



CITY

60340





We're switching from plastic to paper-based packaging. That's why you might find a mix of paper and plastic in our boxes!

Wir stellen von Kunststoffverpackungen auf Verpackungen auf Papierbasis um. Möglicherweise findest du deshalb sowohl Papier als auch Kunststoff in unseren Boxen!

Nous abandonnons progressivement les emballages en plastique au profit d'emballages à base de papier. Il est donc possible que vous trouviez à la fois du papier et du plastique dans nos boîtes !

Stiamo passando dagli imballaggi di plastica a quelli basati su carta. Ecco perché potreste trovare un mix di carta e di plastica nelle nostre confezioni!

Estamos sustituyendo las bolsas de plástico por bolsas con base de papel. ¡Por eso, puede que encuentres una mezcla de papel y de plástico en nuestras cajas!

Estamos a substituir as nossas embalagens de plástico por embalagens à base de papel. Por isso poderá encontrar um misto de papel e plástico nas nossas caixas!

Átállunk a műanyagról a papír alapú csomagolásra. Ezért előfordulhat, hogy a dobozainkban papír és műanyag zacskót egyaránt találasz!

Mēs pārejam no plastmasas iepakojuma uz iepakojumu, kurā izmantots papīrs. Tāpēc mūsu kārbās var būt gan papīra, gan plastmasas daļas.

Trecem de la ambalajele din material plastic la ambalaje pe bază de hârtie. Iată de ce s-ar putea să găsești un amestec de hârtie și material plastic în cutiile noastre!

我们正在从塑料包装向纸基包装过渡。这就是为什么你可能会发现我们的包装盒中同时出现塑料和纸质材料！

[LEGO.com/sustainable-packaging](https://www.lego.com/sustainable-packaging)



乐高®拼搭指引

Check for compatibility
 Kompatibilität prüfen
 Vérifier la compatibilité
 Controlla la compatibilità
 Comprueba tu compatibilidad
 Verificar a compatibilitade
 Ellenőrizd a kompatibilitást
 Pārbaudīt saderību
 Verificarea compatibilității
 检查兼容性

[LEGO.com/devicecheck](https://www.lego.com/devicecheck)



LEGO® Building Instructions



Apple and the Apple logo are trademarks of Apple Inc.
 Google Play and the Google Play logo are trademarks of Google LLC.
 Tencent and the Tencent logo are trademarks of Tencent Inc.

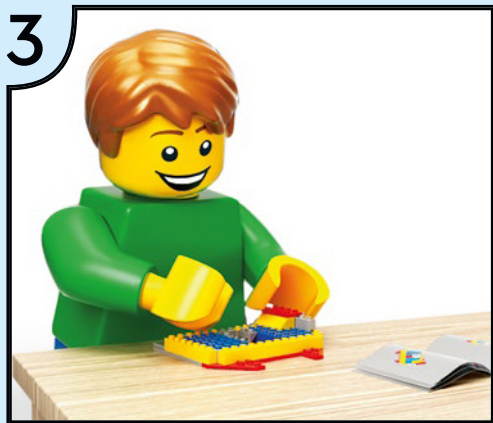



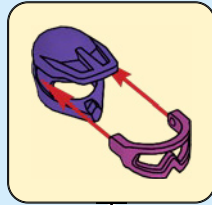
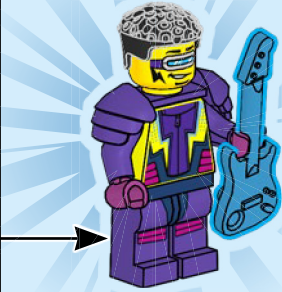
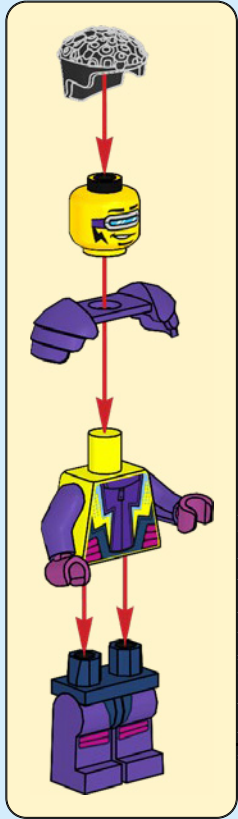

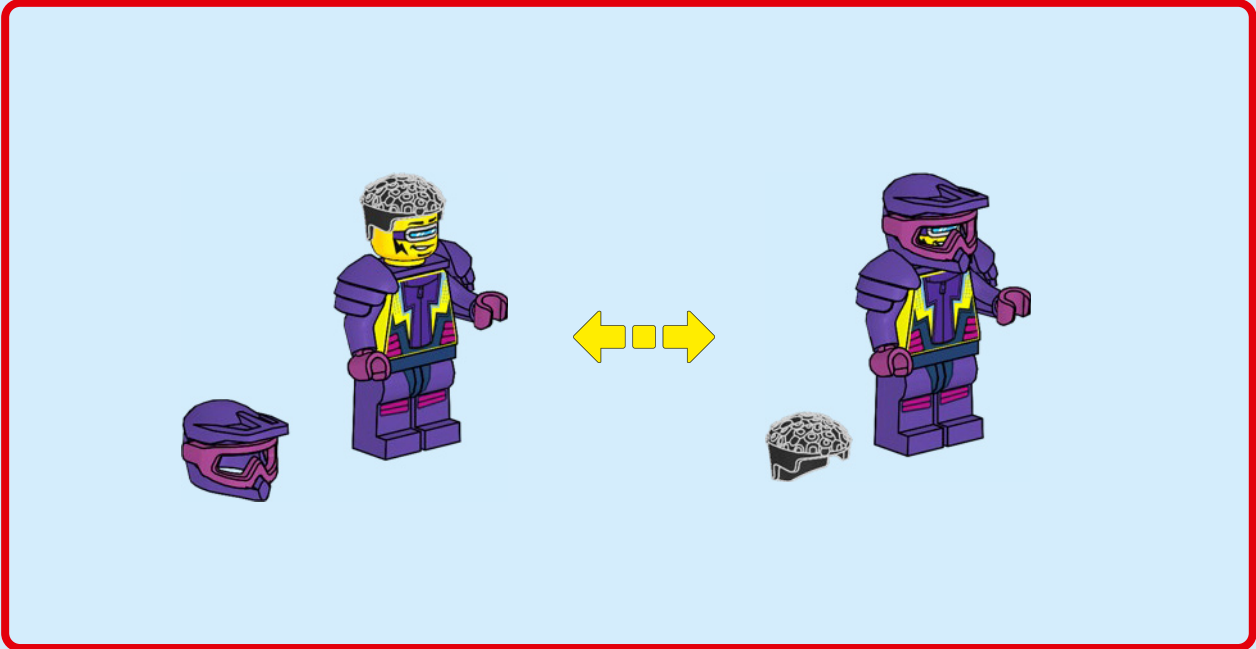

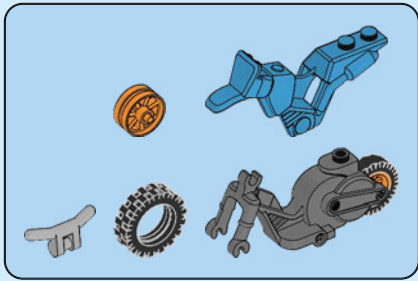

1

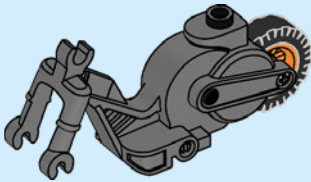

2

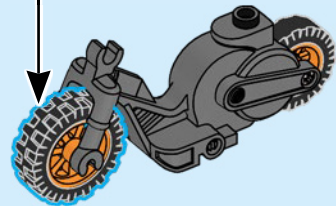
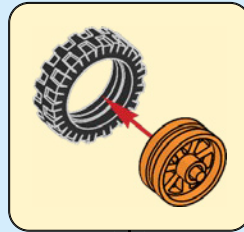

3

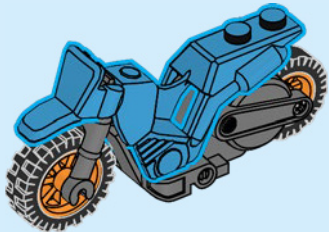

4



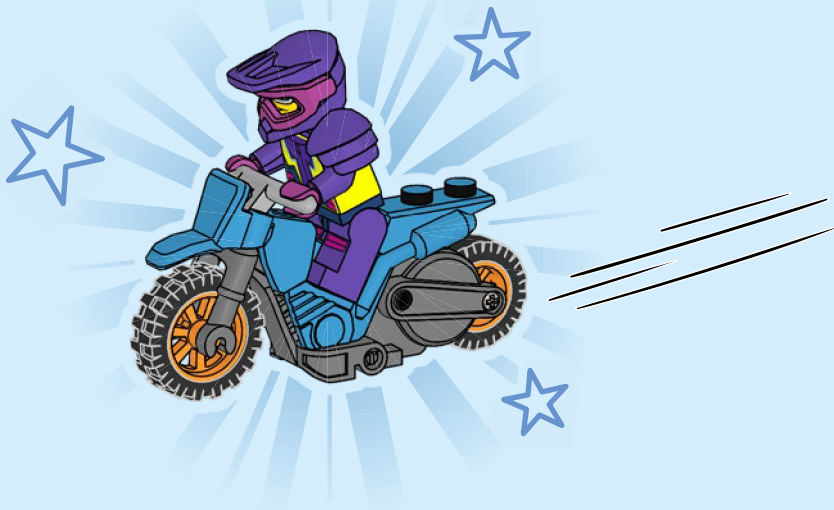

1



← x3

2

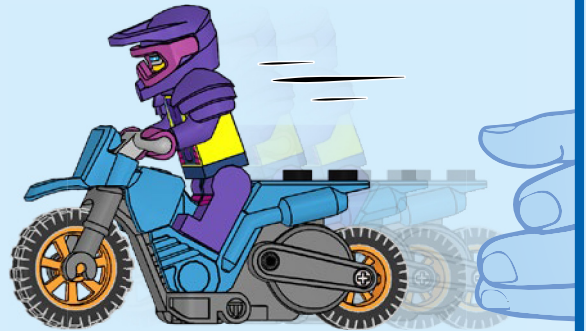

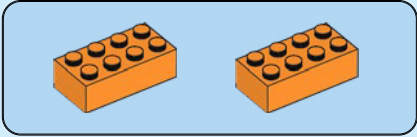
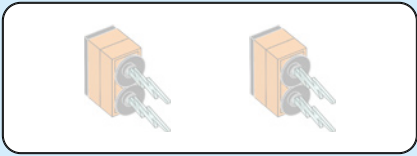

1

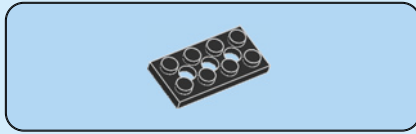
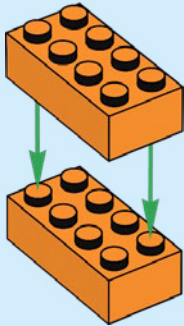

2

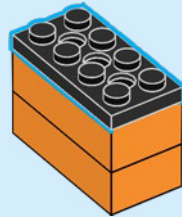

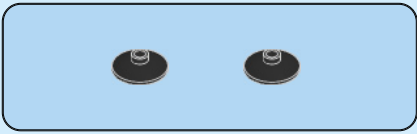

3

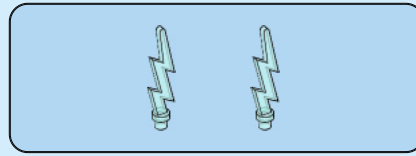
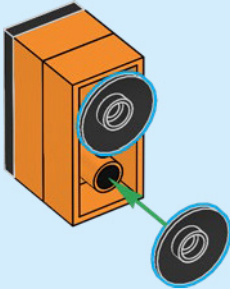

4

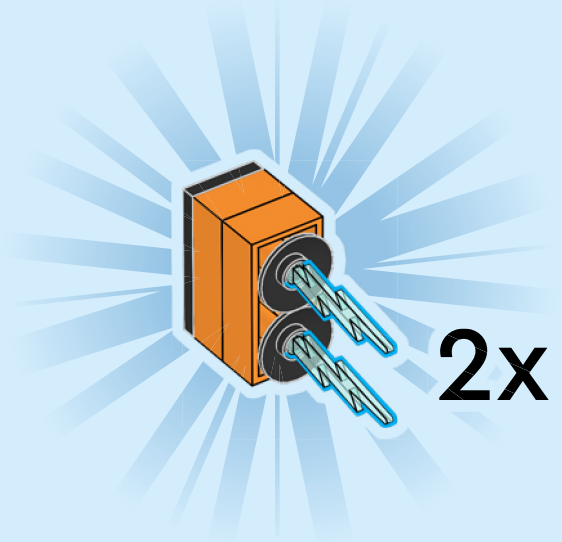

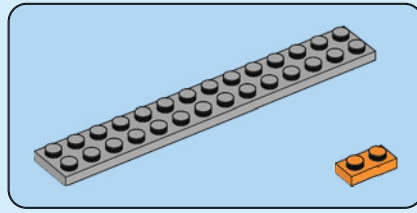
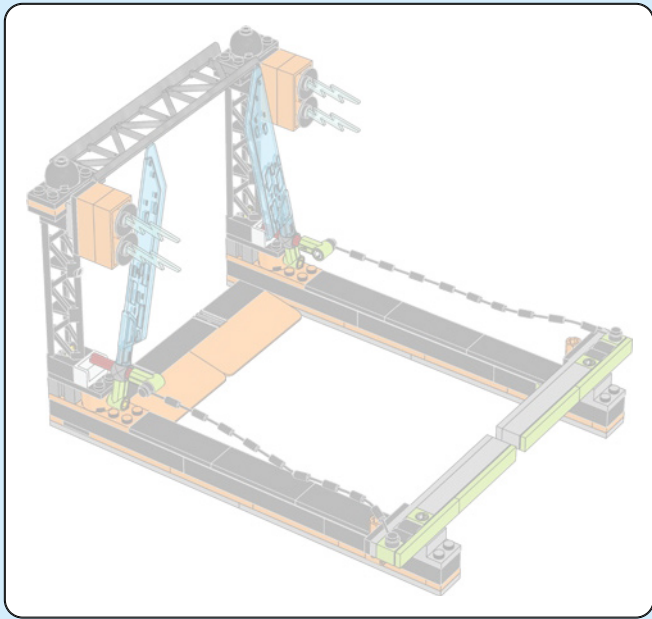

1

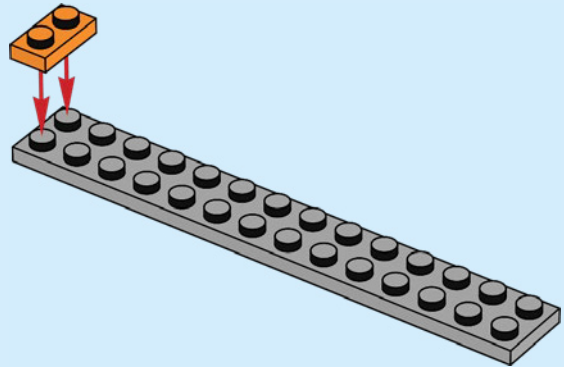

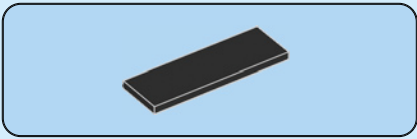

2

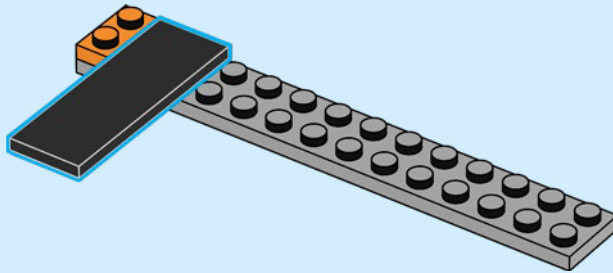

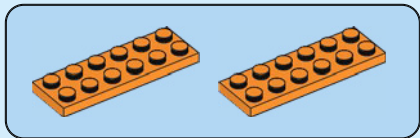

3

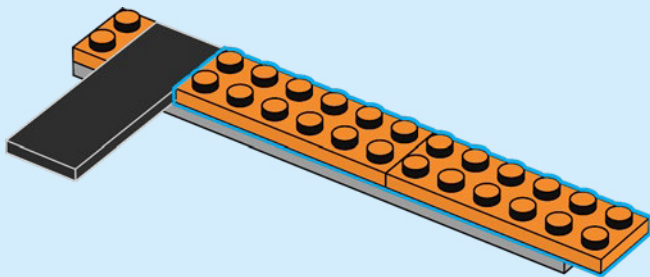

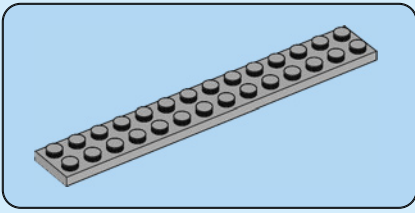

4

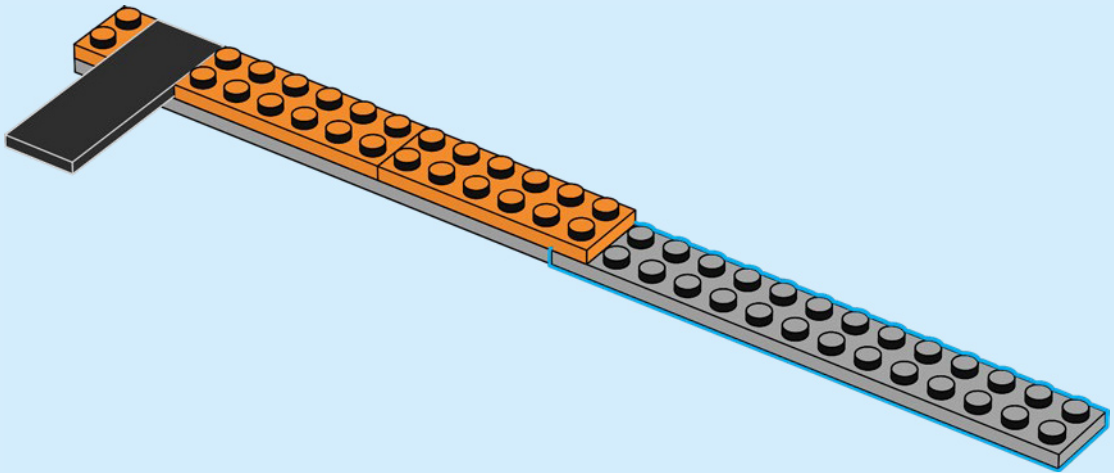

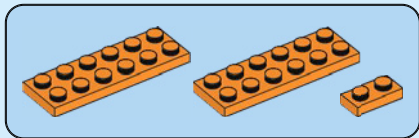

5

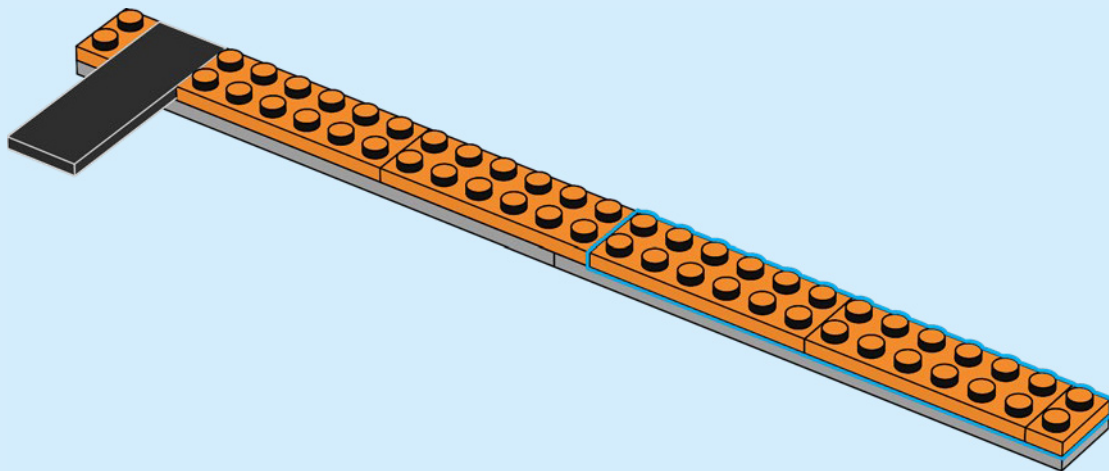

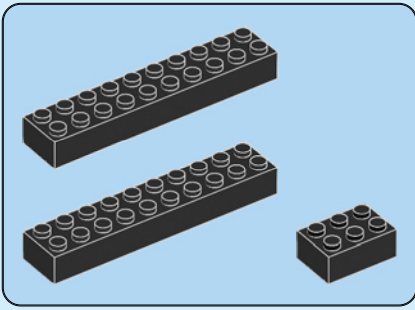

6

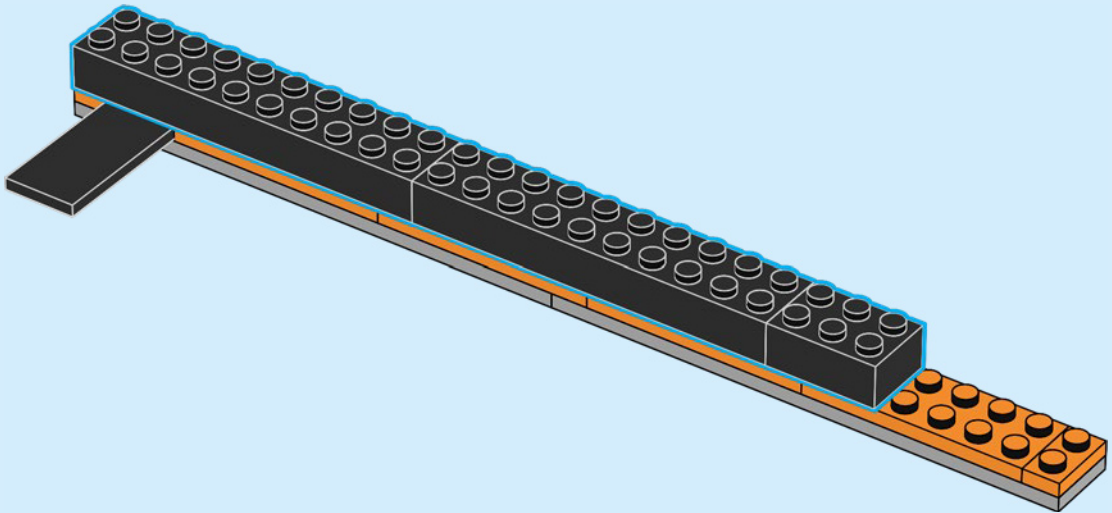

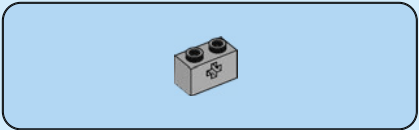

7

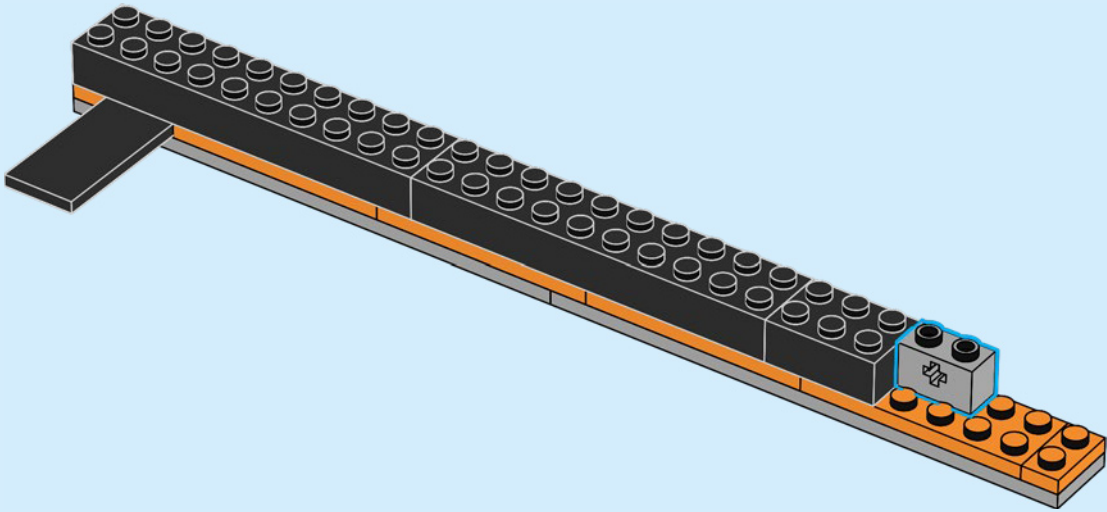

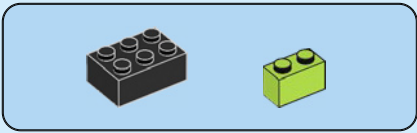

8

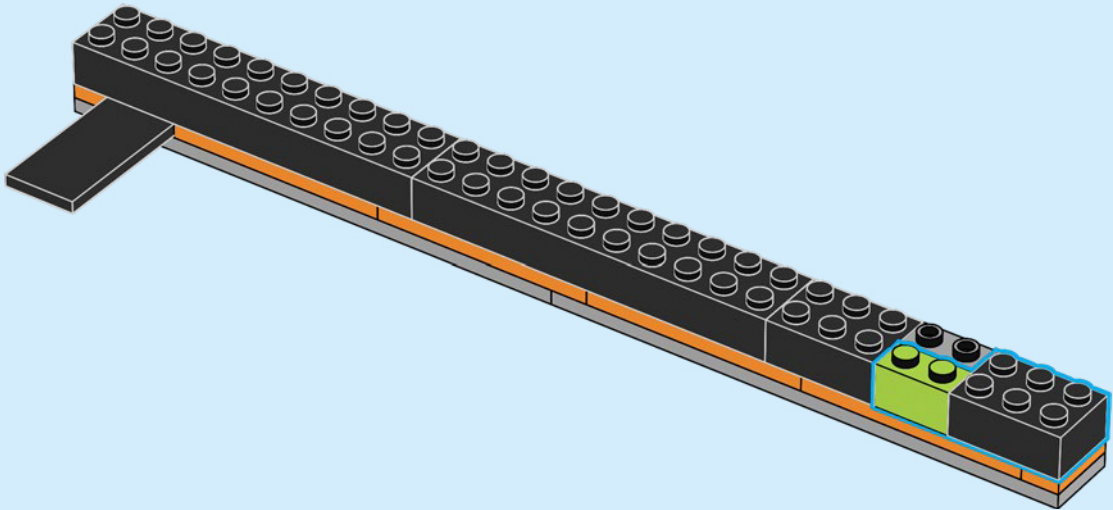

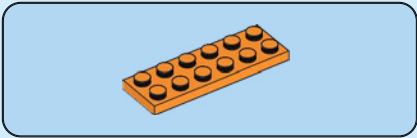

9

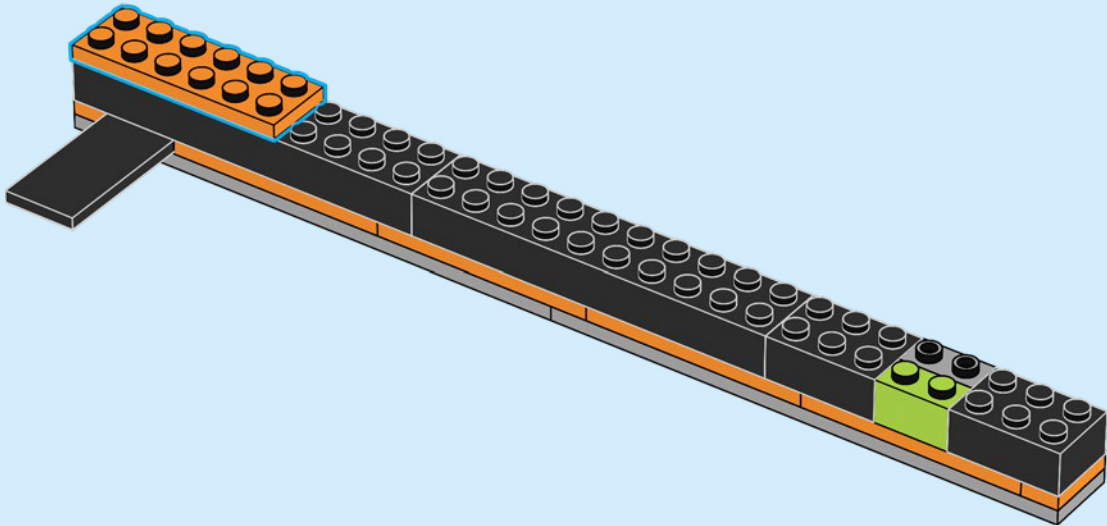

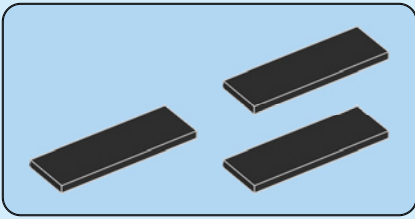

10

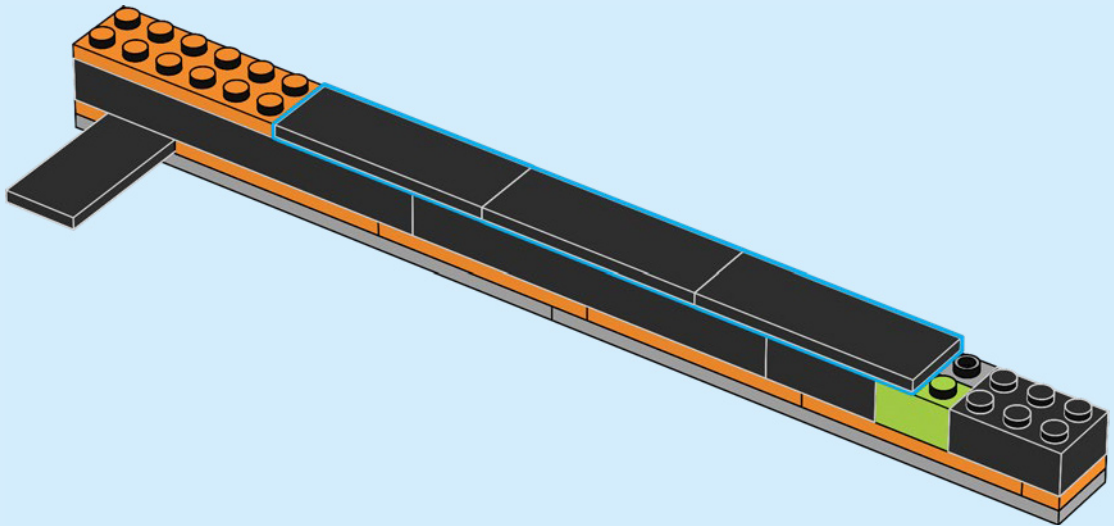

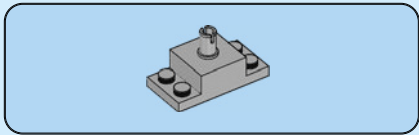

11

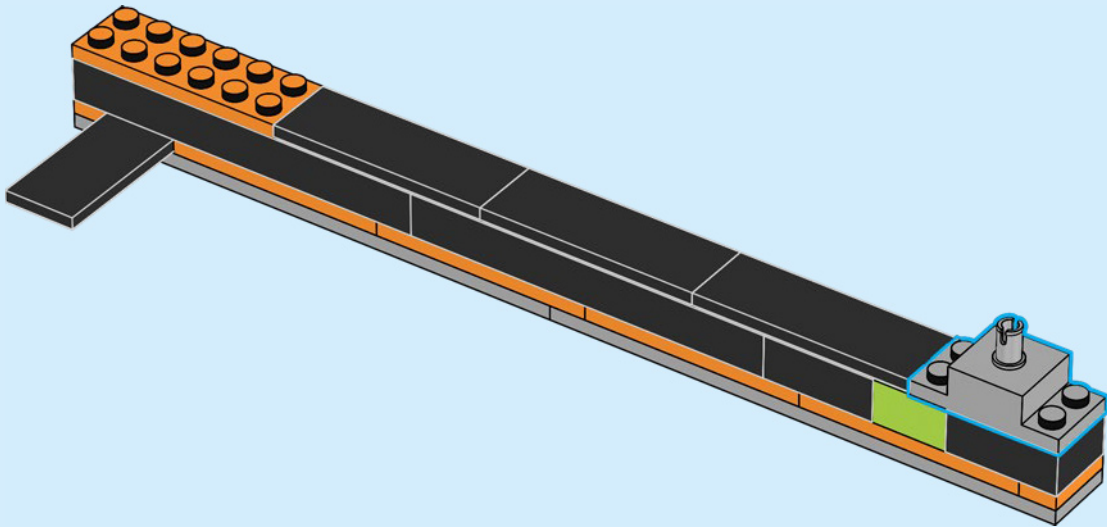

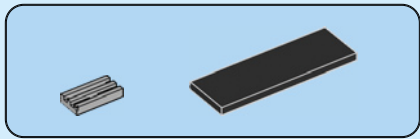

13

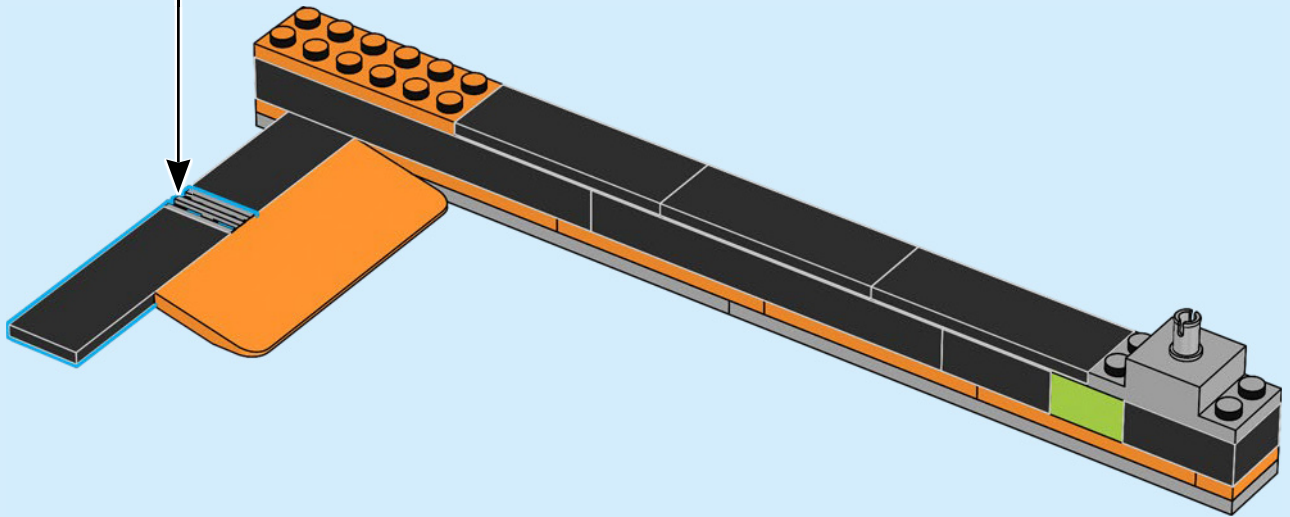
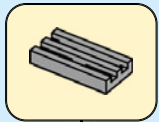

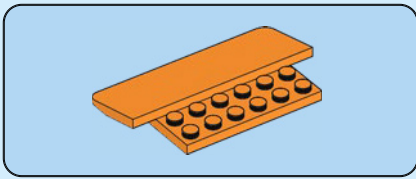

14

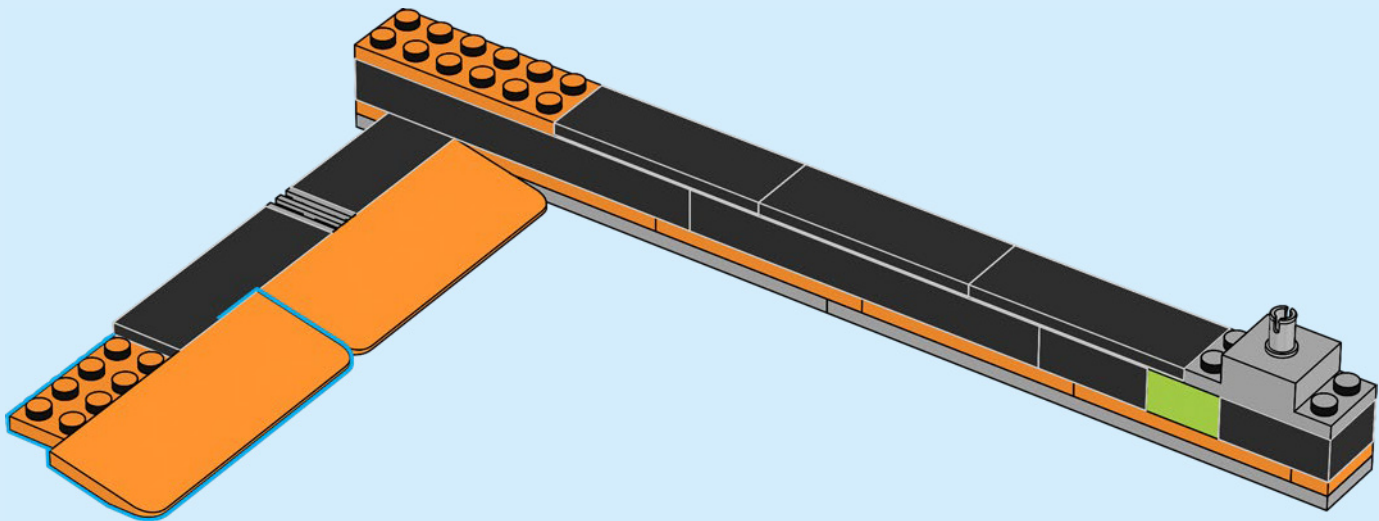

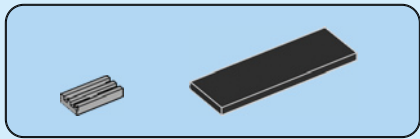

15

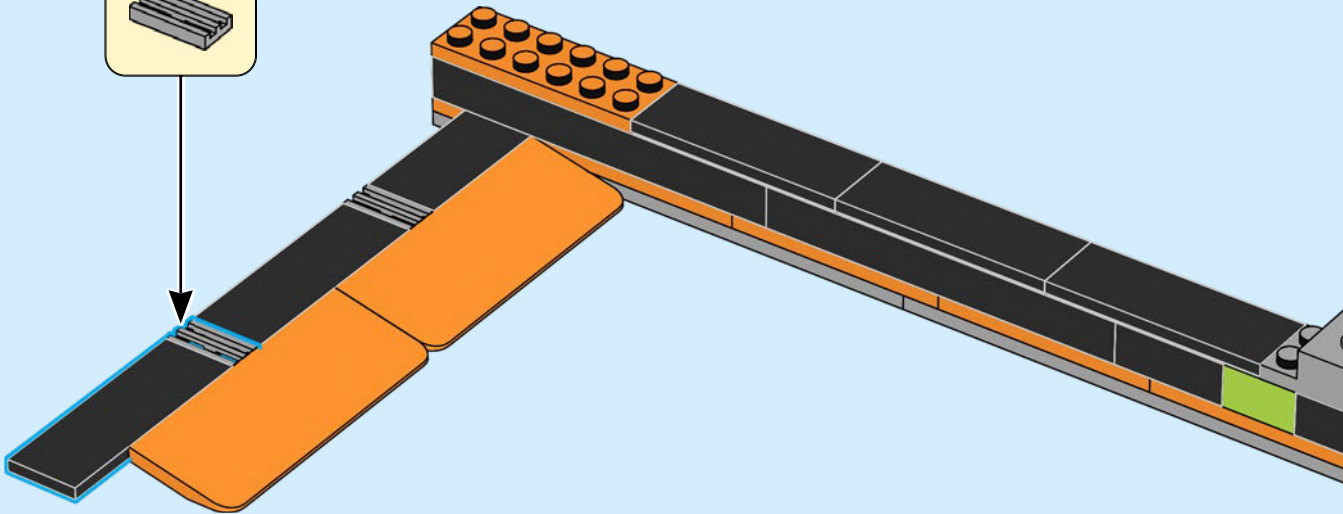
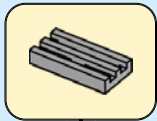

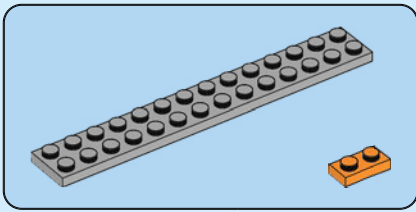

16

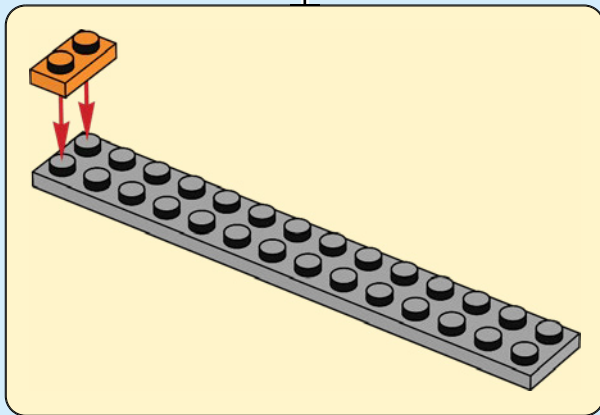
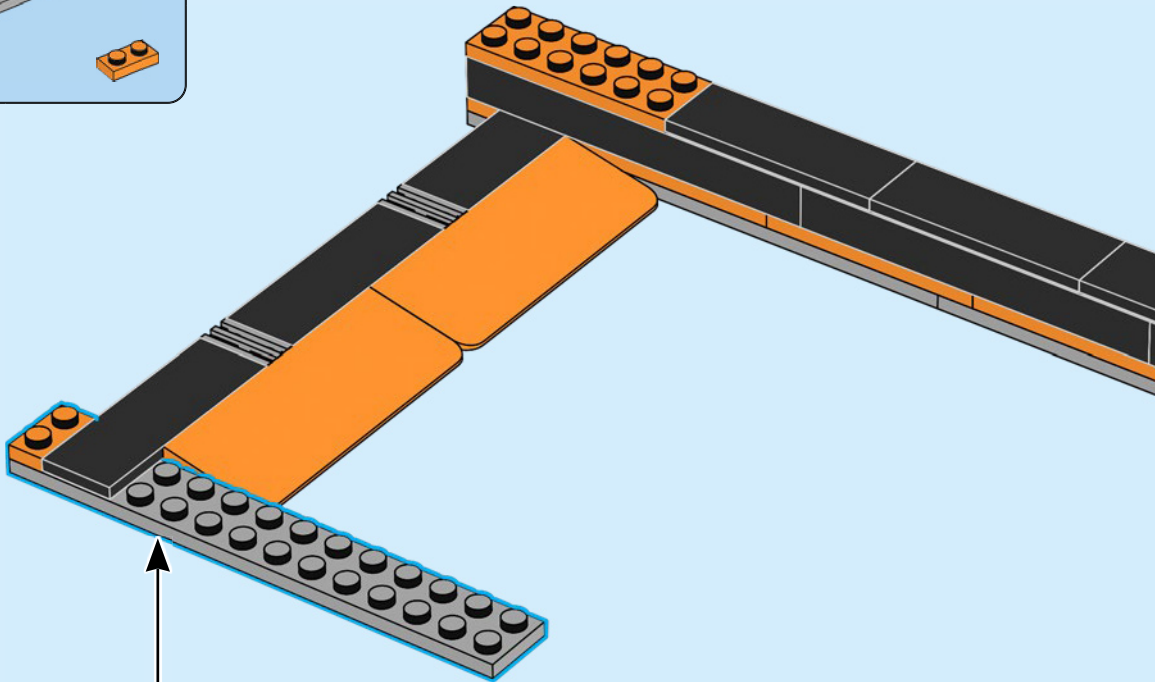

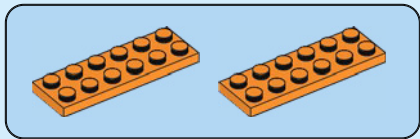

17

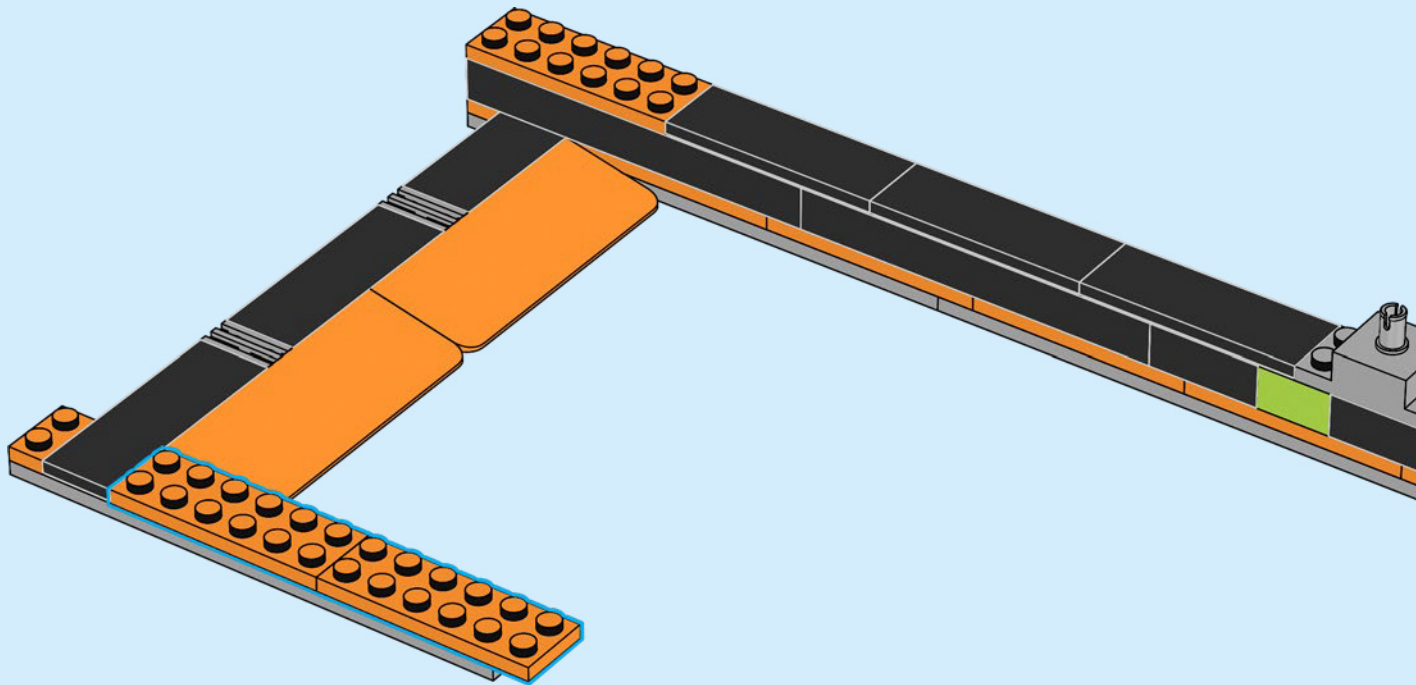

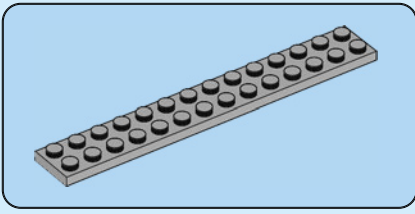

18

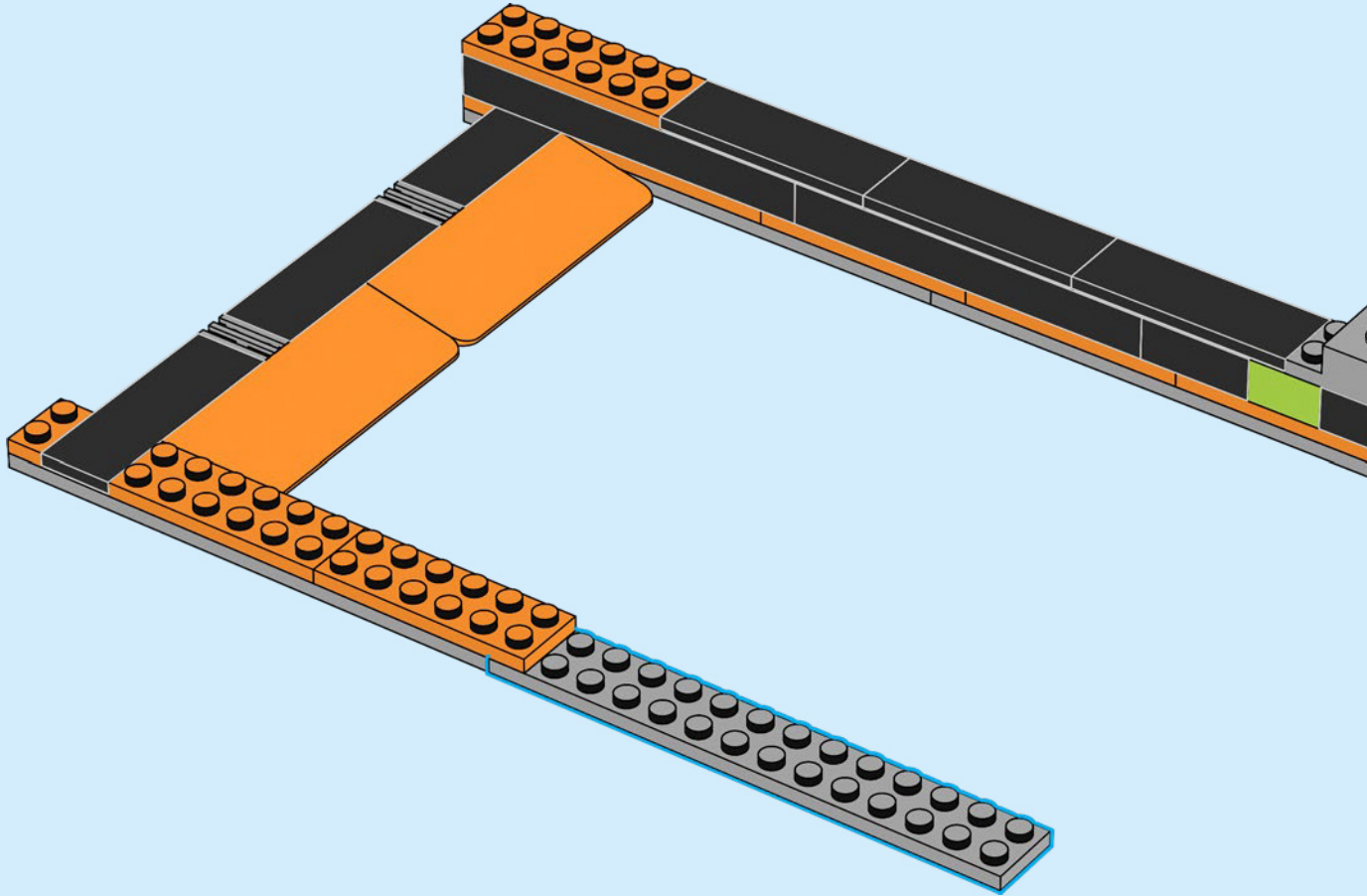

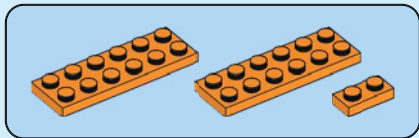

19

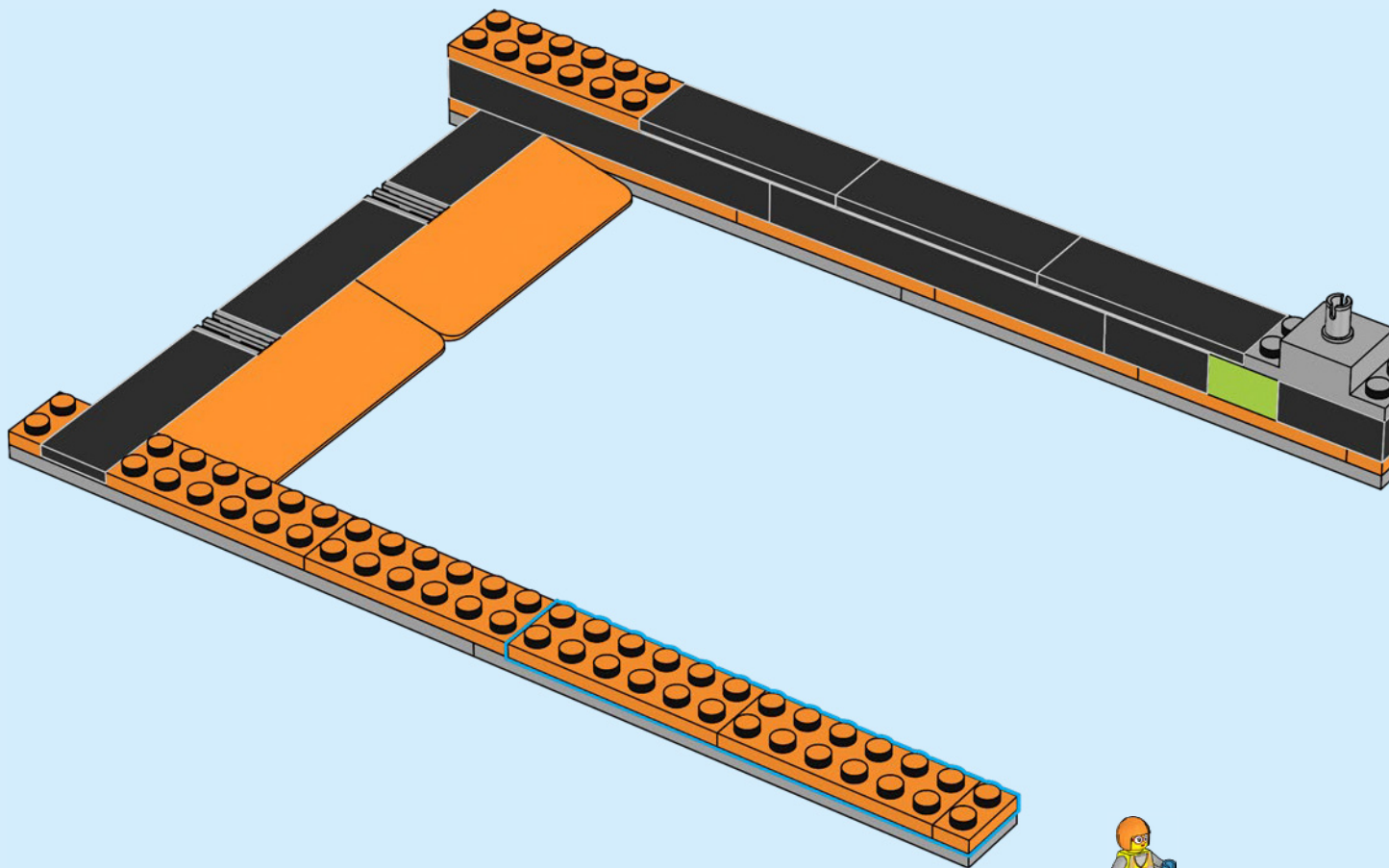

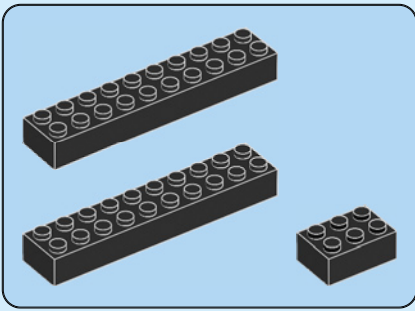

20

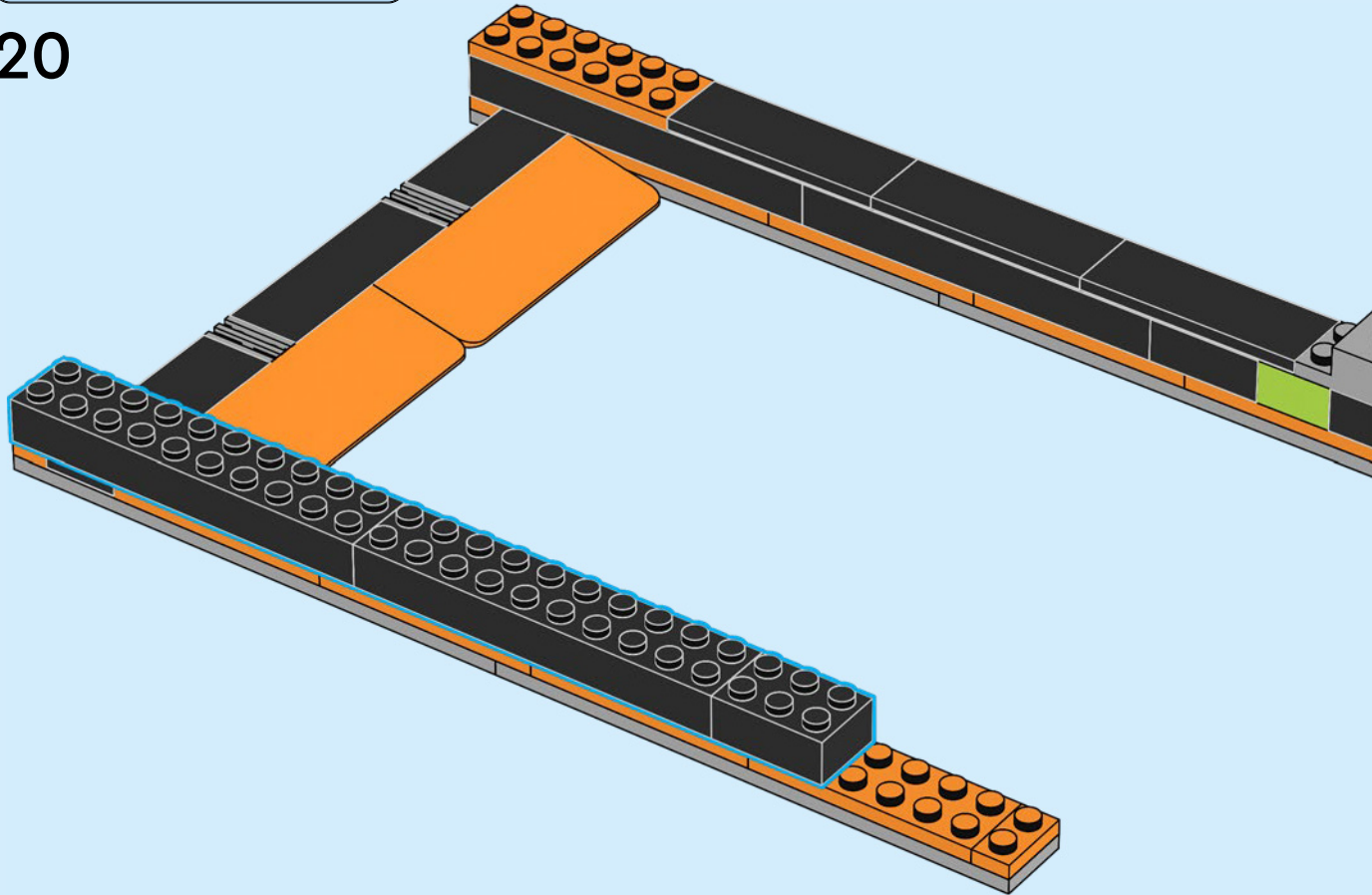

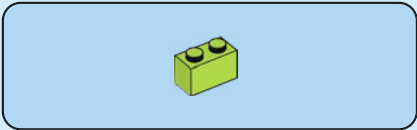

21

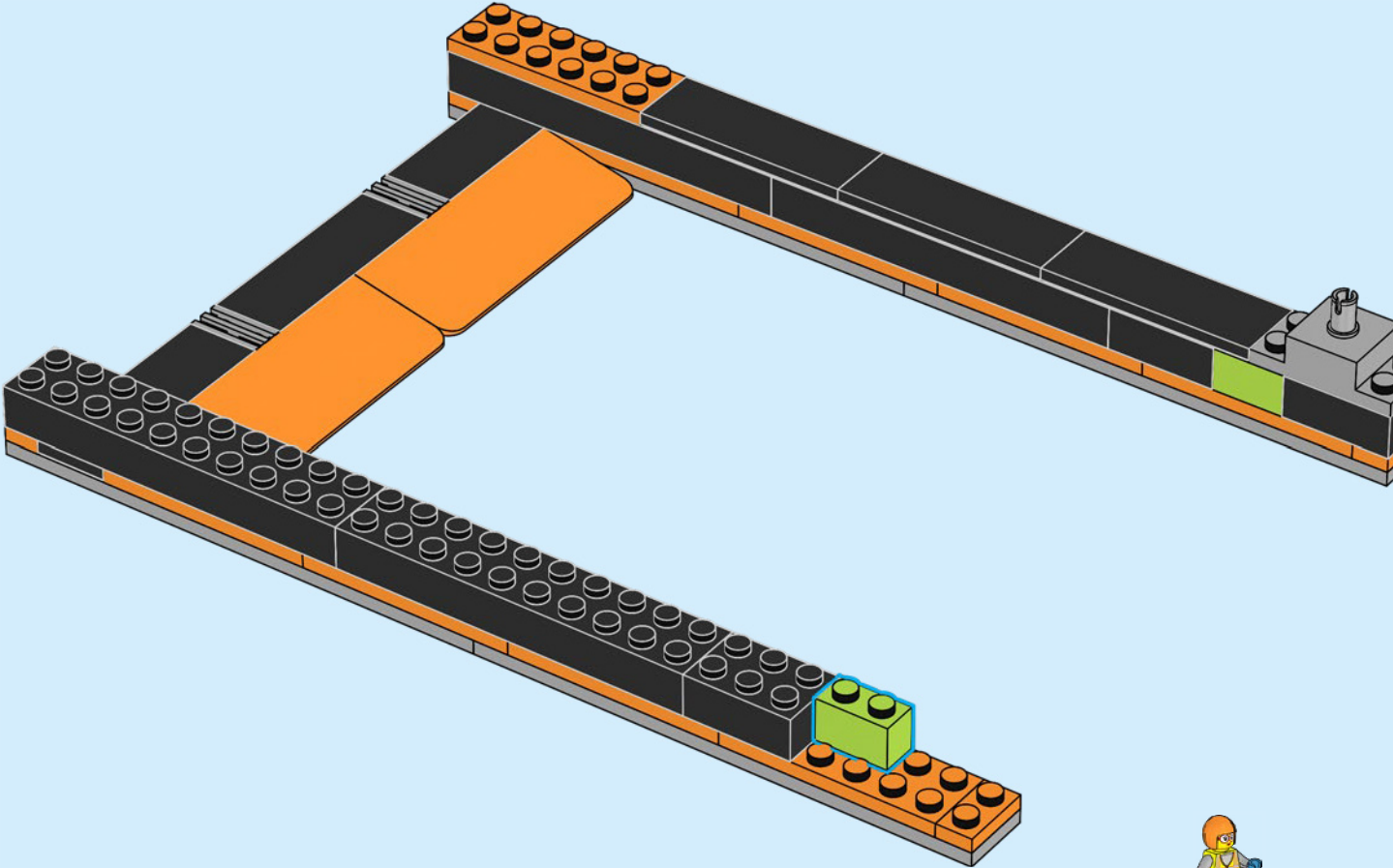

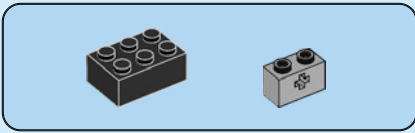

22

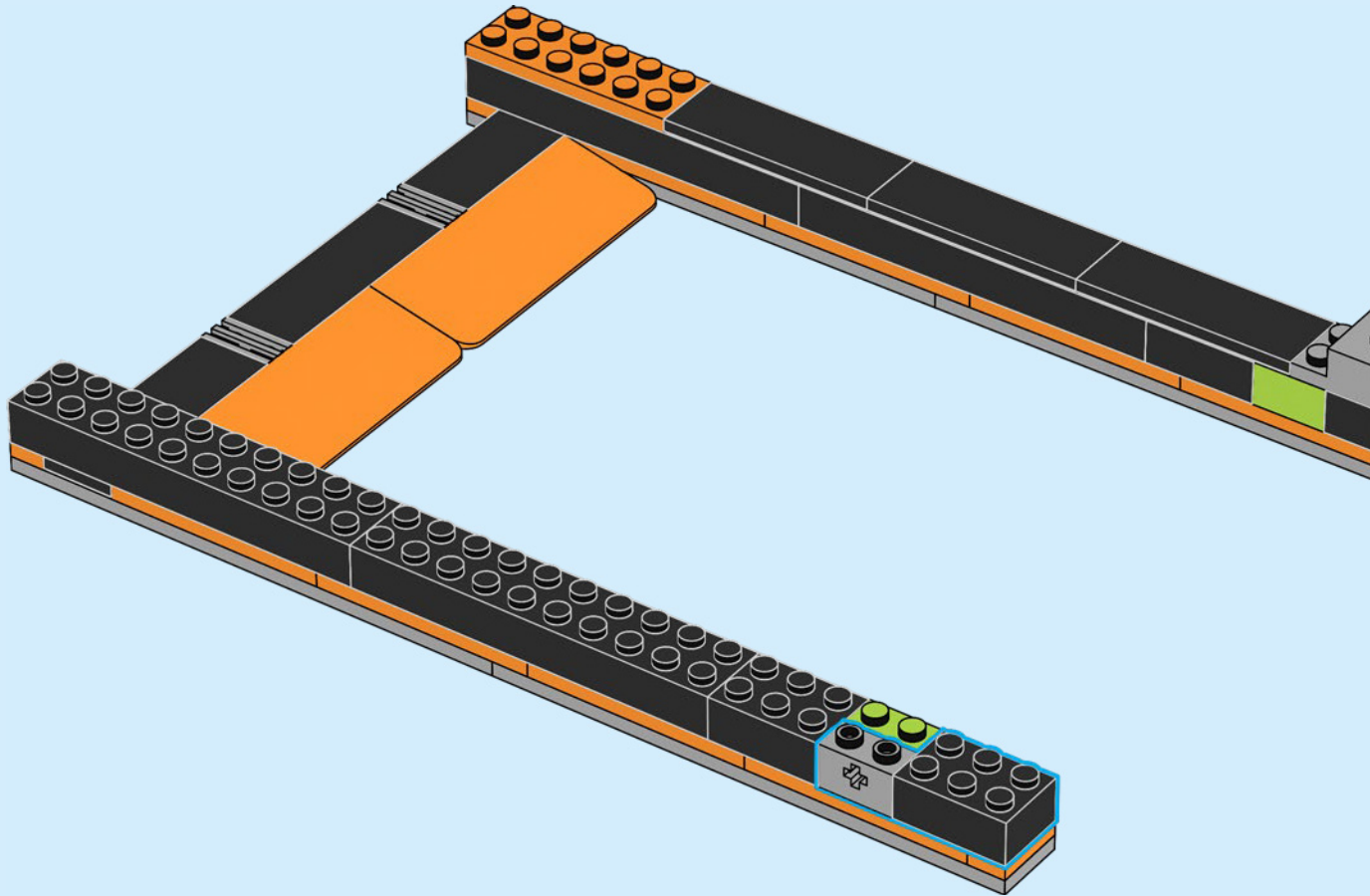

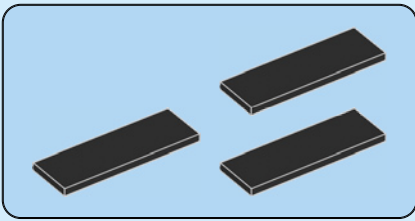

24

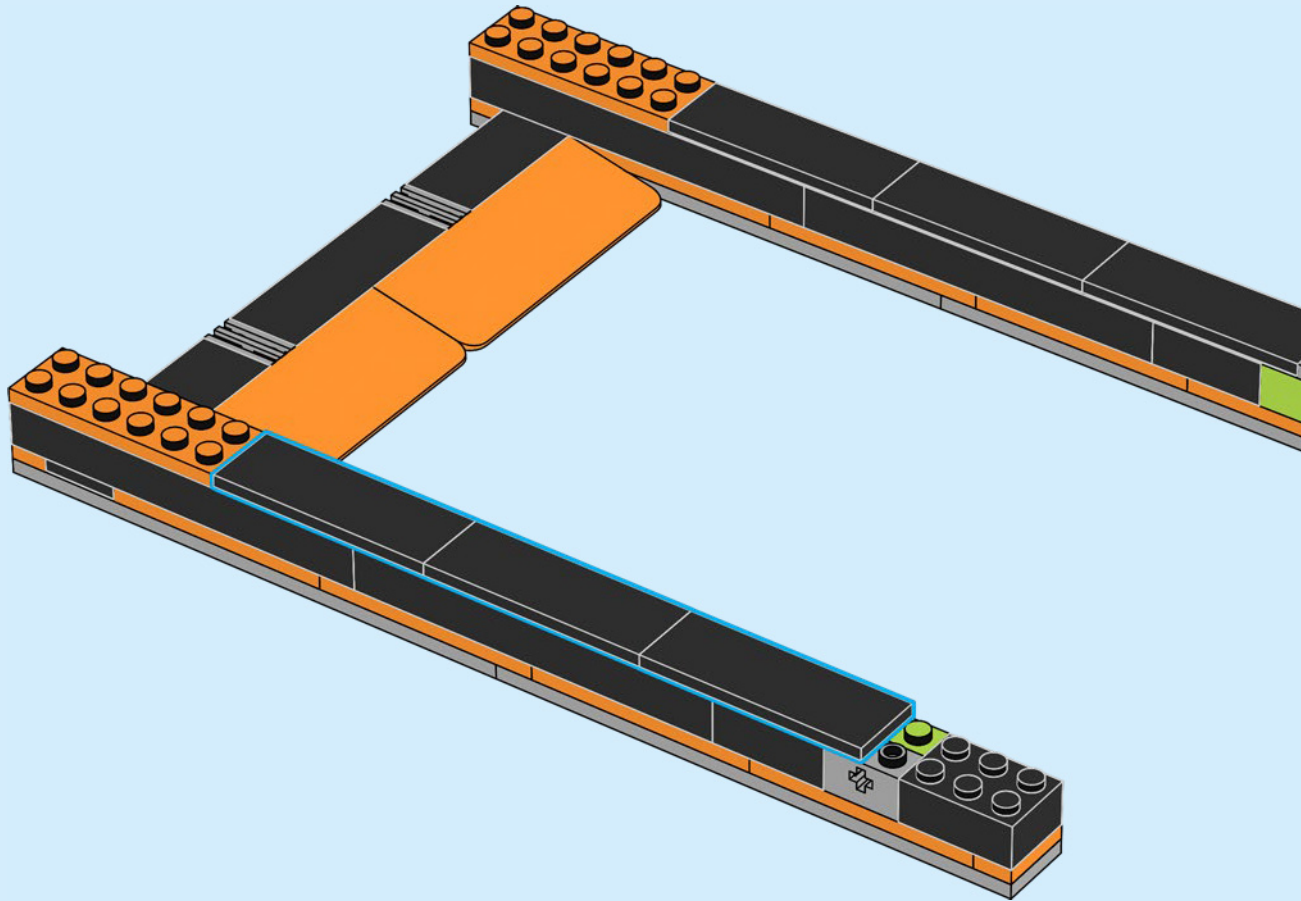

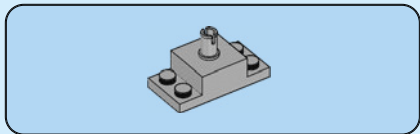

25

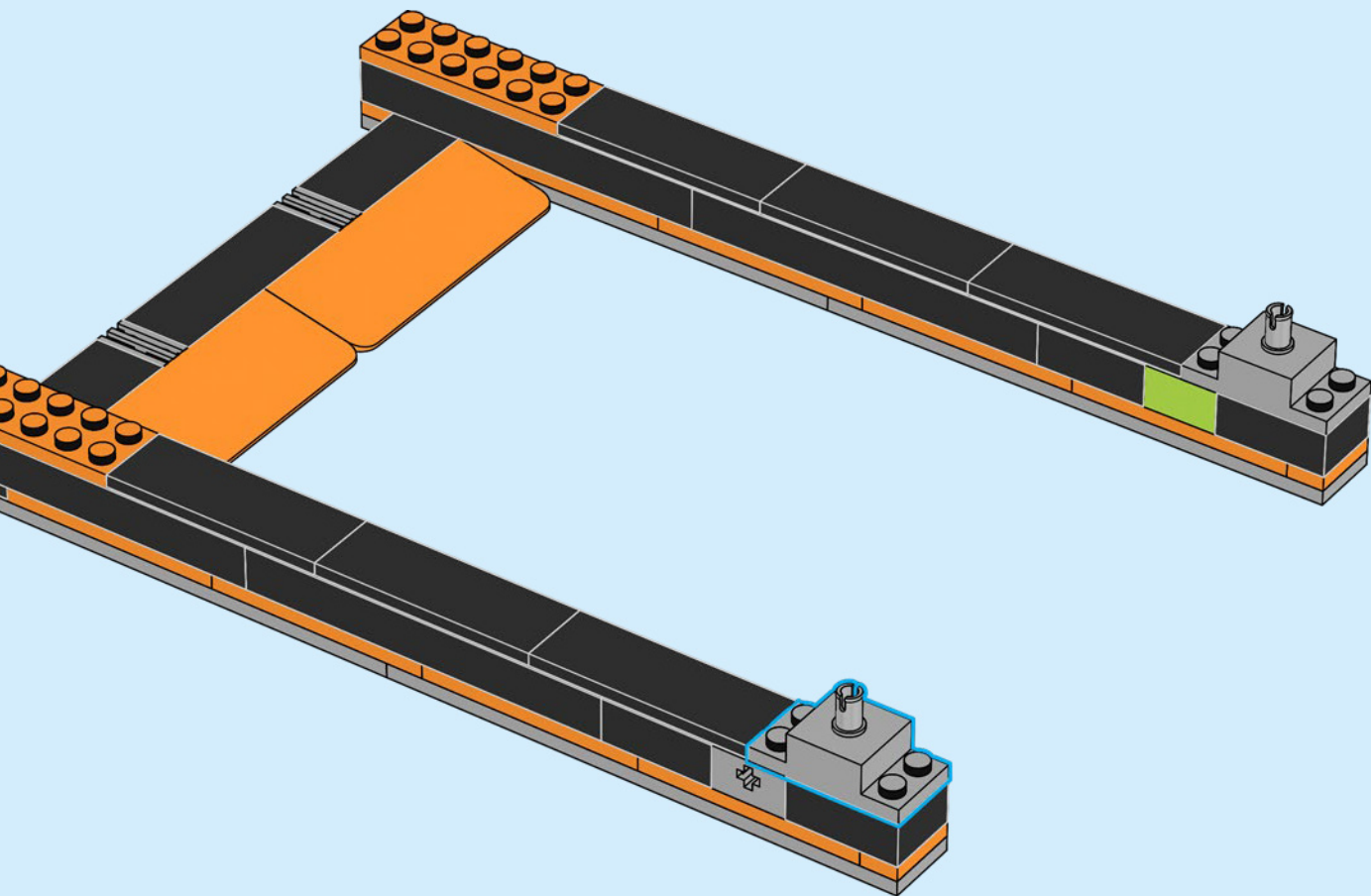

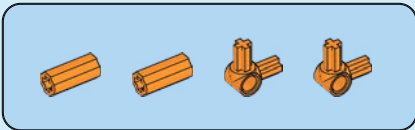

26

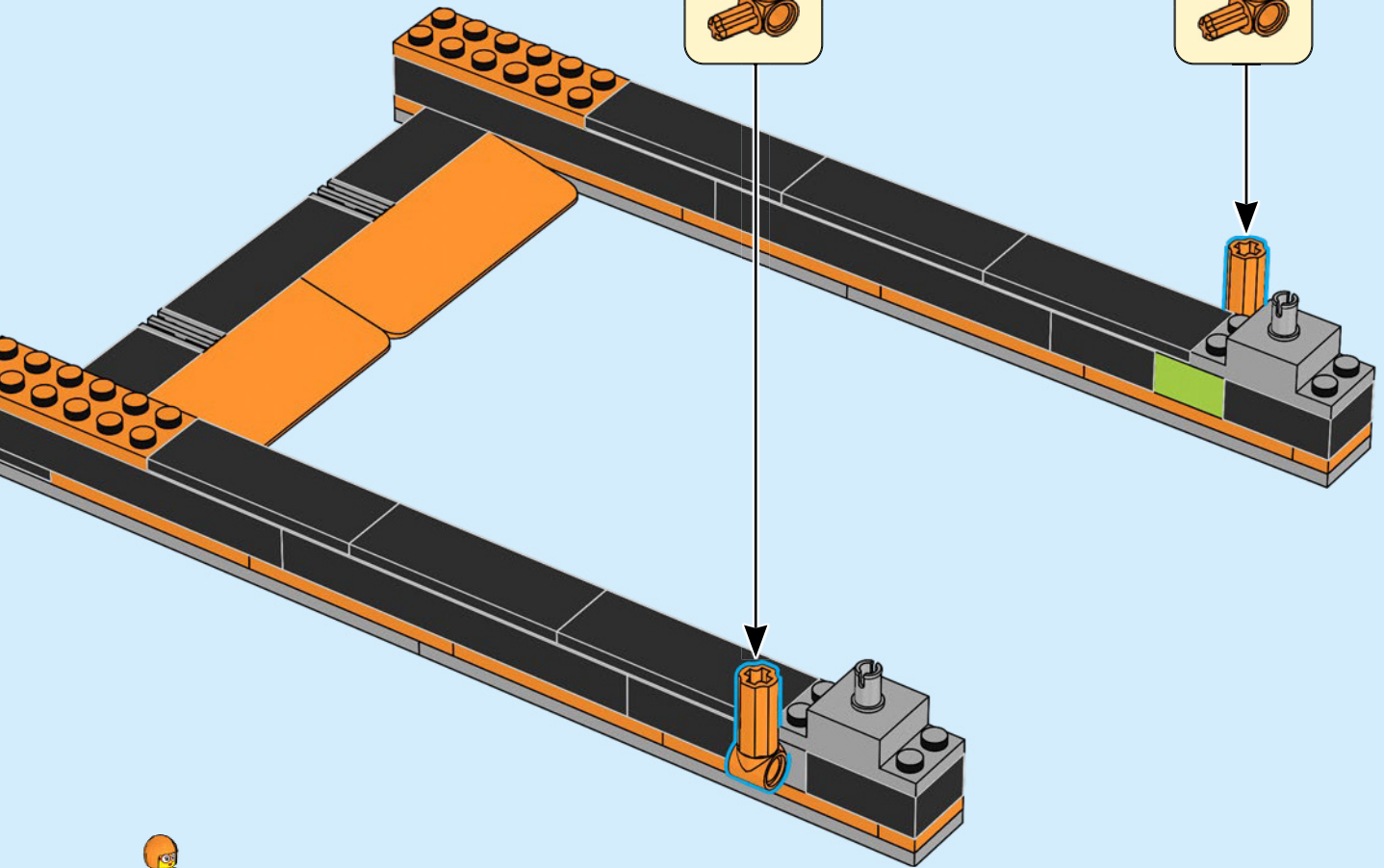
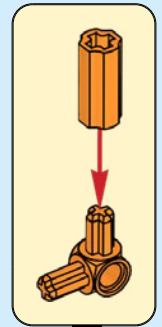
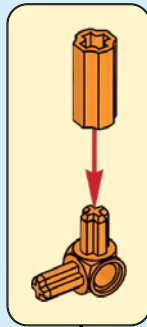



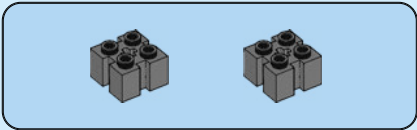

27

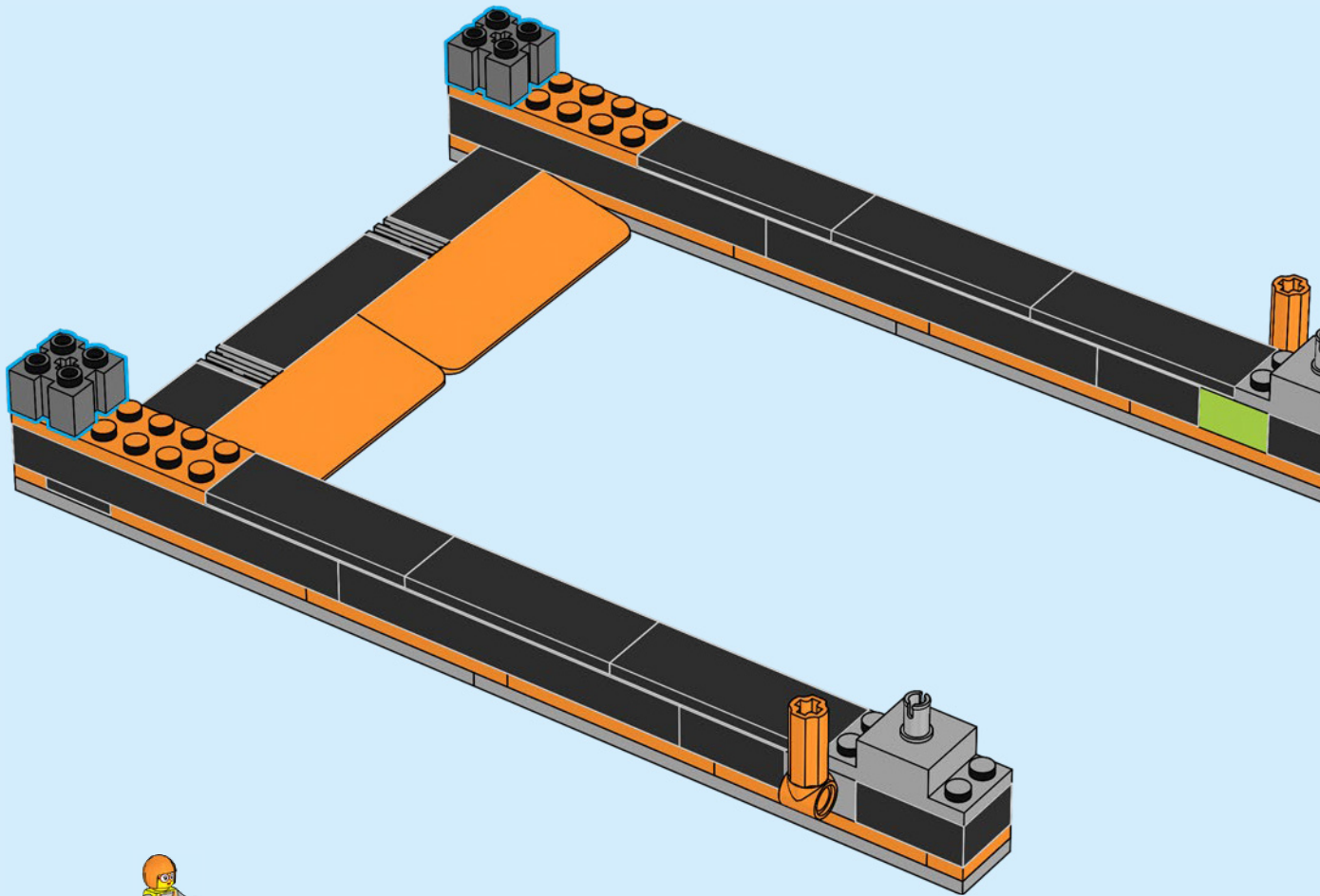

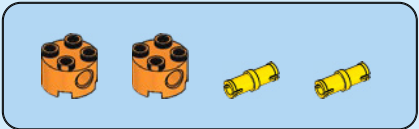

28

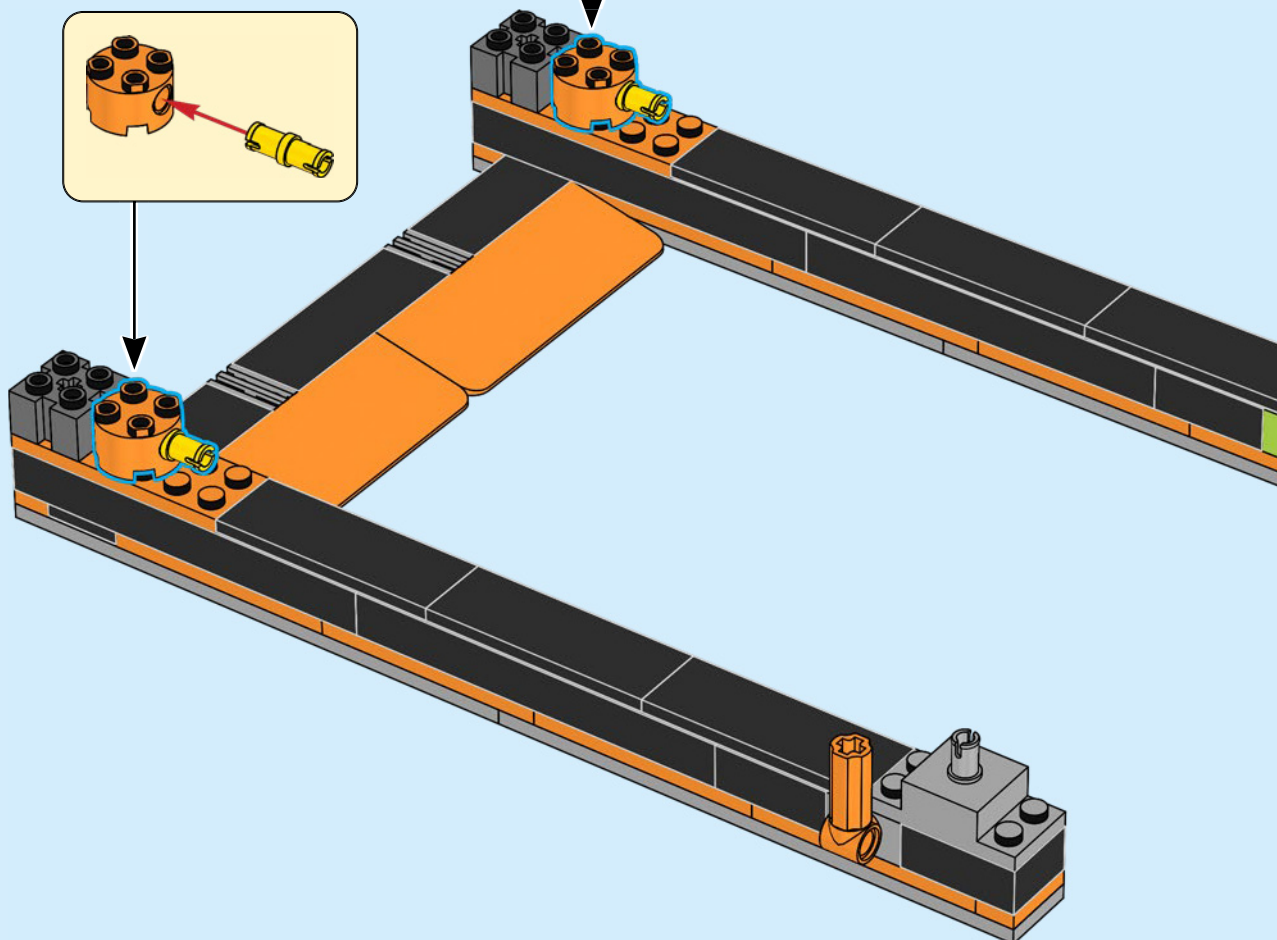
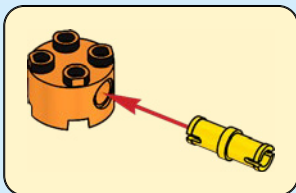
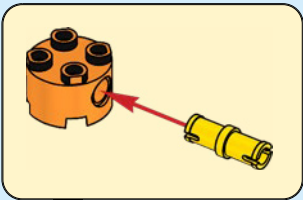

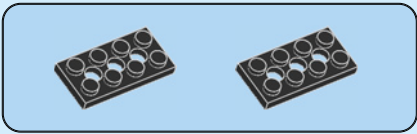

29

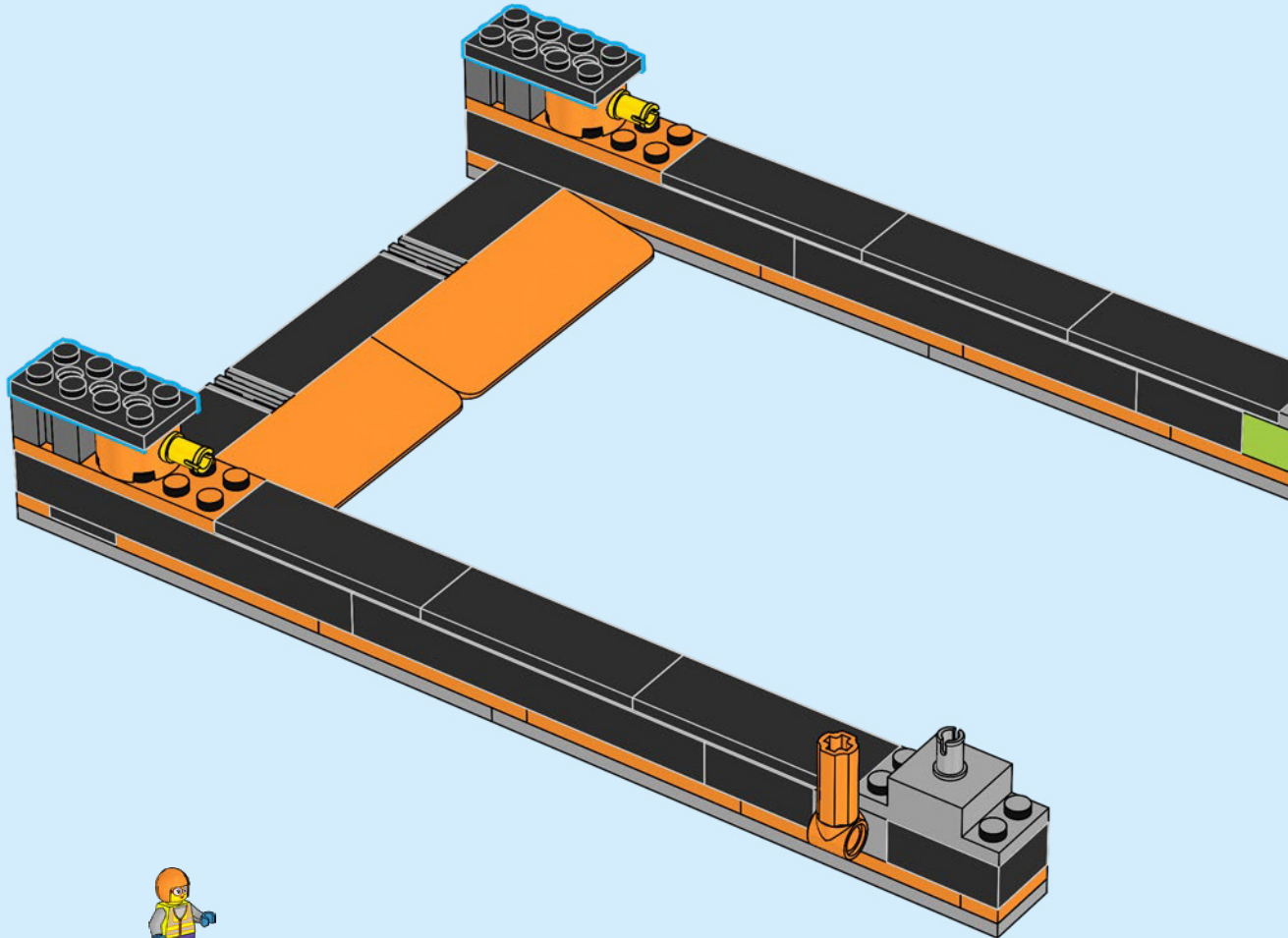

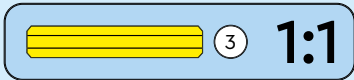
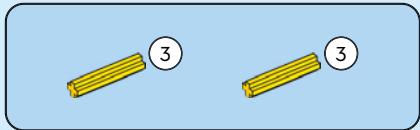

30

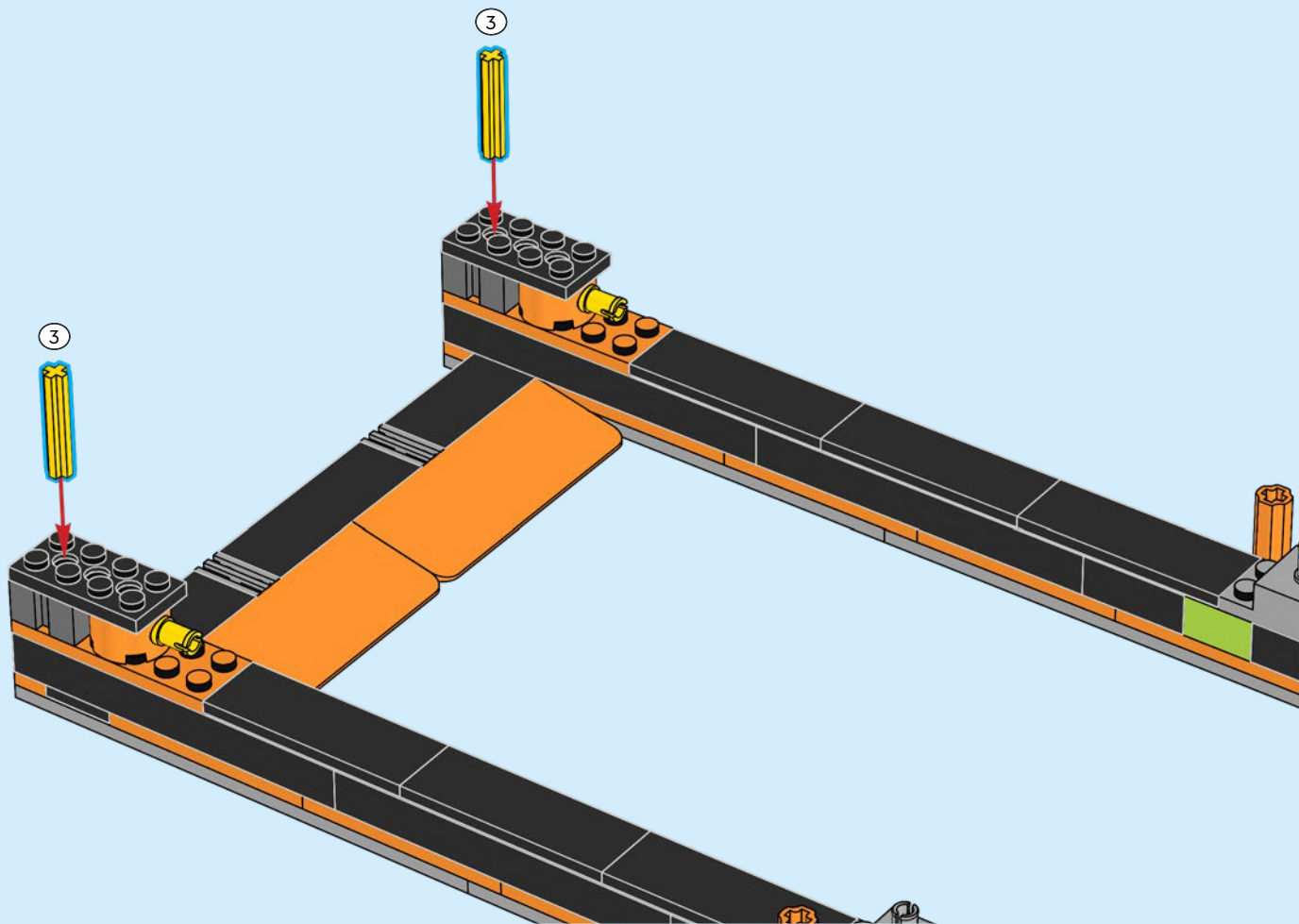

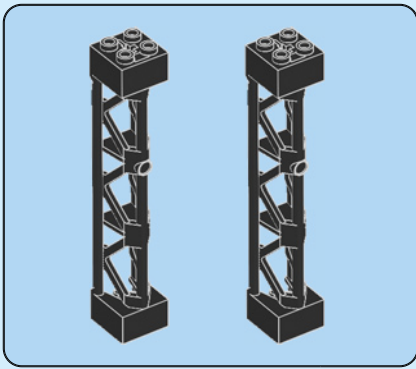

31

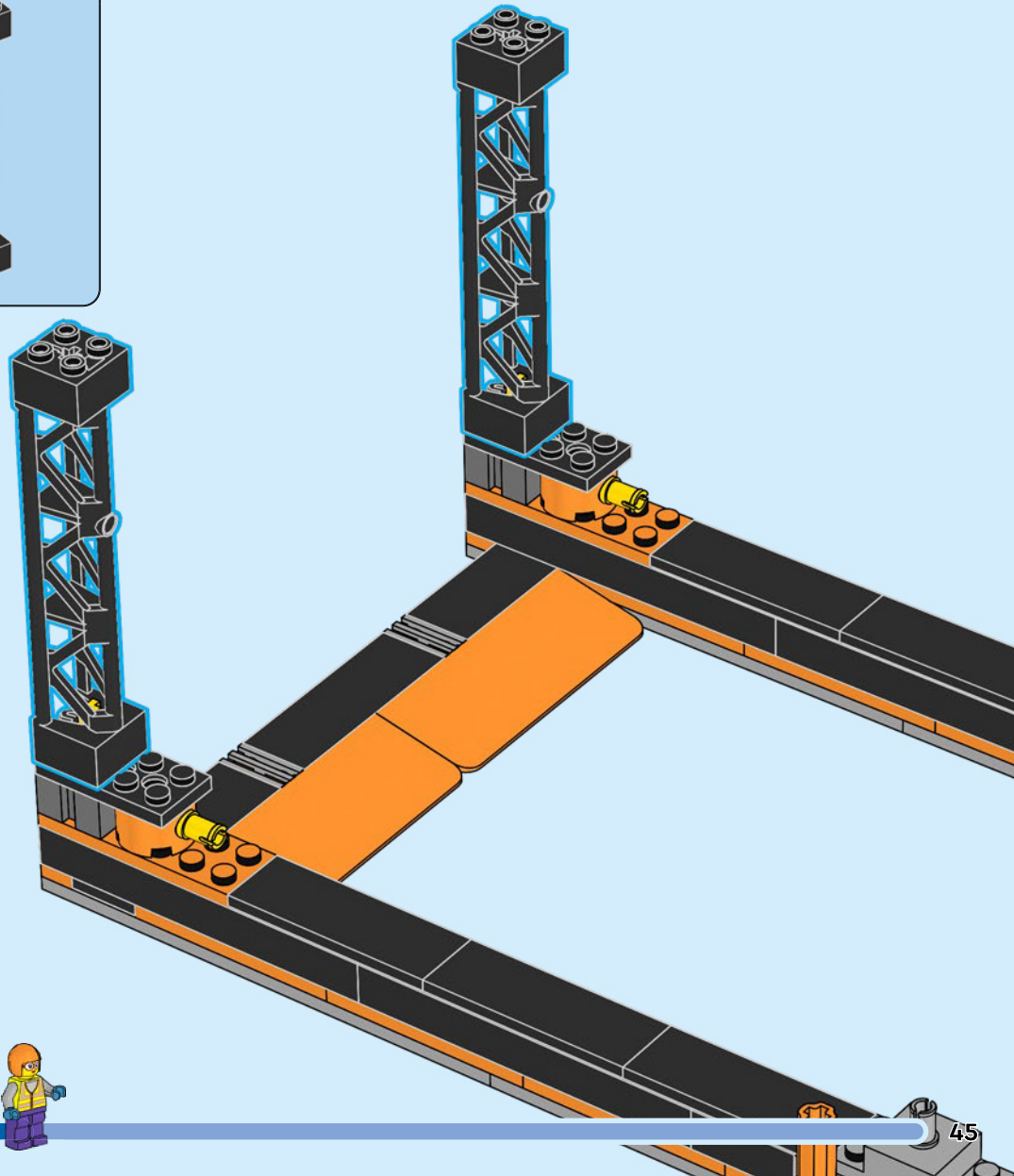

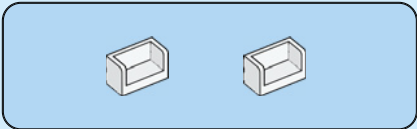

32

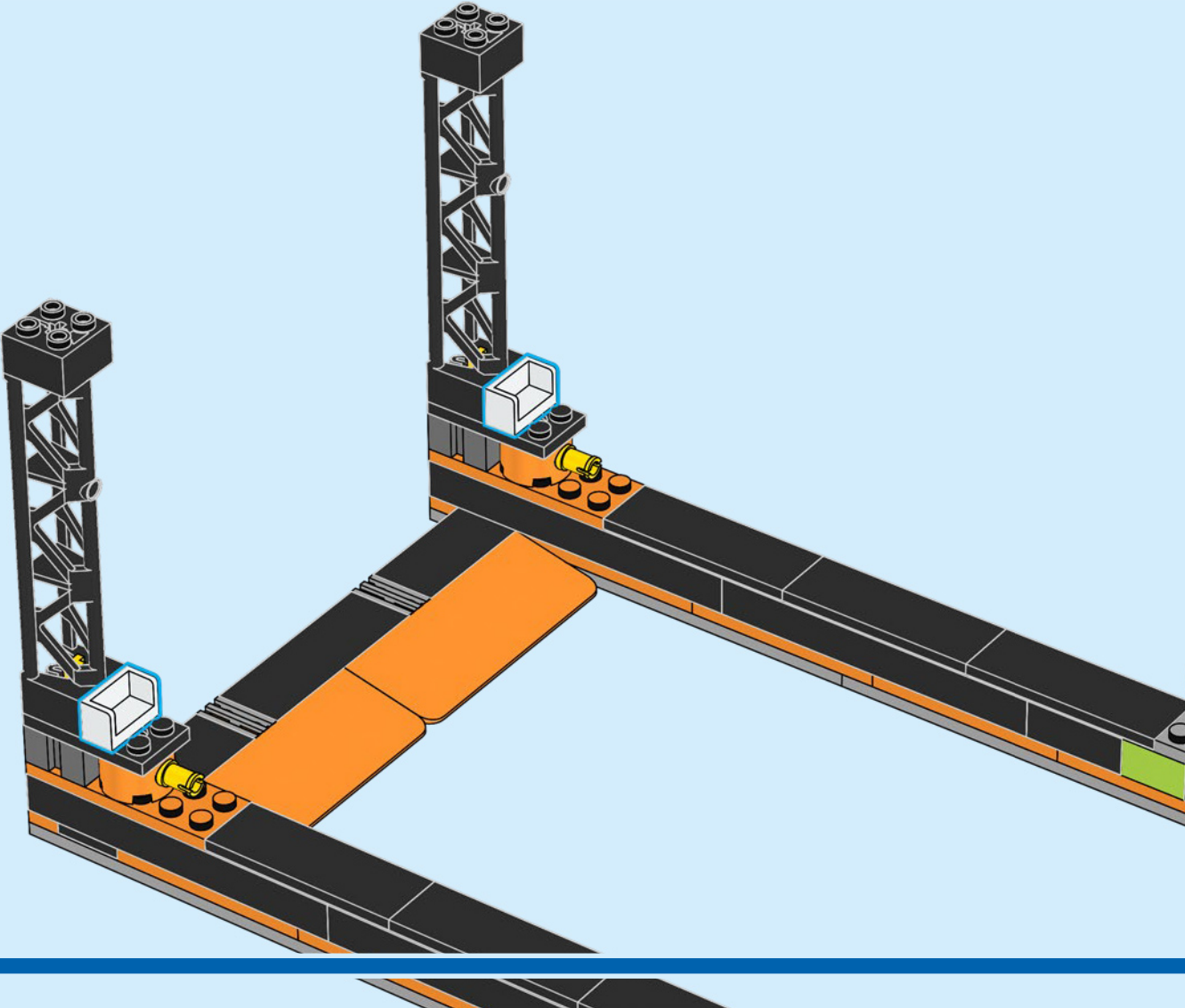

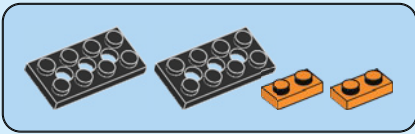

33

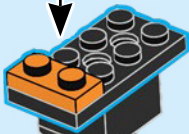
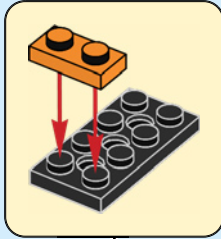
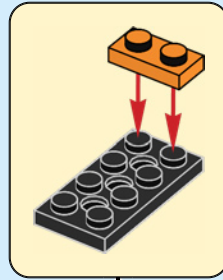

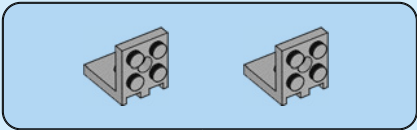

34

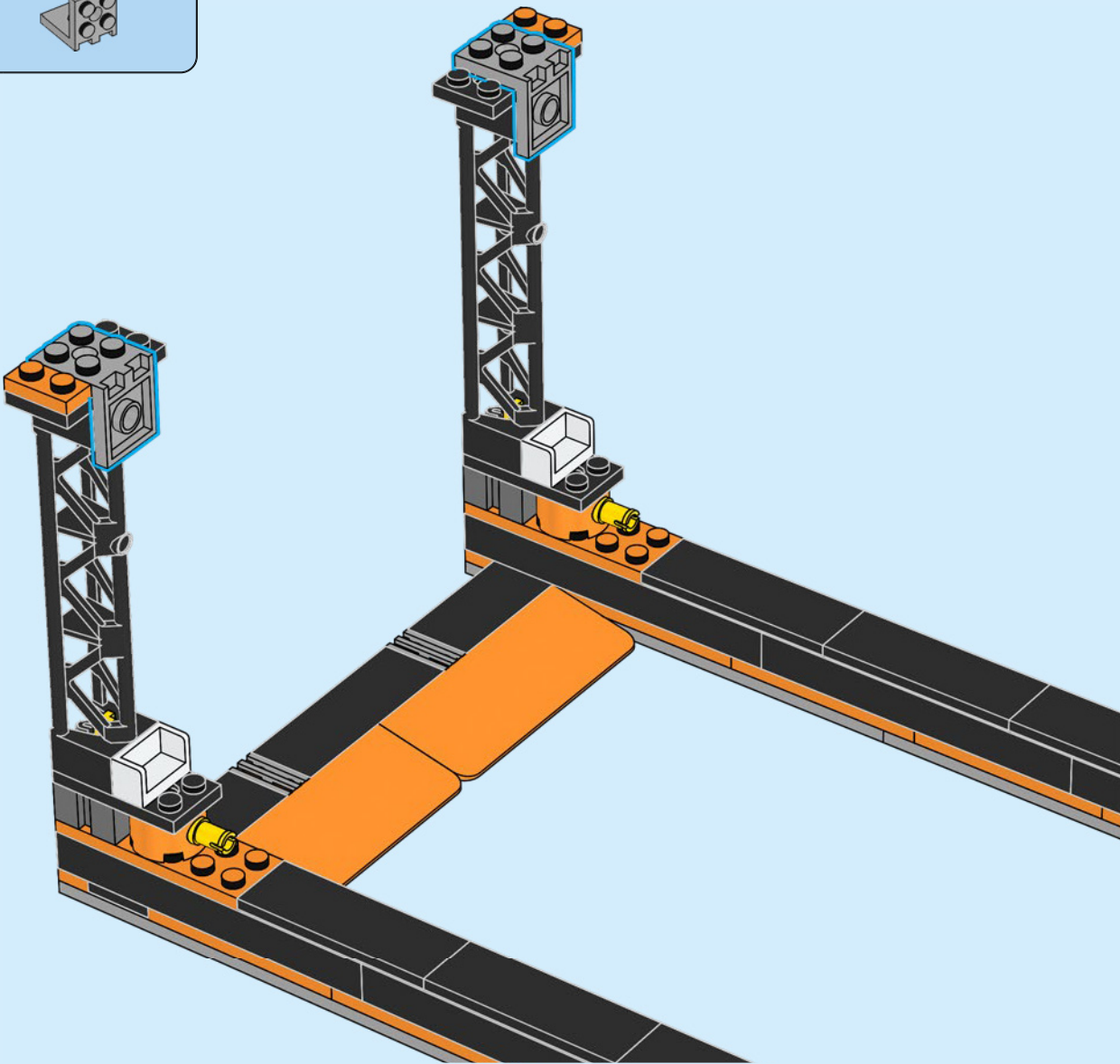

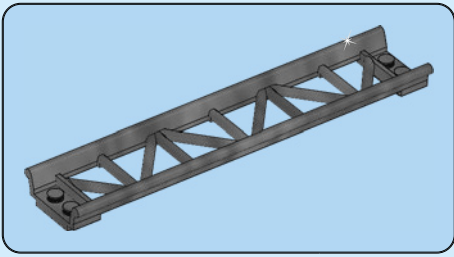

35

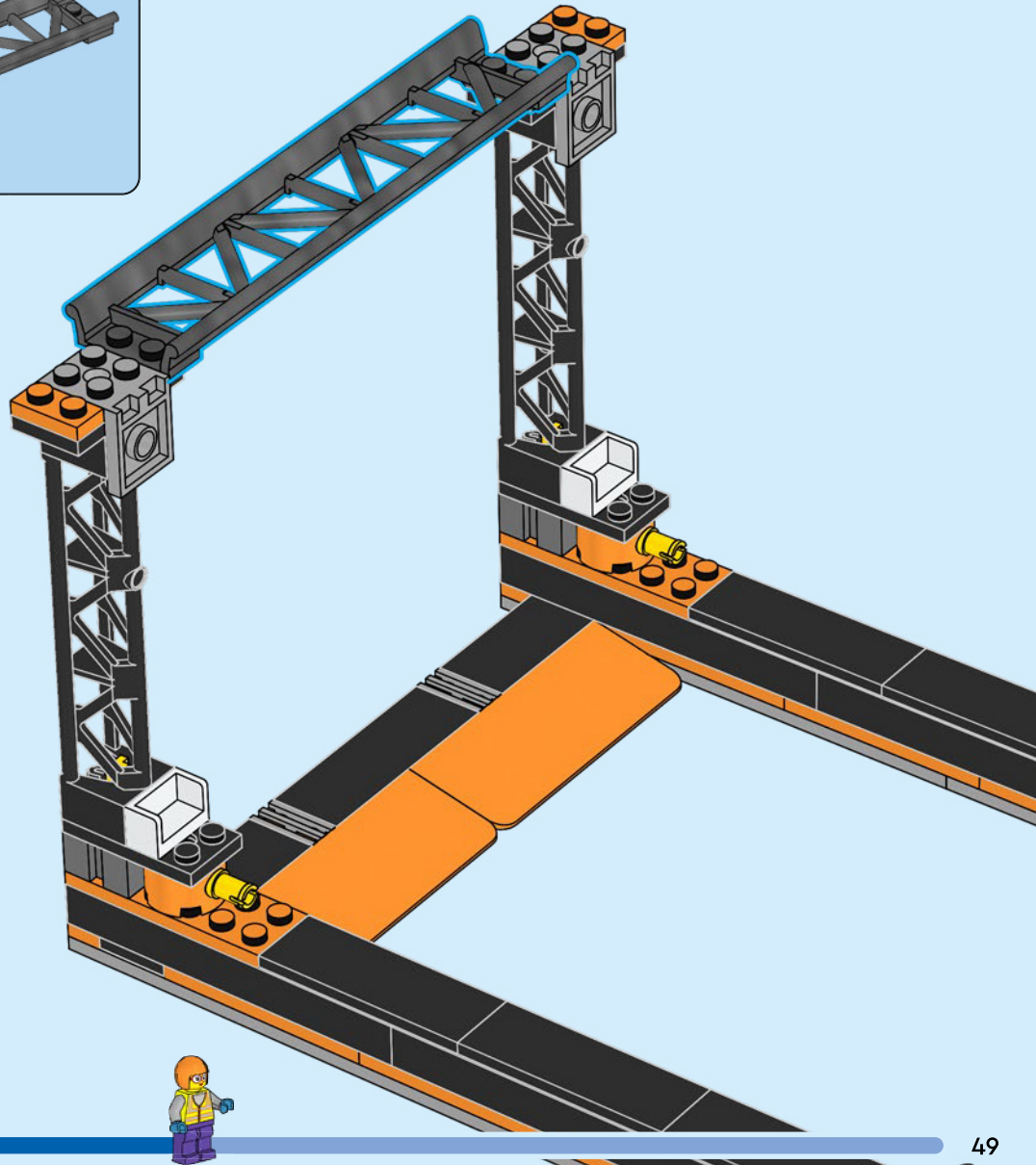

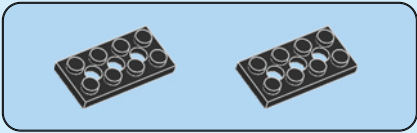

36

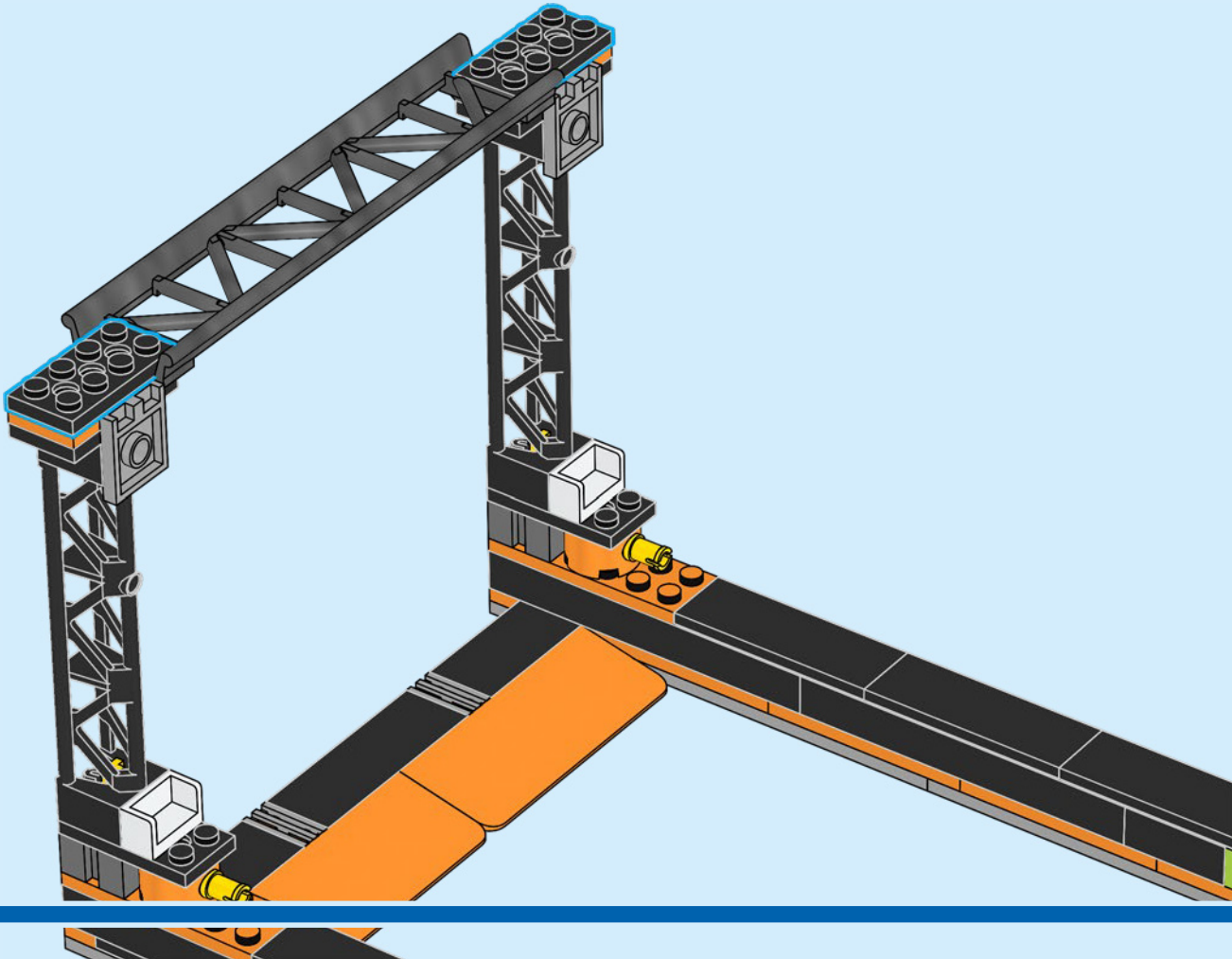

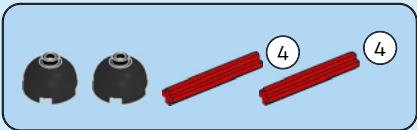

37

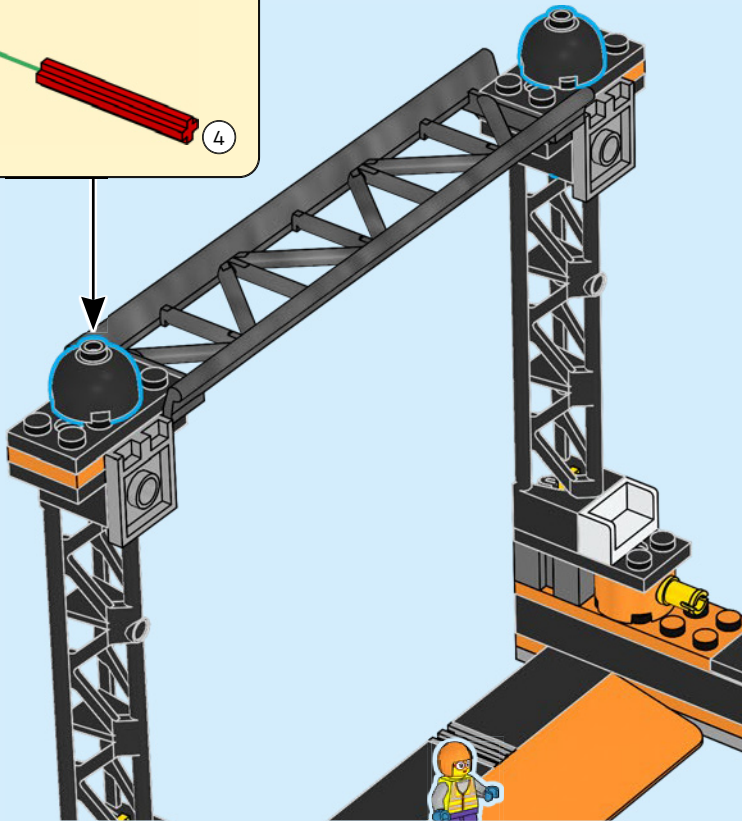
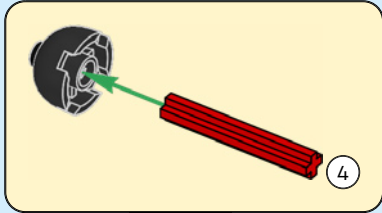
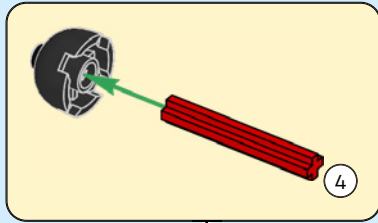

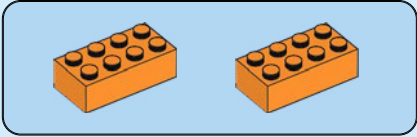
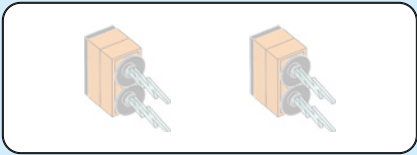

38

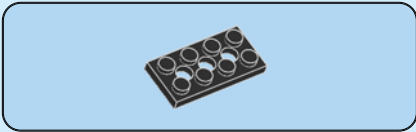
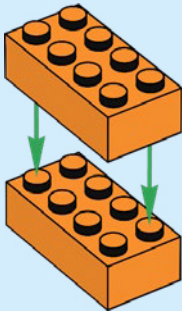

39

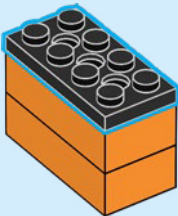

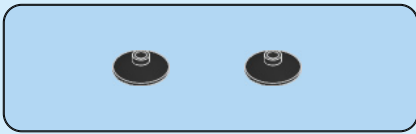

40

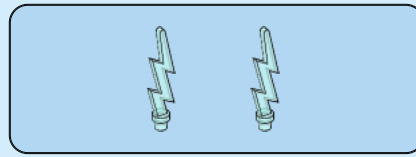
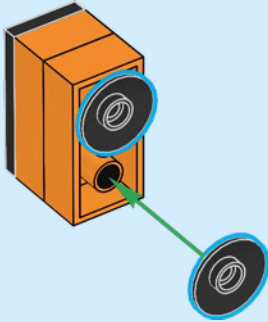

41

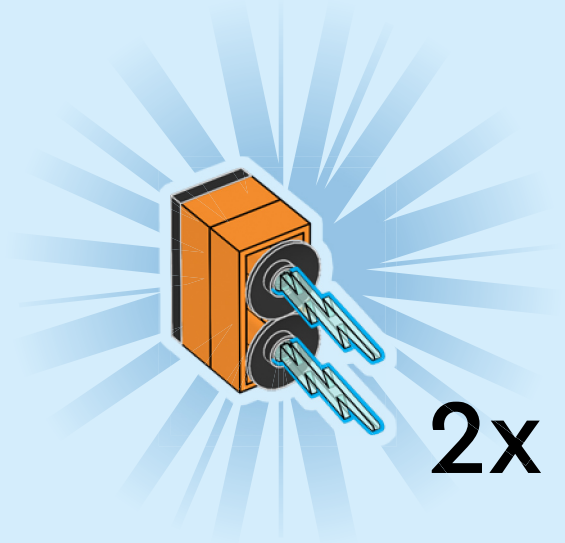

42

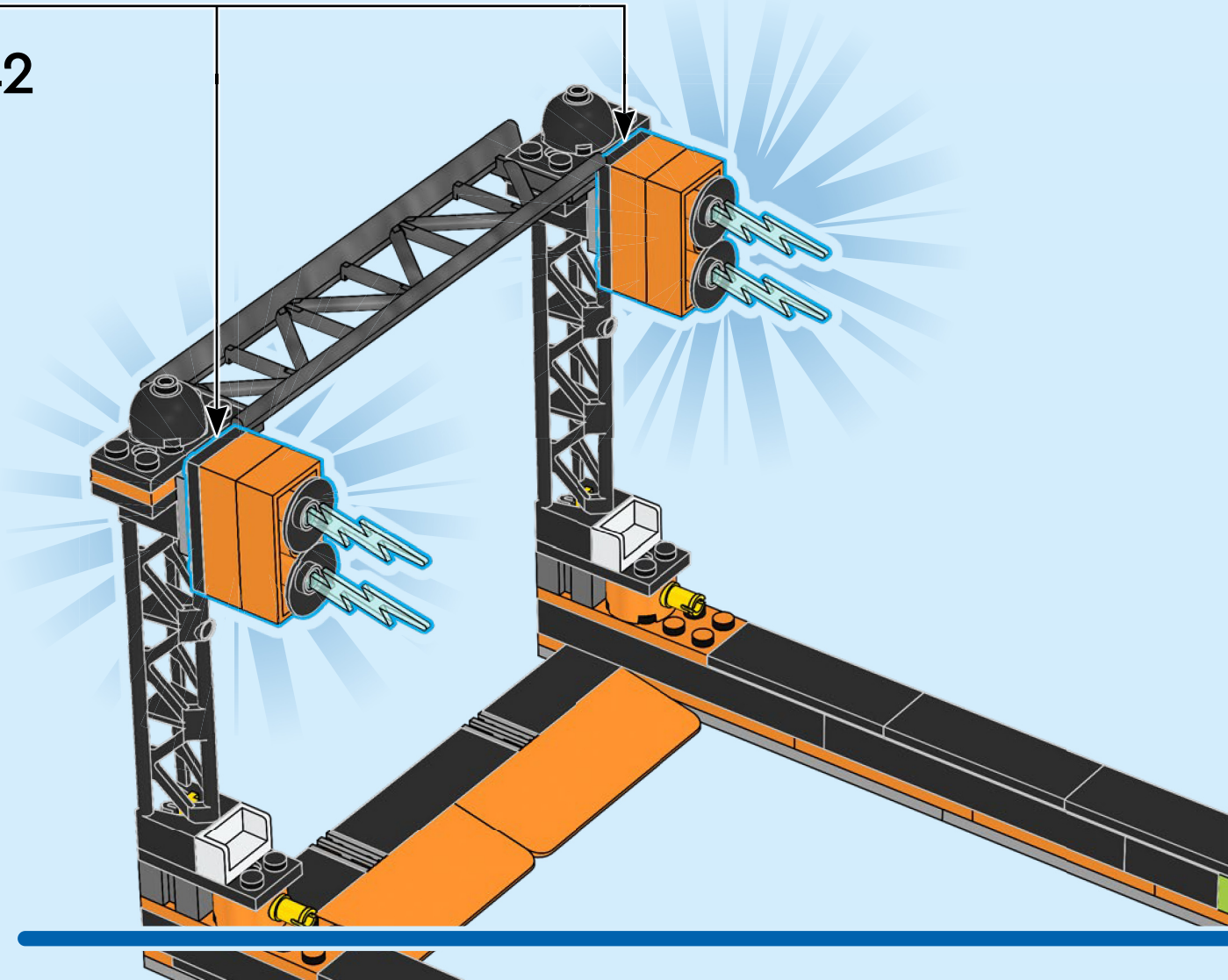

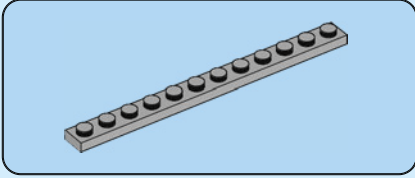
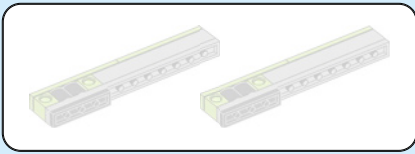

43

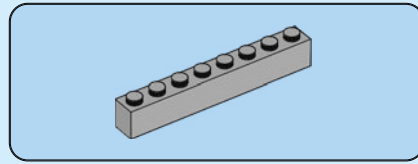
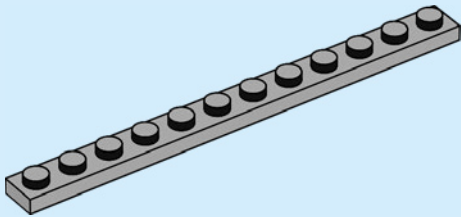

44

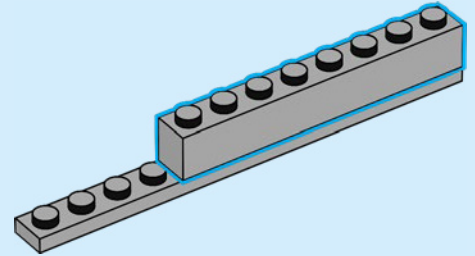

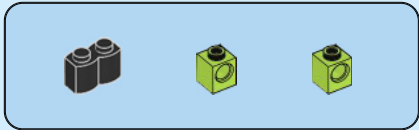

45

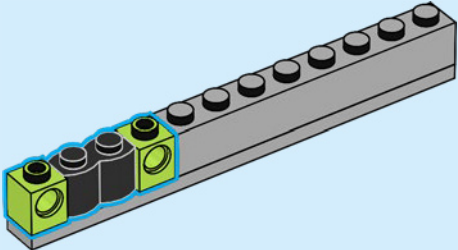

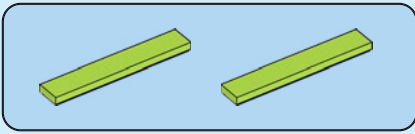

46

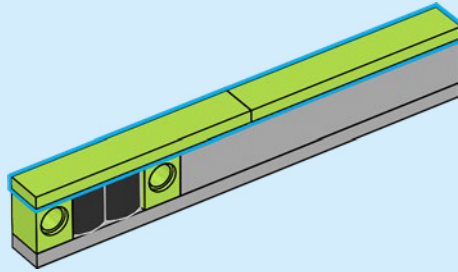

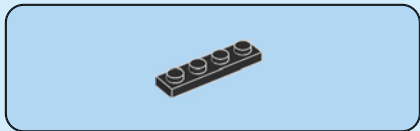

47

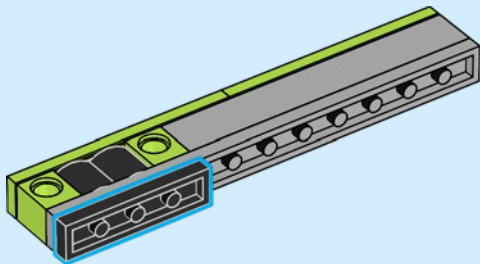
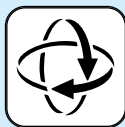

2x

48

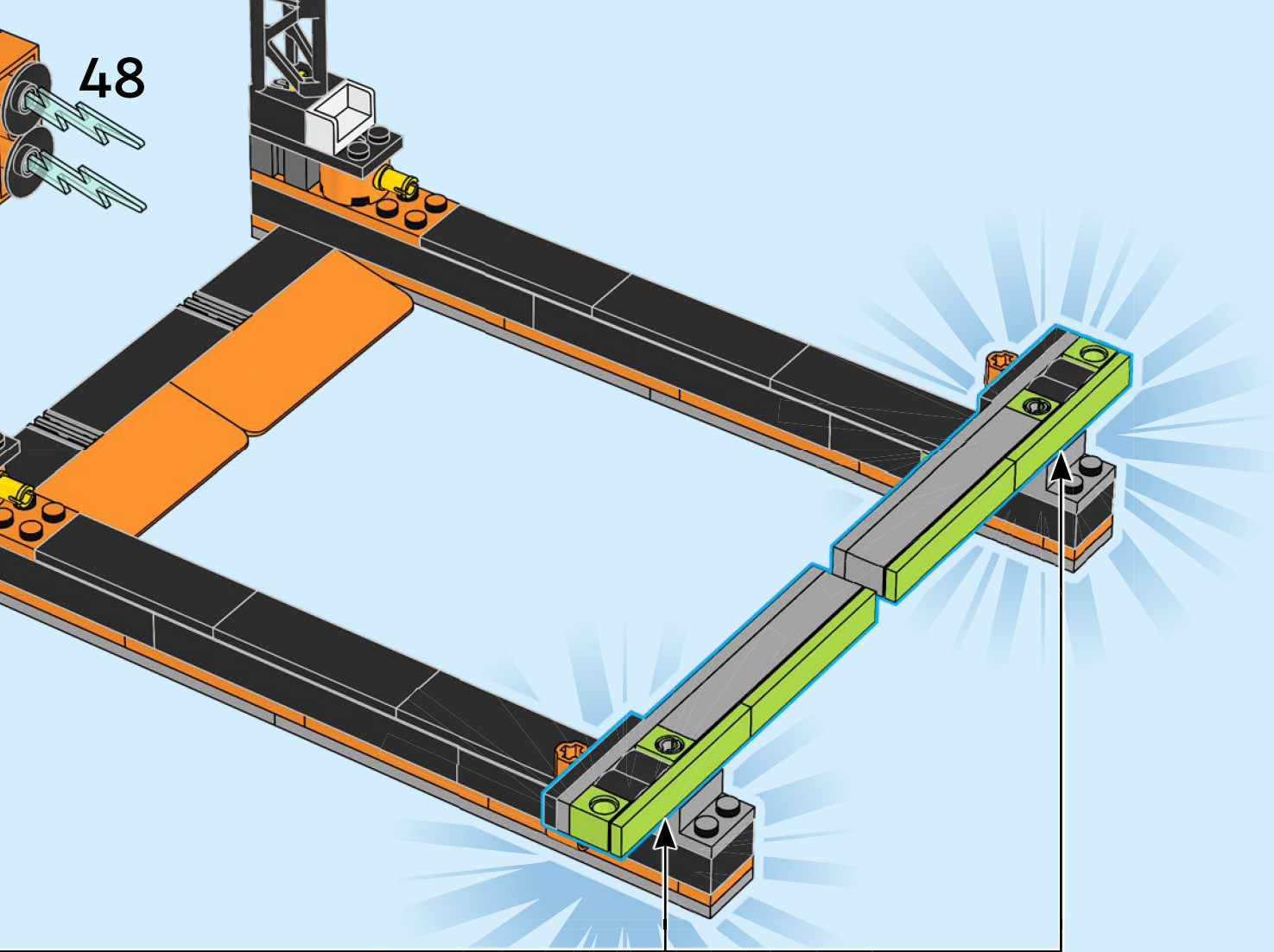

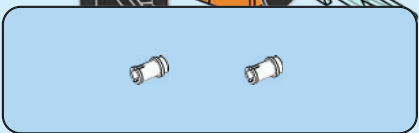

49

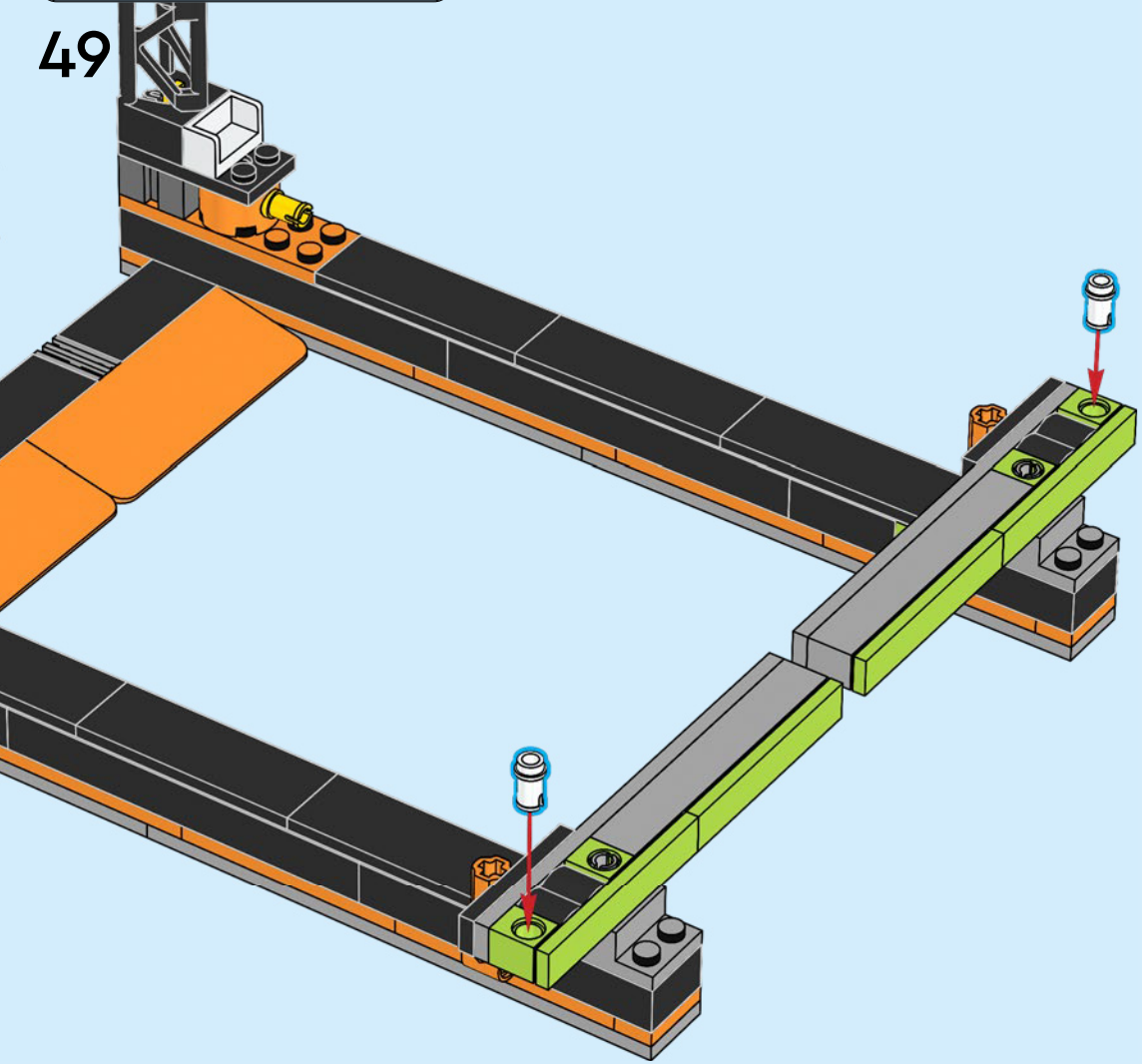

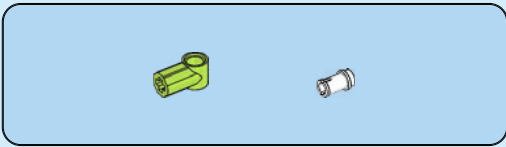
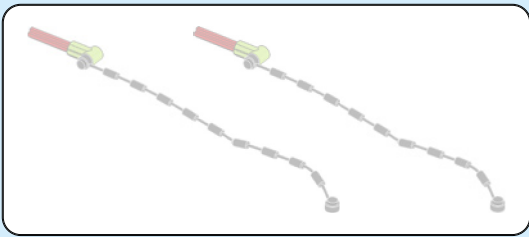

50

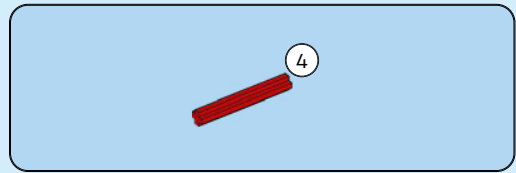
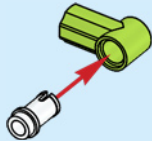

51

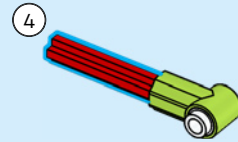

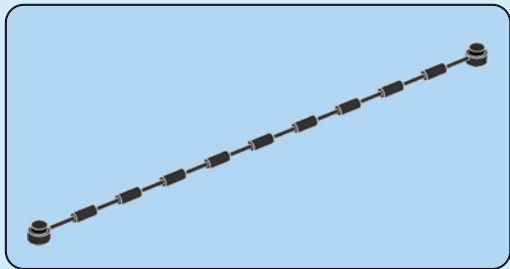

52

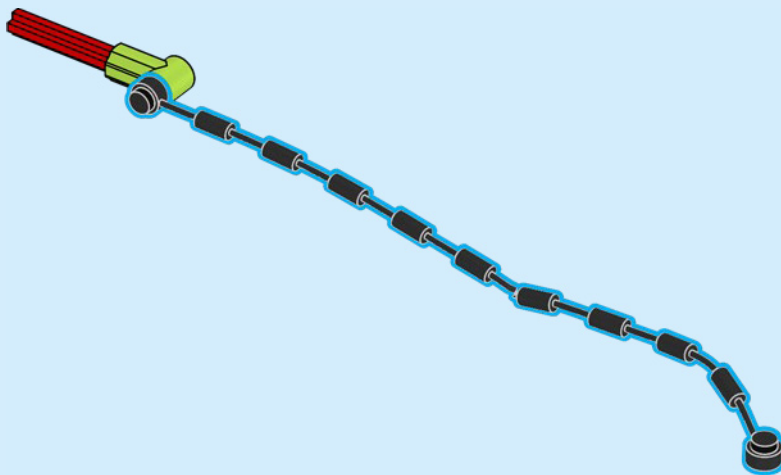

2x

53

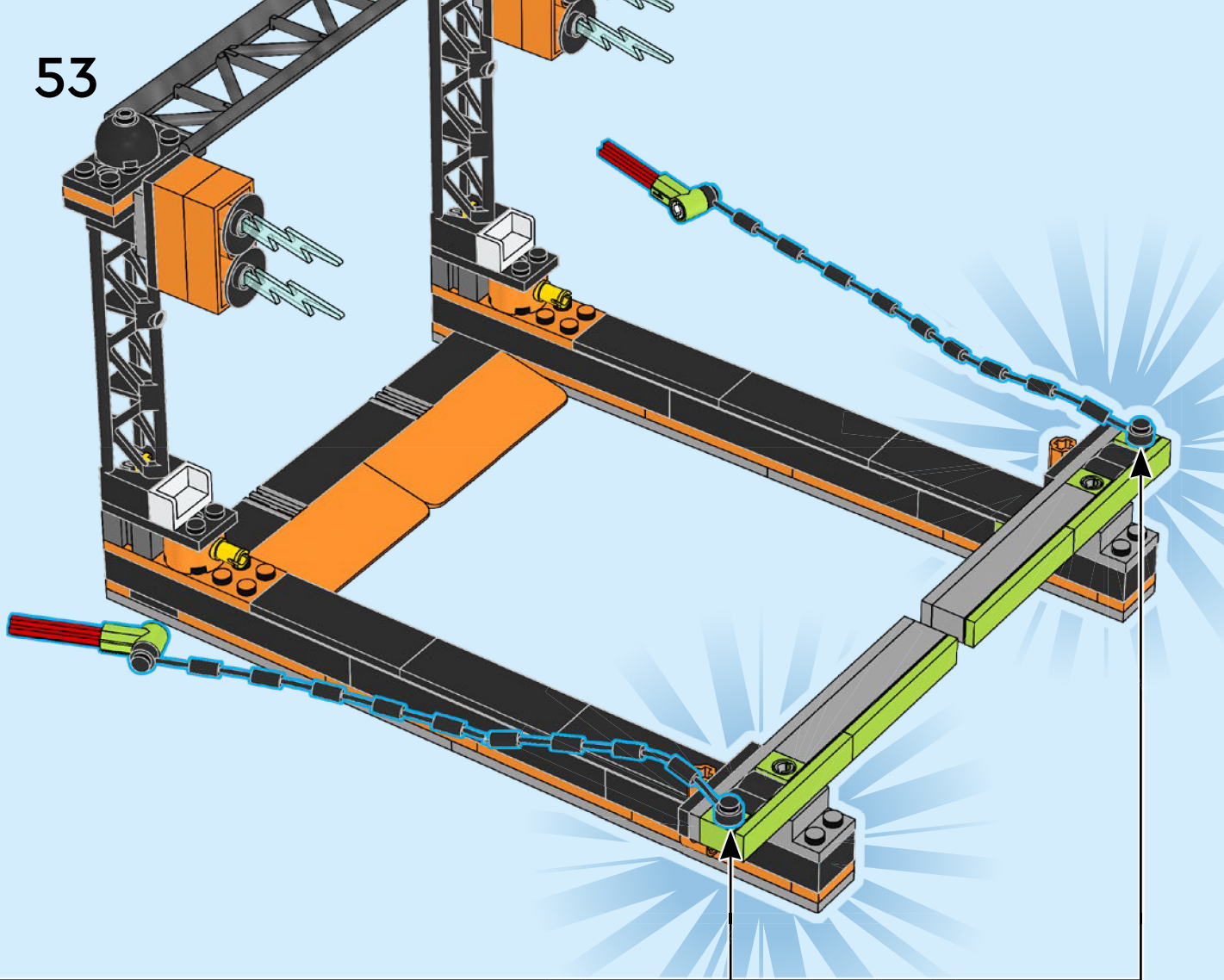

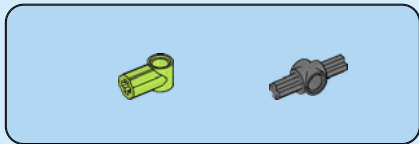
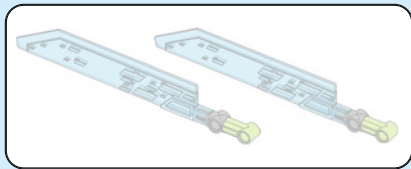

54

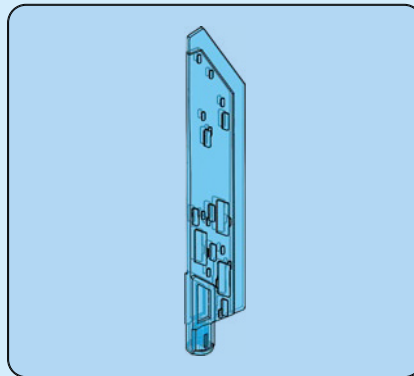
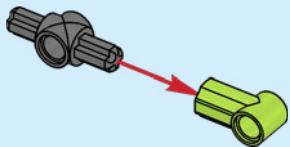

55

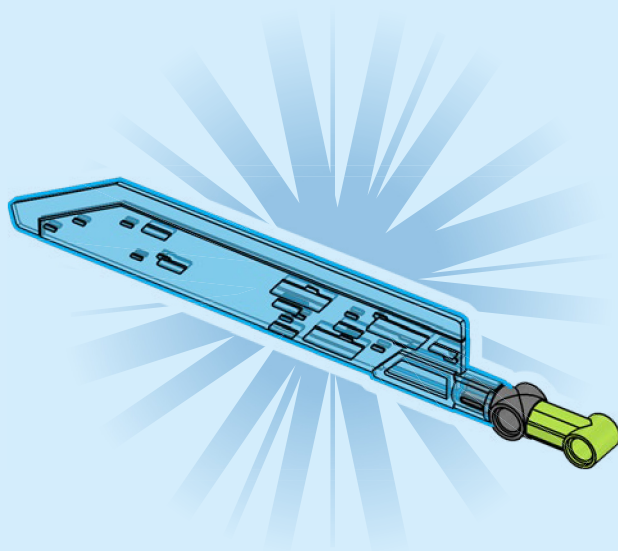

2x

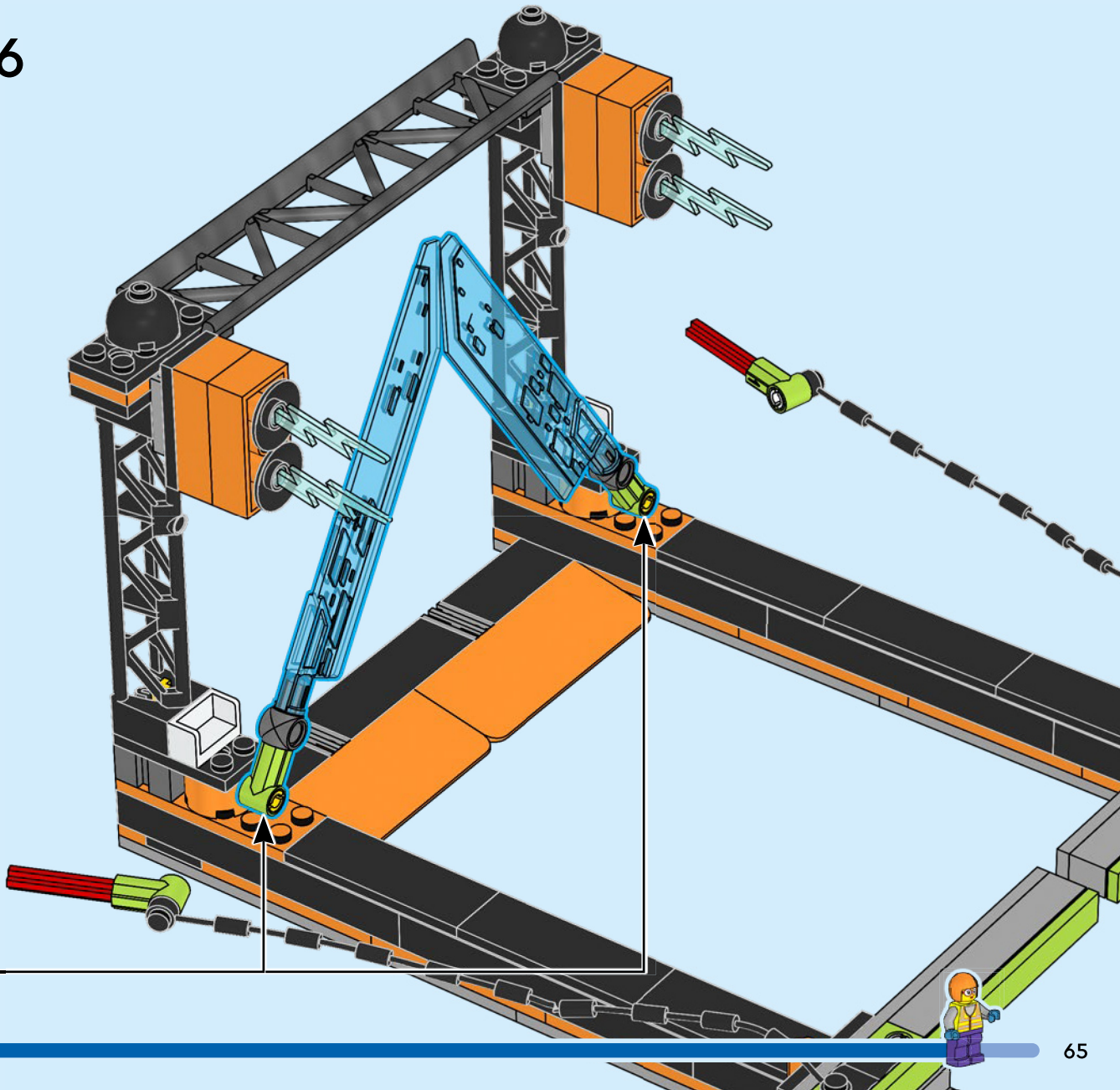

57

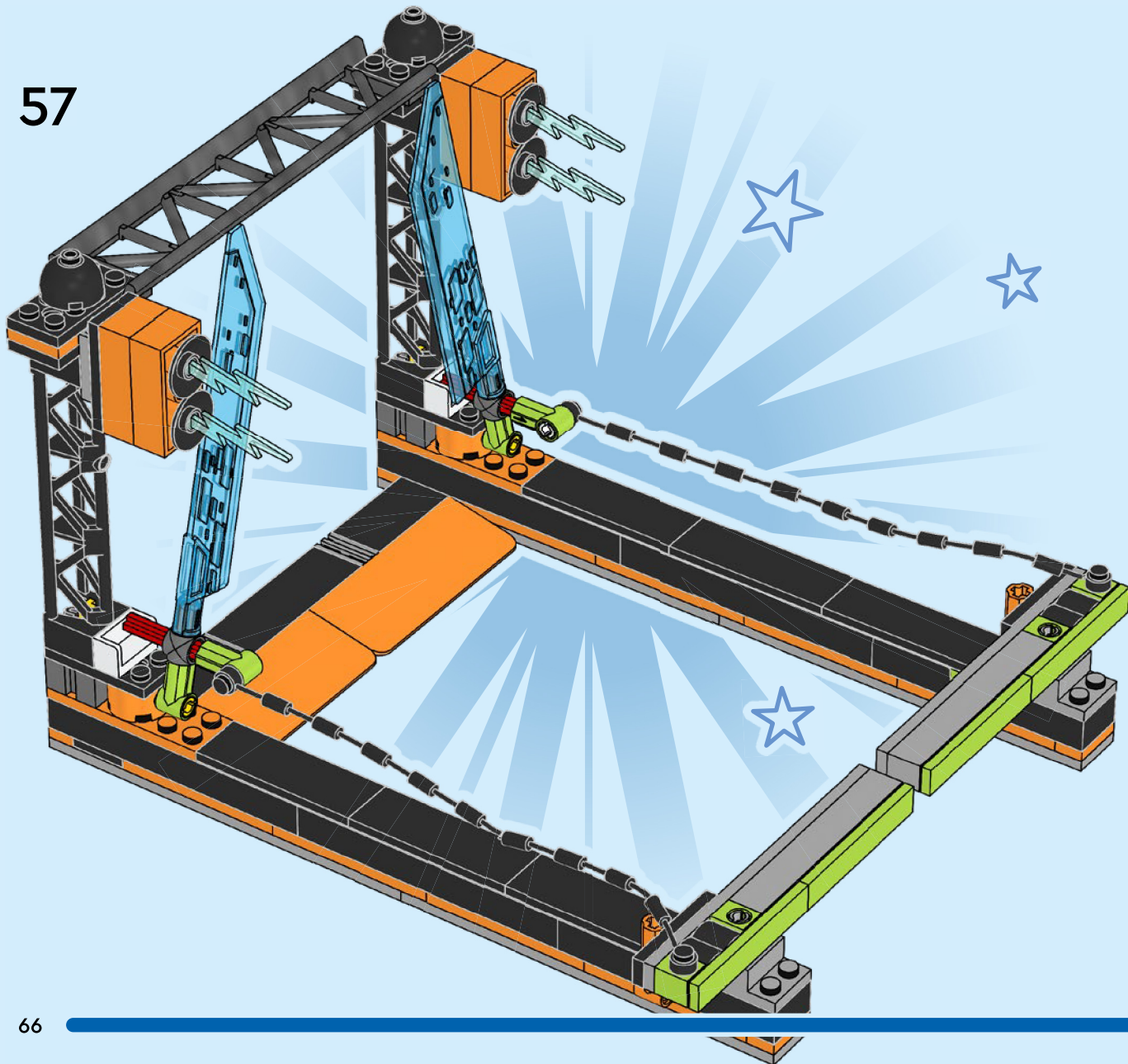

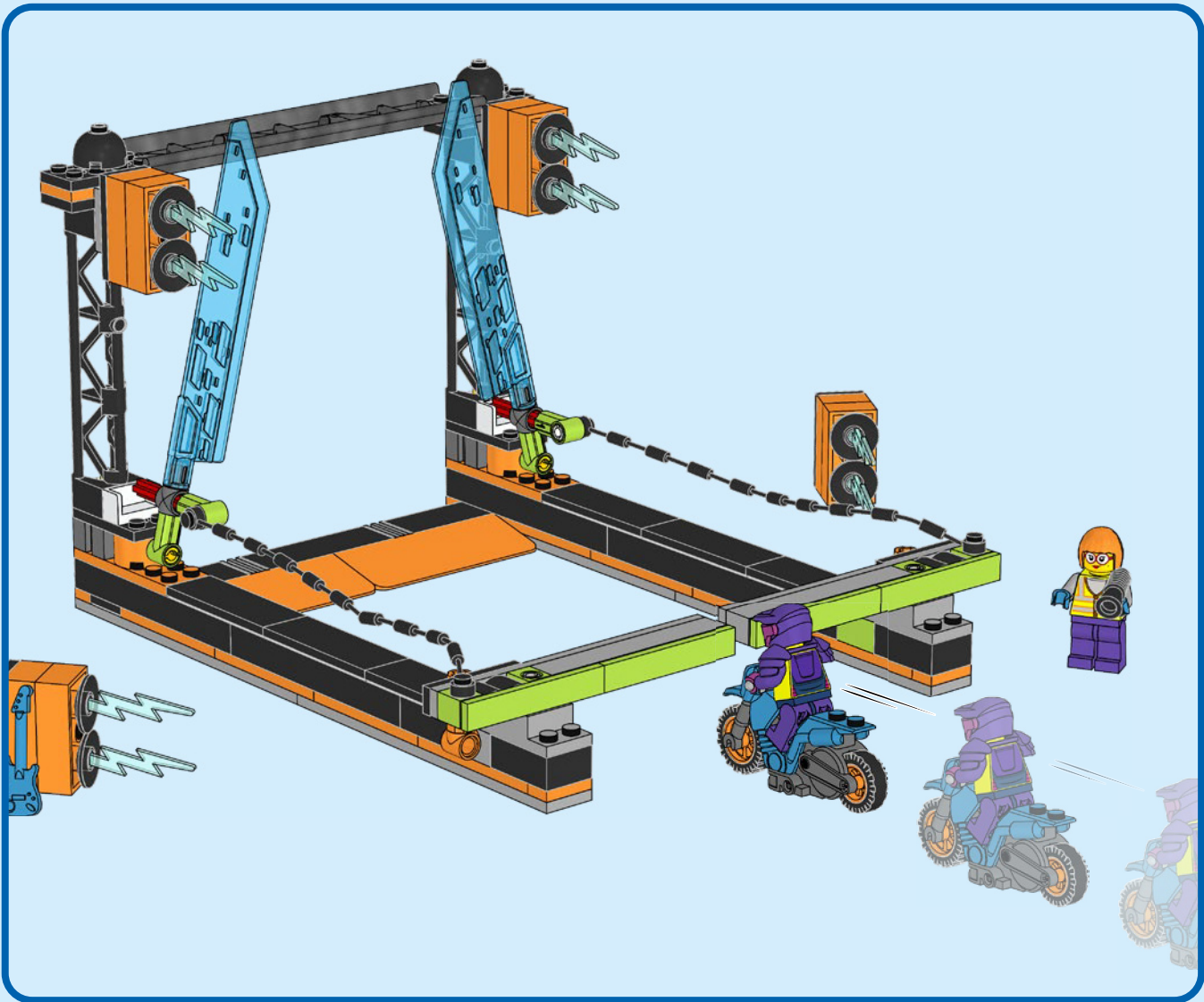



CITY



60331

+



60332

+



60333



60339

+



60338

+



60342

+



60341

+



60340



CITY



MISSIONS



 **FREE APP**
REQUIRED TO PLAY

Free app required to play
 Zum Spielen wird die kostenlose App benötigt
 Application gratuite nécessaire pour jouer
 App gratuita necessaria per giocare
 Se requiere una app gratuita para jugar
 Necessária app grátis para jogar
 A játékhöz appra van szükség (ingyenes)
 Lai spēlētu, nepieciešama bezmaksas lietotne
 Aplicația gratuită este necesară pentru a juca
 玩乐时需要此免费 App 应用程序
 プレイには無料アプリが必要です
 실행을 위해 무료 앱이 필요합니다



60353



60354



60355

MISSIONS	KÜLDETÉSEK
MISSIONEN	MISIJAS
MISSIONI	MISIUNI
MISIONES	任务
MISSÕES	



4x
6388018



2x
6248490



4x
6129995



2x
6167281



2x
6236949



1x
6356861



1x
6174618



8x
474026



2x
4216660



2x
4644456



1x
434926



1x
6064174

70



2x
4667463



4x
300226



2x
371026



10x
370926



9x
6318582

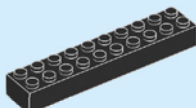

4x
4617860



2x
6096958



1x
6287323



1x
6336408



1x
6411000



2x
6120639



2x
6259825



2x
6143028



6x
4177932



8x
4153827

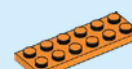

10x
4121741

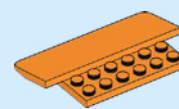

2x
6338339



1x
6391388



1x
6356476



1x
6392223



1x
6390087



1x
6391702



1x
6329613



2x
6331822



2x
6130007



1x
6391704



1x
4586410



1x
6356568



1x
6392222



2x
6206249



2x
4211350



1x
4258308



2x
6254807



2x
6301425

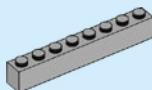

2x
4211392

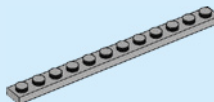

2x
4514846

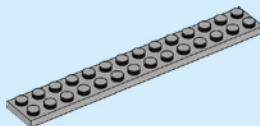

4x
4662161



2x
6390839



8x
6168590



4x
6310282



4x
6332867



2x
4164022

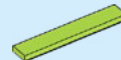

4x
6167465



1x
6392221

Customer Service
 Kundenservice
 Service Client
 Assistenza clienti
 Atención al cliente
 Serviço de Apoio ao Consumidor
 Ügyfélszolgálat
 Klientu apkalpošanas dienests
 Serviciul pentru clienți
 客户服务
 コンシューマーサービス
 고객 서비스
LEGO.com/service

WIN

Terms & Conditions apply

Scan this QR code or go to **LEGO.COM/PRODUCTFEEDBACK** and give us your short feedback about this LEGO® set for a chance to win a cool LEGO prize.



GEWINNE

Scanne diesen QR-Code oder geh auf LEGO.COM/PRODUCTFEEDBACK

und gib uns dein kurzes Feedback zu diesem LEGO® Set. Dann hast du die Chance, einen coolen LEGO Preis zu gewinnen.

Es gelten die Teilnahmebedingungen

GAGNE

Scannez ce code QR ou rendez-vous sur LEGO.COM/PRODUCTFEEDBACK

pour donner votre avis sur ce produit LEGO® et avoir une chance de gagner un prix LEGO.

Voir Conditions Générales

GANAN

Escanea este código QR o visita LEGO.COM/PRODUCTFEEDBACK

y comparte con nosotros tu opinión sobre este set LEGO® para tener la oportunidad de ganar un fantástico premio LEGO.

Términos y Condiciones aplicables

获取奖品

只需扫描此二维码或访问 LEGO.COM/PRODUCTFEEDBACK,

就这款乐高®套装提供简短反馈, 就有机会赢得很酷的乐高奖品。

《条款及条件》适用