



Architecture

21043

San Francisco

California, USA

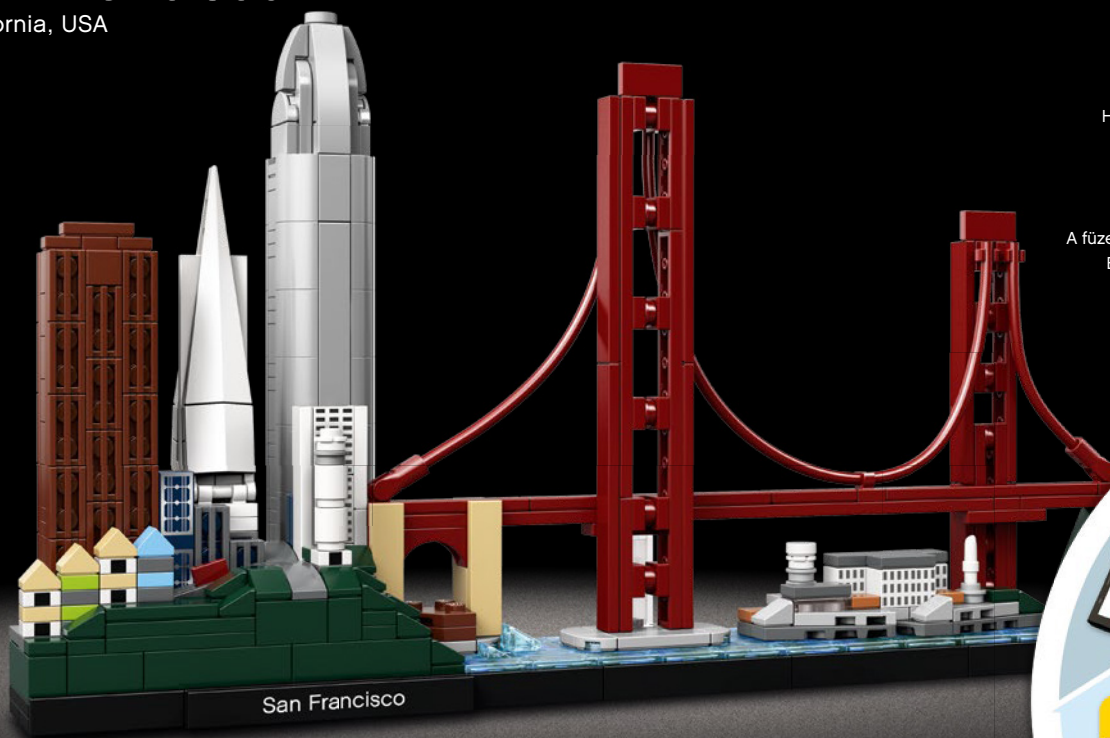

Booklet available in English on
Heft in deutscher Sprache erhältlich auf
Livret disponible en français sur
Libretto disponibile in italiano su
Folleto disponible en español en
Folheto disponível em português em
A füzet magyarul ezen a honlapon olvasható
Buklets latviešu valodā pieejams vietnē
如需中文版手册, 请访问

LEGO.com/architecture



San Francisco

As the fourth largest city in California and the cultural, commercial and financial hub of Northern California, San Francisco's eclectic mix of architecture showcases both its geography and its rich history. It's been more than fifty years since San Francisco enjoyed its revolutionary "Summer of Love" and, having undergone much development since then, this City by the Bay offers a plethora of architectural and cultural delights to its residents and visitors.

"San Francisco has only one drawback: it's hard to leave."

Rudyard Kipling







555 California Street (formerly known as Bank of America Center)

Located in the center of San Francisco's financial district, this iconic skyscraper is the fourth tallest building in the city and the largest by floor area. Until the merger in 1998 with NationsBank, it was the headquarters of the Bank of America and was intended as a display of prosperity, power and importance. Wurster, Bernardi and Emmons and Skidmore, Owings and Merrill designed the carnelian-clad building, in consultation with architect Pietro Belluschi.



“Painted Ladies”

Painted Ladies refers to the San Franciscan architectural phenomenon of brightly painted Victorian or Edwardian houses, acquiring its name from a 1978 photo essay by writers Elizabeth Pomada and Michael Larsen. The transformation of these formerly sober-colored houses into cheerful and colorful buildings is believed to have been led by a local artist who painted his own Victorian house in vivid blues and greens in the 1960s, starting what was known as the ‘colorist movement’, which continues to this day. In parts of the city, San Francisco’s Painted Ladies stand in stark contrast to the skyscrapers of the downtown area.

Transamerica Pyramid

At 48 stories, the Transamerica Pyramid is the second tallest building in the San Francisco skyline and is one of the symbols of the city. Commissioned by The Transamerica Corporation, the striking, angular building was designed by architect William Pereira, and built by Hathaway Dinwiddie, with construction being completed in 1972. During the seasonal holidays and for special occasions, a bright beacon known as the 'Crown Jewel' lights up the pyramid's peak.



Salesforce Tower

Located downtown in the 'SoMa' district of the city, the Salesforce Tower is the tallest building in the San Francisco skyline. Designed by César Pelli and opened in 2018, the soaring 1,070 ft. (326m) tall, 61-story tower has an elegant, obelisk shape with horizontal metal fins that act as sunshades. The building has been created with an emphasis on sustainable design, including a water recycling system and high efficiency air ventilation. The sunshades on the outside maximize light but reduce solar gain, while heat-exchanging coils in the foundation utilize the earth's constant cooler temperature to aid cooling of the building.





Coit Tower

The Lillian Coit Memorial Tower is a memorial tower located in Pioneer Park in the Telegraph Hill neighborhood of San Francisco. This art deco monument was designed by architects Arthur Brown Jr and Henry Howard and dedicated in 1933. The tower was built to commemorate Lillian Hitchcock Coit, who was a local character and a champion and benefactor of firefighters. Her bequest to the city of San Francisco also sponsored the creation of a statue of three firefighters in Washington Square Park.

Fort Point

The masonry seacoast fortification, Fort Point, dates all the way back to the American Civil War when it was built by the United States Army to defend San Francisco against hostile warships. Now protected as the Fort Point National Historic Site, the fortification never saw hostilities during the Civil War and over the subsequent years was used for military barracks, training and storage.



Golden Gate Bridge

The Golden Gate Bridge is one of the best-known and most beautiful bridges in the world and one of the emblems of San Francisco. With its iconic color, spectacular location and graceful lines, this suspension bridge is a design and engineering marvel and the city's most popular tourist attraction. Designed by Irving Morrow, Charles Alton Ellis and Joseph Strauss, the bridge was created to make travel between San Francisco and Marin County easier; but due to differing interests among the stakeholders, it was over a decade before it got the green light. Construction took four years and it was finally opened in 1937 during a week of official celebrations.



Alcatraz Island

Located 1.25 miles (2 kilometers) offshore from San Francisco in its bay, Alcatraz was developed with facilities for a lighthouse and a military fortification and was used as a prison between 1934 and 1963. Today it is part of the Golden Gate National Recreation Area and is open for tours.



1



2



3

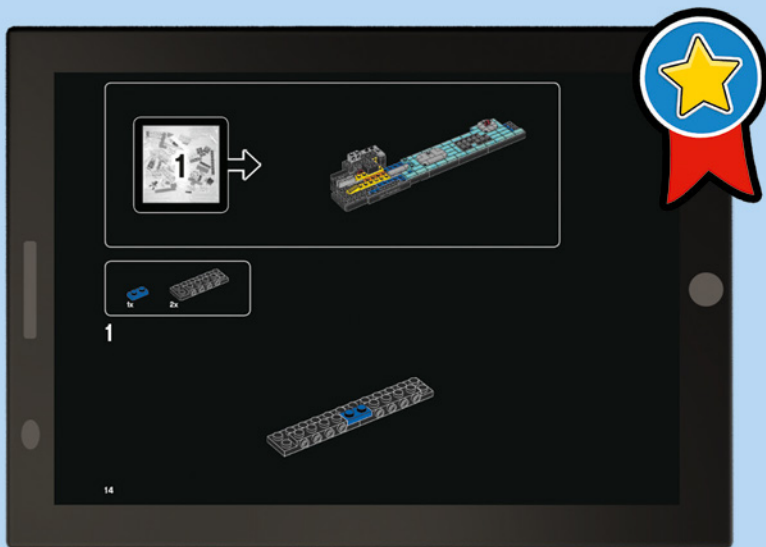

LEGO.com/apps

Check for compatibility
Kompatibilität prüfen
Vérifier la compatibilité
Controlla la compatibilità
Comprueba tu compatibilidad
Verificar a compatibilidade
Ellenőrizd a kompatibilitást
Pārbaudīt saderību
检查兼容性

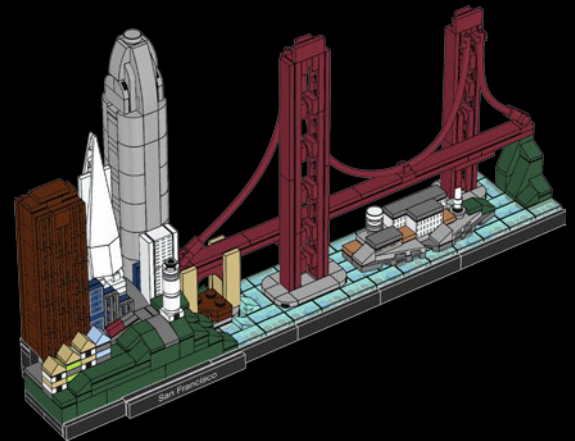
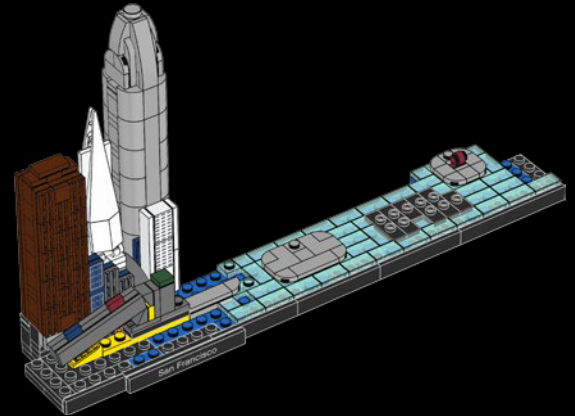
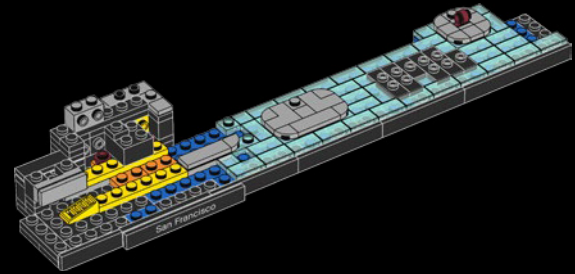

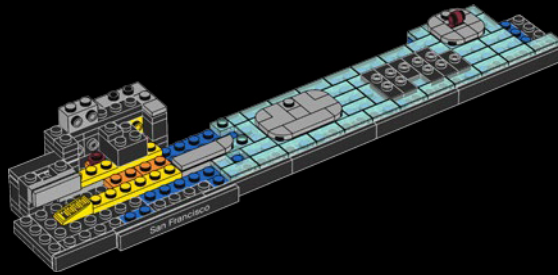

1x

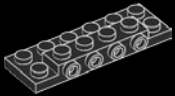

2x

1

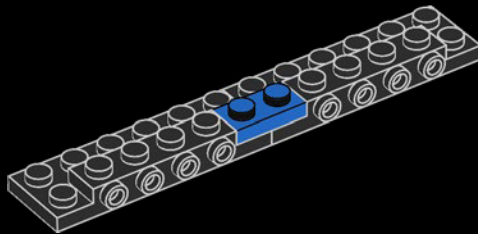

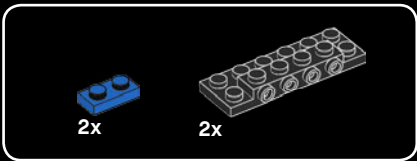

2

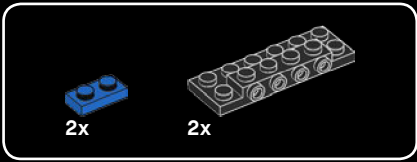
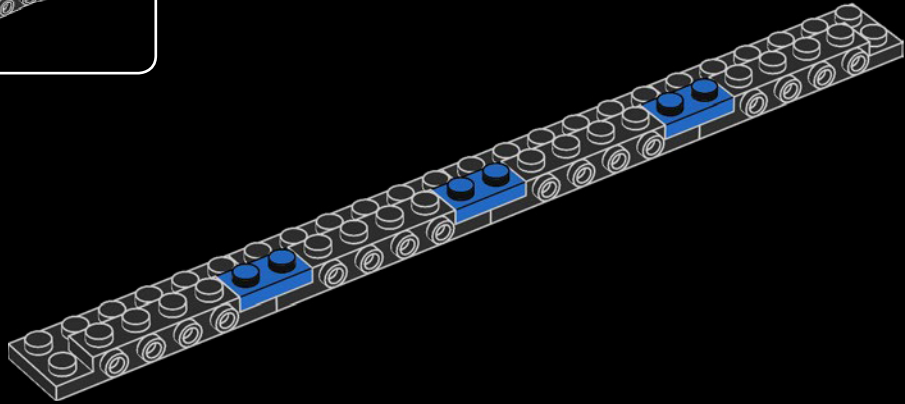

3

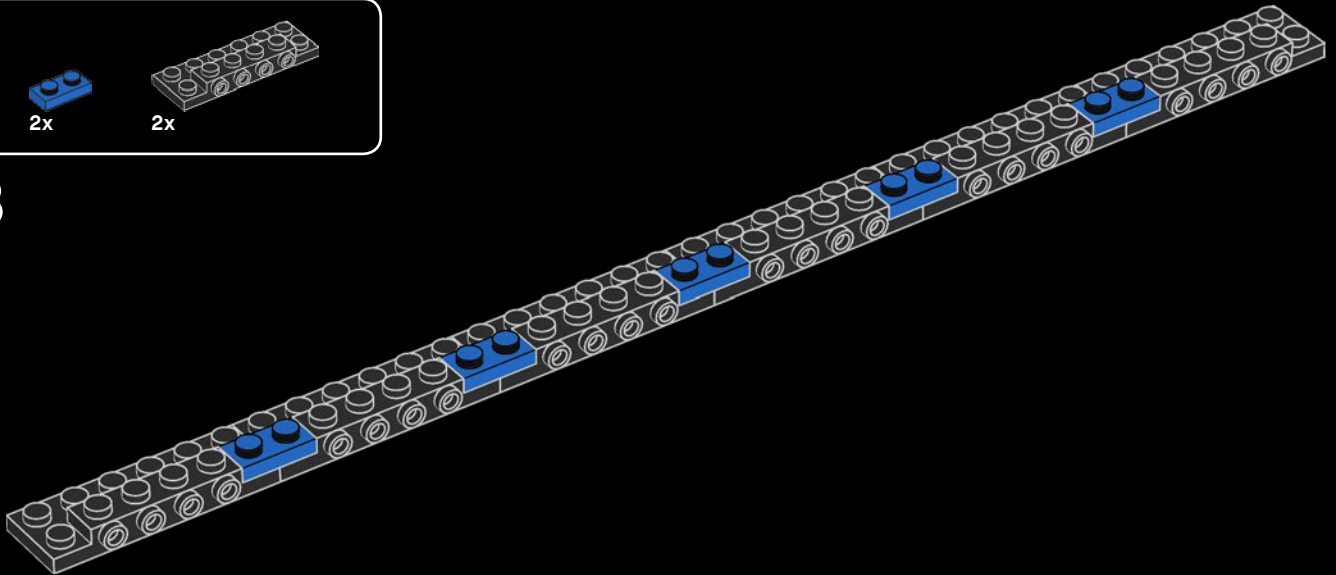

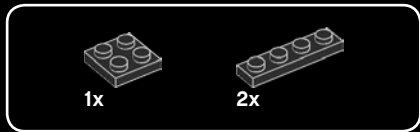

4

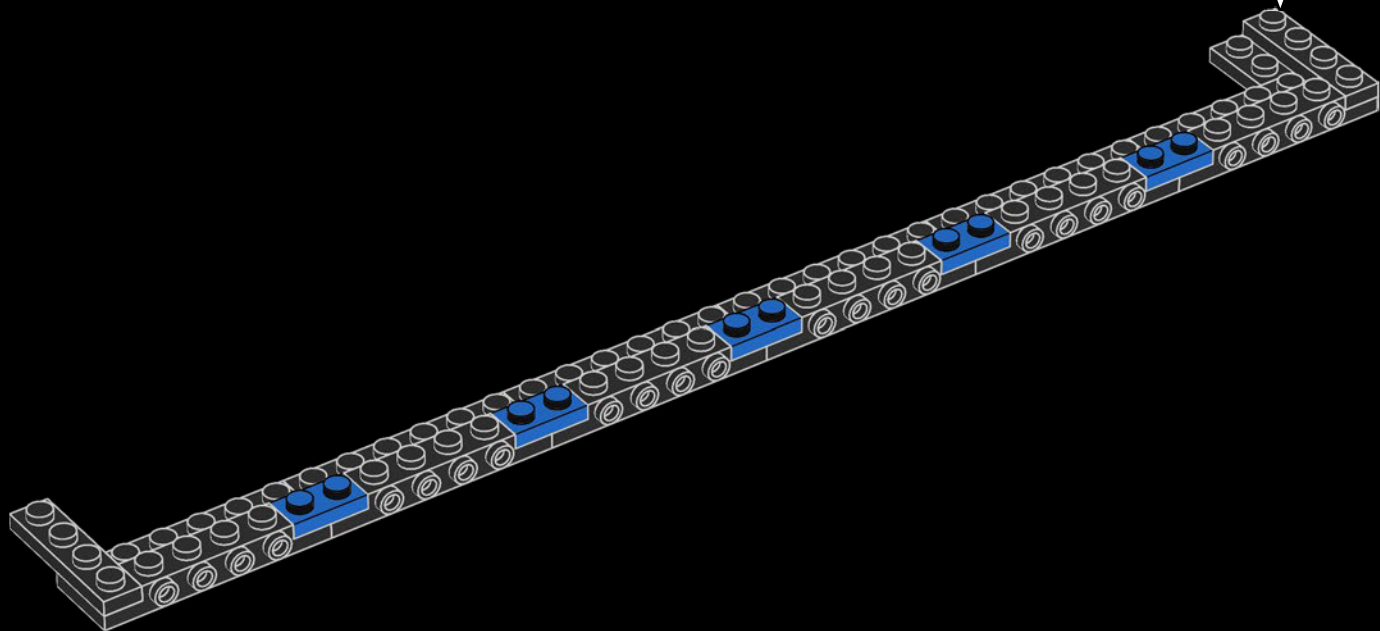
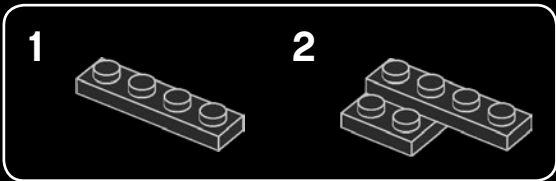

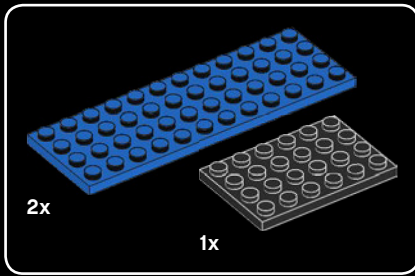

5

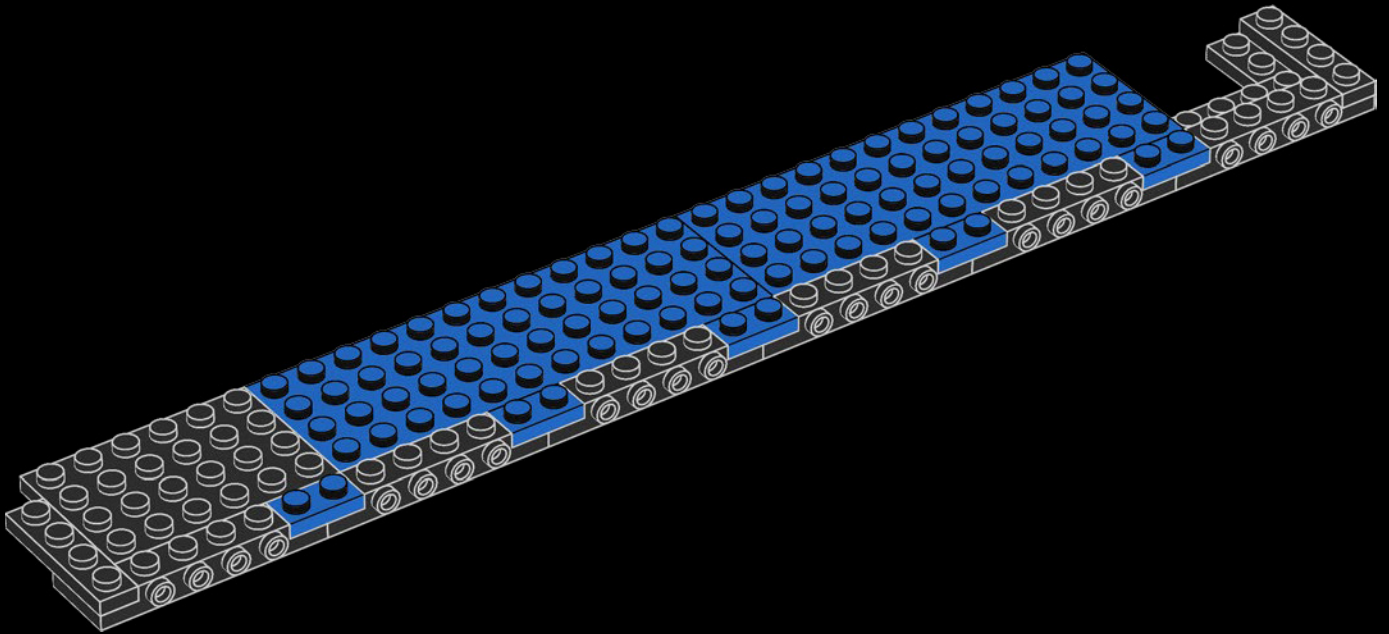

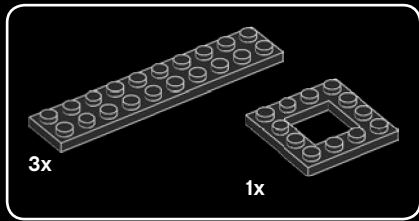

6

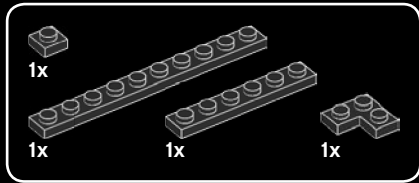
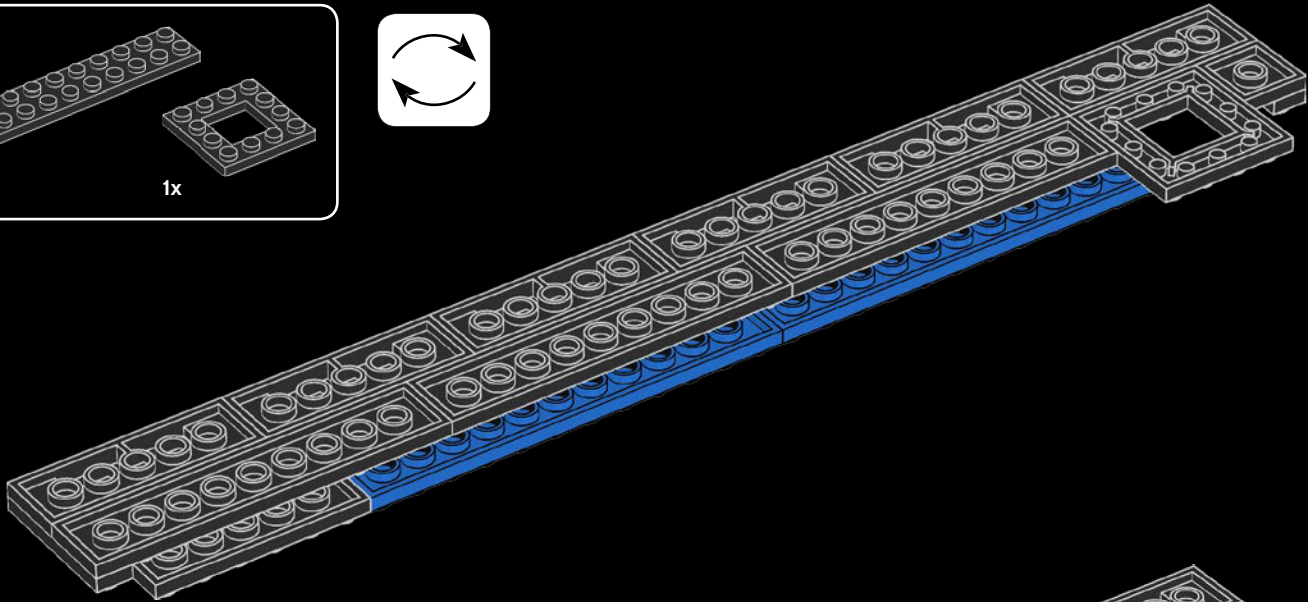

7

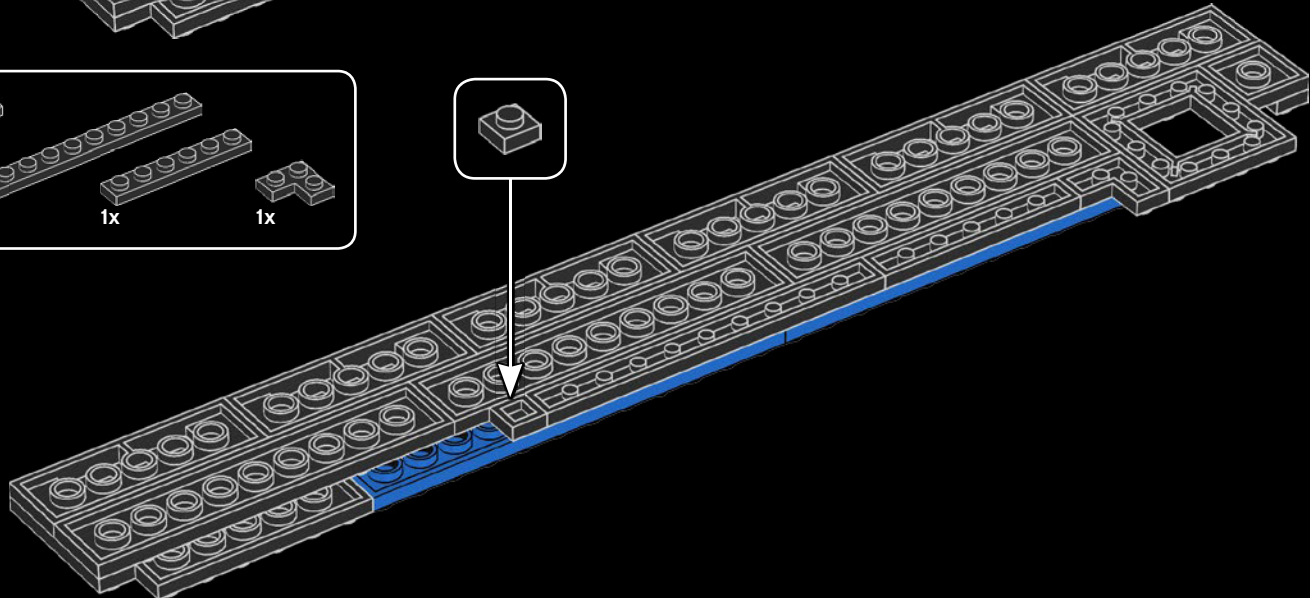

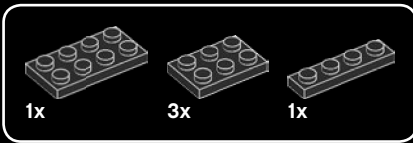

8

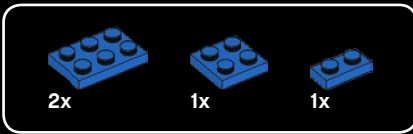
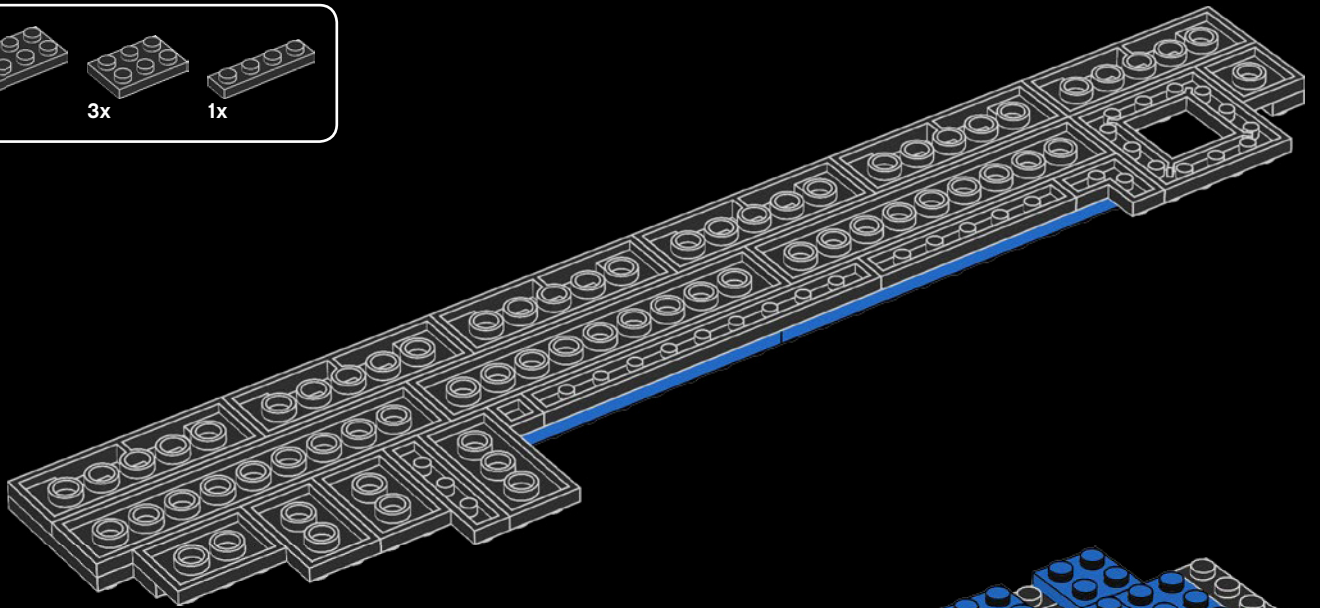

9

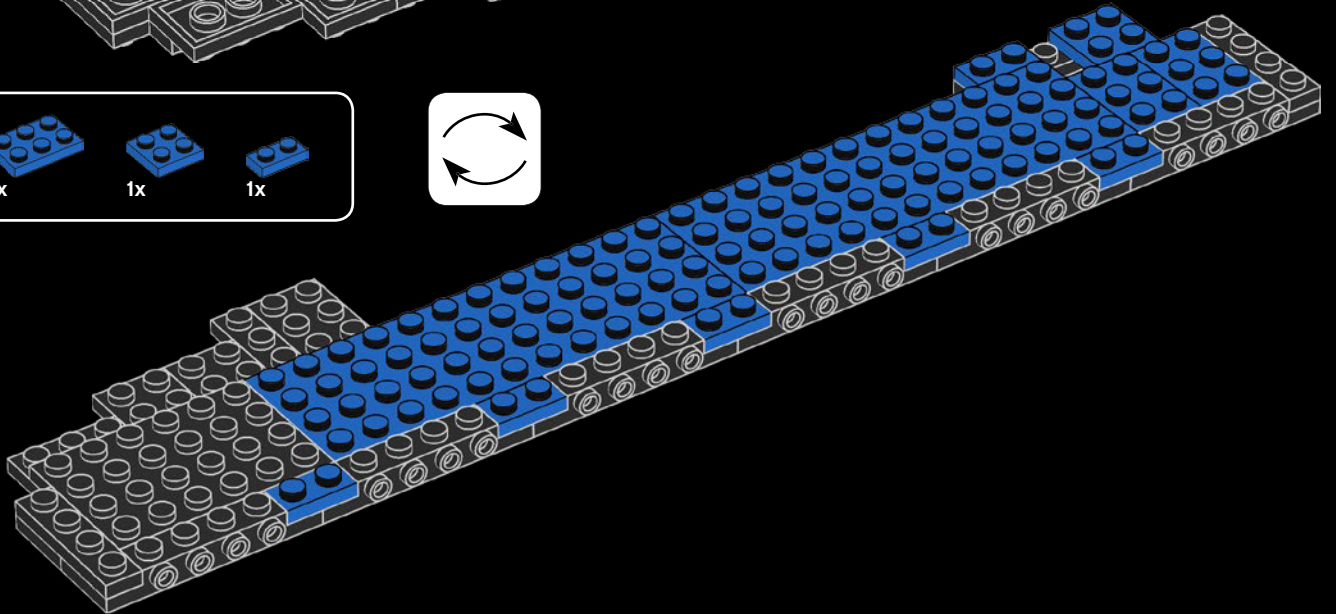

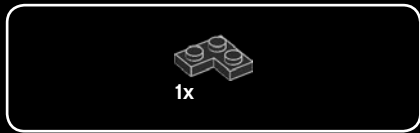

10

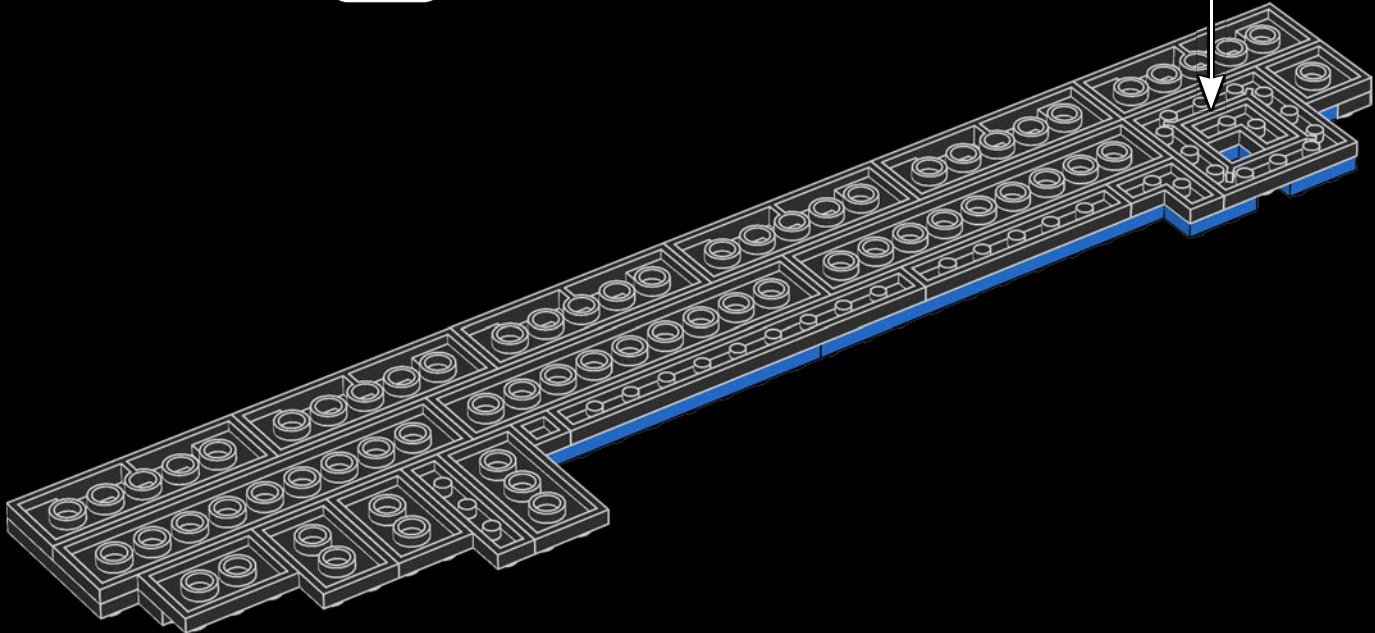
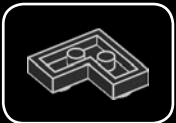

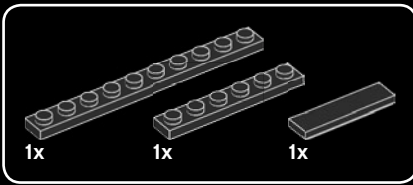

11

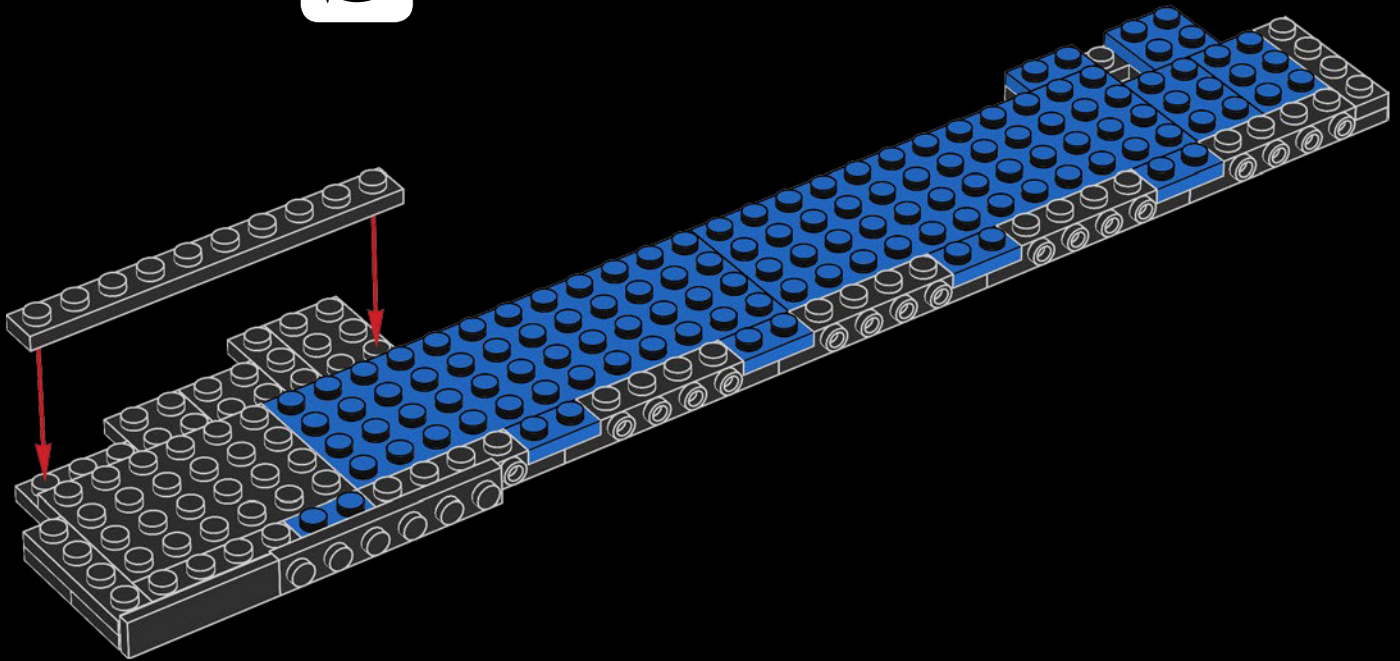
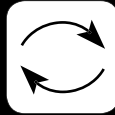

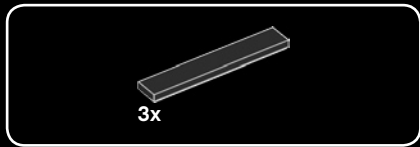

12

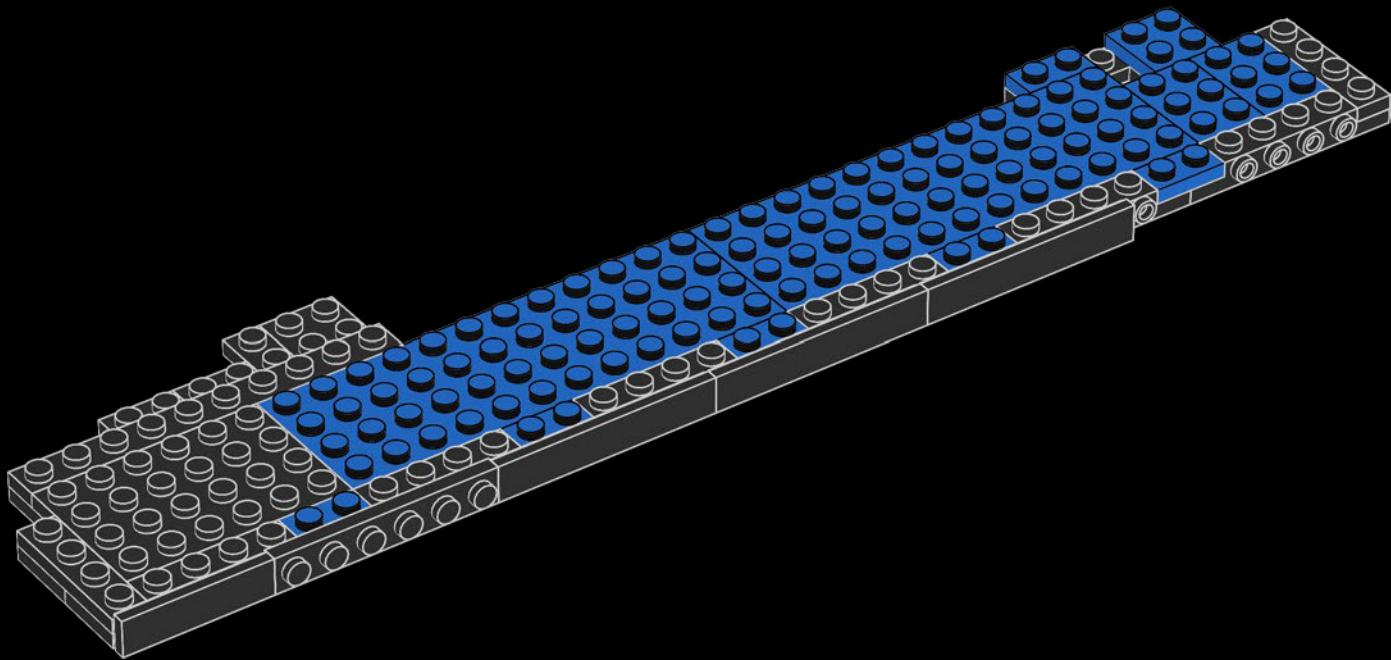

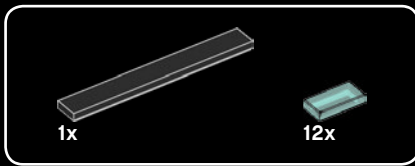

13

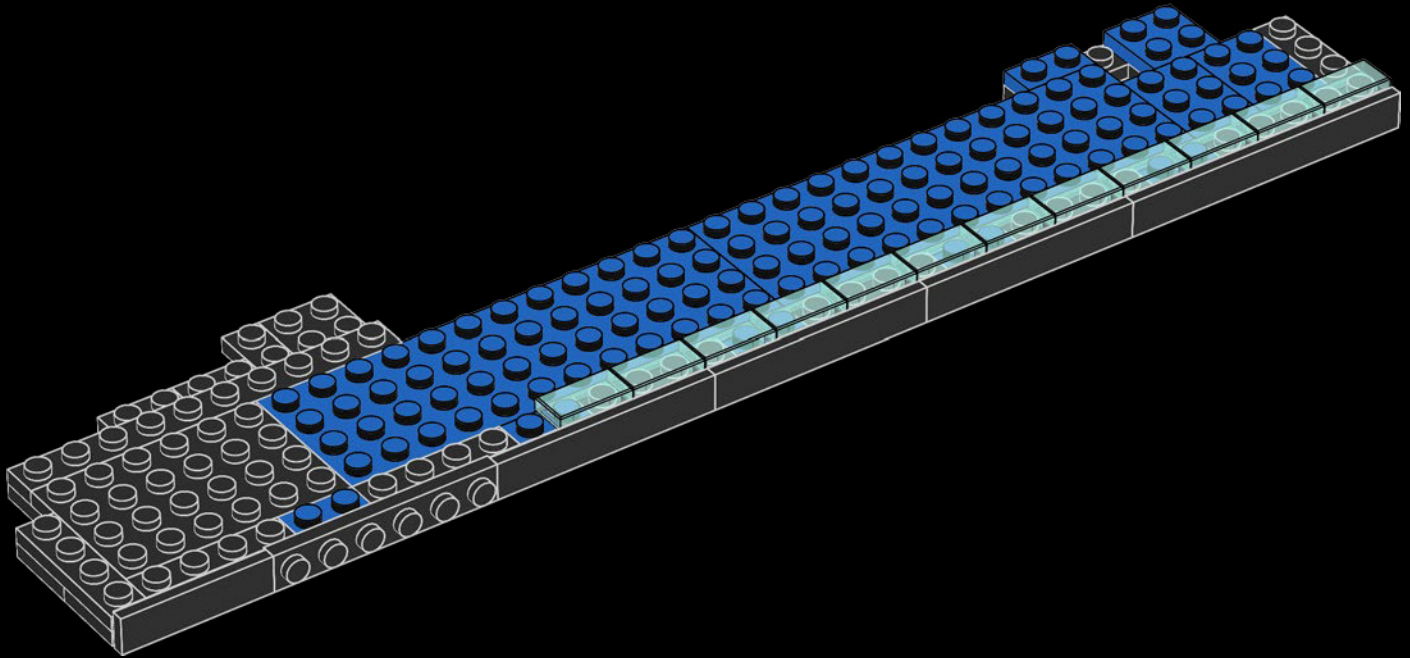

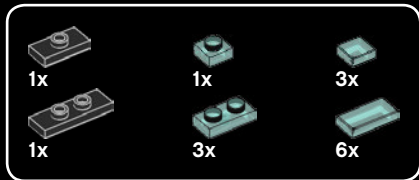

14

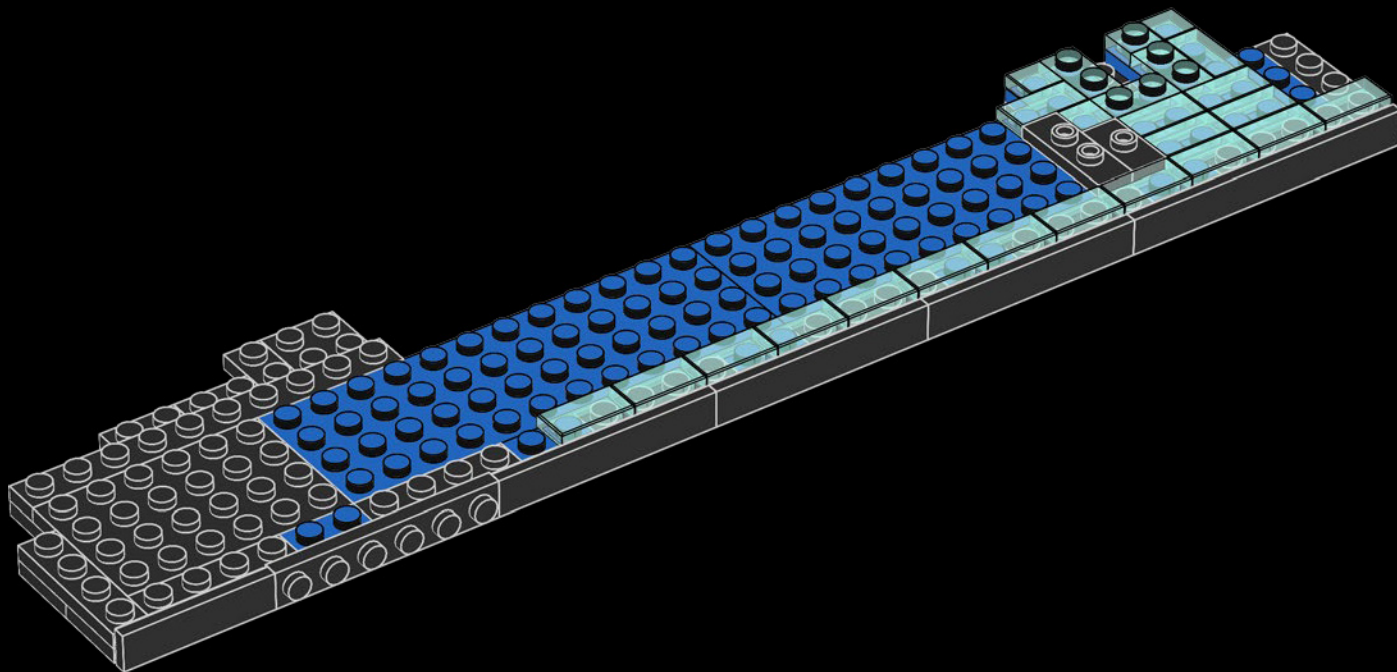



15

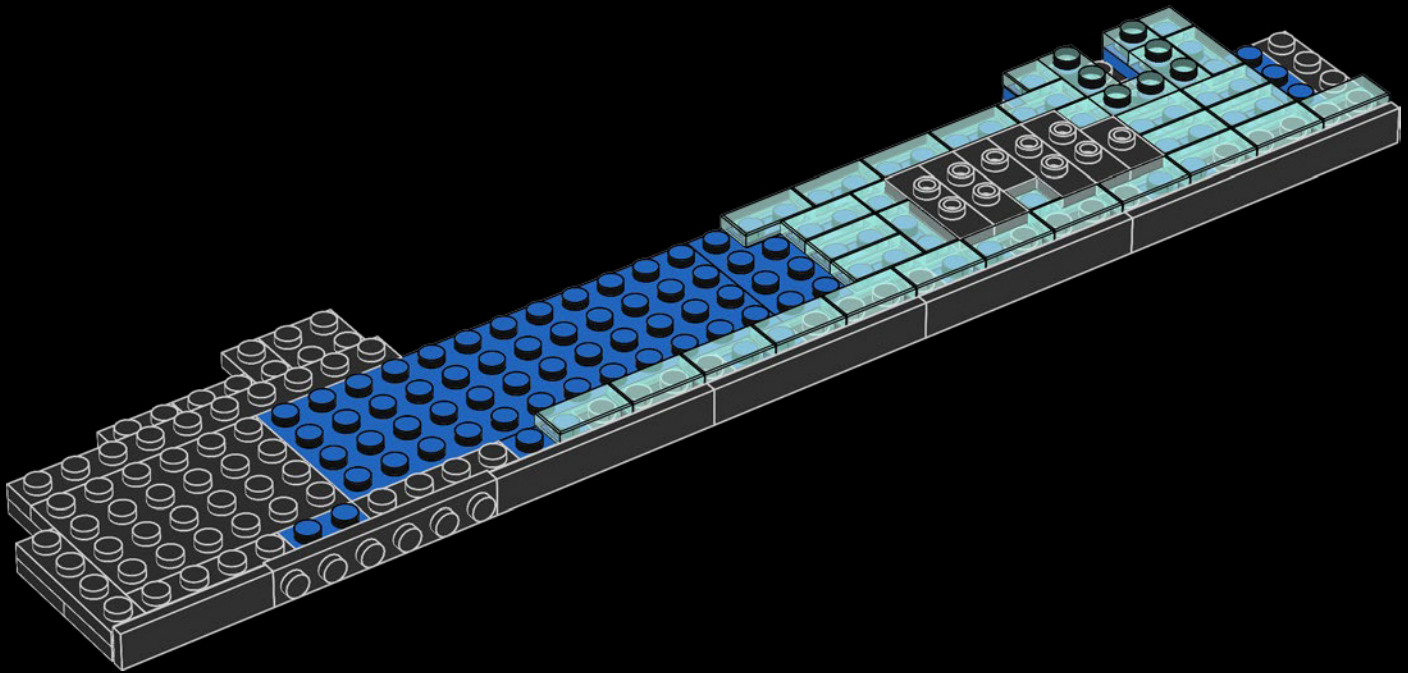

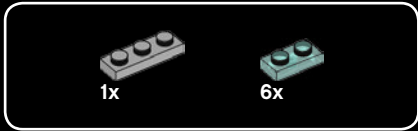

16

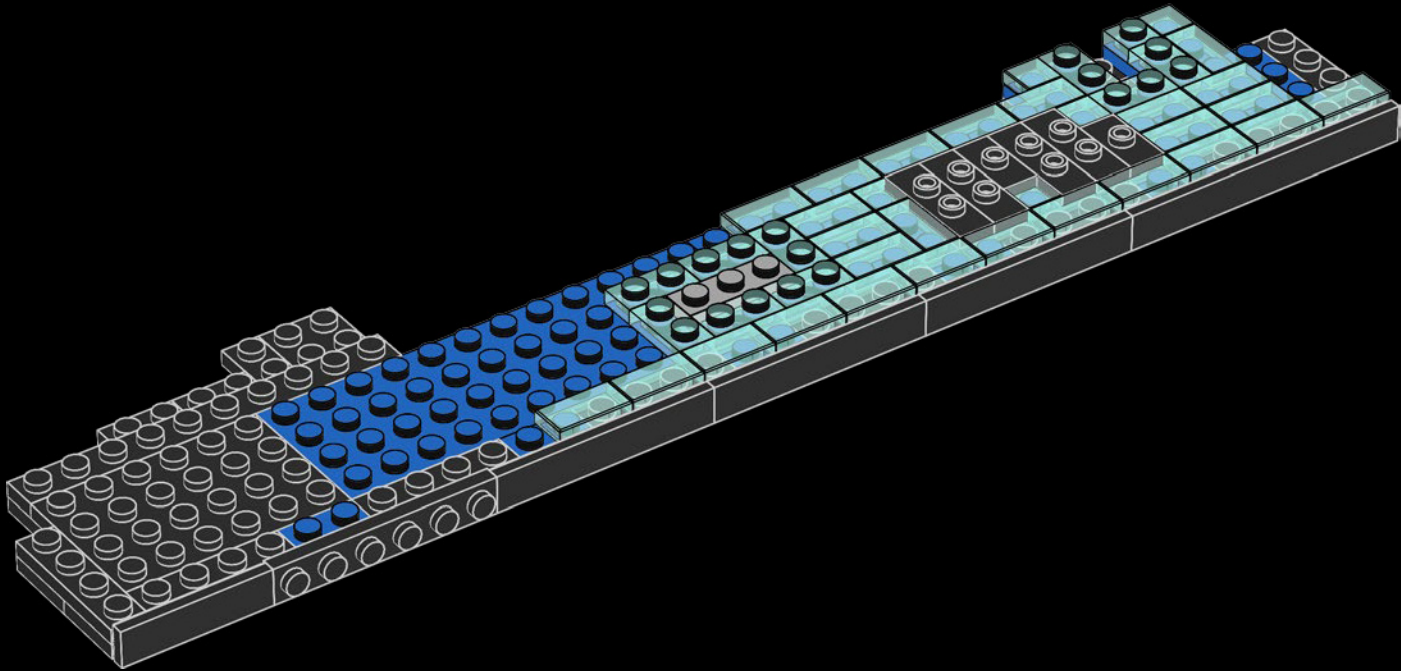



17

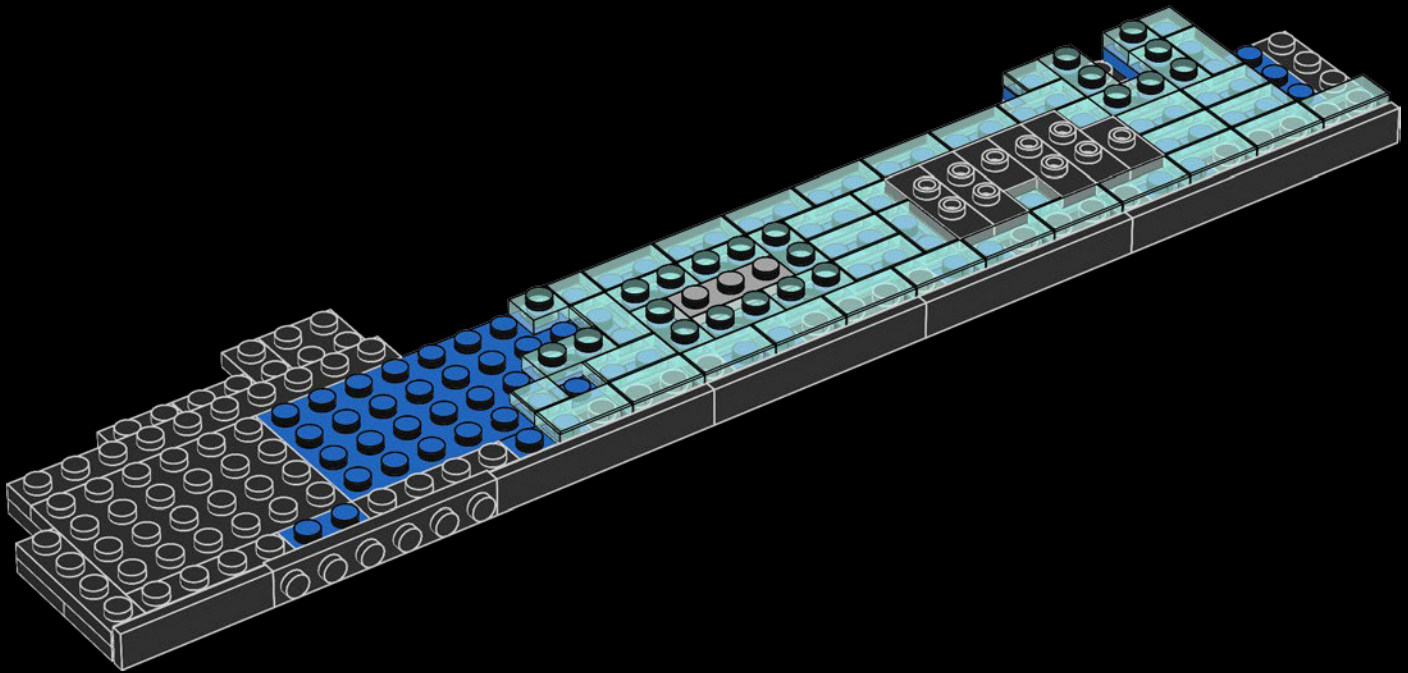

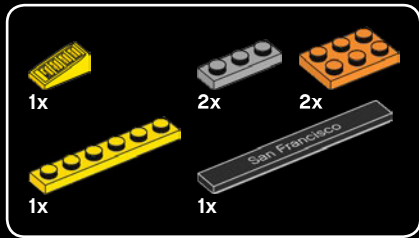

18

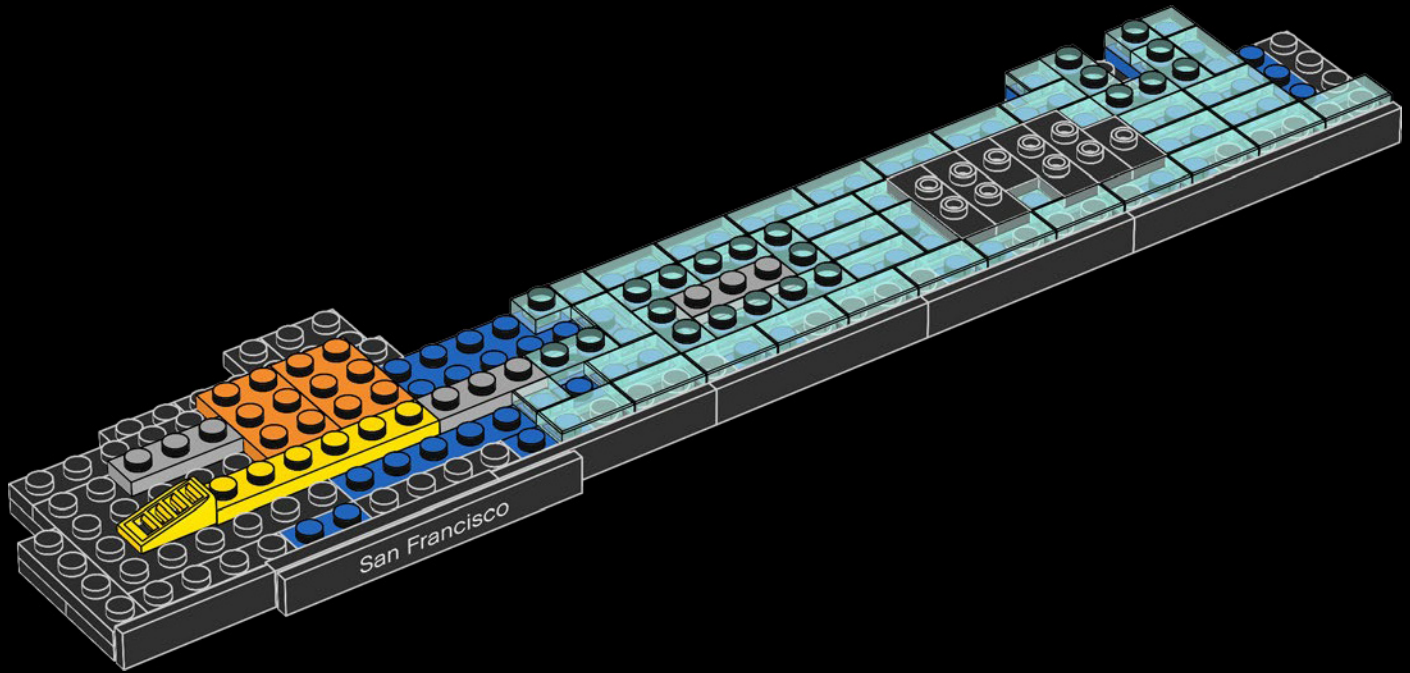

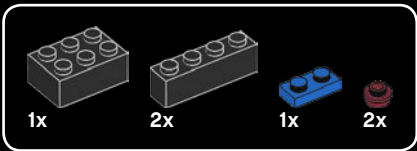

19

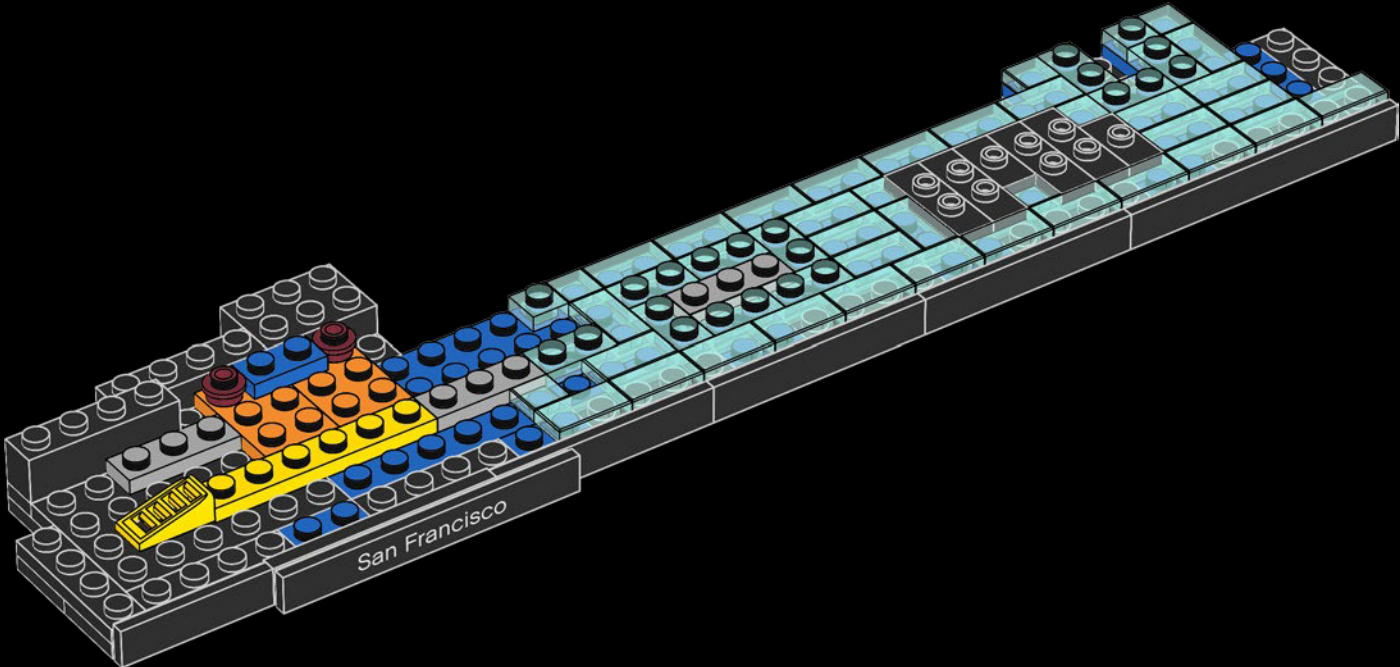

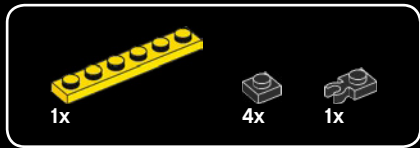

20

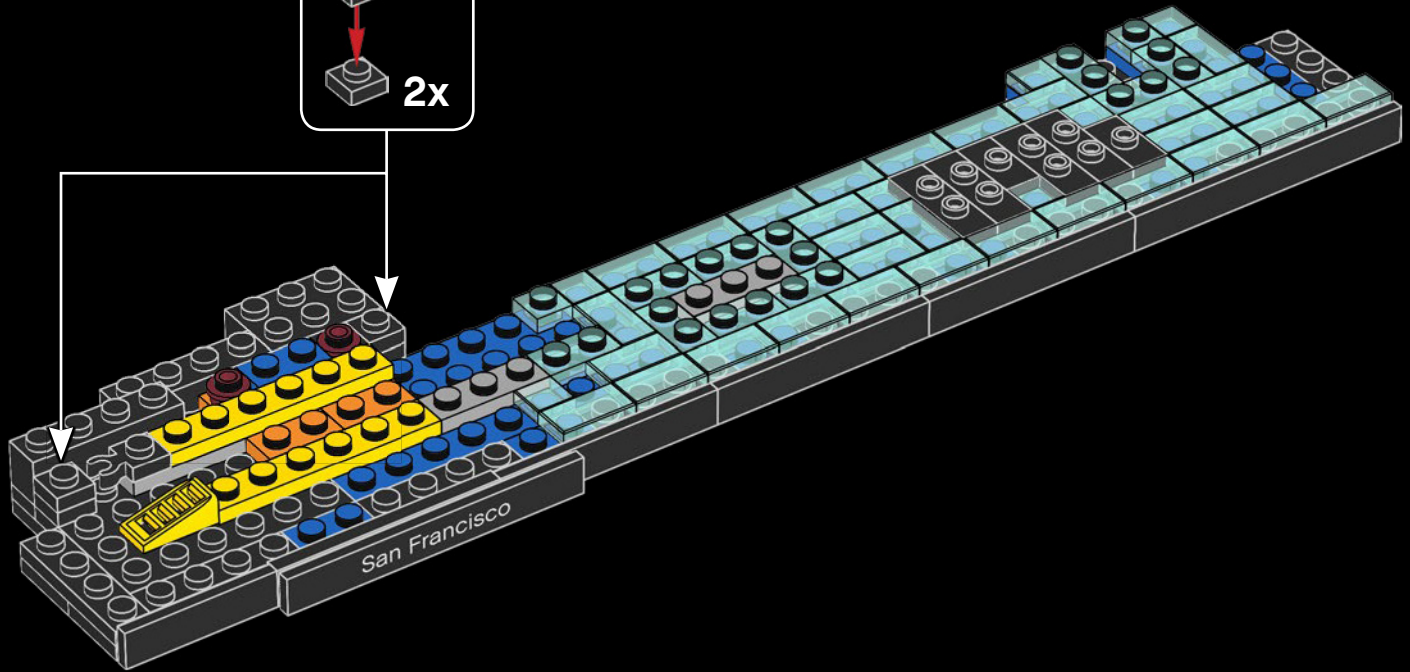
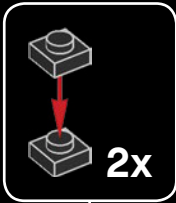

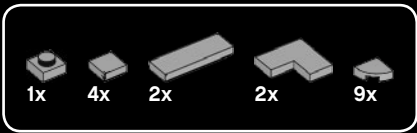

21

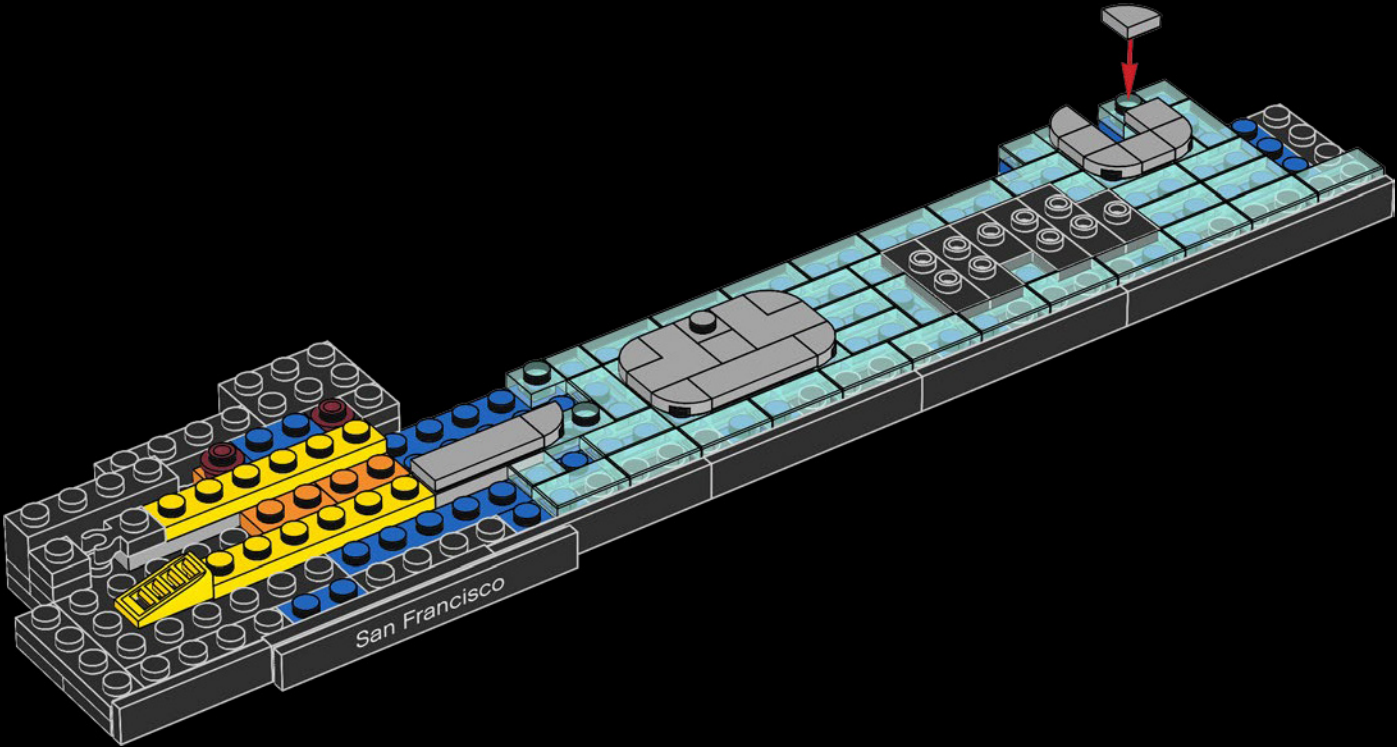

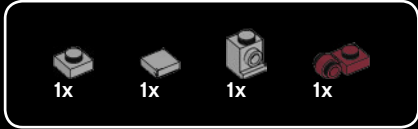

22

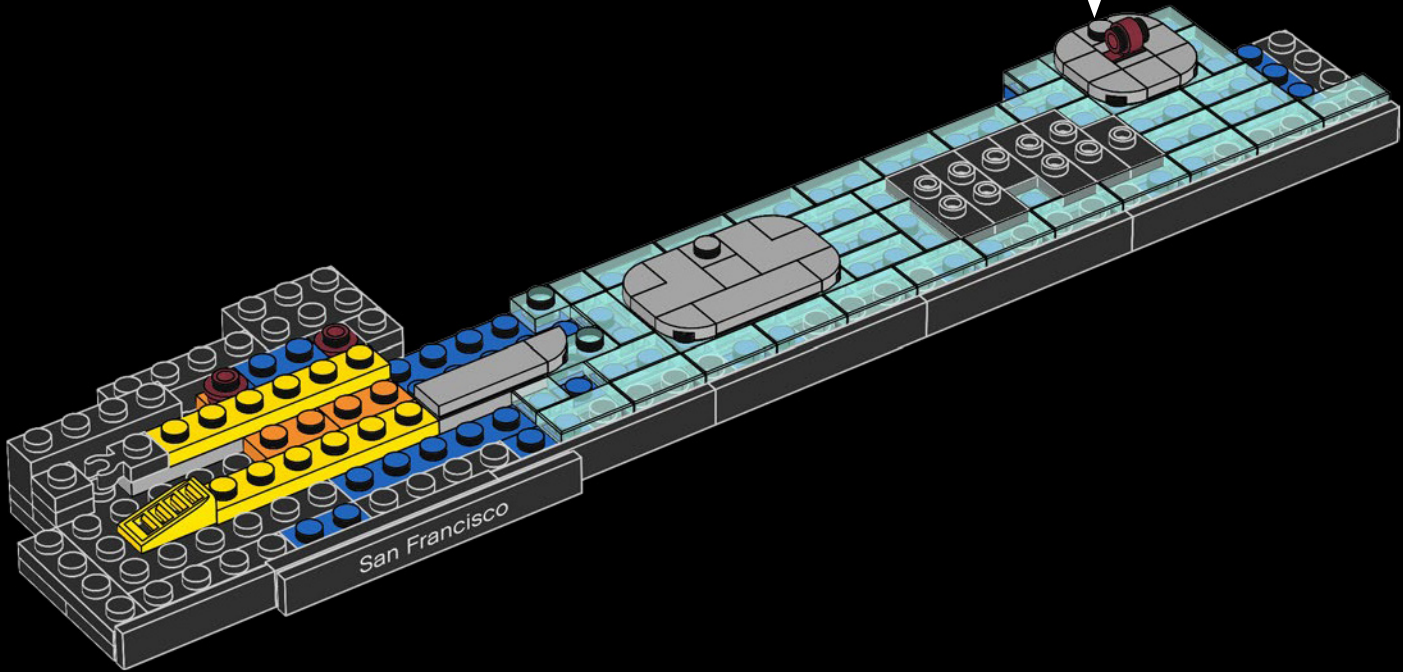
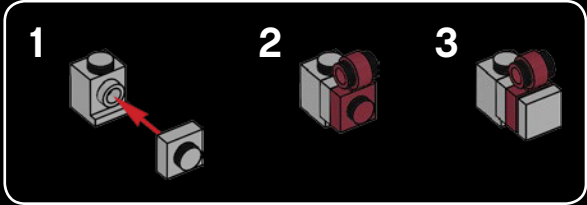

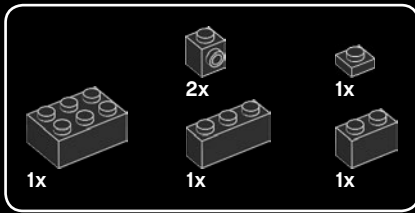

23

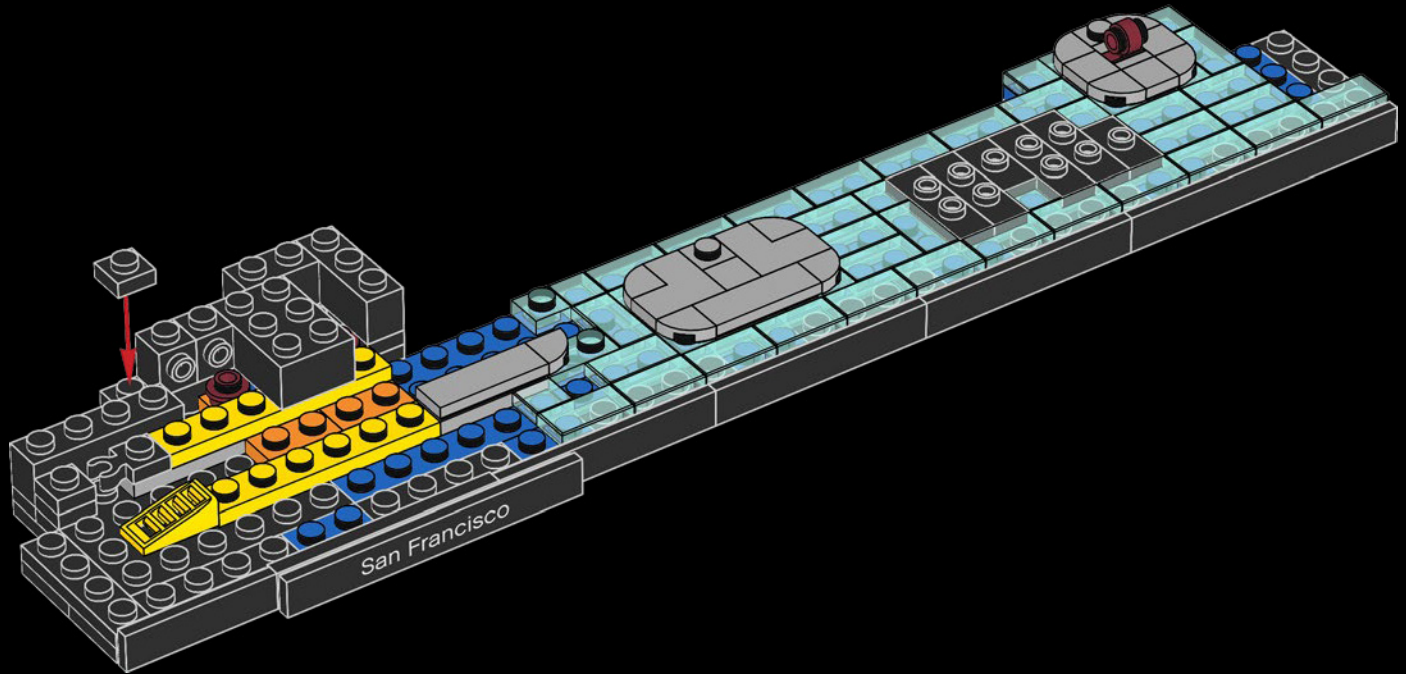

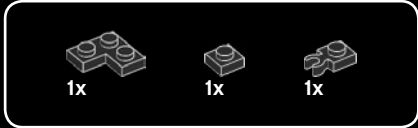

24

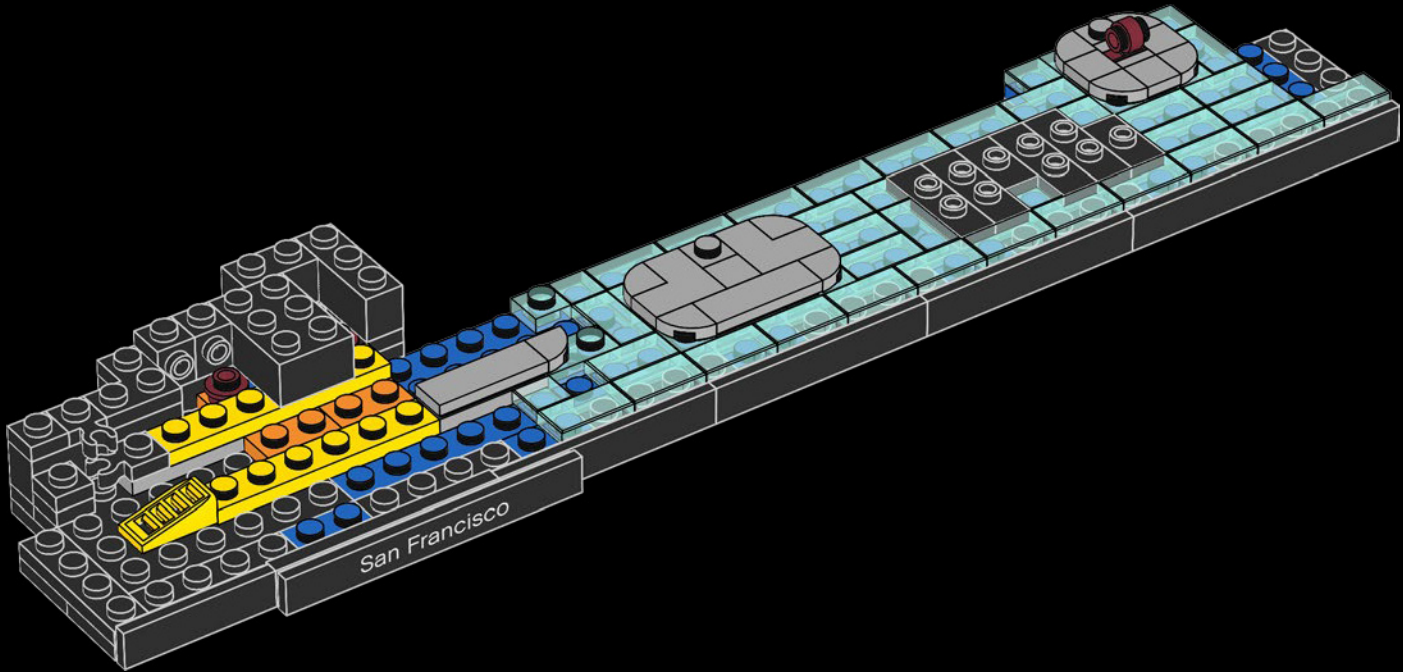

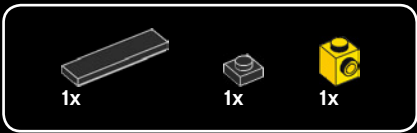

25

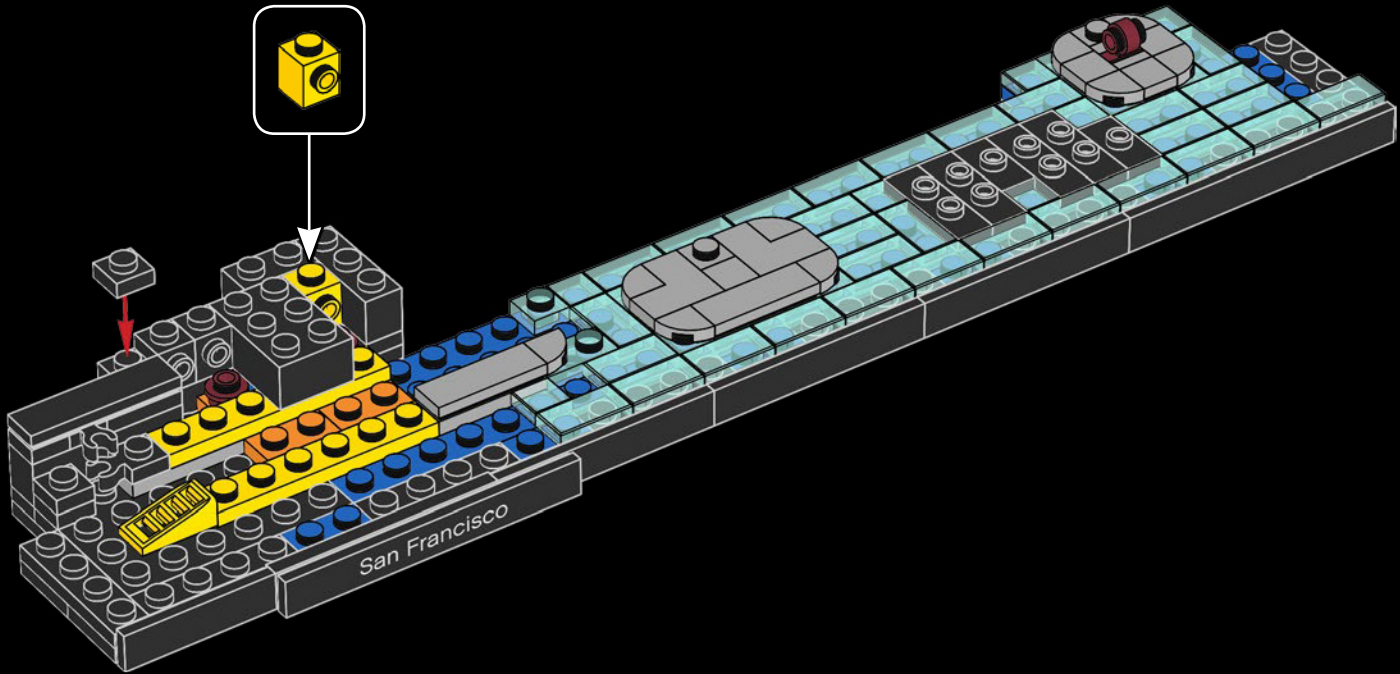

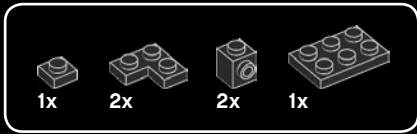

26

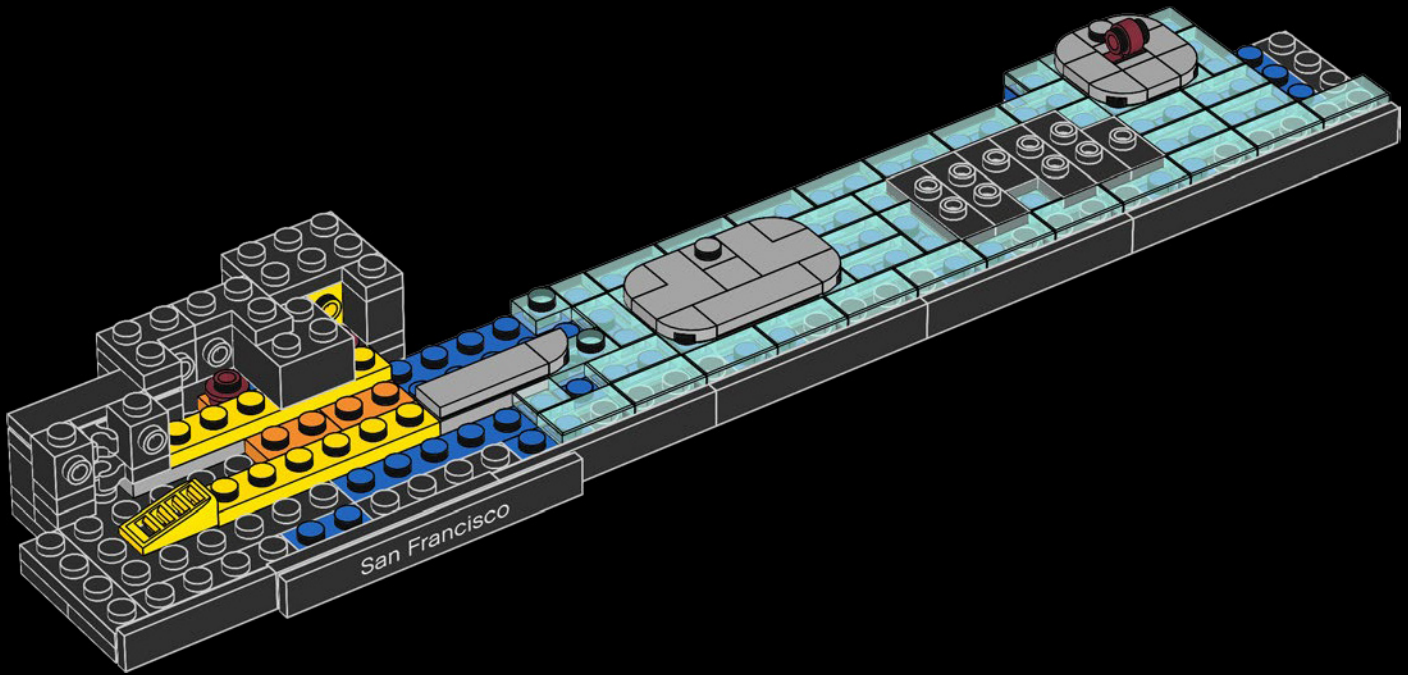

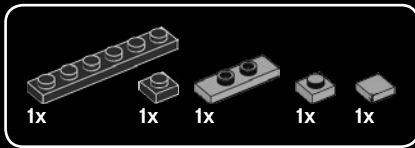

27

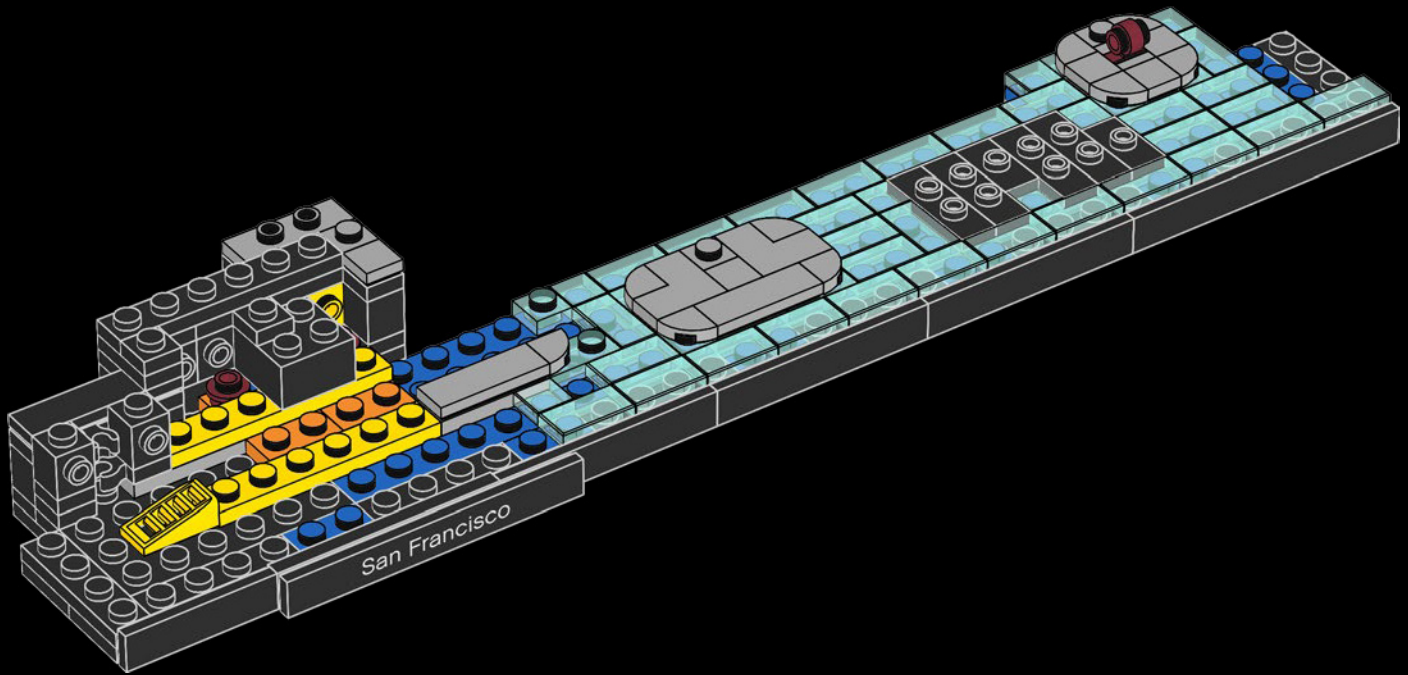

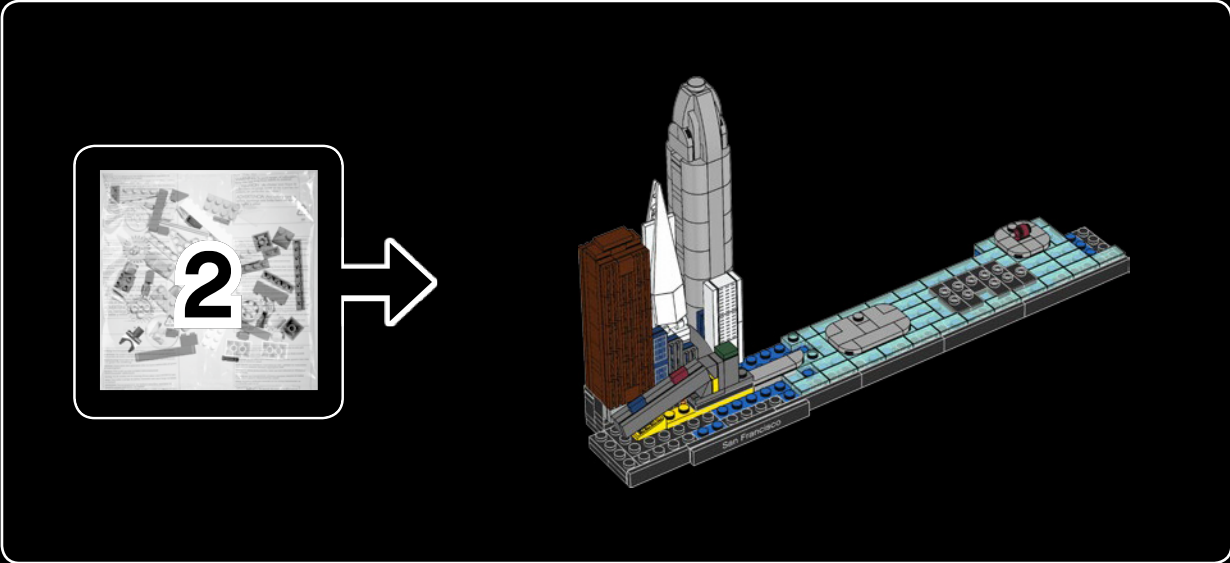

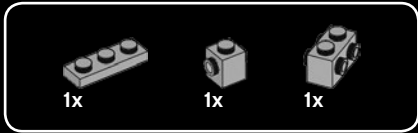

29

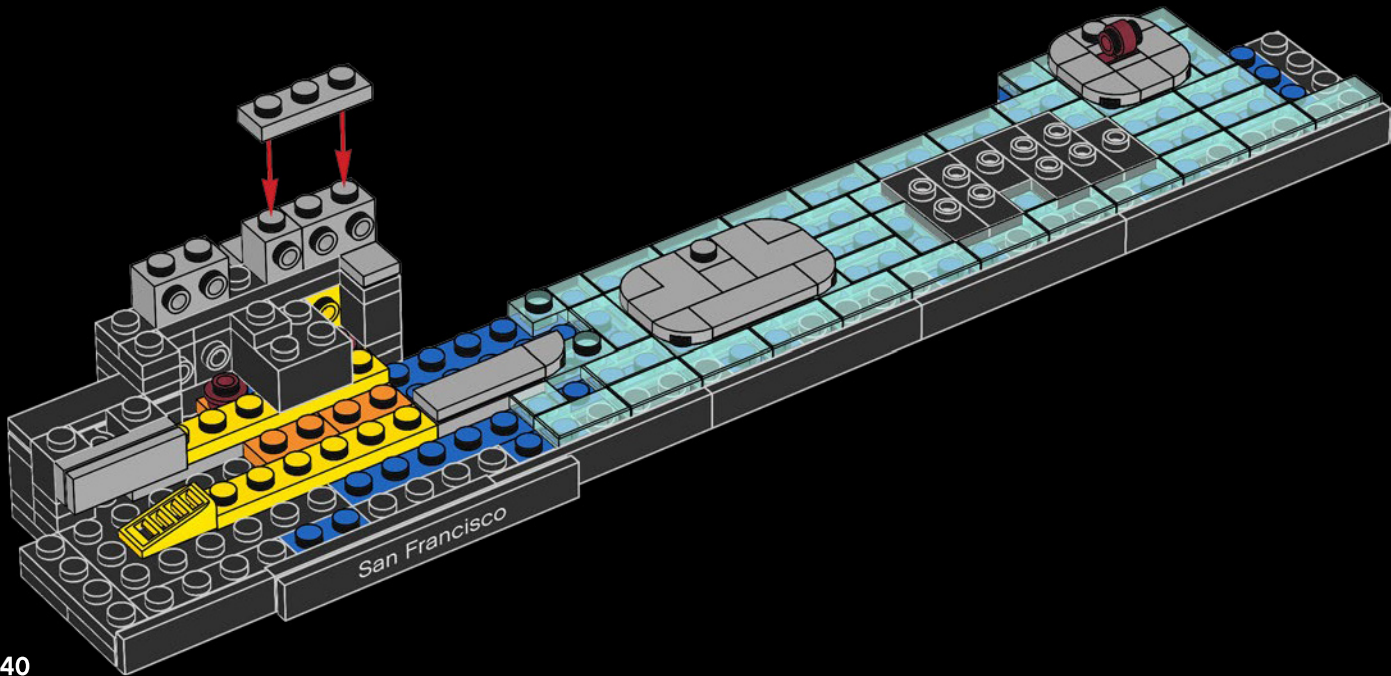



30

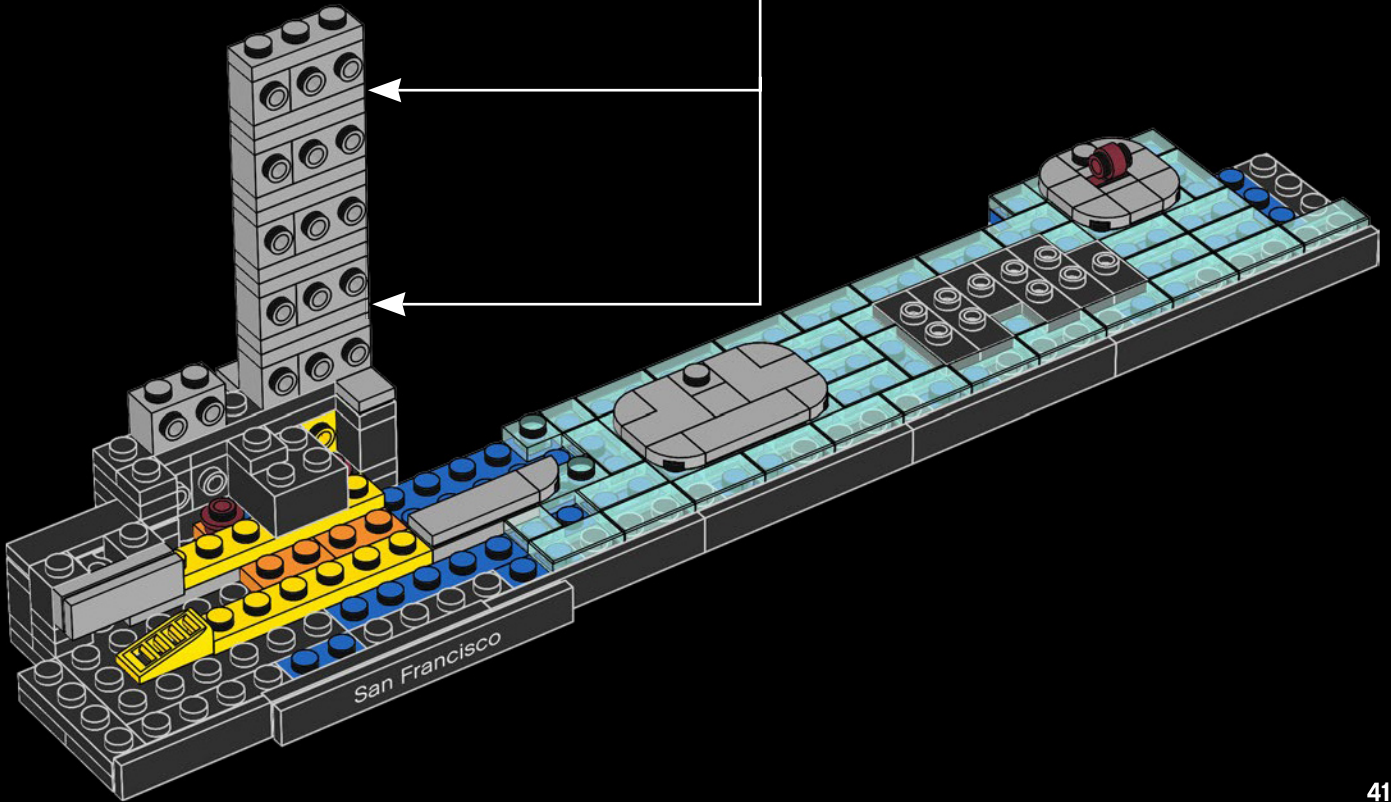
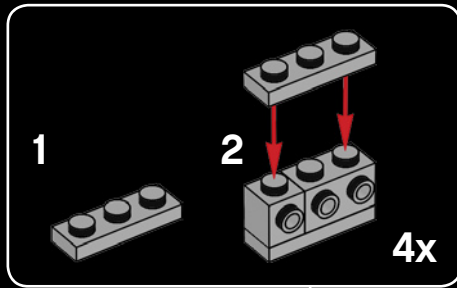

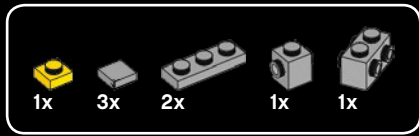

31

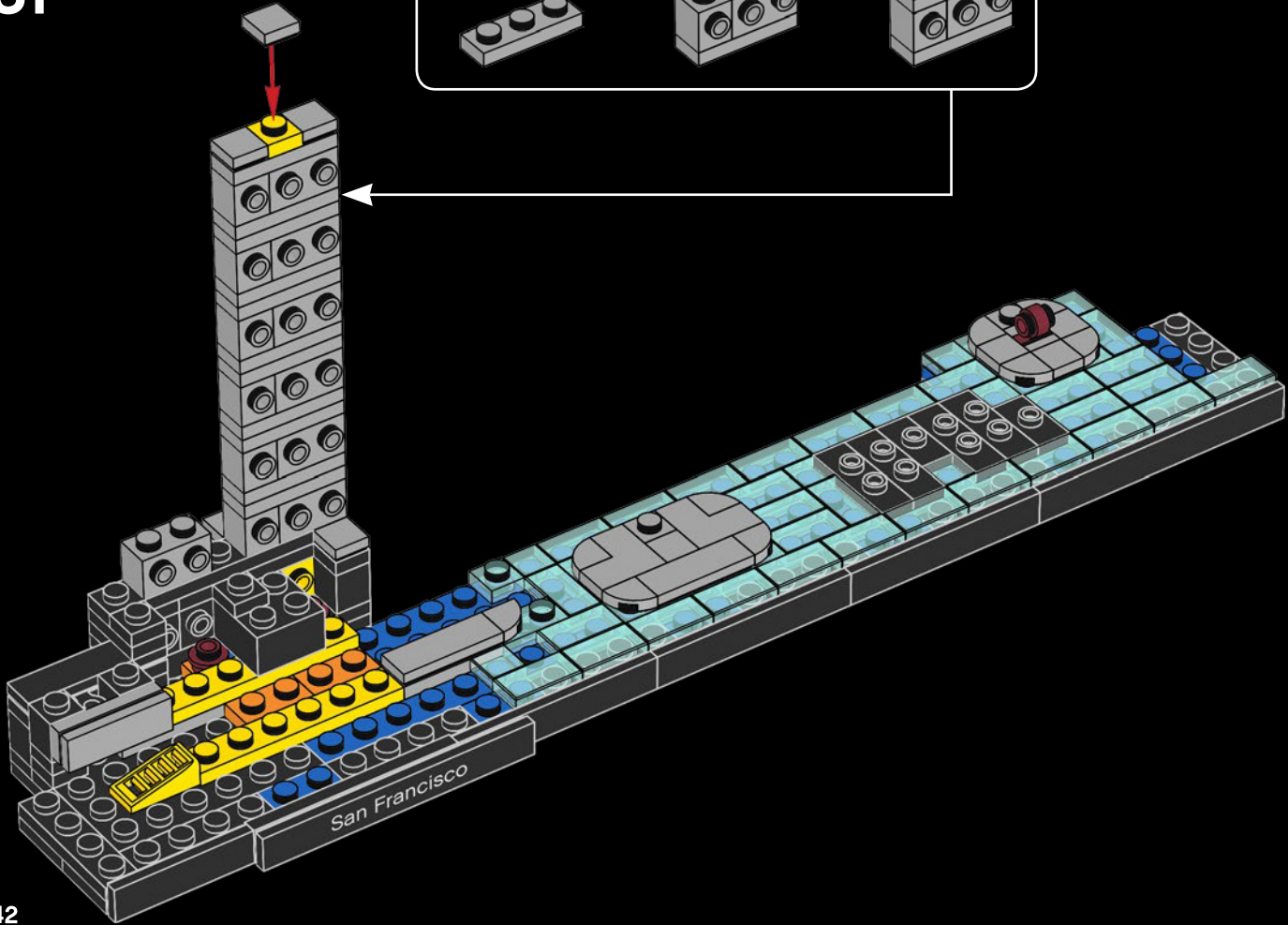
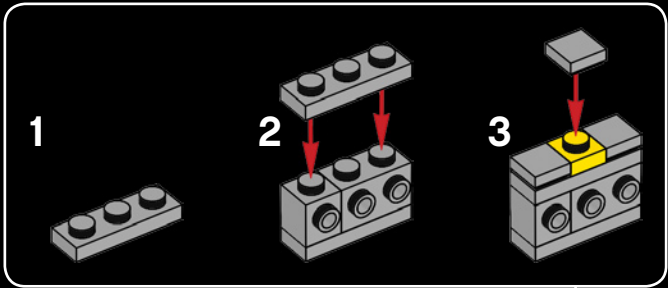

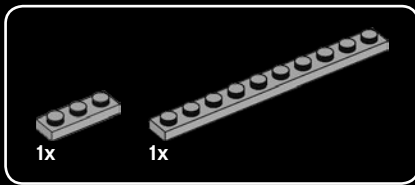

32

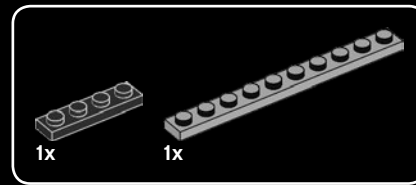
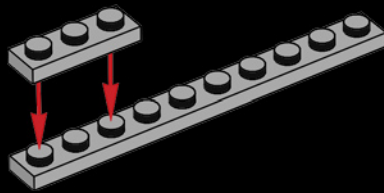

33

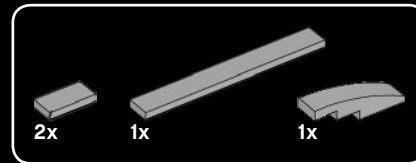
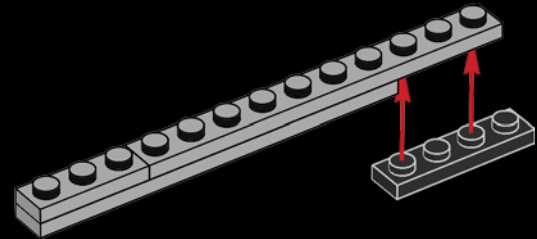

34

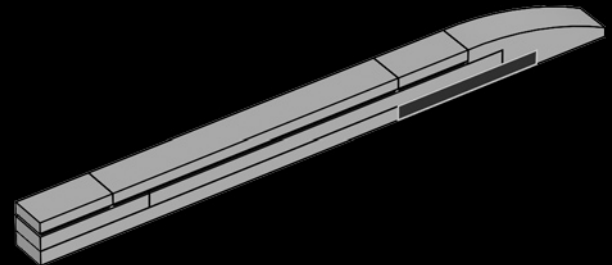

35

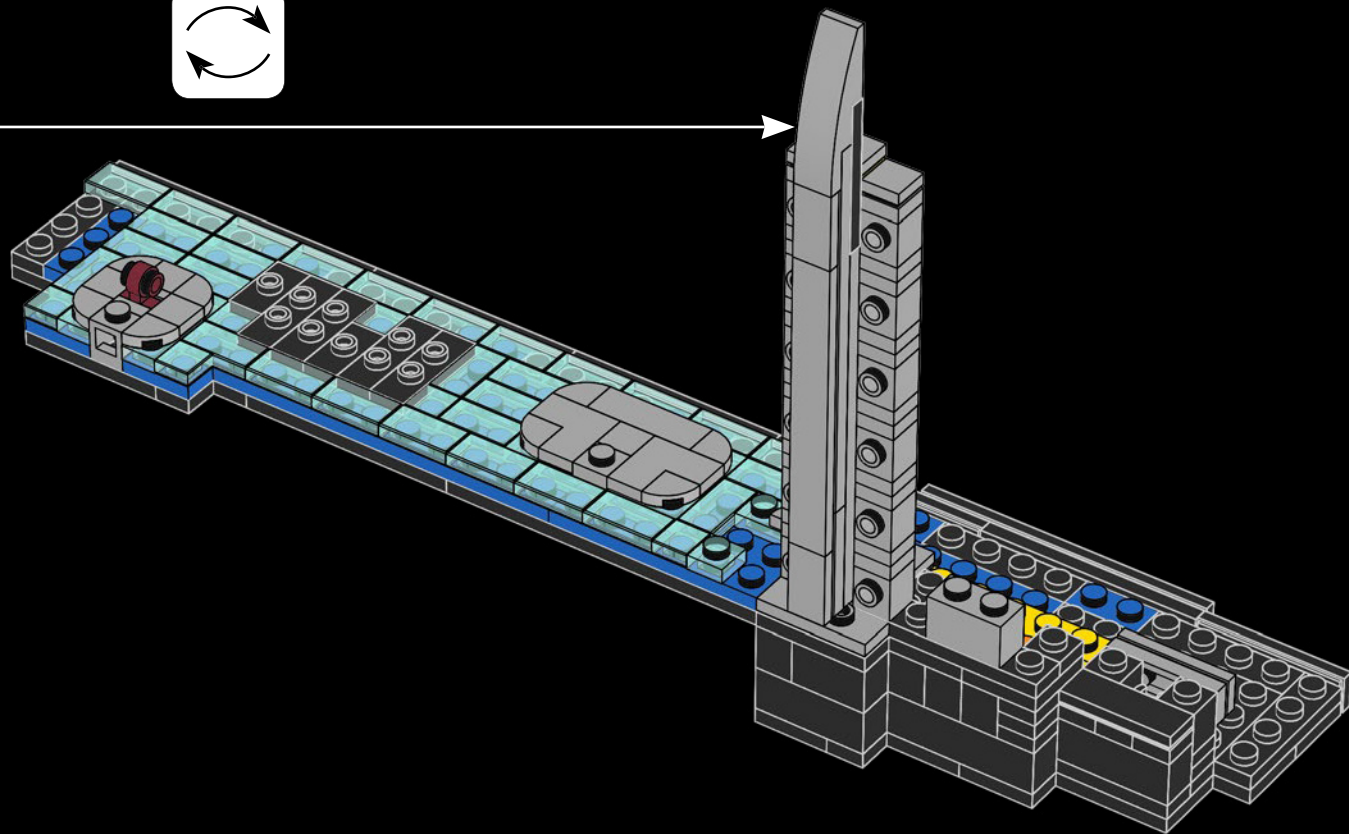

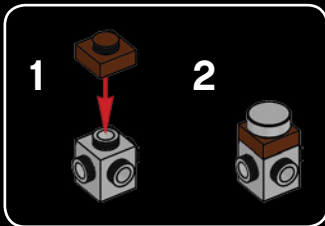

37

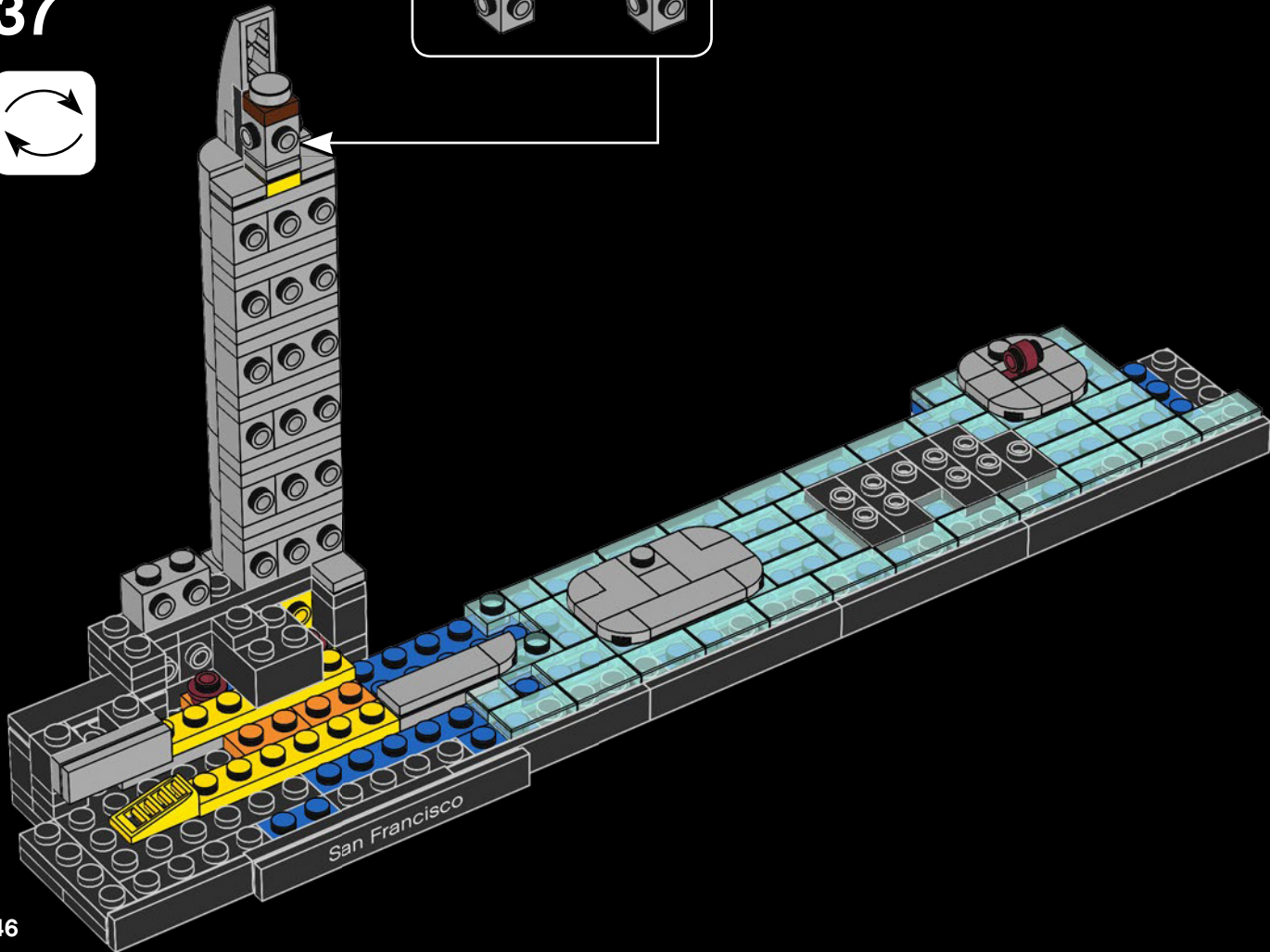



38

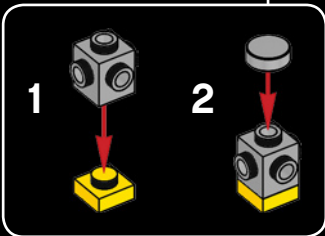
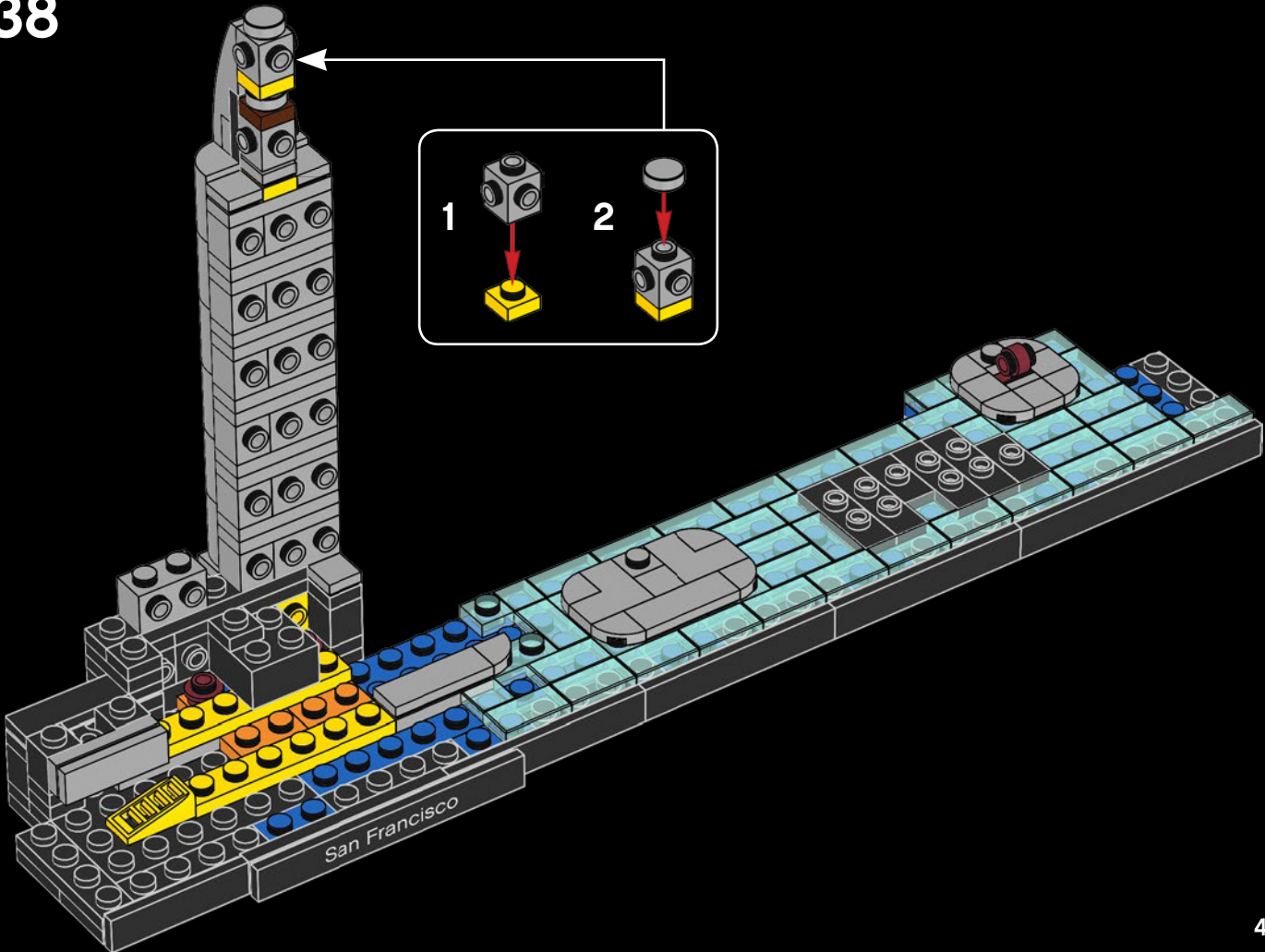

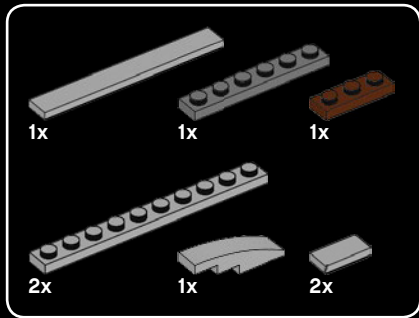

39

1

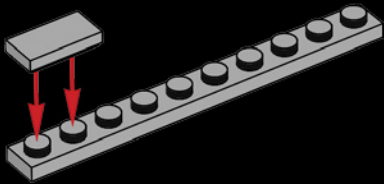

2

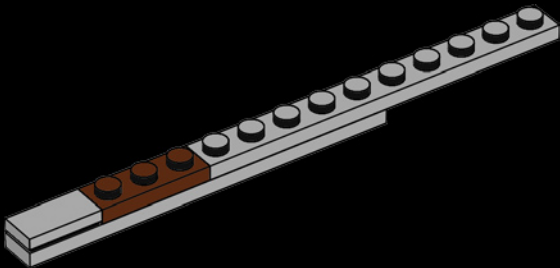

3

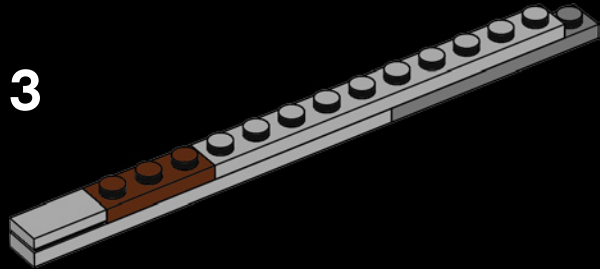

4

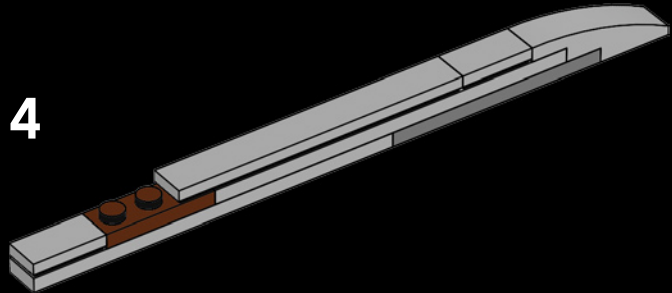

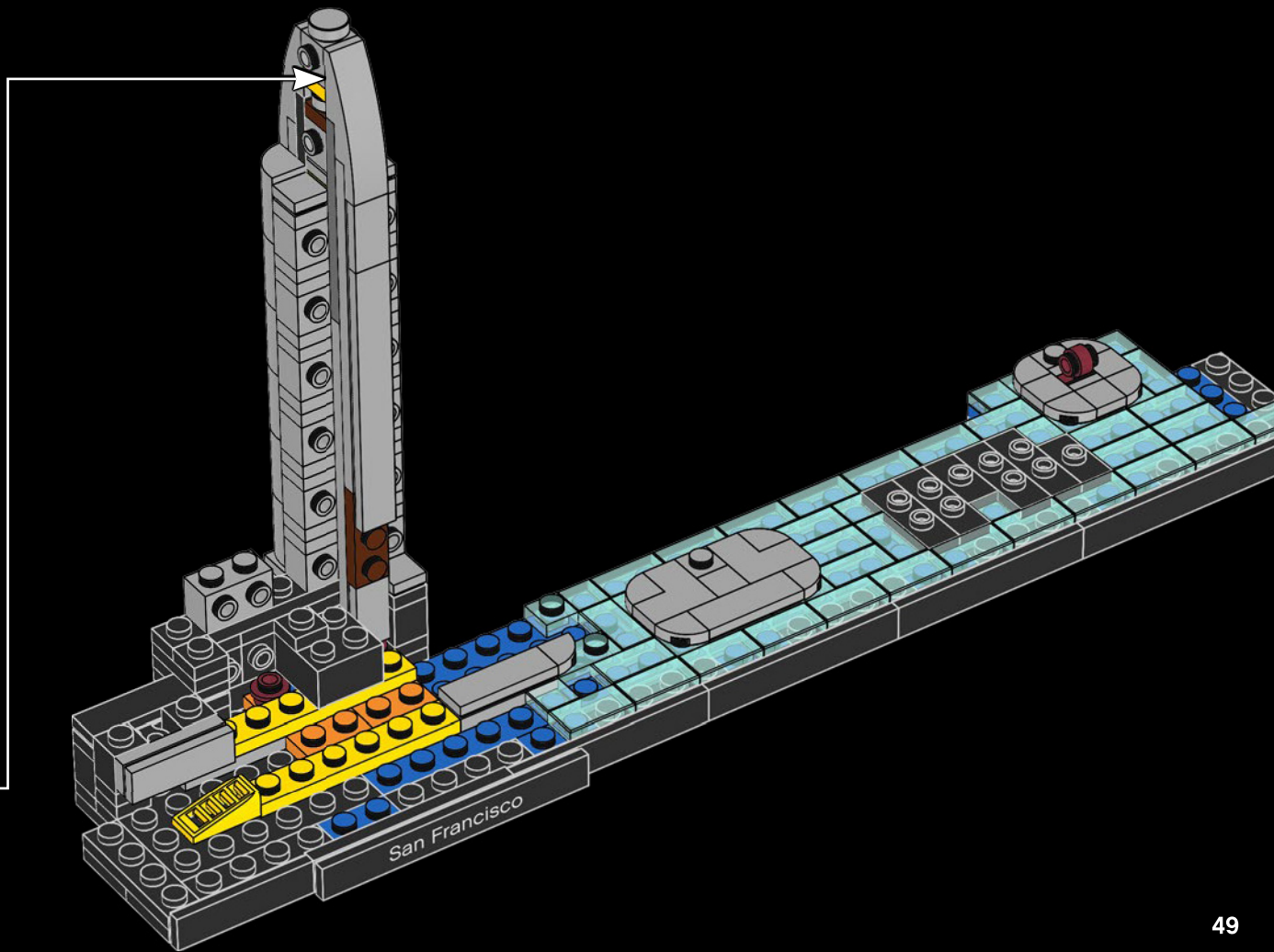

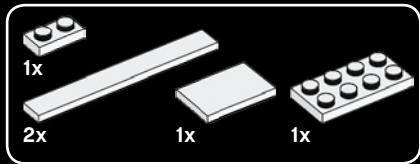

40

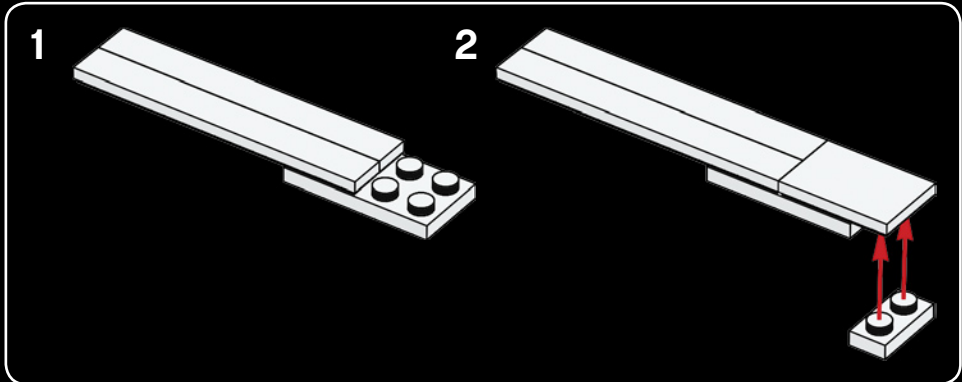
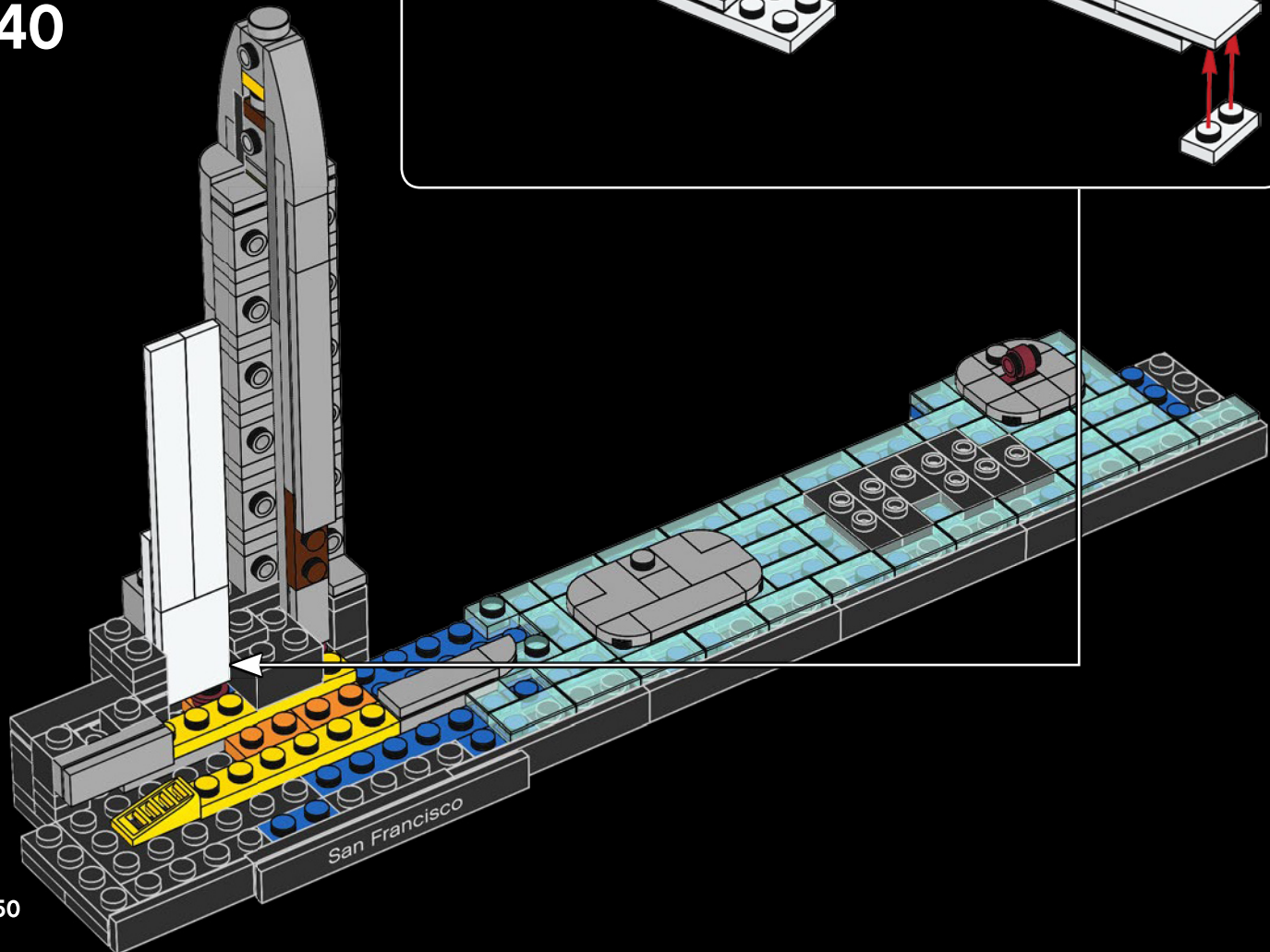

50



2x



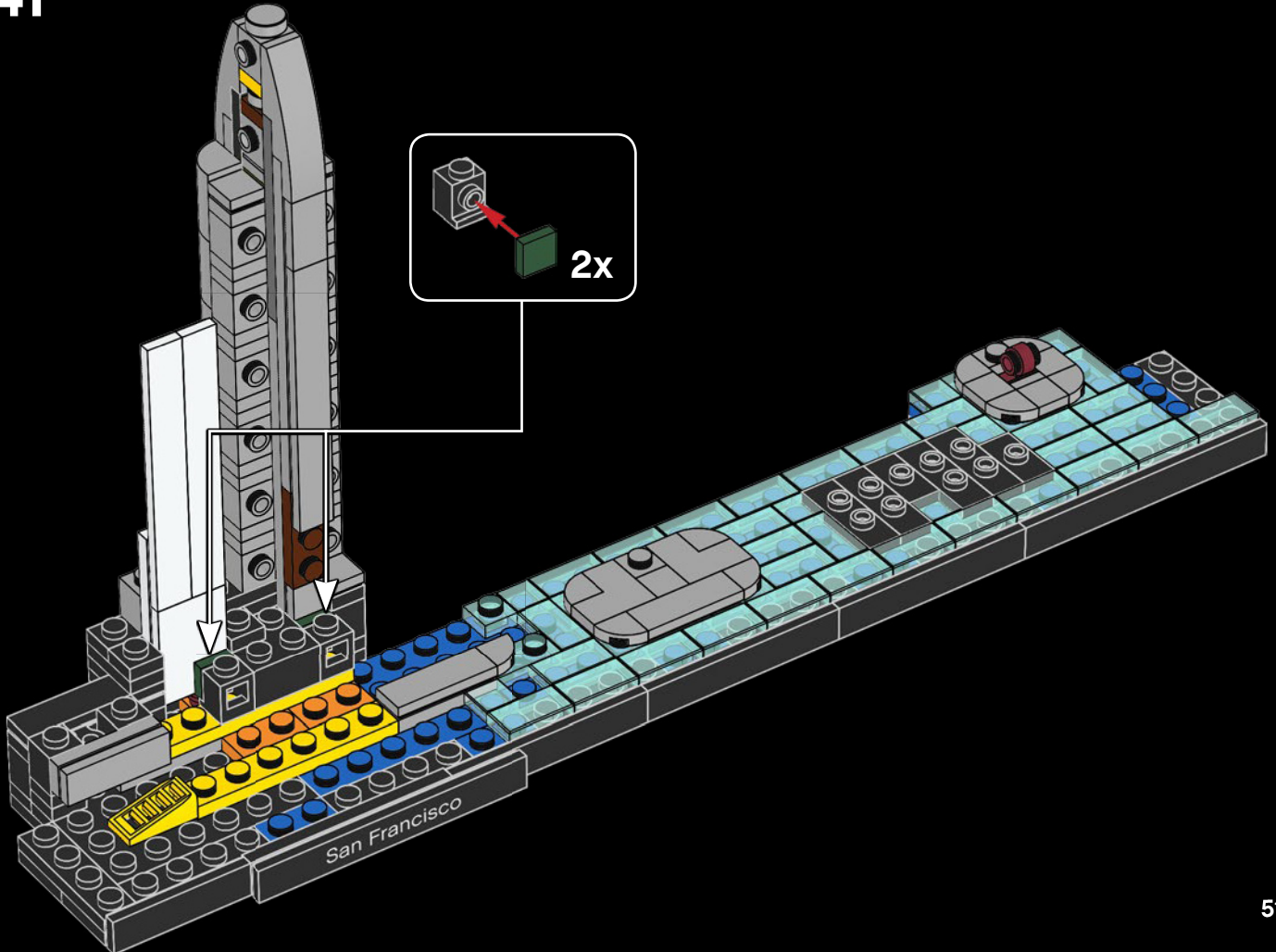

2x

41



2x

San Francisco

2x  2x 

42

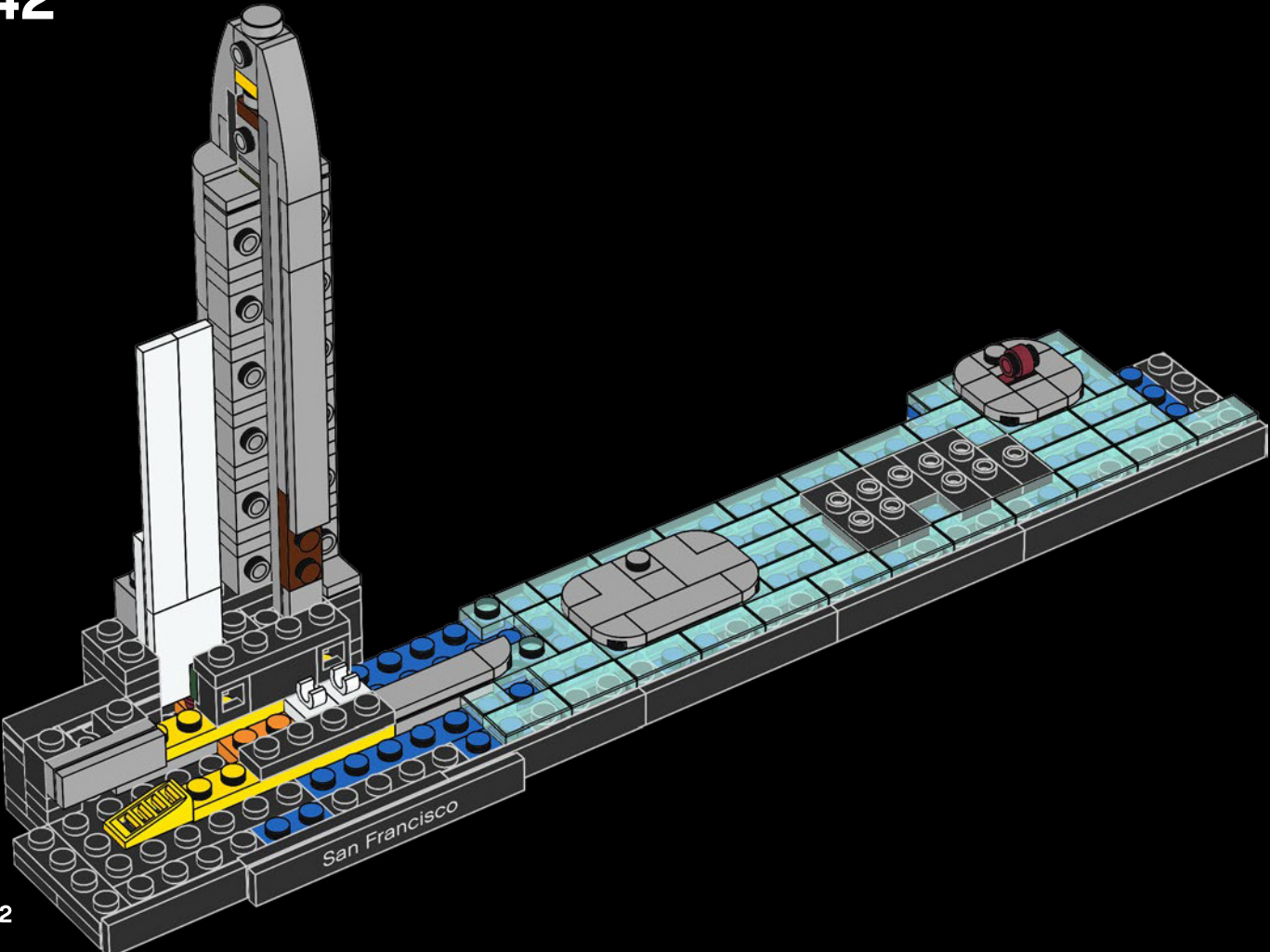

52

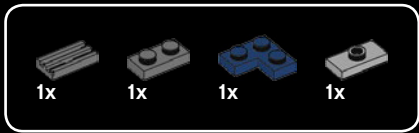

43

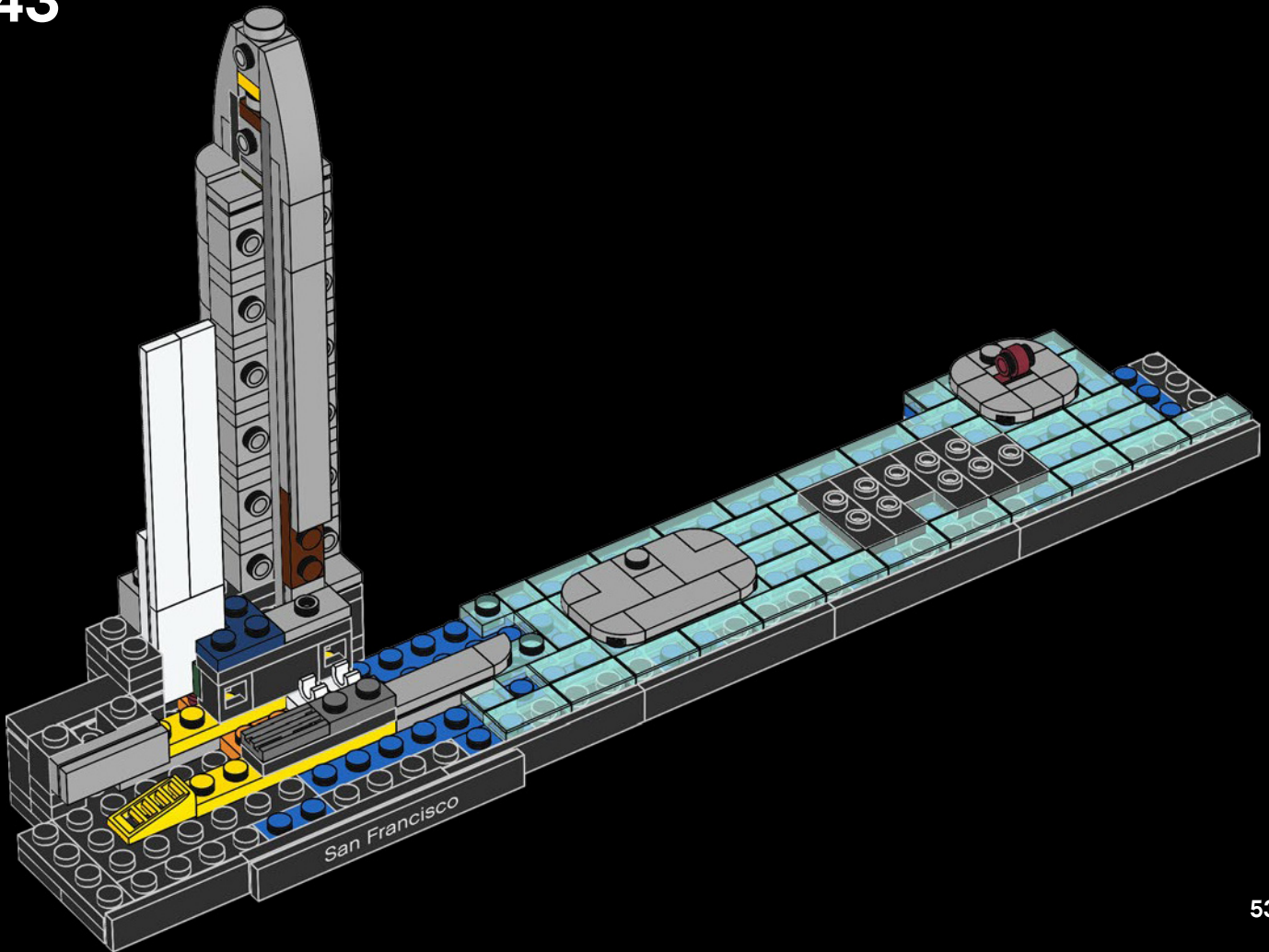

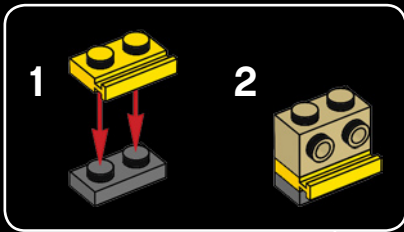

44

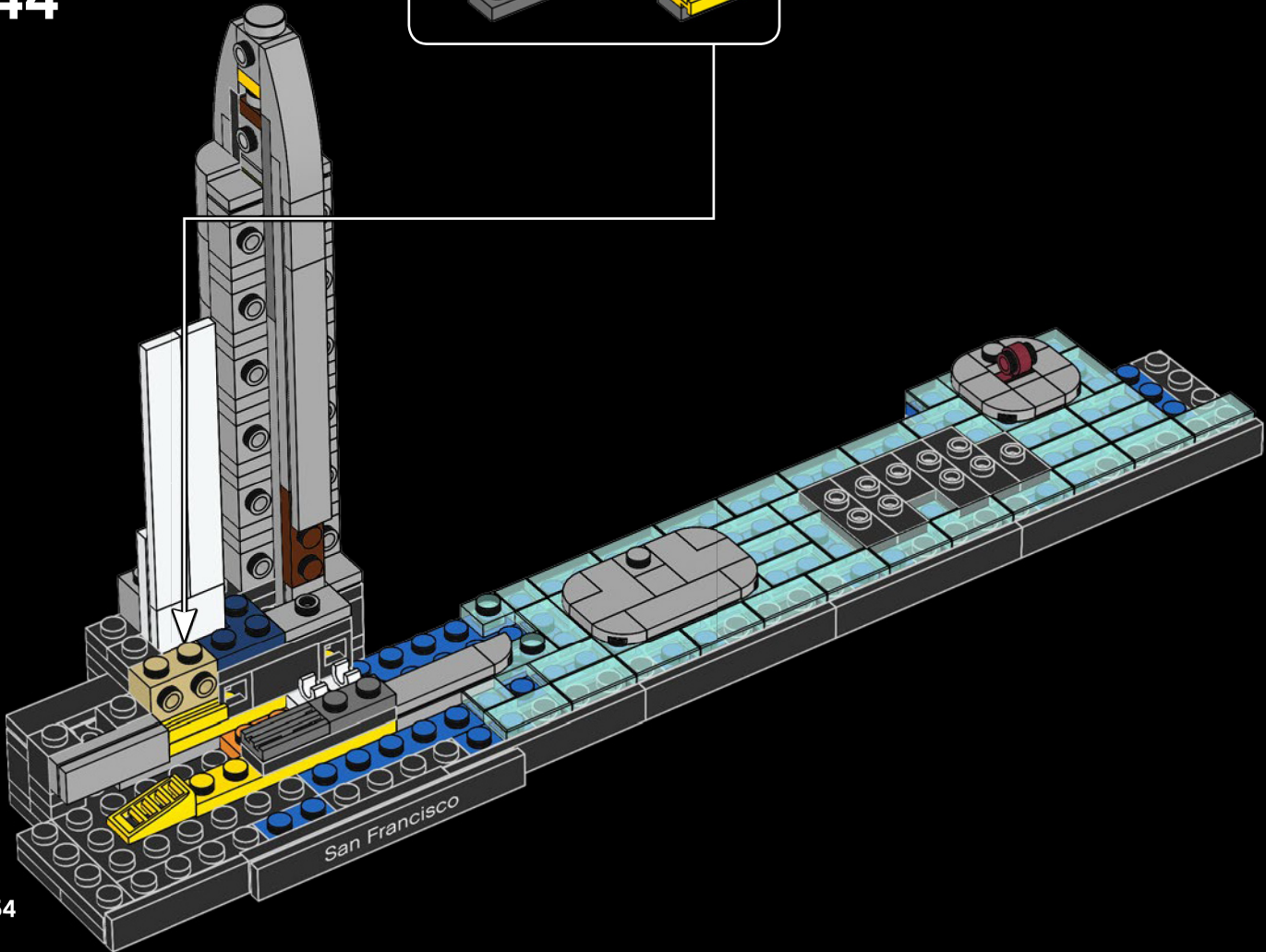

54

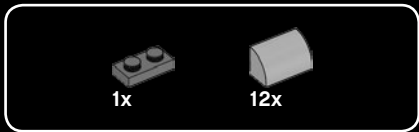

45

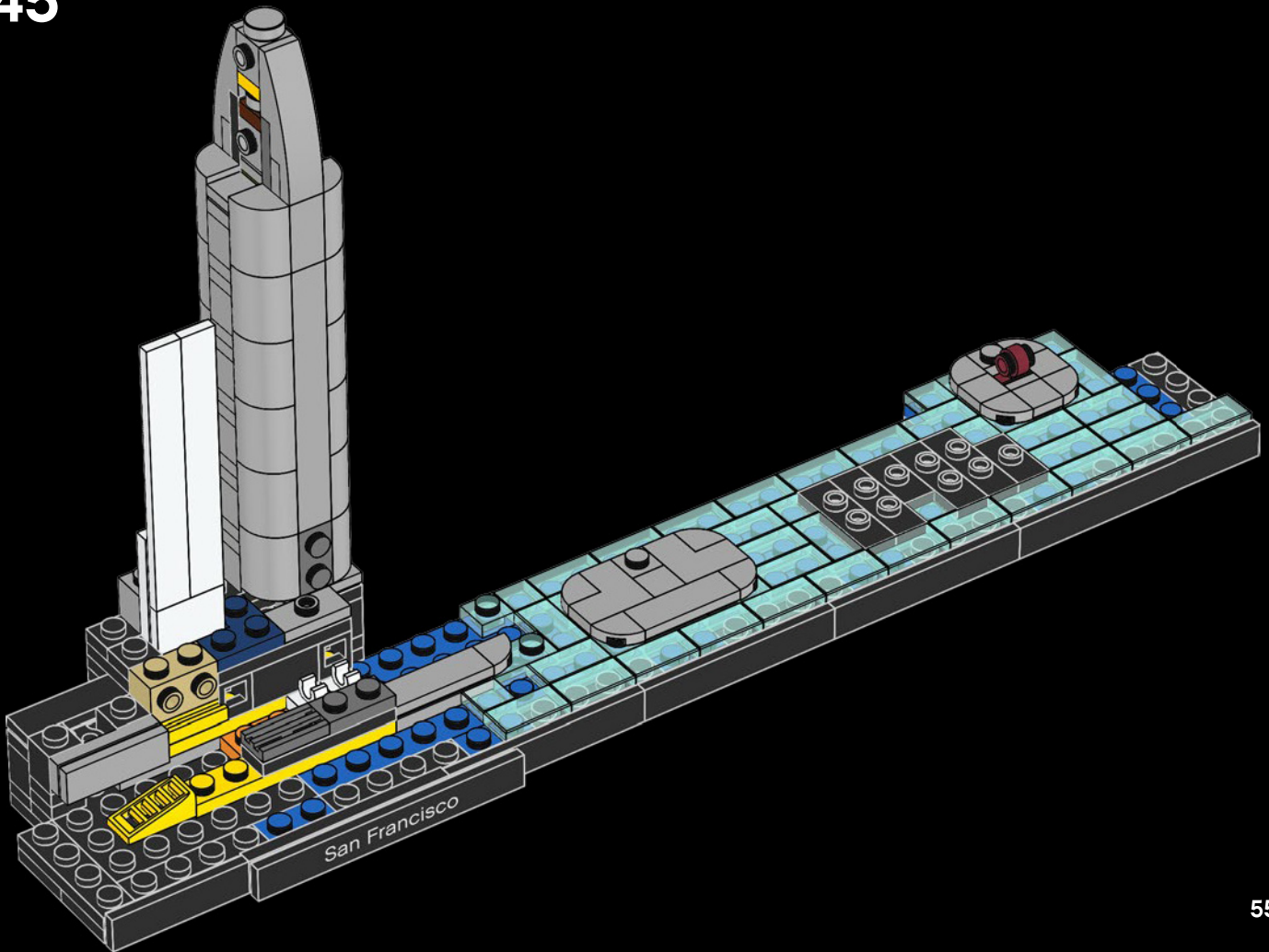

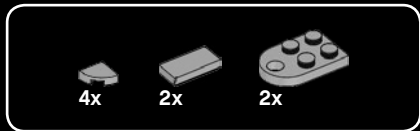

46

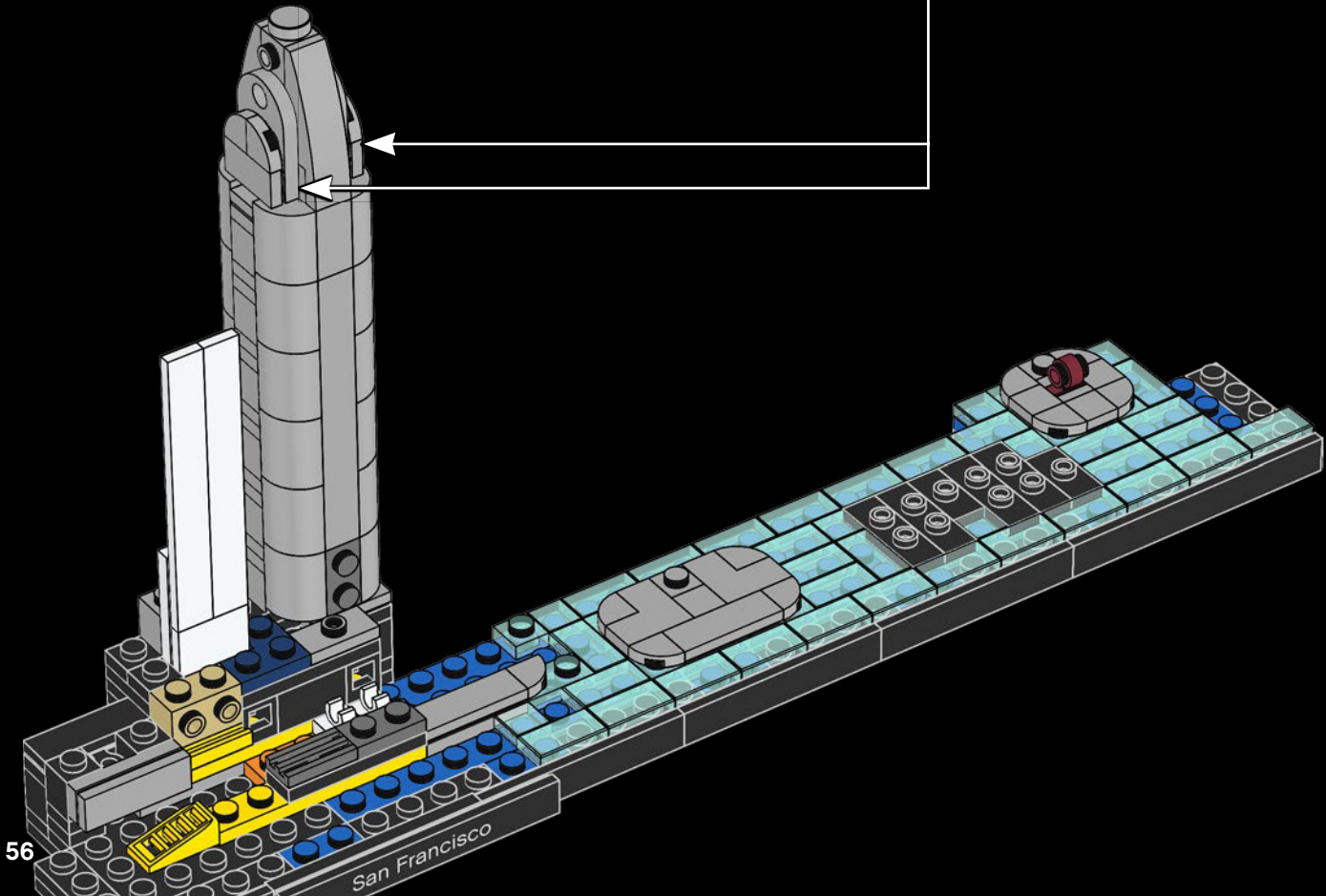
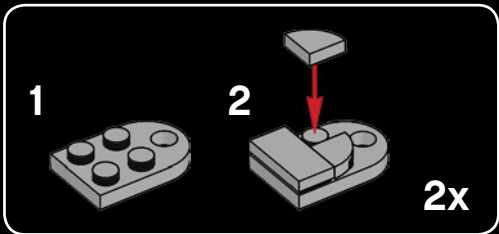



47

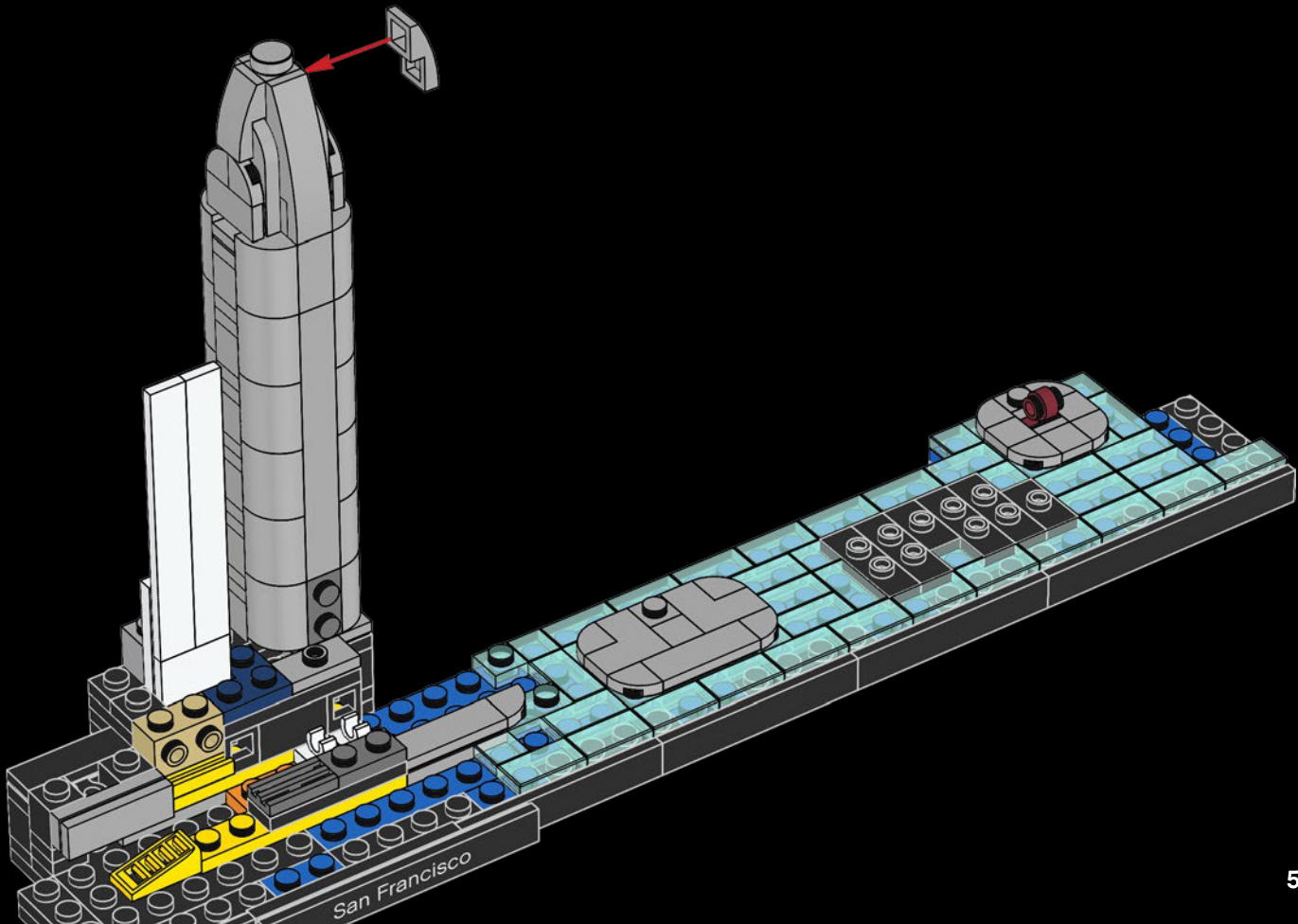

Top Art

The building's crown will feature a nine-story electronic art piece based on abstract videos filmed each day in the city.



1x	1x	2x	1x

48

1	2

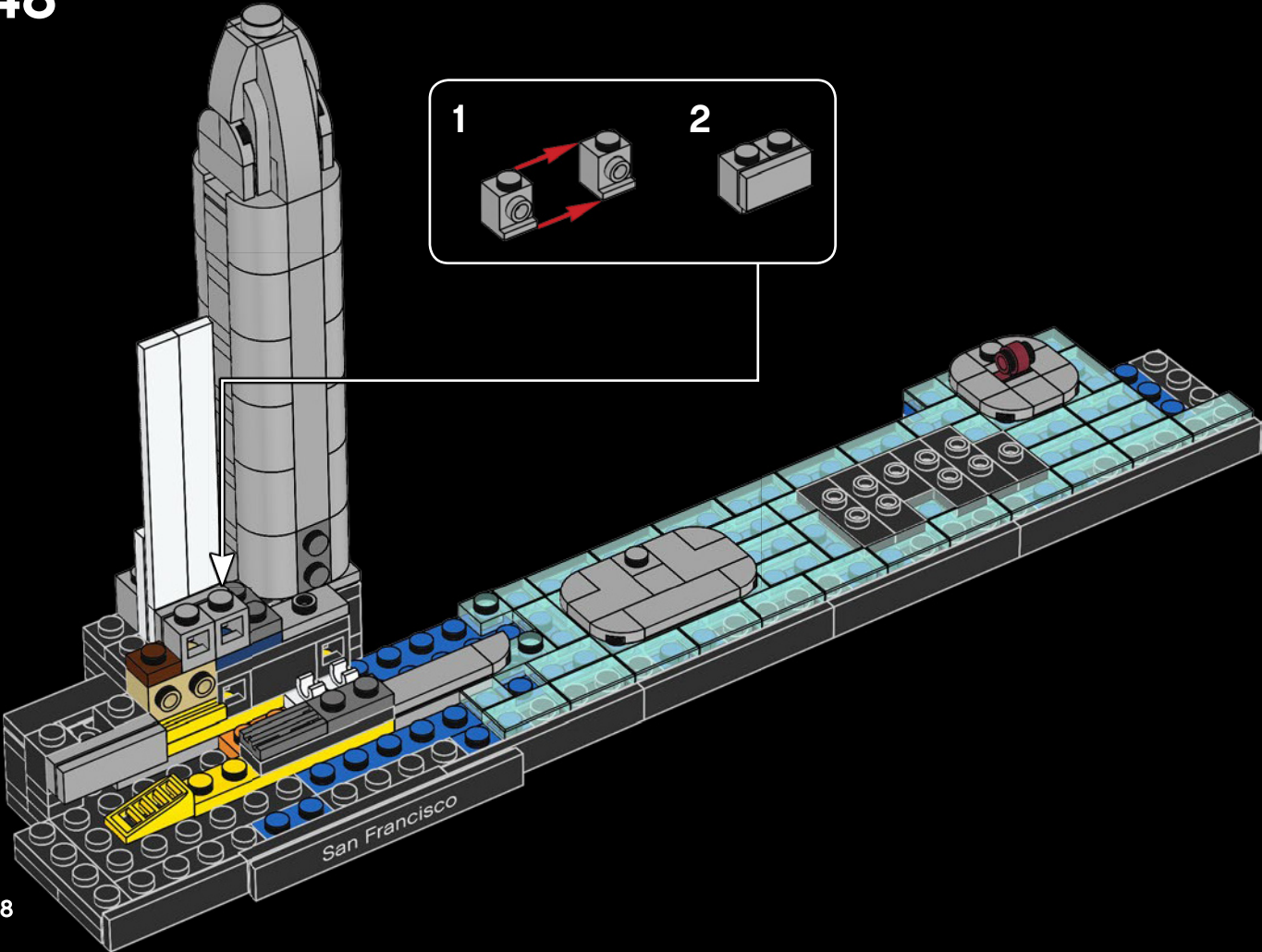

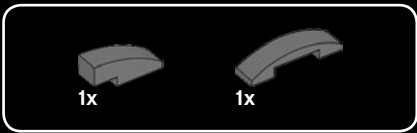

49

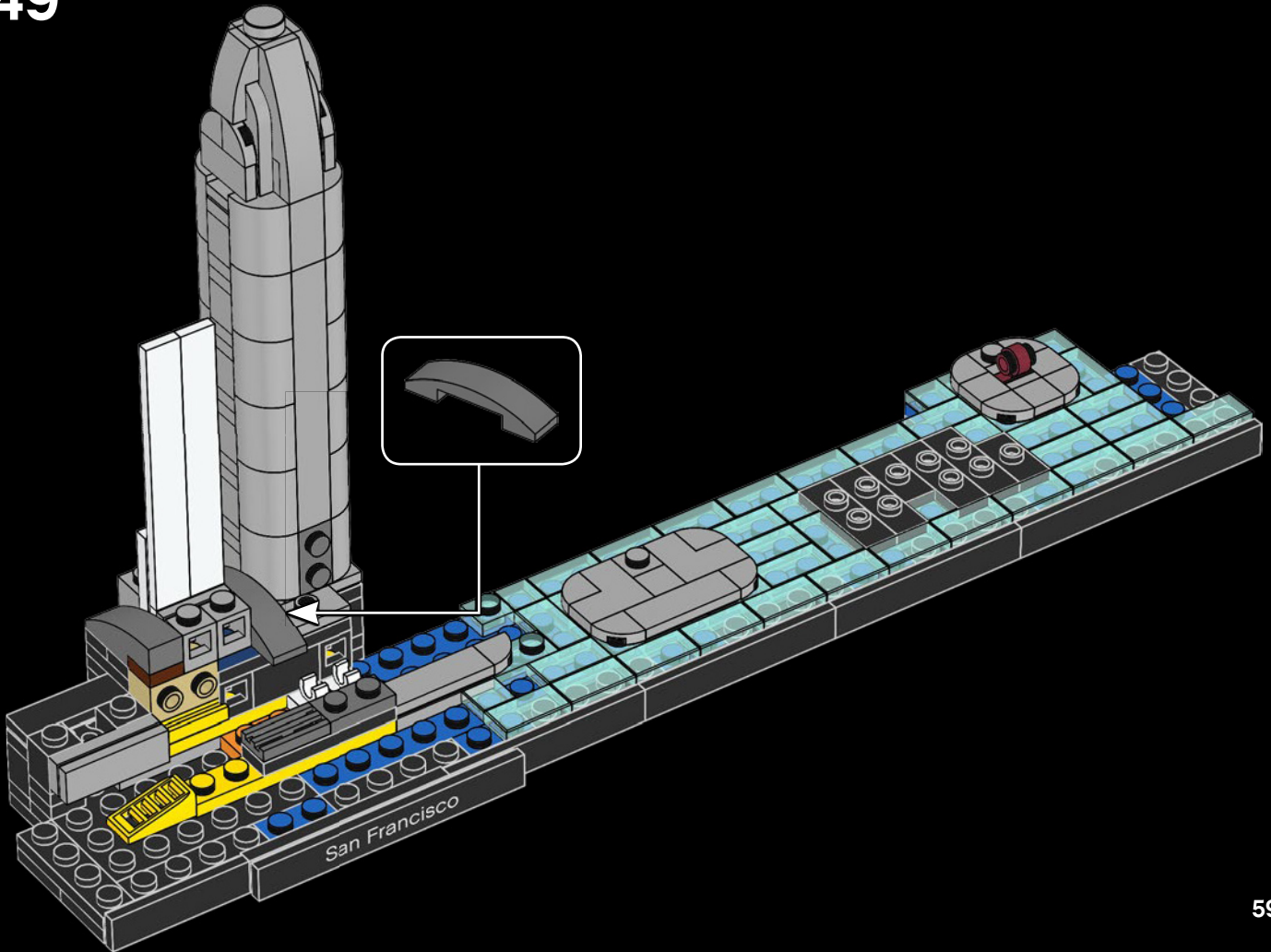

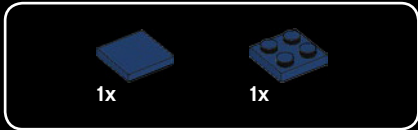

50

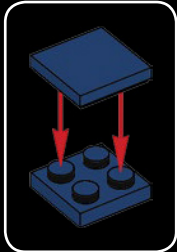
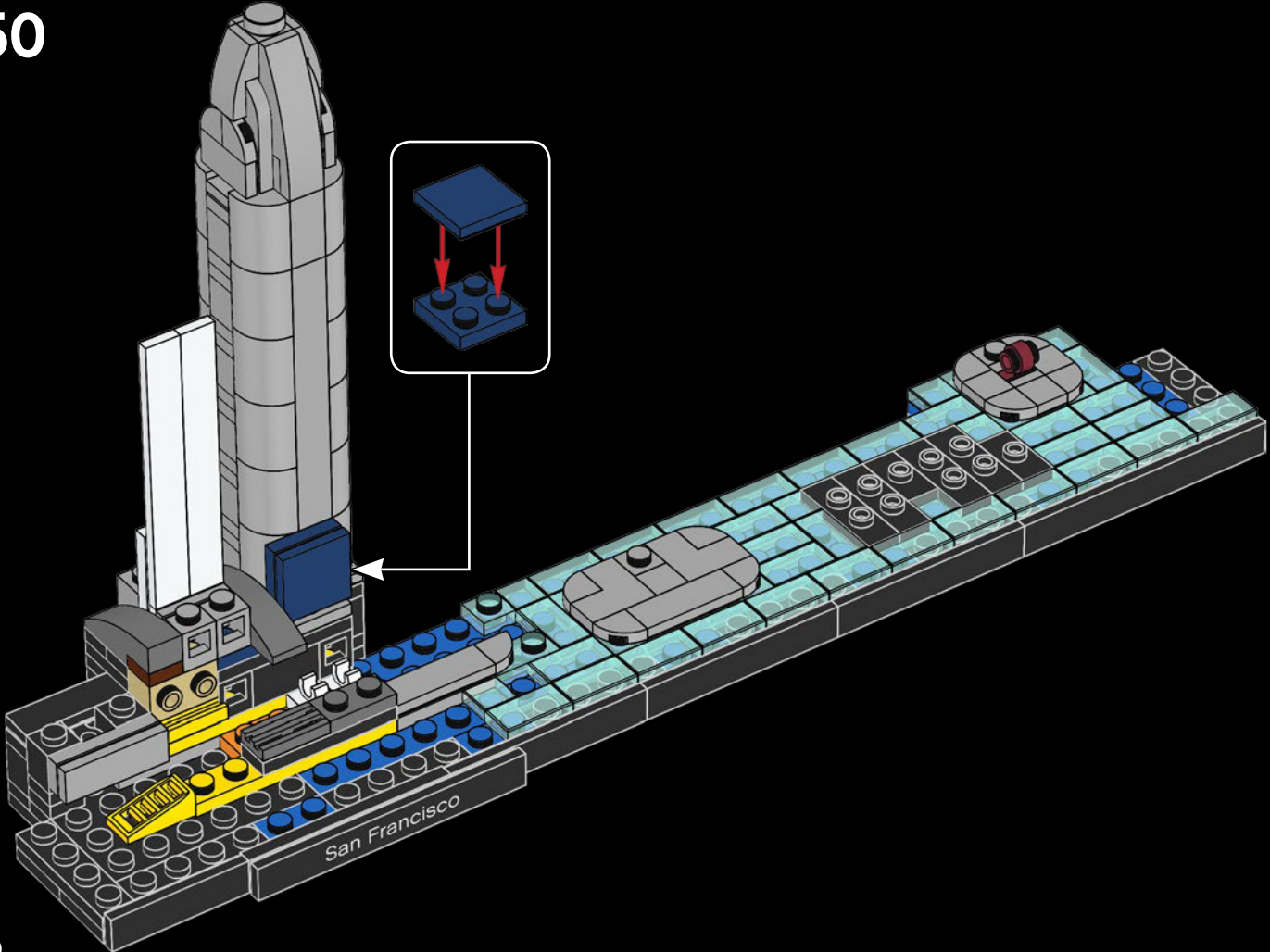

60



51

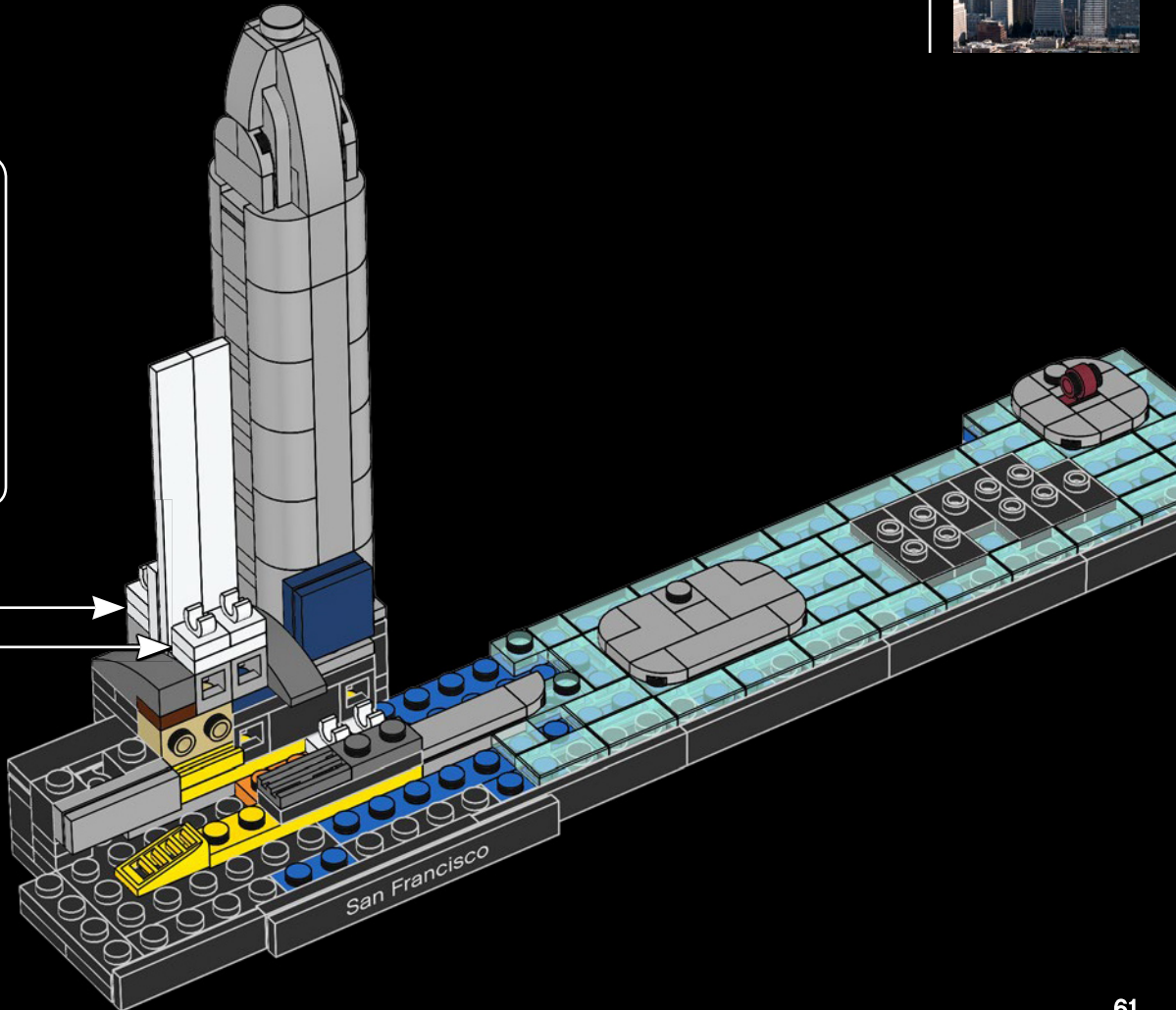
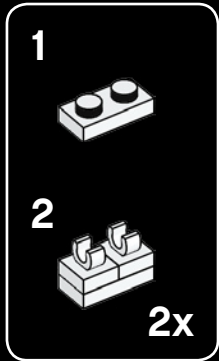

Keeping Clean
Because of the shape of the building, the majority of the windows can pivot 360 degrees so they can be washed from the inside.



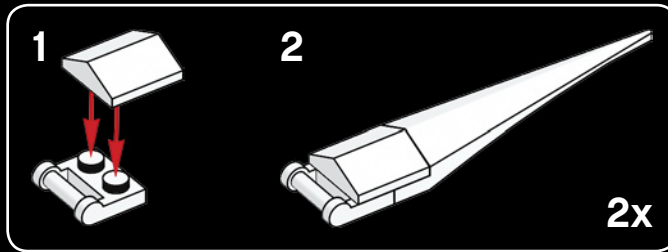
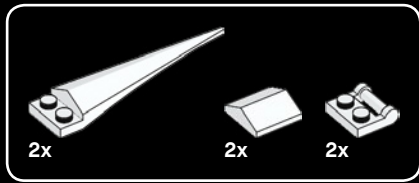

52

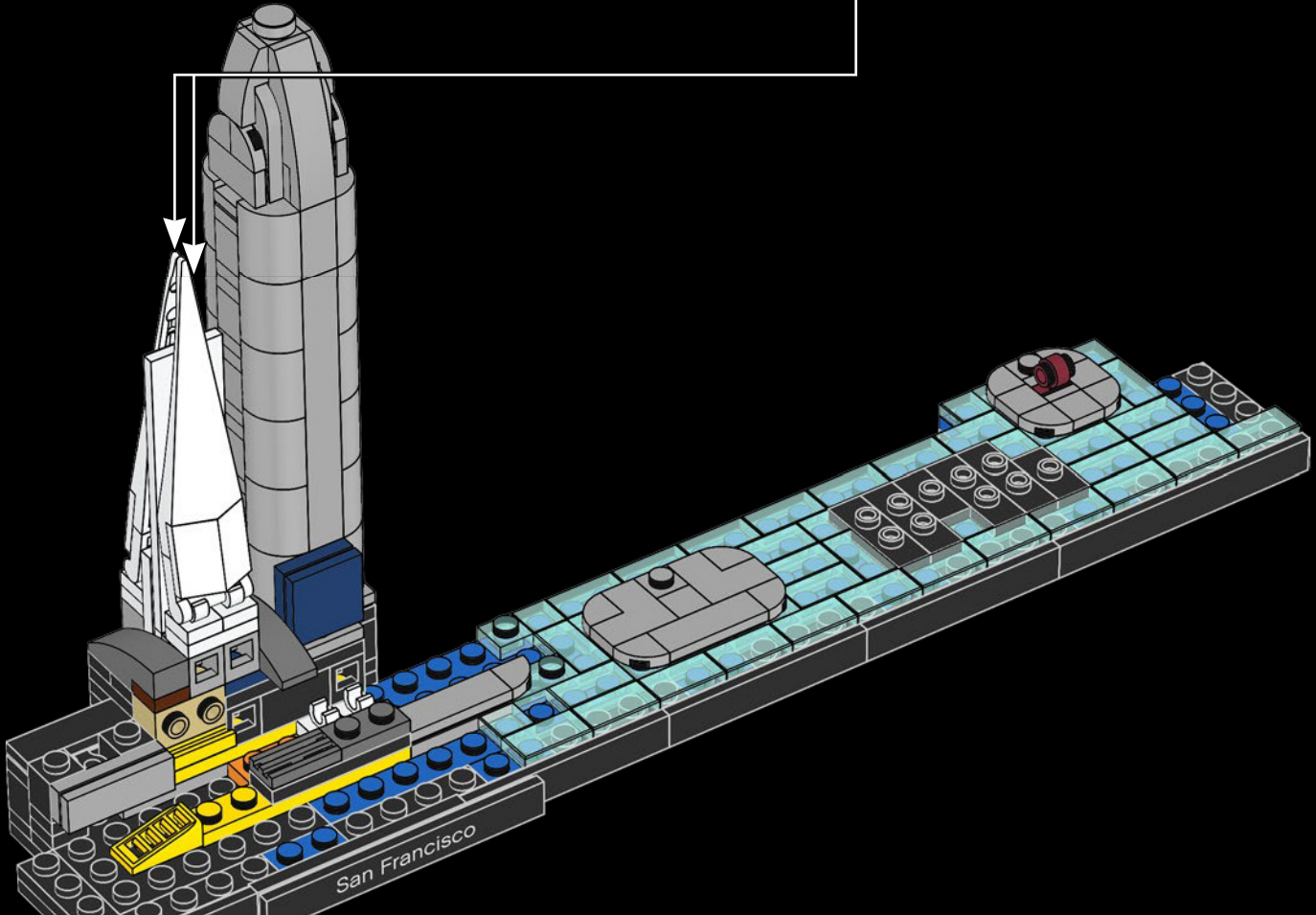

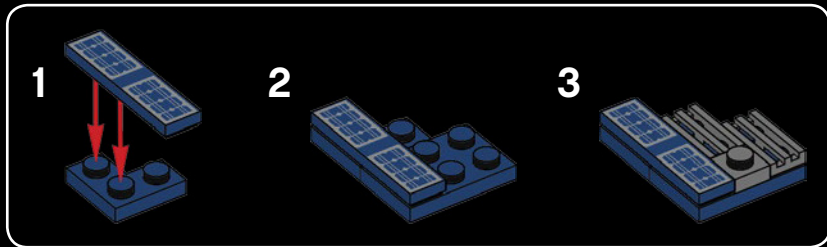
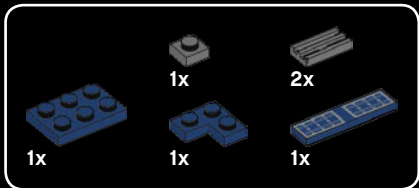

53

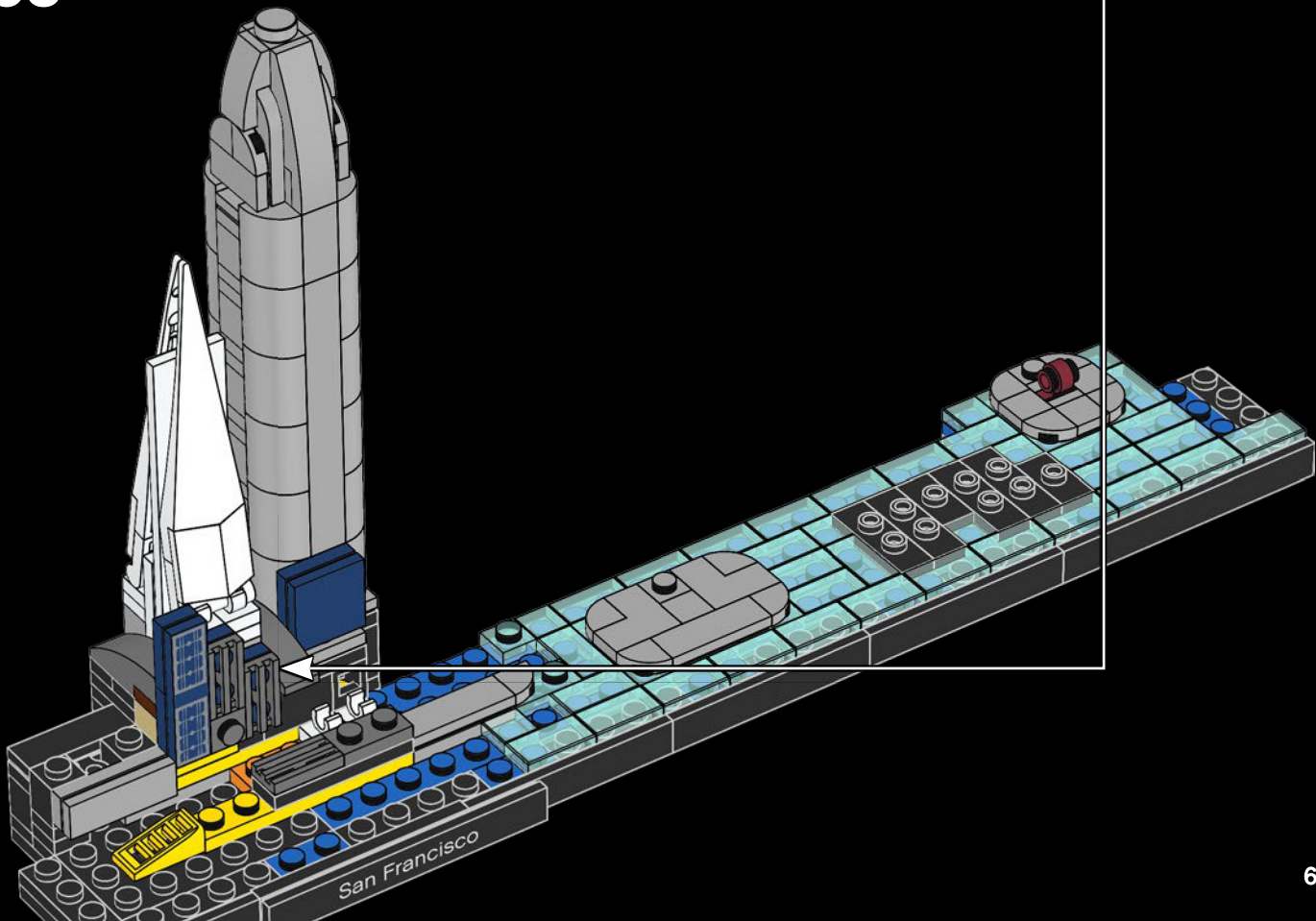

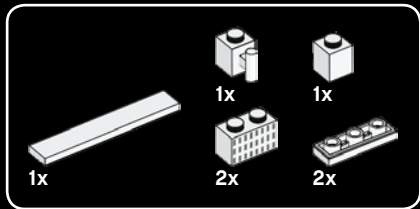

54

1



2



3

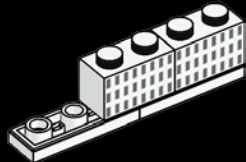

4

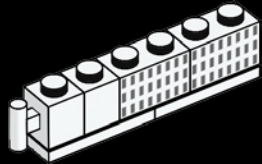

5

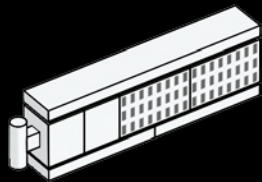

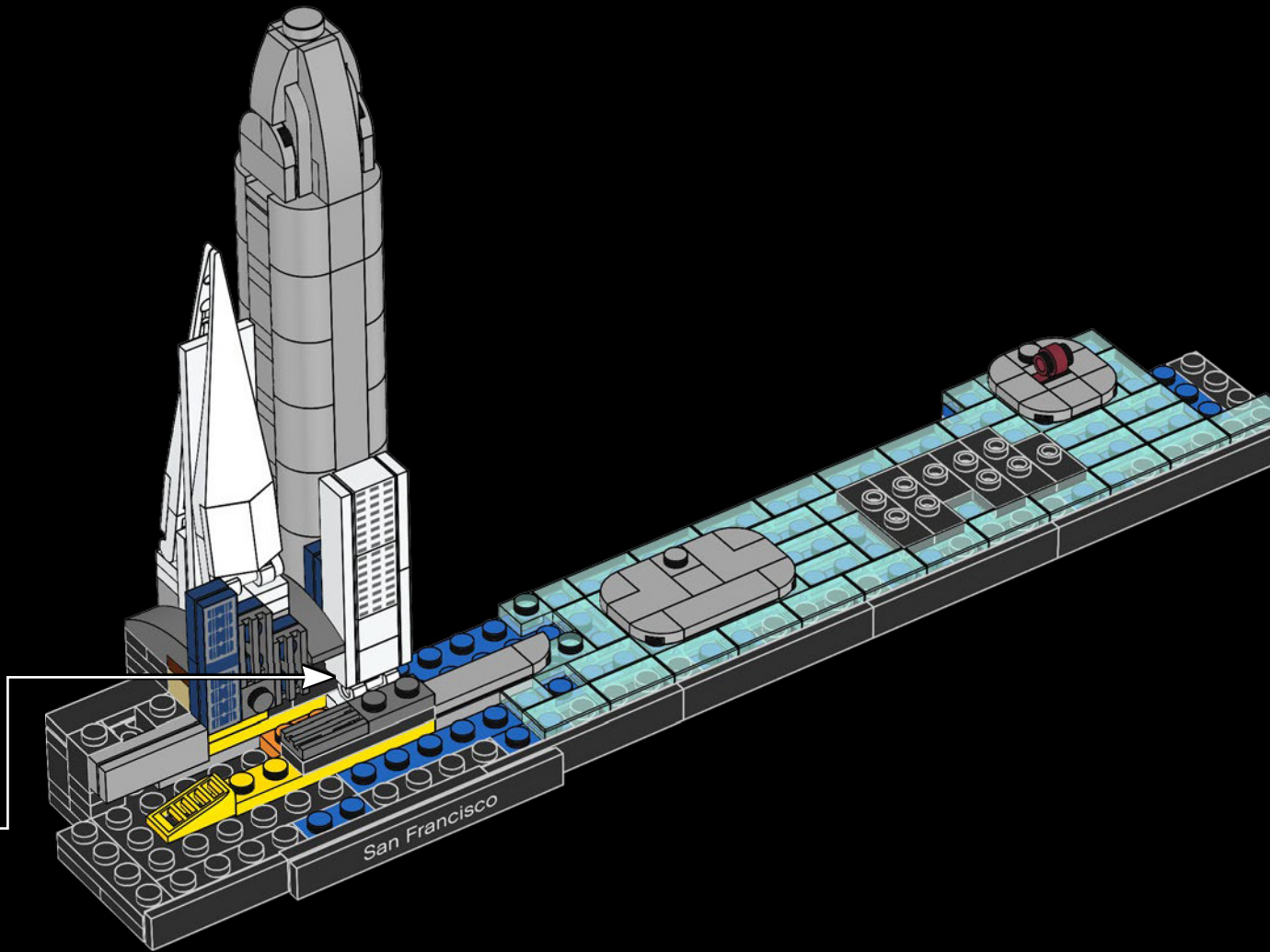



55

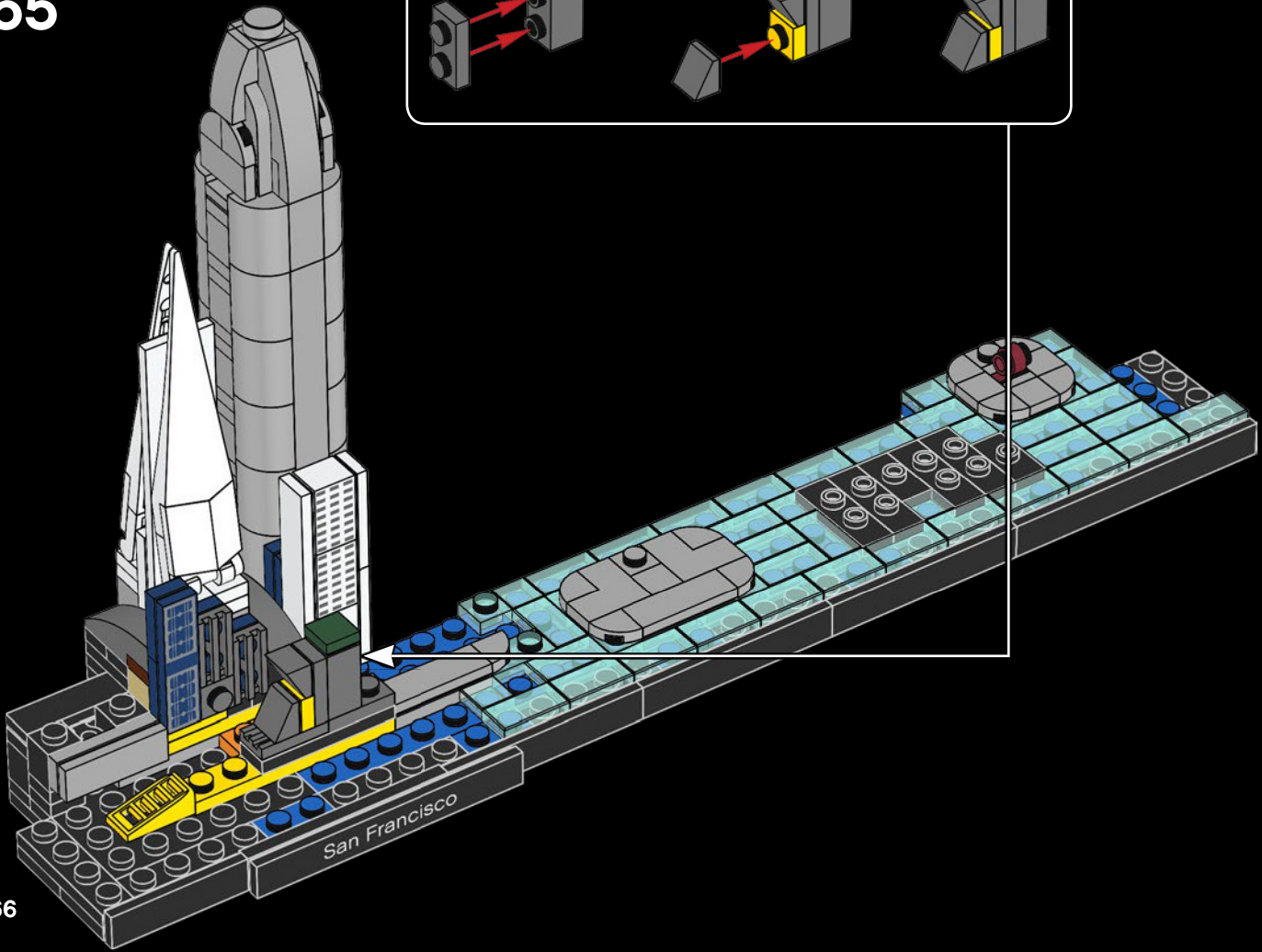
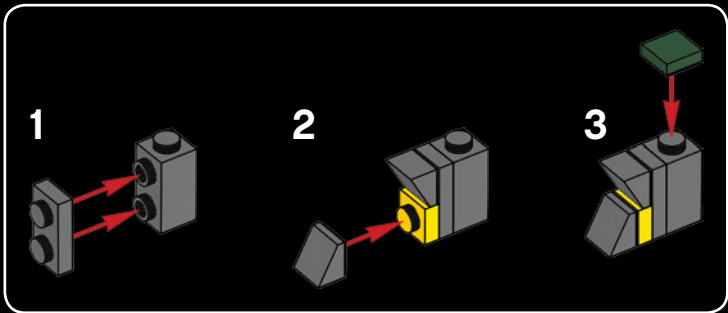

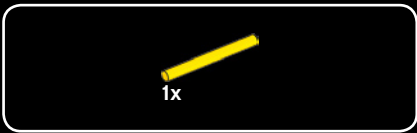

56

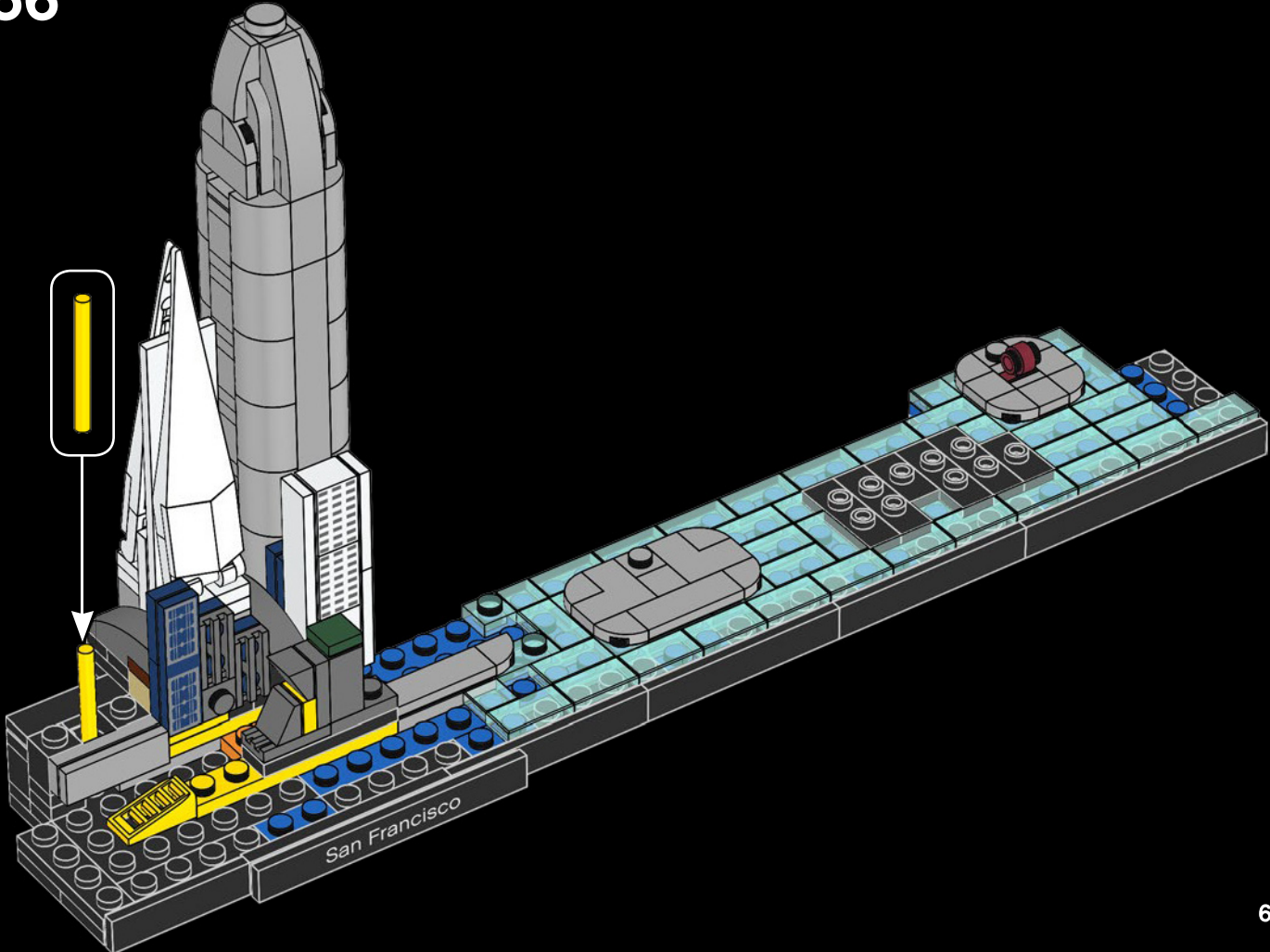



57

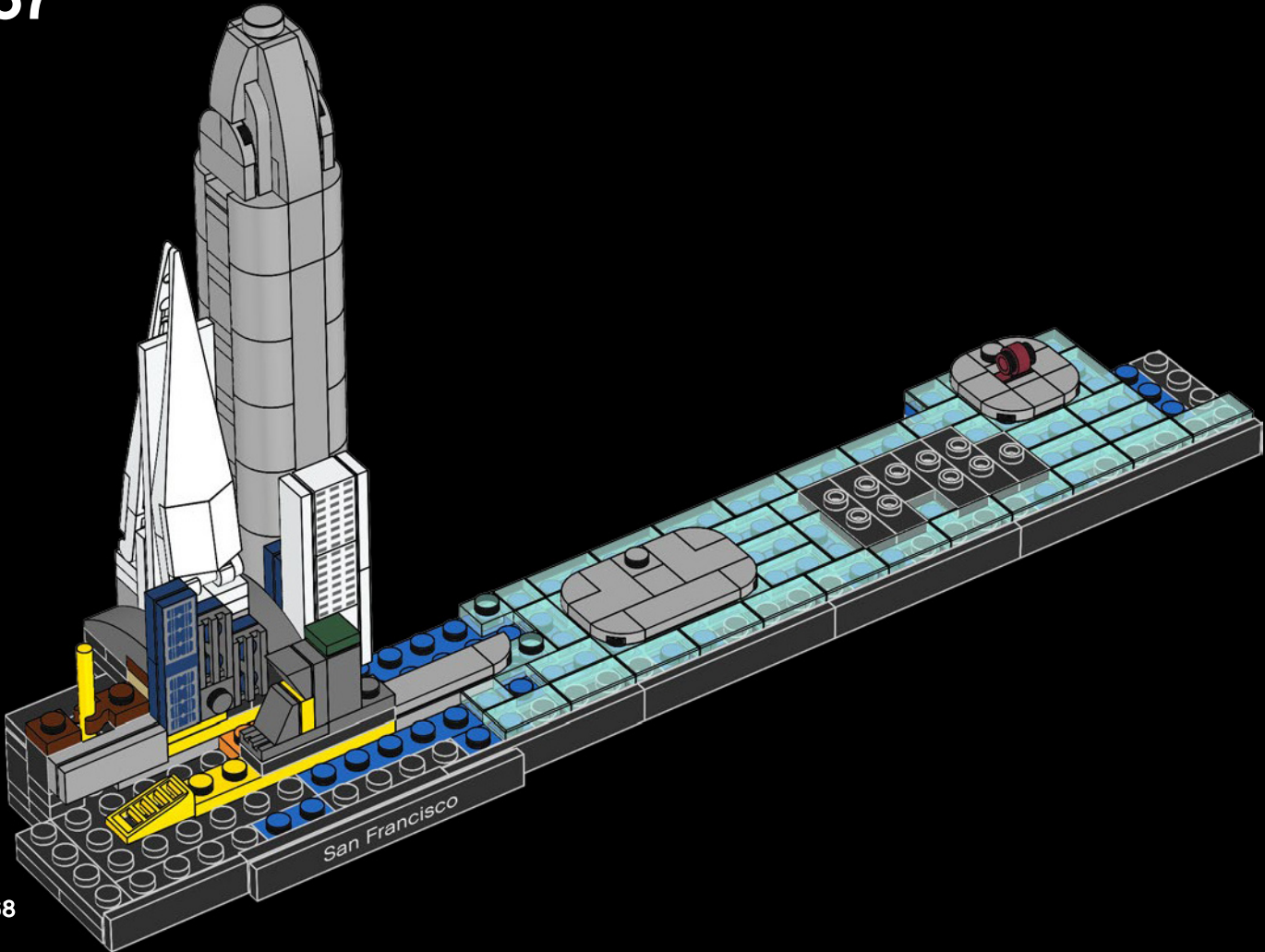

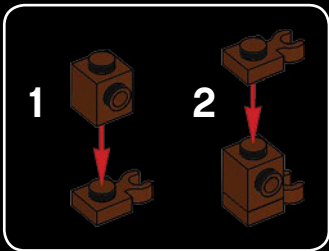

58

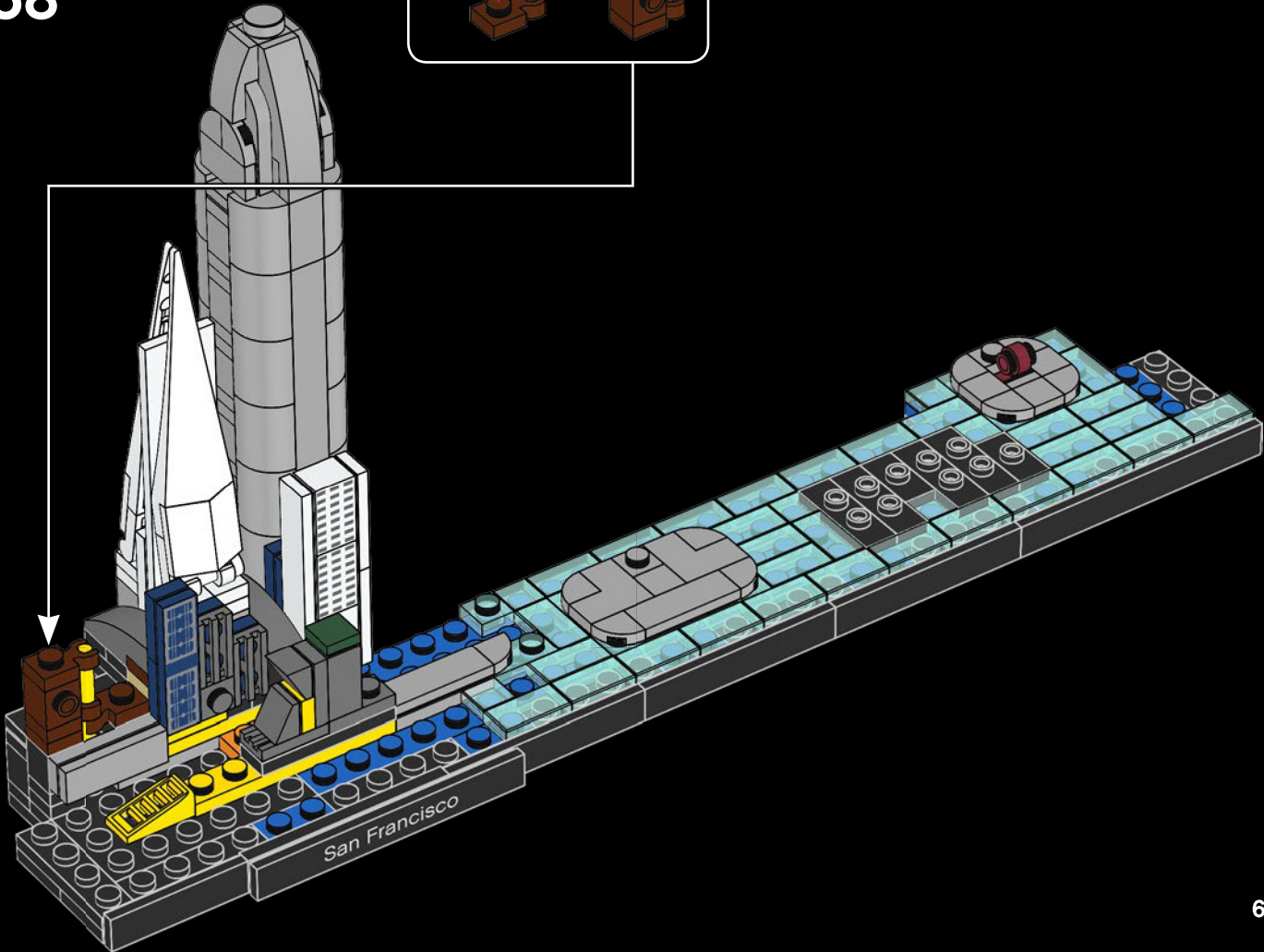

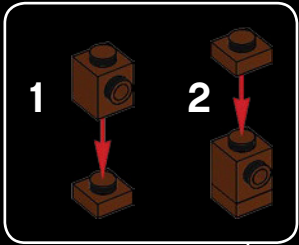
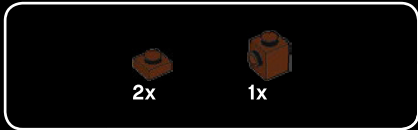

59

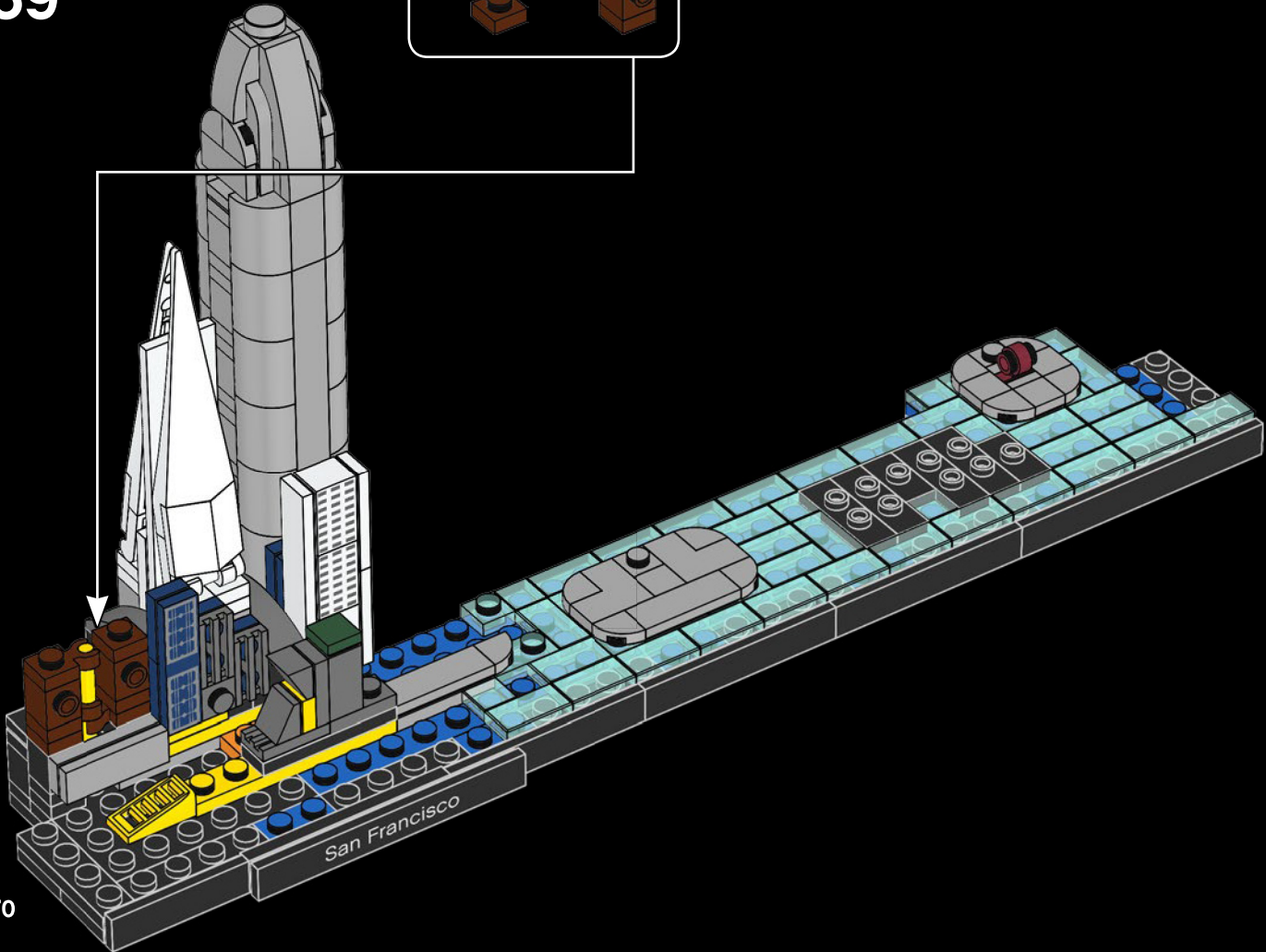

70

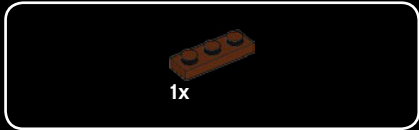
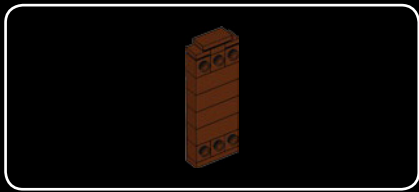

60



61

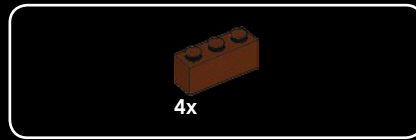
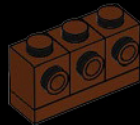

62

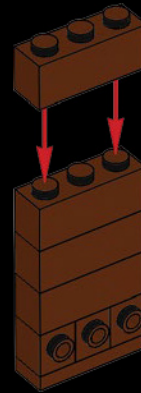



3x

63



1x



2x



1x

64



65

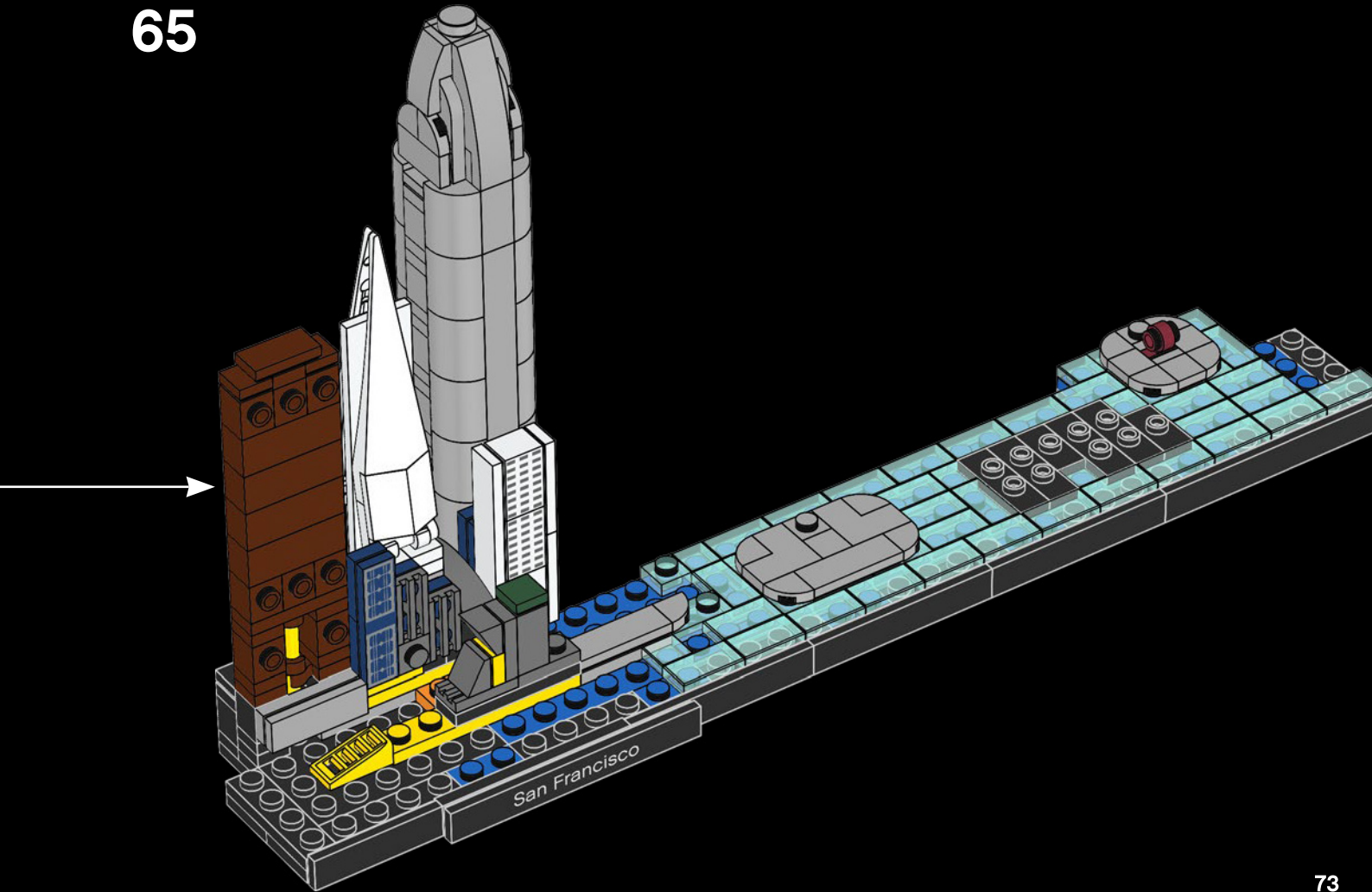

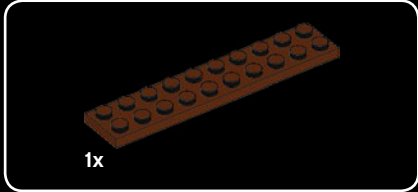

66

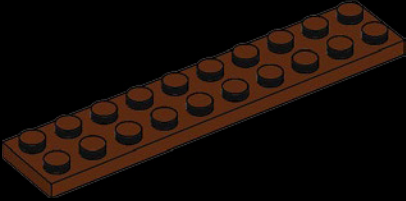

67

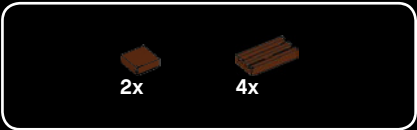
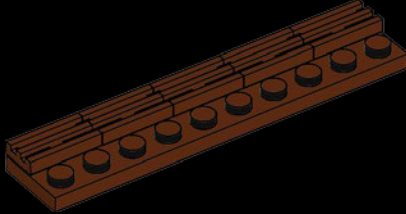

68

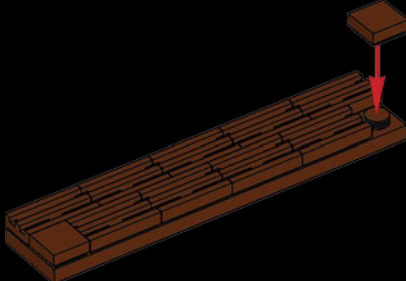

2x

69

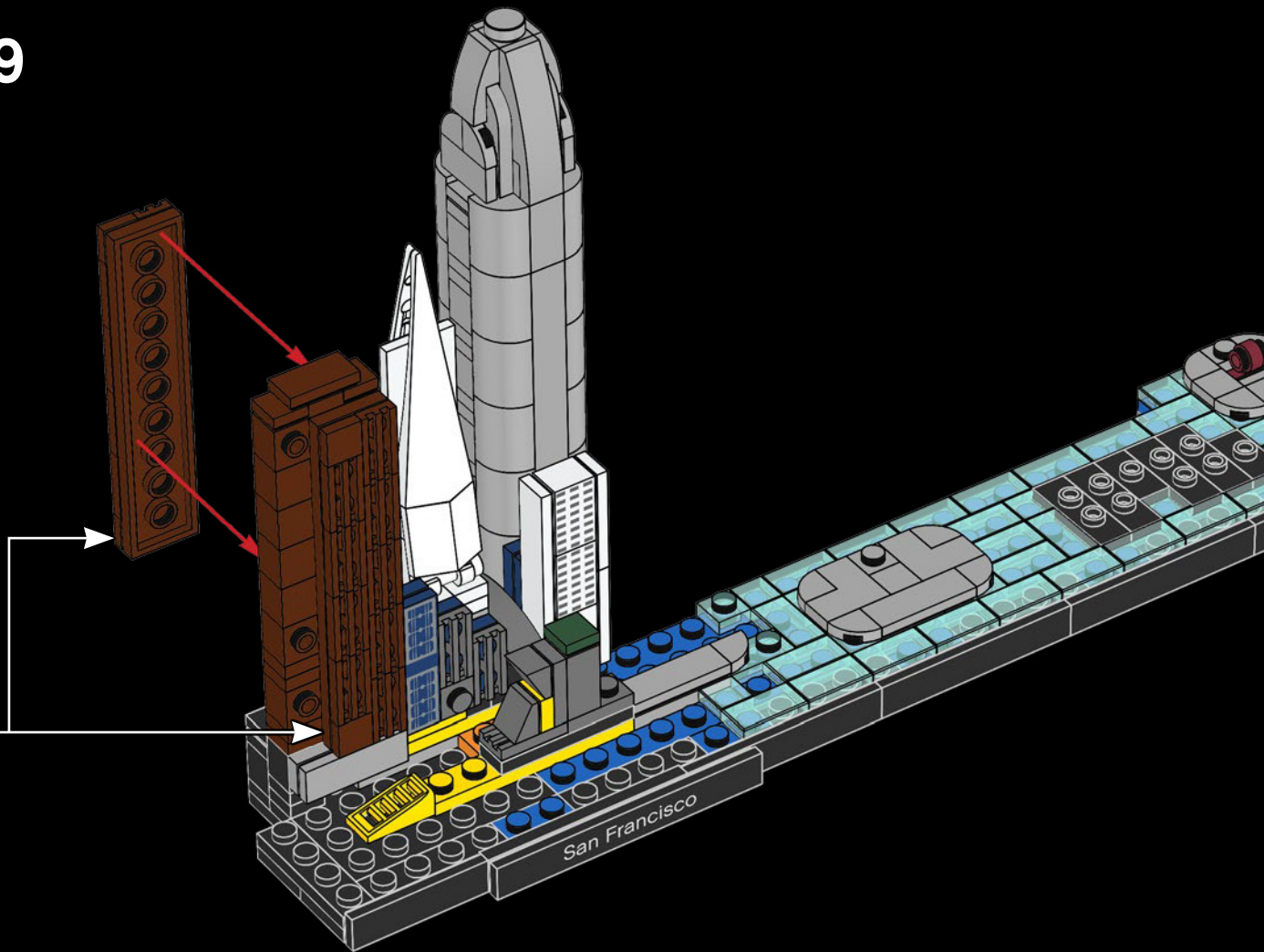

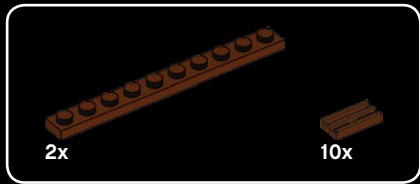

70

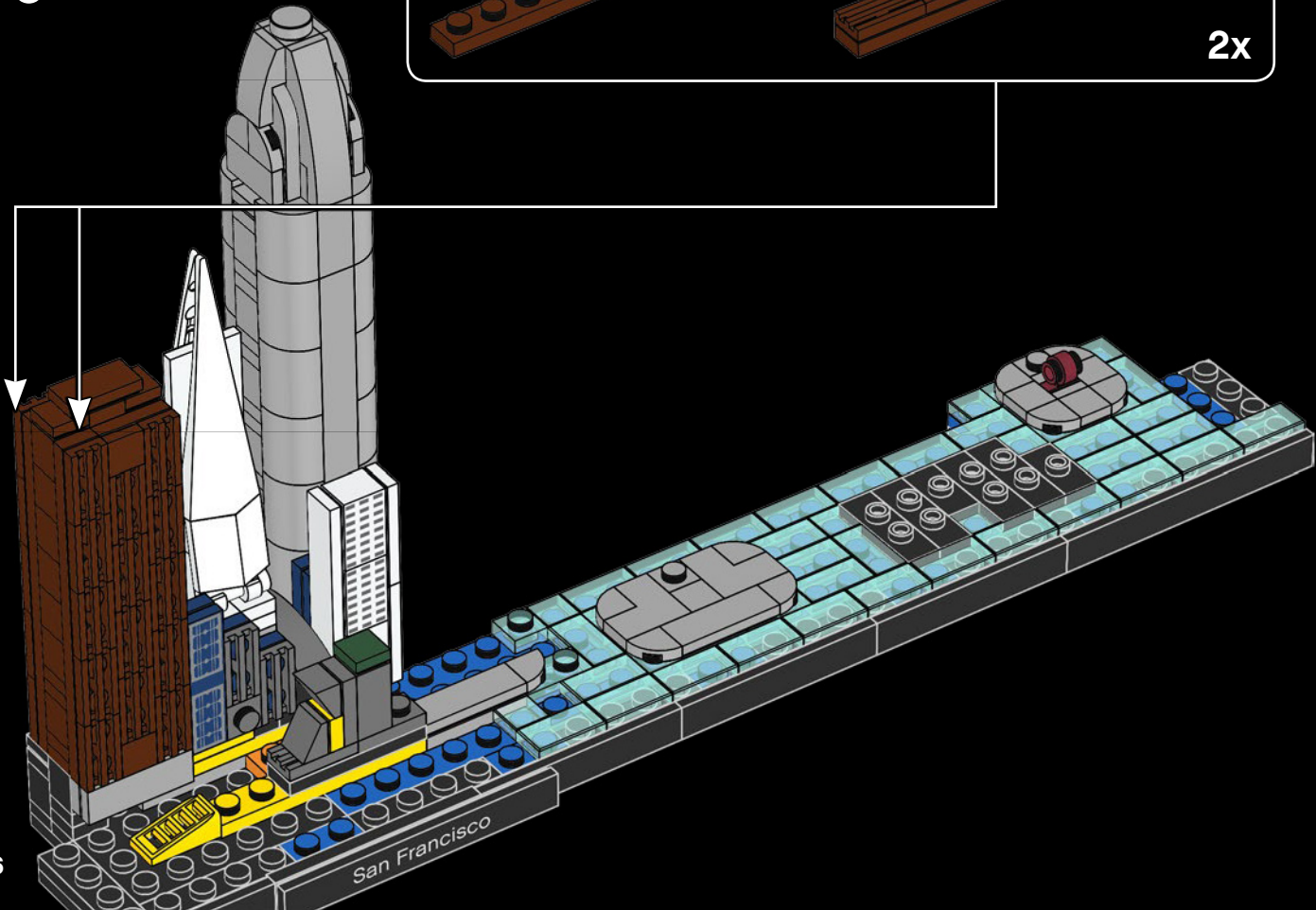
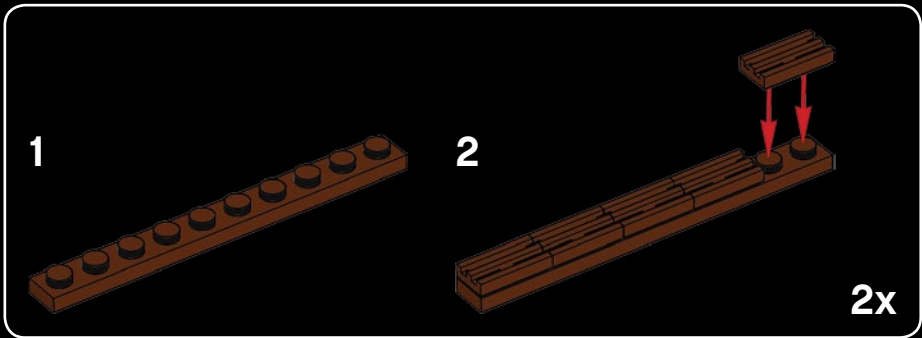

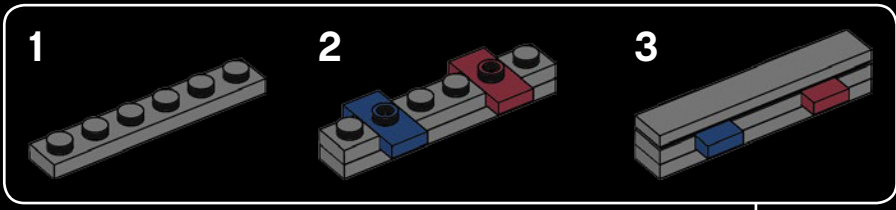
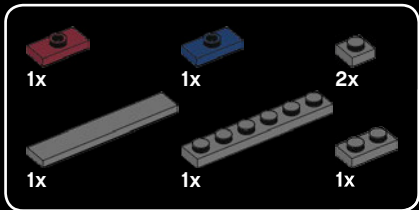

71

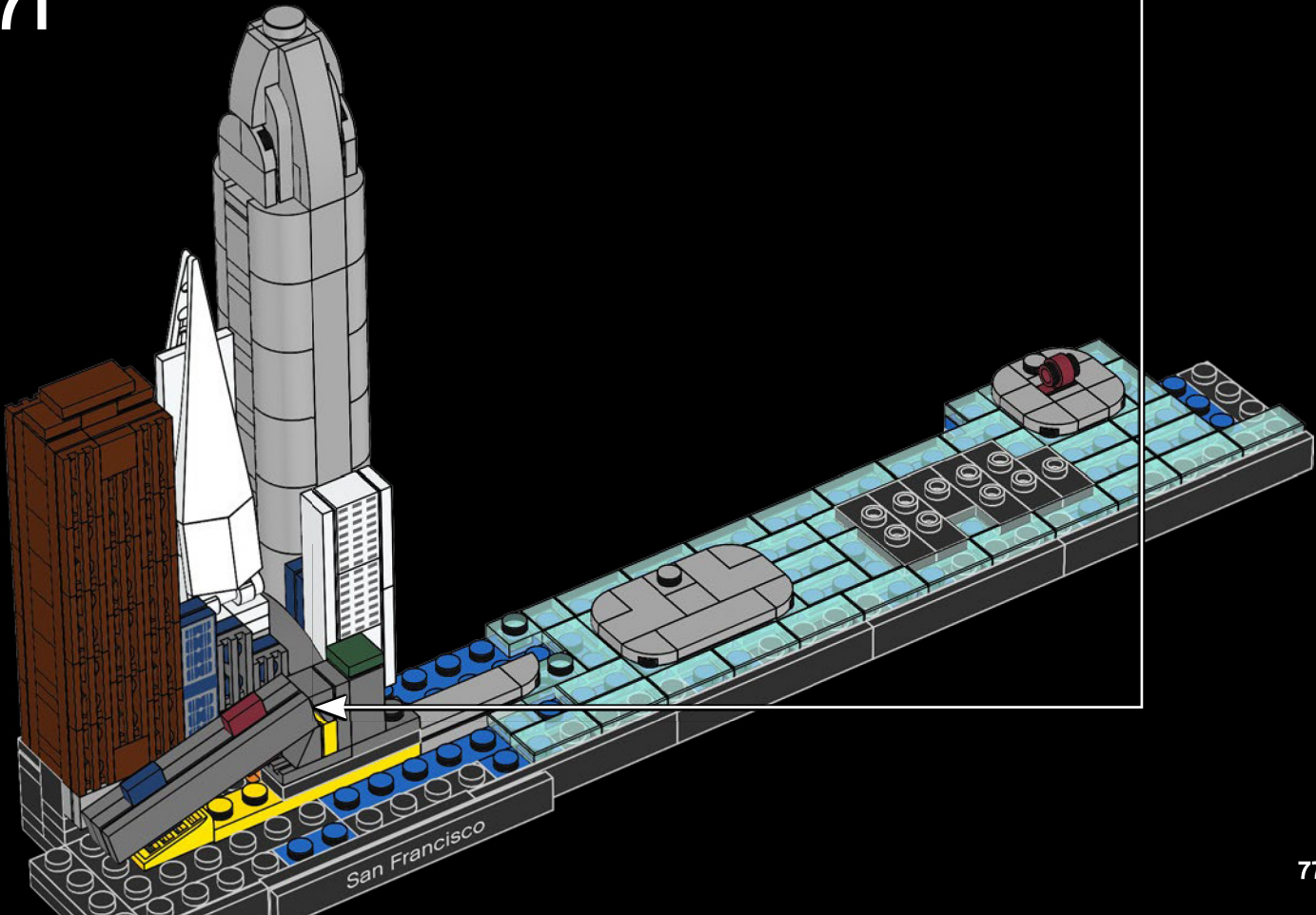

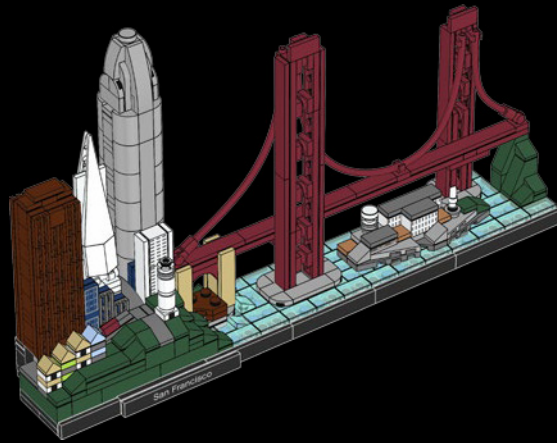

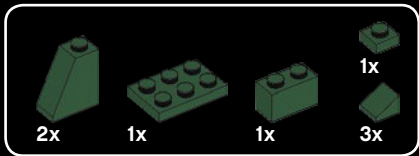

72

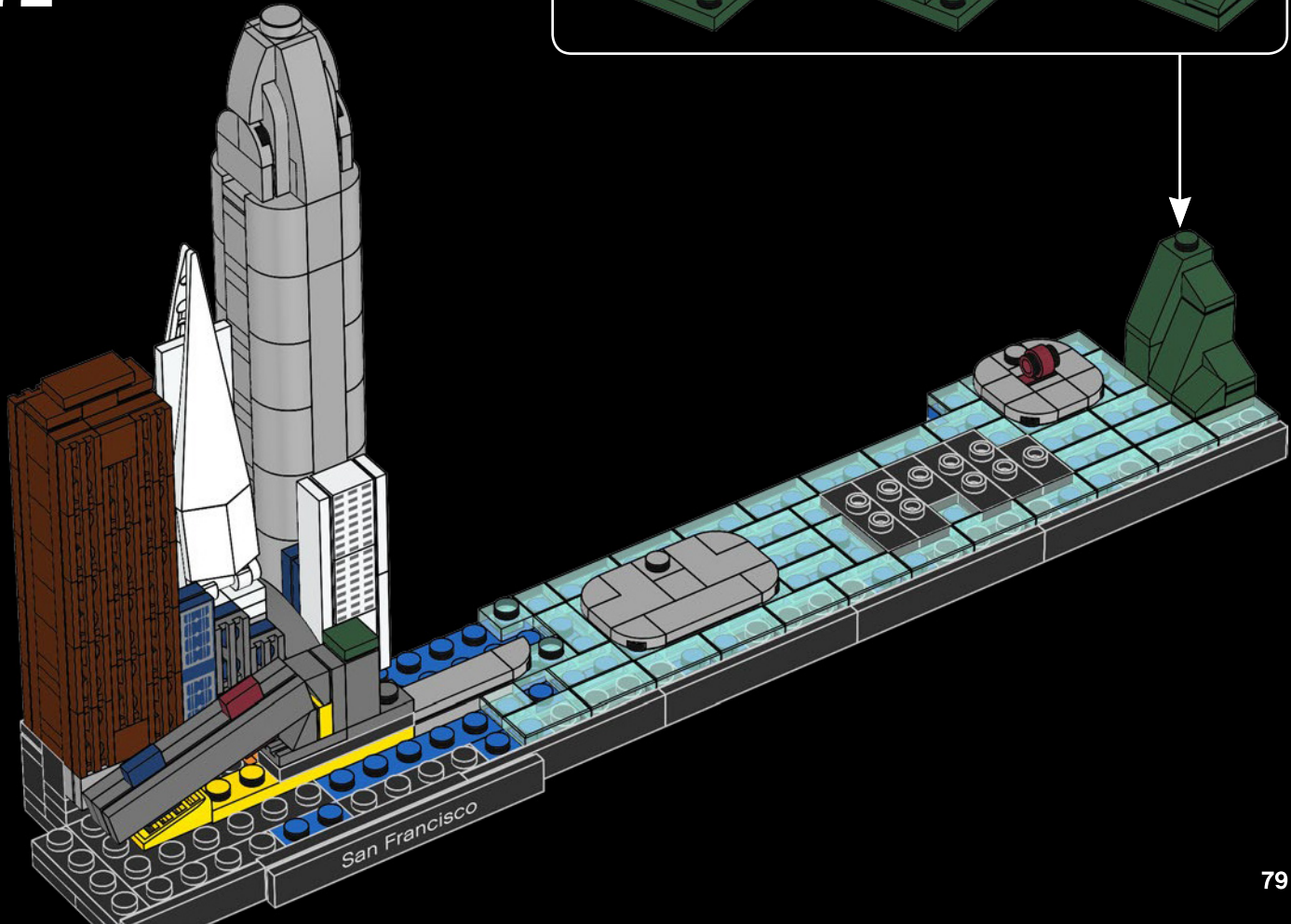
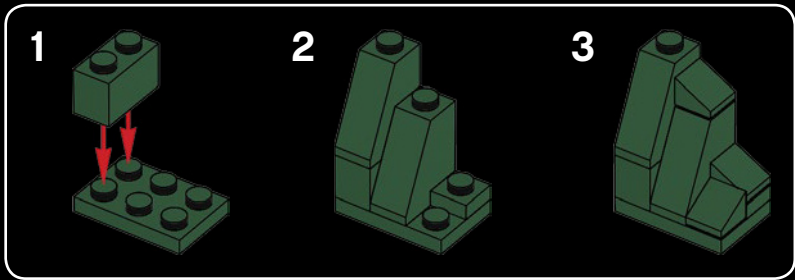

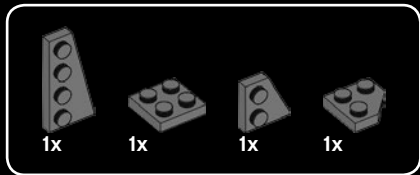

73

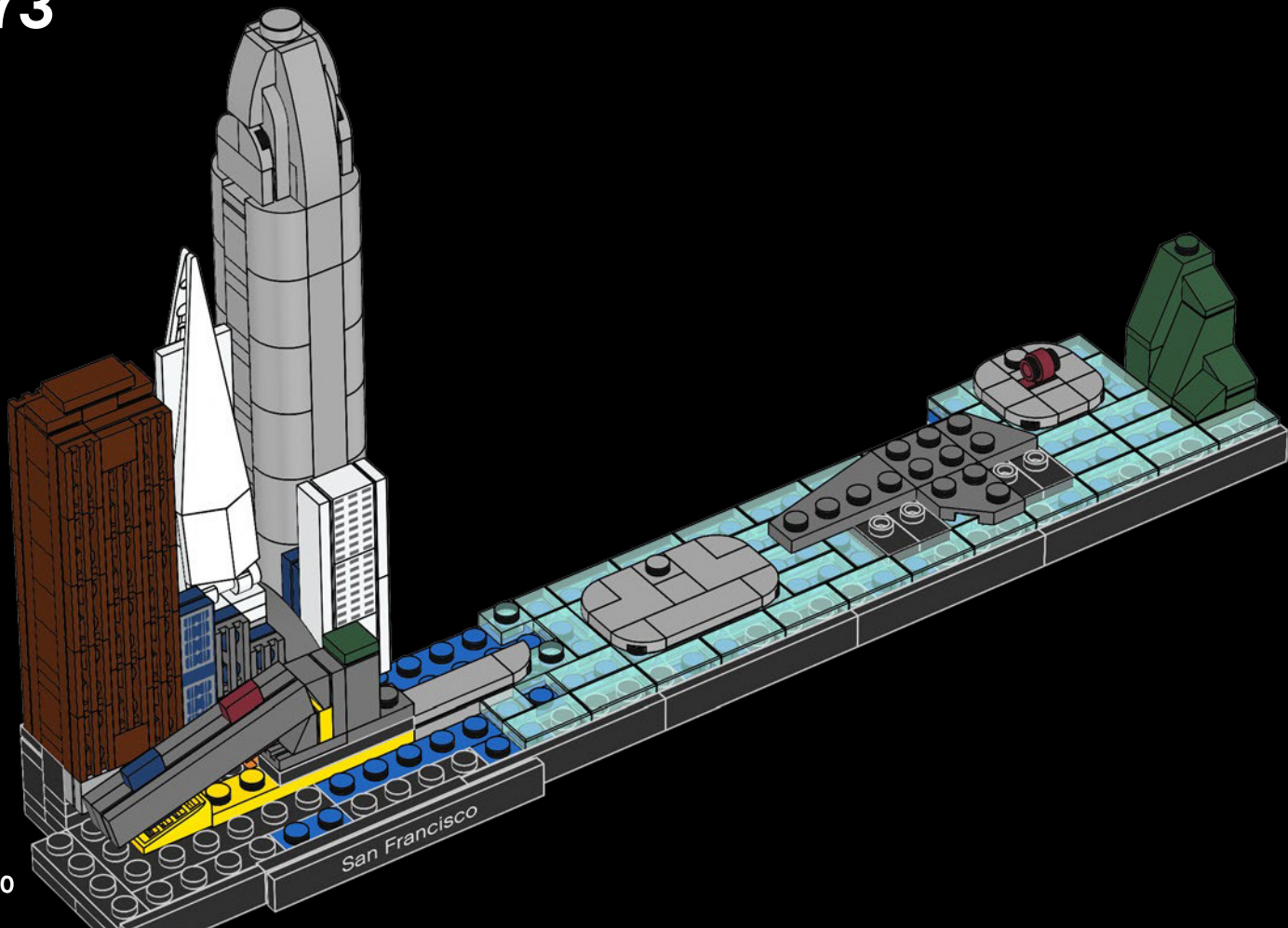

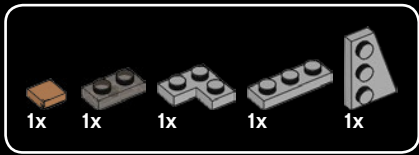

74

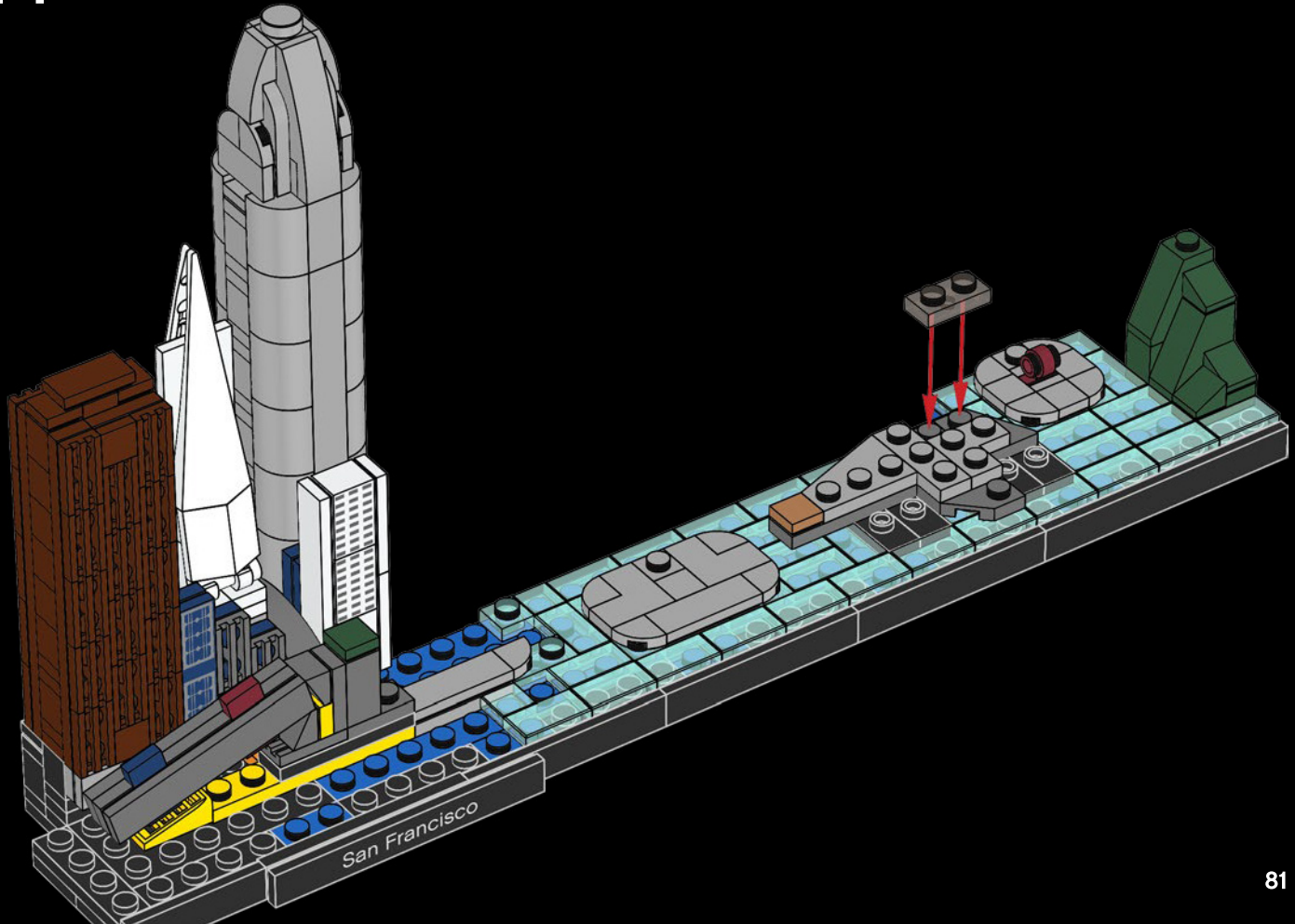

1x 2x 1x

75

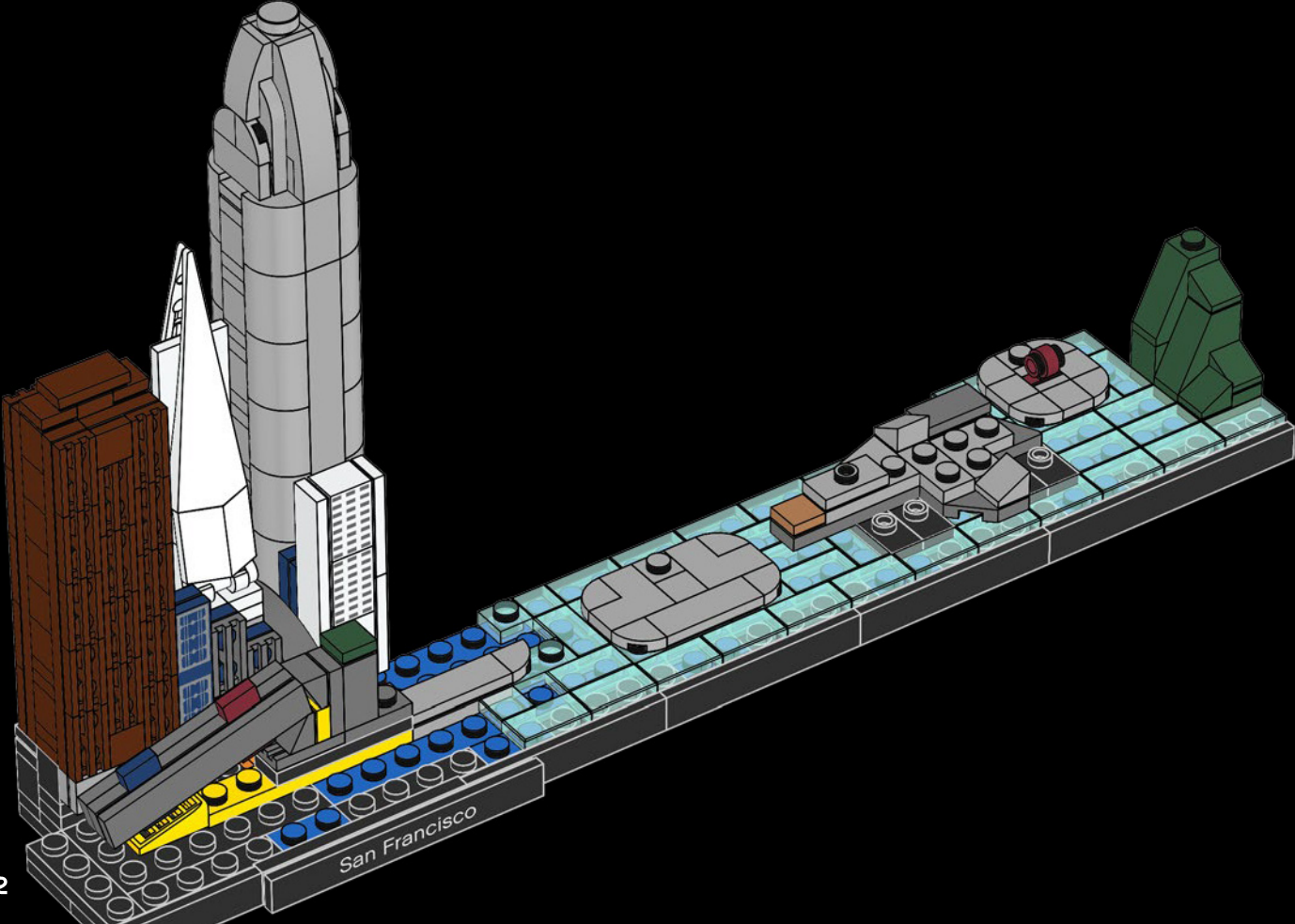



76

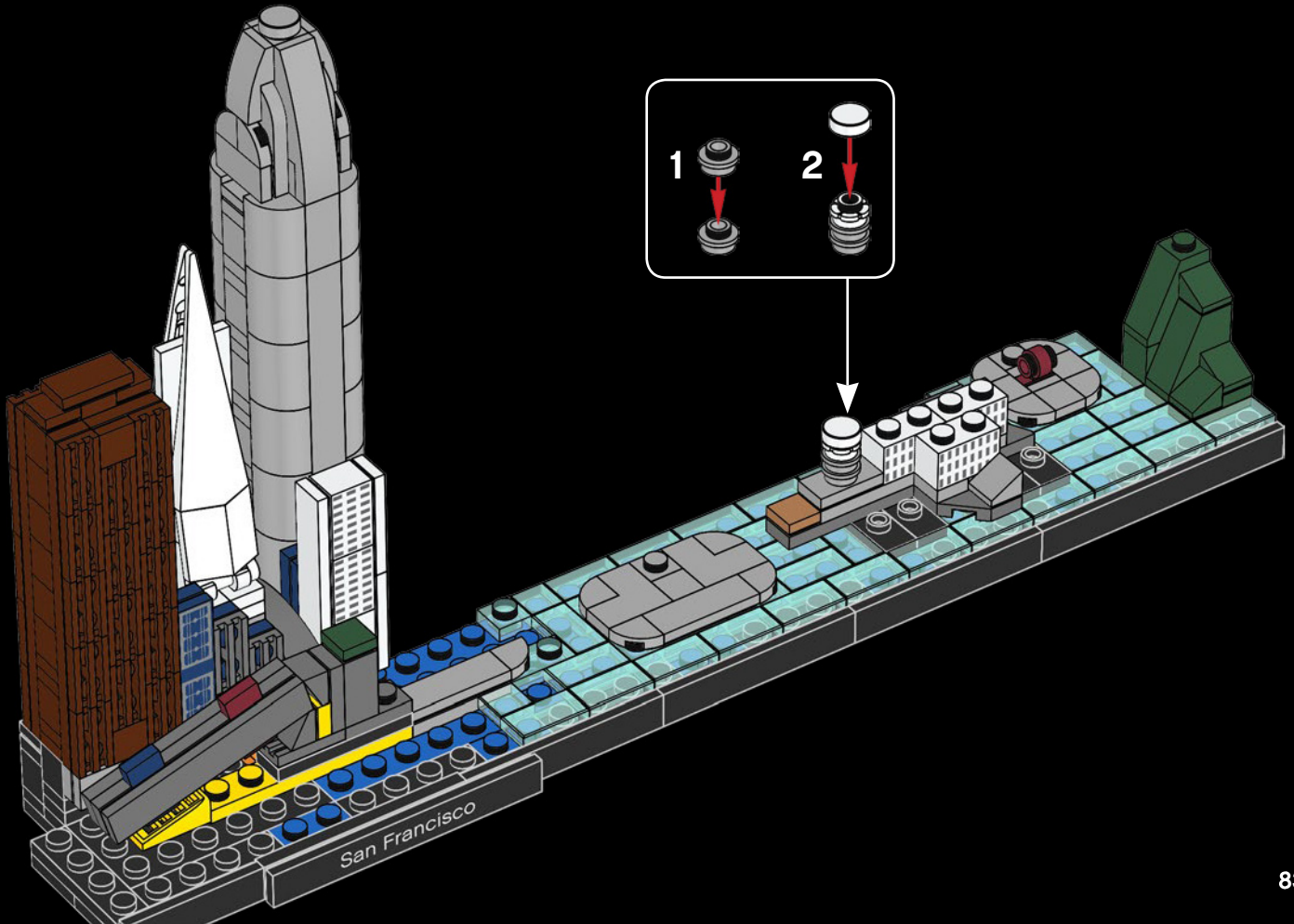

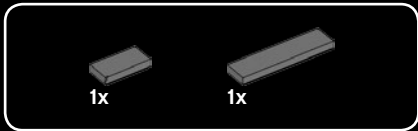

77

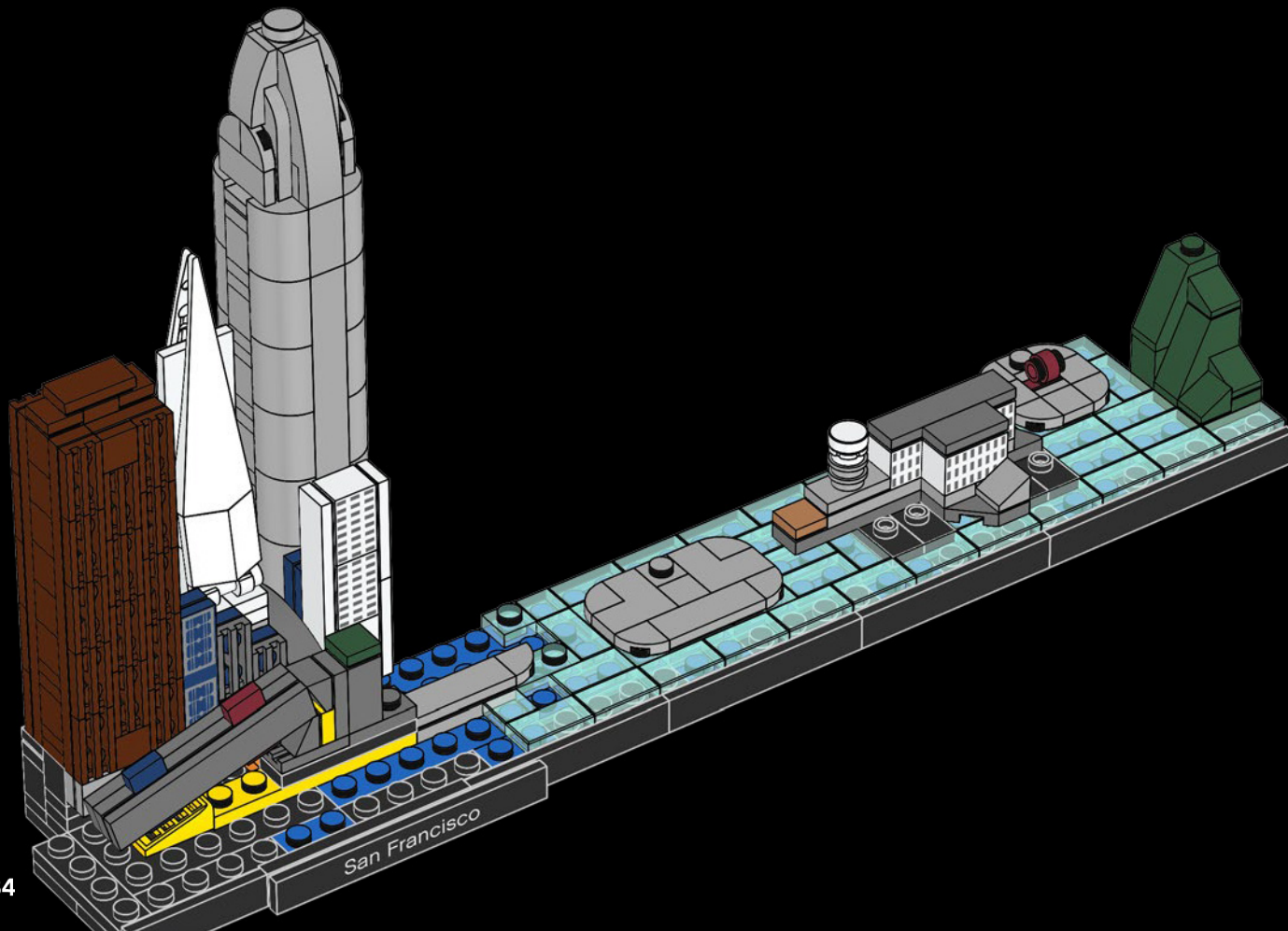

Light on The "Rock"

The island also has a lighthouse on it to help guide ships away from its rocks in the middle of the night, and was the first operational lighthouse on the west coast of the USA when it was lit in 1854.

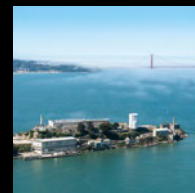

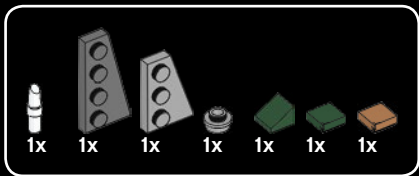

78

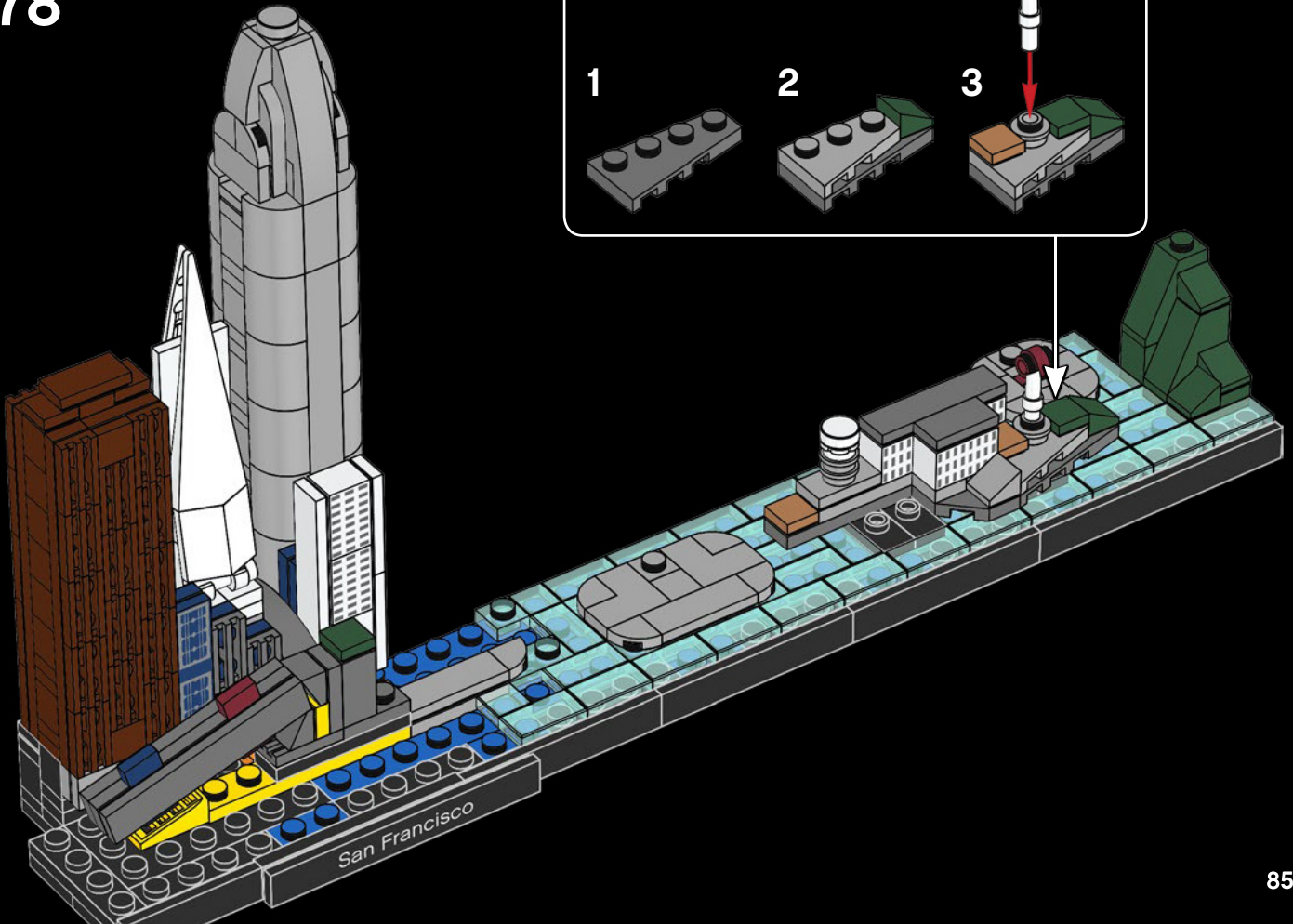
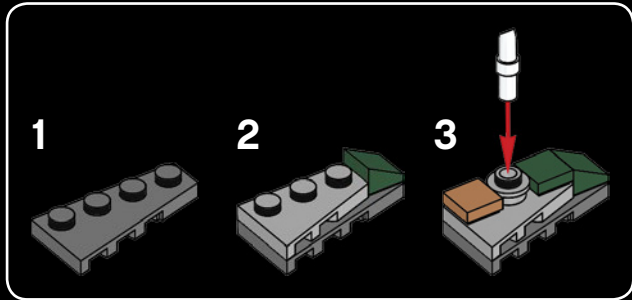

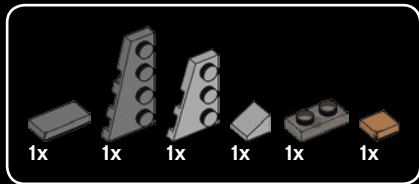

79

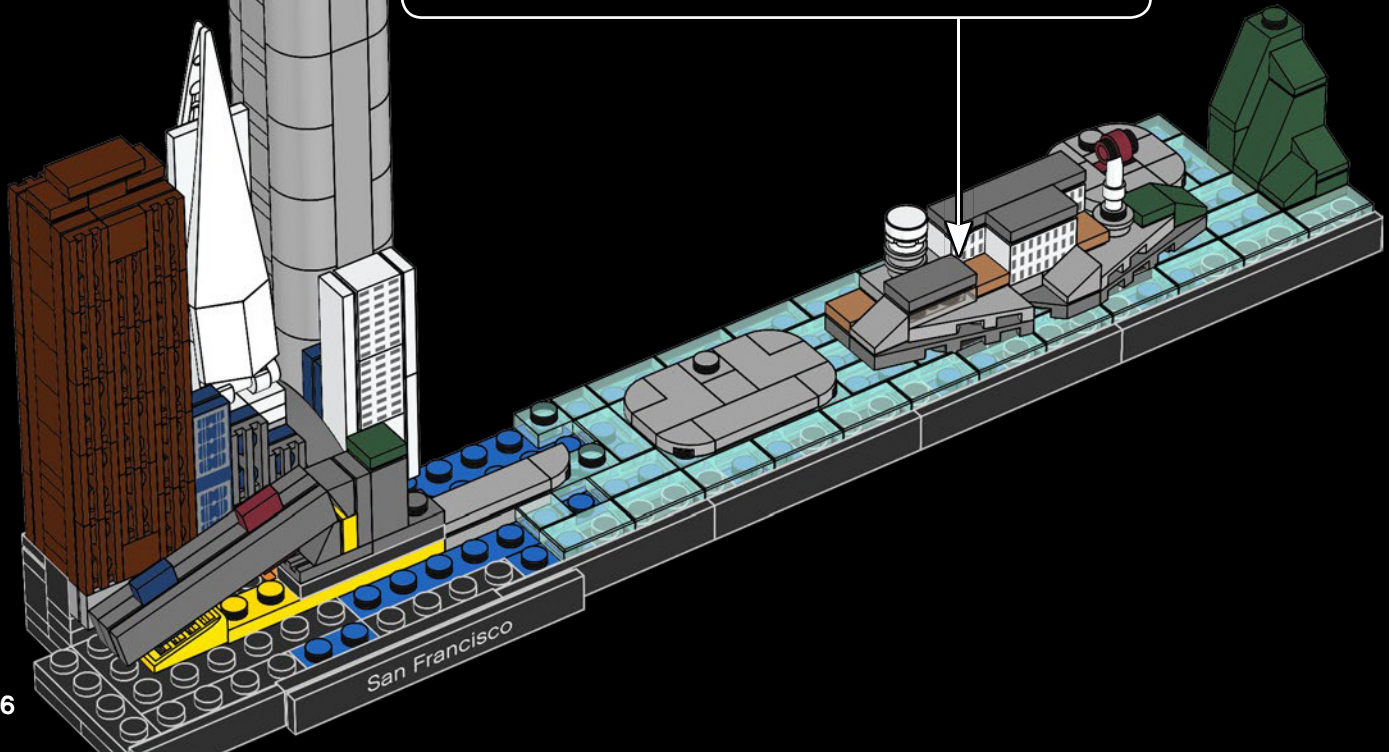
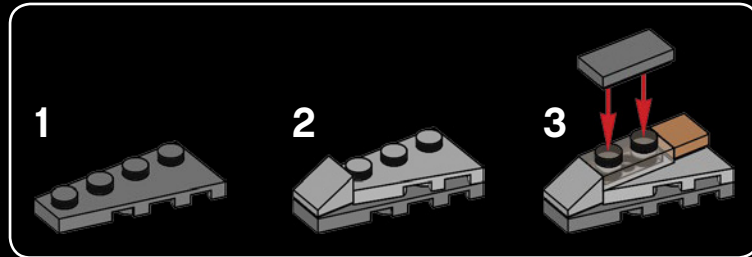

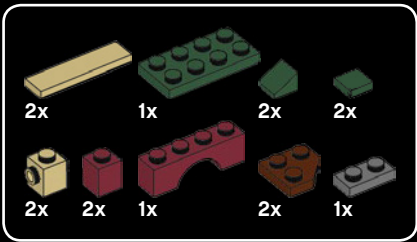

80

1



2

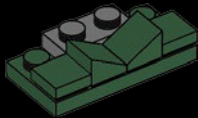

3

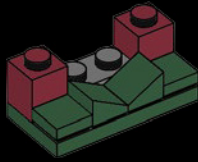

4

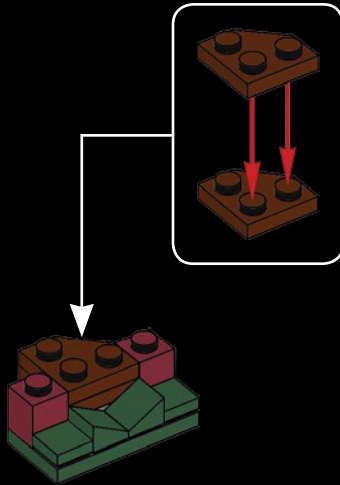

5

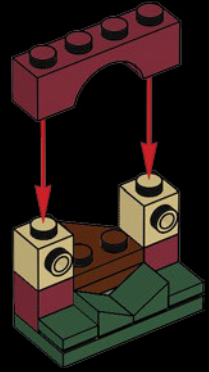

6

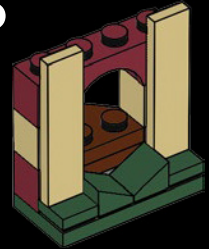

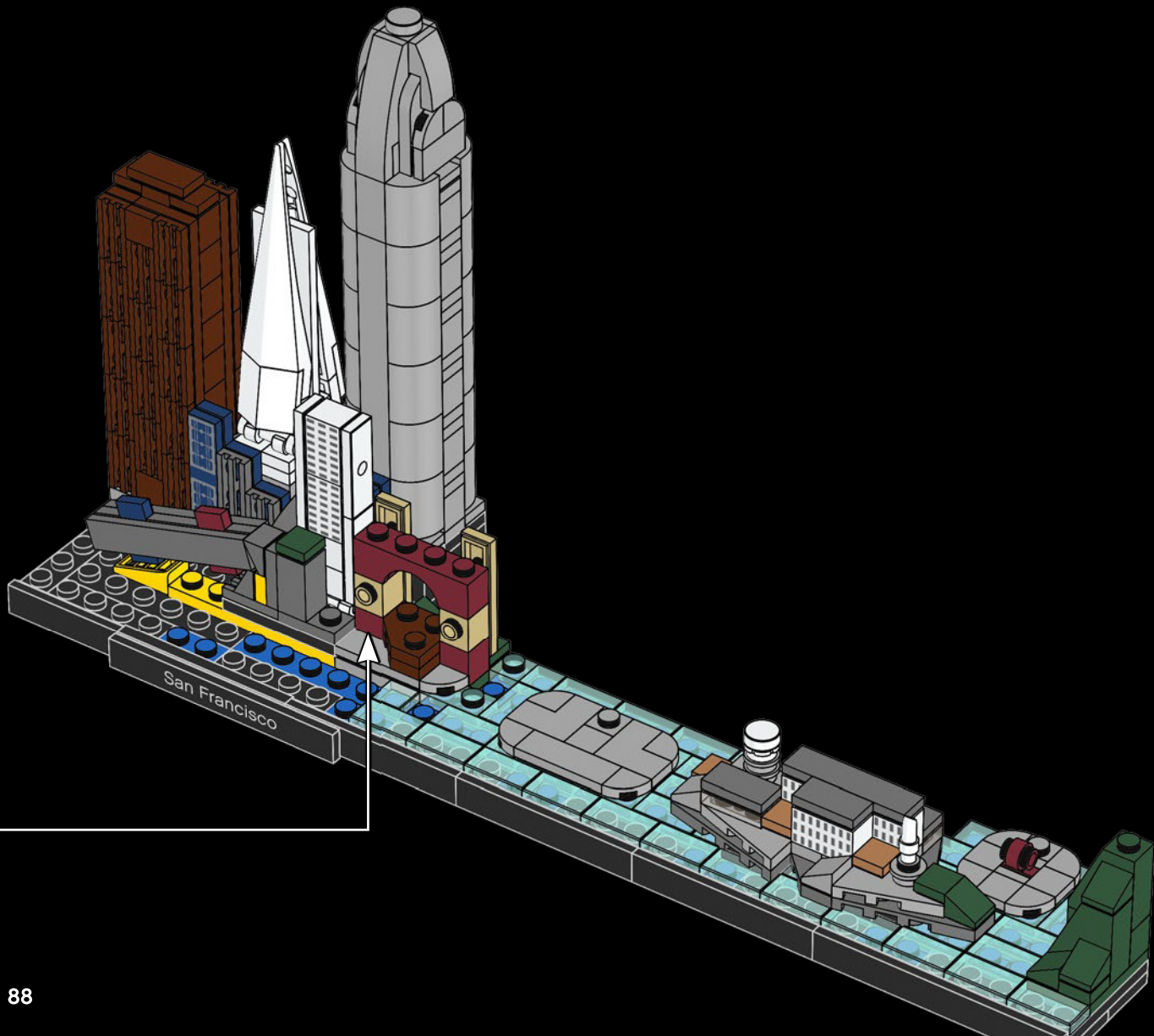



81

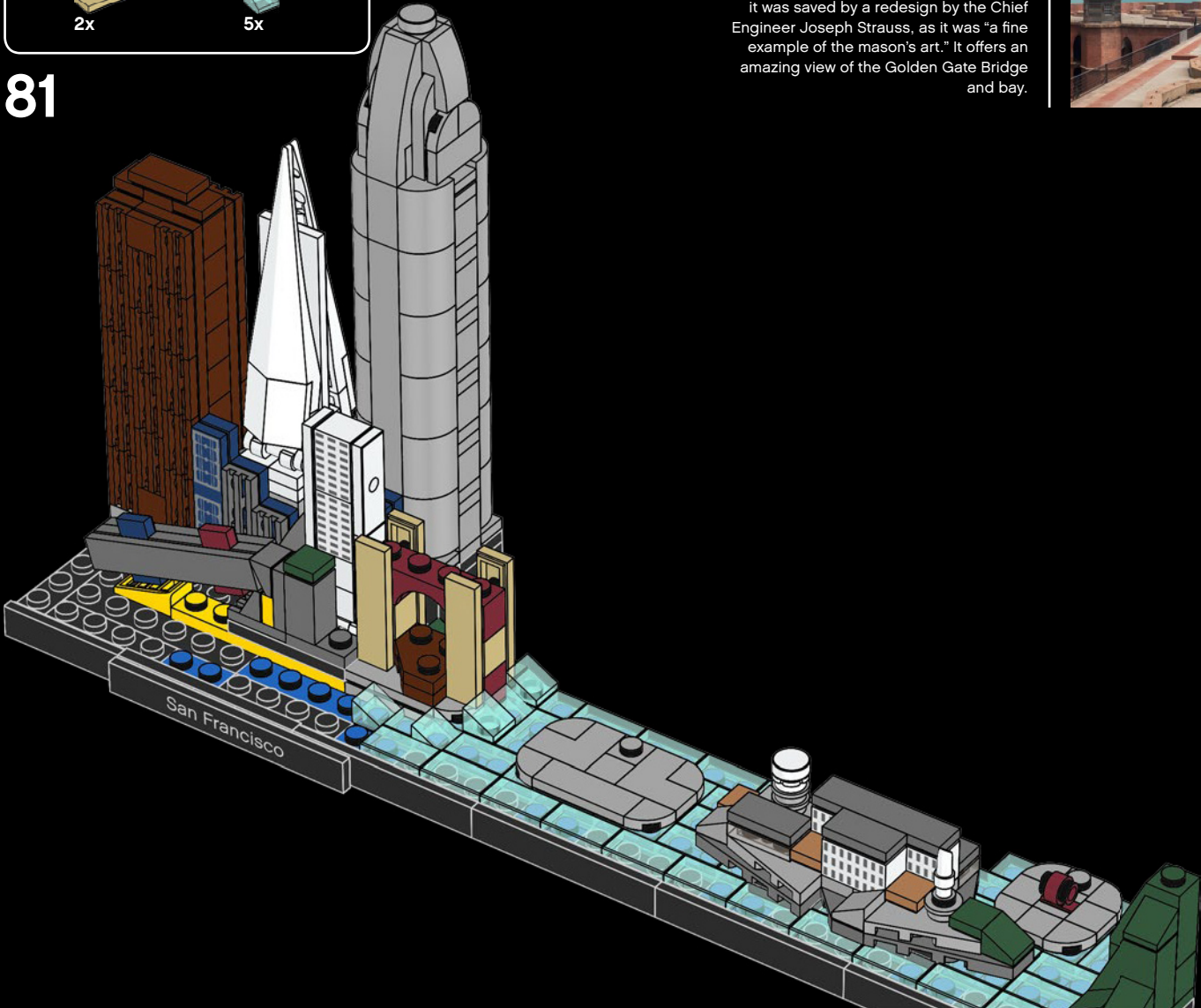

View of the bridge

Original plans for the Golden Gate Bridge would have required the fort's removal, but it was saved by a redesign by the Chief Engineer Joseph Strauss, as it was "a fine example of the mason's art." It offers an amazing view of the Golden Gate Bridge and bay.



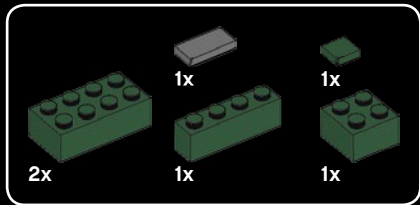

82

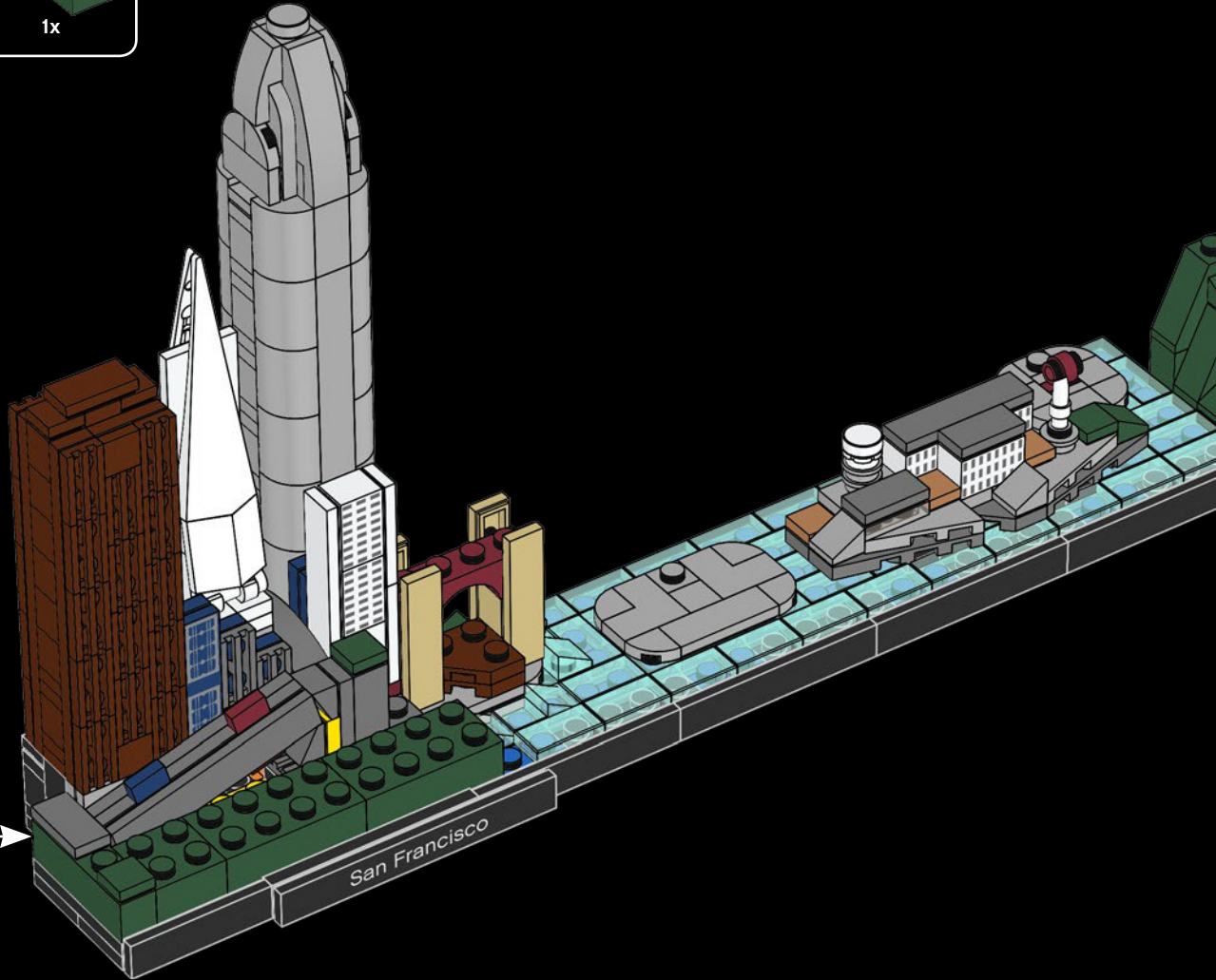
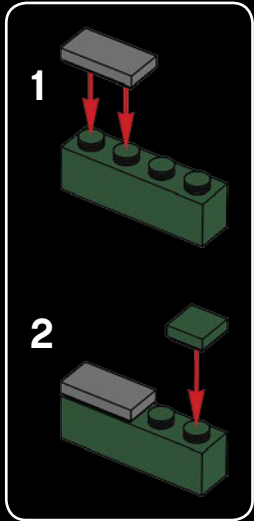

- 1x
- 2x
- 2x
- 1x
- 2x
- 2x

83

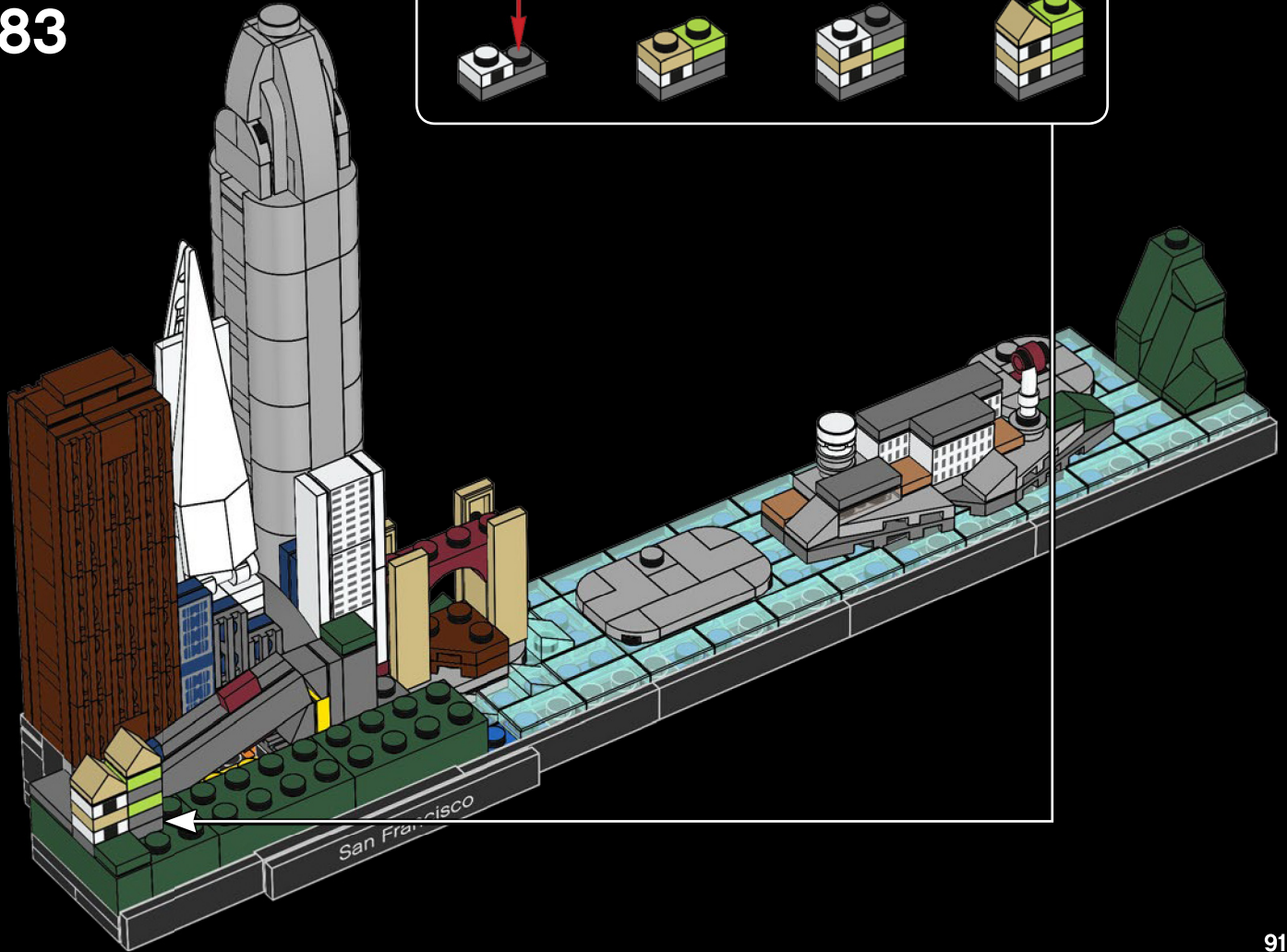
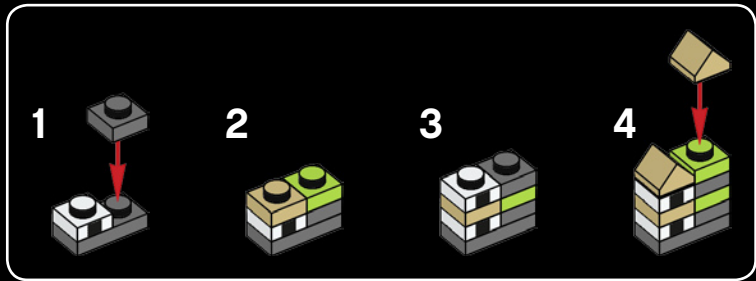



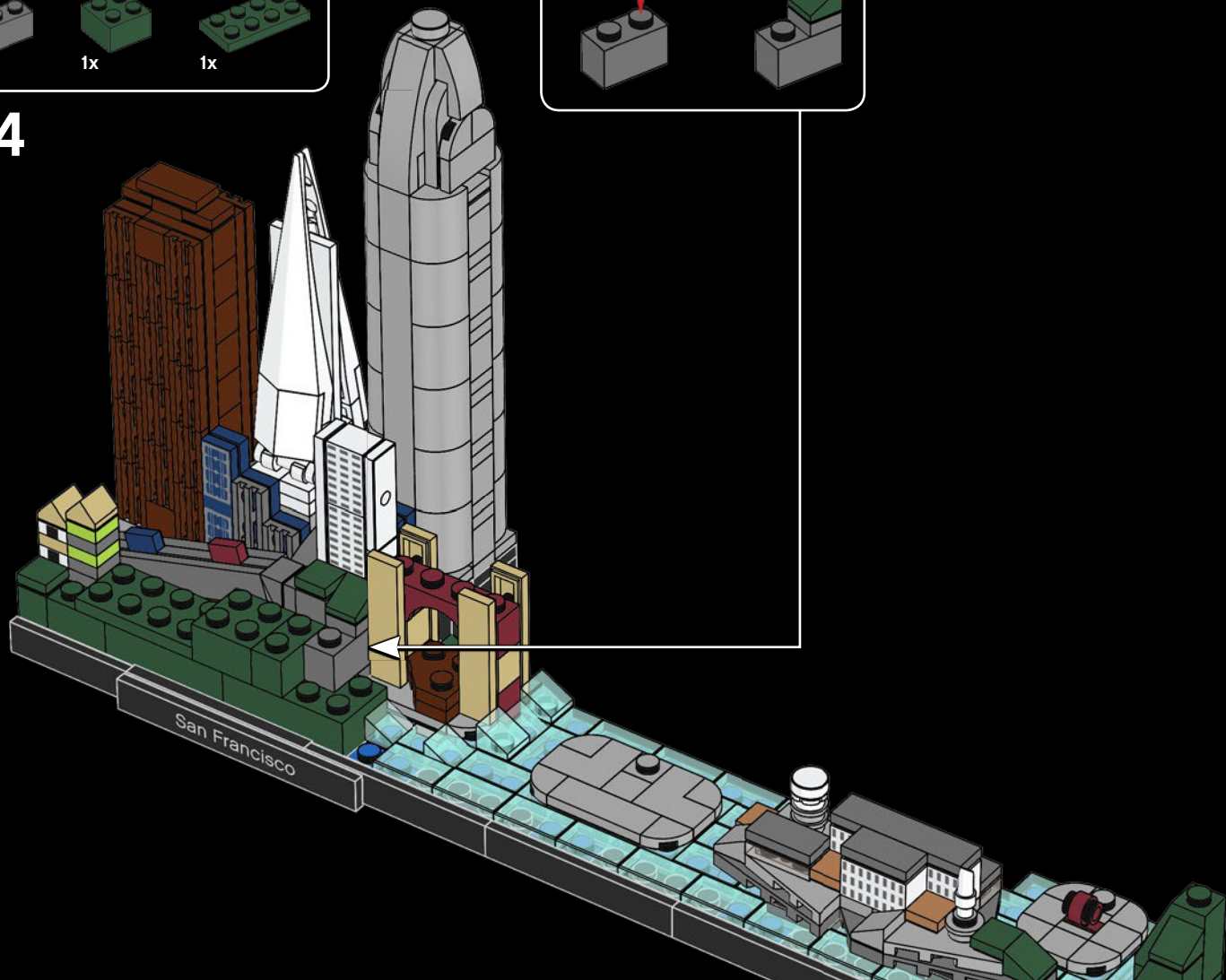
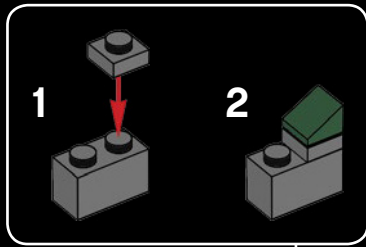
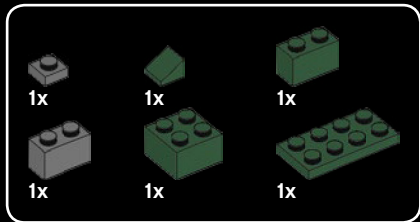

84



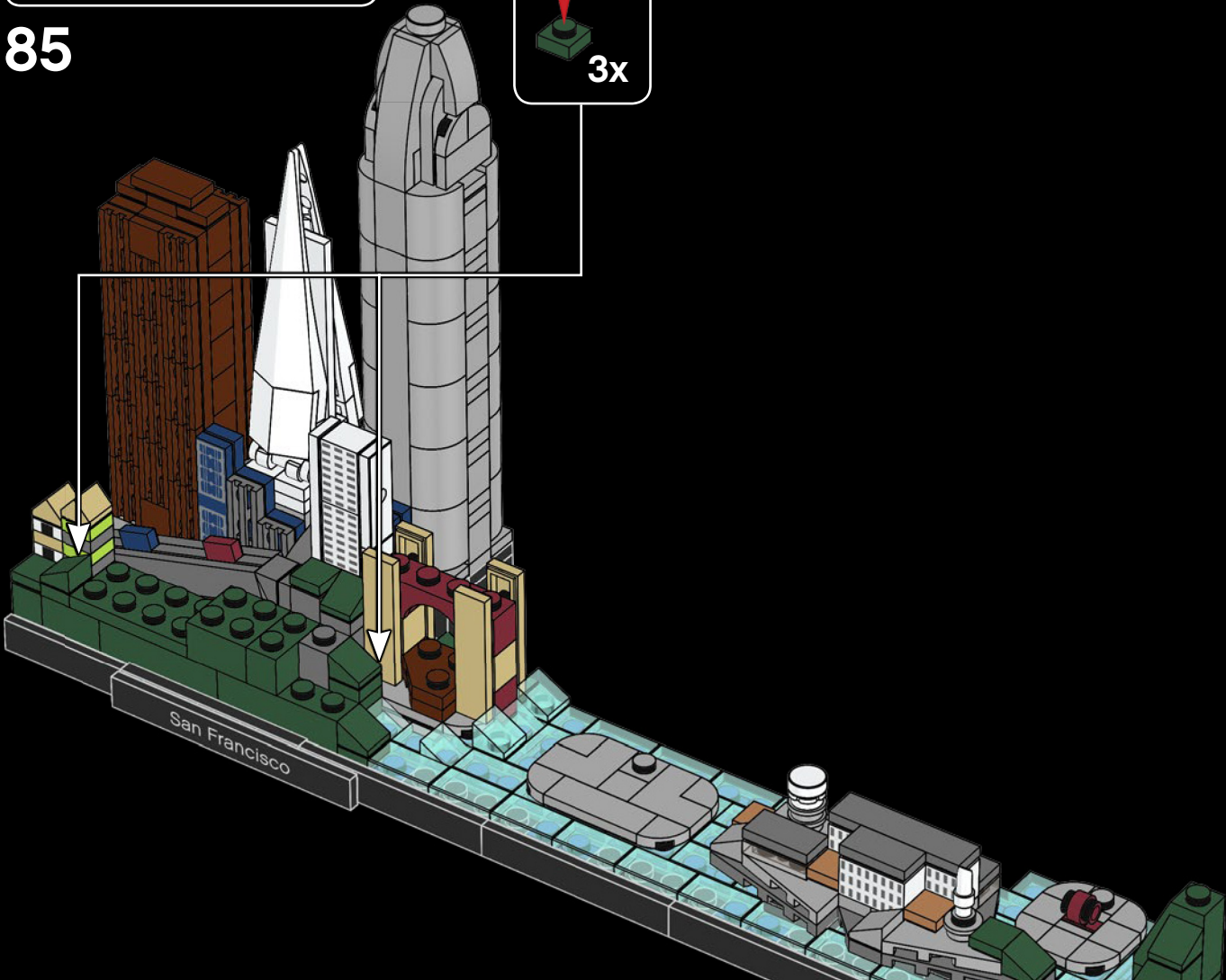
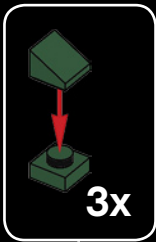



85

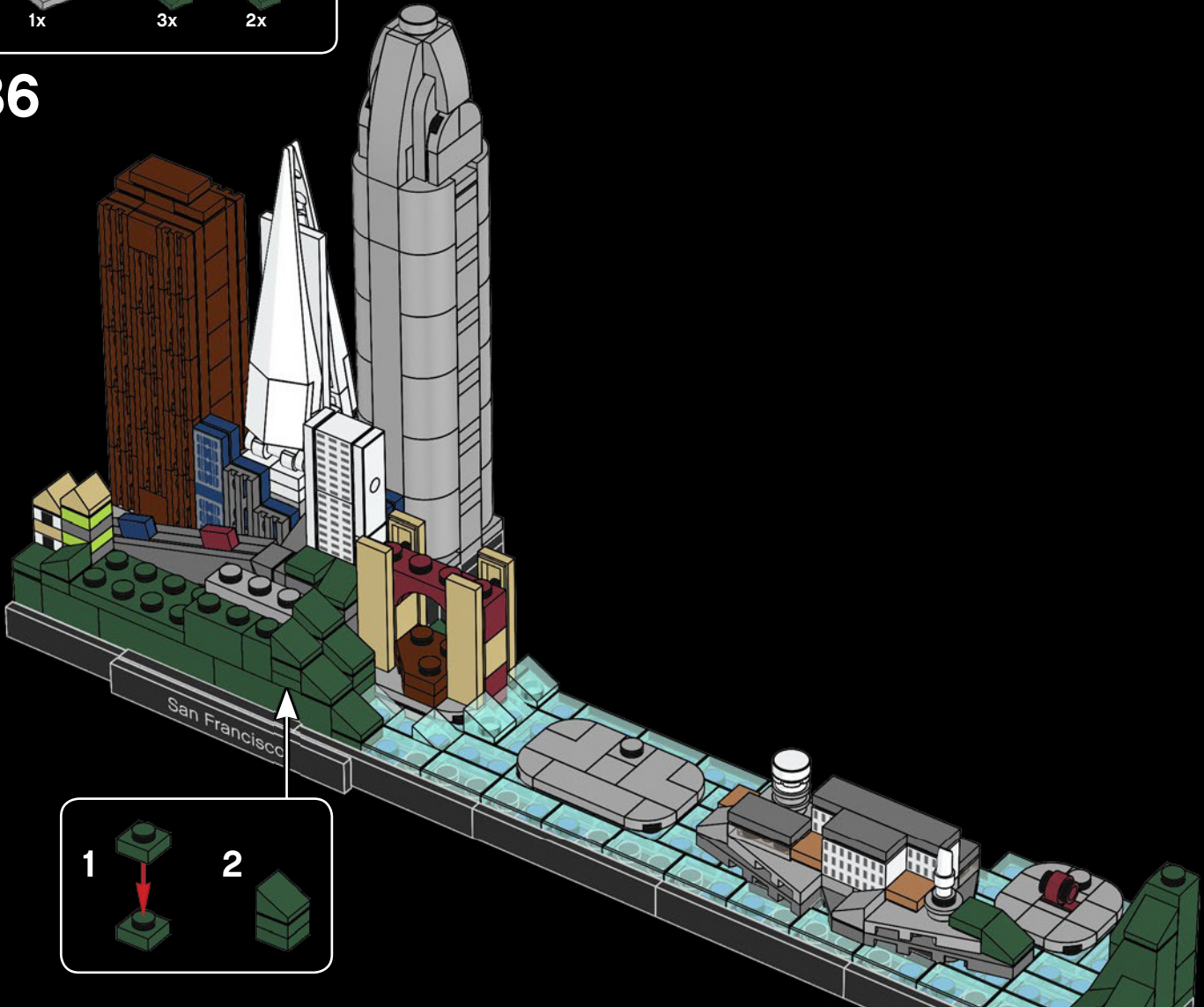

1x  3x  2x 

86



1  2 

A callout box showing two steps for assembly. Step 1 shows a red arrow pointing down from a green 1x2 Technic brick with a hole to a grey 1x2 Technic brick with a hole. Step 2 shows a green 1x2 Technic brick with a hole being placed on top of the grey brick.



87



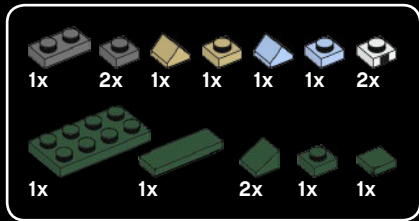

88

1

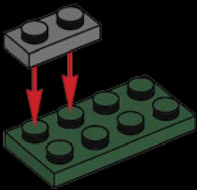

2

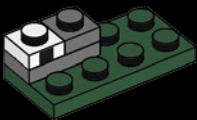

3

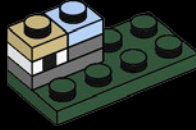

4

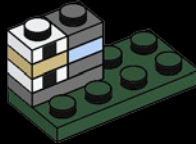

5



6



7



The Color of Money

Painted Ladies consist of thousands of similarly painted houses that, with their opulent colors and elaborate decorations, symbolize the new money that came with the Gold Rush Era.

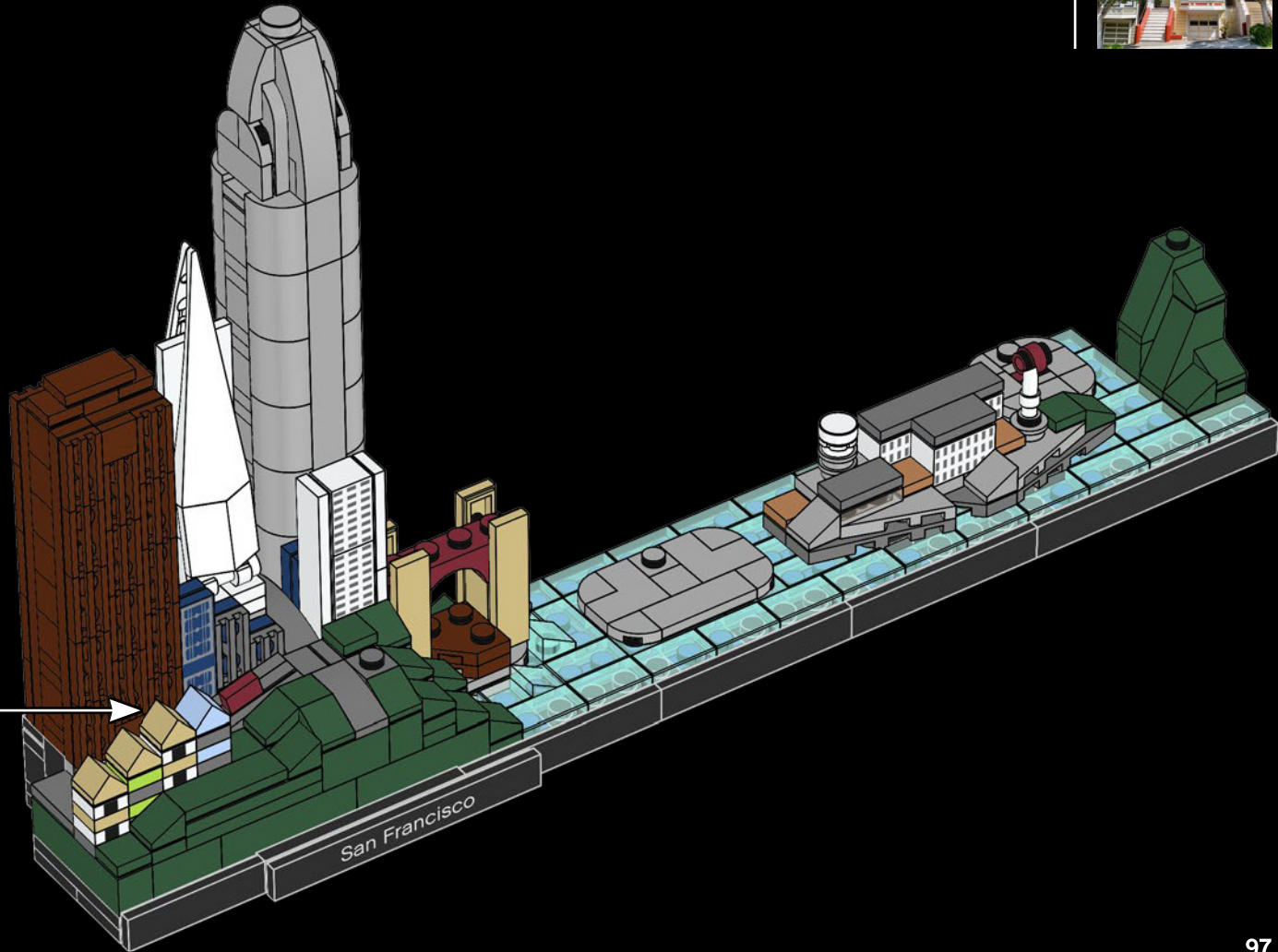



2x



1x



1x



1x

89

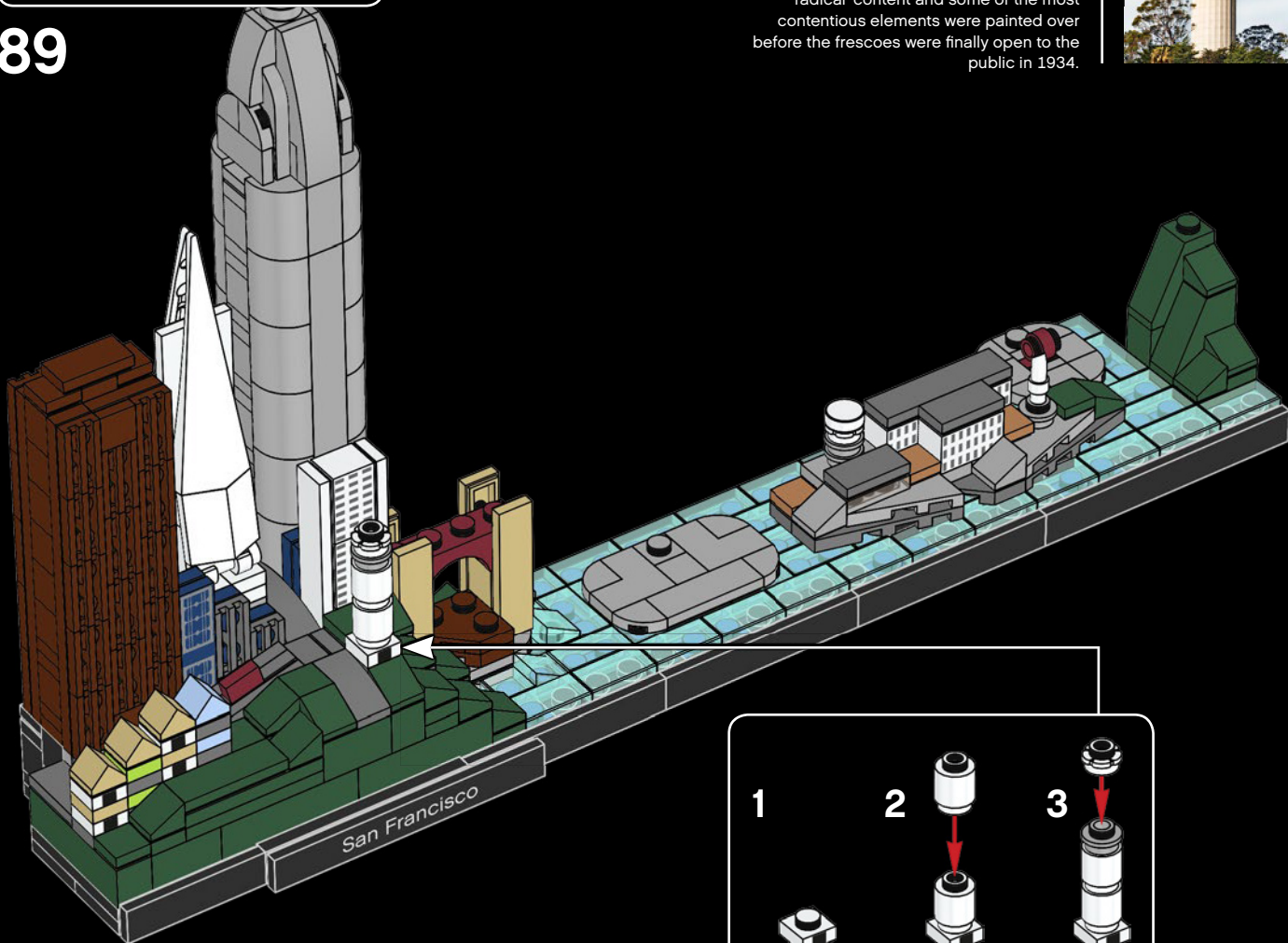

Artistic Controversy

Over 27 different artists decorated the Coit Tower with fresco murals depicting California life in the 1930s. At the time, there was some controversy over the murals' 'radical' content and some of the most contentious elements were painted over before the frescoes were finally open to the public in 1934.

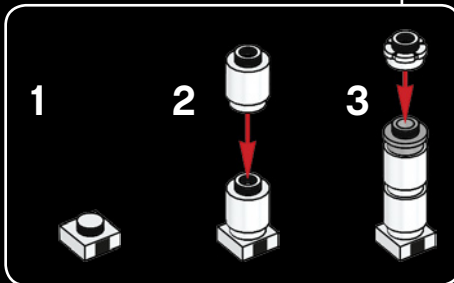

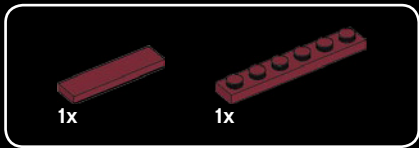

90

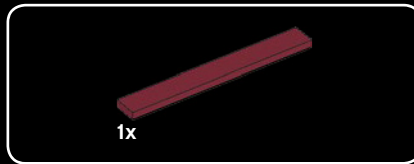
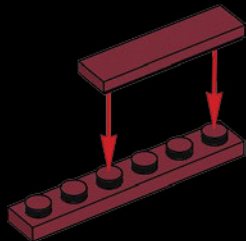

91

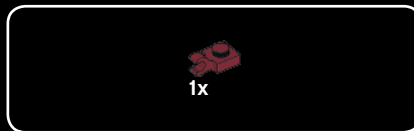
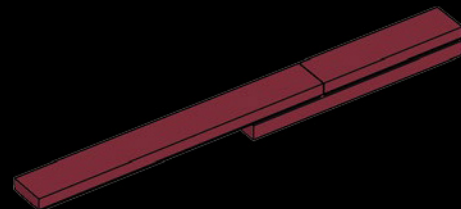

92

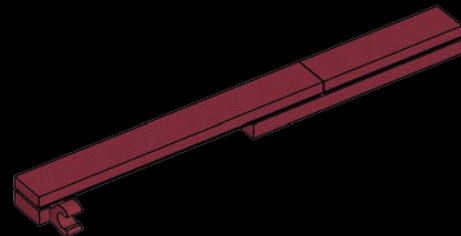

93

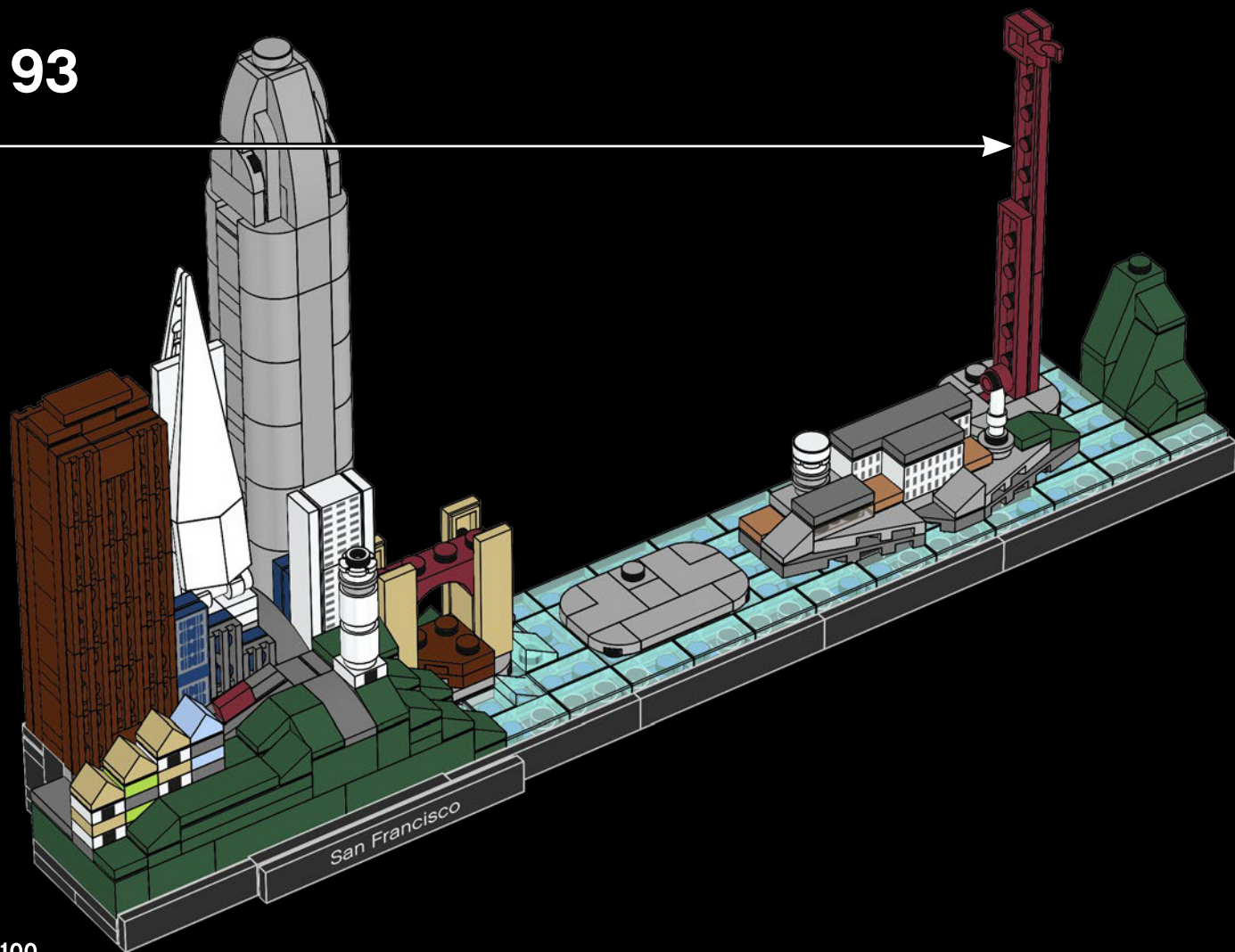

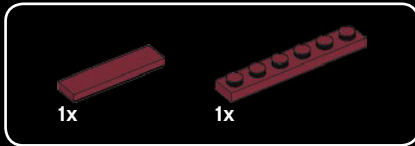
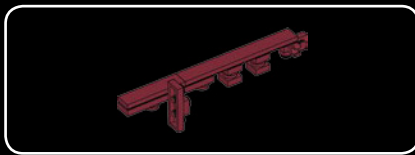

94

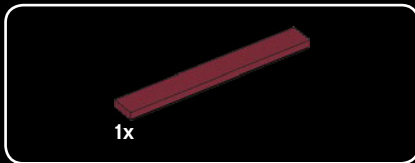
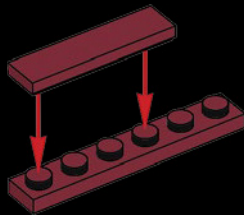

95

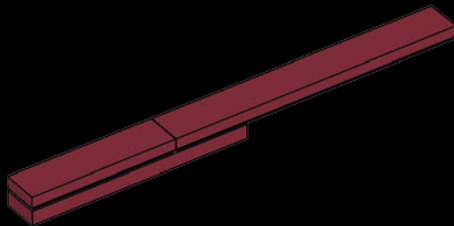

96

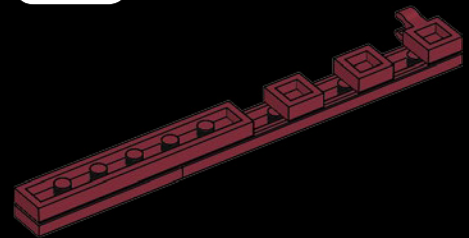
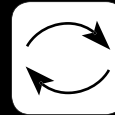

97

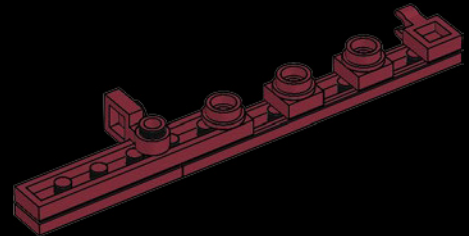

1x

98

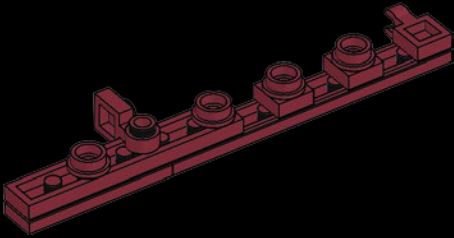

2x

1x

99

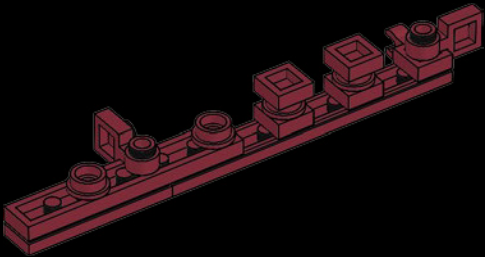

1x

100

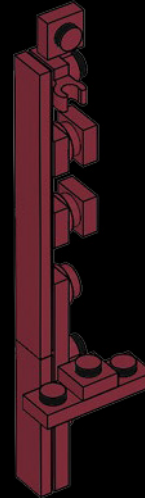
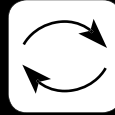

101

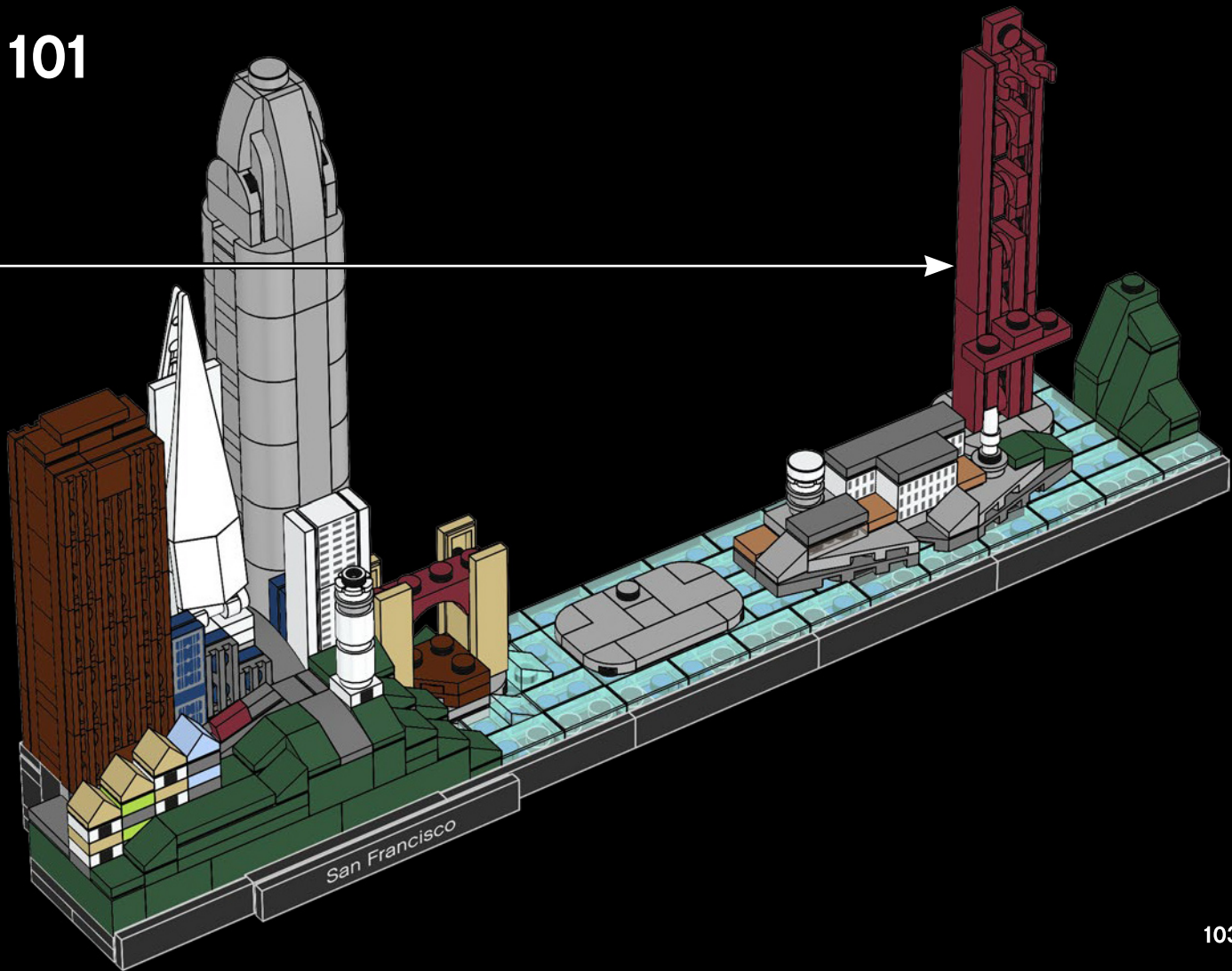

1x 1x 2x

102

1 2

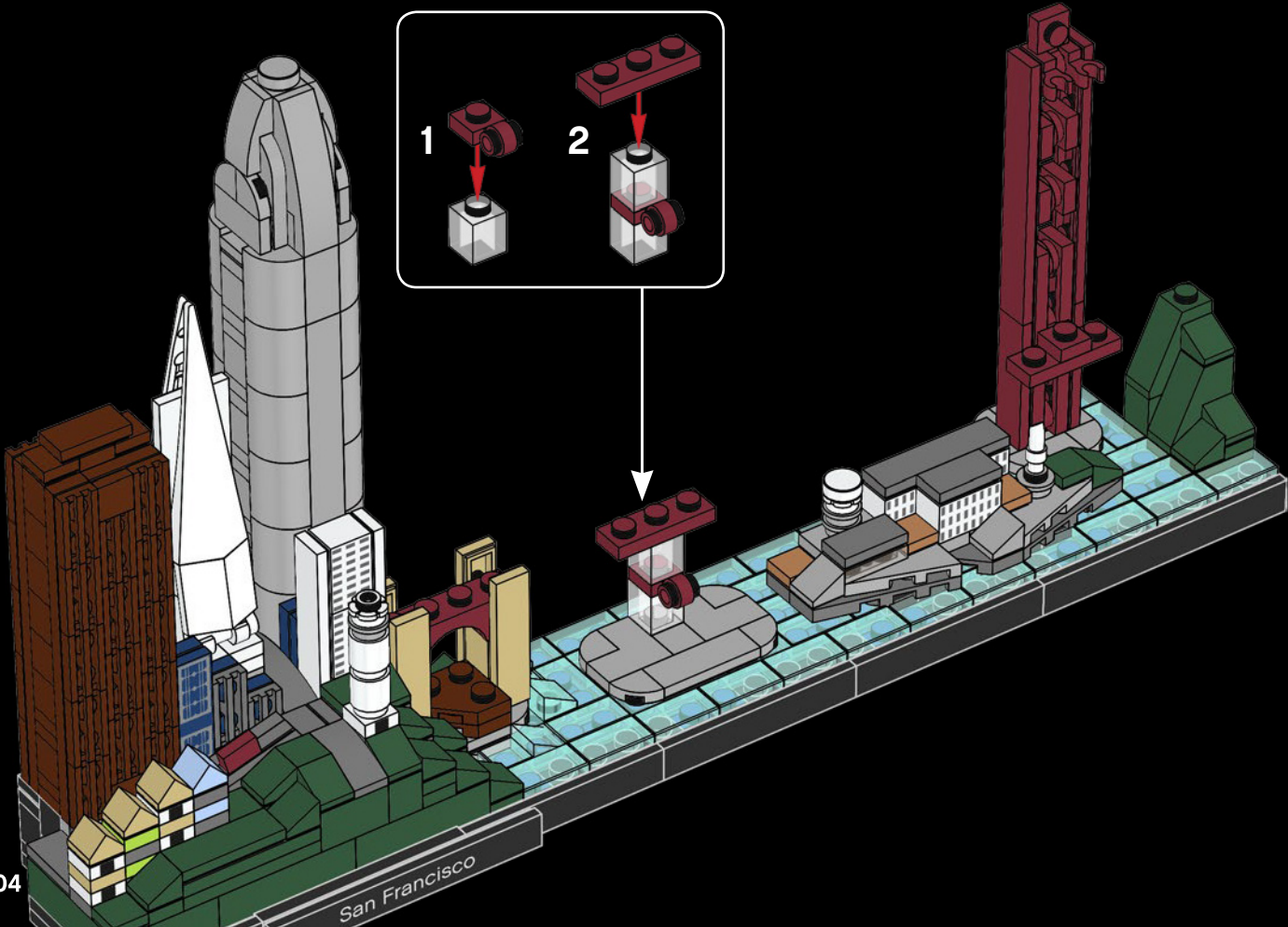

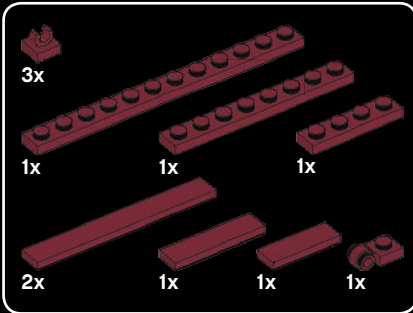
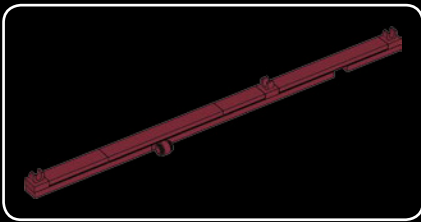

103

1

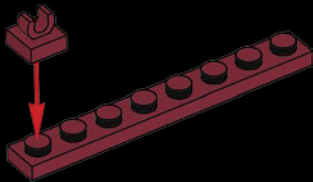

2

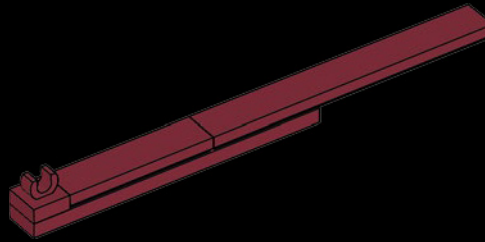

3

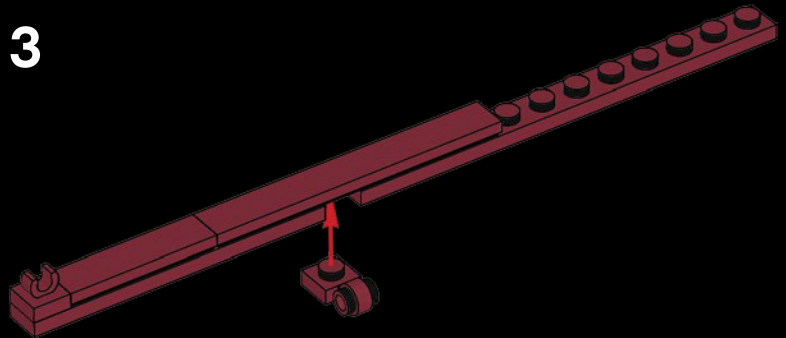

4

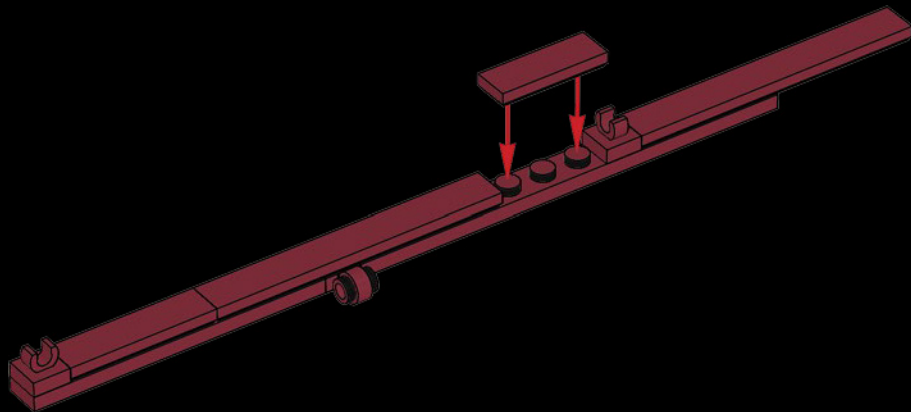

5

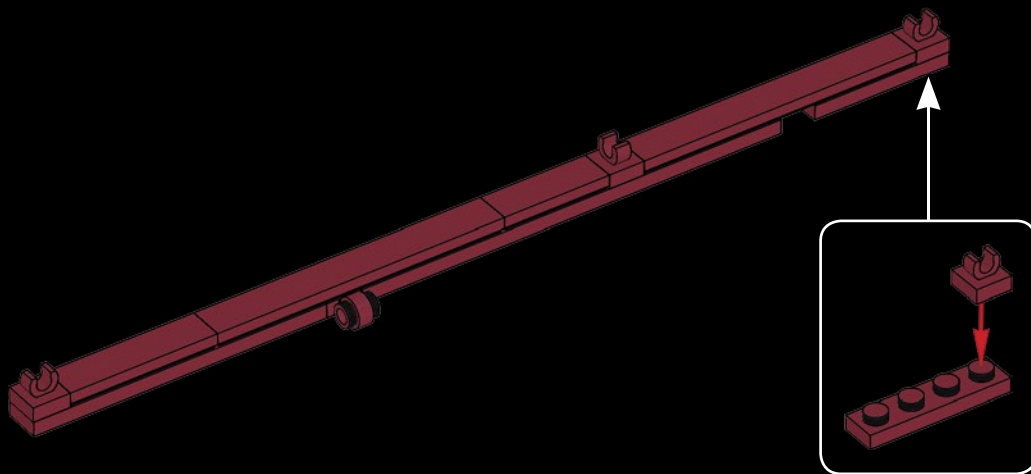

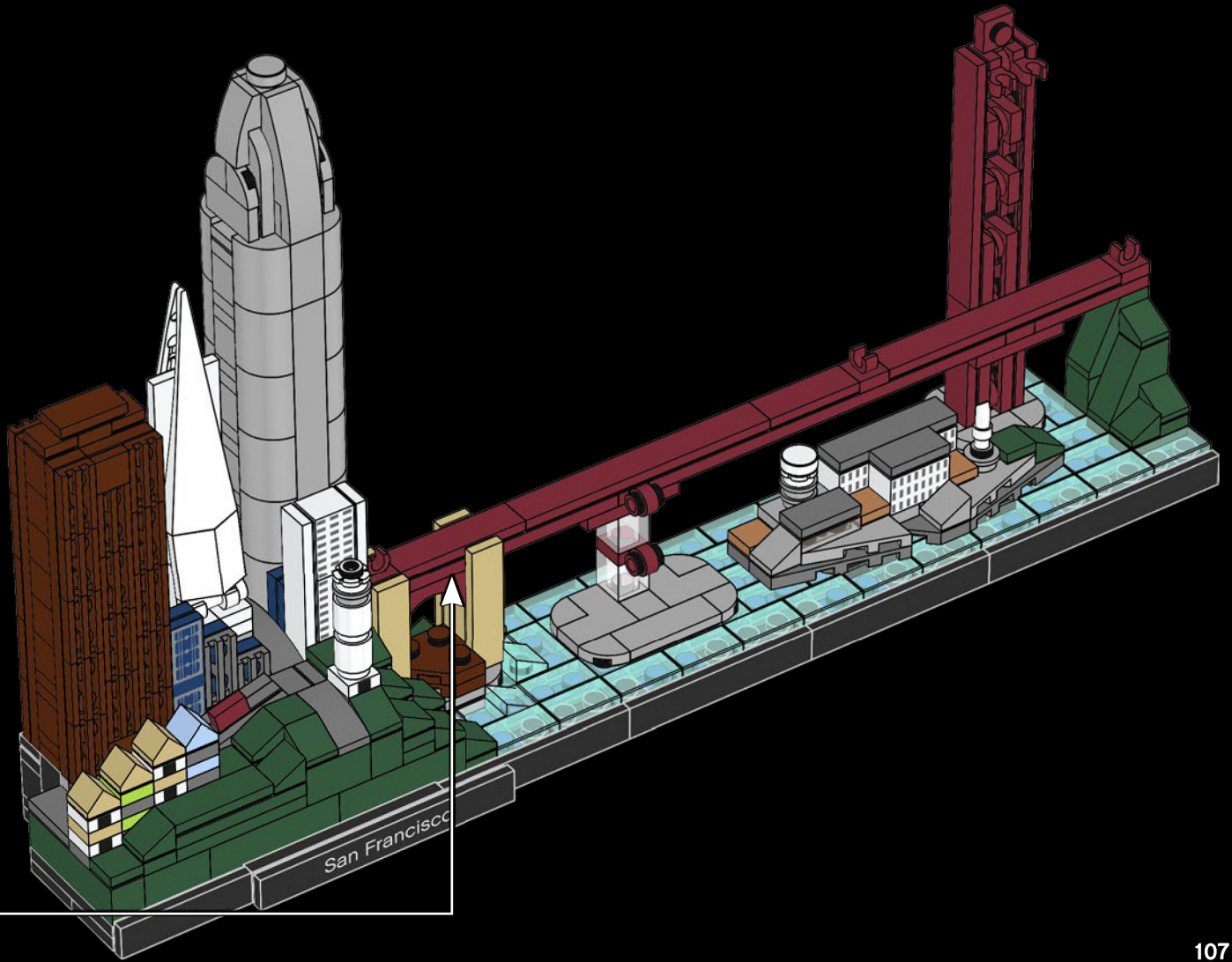

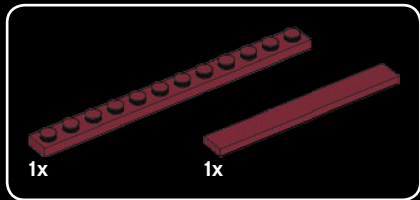

104

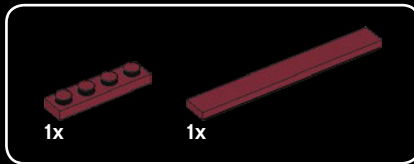
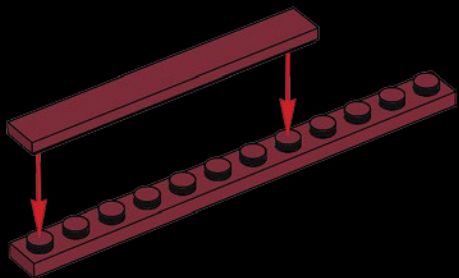

105

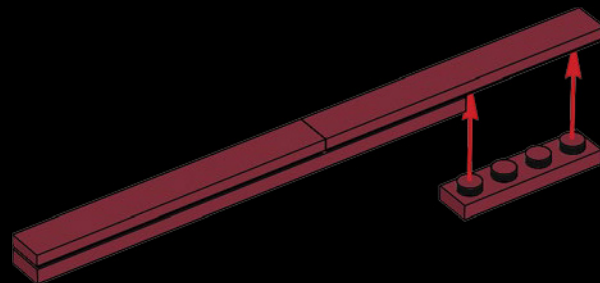

106

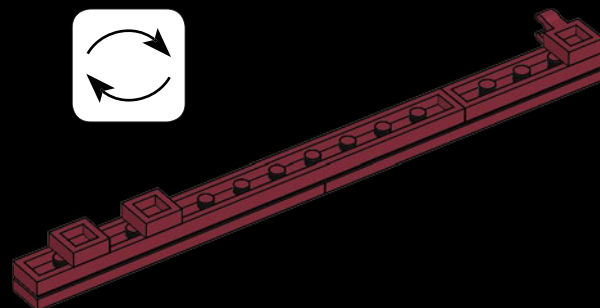
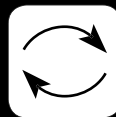

107

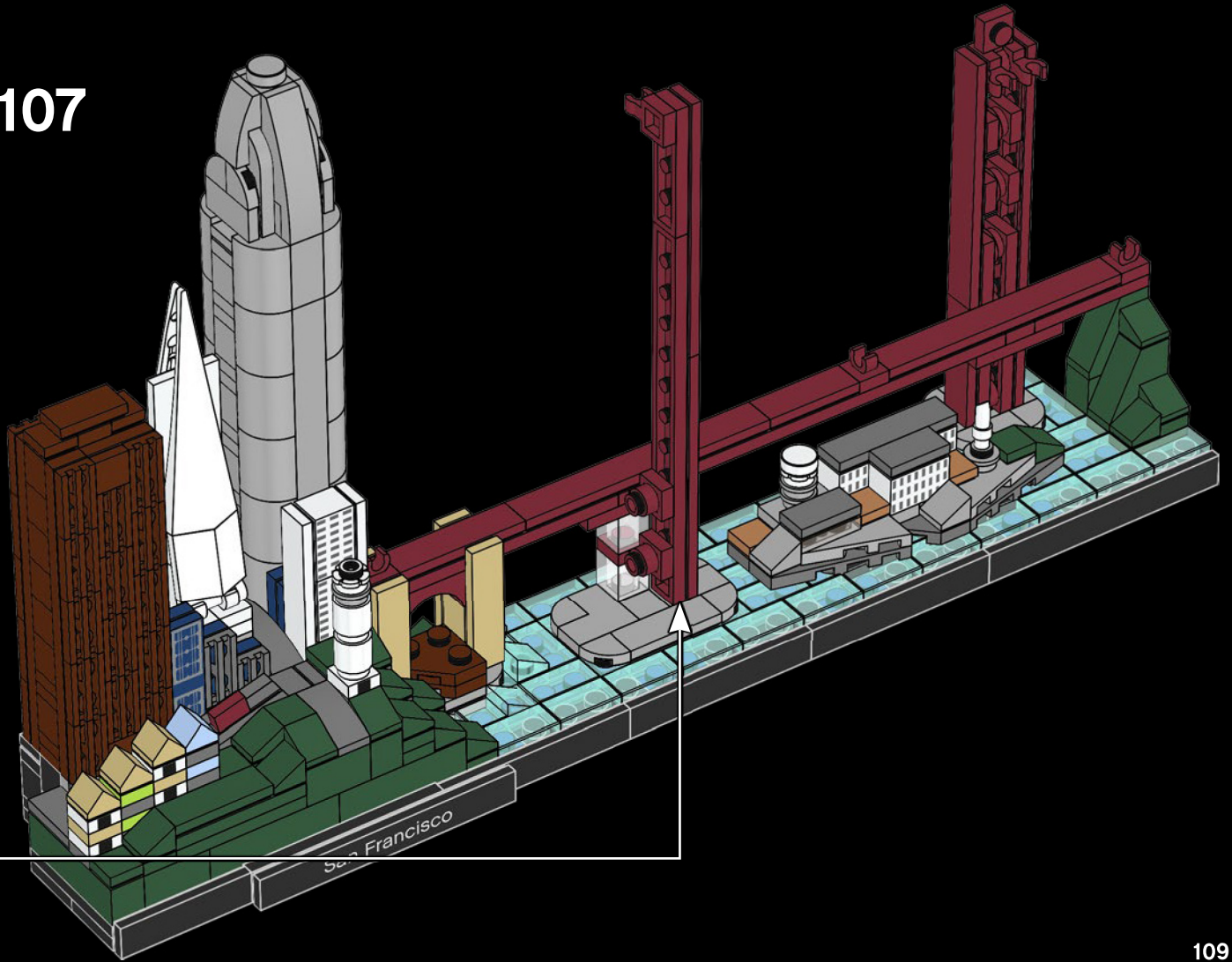

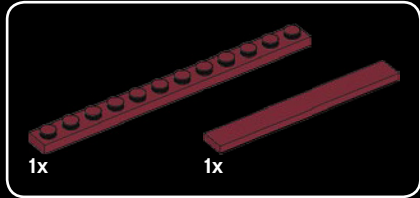
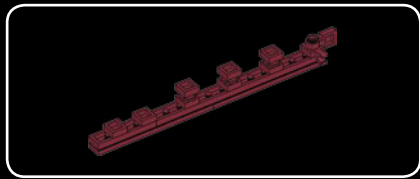

108

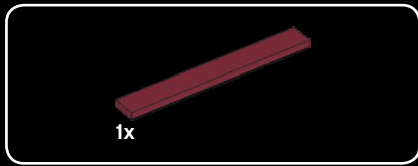
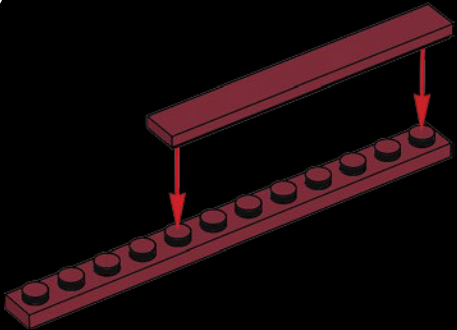

109

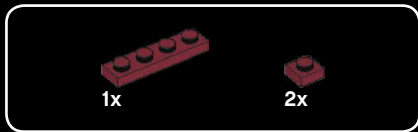
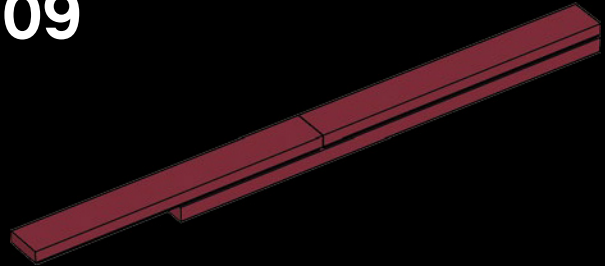

110

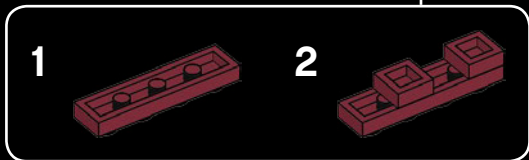
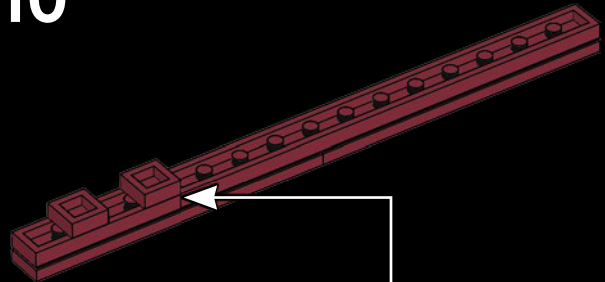

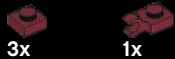

3x

1x

111

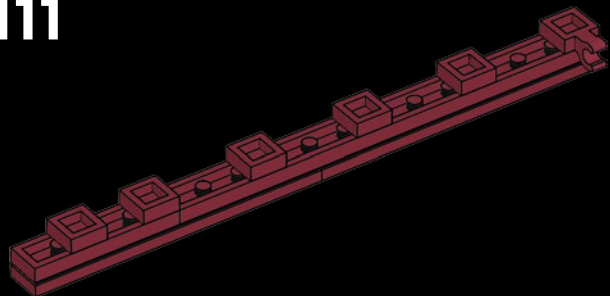

1x

3x

112

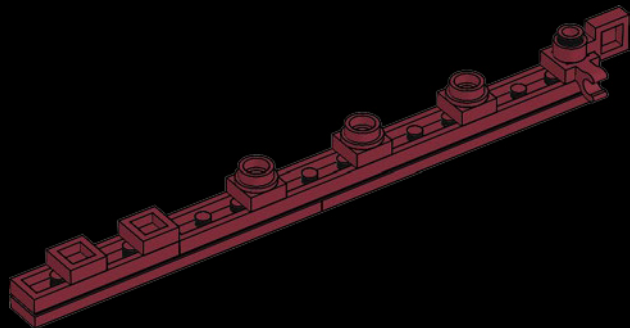

3x

113

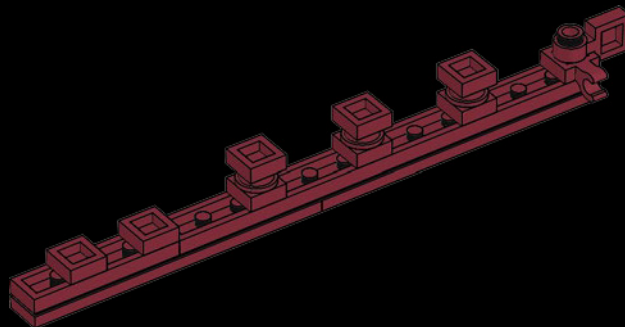

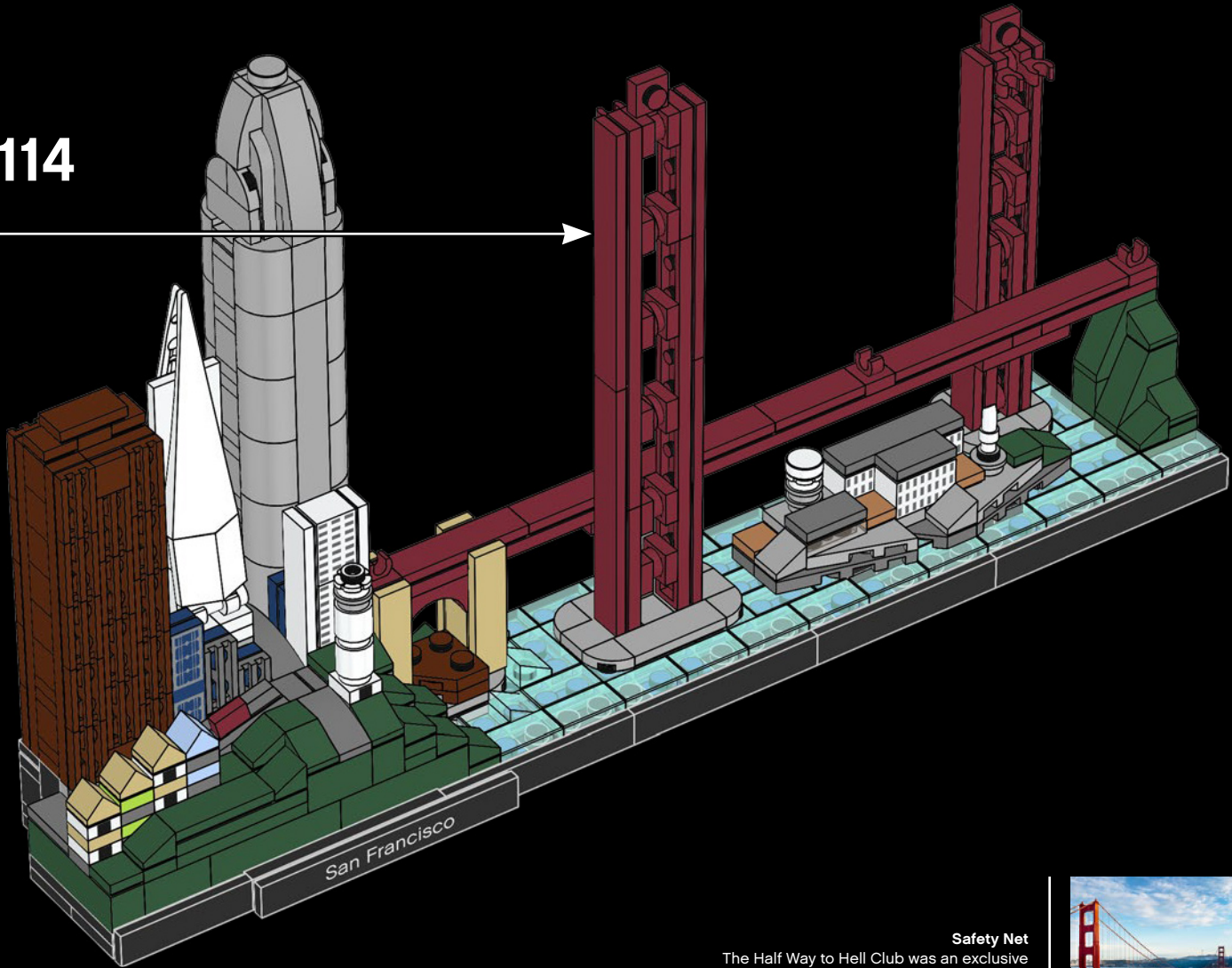
**Safety Net**

The Half Way to Hell Club was an exclusive club organized by the men who fell from the Golden Gate Bridge during its construction in 1936 and 1937 and were saved by the safety nets.



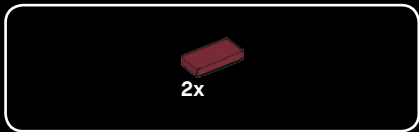

115

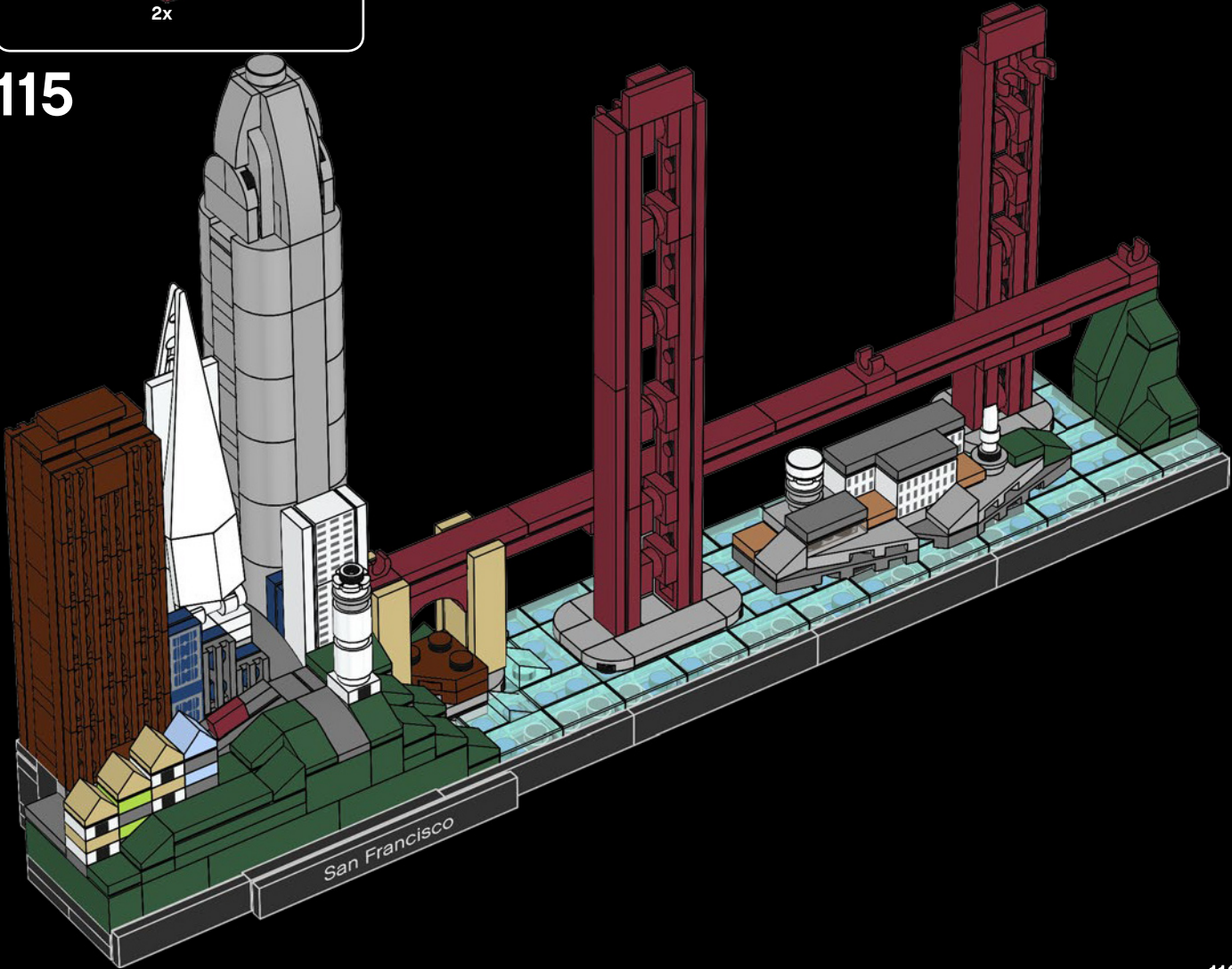

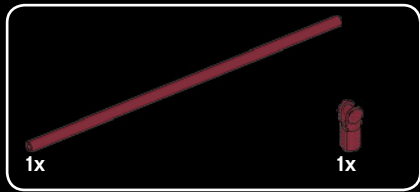

116



117

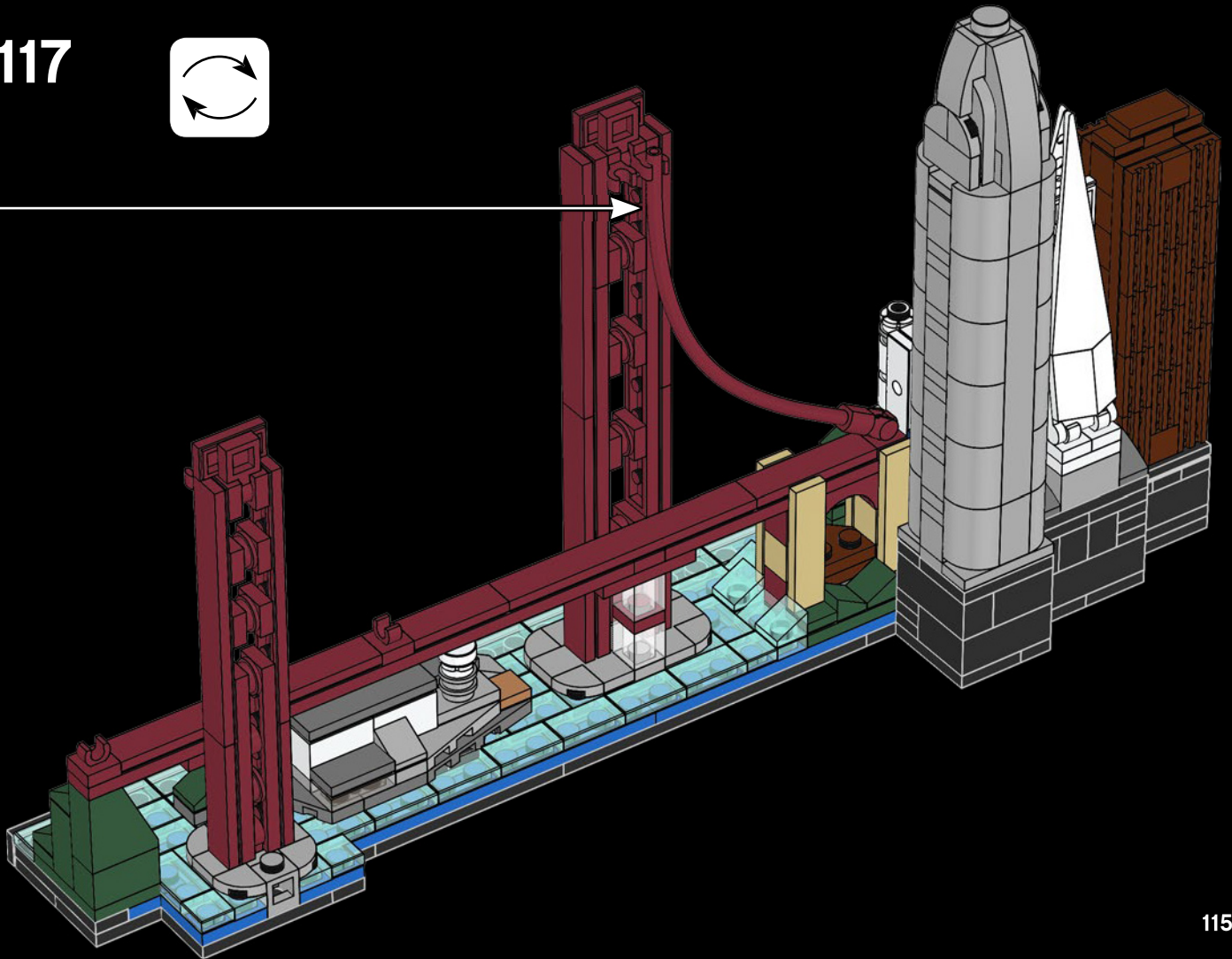
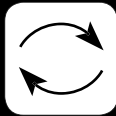

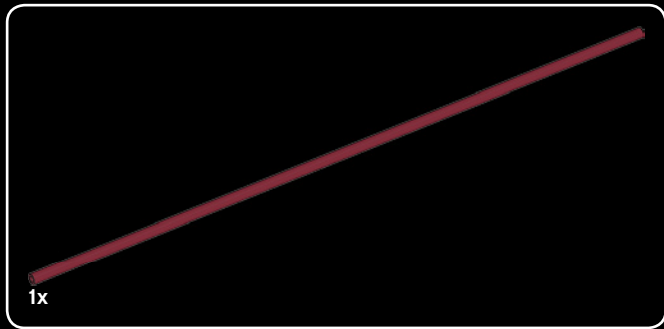

118

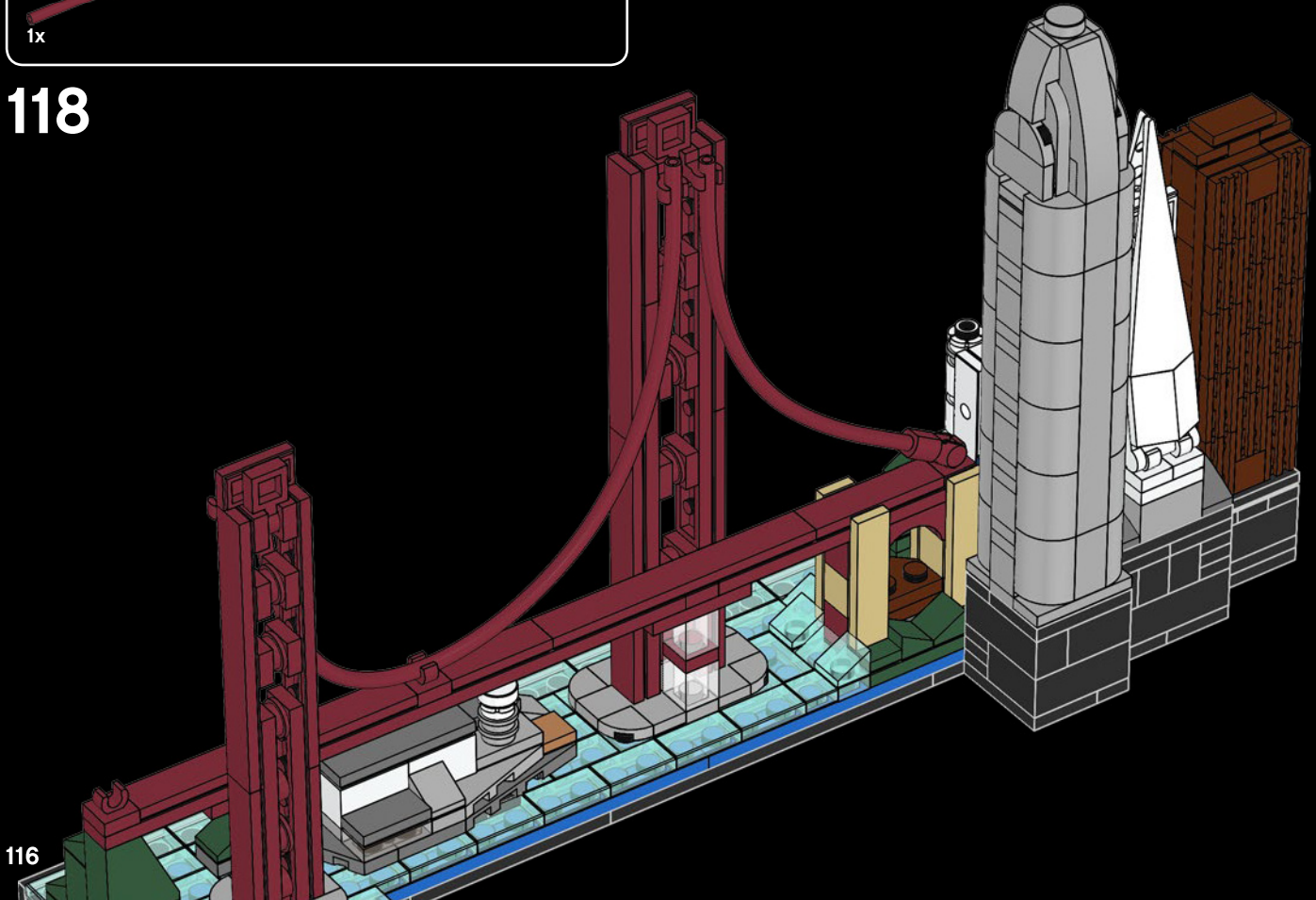

116

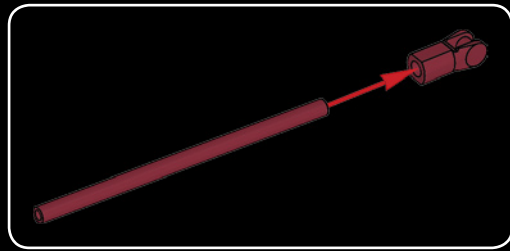
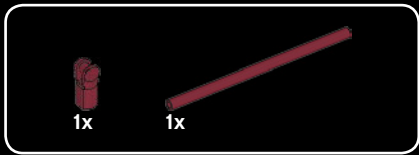

119

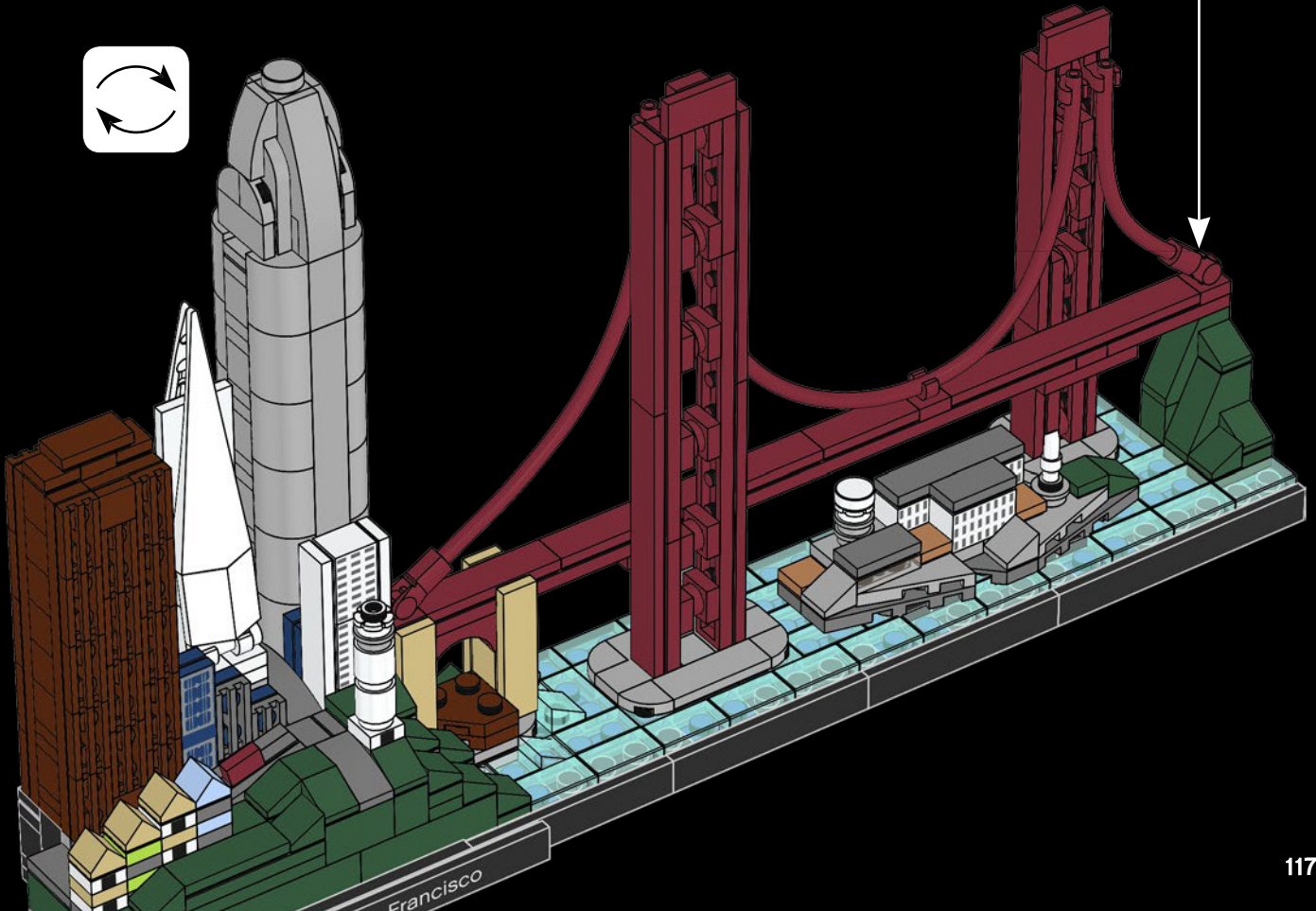



LEGO® Architecture – do you like it?

The LEGO Group would like your opinion on the new product you have just purchased. Your feedback will help shape the future development of this product series. Please visit:

[LEGO.com/productfeedback](https://www.lego.com/productfeedback)

By completing our short feedback survey, you will be automatically entered into a drawing to win a LEGO® prize.





Terms & Conditions apply.

LEGO® Architecture

The LEGO® Architecture series creatively captures the essence of many of the world's most iconic landmarks while giving you an enjoyable and engaging LEGO building experience.

Whether your interest is in travel, design, history or architecture, these sets are a physical memento of a great trip abroad, a famous building you know well, or a city you still dream of visiting.

Every LEGO Architecture set is designed to be displayed. Much more than just a photo, building and displaying your model on your desk, in the bookcase or on the shelf, lets you be transported every time you admire the view.

Follow us on  

Adam Reed Tucker is the co-developer of the LEGO Architecture product line.



Celebrate the world of architecture
and collect all the models



21041
Great Wall of China



21030
United States
Capitol Building



21042
Statue of Liberty

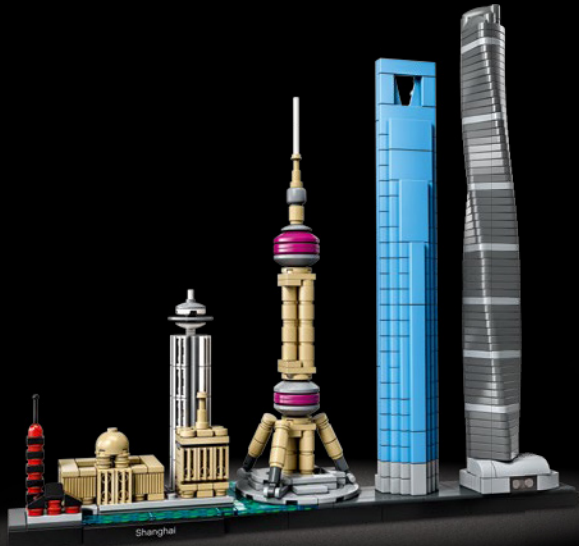

21039
Shanghai



21047
Las Vegas



21034
London



21028
New York City

References

Pictures -

© GettyImages

Customer Service
Kundenservice
Service Consommateurs
Servicio Al Consumidor
LEGO.com/service or dial

 00800 5346 5555 ;
 1-800-422-5346 ;



1



2



3

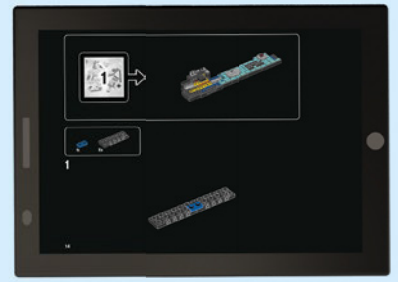

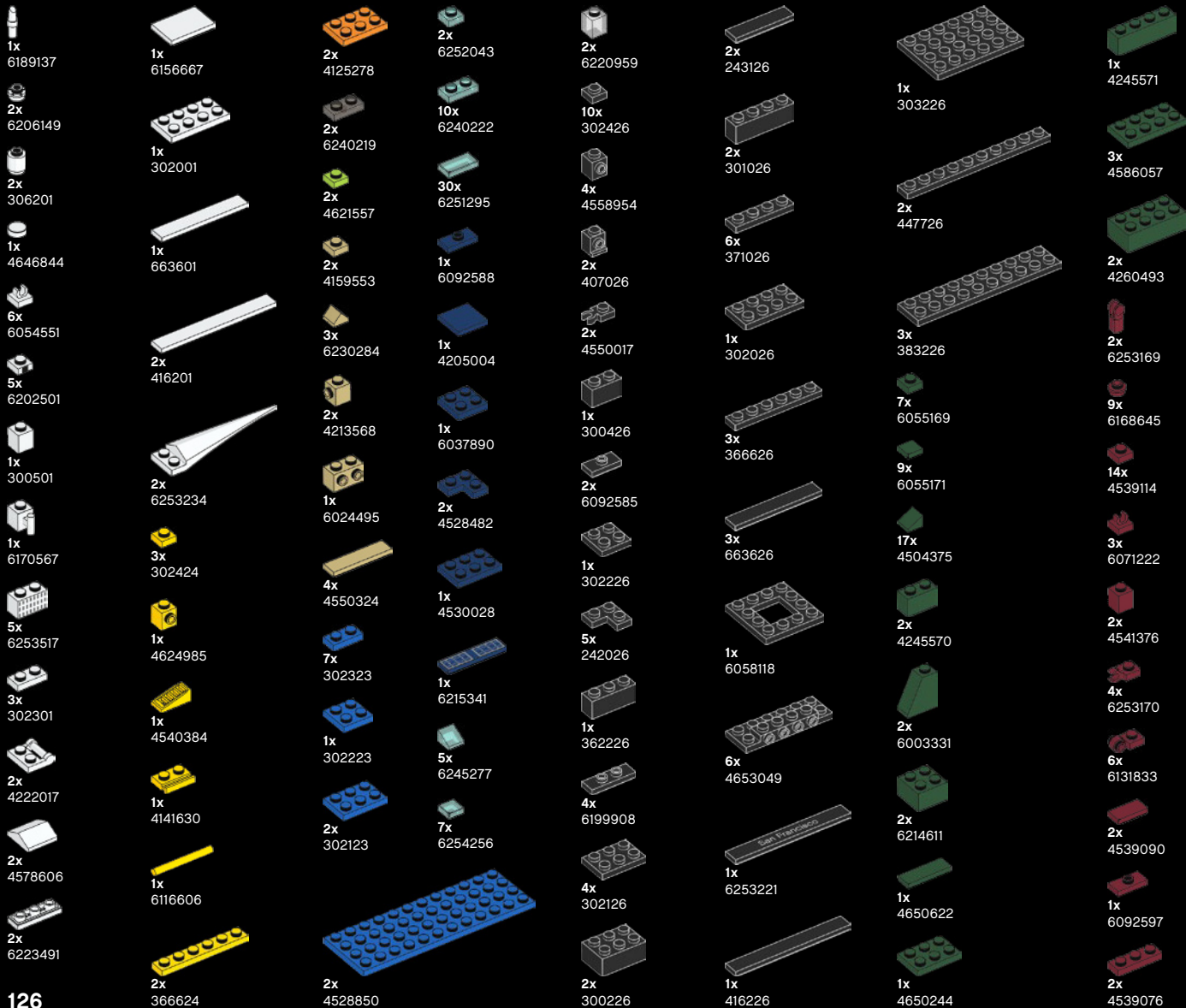



1x
6146854



3x
4539060



3x
4539061



2x
4539062



1x
6256143



8x
4539083



1x
4541507



3x
6253142



1x
6256144

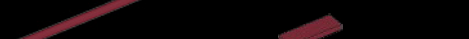

1x
6256145



8x
6253167



3x
6066142



28x
4224243



2x
6218366



1x
4211151



2x
4211152



4x
4211220



2x
4223683



2x
4211214



1x
4583299



6x
4221744



6x
4211288



2x
4650260



4x
6168647



13x
6176433



3x
4211399



3x
4521921



3x
4211476



9x
4211415



2x
4211511



6x
4213567



2x
4211791



1x
4211794



6x
4657459



2x
6028813



24x
6227184



2x
6066097



7x
4211414



1x
6015344



1x
4211353



2x
6065824



1x
6211969



18x
4211429



3x
4558169



2x
4211419



2x
6042950



2x
4211481

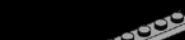

4x
4251149



2x
4504378



9x
4210719



1x
6228923



1x
6143417



1x
4210788



1x
4246896



2x
4210782



3x
4210631



1x
6164073



4x
4211052



1x
4211088



9x
4211063



1x
6029948



1x
4648256



1x
4211094



1x
4211053



2x
4211056



1x
4210651



1x
6184484



1x
6228085



3x
6177146



Customer Service

Kundenservice

Service Consommateurs

Servicio Al Consumidor

LEGO.com/service or dial



: 00800 5346 5555

: 1-800-422-5346

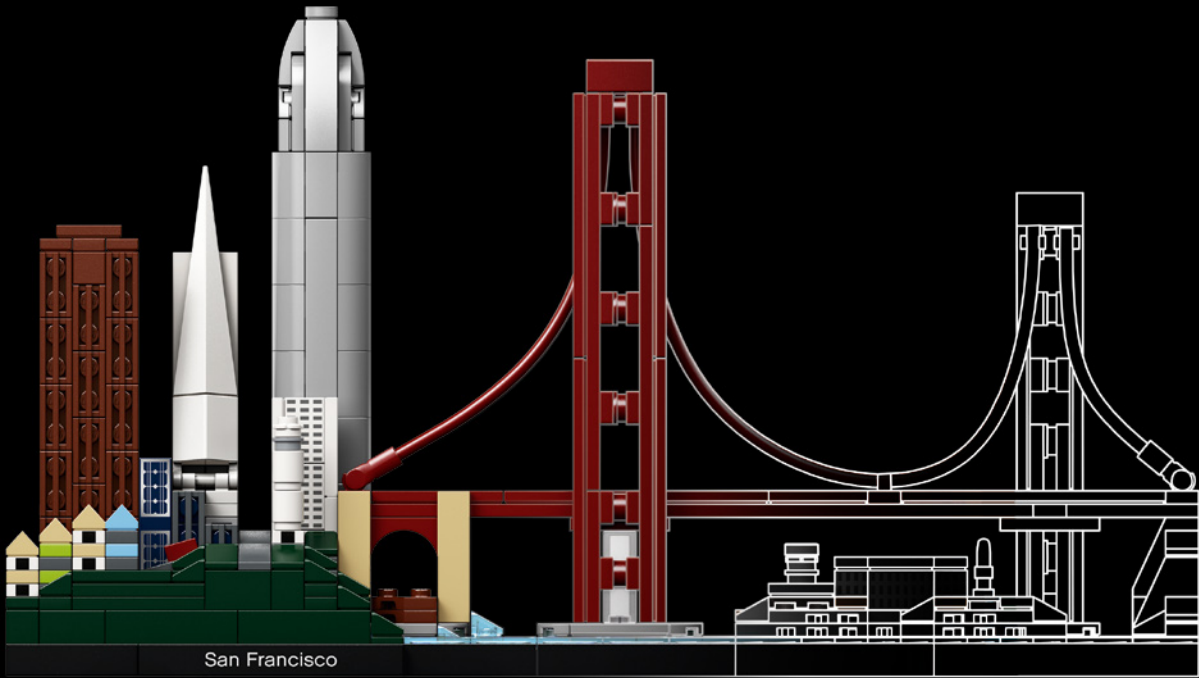

San Francisco

LEGO and the LEGO logo are trademarks of the LEGO Group.
©2019 The LEGO Group. 6268685

The Transamerica Pyramid Building is a registered service mark of Transamerica Corporation and is being used with permission.

 [LEGO.com/architecture](https://www.lego.com/architecture)

Follow LEGO® Architecture on

