



BRICK 'HEADZ

41634



THE
LEGO
MOVIE

EMMET

88





 LEGO.com/movie2



70823 70829 70830 70831



THE LEGO® MOVIE 2™ © & ™, Warner Bros. Entertainment Inc. & The LEGO Group. LEGO, the LEGO logo, DUPLO, the Minifigure and the Brick and Knob configurations are trademarks and/or copyrights of the LEGO Group. ©2019 The LEGO Group. All rights reserved. WB SHIELD: TM & © WBEI. (s19)



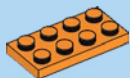

1x

1

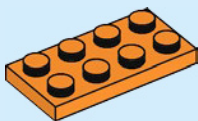

4

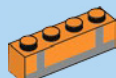

2x

2

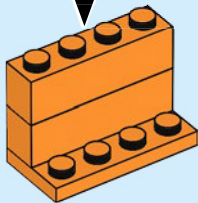
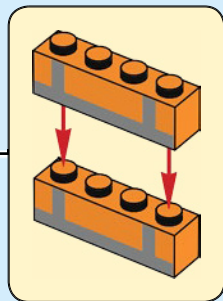



2x

3

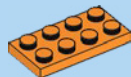
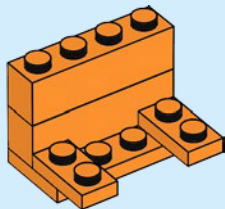

1x

4

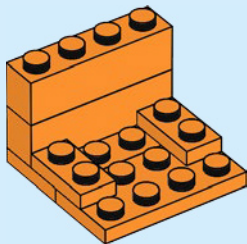

5



2x

5

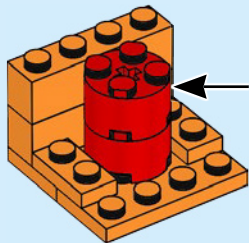
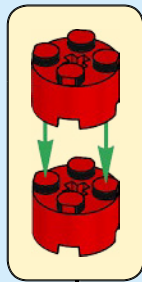

6



2x

6

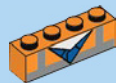
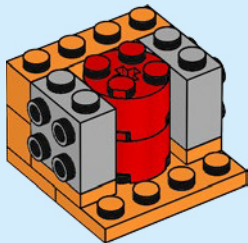

1x

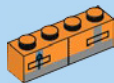

1x

7

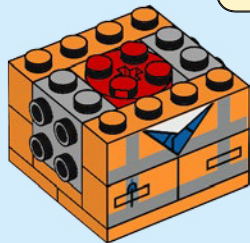
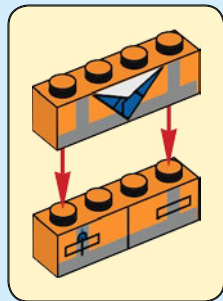



1x

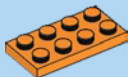

1x



2x

8

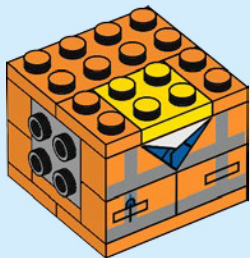

8

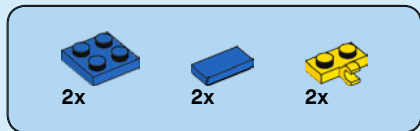

9

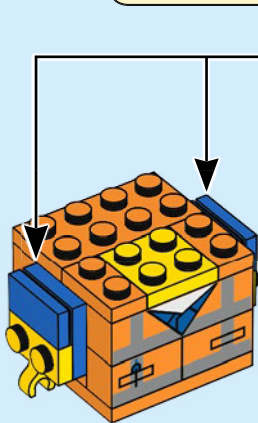
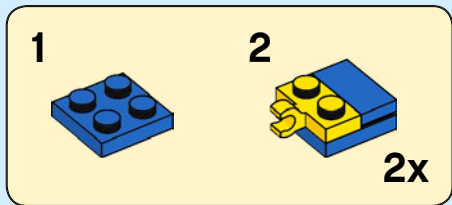



6x

10

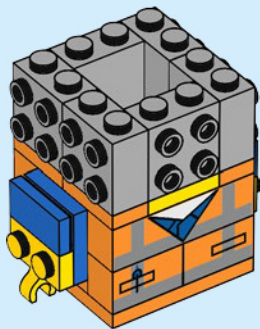

10

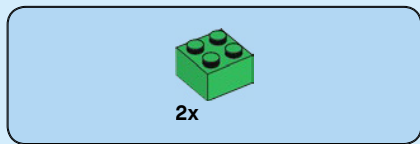

11

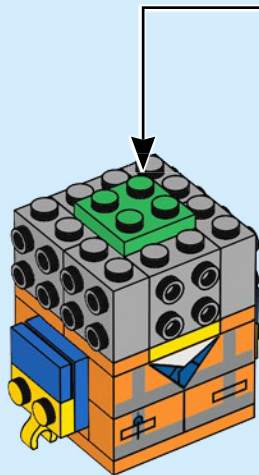
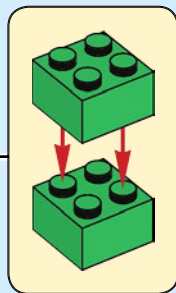



2x



4x

12

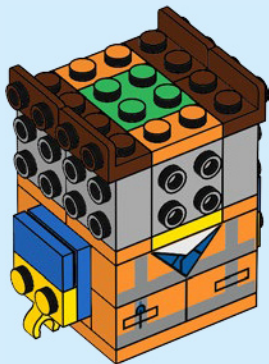

12

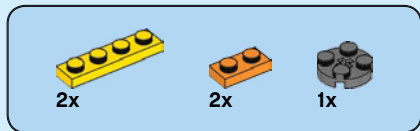

13

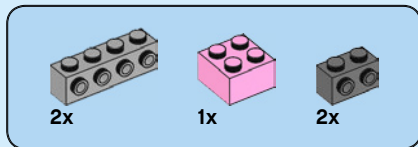
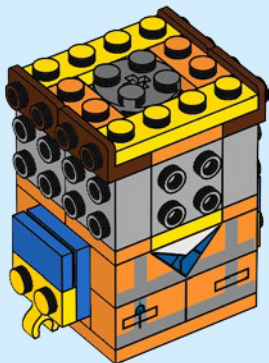

14

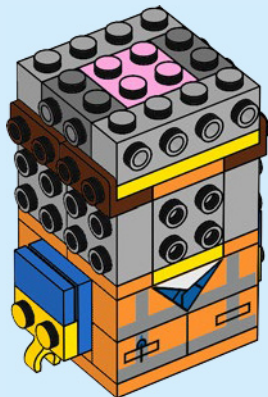



1x



1x



2x

15

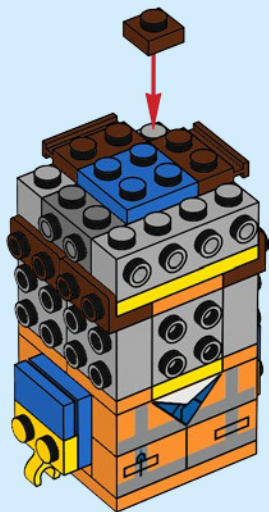

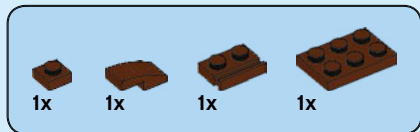

16

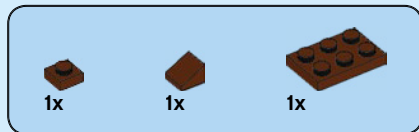
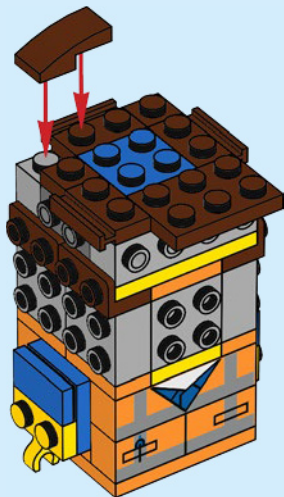

17

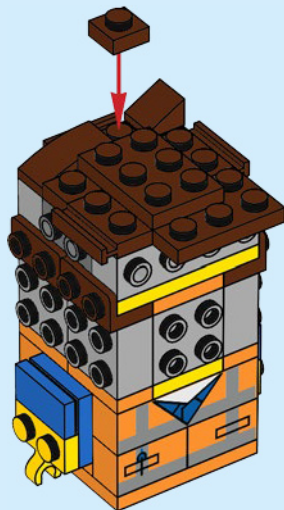



1x



1x



2x

18

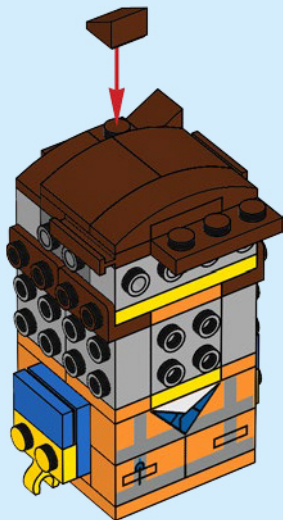

16



1x



1x

19

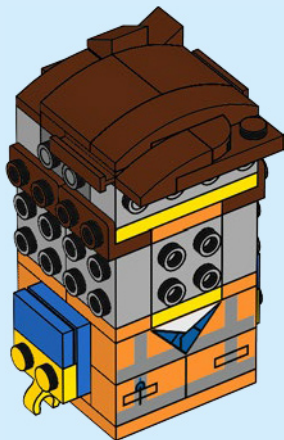

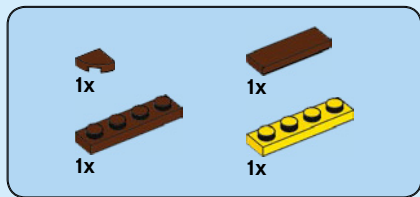

20

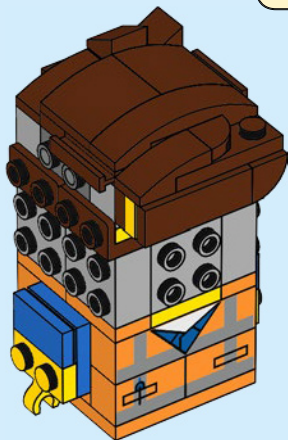
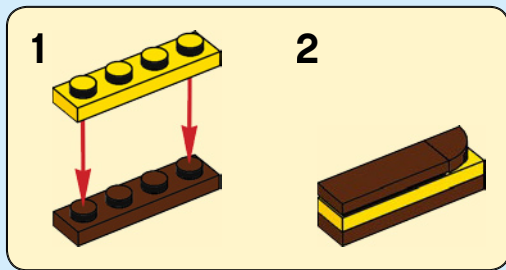

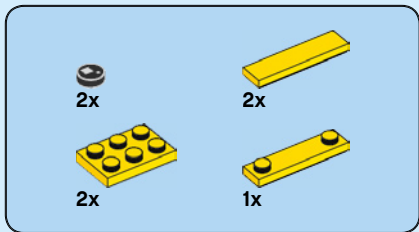

21

1

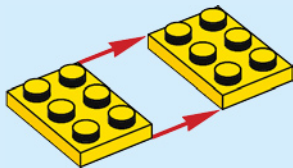

2

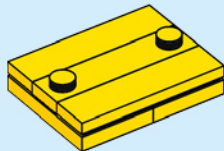

3

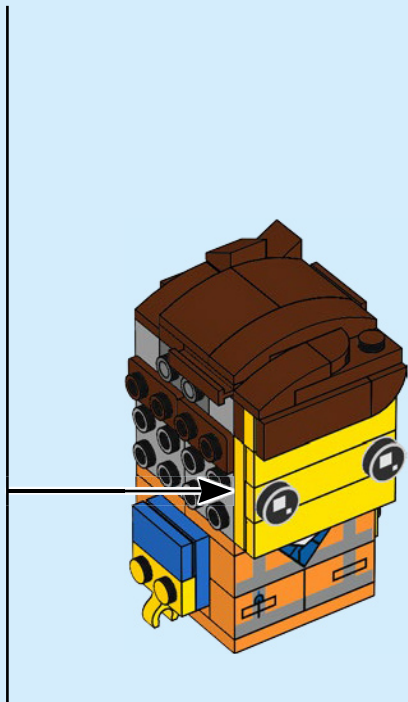
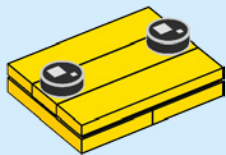



1x



1x



1x



3x

22

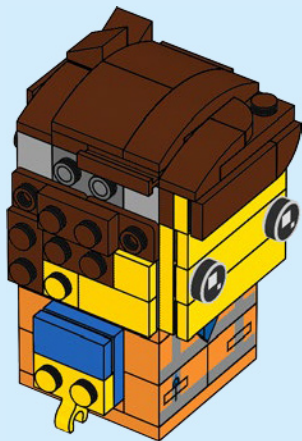

20



1x



1x

23

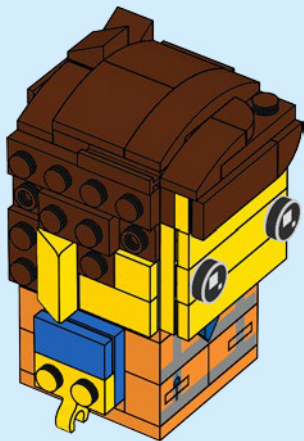

1x



1x



1x

24

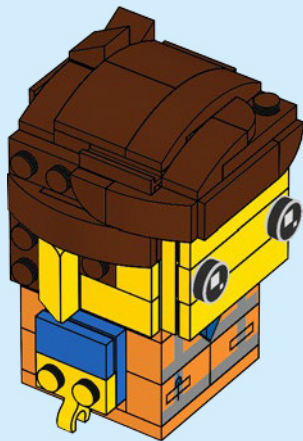



1x



1x



1x



3x

25

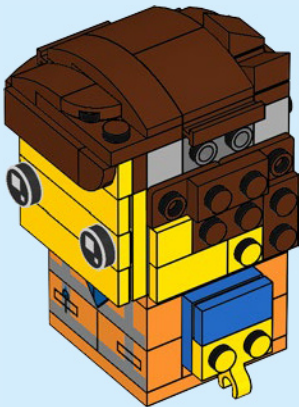
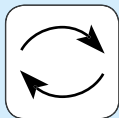



1x



1x

26

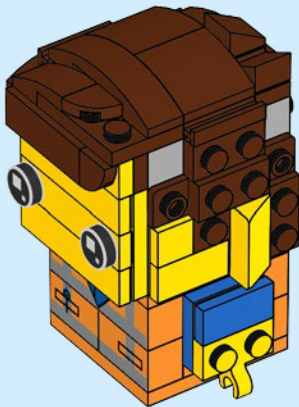



2x

27

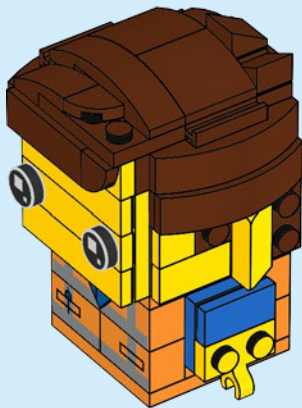

24

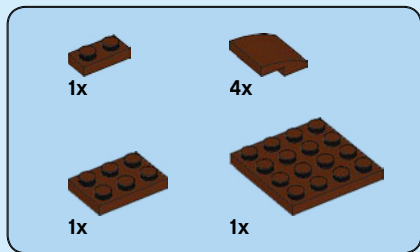

28

1

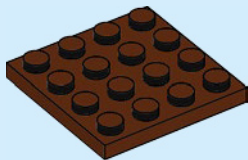

2

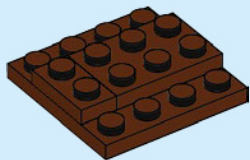

3

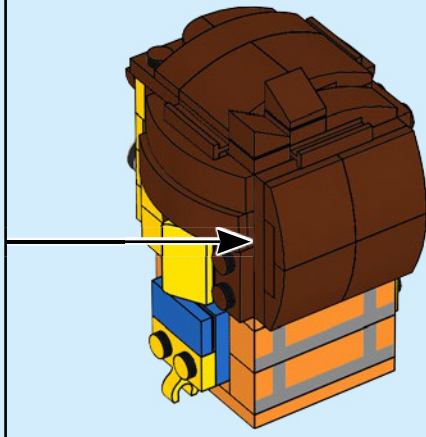
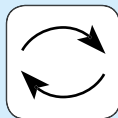
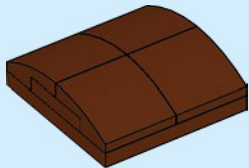



1x

29

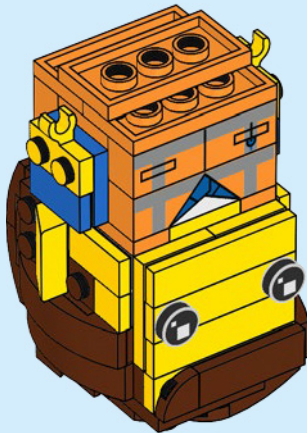
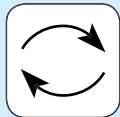



4x



2x

30

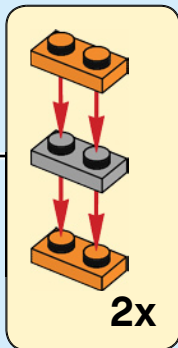
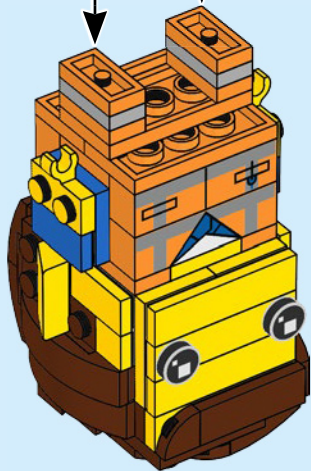

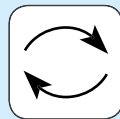
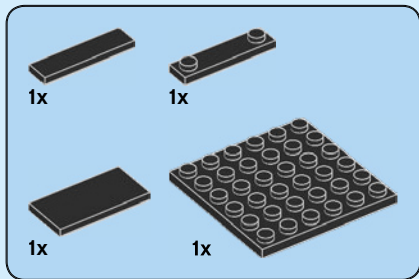

31

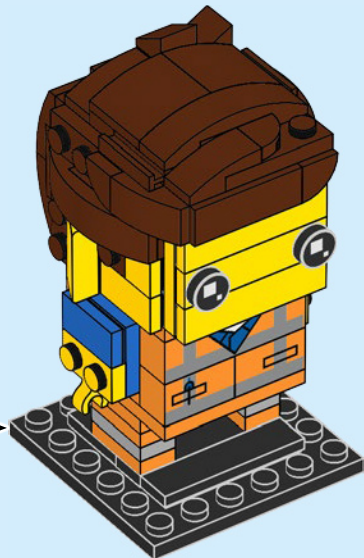
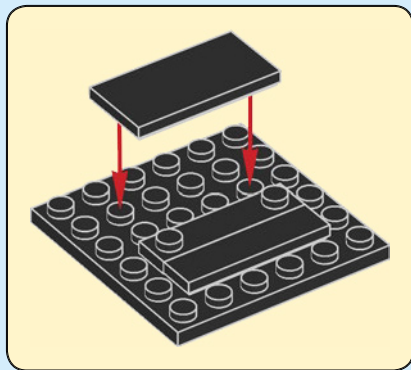

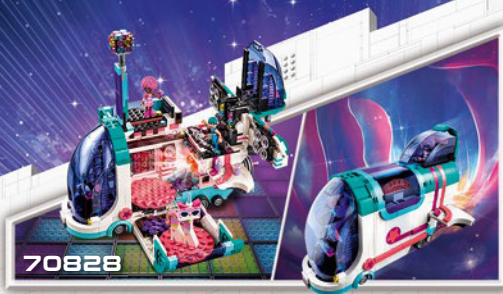

 LEGO.com/movie2



70826

70830

70831

70828

LEGO

**THE
LEGO
MOVIE**

THE LEGO® MOVIE 2™ © & ™, Warner Bros. Entertainment Inc. & The LEGO Group. LEGO, the LEGO logo, DUPLO, the Minifigure and the Brick and Knob configurations are trademarks and/or copyrights of the LEGO Group. ©2019 The LEGO Group. All rights reserved. WB SHIELD: TM & © WBEI. (s19)

LEGO





2x
4211398



8x
6123809



2x
4211636



2x
6178627



1x
6254045



1x
243126



1x
4560182

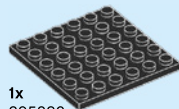

1x
395826



1x
4211042



2x
6230233



12x
4177932



1x
6267073



2x
6267082



1x
6267070



4x
4158355



1x
4550359



6x
6146858



1x
6100769



3x
4211189



4x
4658005



2x
4211190



1x
4243838



3x
6149677



3x
4221744



2x
4504376



3x
6069984



8x
4211150



4x
6174856



3x
4645103



2x
306924



1x
302224



2x
302124



3x
371024



1x
6257598



2x
307024



2x
302424



2x
4550348



2x
6179329



2x
243124



2x
306923



3x
302223



2x
614321



2x
300328



Customer Service

Kundenservice

Service Consommateurs

Servicio Al Consumidor

LEGO.com/service or dial



: 00800 5346 5555

: 1-800-422-5346

WIN

GO TO WWW.LEGO.COM/PRODUCTFEEDBACK AND
GIVE US YOUR SHORT **FEEDBACK** ABOUT THIS
LEGO® SET FOR A CHANCE TO WIN
A COOL LEGO PRIZE.

Terms & Conditions apply

LEGO.com/productfeedback



GEWINNE

Erzähle uns auf
www.LEGO.com/productfeedback

etwas über die Erfahrungen, die du
mit diesem LEGO® Set gemacht hast,
und sichere dir die Chance auf einen
coolen LEGO Preis!

Es gelten die Teilnahmebedingungen

GAGNE

Rends-toi sur
www.LEGO.com/productfeedback

et donne-nous quelques commen-
taires sur ce produit LEGO® pour
avoir une chance de gagner un
prix LEGO !

Voir Conditions Générales

GANA

Visita
www.LEGO.com/productfeedback

y envíanos tu opinión acerca de este
set LEGO®. ¡Participarás en el sorteo
de un premio LEGO!

Términos y Condiciones aplicables

获取奖品

登录
www.LEGO.com/productfeedback

给出关于此乐高®套装的简短反馈，
就有机会获得炫酷乐高奖品

《条款及条件》适用

THE LEGO® MOVIE 2™ © & TM Warner Bros. Ent. Inc. & The LEGO Group. LEGO, the LEGO logo, DUPLO,
the Minifigure and the Brick and Knob configurations © & TM The LEGO Group. ©2019 The LEGO Group.
WB SHIELD: TM & © WBEI. (s19)



6277207