



building
bigger
thinking

10402



building
bigge
thinking™

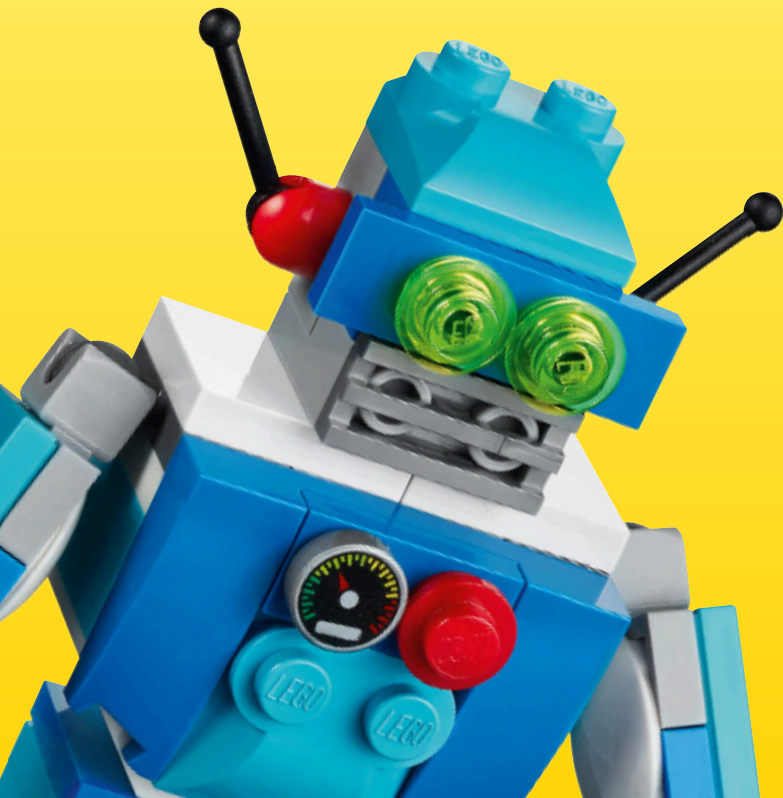

Did you know your imagination is **bigger** than a grown-up?

Wusstest du, dass deine Fantasie
größer ist, als die der Erwachsenen?

Savais-tu que ton imagination est
encore plus grande que les adultes ?

Lo sapevi che la tua immaginazione
è più grande di quella degli adulti?

¿Sabías que tienes más
imaginación que los mayores?

Sabes que a tua imaginação é
maior do que a dos adultos?

Tudtat, hogy a képzeleted
gazdagabb, mint a felnőtteké?

你知道吗？
你的想像力比大人还丰富呢？

It's true! you can
think of anything...
all you need to do is **build it**

das stimmt!
du kannst dir alles ausdenken...
dann musst du es nur noch bauen

c'est vrai !
tu peux inventer tout ce que tu veux...
tu n'as qu'à le construire

è vero!
puoi immaginare qualsiasi cosa...
devi solo costruirla

¡es cierto!
puedes imaginar cualquier cosa...
lo único que tienes que hacer es construirla

é verdade!
tu consegues pensar em tudo...
tudo o que precisas de fazer é construir

ez így van!
bármit elképzelhetsz...
csak annyit kell tenned, hogy megépíted

千真万确!
各种奇思妙想,
尽在一拼一搭间, 得以实现.....



For **60 years** LEGO® bricks have inspired **creativity**

Seit 60 Jahren
fördern LEGO®
Steine Kreativität



Les briques LEGO®
stimulent la créativité
depuis 60 ans

Los ladrillos LEGO®
llevan más de 60 años
fomentando la creatividad

A LEGO® kockák
már 60 éve ösztönzik
a kreativitást

Per 60 anni, i
mattoncini LEGO®
hanno ispirato
creatività

Durante 60
anos as peças
LEGO® inspiraram
criatividade

60年来, 乐高®
积木激发了孩子们无限的创造力

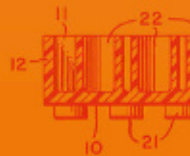



Diese Box wurde entwickelt, um größeres Denken in zukünftigen Generationen zu fördern

Cette boîte est conçue pour encourager les générations futures à voir plus grand

Questa scatola è progettata per incoraggiare le generazioni future a pensare in grande

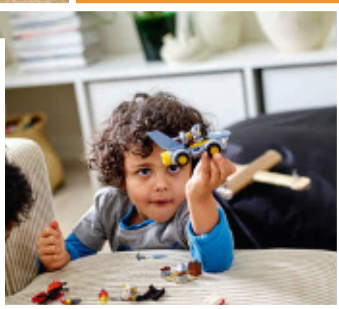

Esta caja está diseñada para hacer pensar en grande a las generaciones venideras

Esta caixa é concebida para inspirar pensar em grande em gerações futuras

Ezzel a dobozzal azt üzenjük a jövő generációinak, hogy gondolj egy nagyot!

该盒子旨在激发孩子们的创造力，拓展他们的思维空间

This box is
designed to inspire
bigger thinking in
generations to come

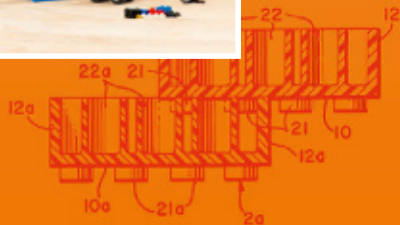



Easy building
Einfach zu bauen
Construction facile
Costruzione facile
Construcción fácil
Construção fácil
Kezdő építőknek
简单拼砌



Medium building
Mittelschwer
Construction intermédiaire
Costruzione media
Construcción intermedia
Construção intermédia
Gyakorló építőknek
中级拼砌



Advanced building
Fortgeschritten
Construction avancée
Costruzione avanzata
Construcción avanzada
Construção avançada
Tapasztalt építőknek
高级拼砌

Page
Seite
Pagina
Página
oldalszám
页码



Page **8**



what will 
do for us in **the future?**

was wird für uns
in **Zukunft tun?**

que feront les
pour nous dans **le futur ?**

cosa farà per
noi nel **futuro?**

¿qué hará por nosotros
en **el futuro?**

o que fará o por
nós no **futuro?**

mit **fog** tenni értünk
a **jövőben?**

在未来,
能为我们做些什么?



Page 20



Page 30



1x

1

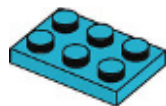



2x

2

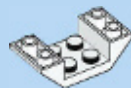
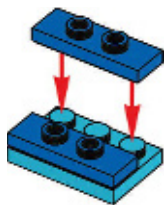

1x

3

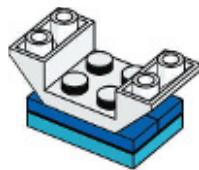



2x

4

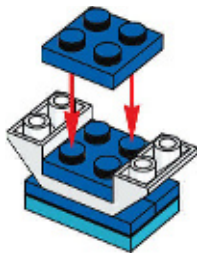

3x

5

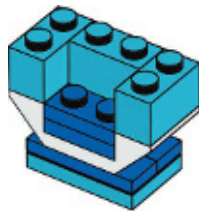



2x

6

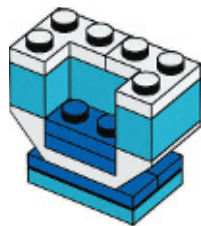

1x



1x



2x

7

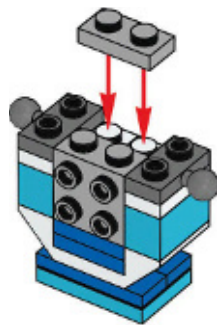



2x

8

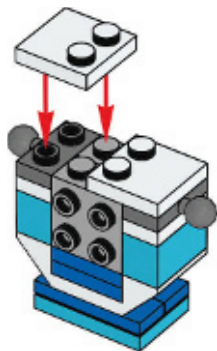

1x

9

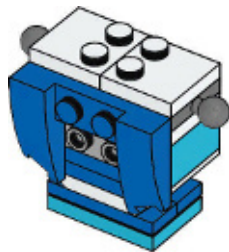



1x



1x

10

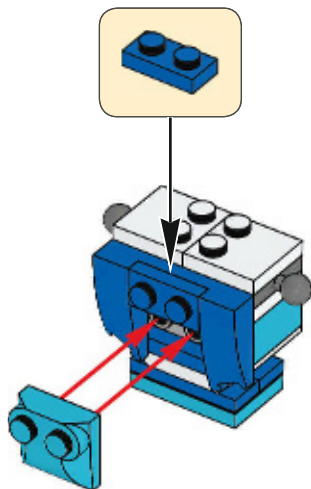

1x



1x

11

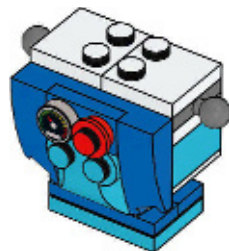



2x



2x



2x



2x

12

1



2



3

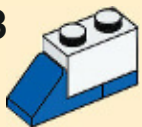

4

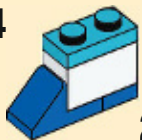

2x

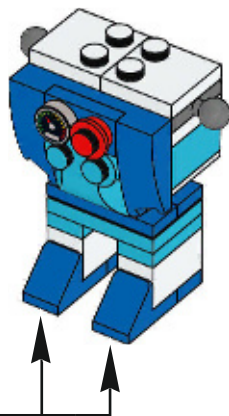

14



1x

13

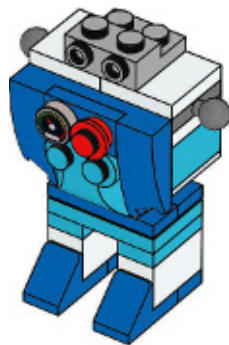



2x

14

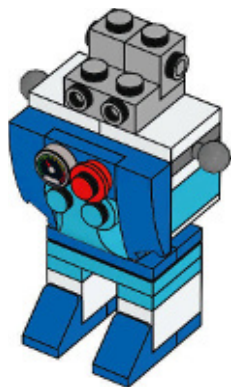

1x



2x

15

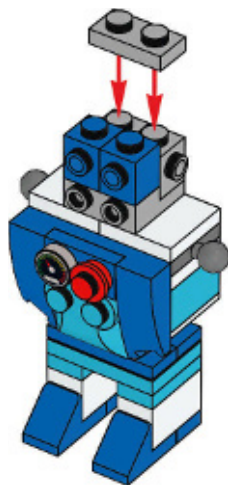



1x

16

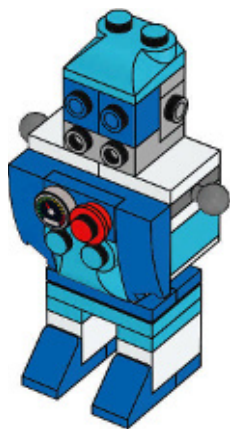

16



2x

17

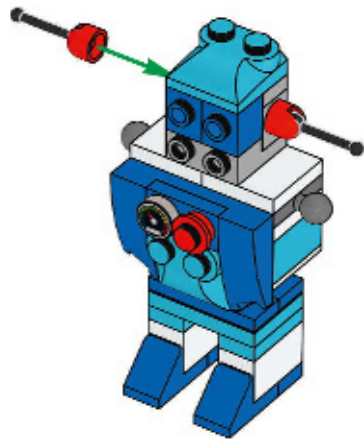



1x



1x

18

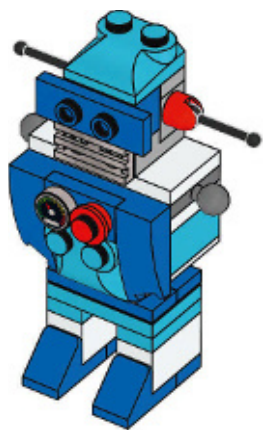

2x

19

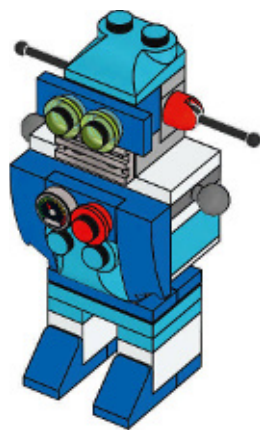

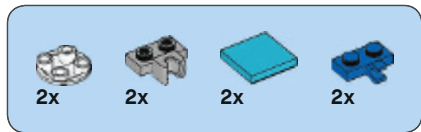

20

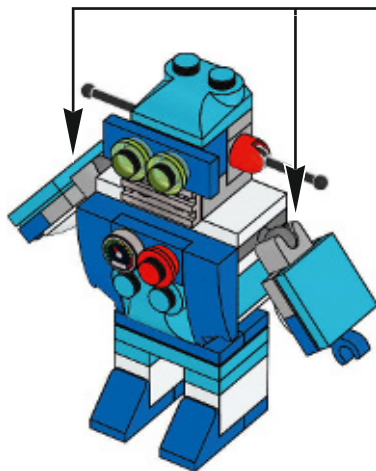
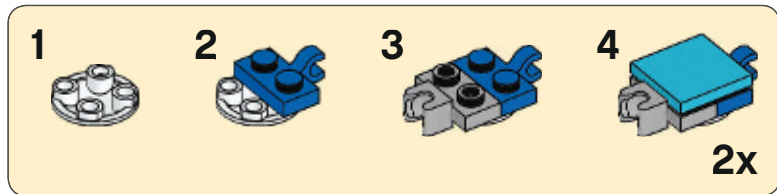

what is a



latest invention?

was ist neueste
Erfindung?

quelle est la dernière
invention de ?

qual è l'ultima invenzione
di un ?

¿cuál es el último invento de
..... ?

o que é uma
última invenção?

mi legújabb
találománya?

..... 最新 发明是什么?

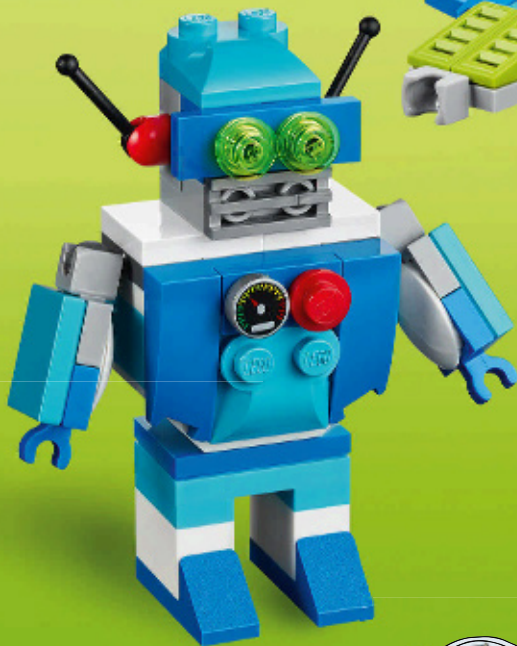

Upload your build at / Lade deine Kreation hoch in / Télécharge ta construction sur /
Carica il tuo modello su / Carga tu modelo en / Faz o upload do teu modelo em /
Töltsd fel az építményedet ide / 在此处上传您的拼搭作品





1

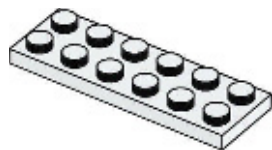



2x

2



1x



2x

3

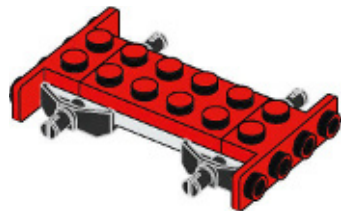



1x

4

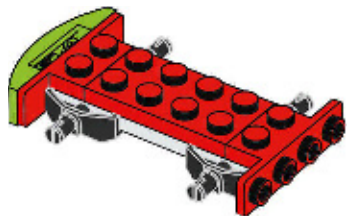

2x



2x

5

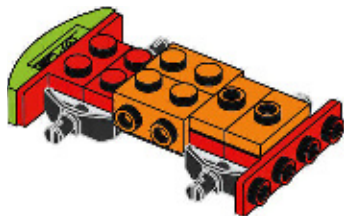



1x

6

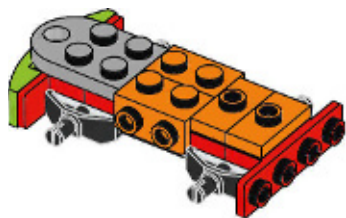

1x

7

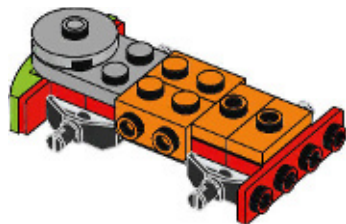



1x

8

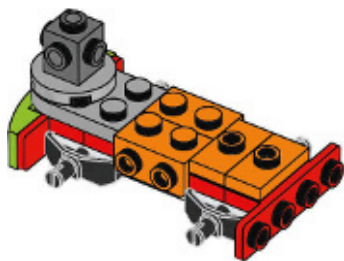

1x



2x

9

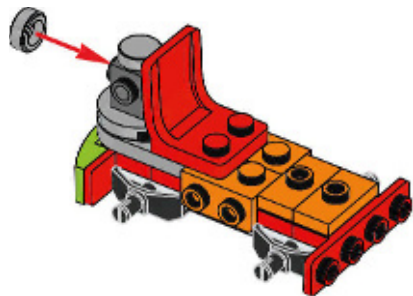



2x



1x

10

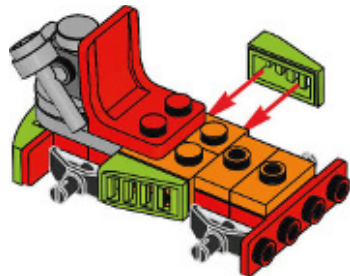

1x

11

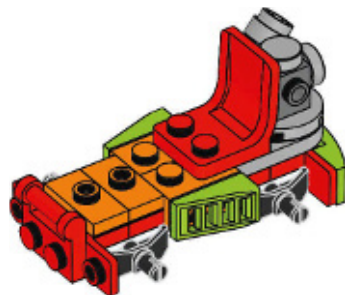
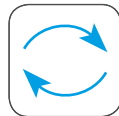



1x

12

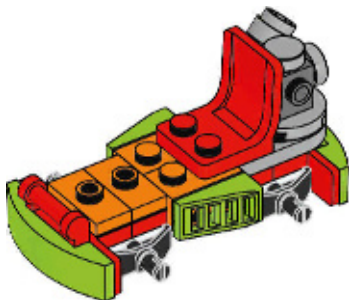



1x

13

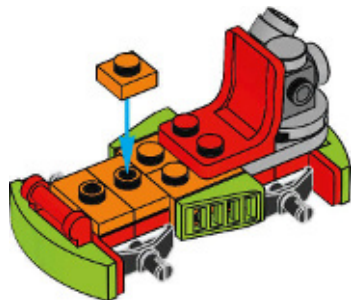

1x

14

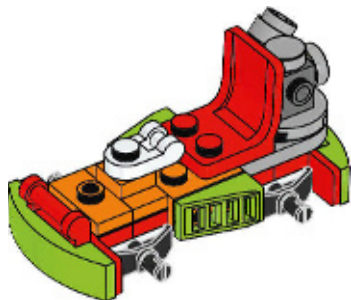



1x

15

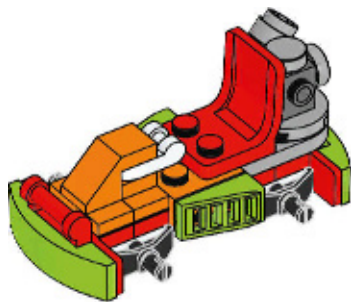



16

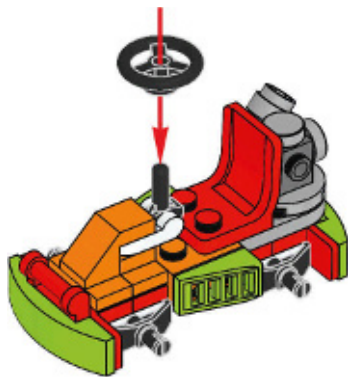

17

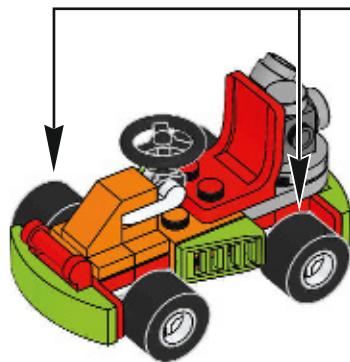
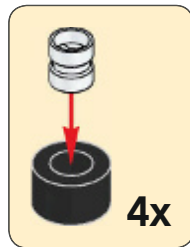

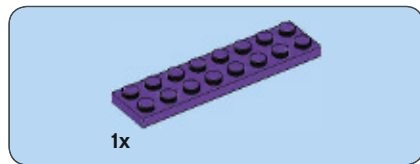

1

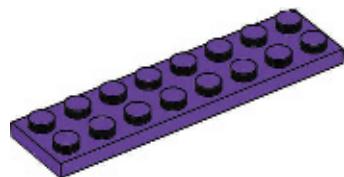



1x

2

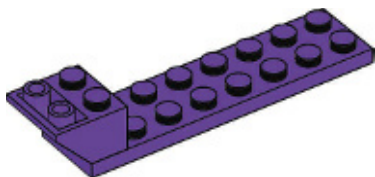

1x

3

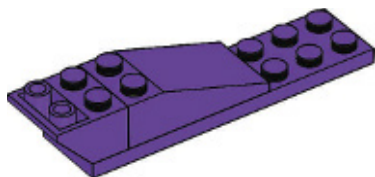



4

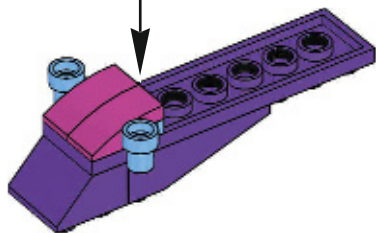
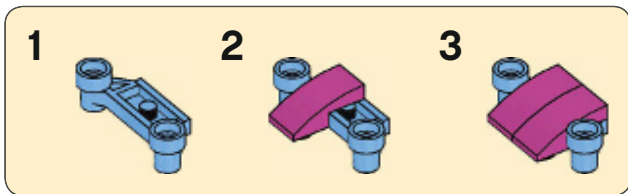
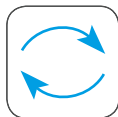



2x

5

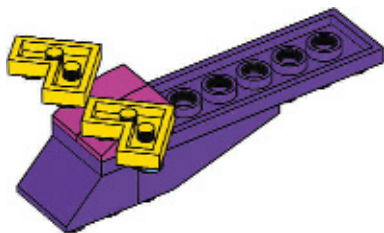

1x

6

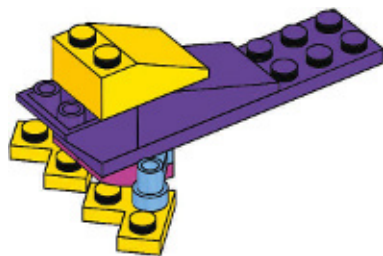
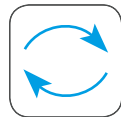



1x

7

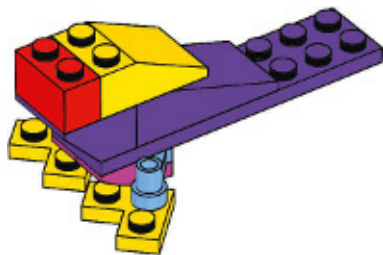

2x

8

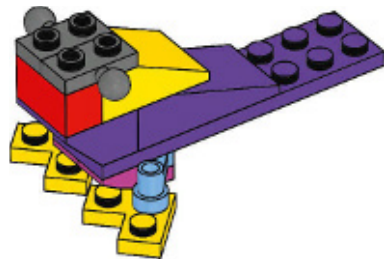



1x

9

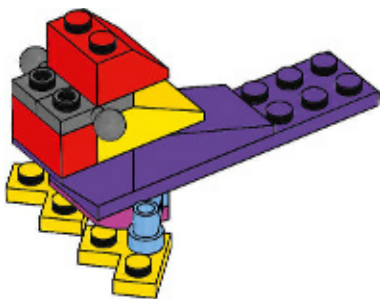

1x

10

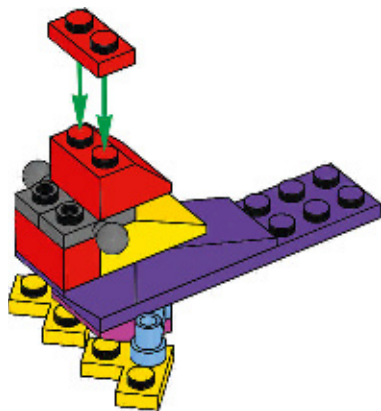



1x

11



2x

12

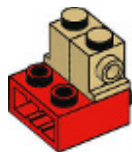



1x

13

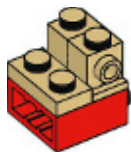

2x

14

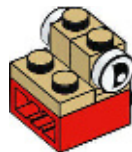



2x

15

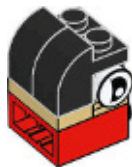

1x

16

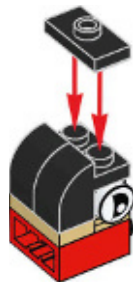

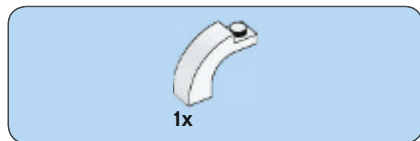

17



18

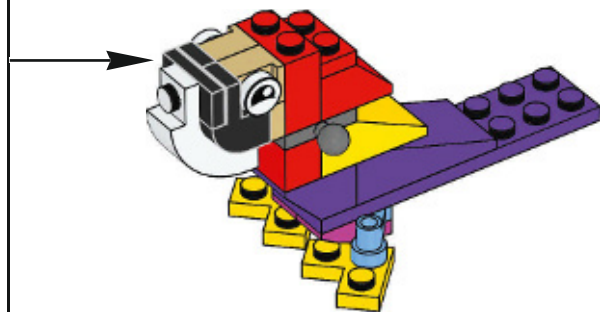

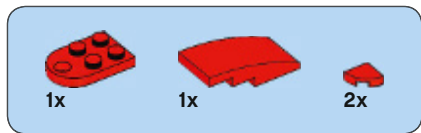

19

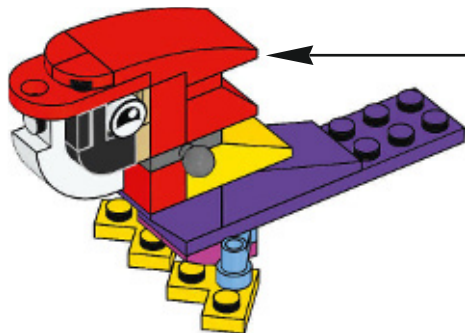

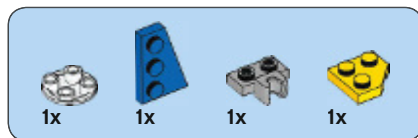

20

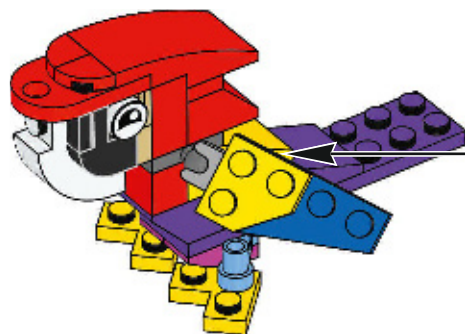
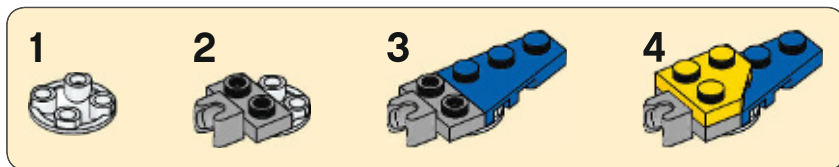

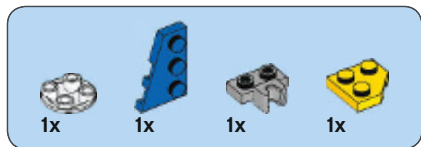

21

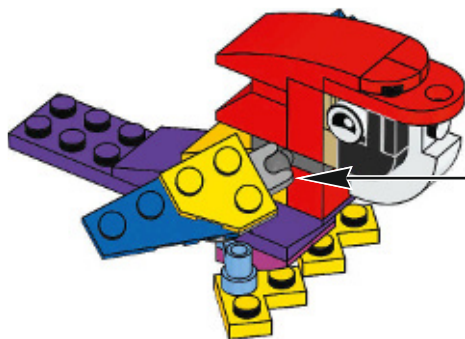
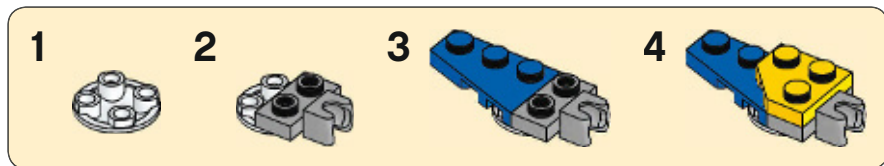
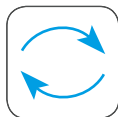



1x



1x

22

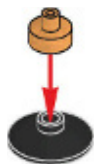

1x



1x

23



1x



1x



1x

24

1



2



3



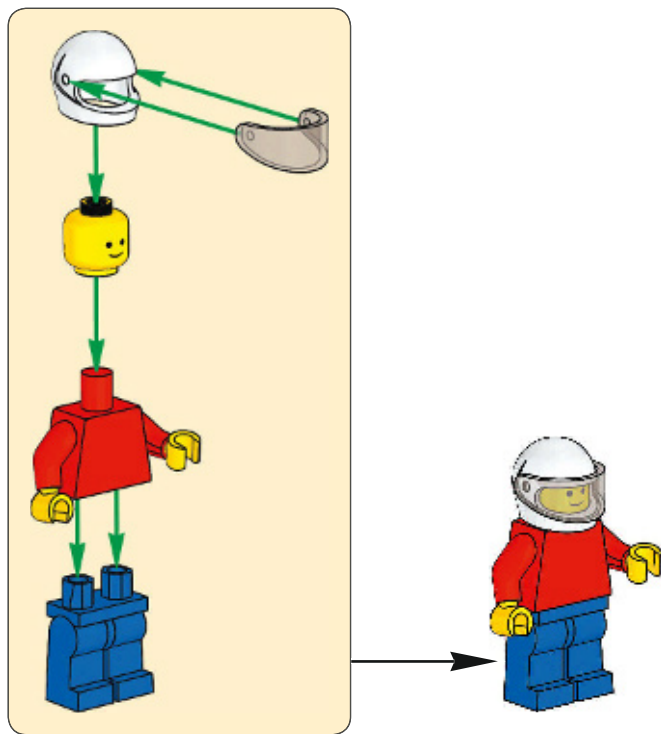

who is the



singing to?

für wen singt
der ?

pour qui
chantent les
..... ?

per chi sta
cantando il
..... ?

¿a quién le
canta ?

para quem
está o a
cantar ?

kinek énekel
..... ?

..... 在为谁 歌唱?



Upload your build at / Lade deine Kreation hoch in / Télécharge ta construction sur /
Carica il tuo modello su / Carga tu modelo en / Faz o upload do teu modelo em /
Töltsd fel az építményedet ide / 在此处上传您的拼搭作品



LEGO Friends



LEGO CLASSIC



LEGO CITY



1x 614101	2x 4173943	1x 6135130	4x 4583862	1x 6179675	2x 615726	2x 4165967	1x 6123809	4x 4118793	1x 9336	1x 6030333
2x 6099548	2x 379501	2x 4226876	2x 302423	2x 6143318	1x 4107050	2x 6142402	1x 4654577	1x 4113917	2x 6195184	2x 4619636
4x 6011380	2x 6109931	4x 303921	2x 4498155	1x 4289538	2x 6185356	2x 4539481	2x 4211419	1x 4113917	2x 242024	2x 6071247
1x 4298609	2x 6174937	1x 407921	2x 4498156	2x 4290713	1x 4524929	2x 4650260	2x 4210700	1x 6186672	1x 4275872	1x 4619513
2x 6174937	4x 4278271	2x 6133921	1x 9341	2x 474026	2x 6181314	4x 4558953	4x 6039479	1x 6093516	2x 329824	4x 6092674
4x 4278271	2x 300401	2x 6231523	2x 6057397	1x 6057397	2x 6092599	2x 4595836	2x 4550359	2x 6057034	2x 74335	2x 6097419
2x 300401	2x 6218822	2x 6089576	4x 4508215	4x 4508215	2x 6193782	2x 4595836	2x 4550359	1x 6227618	2x 6097419	2x 6060857
2x 6218822	2x 614121	2x 4613174	1x 6092585	1x 6092585	1x 4163306	2x 6183782	2x 6212064			
2x 242001	2x 6170390	1x 302021	2x 6213381	2x 6213381	1x 4163306	2x 6183782				
2x 4629913	1x 302321	1x 302021	1x 302323	1x 302323	2x 6184784	2x 4211398				
1x 6218943	4x 300421	2x 300121	2x 302223	2x 302223	1x 4505757	4x 6043656				
			4x 6231513	4x 400626	2x 4617069					



Customer Service

Kundenservice

Service Consommateurs

Servicio Al Consumidor

LEGO.com/service or dial



: 00800 5346 5555

: 1-800-422-5346

WIN

GO TO WWW.LEGO.COM/PRODUCTFEEDBACK AND
GIVE US YOUR SHORT **FEEDBACK** ABOUT THIS
LEGO® SET FOR A CHANCE TO WIN
A COOL LEGO PRIZE.

Terms & Conditions apply

LEGO.com/productfeedback



GEWINNE

Erzähle uns auf
www.LEGO.com/productfeedback

etwas über die Erfahrungen, die du mit
diesem LEGO® Set gemacht hast, und
sichere dir die Chance auf einen coolen
LEGO Preis!

Es gelten die Teilnahmebedingungen

GAGNE

Rends-toi sur
www.LEGO.com/productfeedback

et donne-nous quelques commentaires sur
ce produit LEGO® pour avoir une chance
de gagner un prix LEGO !

Voir Conditions Générales

GANANA

Visita
www.LEGO.com/productfeedback

y envíanos tu opinión acerca de este set
LEGO®. ¡Participarás en el sorteo de un
premio LEGO!

Términos y Condiciones aplicables

获取奖品

登录
www.LEGO.com/productfeedback

给出关于此乐高®套装的简短反馈，
就有机会获得炫酷乐高高奖品

《条款及条件》适用