

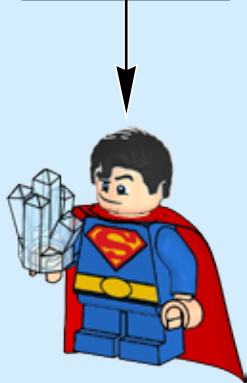

1

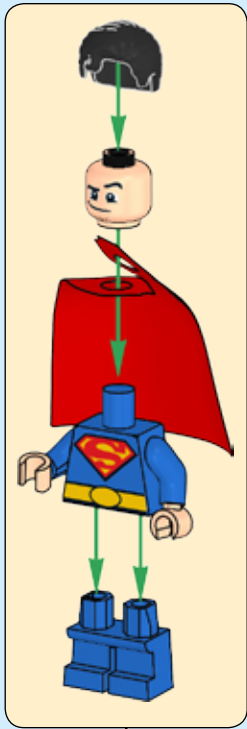

1



2

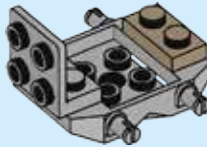

3

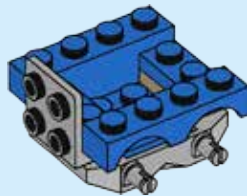

4

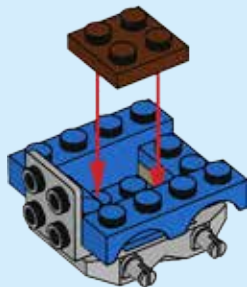

5

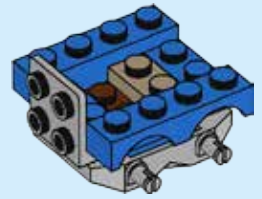

6

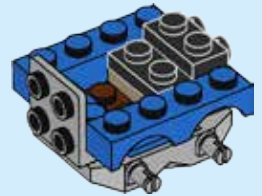

7

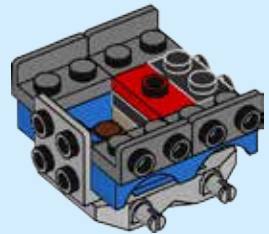

8

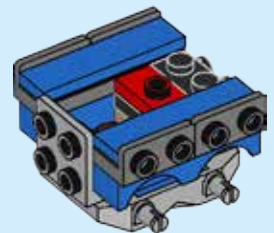

9

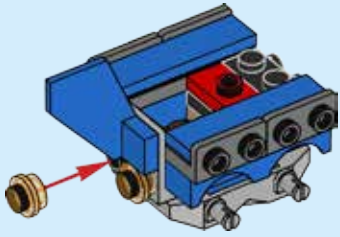

10

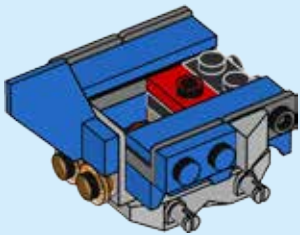

11

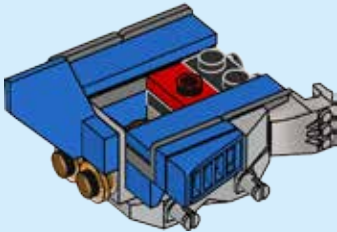

12

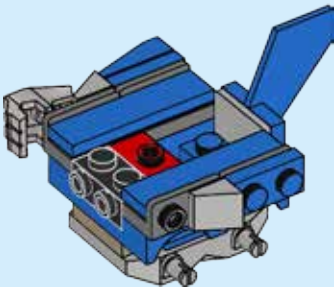
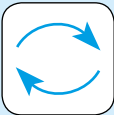

13

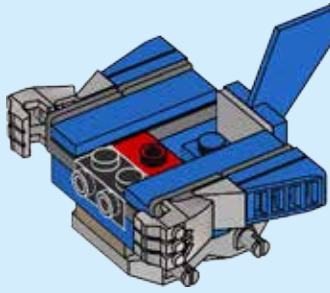

14

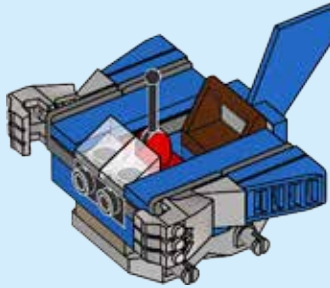

15

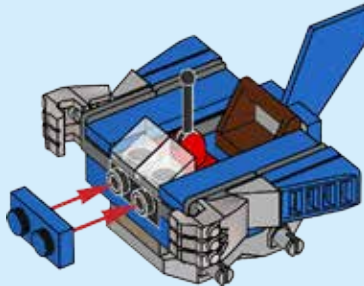

16



17

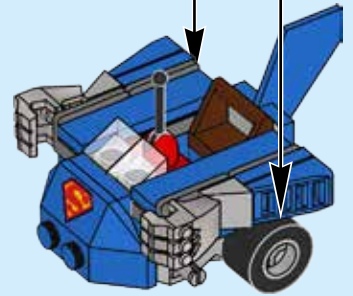
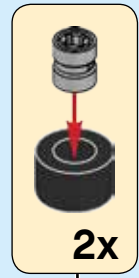

18

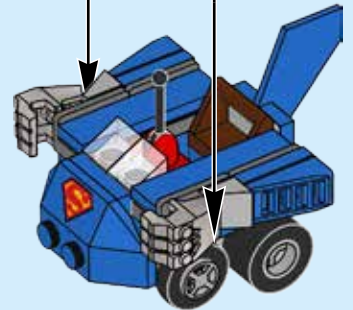
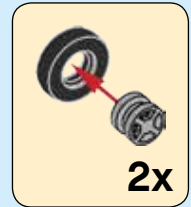

LEGO.com/service

LEGO and the LEGO logo are trademarks of the LEGO Group. ©2017 The LEGO Group. 6187416

DC All DC characters and elements © & TM DC Comics.

WB SHIELD: TM & © WBEI. (s17)



DC COMICS
**SUPER
HEROES**

76068

6187423

2

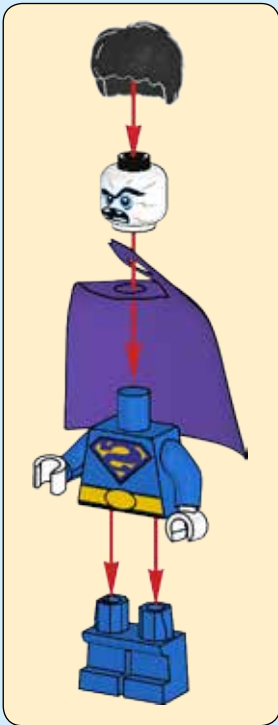

1



2

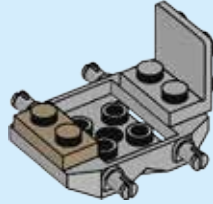

3

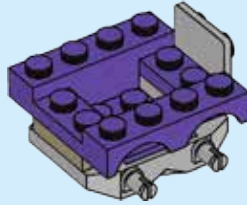

4

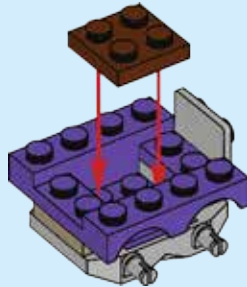

5

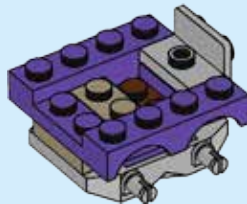

6

7 LEGO.com/DCSUPERHEROES

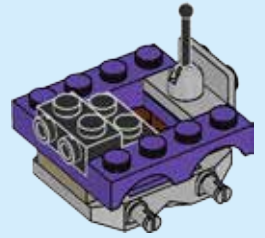

7

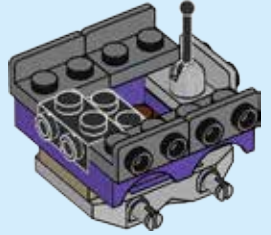

8

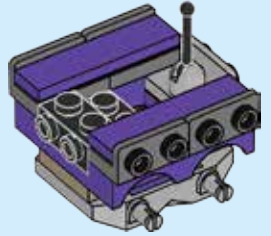

9

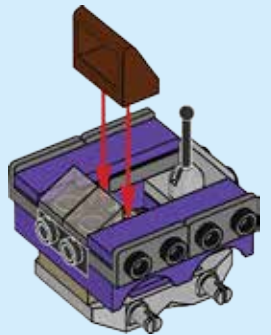

10

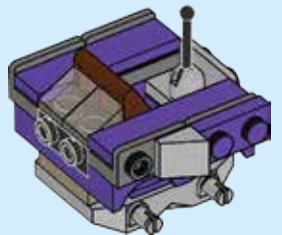

11

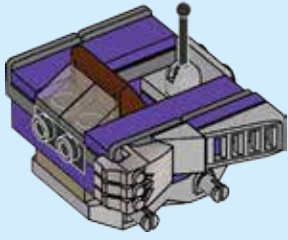

12

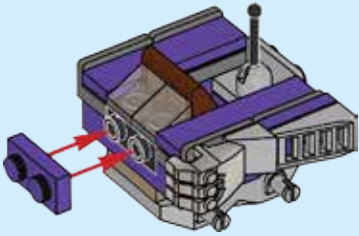

13

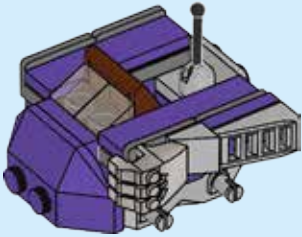

14

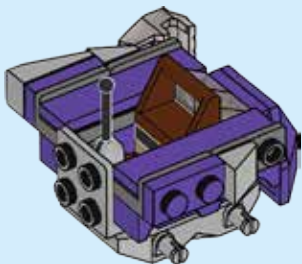
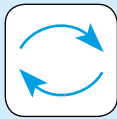

15

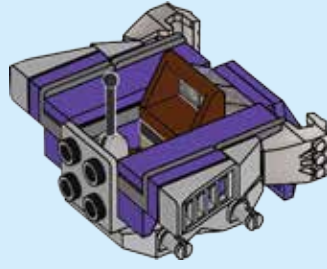

16

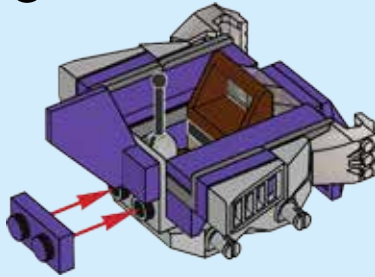

17

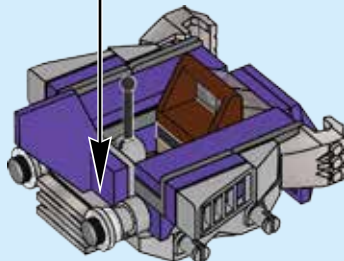
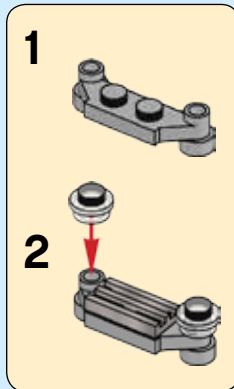

18

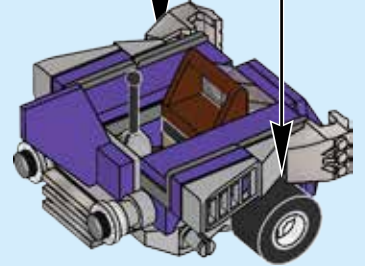
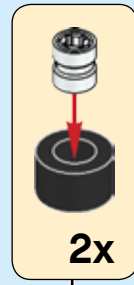

19

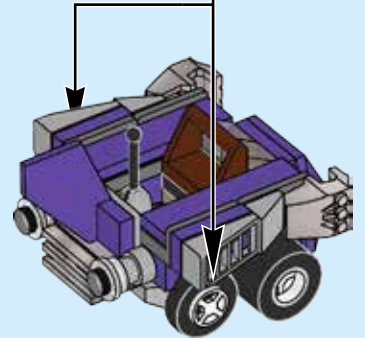
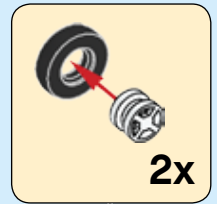

LEGO.com/service

LEGO and the LEGO logo are trademarks of the LEGO Group. ©2017 The LEGO Group. 6187423

DC All DC characters and elements © & TM DC Comics.

WB SHIELD: TM & © WBEI. (s17)



DC COMICS SUPER HEROES

76068

LEGO and the LEGO logo are trademarks of the LEGO Group. ©2017 The LEGO Group.

DC All DC characters and elements © & ™ DC Comics.

WB SHIELD: TM & © WBEI.
(s17)

6187426



Terms & Conditions apply

LEGO.com/productfeedback

GEWINNE



Erzähle uns auf
www.LEGO.com/productfeedback

etwas über die Erfahrungen, die du mit diesem LEGO® Set gemacht hast, und sichere dir die Chance auf einen coolen LEGO Preis!

Es gelten die Teilnahmebedingungen

GAGNE



Rends-toi sur
www.LEGO.com/productfeedback

et donne-nous quelques commentaires sur ce produit LEGO® pour avoir une chance de gagner un prix LEGO !

Voir Conditions Générales

GANA



Visita
www.LEGO.com/productfeedback

y envíanos tu opinión acerca de este set LEGO®, ¡participarás en el sorteo de un premio LEGO!

Términos y Condiciones aplicables

获取奖品



登录
www.LEGO.com/productfeedback

给出关于此乐高®套装的简短反馈，就有机会获得炫酷乐高奖品

《条款及条件》适用

- | | | | | | | | | | | |
|---------------|---------------|---------------|---------------|---------------|---------------|---------------|---------------|---------------|---------------|---------------|
| 1x
4651571 | 1x
6170209 | 2x
4543857 | 1x
6163465 | 2x
4211506 | 4x
4516843 | 2x
4211219 | 1x
4243703 | 1x
6164281 | 4x
4655695 | 1x
6144650 |
| 1x
4157659 | 1x
6170177 | 2x
4597338 | 1x
6066097 | 4x
4521921 | 4x
4508215 | 2x
4216695 | 1x
6134621 | 2x
6057988 | 1x
6174952 | |
| 1x
6170212 | 1x
74335 | 2x
243123 | 2x
4654580 | 2x
6011375 | 2x
6052126 | 2x
462401 | 2x
4222960 | | | |
| 1x
6170179 | 1x
6092565 | 1x
6133558 | 1x
6138067 | 2x
6092111 | 4x
6037408 | 2x
6011380 | 2x
3005740 | | | |
| 1x
6170501 | 1x
6102553 | 1x
6172552 | 1x
6134236 | 1x
4221775 | 1x
4619636 | 2x
4244362 | | | | |
| | 3x
302323 | | 2x
6134236 | 8x
6000606 | 4x
4528604 | 2x
4244368 | | | | |

Customer Service
Kundenservice
Service Consommateurs
Servicio Al Consumidor

LEGO.com/service or dial



: 00800 5346 5555
: 1-800-422-5346

LEGO

DC COMICS
**SUPER
HEROES**

**MIGHTY
MICROS**

LEGO.com/DCSUPERHEROES

DC All DC characters and elements © & ™ DC Comics.

WB SHIELD: TM & © WBEI.
(s17)

Apple and the Apple logo are trademarks of Apple Inc.,
registered in the U.S. and other countries.
App Store is a service mark of Apple Inc.

Google Play is a trademark of Google Inc.

Ask parents' permission first.
Bitte frage erst deine Eltern um Erlaubnis.
Demande d'abord l'autorisation d'un parent.
Pide antes permiso a tus padres.
Pede primeiro permissão aos teus pais.
Először kérj engedélyt a szüleidtől!
先请求家长的许可。



LEGO

DC COMICS
**SUPER
HEROES**

76054

76055

76053



76055

76054

76053

DC BATMAN and all related characters and elements
© & ™ DC Comics and Warner Bros.
Entertainment Inc.

WB SHIELD: TM & © WBEI.
(s17)

