



CITY

30349

6150657



1

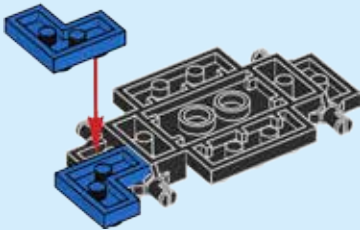

2

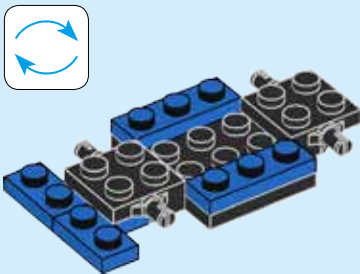

3

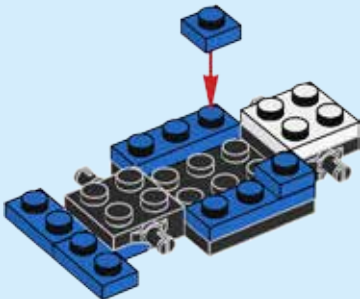

4

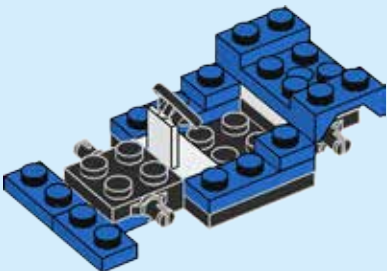

5

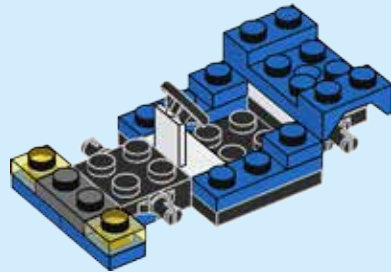

6

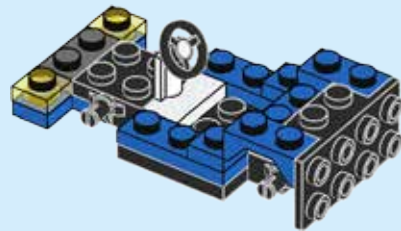

7

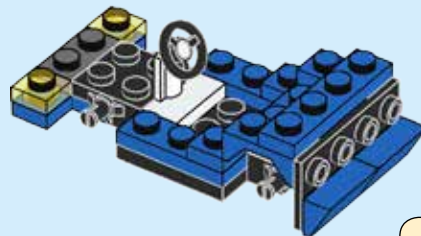

8

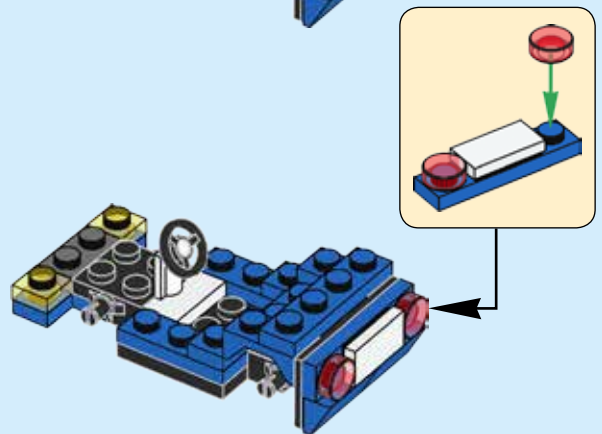

9

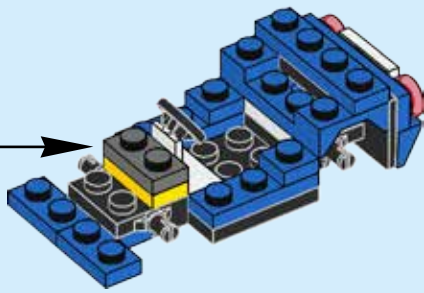
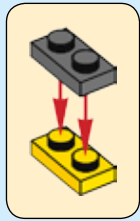

10

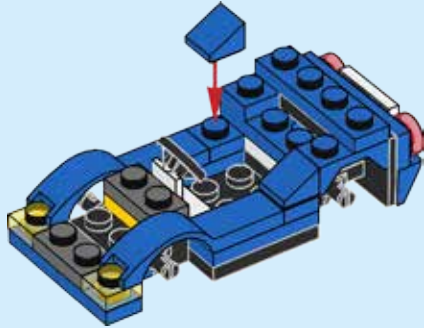

11

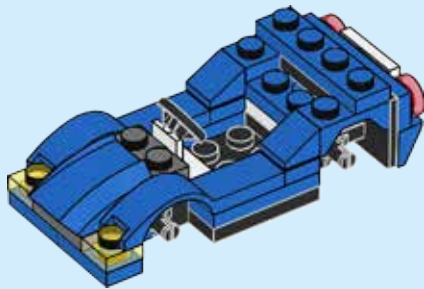

12

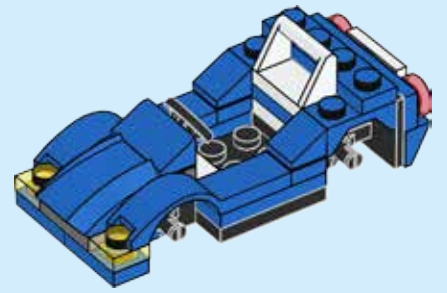

13

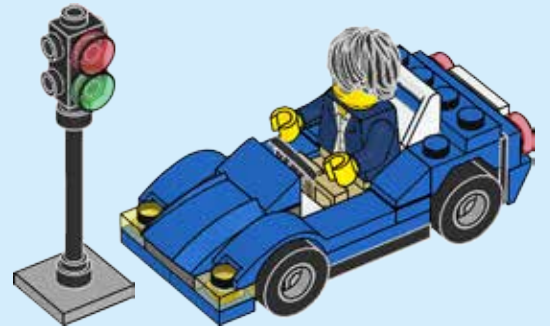

**LEGO CITY**



60130



60129



60128



60127



60126

[LEGO.com/city](http://LEGO.com/city)

[LEGO.com/service](http://LEGO.com/service)

LEGO and the LEGO logo are trademarks of the LEGO Group. ©2016 The LEGO Group. 6150657