



# CLASSIC



10692











[LEGO.com/brickseparator](https://LEGO.com/brickseparator)

 Easy building  
Einfach zu bauen  
Construction facile  
Construcción fácil  
Construção fácil  
Kezdő építőknek  
简单拼砌

  
 Medium building  
Mittelschwer  
Construction intermédiaire  
Construcción intermedia  
Construção intermédia  
Gyakorló építőknek  
中级拼砌

  
  
 Advanced building  
Fortgeschritten  
Construction avancée  
Construcción avanzada  
Construção avançada  
Tapasztalt építőknek  
高级拼砌



LEGO.com/classic

Page/页码

 6



Page/页码

46



Page/页码

12



Page/页码

37



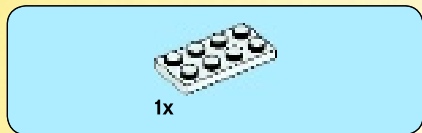

1

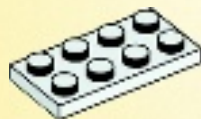



1x

**2**

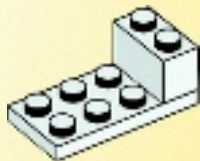

1x

**3**

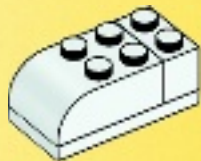



1x

4



2x

5







2x

6

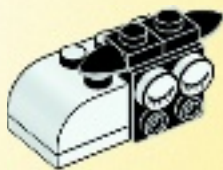

2x

7





1x

1



1x

2





1x

**3**



1x



1x

**4**







1x

1

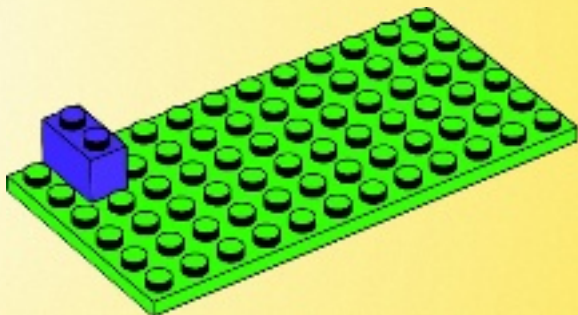



1x

2

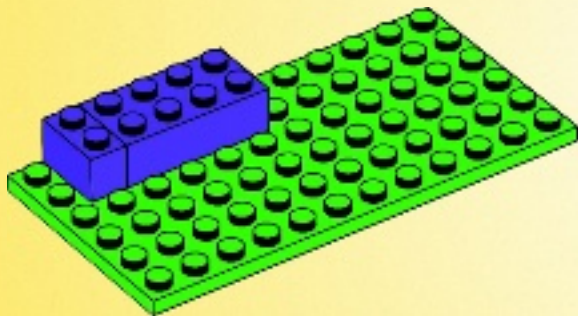



4x

3

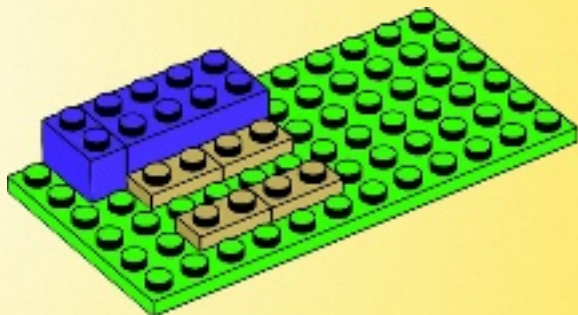



2x

4

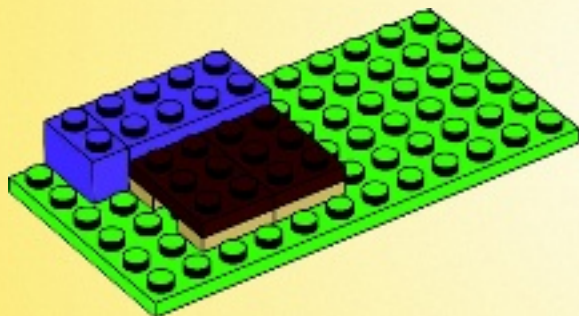





1x



1x

5

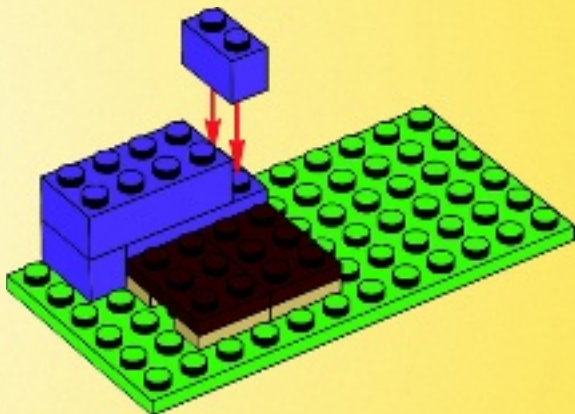



1x

6

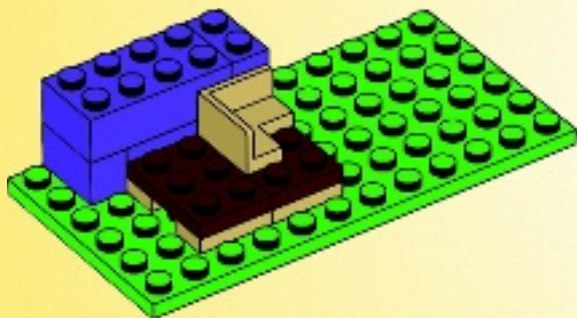



1x

7

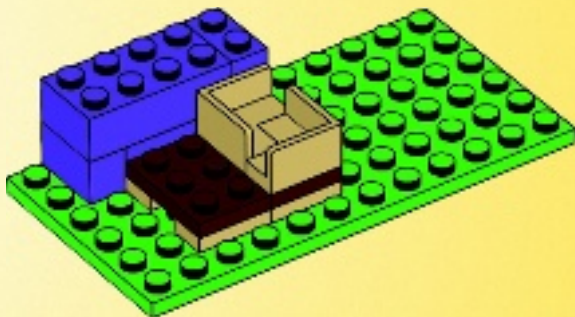



2x



1x

8

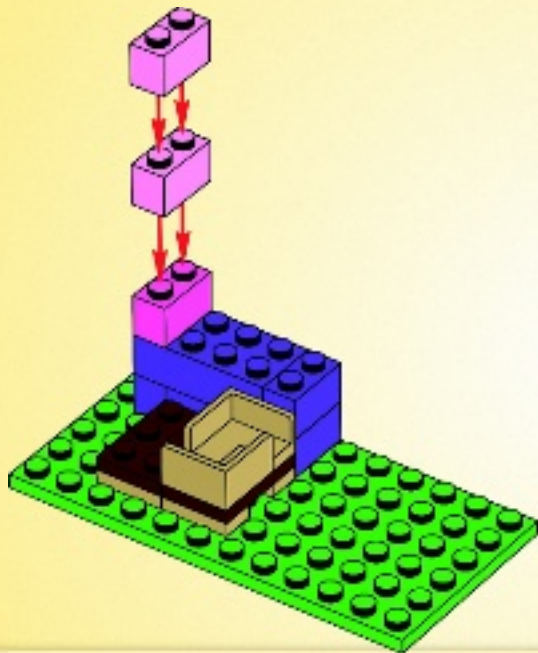

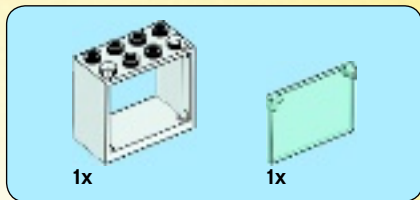

9

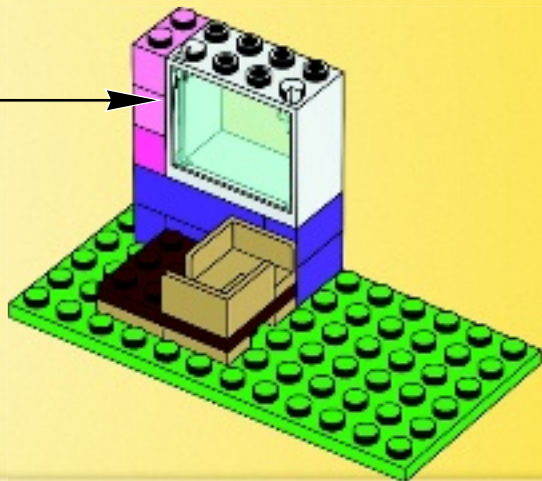
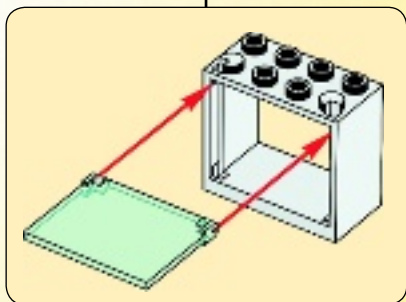



1x



1x



1x

# 10

1



2

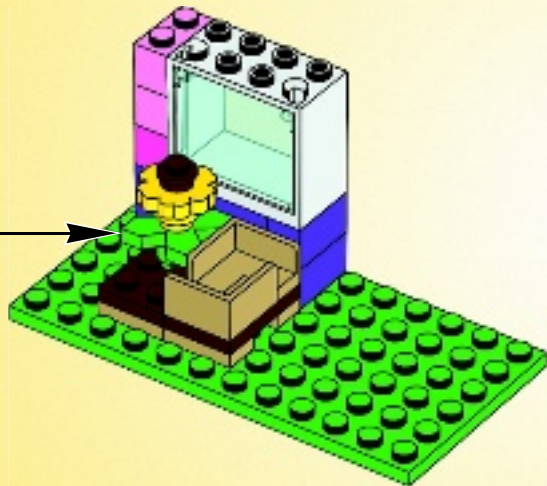



2x



2x



2x

# 11



2x

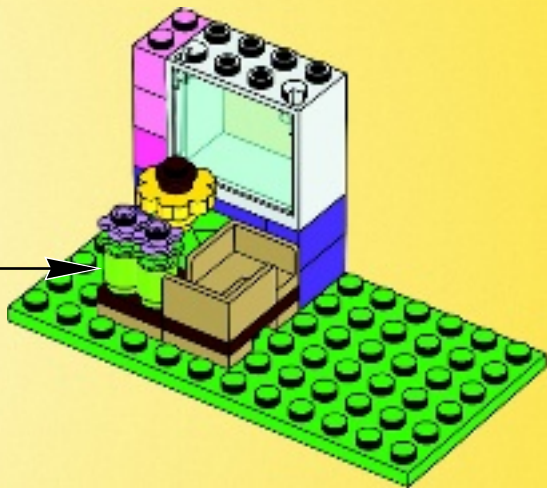

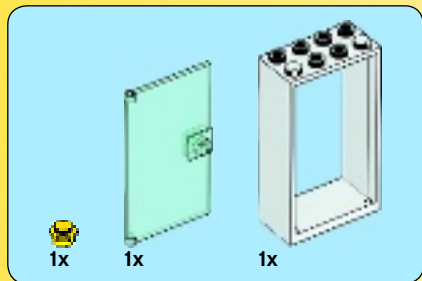

12

1

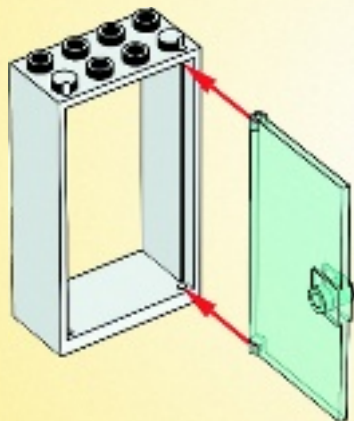



2

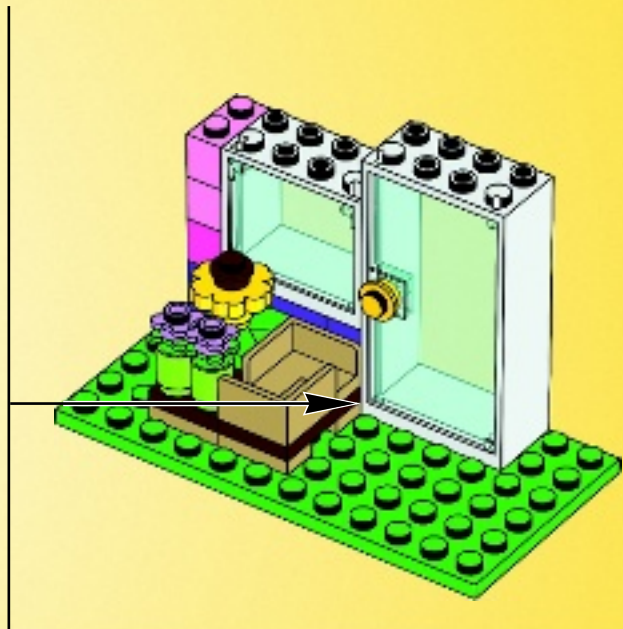
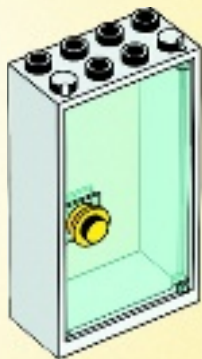



1x



2x

# 13

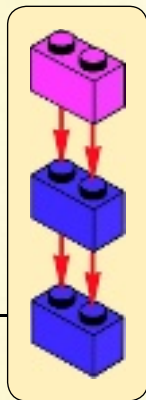
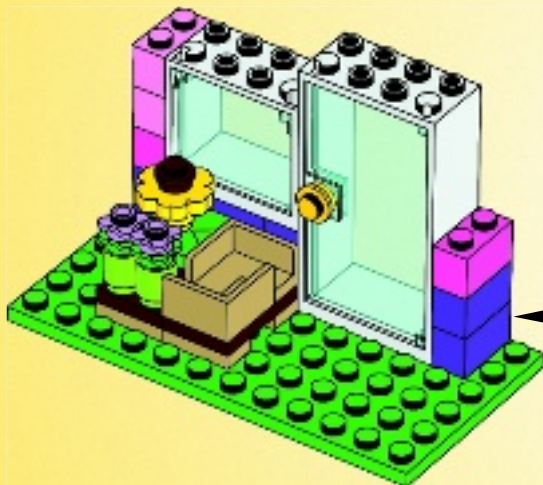



3x

# 14

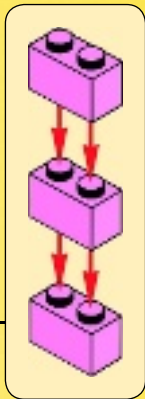
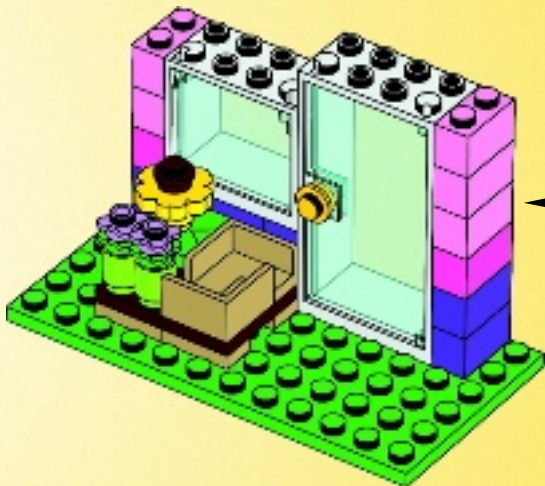



1x



1x

# 15

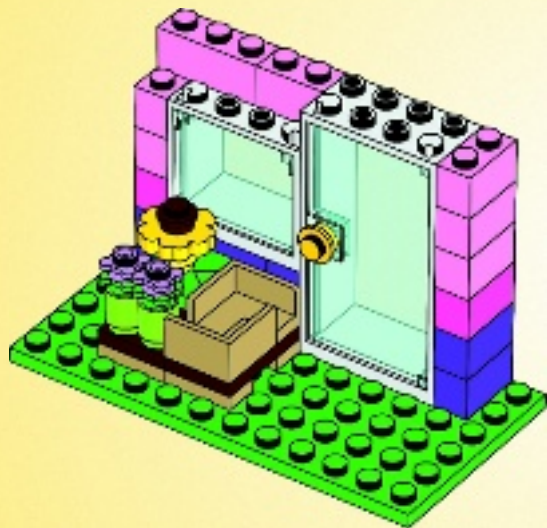



1x



1x

# 16





2x



2x

# 17



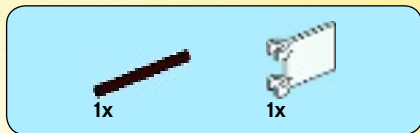

18

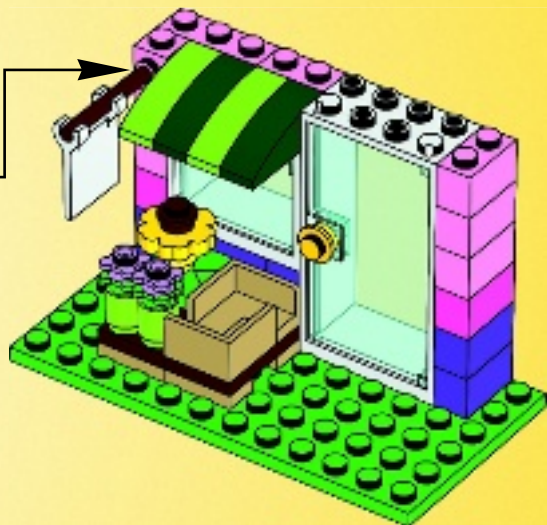
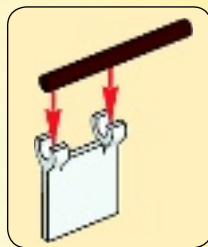

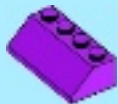

1x



1x

# 19







1x



1x

20

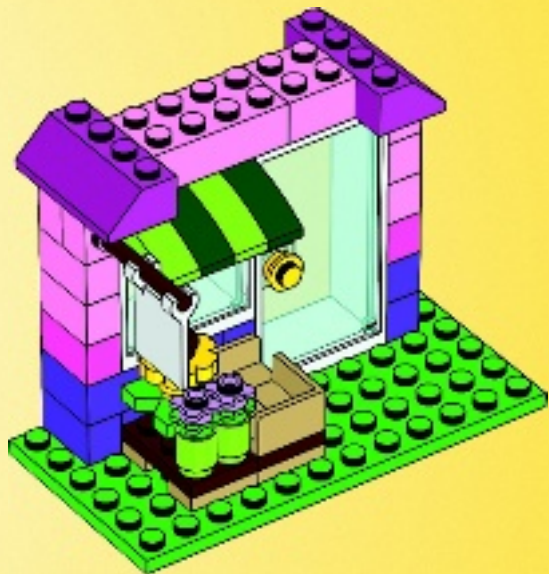

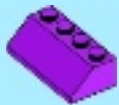

2x



1x

# 21





2x

22





2x



2x

# 23

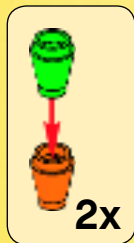



1x

1





1x

**2**



1x

**3**





1x



1x

# 4

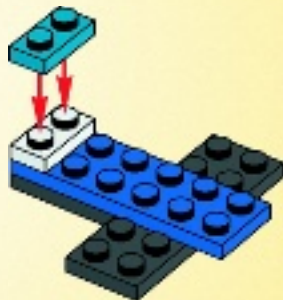

1x

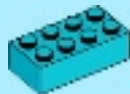

1x



1x

# 5

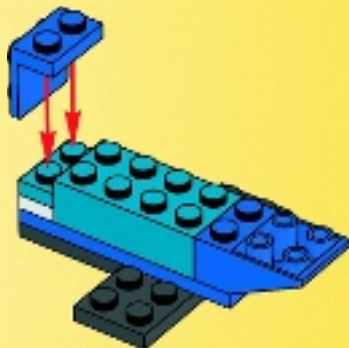



1x



2x

# 6

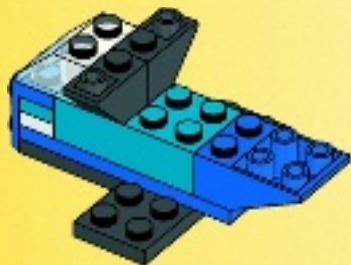

1x



1x

# 7

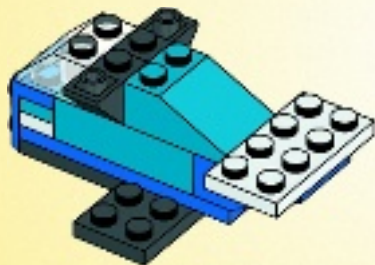



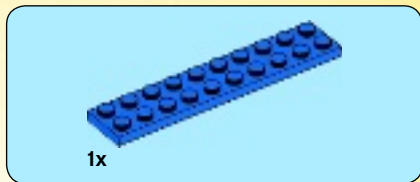

8

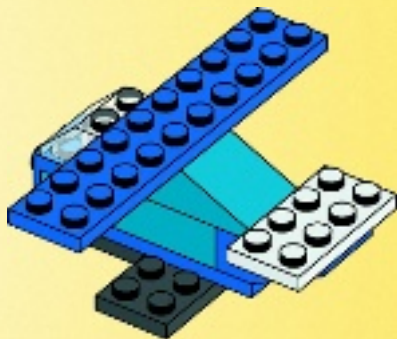



2x

9

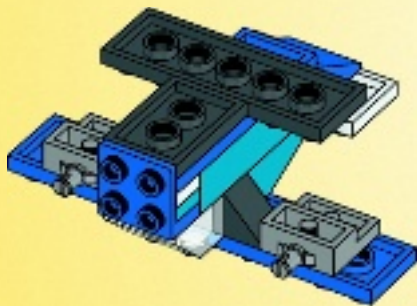
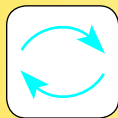



3x



3x



# 10

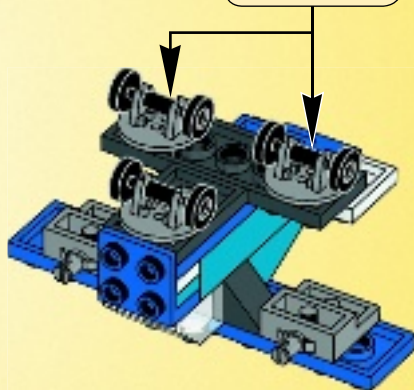



1x



1x

# 11

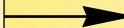
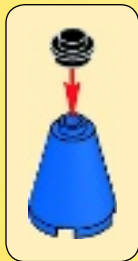
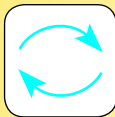



1x



2x

# 12





1x



2x

1





4x

2



1x



1x

3





1x

4





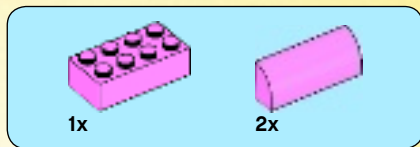

**5**

**1**

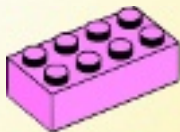

**2**

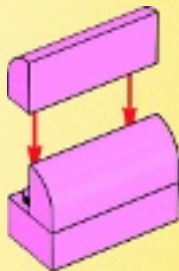

**3**

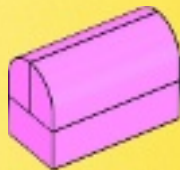



**More ideas online:**  
[LEGO.com/classic](http://LEGO.com/classic)

**More ideas online:**  
**Weitere Ideen online:**  
**Plus d'idées en ligne :**  
**Más ideas en Internet:**  
**Mais ideias online:**  
**Online még több ötletet találsz:**  
**更多在线构思:**  
[LEGO.com/classic](http://LEGO.com/classic)



**LEGO CLASSIC**



10692



10693



10694



10696

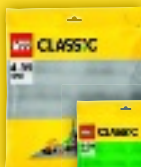

10701

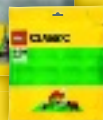

10700



# CREATOR



31030



31031



31032



31033



[LEGO.com/creator](http://LEGO.com/creator)



1x  
300401



1x  
604460



8x  
4567449



2x  
44600



1x  
62150



2x  
6031098



1x  
368001



1x  
30230



2x  
30200



2x  
6029156



2x  
6097402



1x  
40320



2x  
4507685

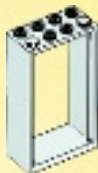

1x  
4528140



1x  
4584888



2x  
455017



1x  
6011794



4x  
4113917



2x  
4593748



2x  
30042



1x  
30032



1x  
30012



1x  
4278275



4x  
4567445



2x  
4651524



1x  
30392



2x  
4515360



2x  
4243814



1x  
30342



1x  
4654448



1x  
6092663



1x  
303923



1x  
4509443



1x  
302023



1x  
379523



1x  
383223



1x  
6037412



6x  
614324



1x  
614124



2x  
6000022



1x  
6104578



1x  
4619524



2x  
6074906



2x  
622740



1x  
4529236



4x  
302326



1x  
6048855



3x  
614126



1x  
4180087



4x  
4508215



3x  
249626



4x  
4273590



2x  
460026



2x  
4289255



2x  
300426



2x  
4529239



1x  
621528



1x  
302228



2x  
4143562



2x  
4211096



1x  
4211043



1x  
4211002



2x  
4621545



2x  
4619599

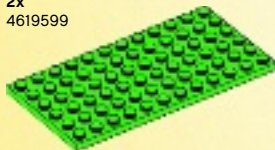

1x  
4541414



3x  
4569382



2x  
6058085



1x  
611644



4x  
4121739



2x  
4518029

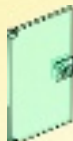

1x  
4520866



1x  
6013633



4x  
4518889



2x  
4599548



4x  
6003003



2x  
4211221



1x  
4262974



2x  
4211150



2x  
4211189



2x  
4211186



1x  
4211247



2x  
6062574



1x  
4624507



3x  
4216581



2x  
4211210



1x  
4211180



1x  
6021566



1x  
4653988



1x  
6029690



1x  
4655172



2x  
6070756



1x  
4540203



2x  
4650645



1x  
4523353



4x  
6011375



3x  
4211373



2x  
6018081



6x  
4517993



1x  
4550359



1x  
6052345



1x  
4621554



2x  
6083614



4x  
4517996



3x  
4520632



1x  
4260493



2x  
4267850



4x  
6104154



2x  
4626935



2x  
4539061



1x  
4539071



1x  
4539104



1x  
4539097



1x  
4164022



1x  
4220631



3x  
4212454



1x  
4504372



2x  
4537928



**Customer Service**

**Kundenservice**

**Service Consommateurs**

**Servicio Al Consumidor**

**LEGO.com/service or dial**



**: 00800 5346 5555**



**: 1-800-422-5346**

# WIN

GO TO [WWW.LEGO.COM/PRODUCTFEEDBACK](http://WWW.LEGO.COM/PRODUCTFEEDBACK) AND  
GIVE US YOUR SHORT **FEEDBACK** ABOUT THIS  
LEGO® SET FOR A CHANCE TO WIN  
A COOL LEGO PRIZE.



## LEGO.com/productfeedback

### GEWINNE



Erzähle uns auf  
[www.LEGO.com/productfeedback](http://www.LEGO.com/productfeedback)

etwas über die Erfahrungen, die  
du mit diesem LEGO® Set gemacht  
hast, und sichere dir die Chance auf  
einen coolen LEGO Preis!

### GAGNE



Rends-toi sur  
[www.LEGO.com/productfeedback](http://www.LEGO.com/productfeedback)

et donne-nous quelques commen-  
taires sur ce produit LEGO® pour  
avoir une chance de gagner un  
prix LEGO !

### GANA



Visita  
[www.LEGO.com/productfeedback](http://www.LEGO.com/productfeedback)

y envíanos tu opinión acerca de este  
set LEGO®. ¡Participarás en el sorteo  
de un premio LEGO!

### 获取奖品



登录  
[www.LEGO.com/productfeedback](http://www.LEGO.com/productfeedback)

给出关于此乐高®套装的简短反馈，  
就有机会获得炫酷乐高奖品

LEGO and the LEGO logo are trademarks of the LEGO Group. ©2015 The LEGO Group.

6117825