



LEGENDS OF

CHIMA

TM

70134





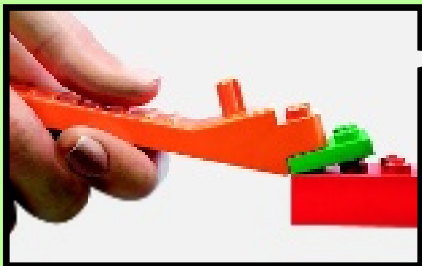
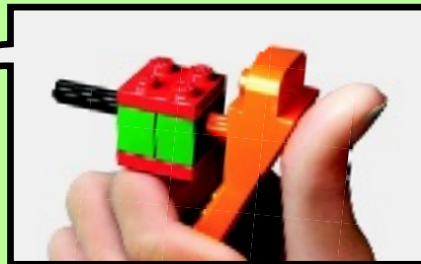

LEGO.com/brickseparator



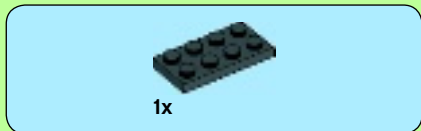

1

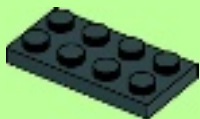

2

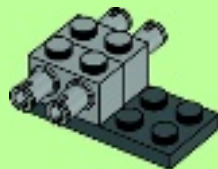

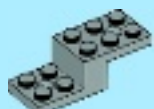

1x

3

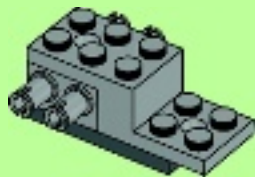

6



2x



2x

4

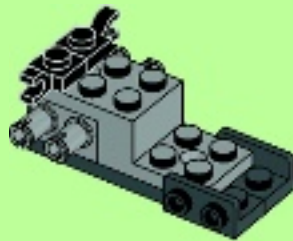



2x

5

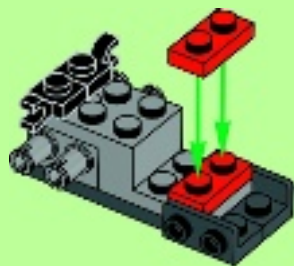

1x

6

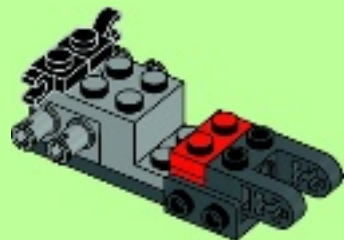



2x

7

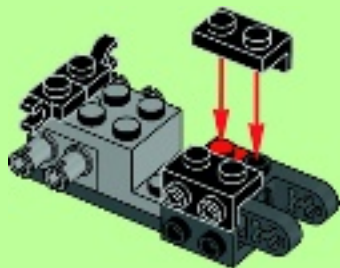

8



2x

8

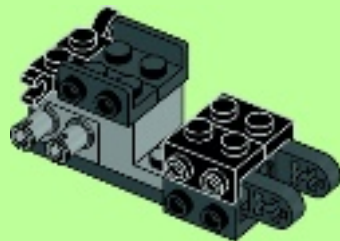



2x



1x

9

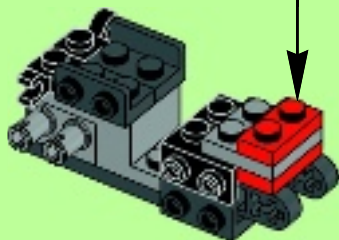
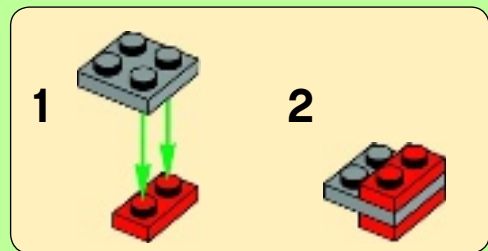

2x

10

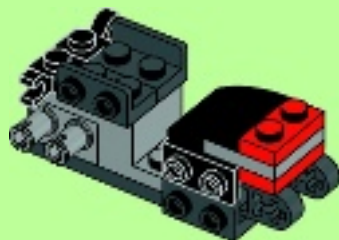



1x

11

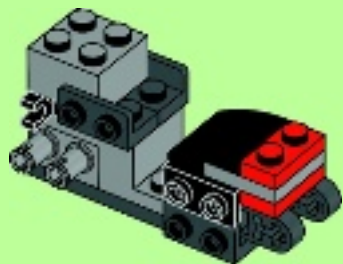

1x



1x

12

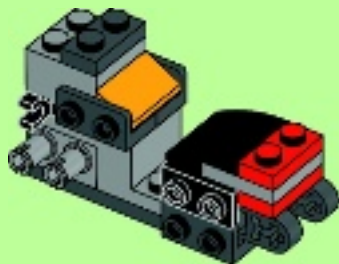



13

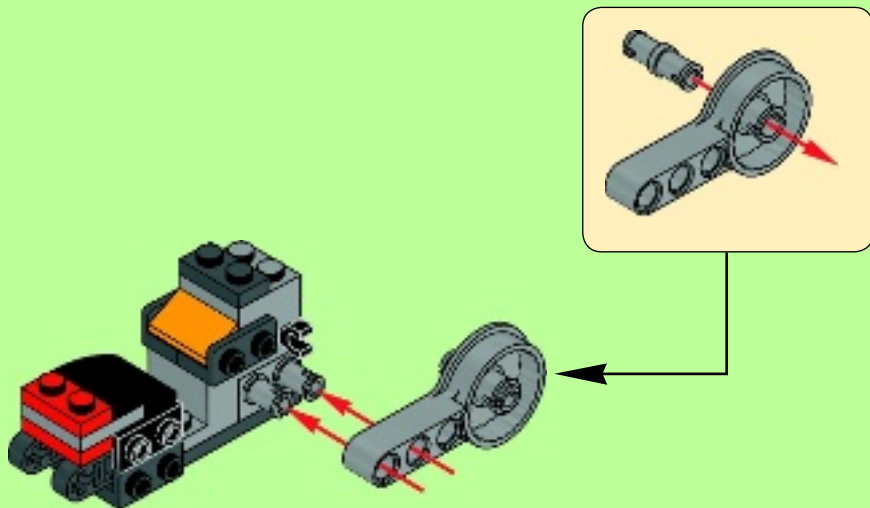



14

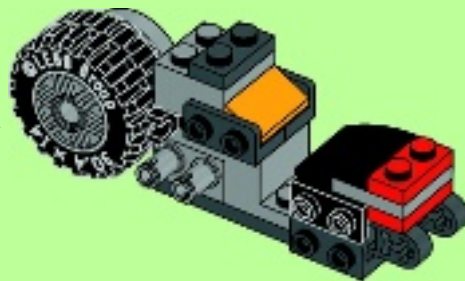
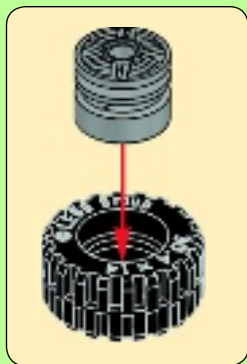



15

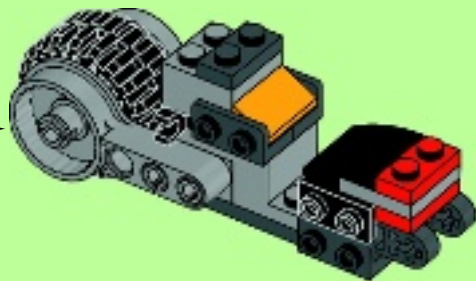
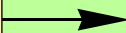
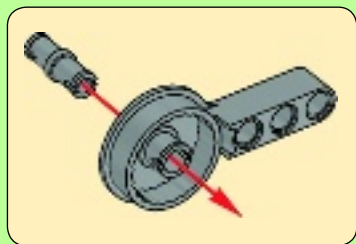

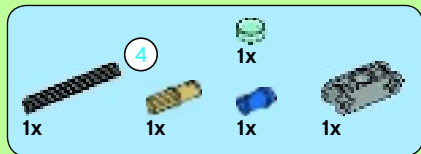

16

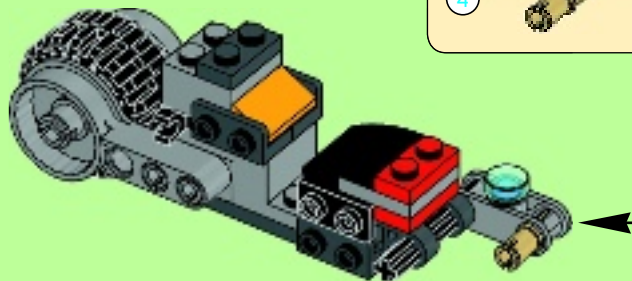
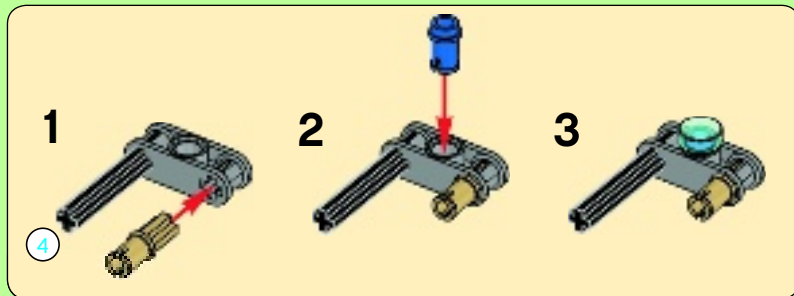



17

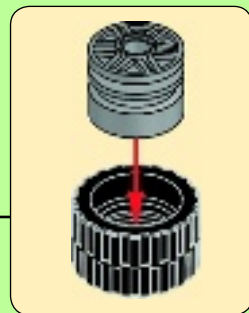
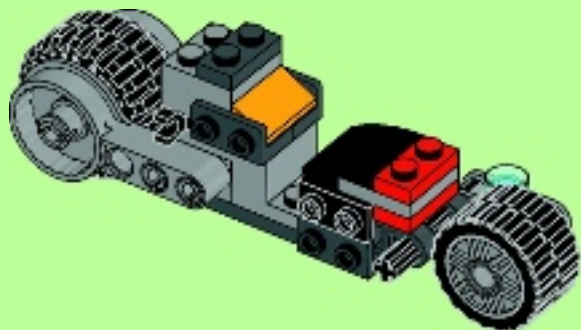



1x



1x



1x



1x

18

1

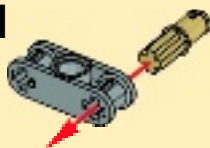

2

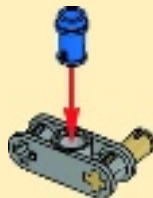

3

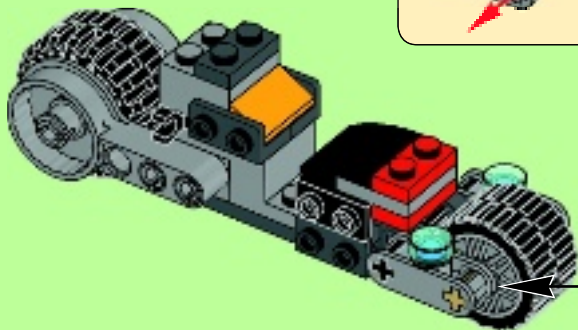



1x

19

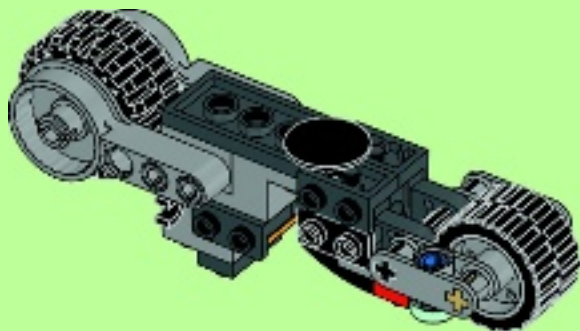
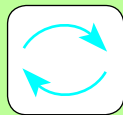



20

1



2



3

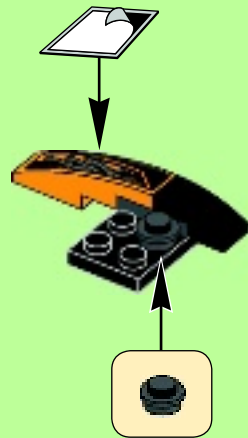



21

1



2



3



4

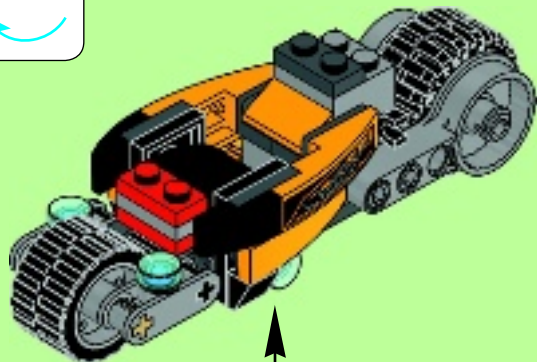



22

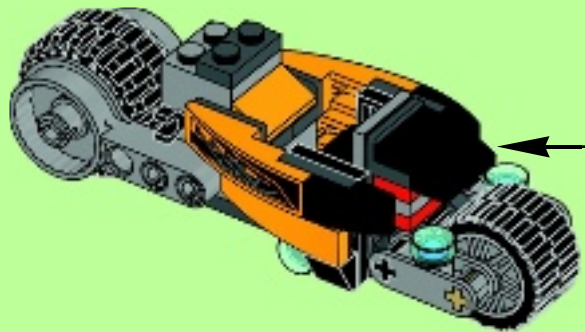

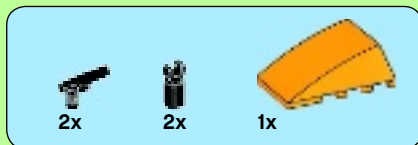

23

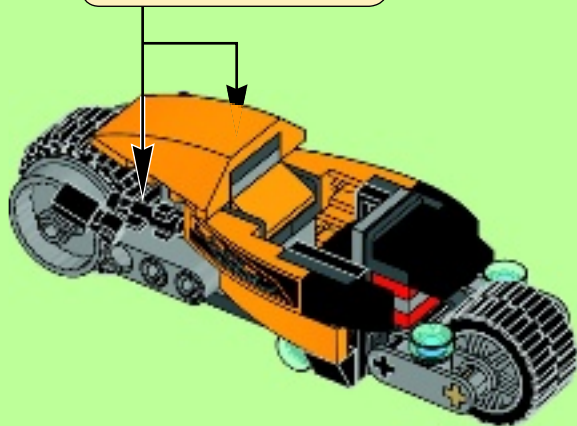

24

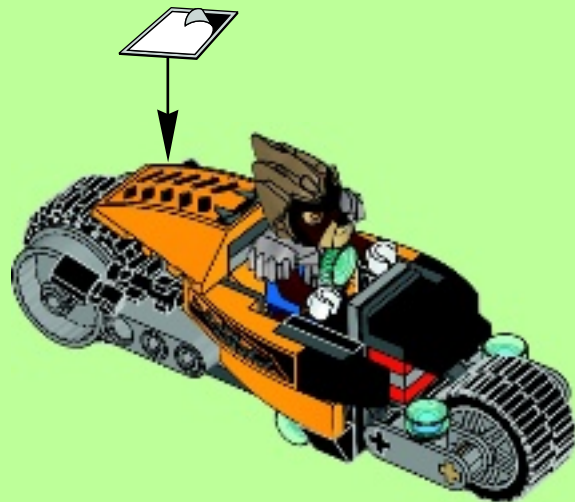



1x

1

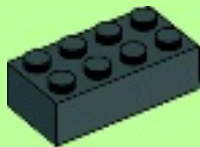

1x



2x

2





2x



1x

3





2x

5

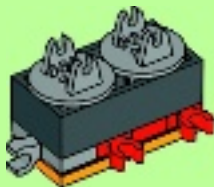
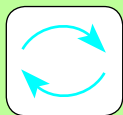

2x

6





7

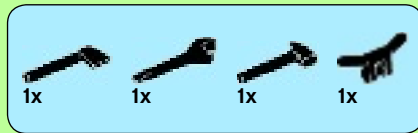
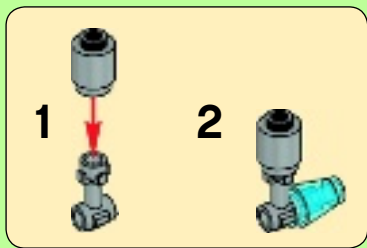

8



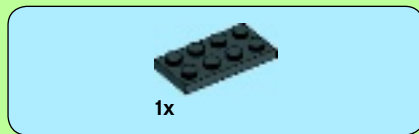
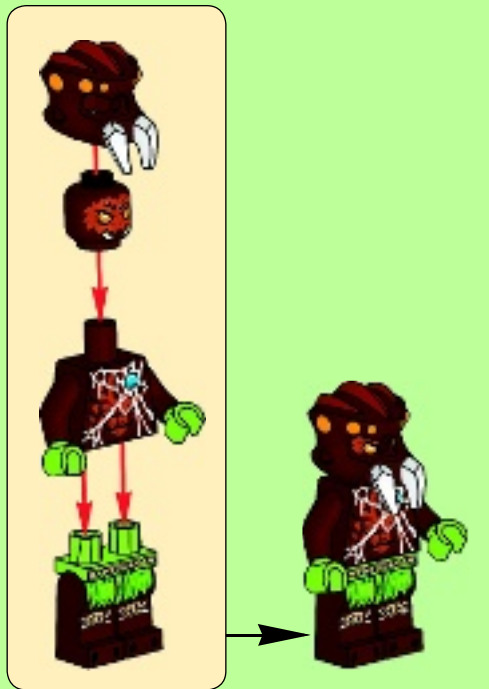

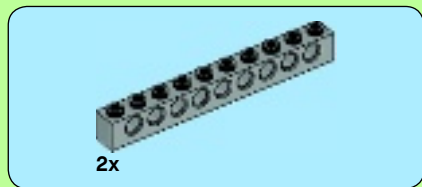

2



3

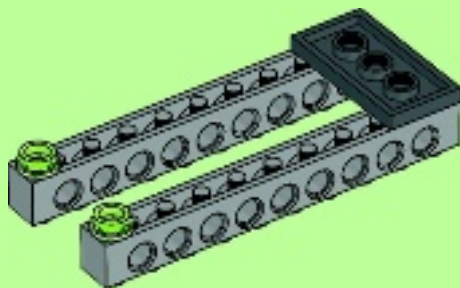
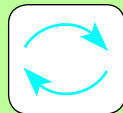

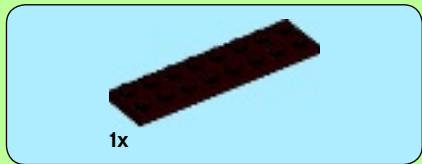

4

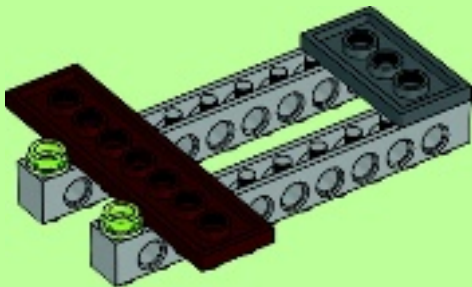

5

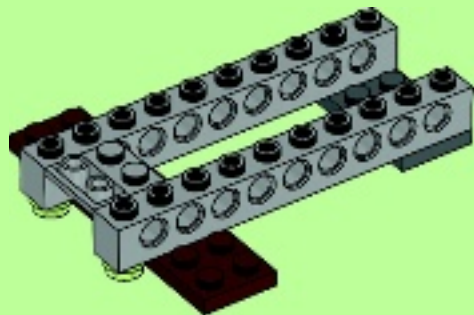



6

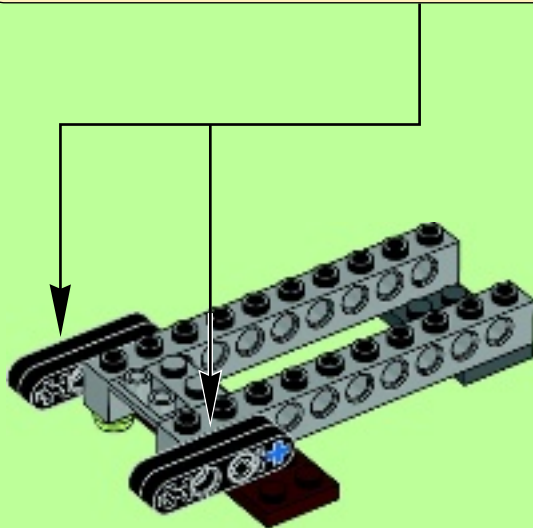
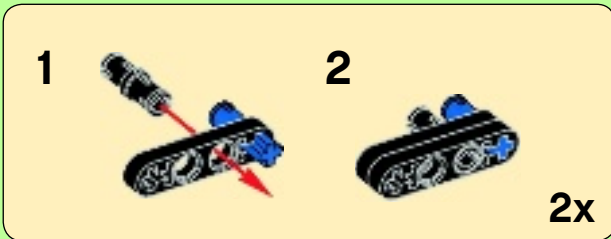



2x

7

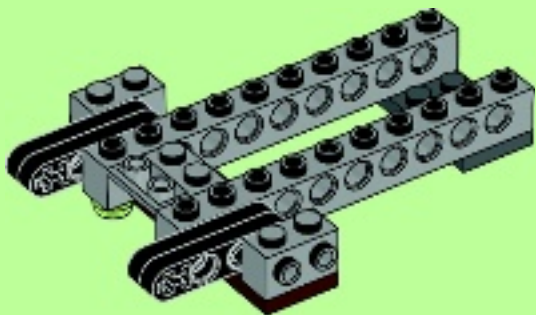

1x

8

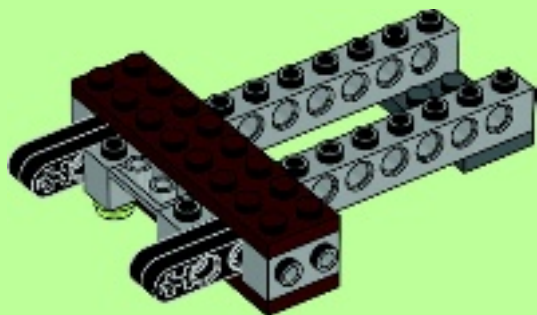



2x



2x

9

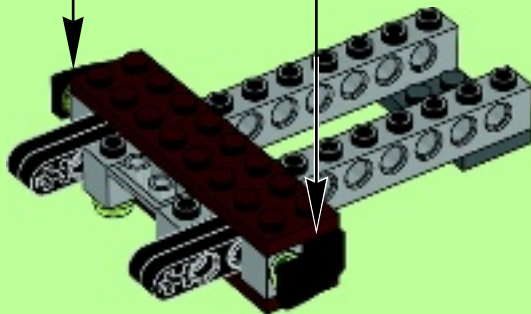



2x



1x



1x

10

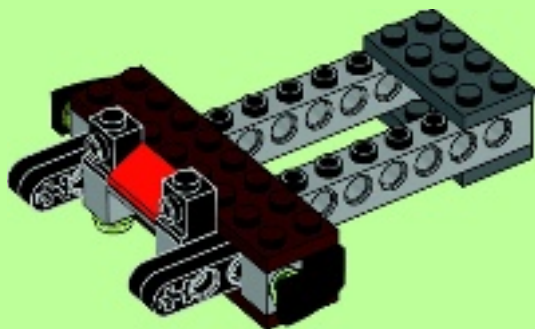

1x



1x



1x

11

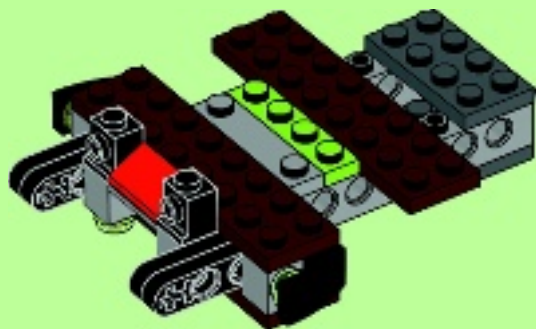



12

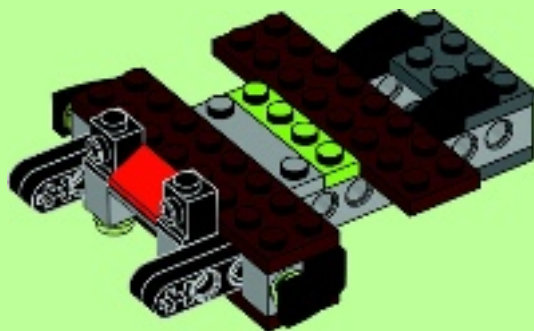

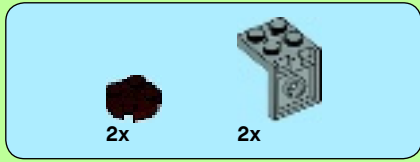

13

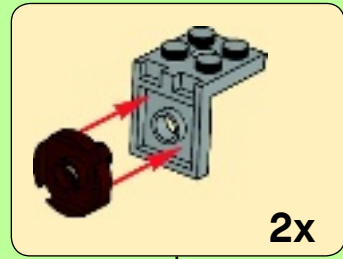
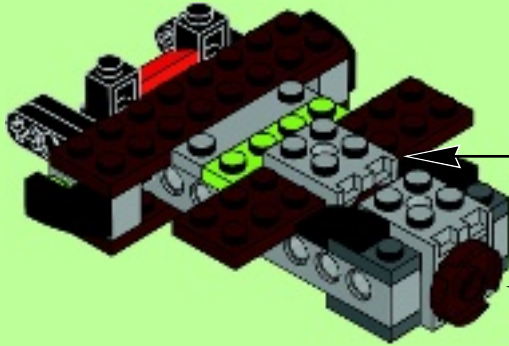

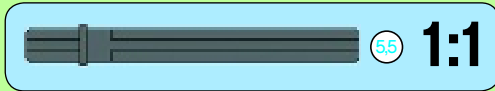
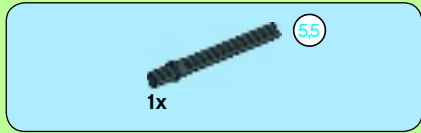

14

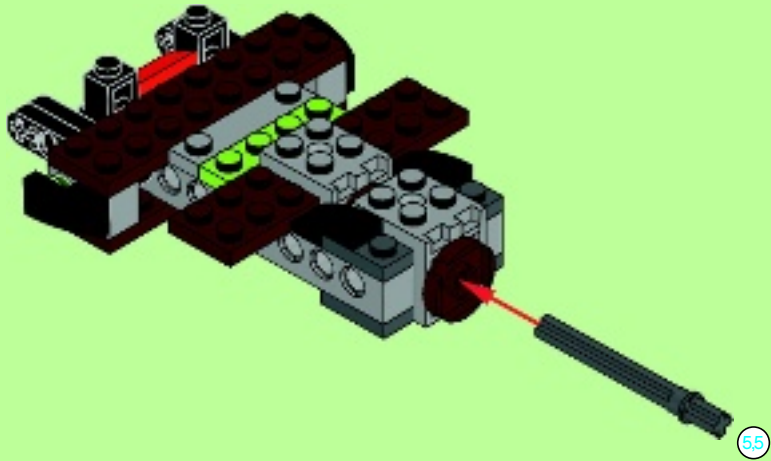



1x



2x

15

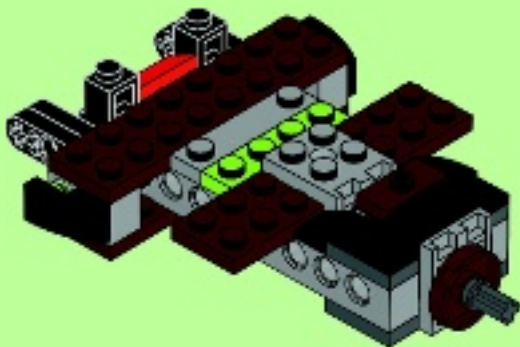

2x

16

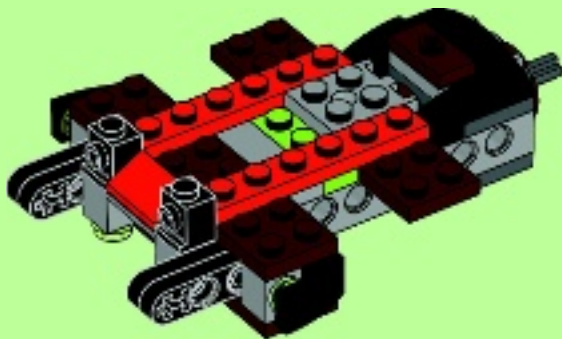



2x



2x



1x

17

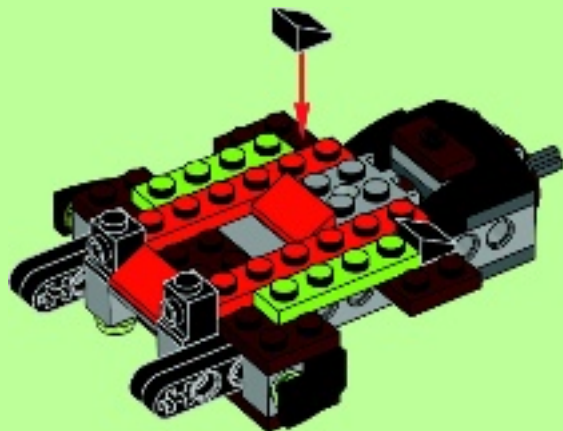

2x



4x

18

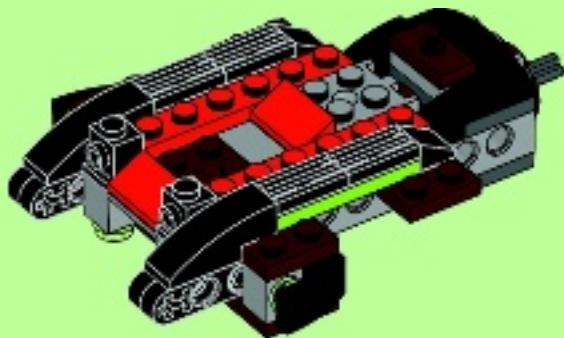



1x



2x

19

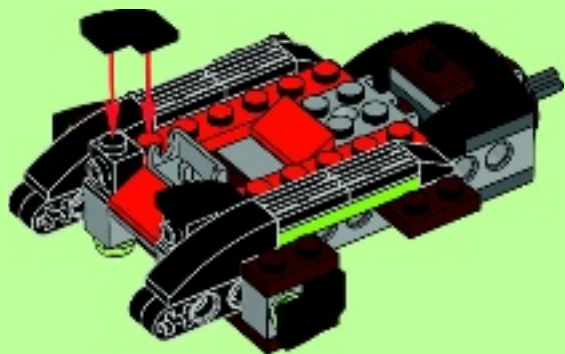

1x



2x



2x

20

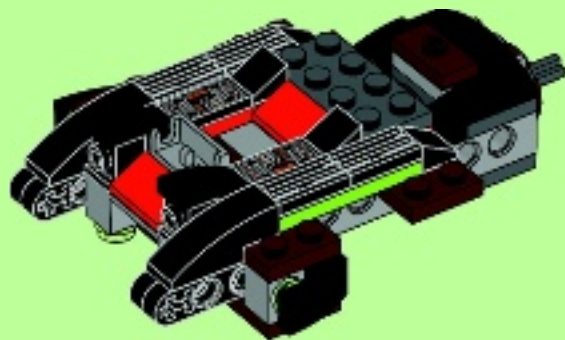



1x



2x

21

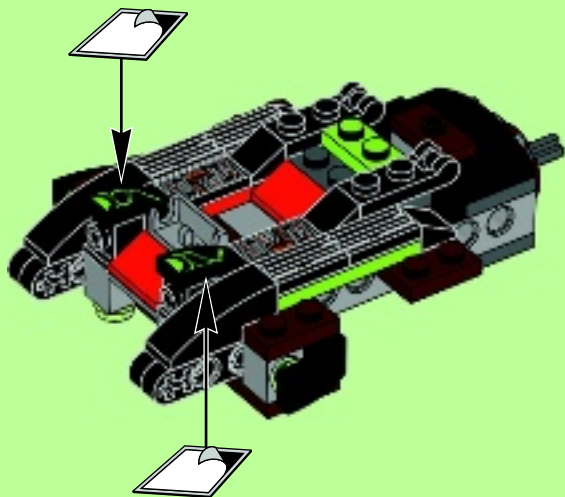

1x



1x



2x

22

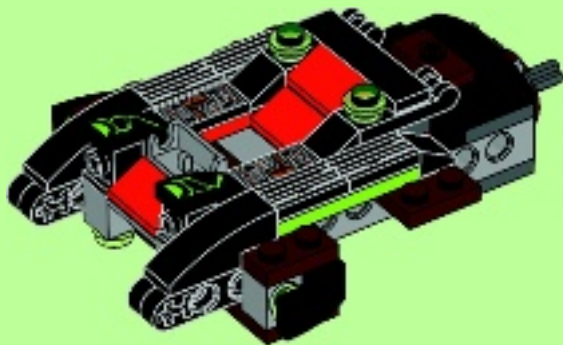



1x



4x

23

1



2

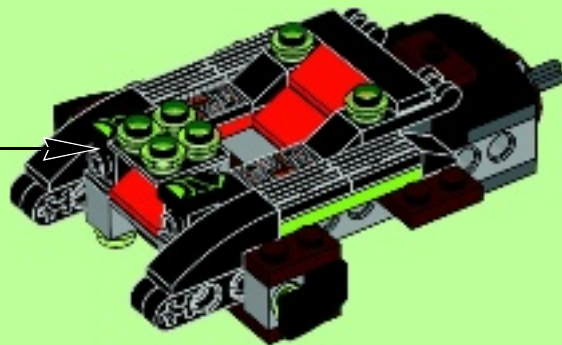

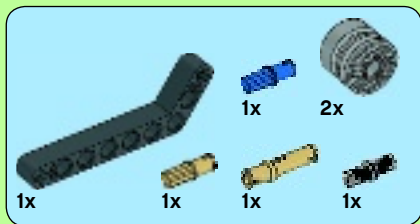

24

1

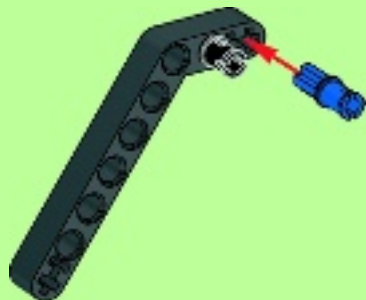

2

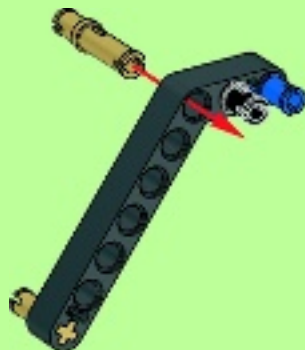

3

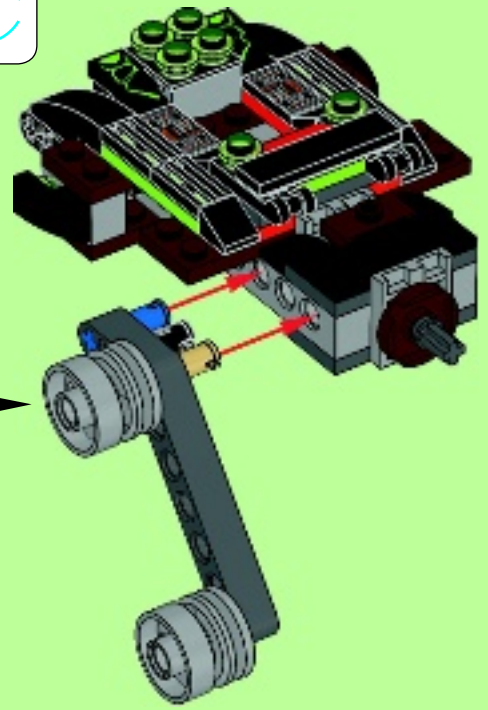
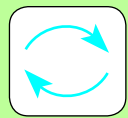

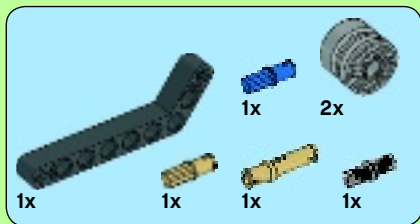

25

1



2



3

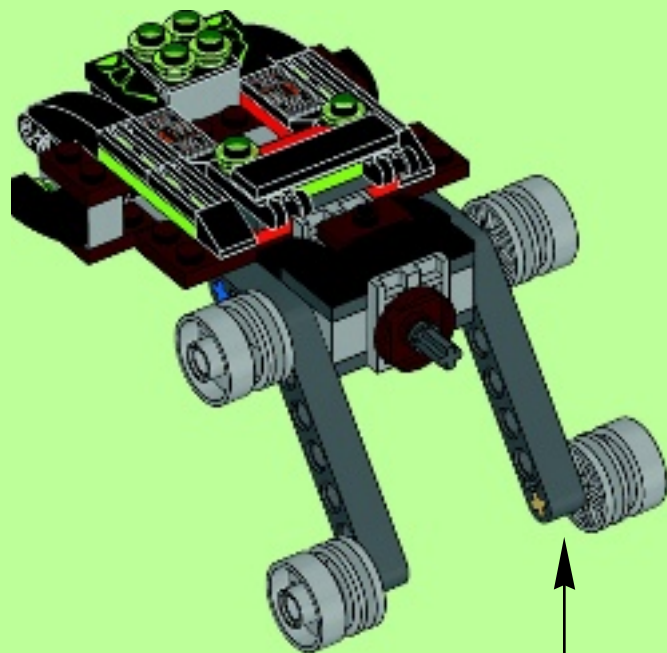
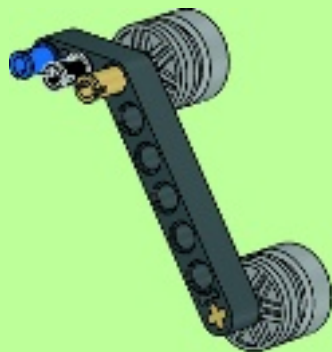



2x

26

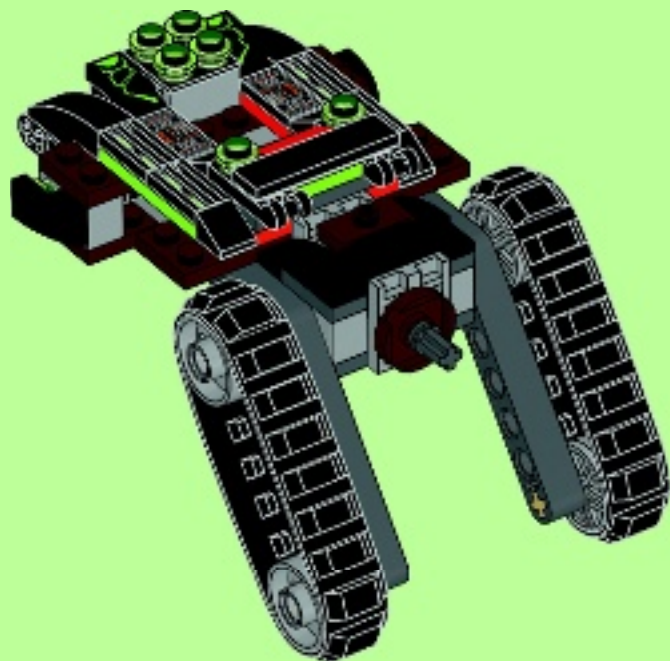

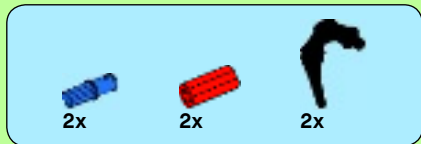

27

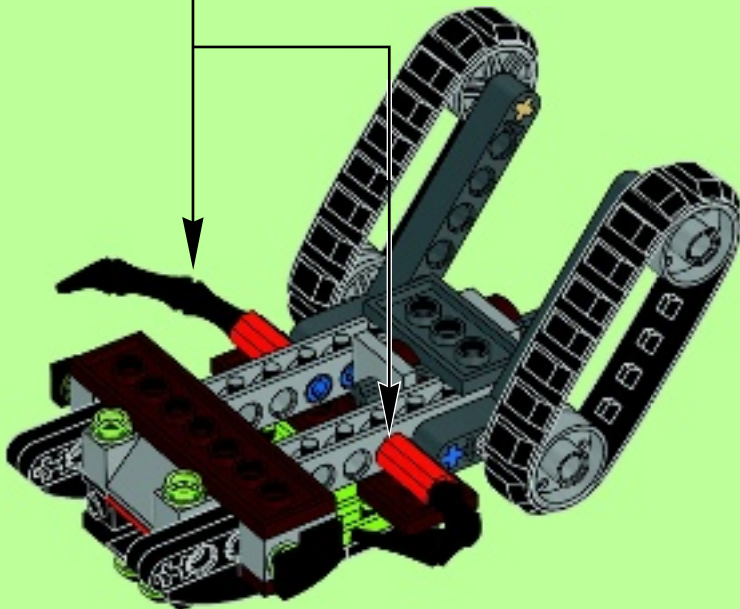
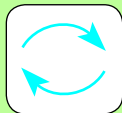
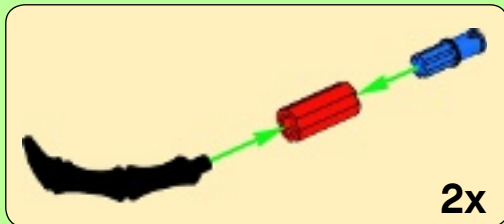



28

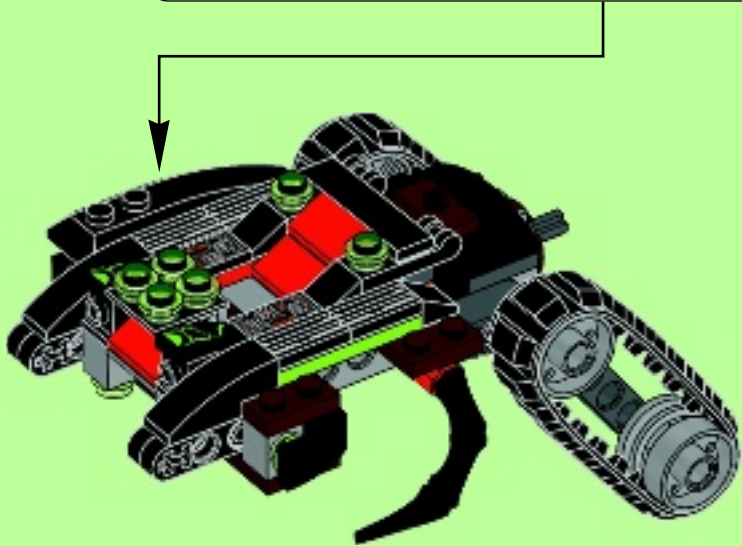
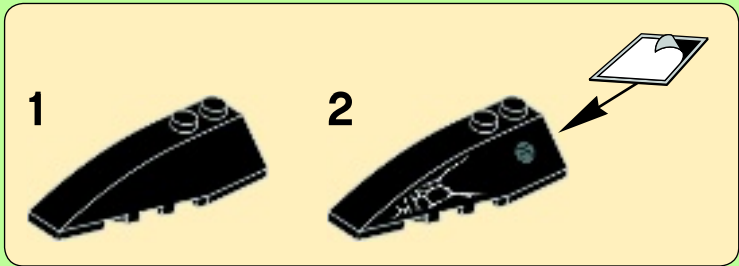



29

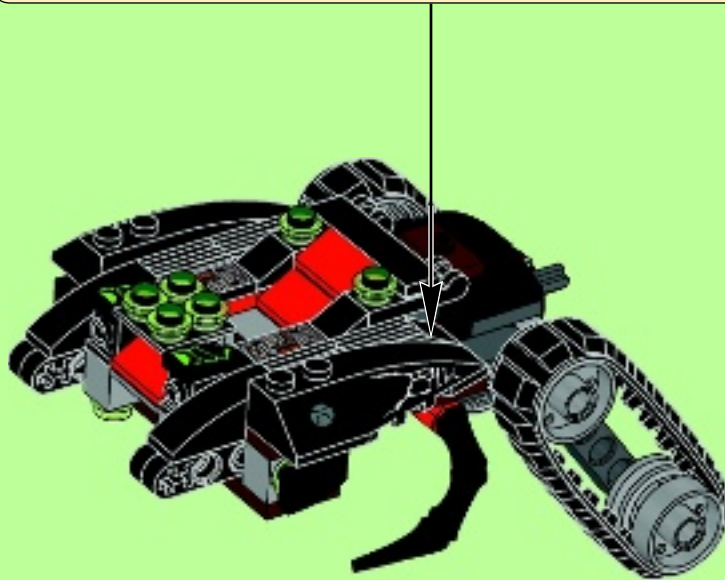
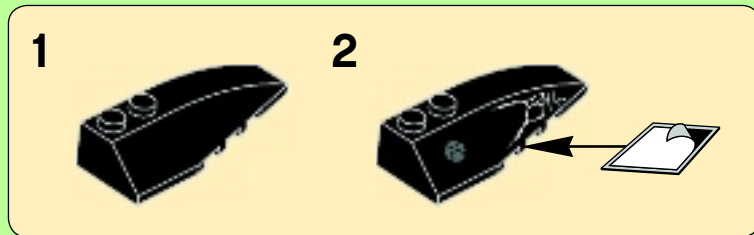

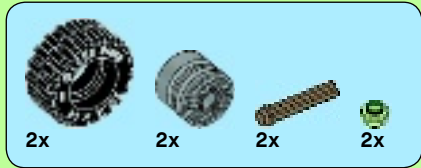

30

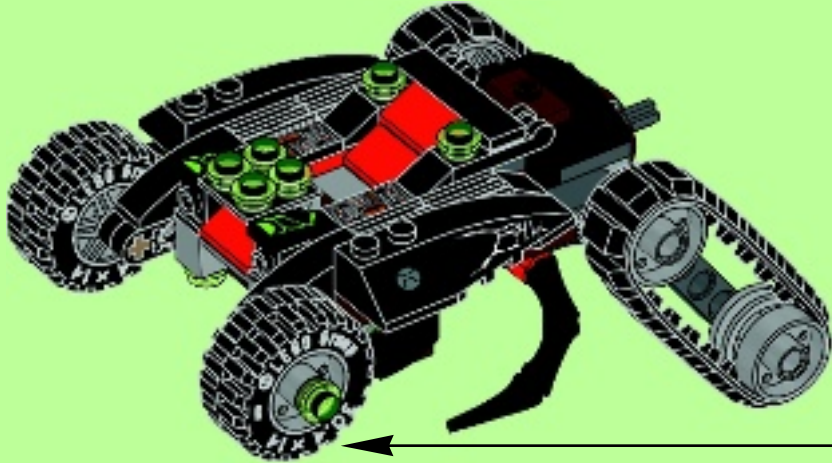
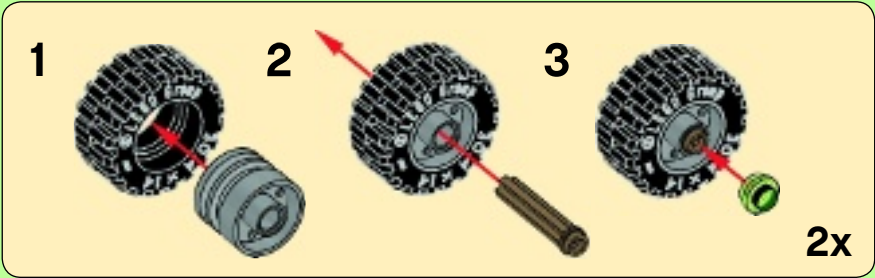



2x

31

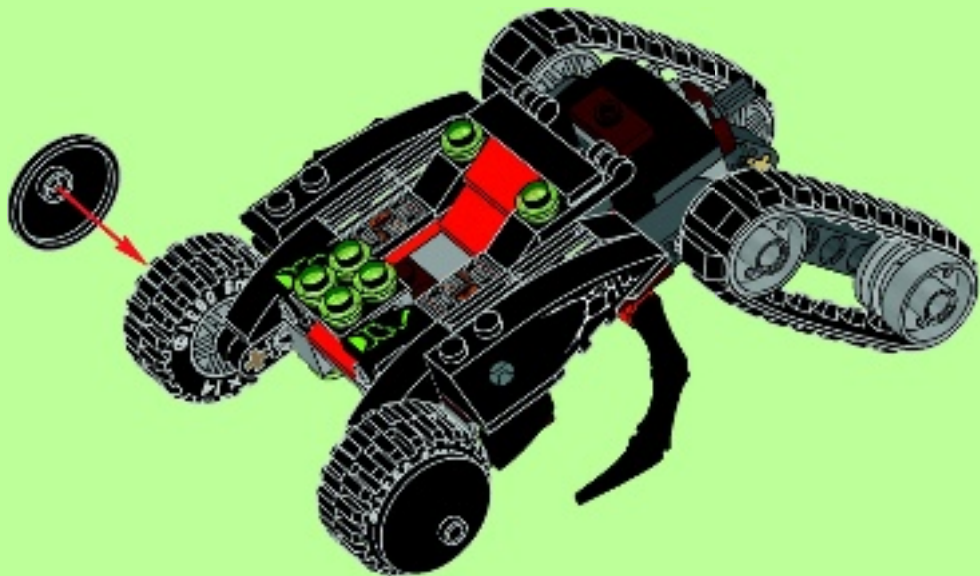



32

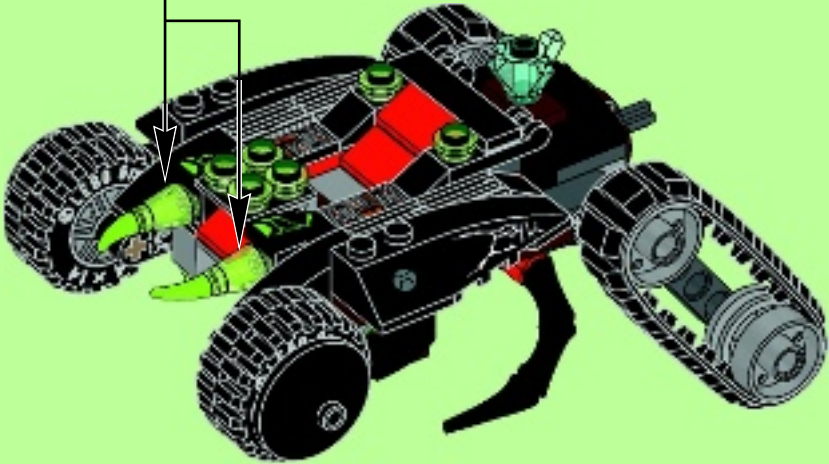
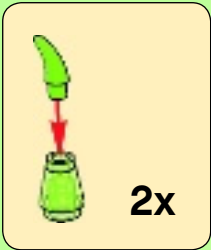



33

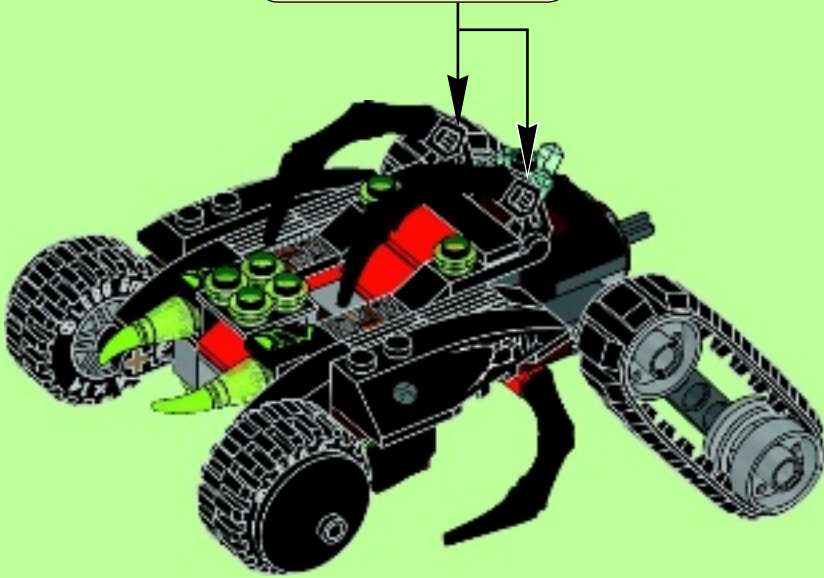
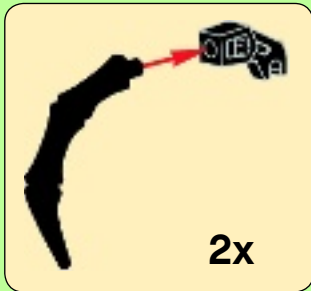



1

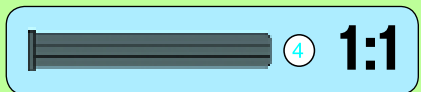
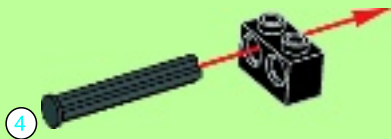

2

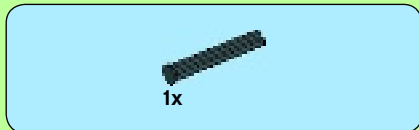

3

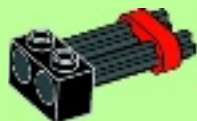



4

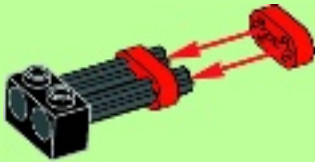

5

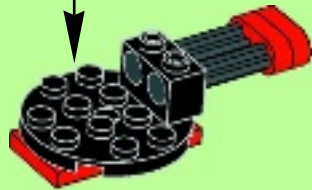
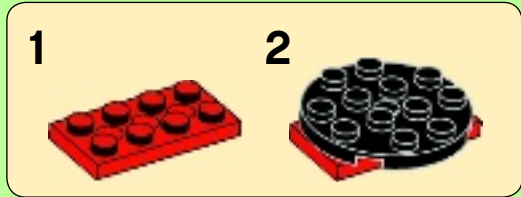



1x



1x

6

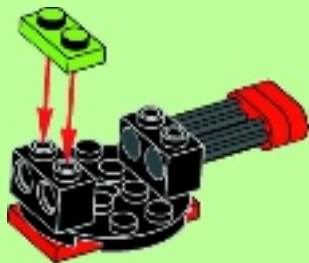



7

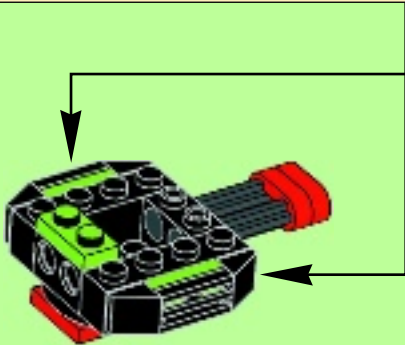



8



9

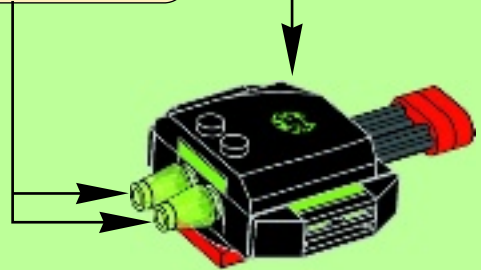
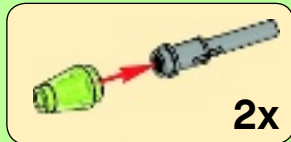



10

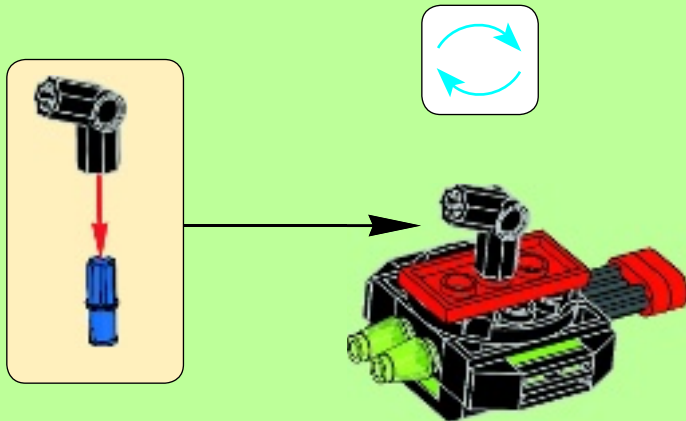

34

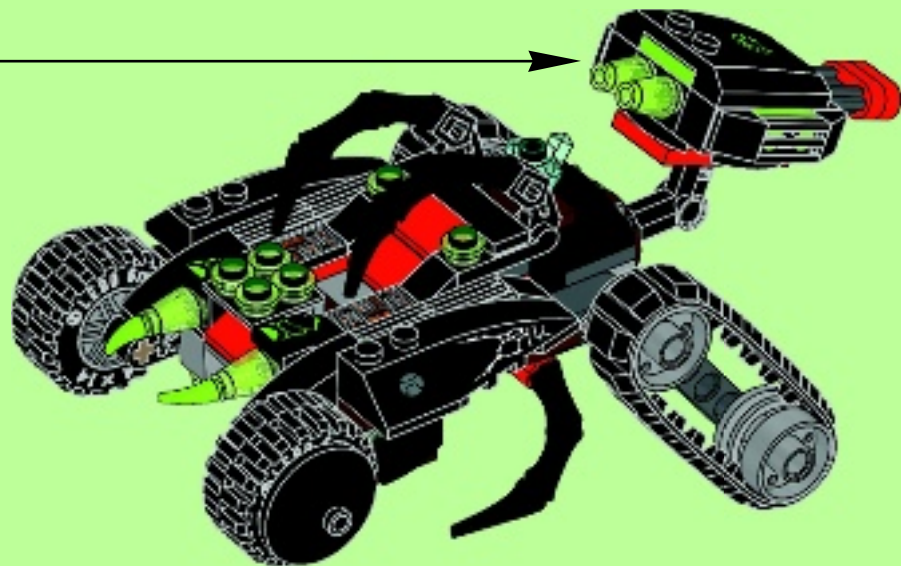

35

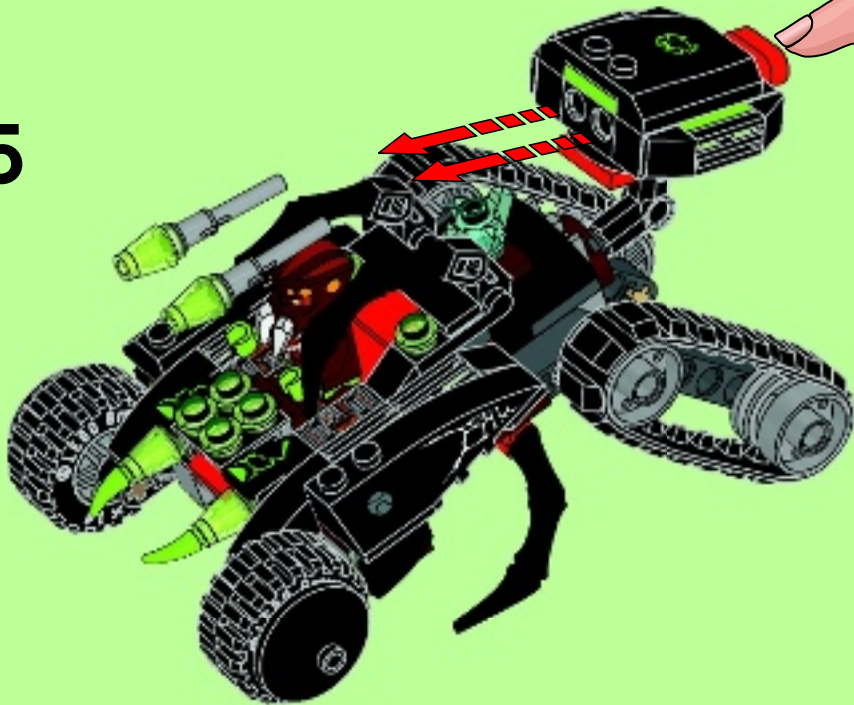



club™

Free*! Gratuit!

* Paid subscription in Australia and New Zealand.
Abonnement payant en Australie et Nouvelle-Zélande



© 2014 The LEGO Group



LEGO.com/club



WIN!

Go to LEGO.com/productfeedback to fill out a survey for a chance to win a cool LEGO® Product.

No purchase necessary.
Open to all residents where not prohibited.



LEGO.com/productfeedback

GEWINNE!

Nimm an der Umfrage auf LEGO.com/productfeedback teil und hab die Chance ein cooles LEGO® Produkt zu gewinnen!

Die Teilnahme am Gewinnspiel führt zu keinerlei Kaufverpflichtungen. Teilnahme in allen nicht ausgeschlossenen Ländern möglich.

 LEGO.com

6074005

WIN!

Ga naar LEGO.com/productfeedback, vul een enquêteformulier in en maak kans op een cool LEGO® product.

Geen aankoopverplichting.
Iedereen mag deelnemen, uitgezonderd ingezetenden van landen waar een enquêteverbod geldt.

GAGNE!

Visite LEGO.com/productfeedback pour répondre à un questionnaire et avoir une chance de gagner un produit LEGO® très cool!

Aucune obligation d'achat.
Ouvert à tous les résidents des pays autorisés.

当てよう!

LEGO.com/productfeedback にアクセスして、アンケートにご記入ください。当選者にはレゴ®製品を差し上げます。

お買い上げの必要はありません。
禁止されていない限り、すべての皆様にご利用いただけます。

LEGO, the LEGO logo and LEGENDS OF CHIMA are trademarks of the LEGO Group.
©2014 The LEGO Group.



LEGENDS OF

CHIMA

TM



70134

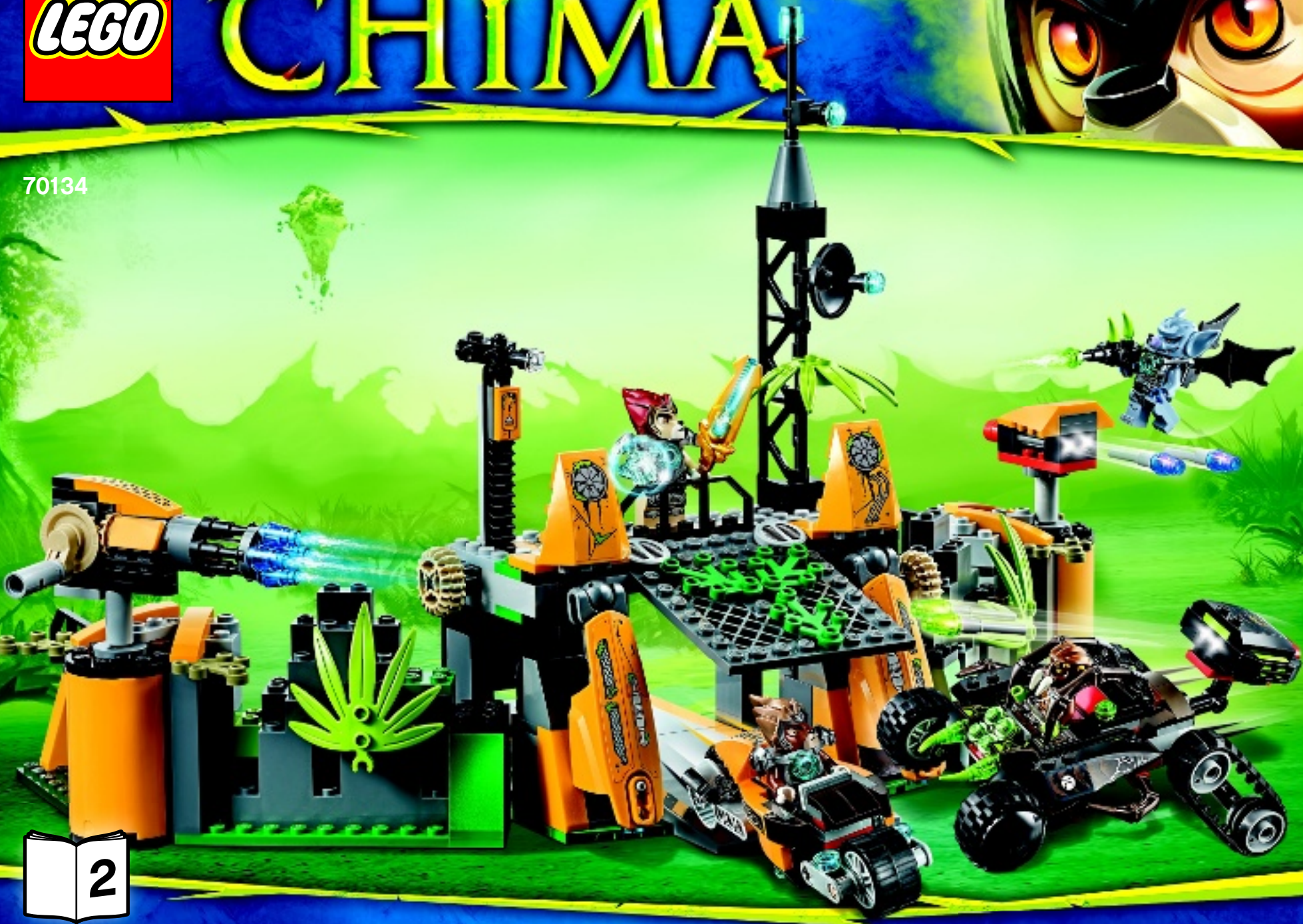

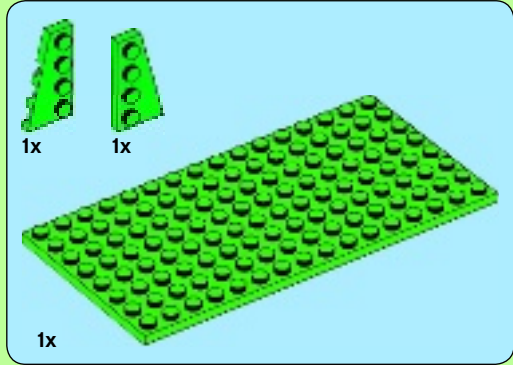
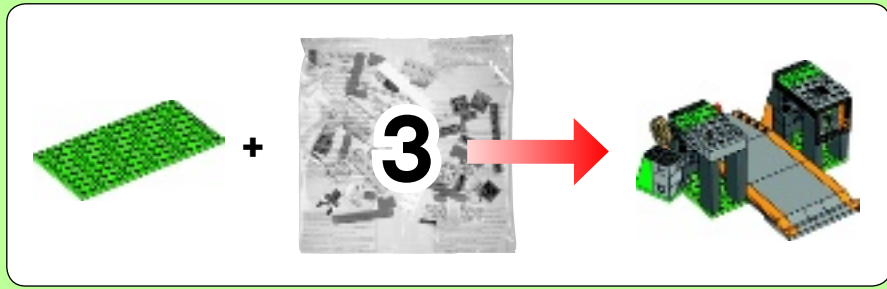

1

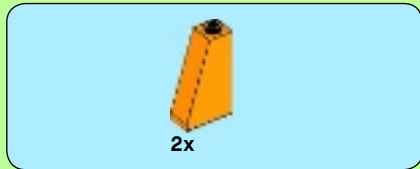
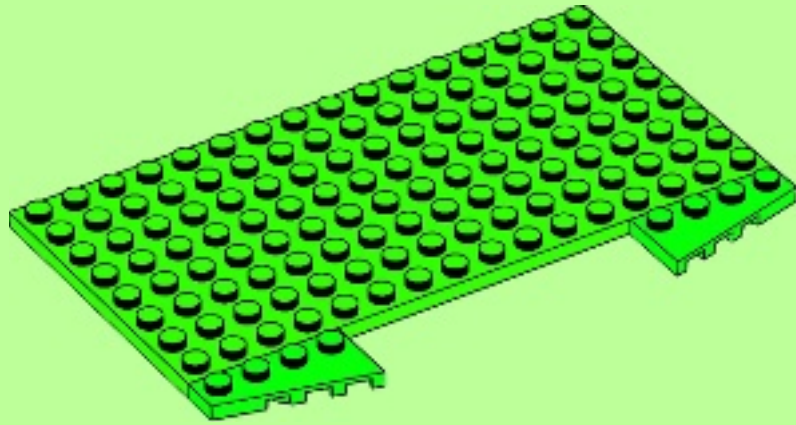

2

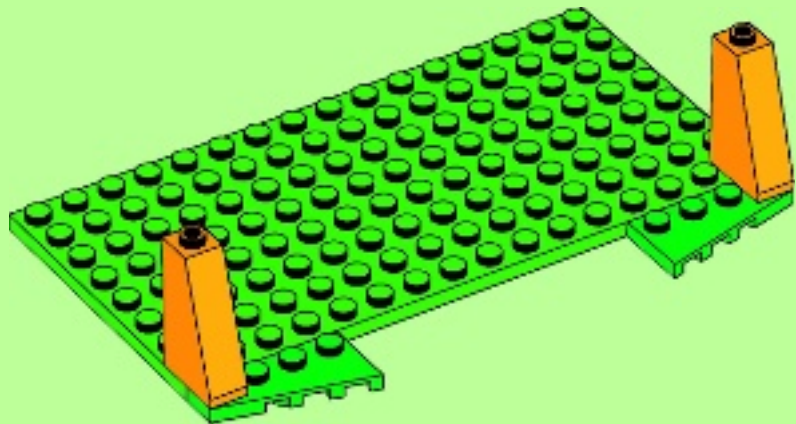



3

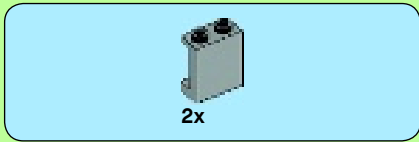
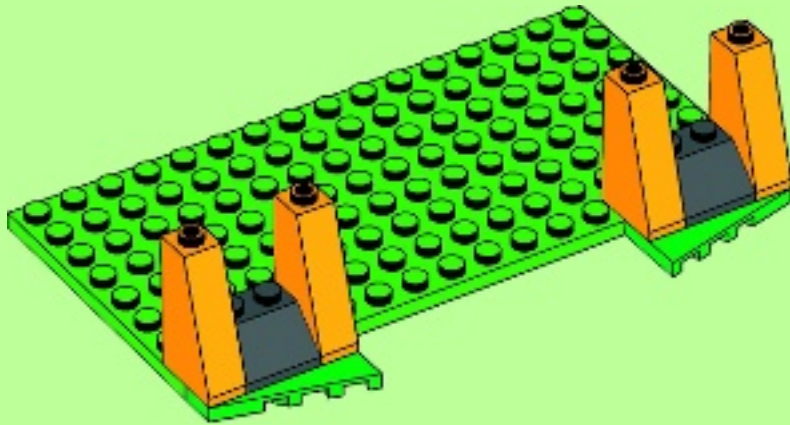

4

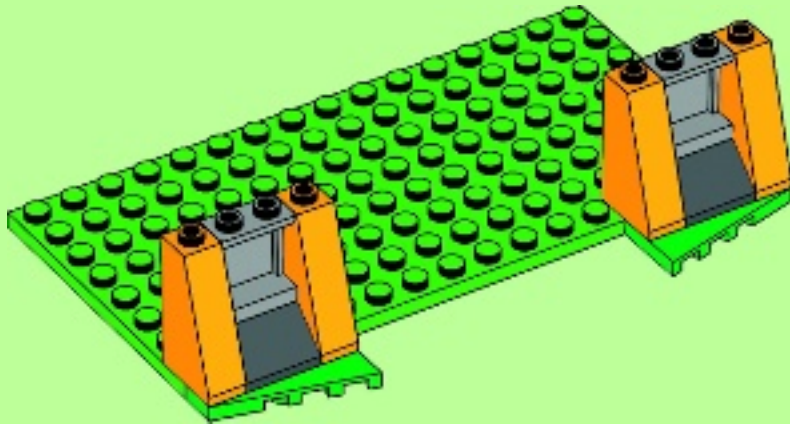

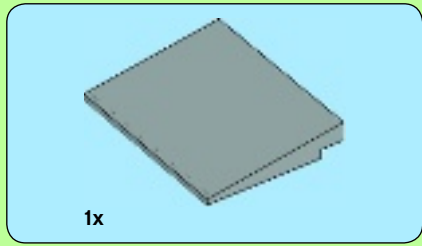

5

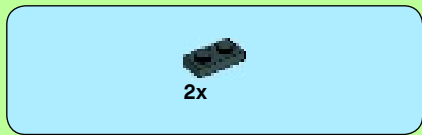
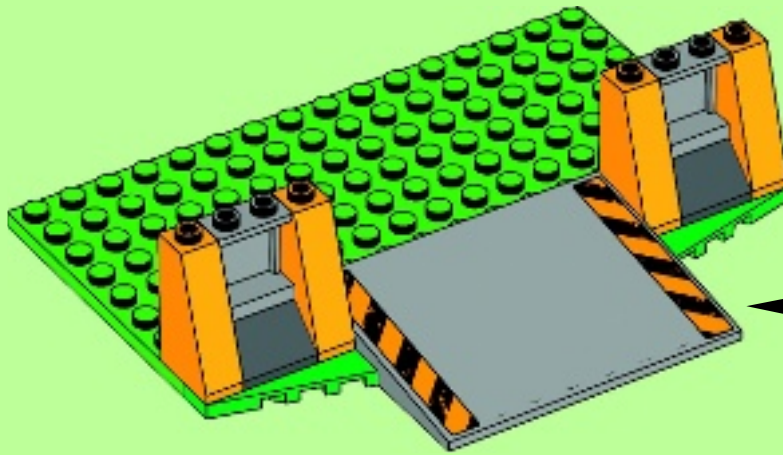
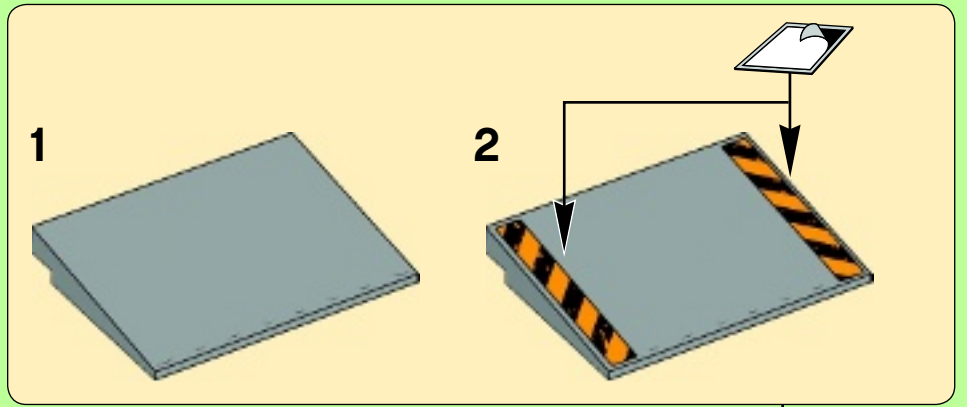

6

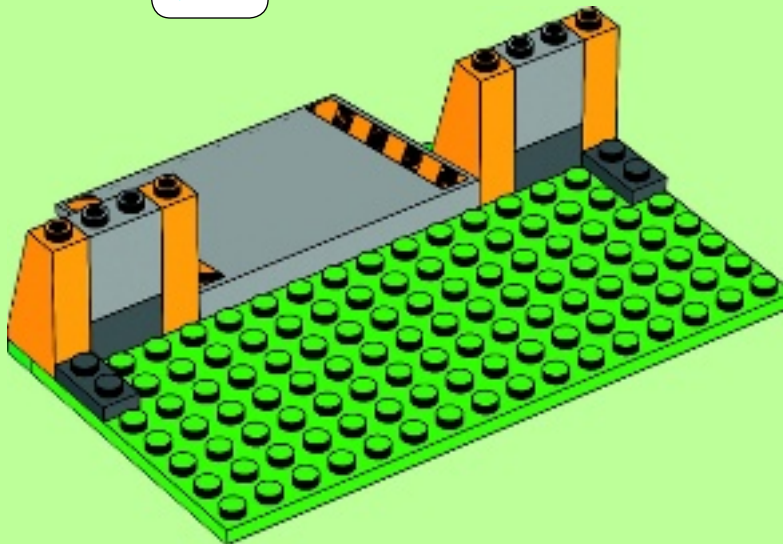
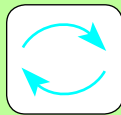

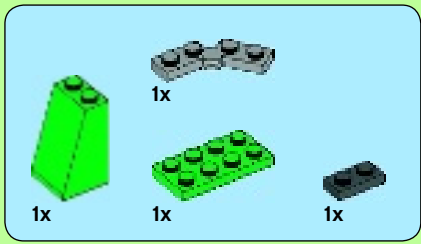

7

1

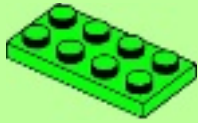

2

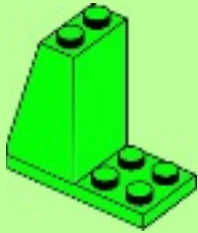

3

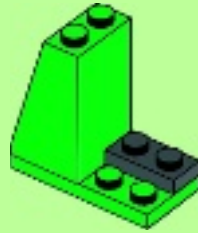

4

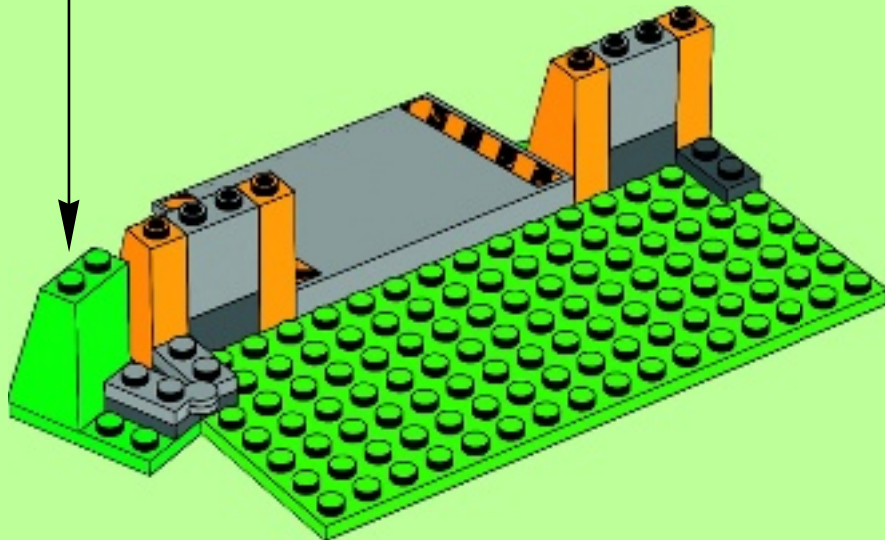
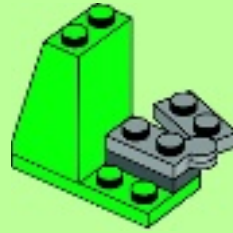

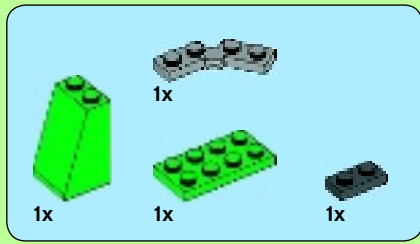

8

1

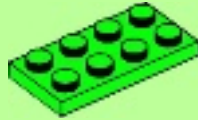

2

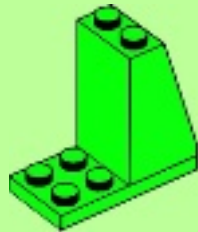

3

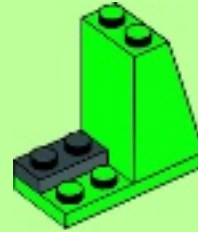

4

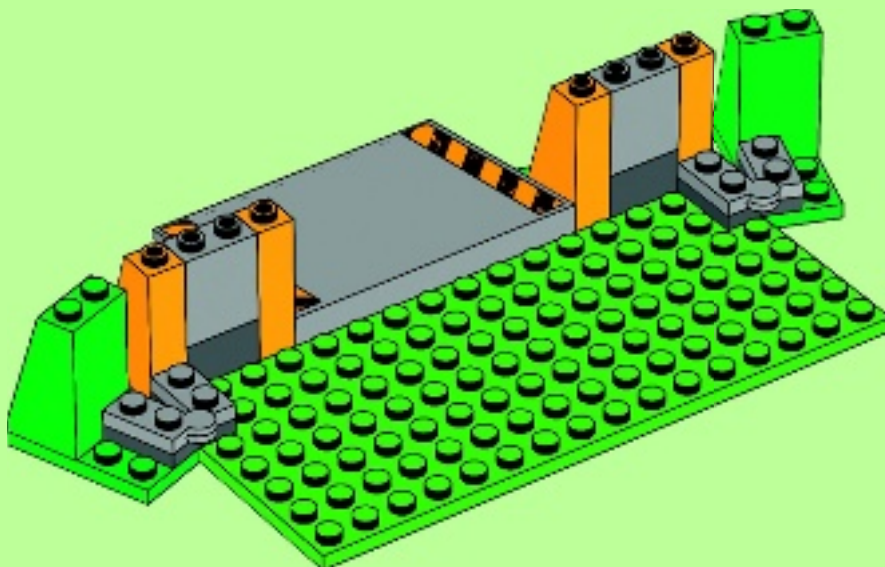
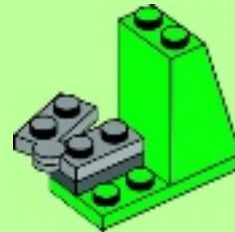



4x



2x

9

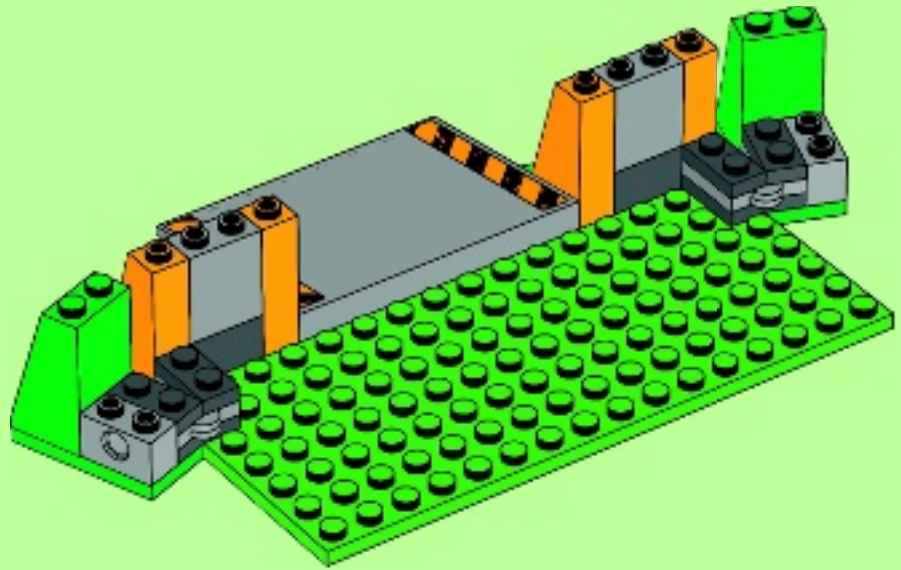

2x

10

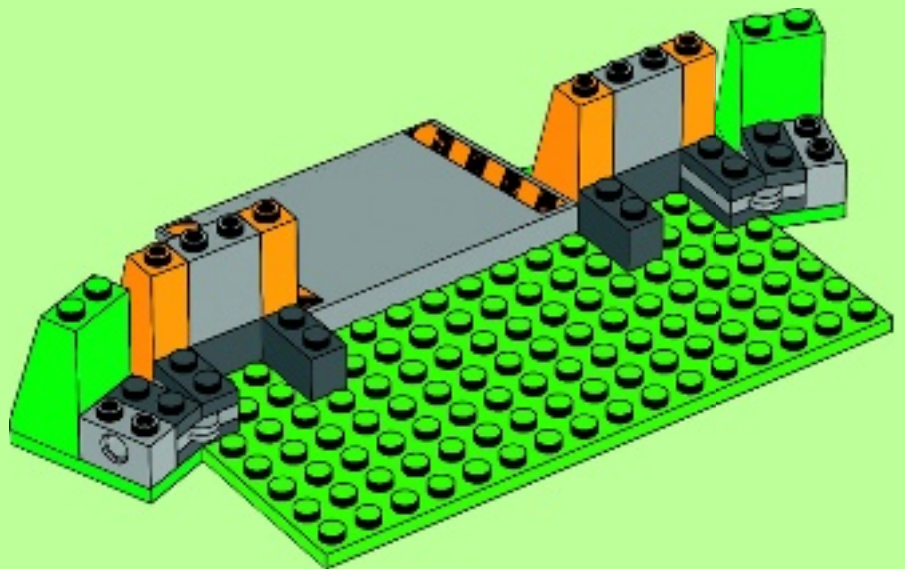

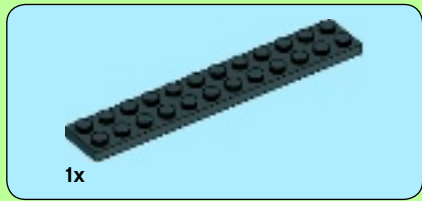

1

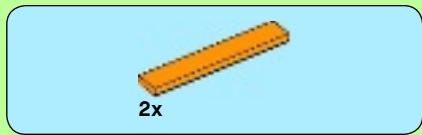
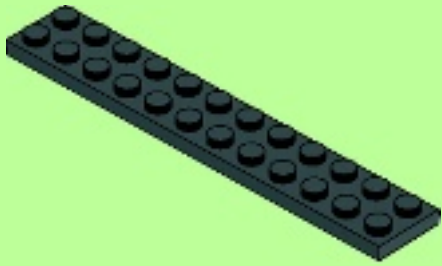

2

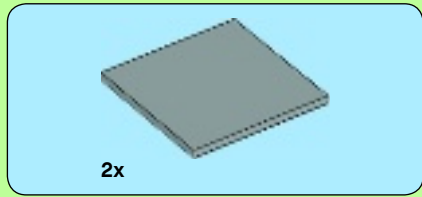
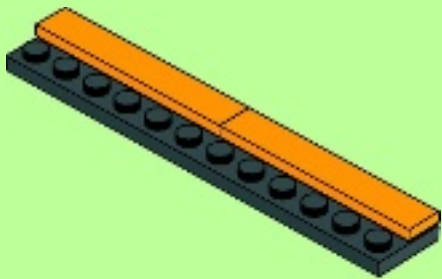

3

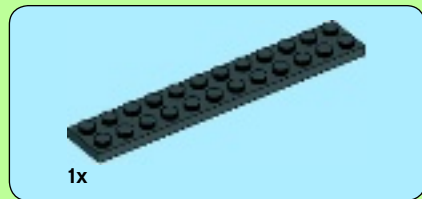
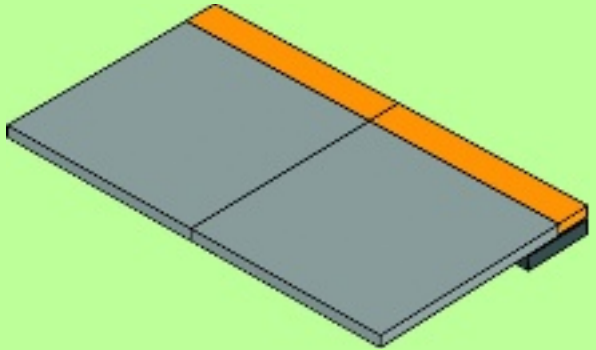

4

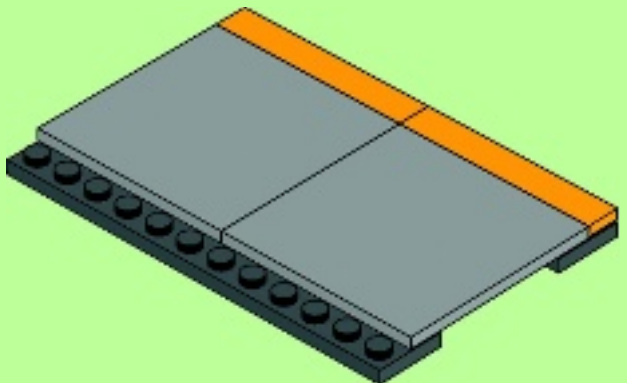

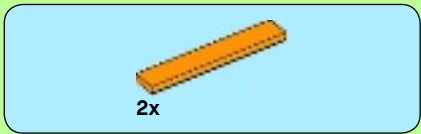

5

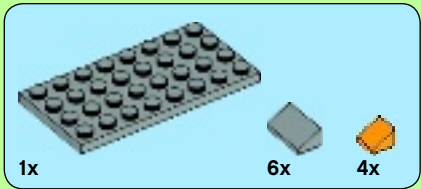
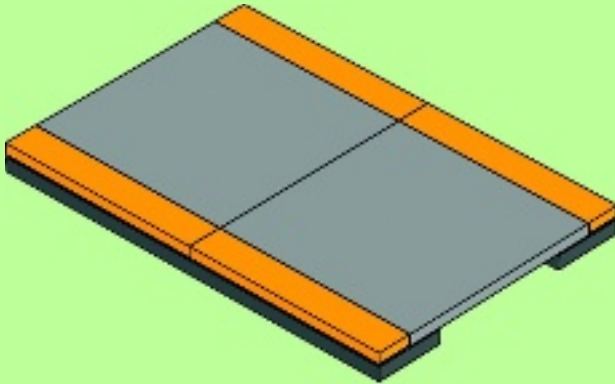

6

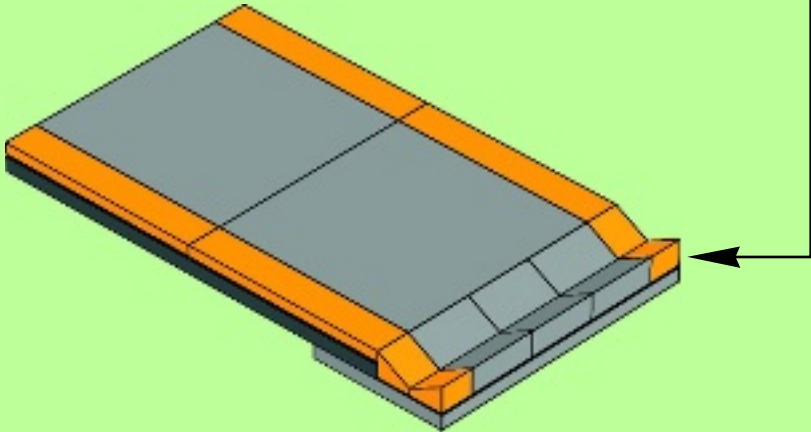
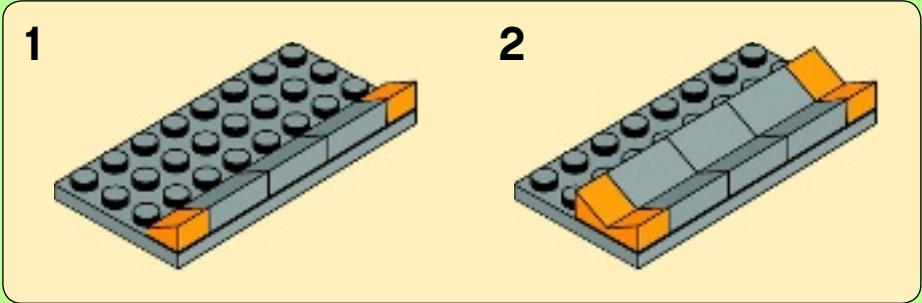

11

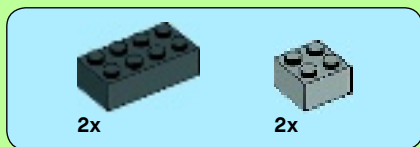
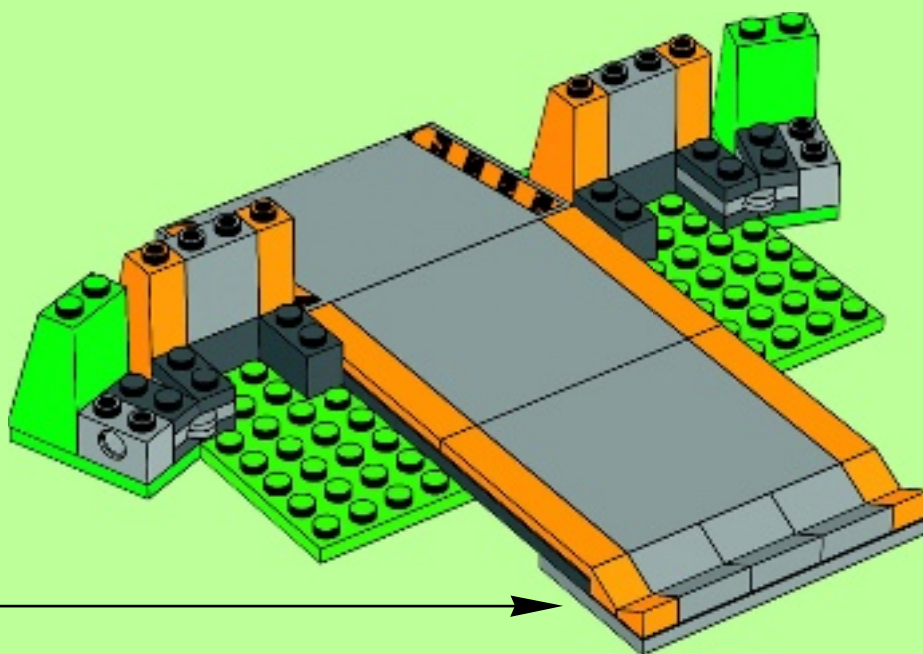

12

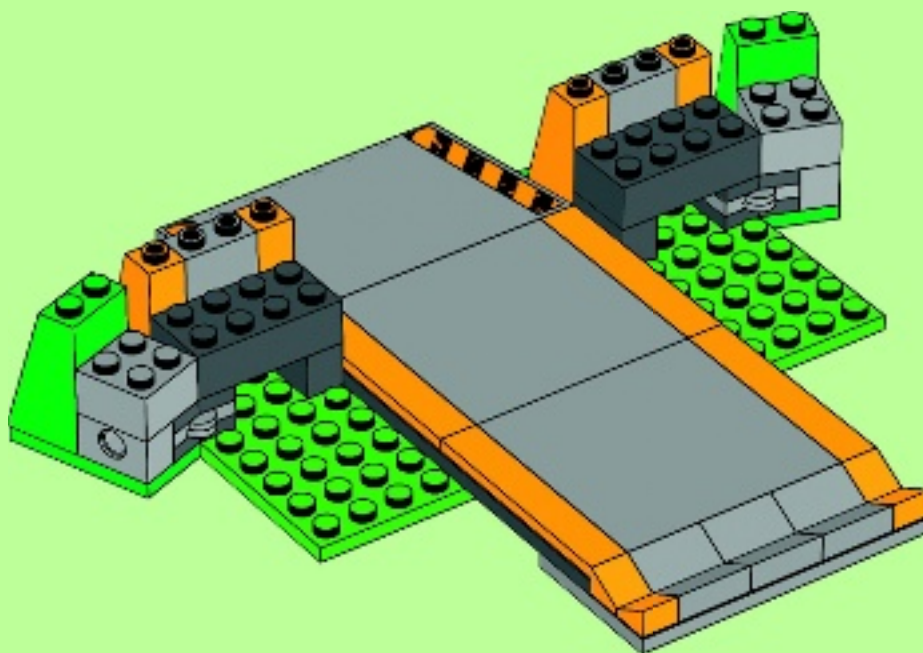



4x



2x

13

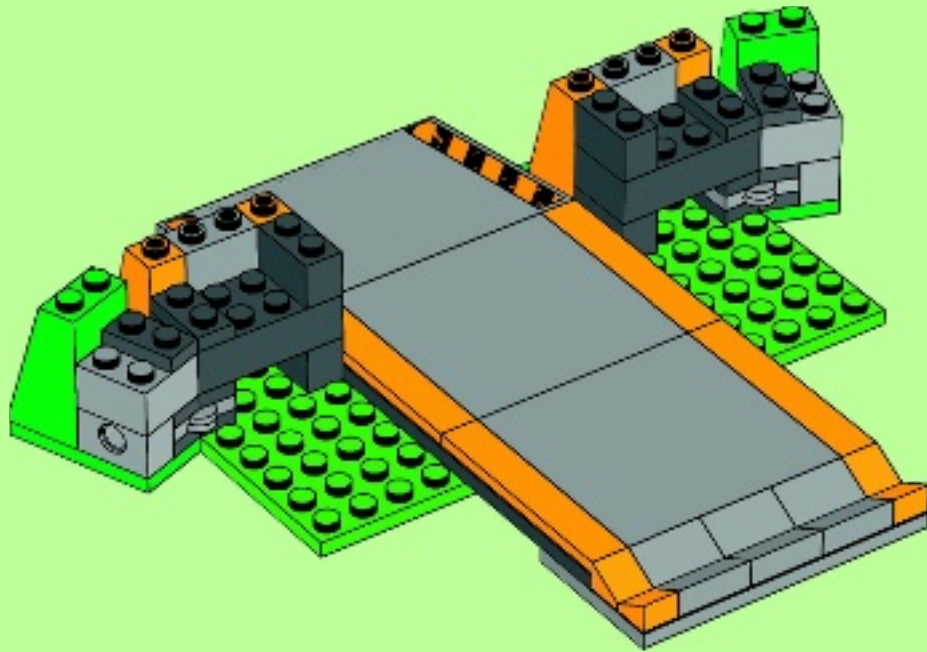

2x

14

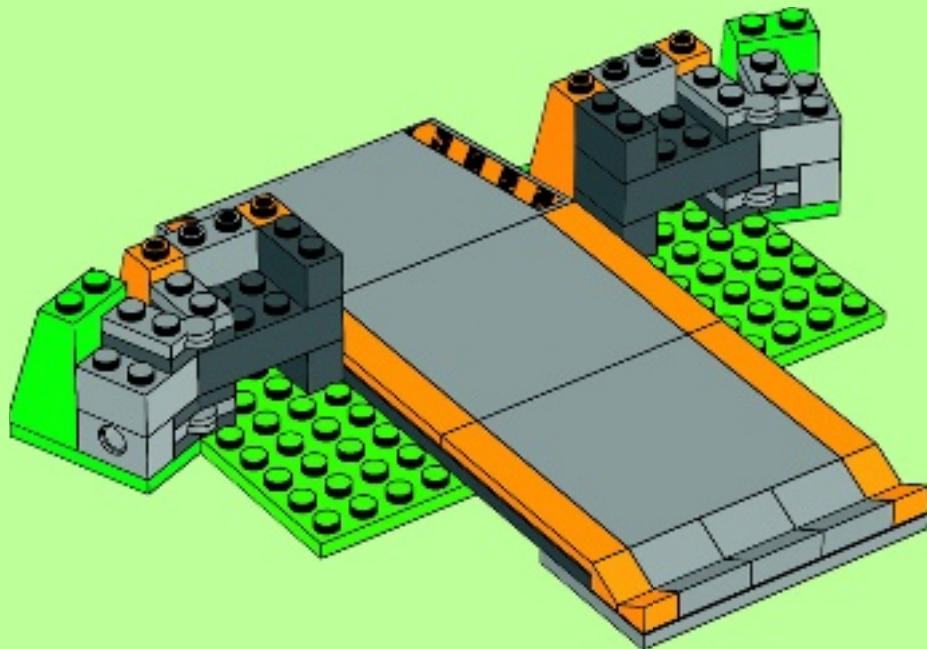



2x



4x

15

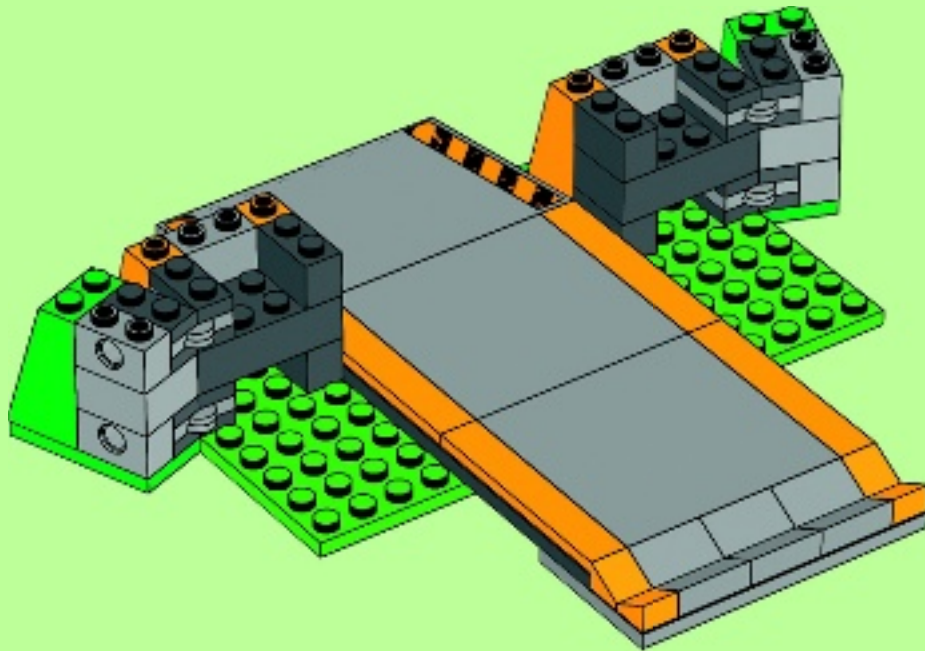

4x

16

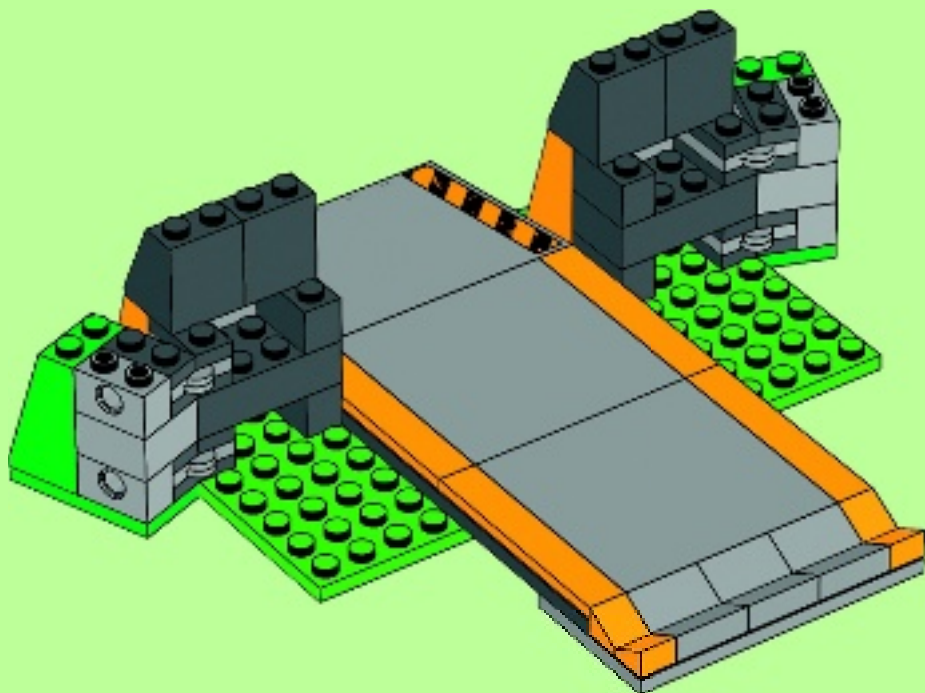



17

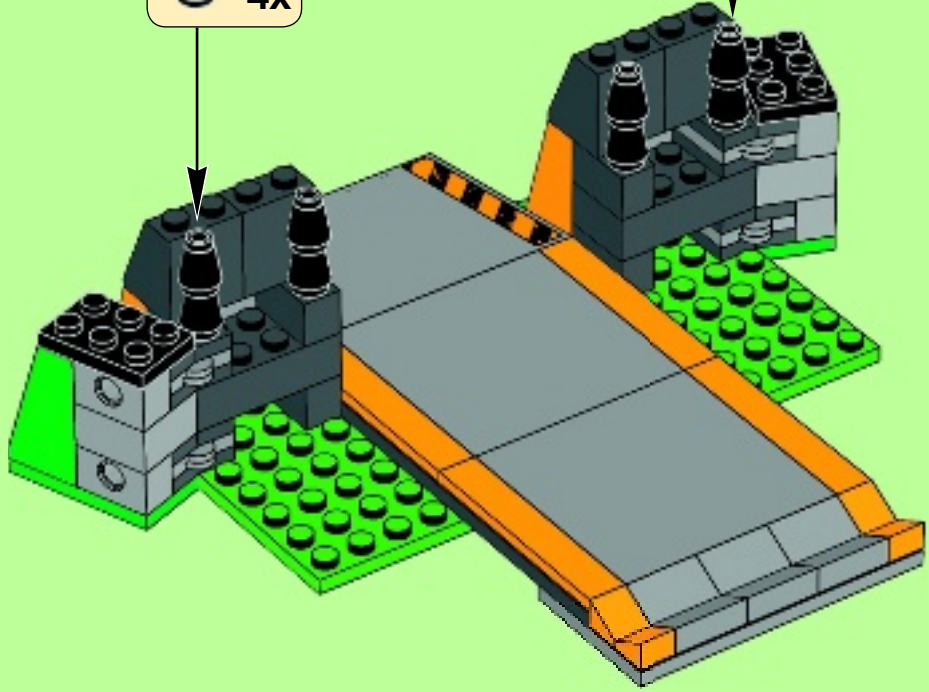

18

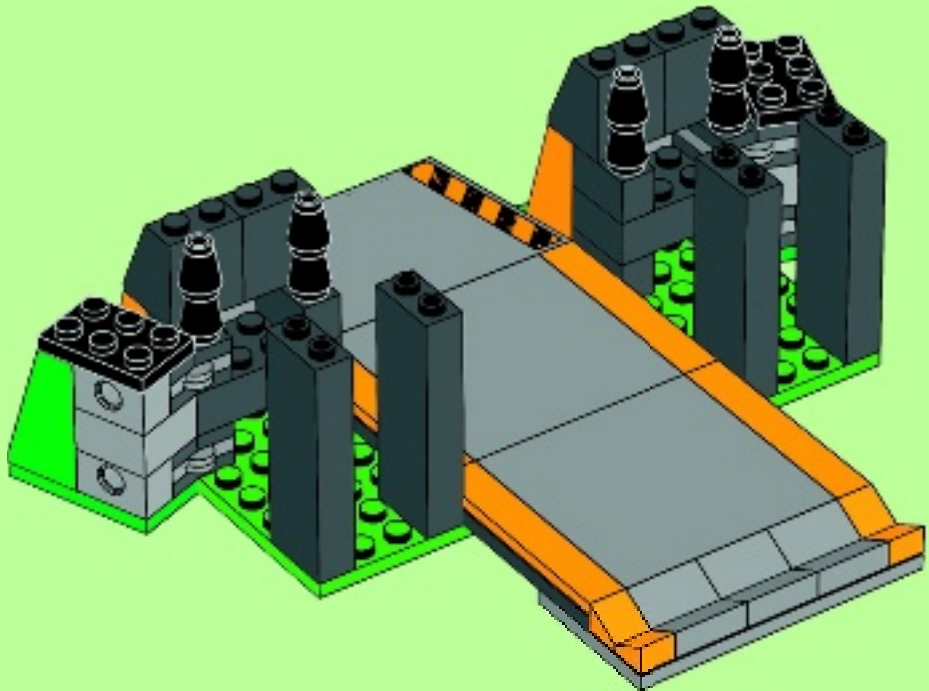



19

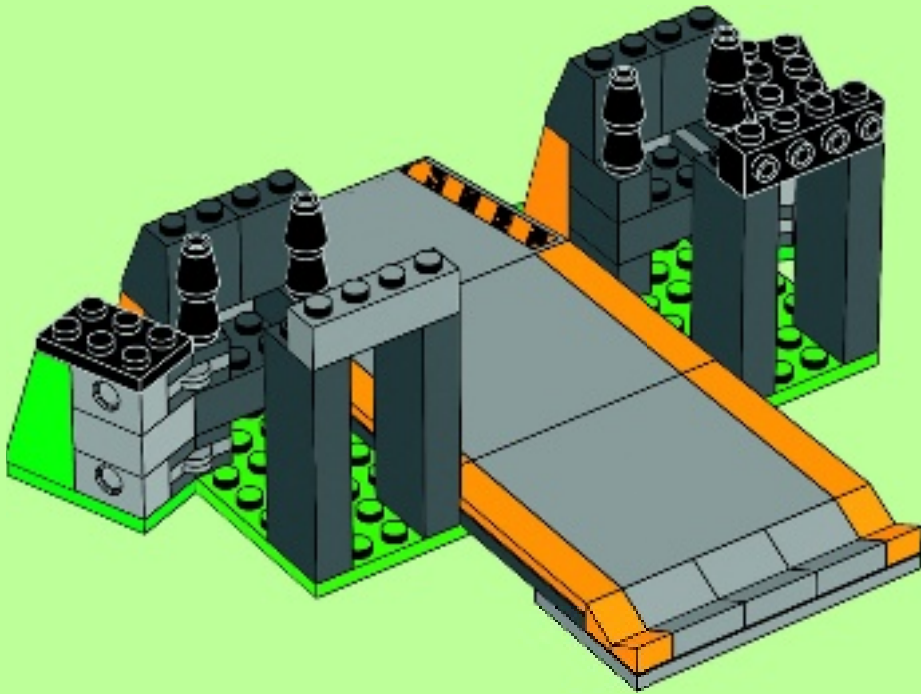

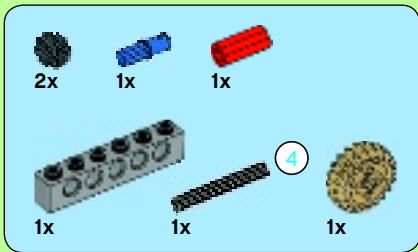

20

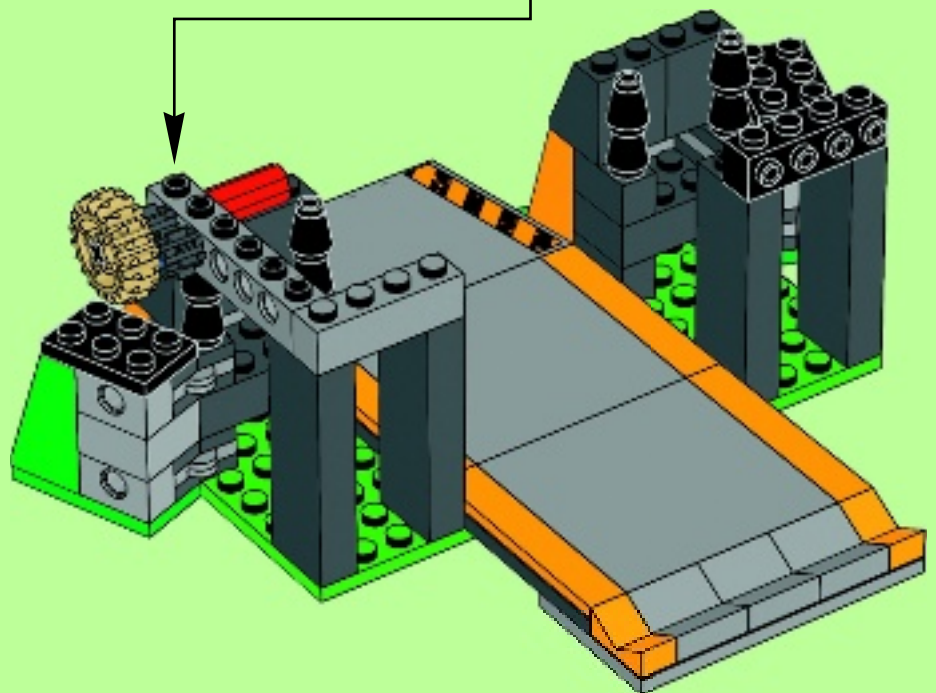
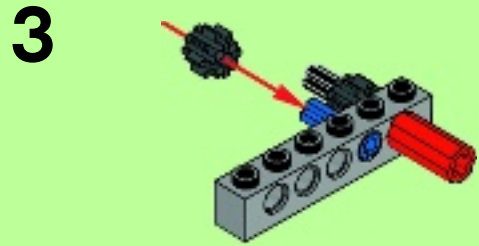
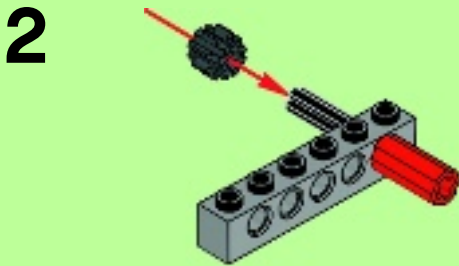
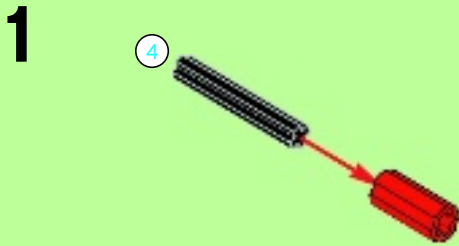

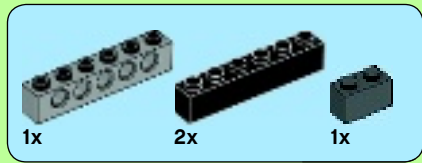

21

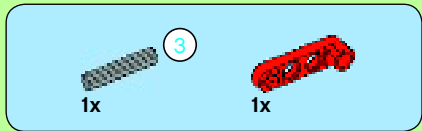
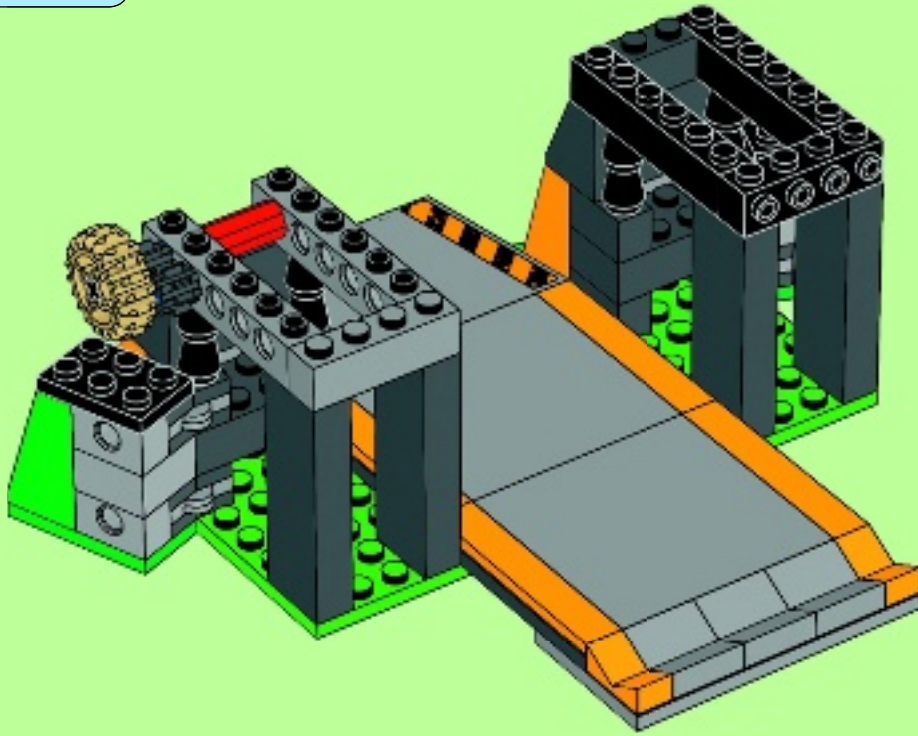

22

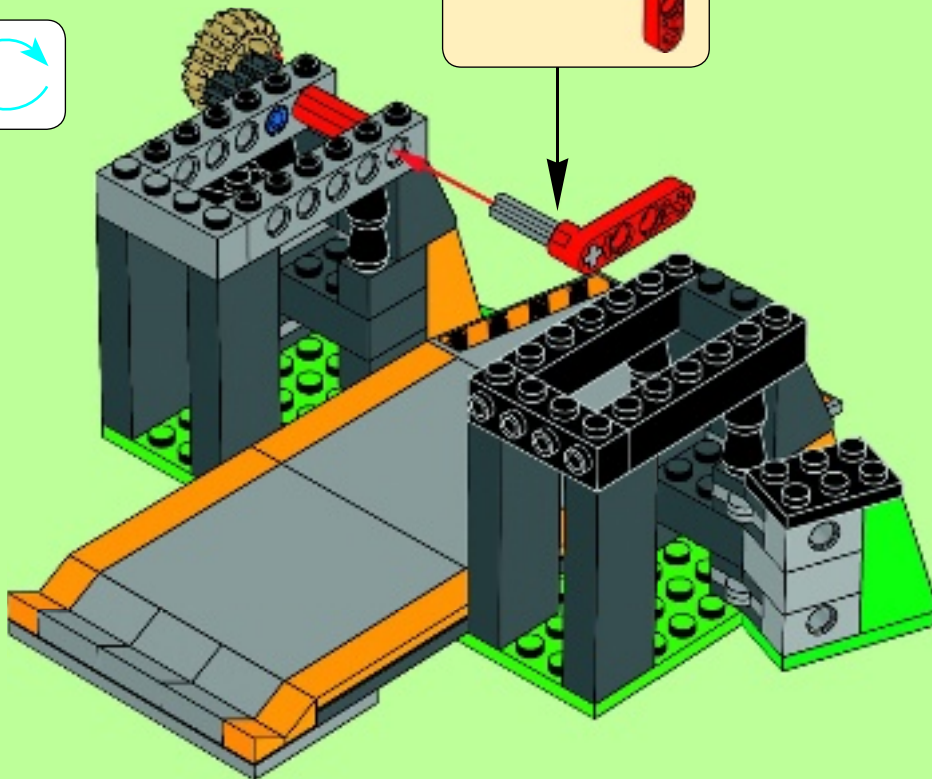
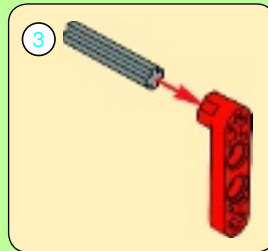



23

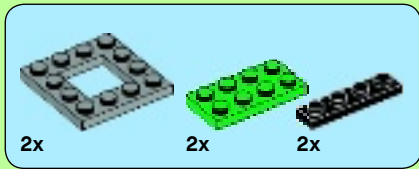
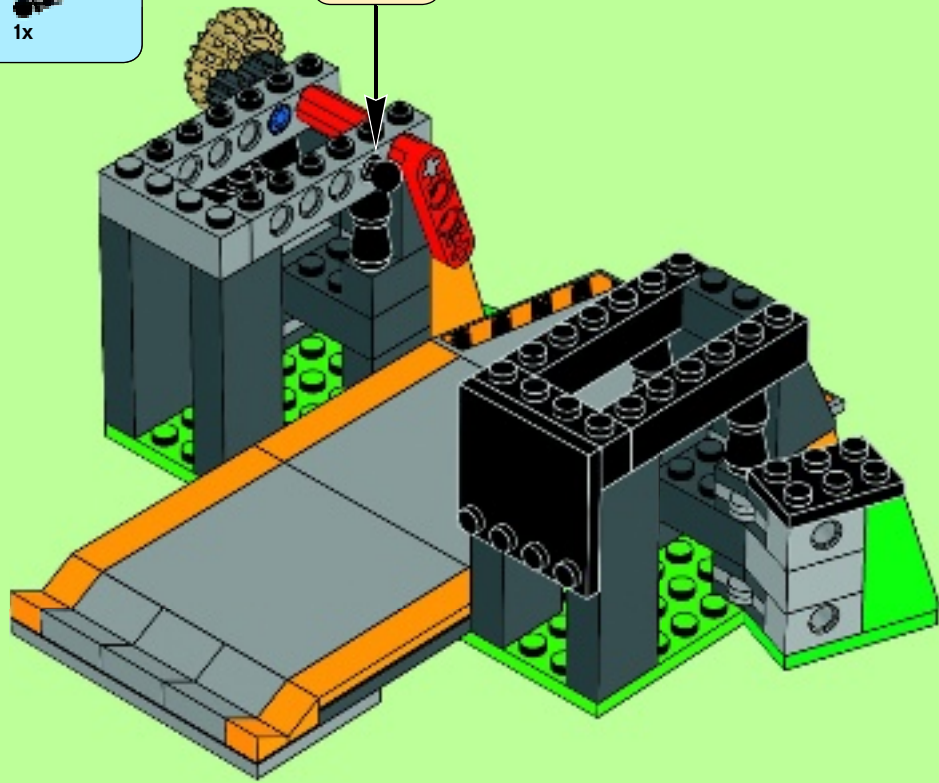

24

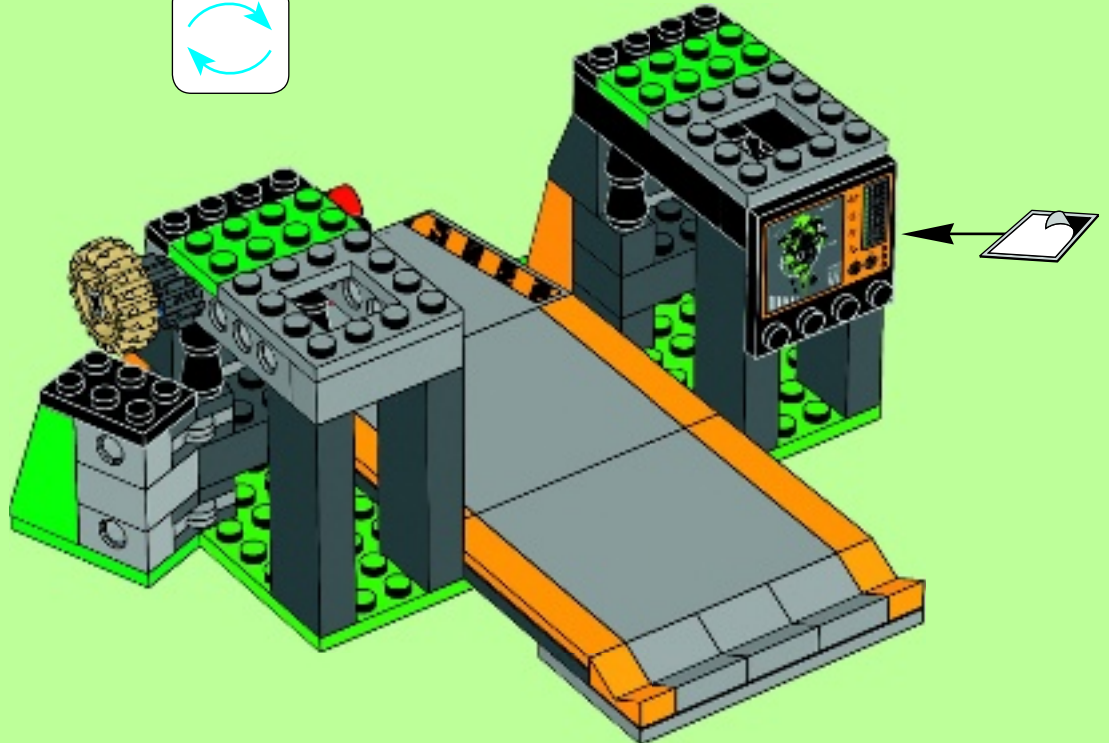

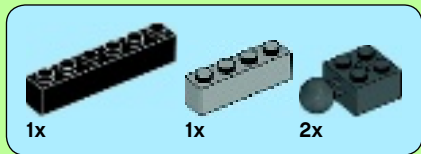
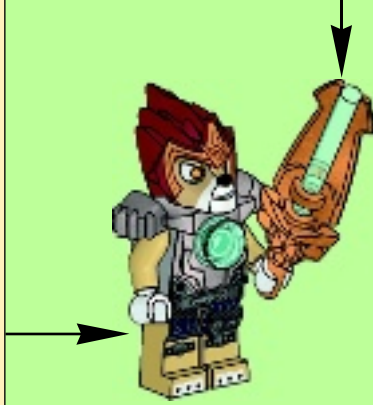
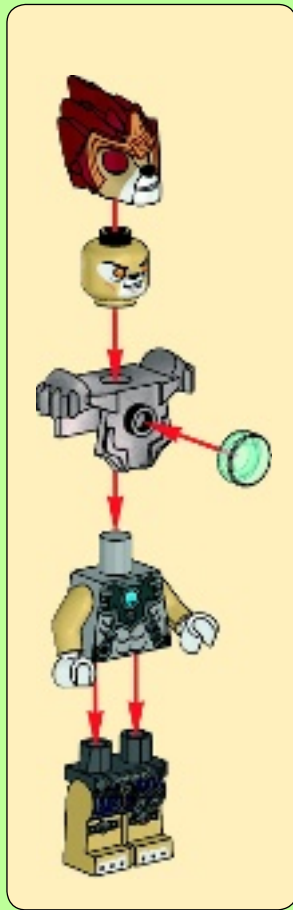

25

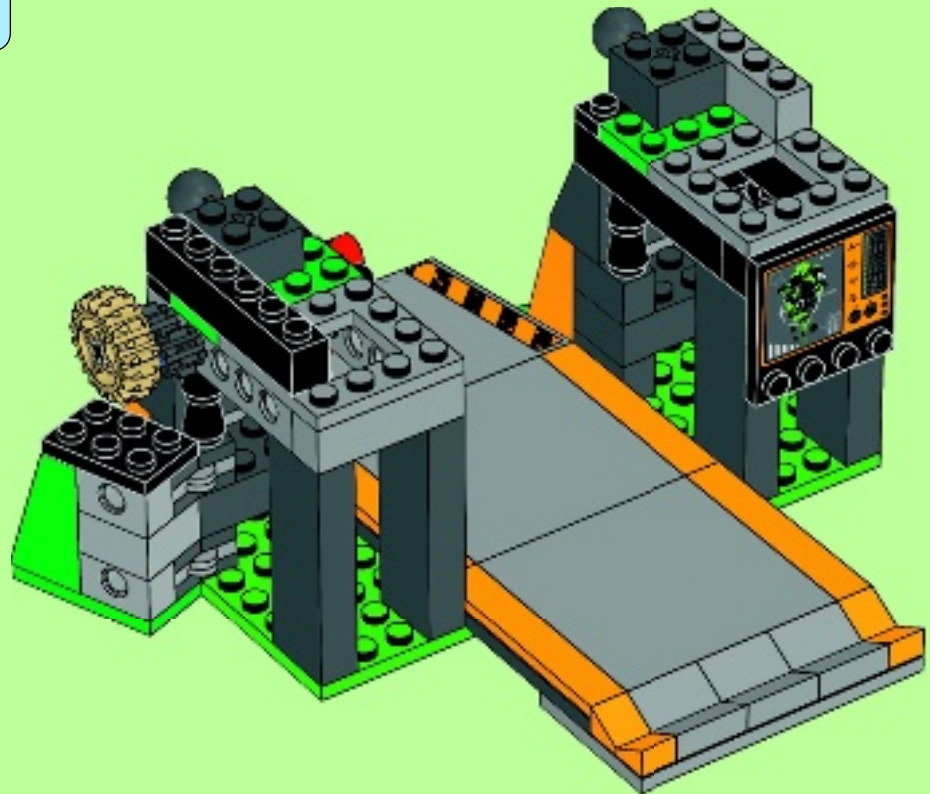

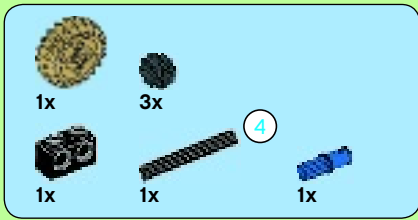

26

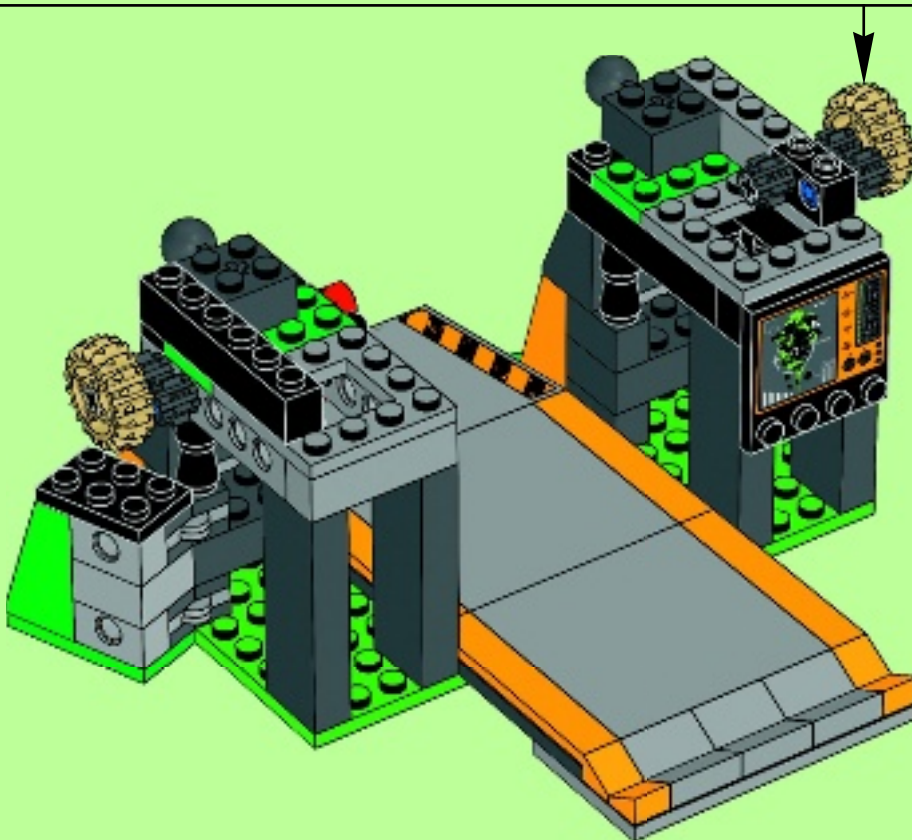
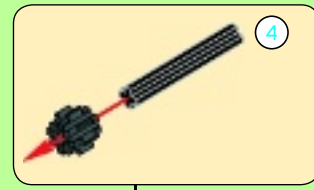
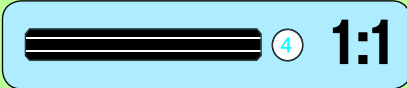

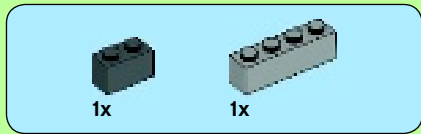

27

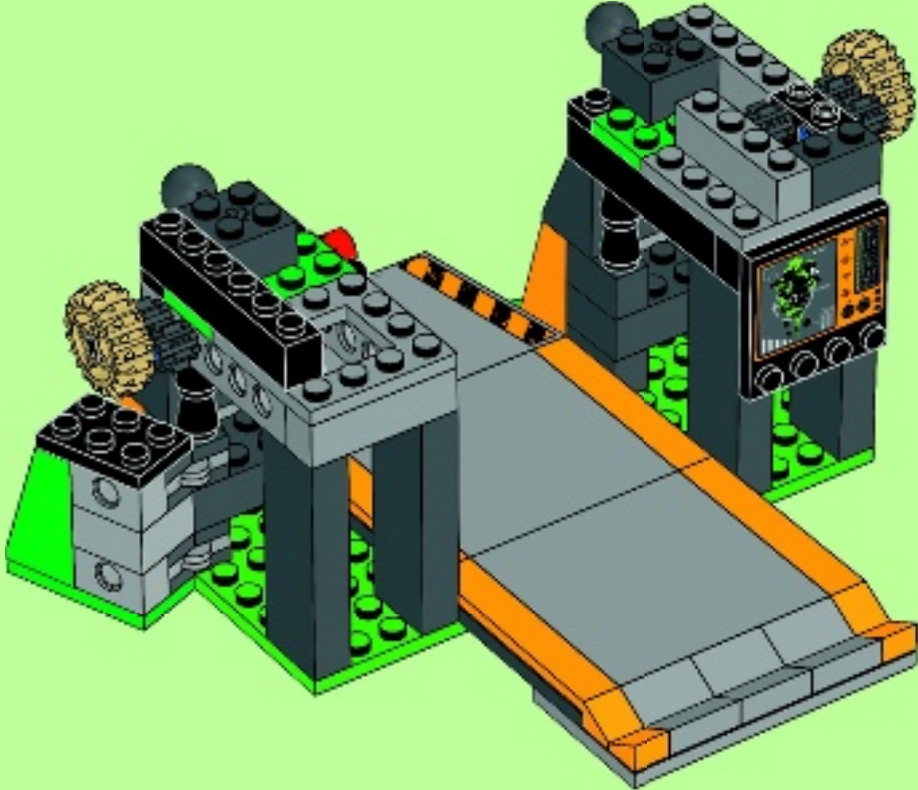

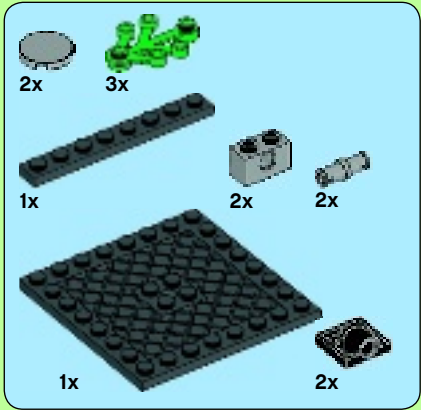

28

1

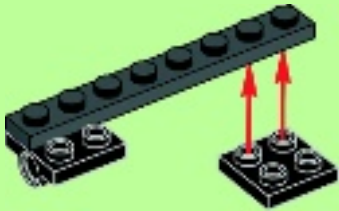

2



3



4

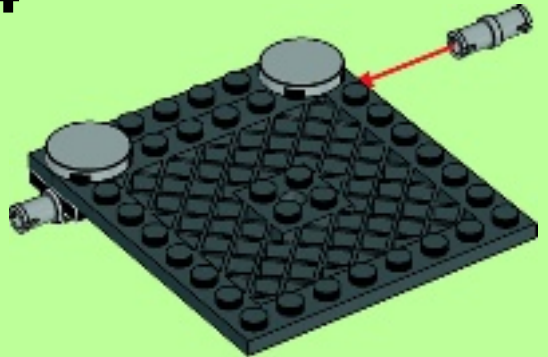

5

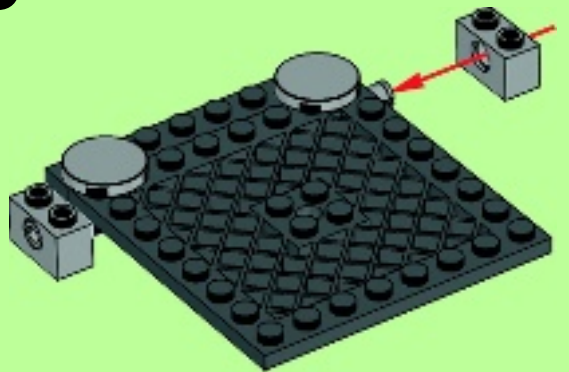

6

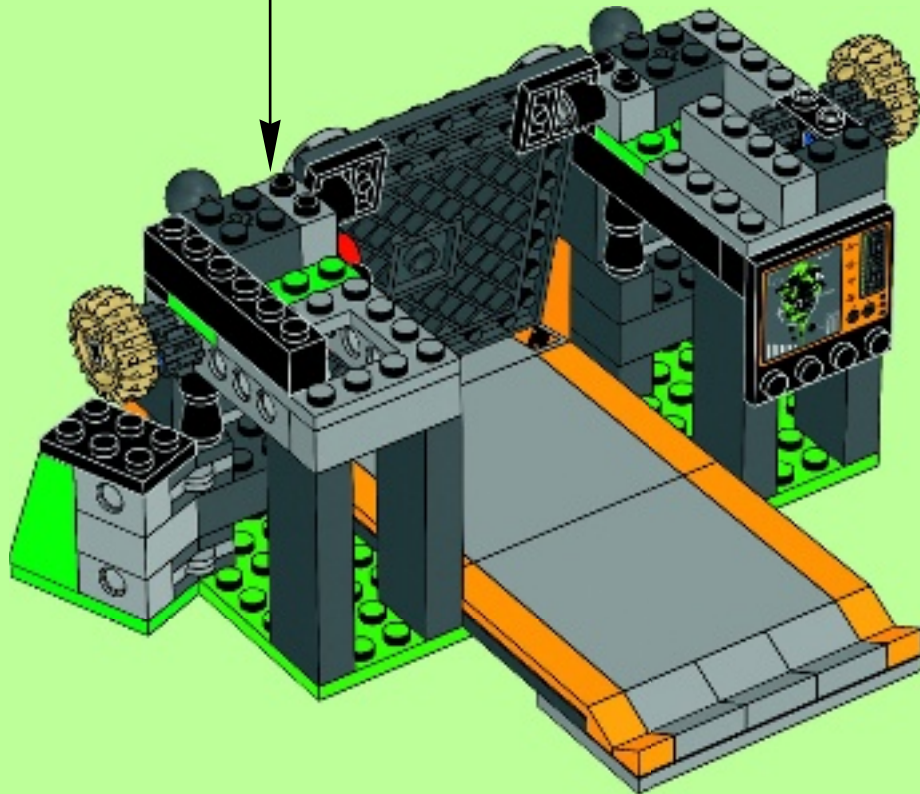

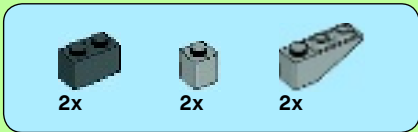

29

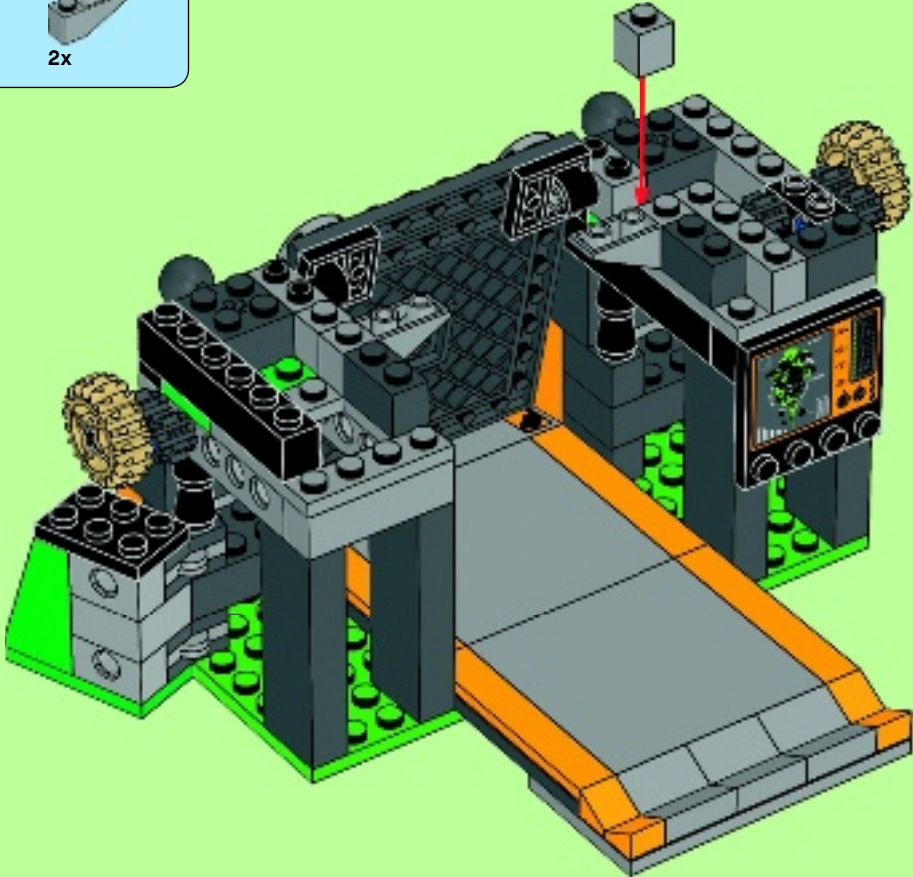

30

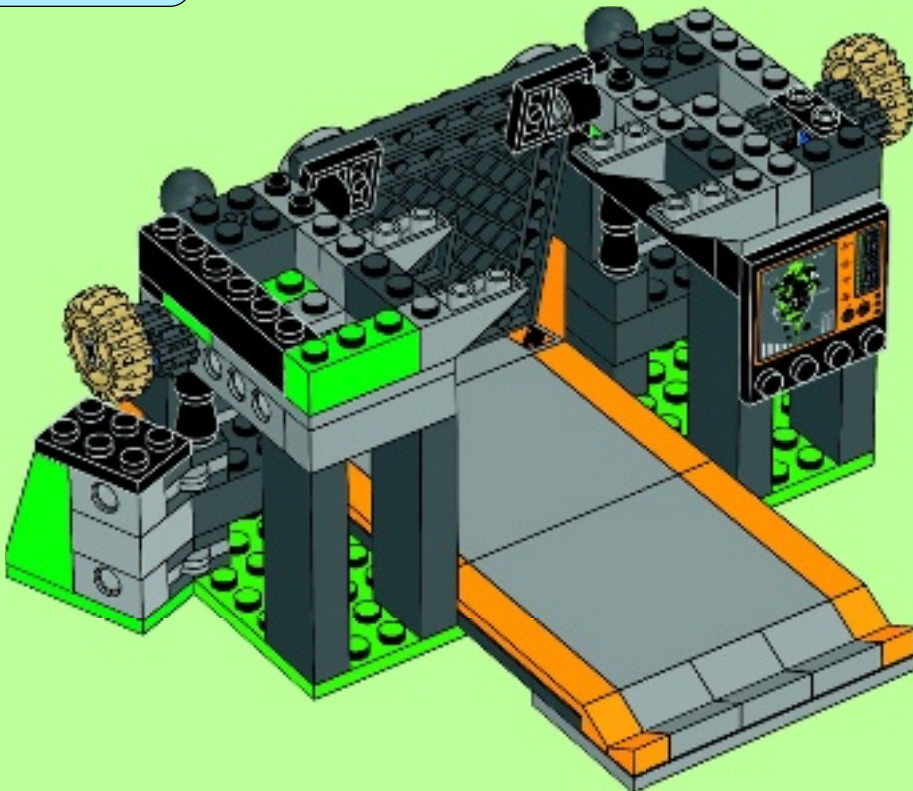

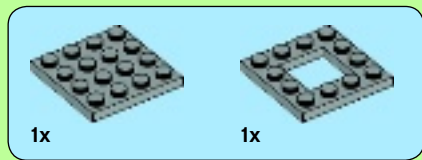

31

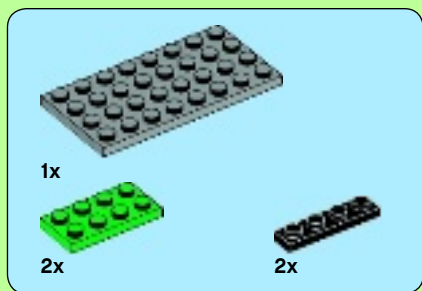
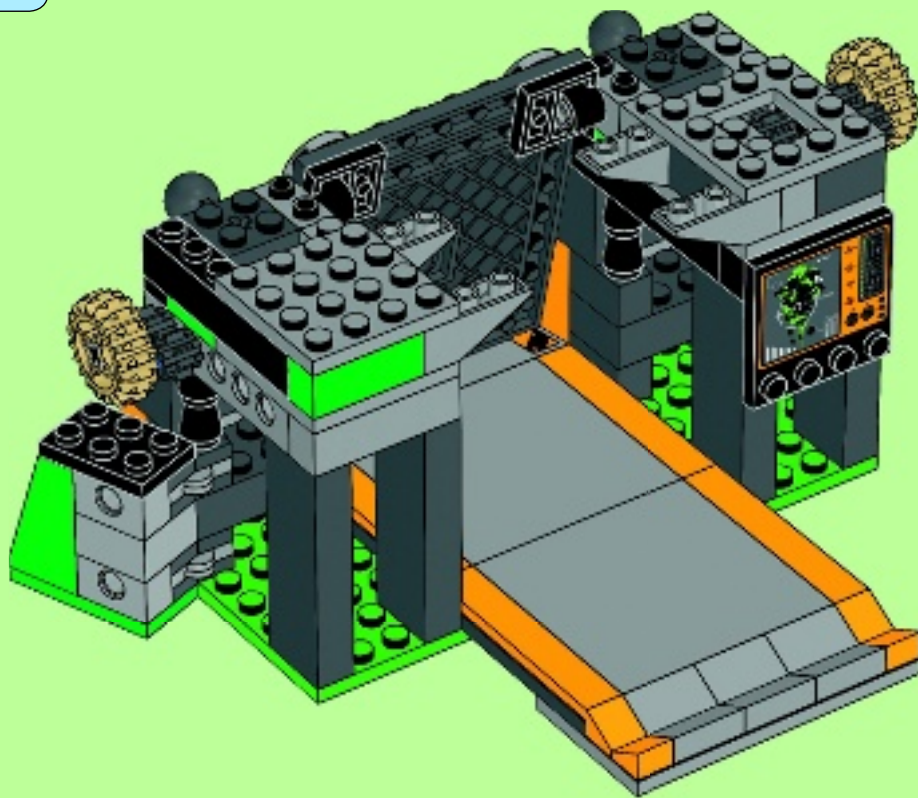

32

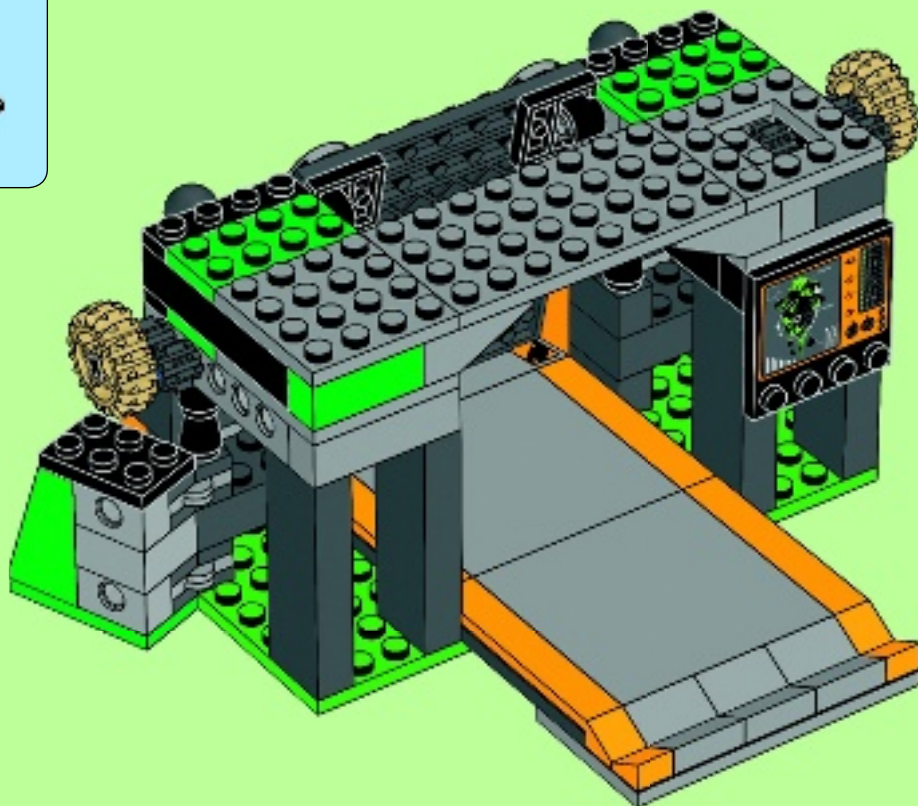

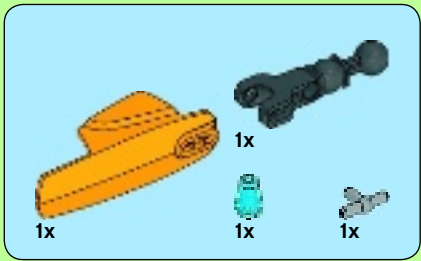

33

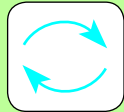
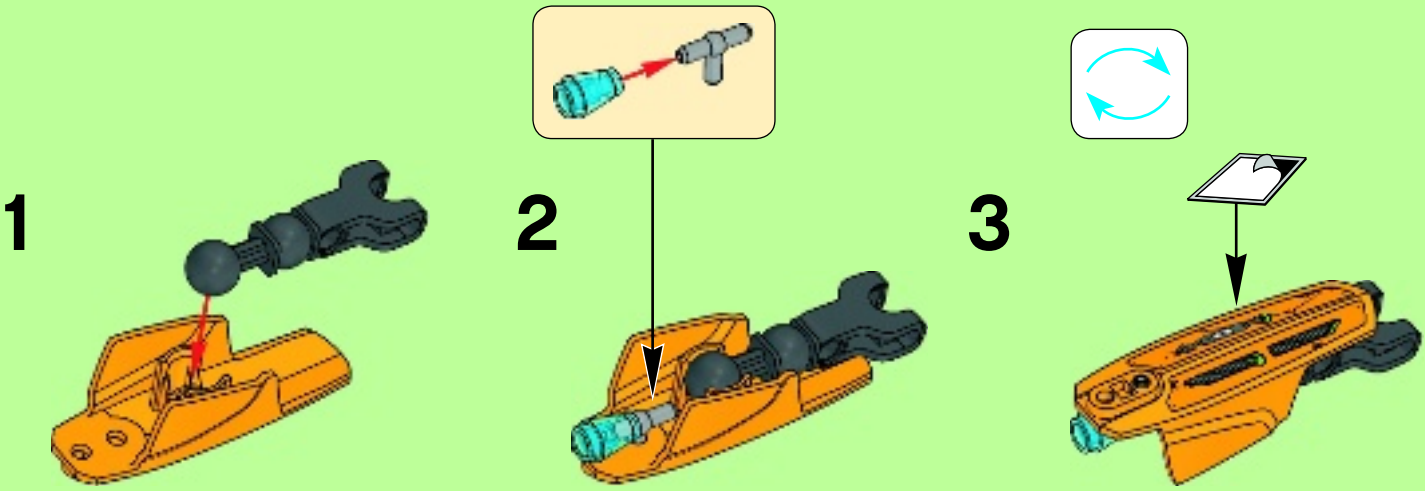

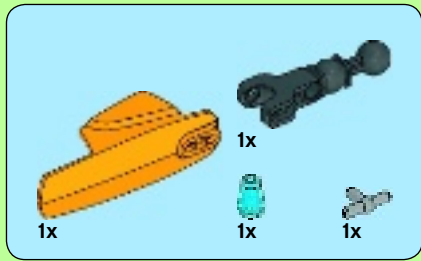

34

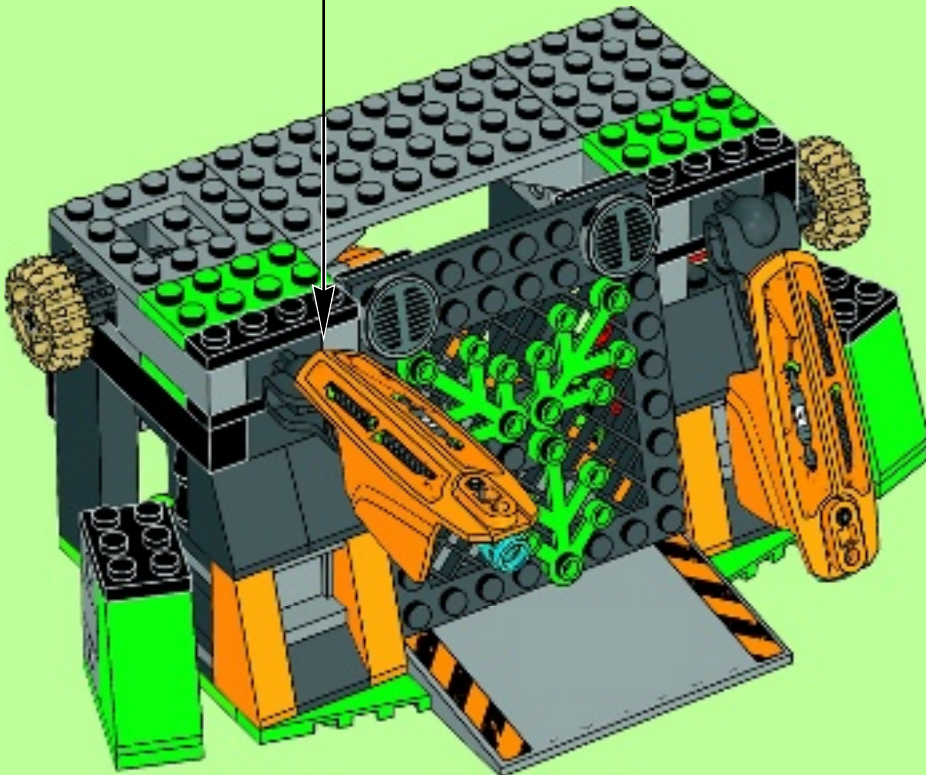
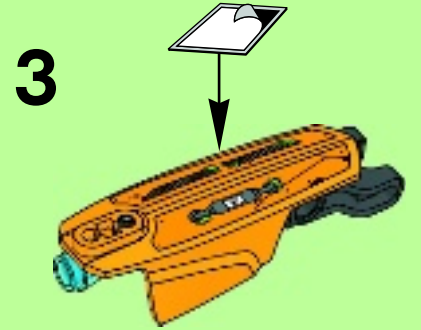
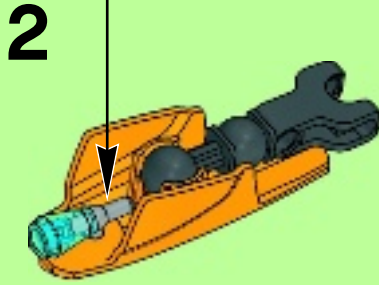
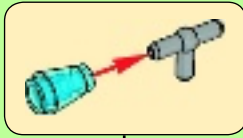
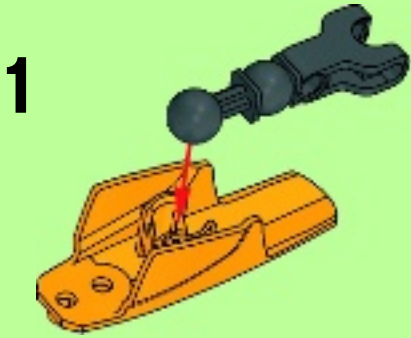



5x

35

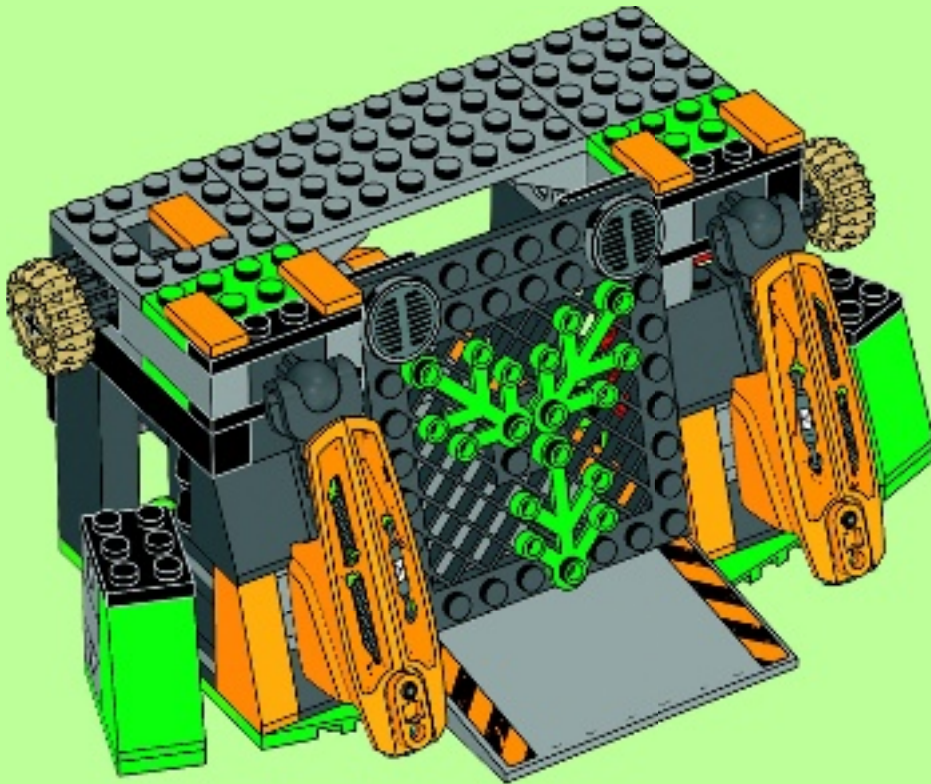

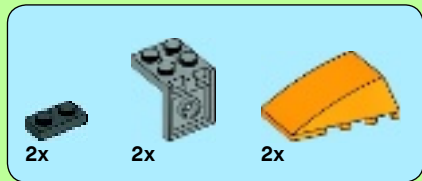

36

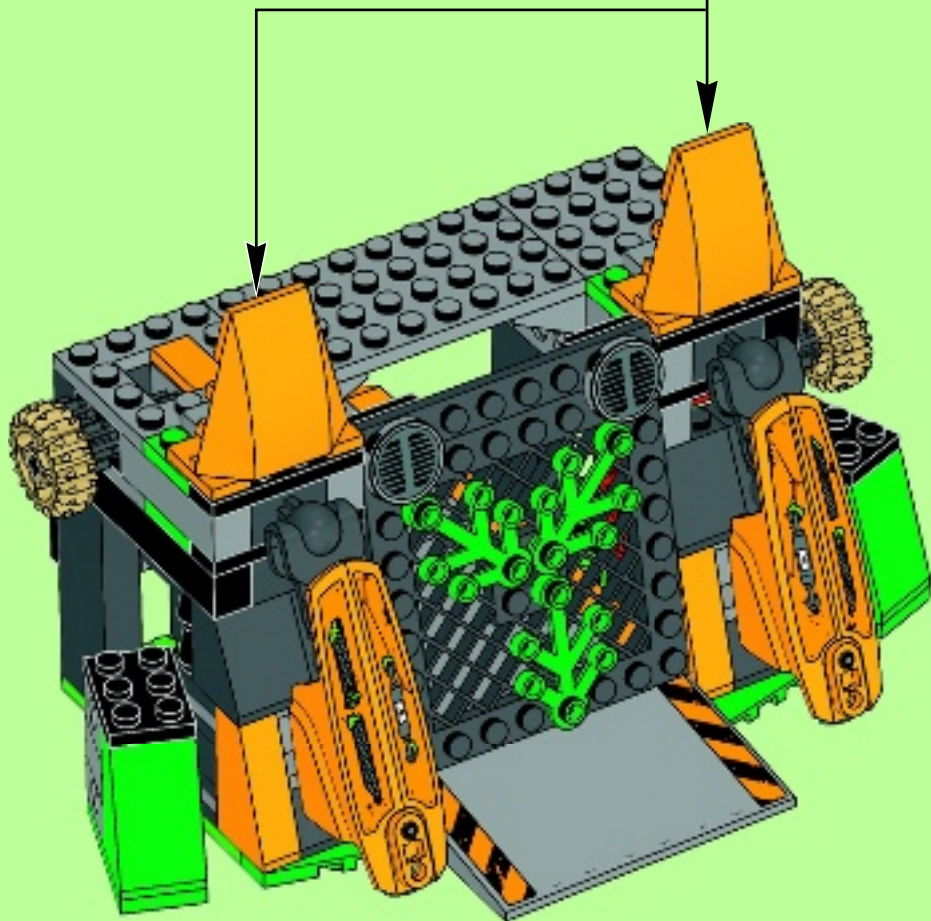

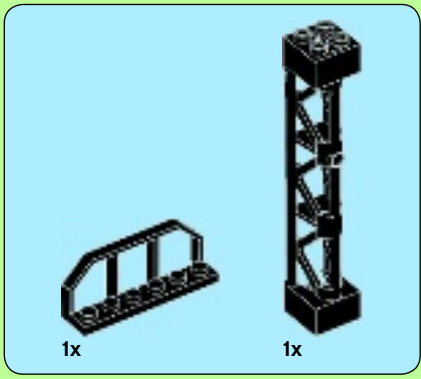

37

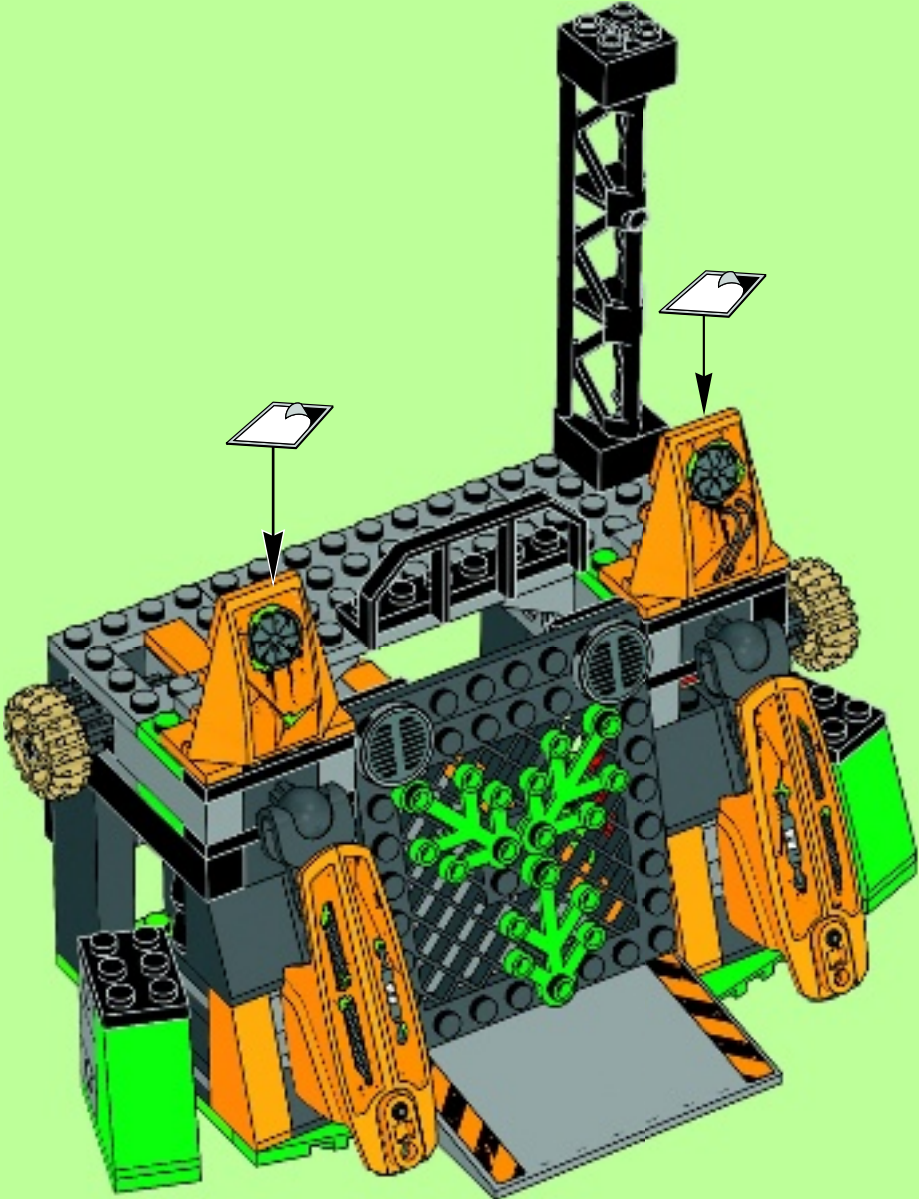

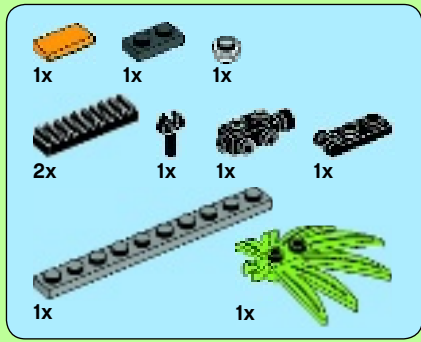

38

1

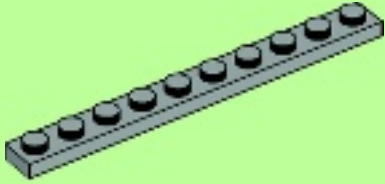

2

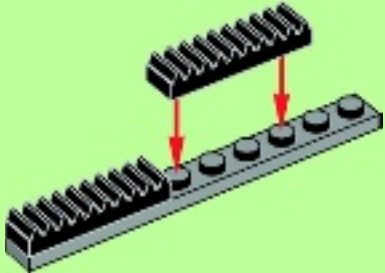

3

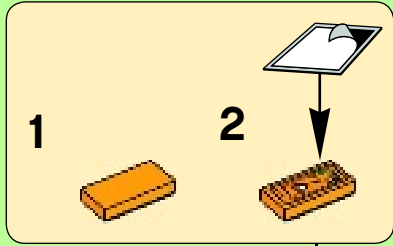
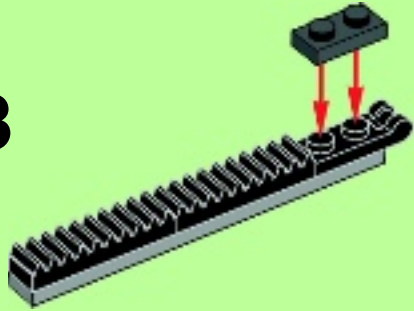

4

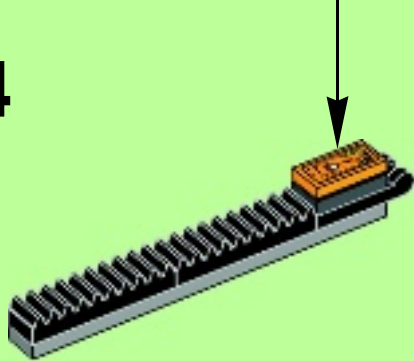

5

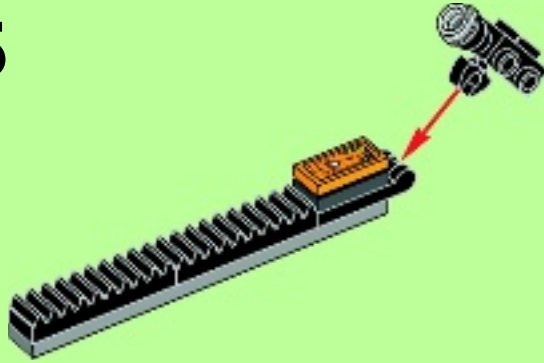

1



2

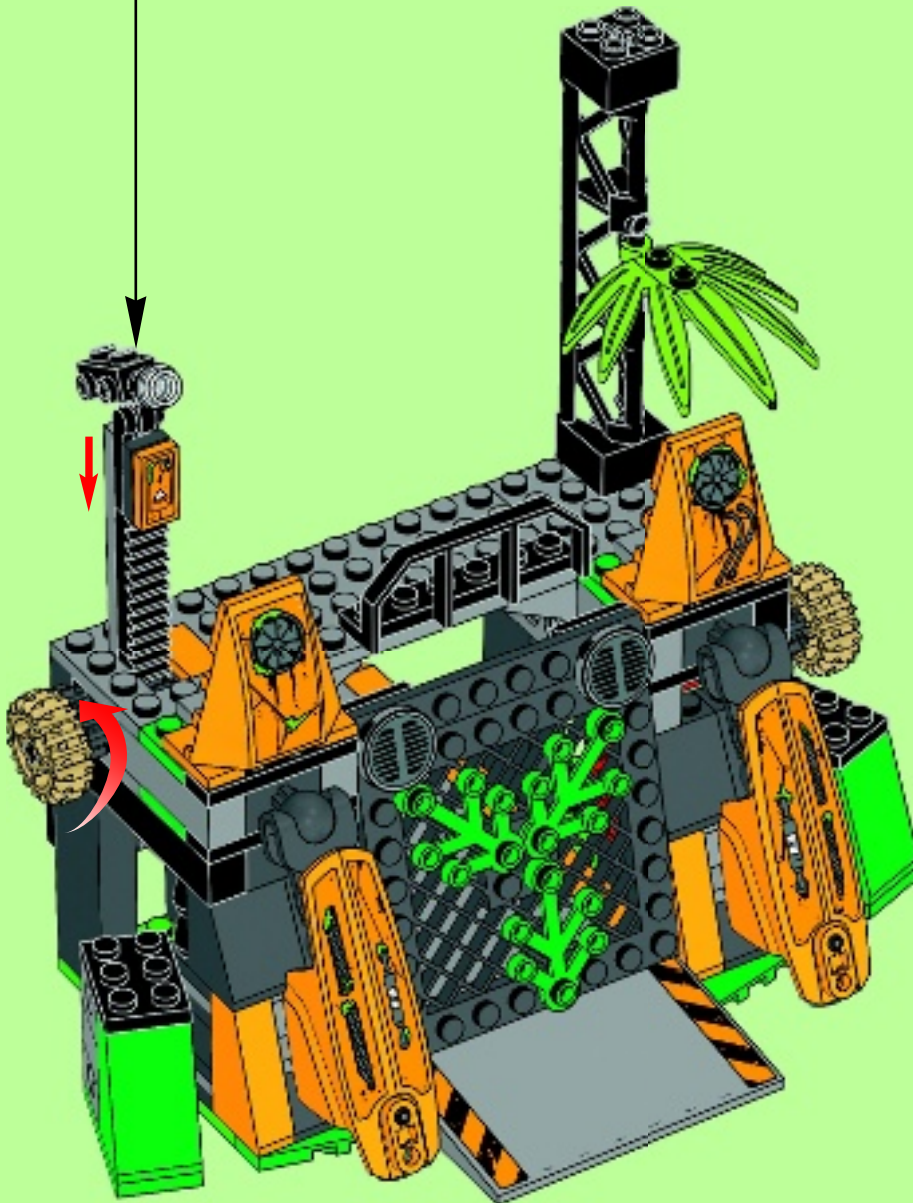
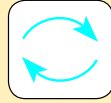



39

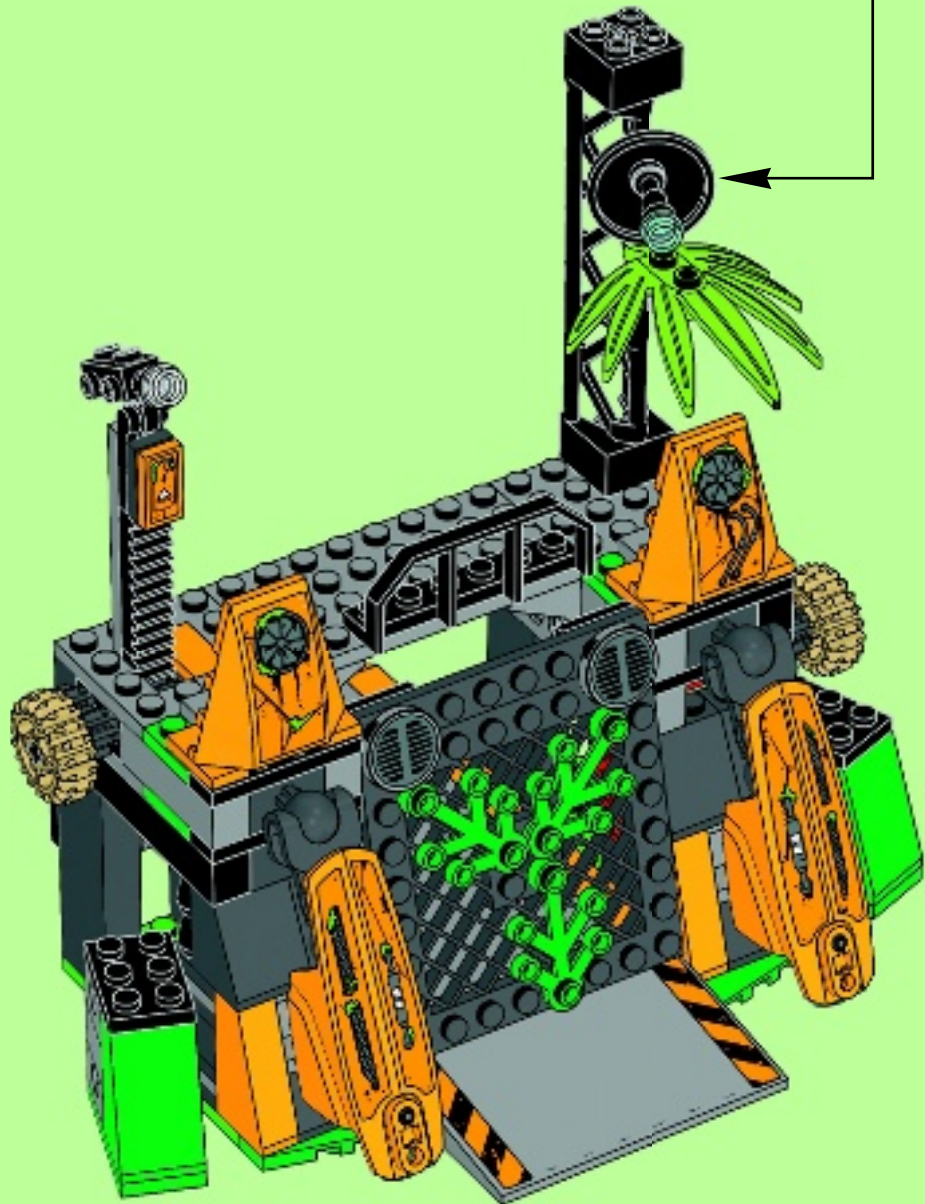

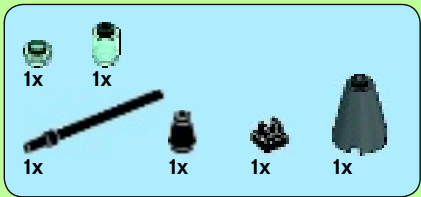

40

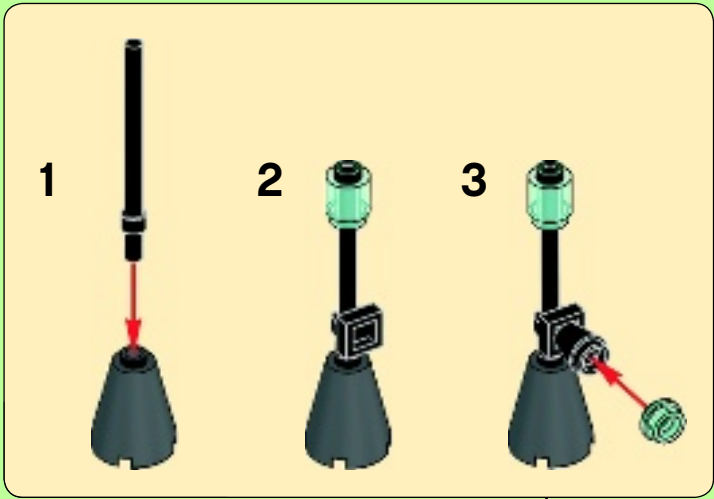

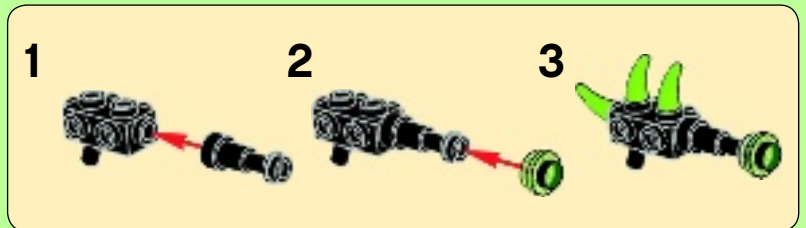
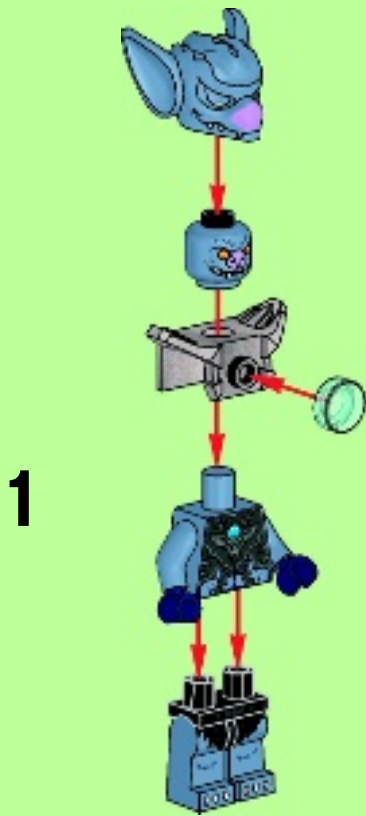
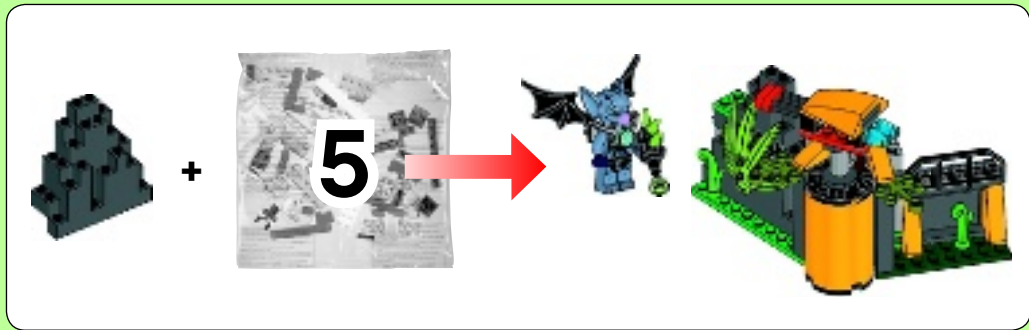



1



2

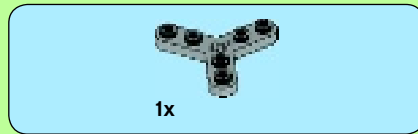

3



4



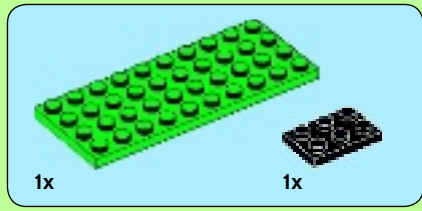

5

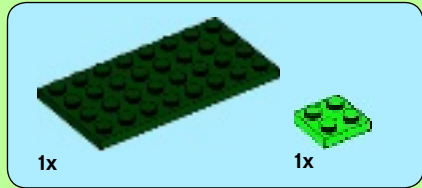
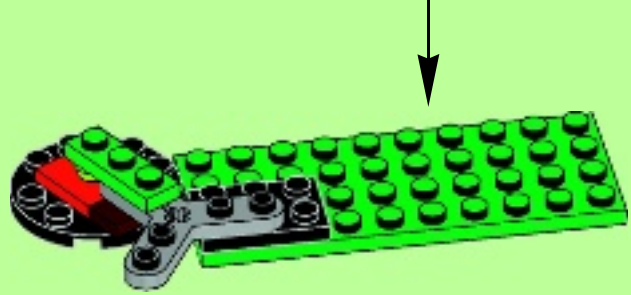
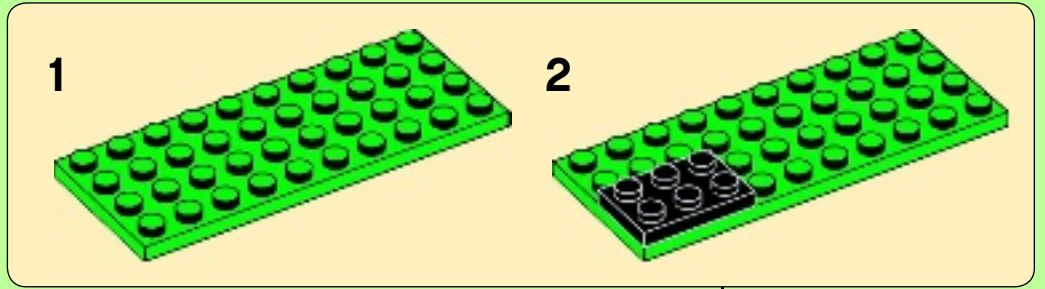

6

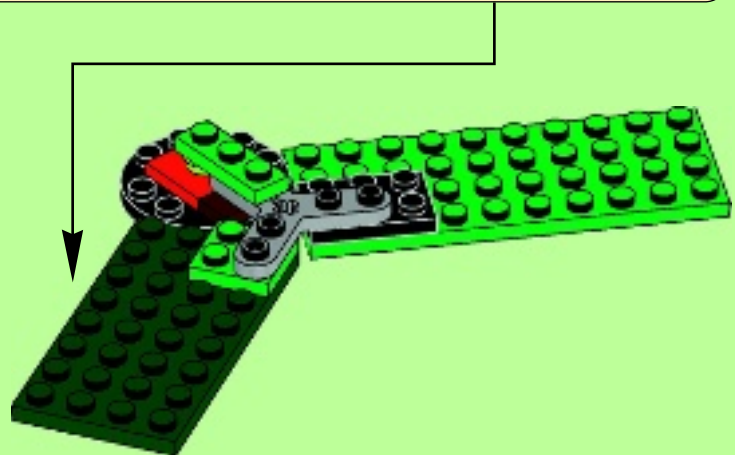
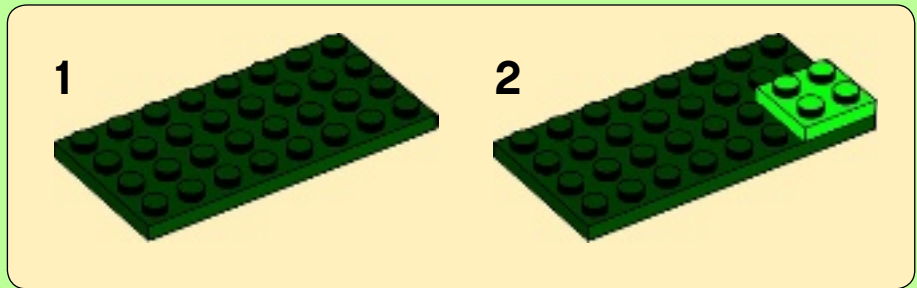



7

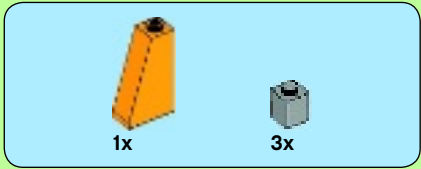
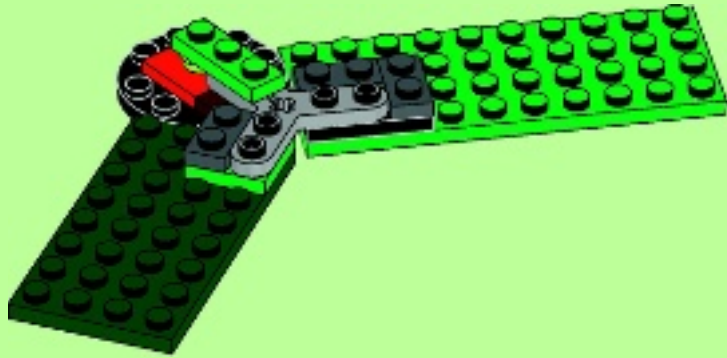

8

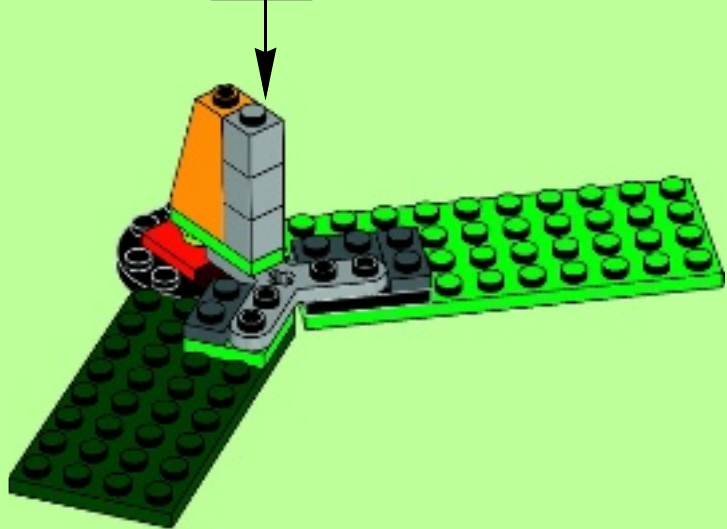
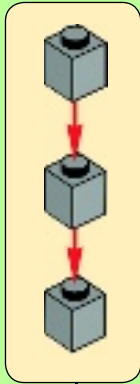



9

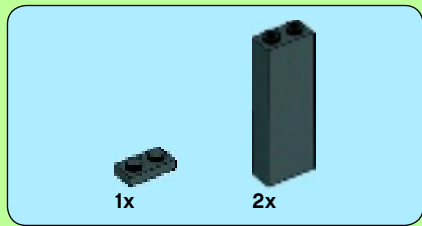
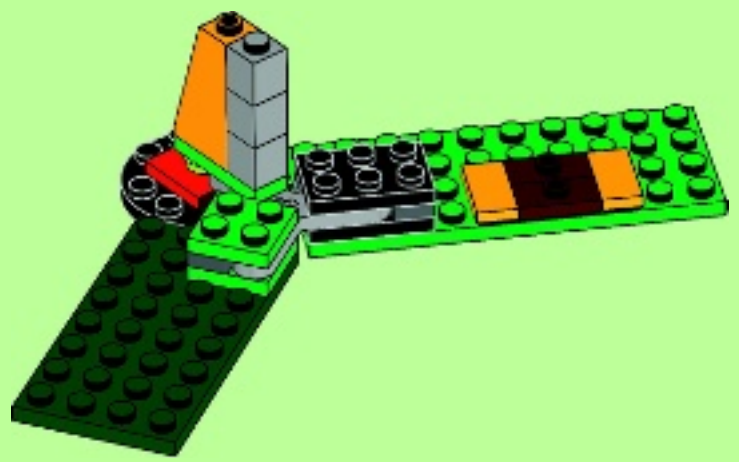

10

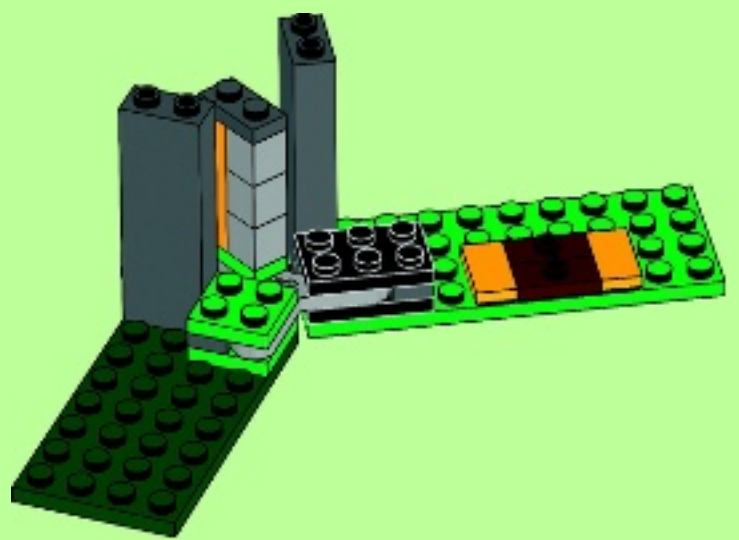



11

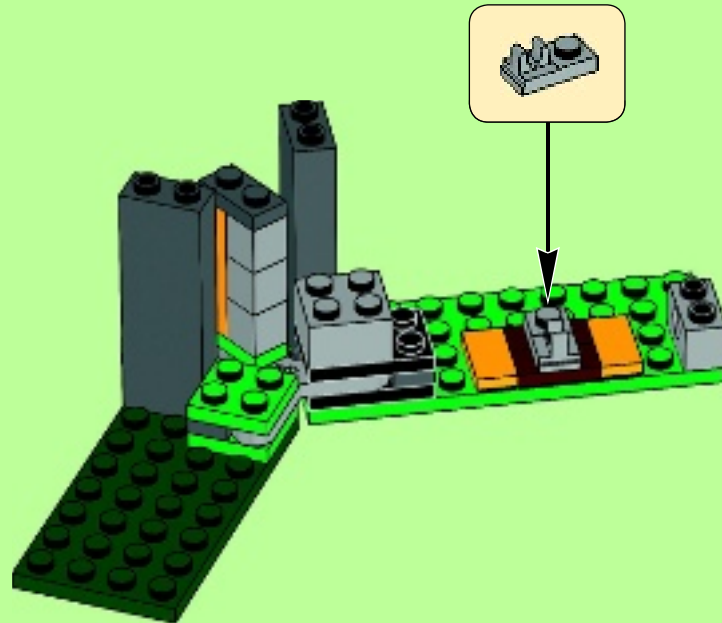

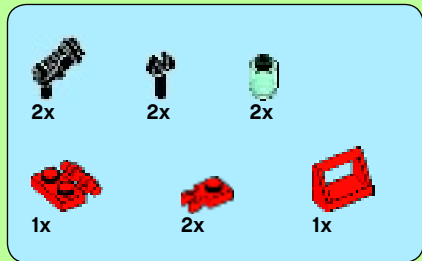

12

1

2

3

4

1

2

2x

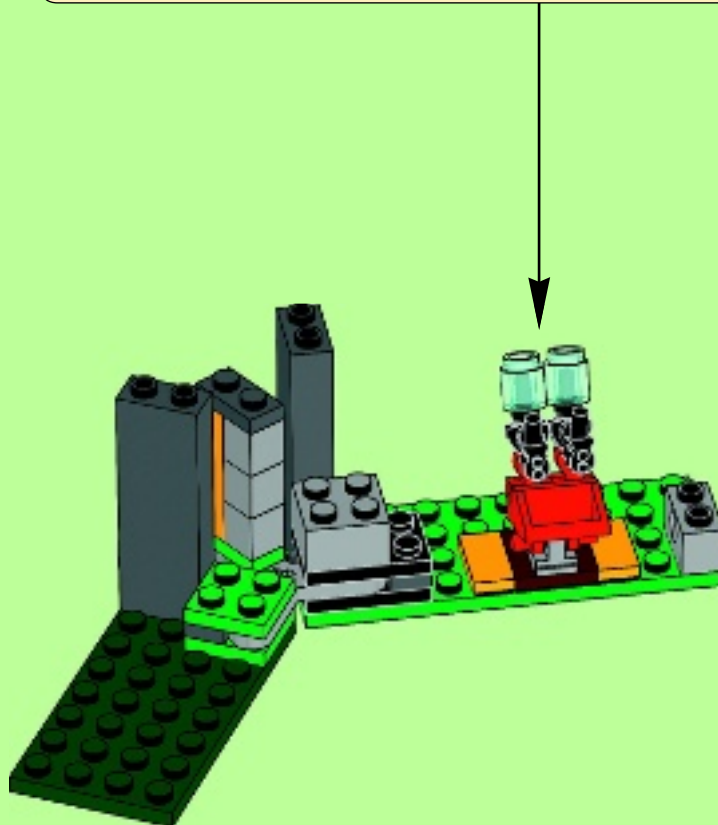

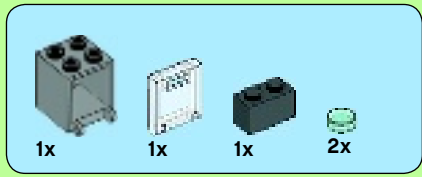

15

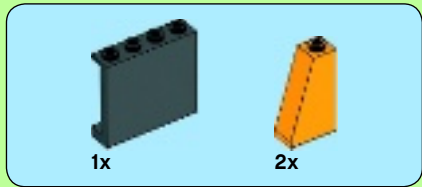
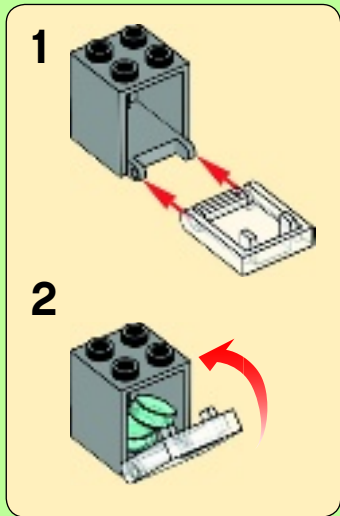
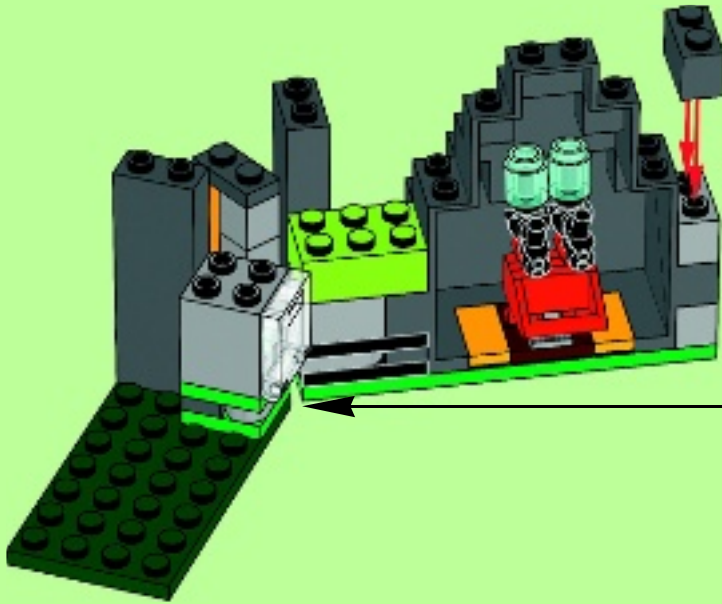

16

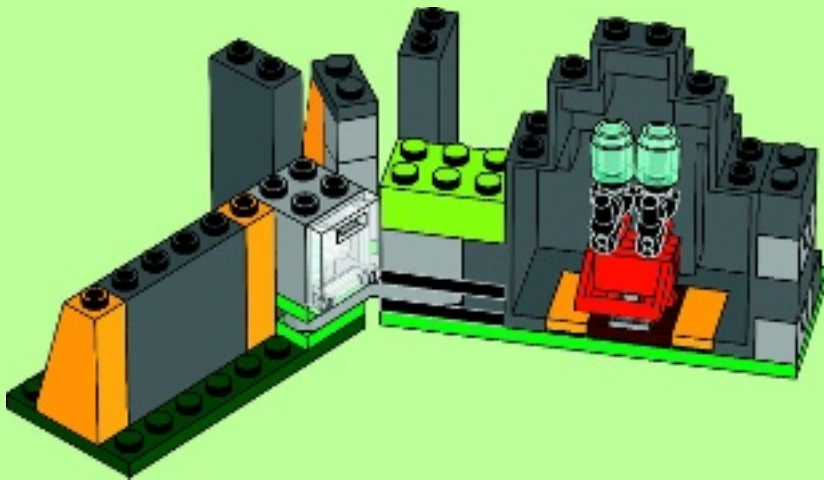



17

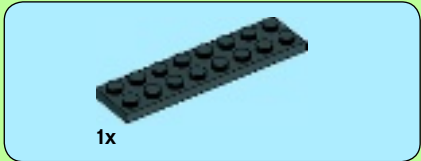
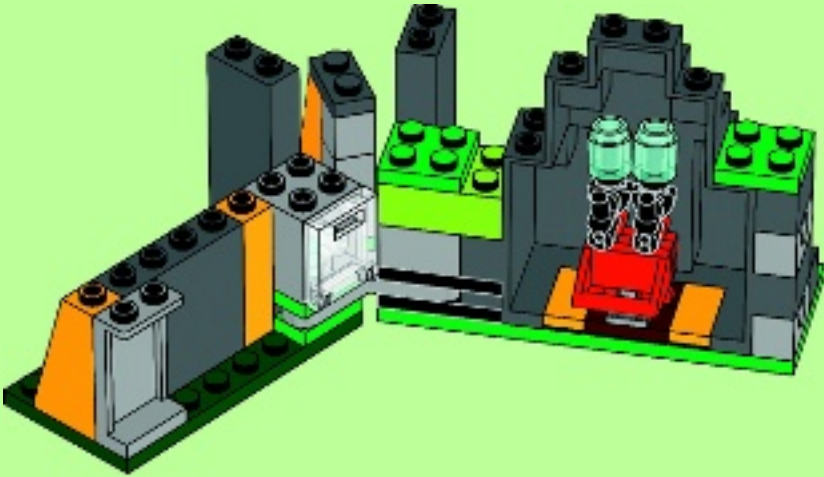

18

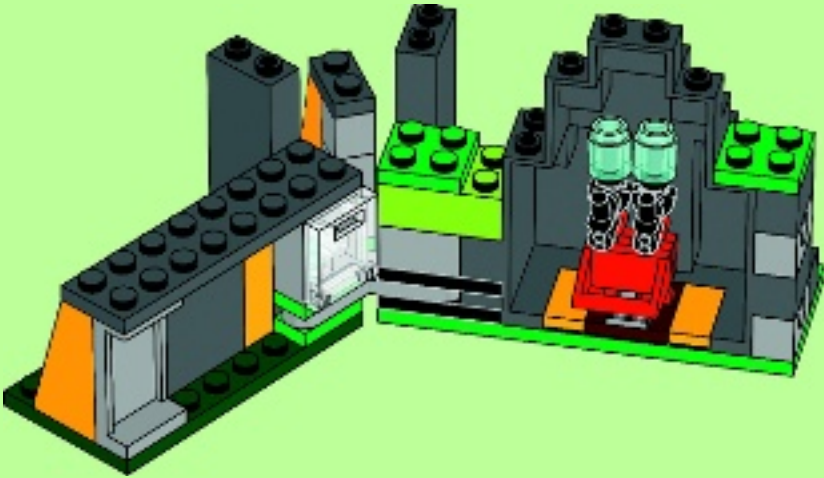

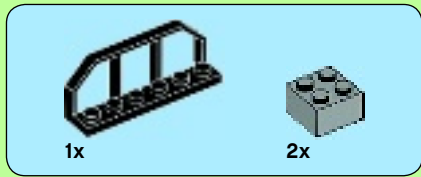

19

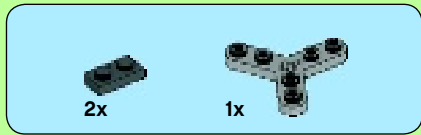
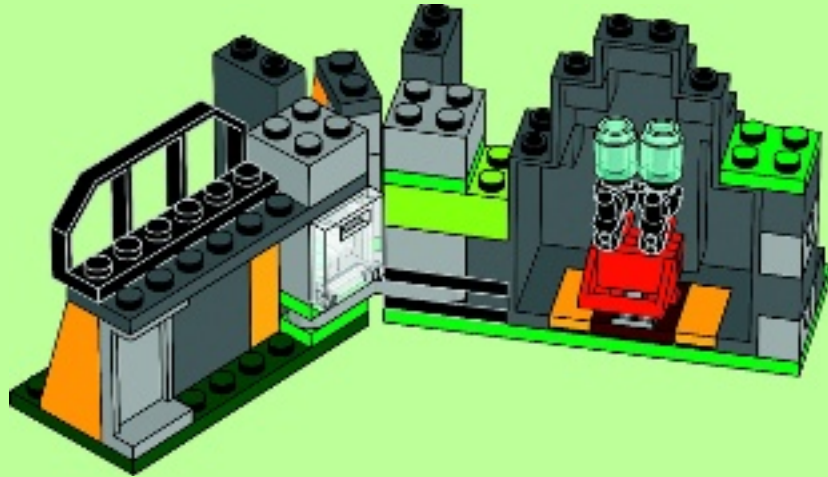

20

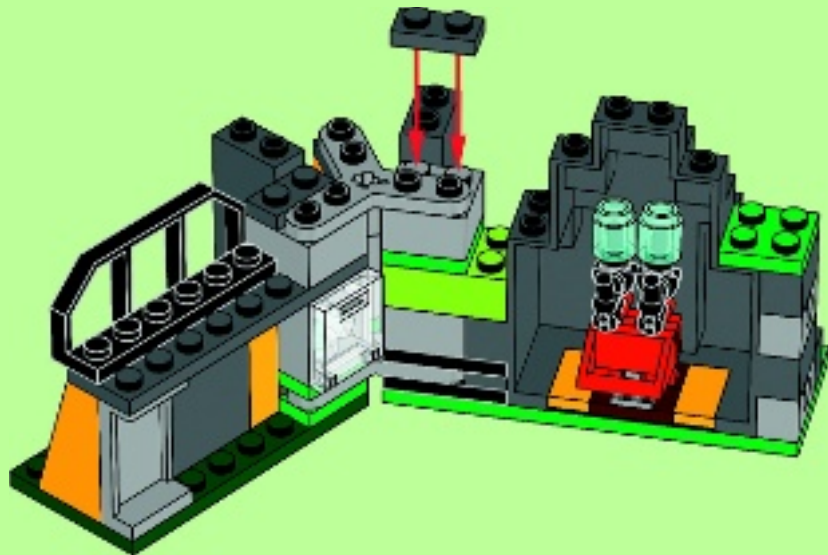



2x

21

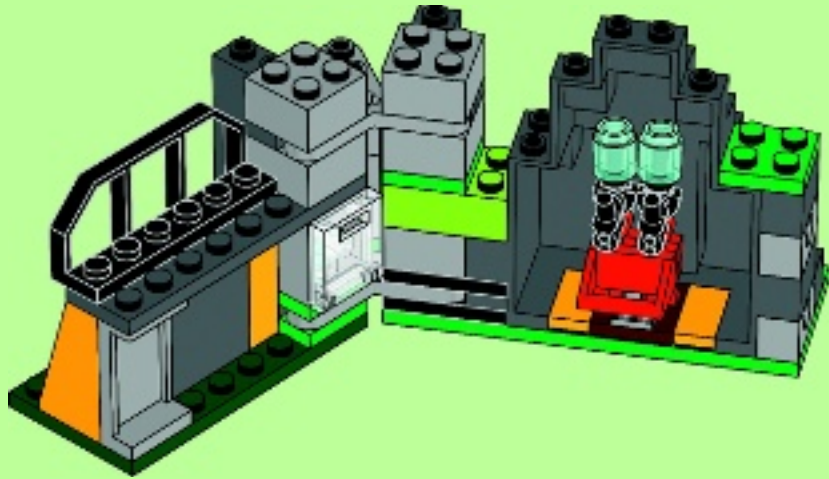

1x



2x



3x

22

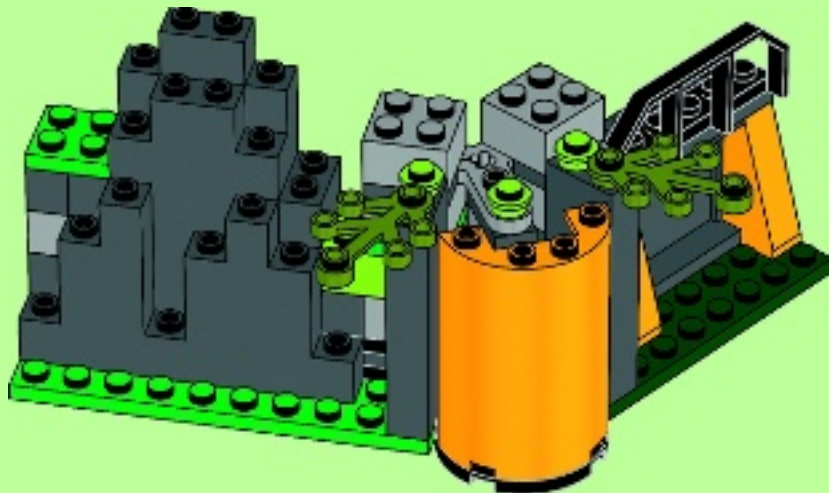
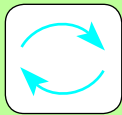

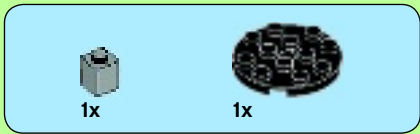

23

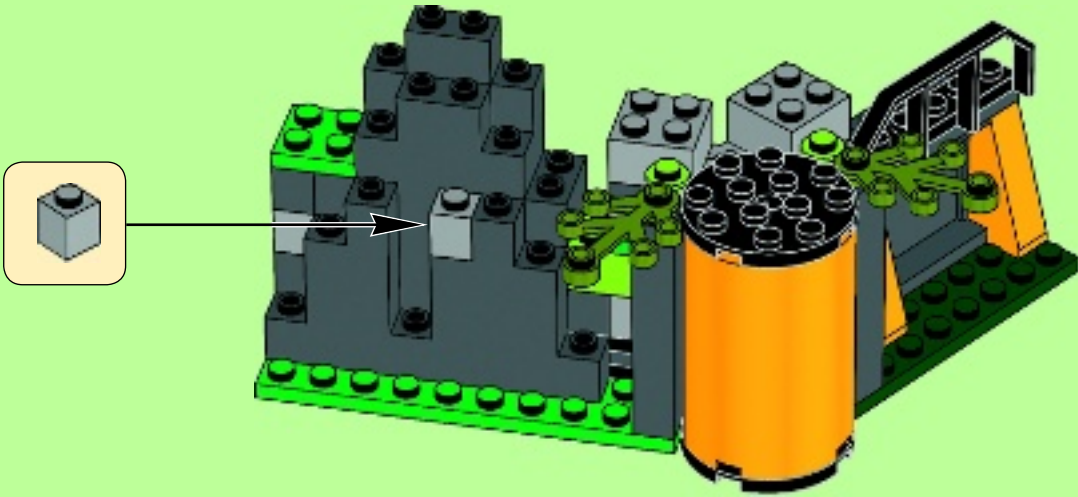

24

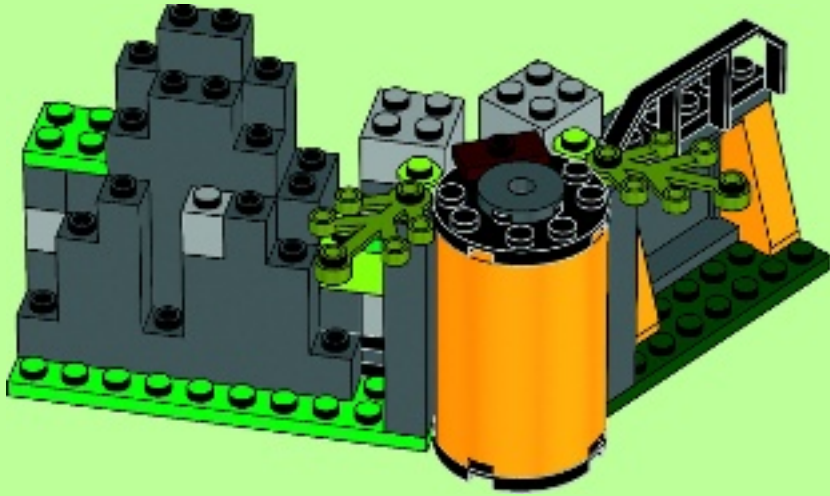

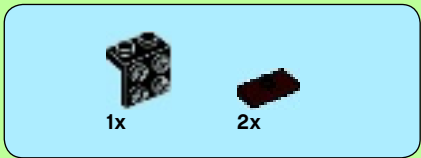

25

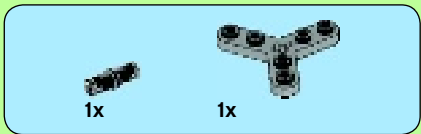
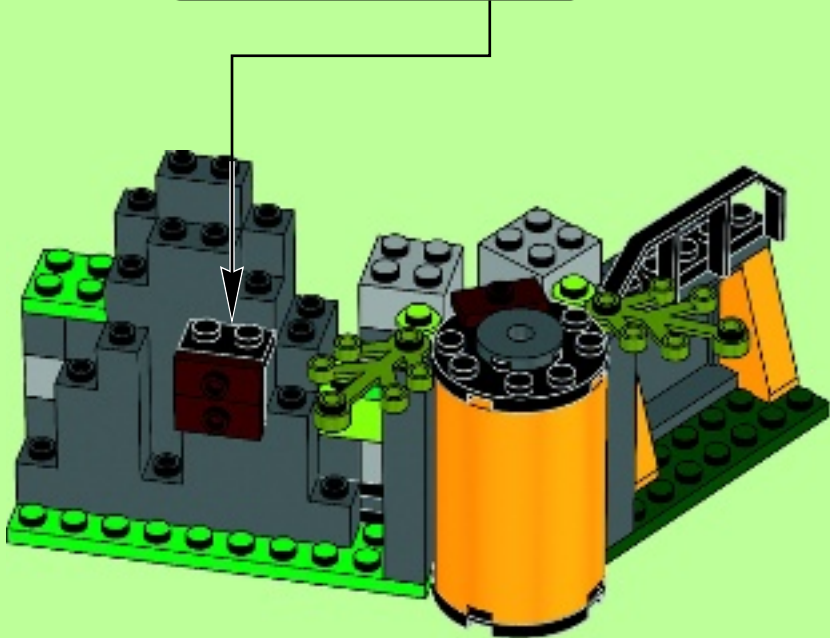

26

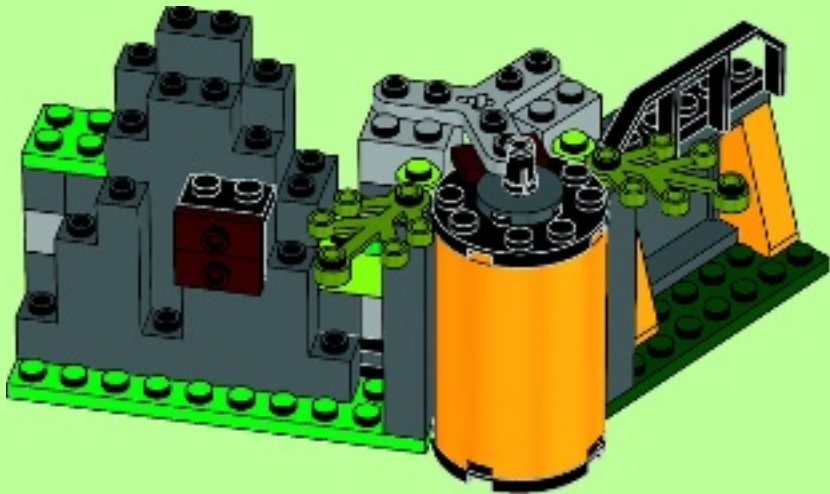

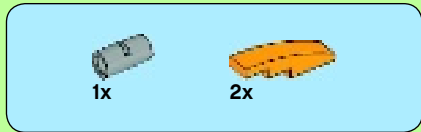

27

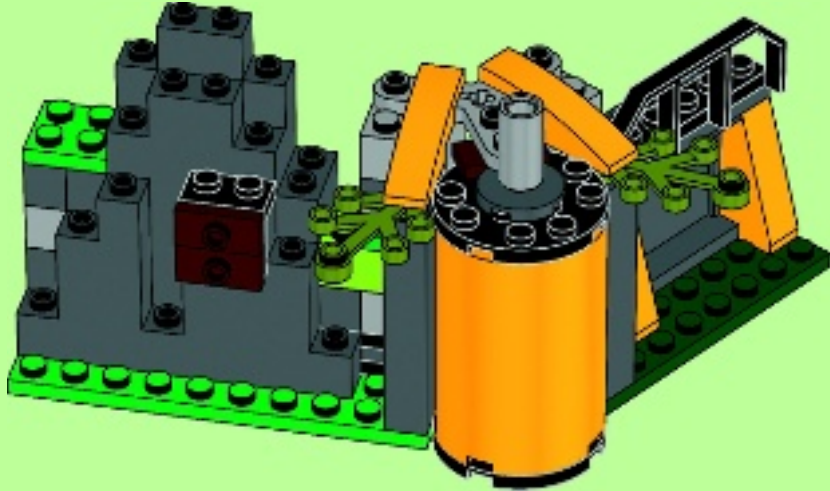

28

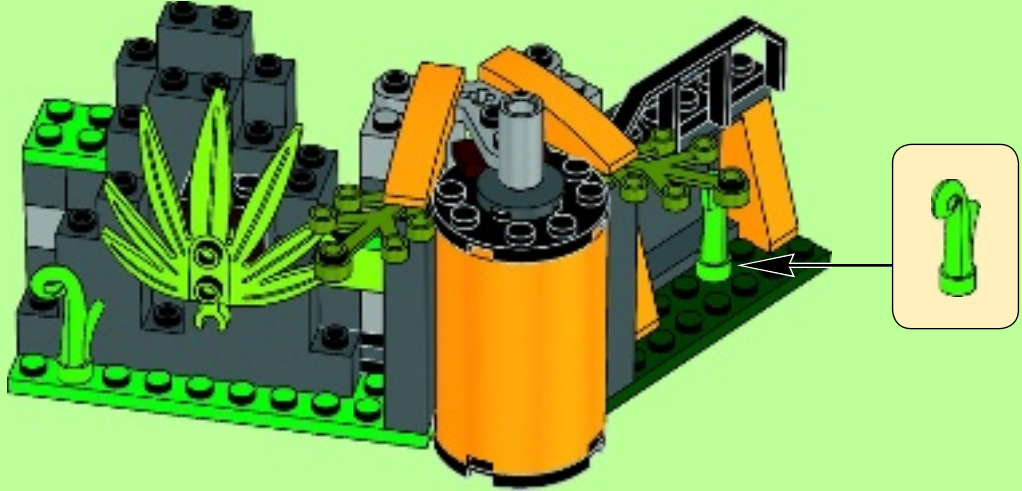



1

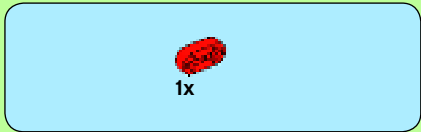
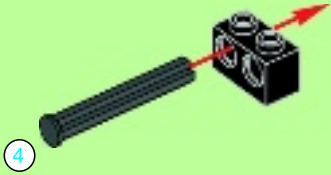

2

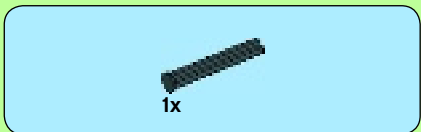

3

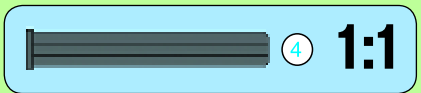

4



5



6

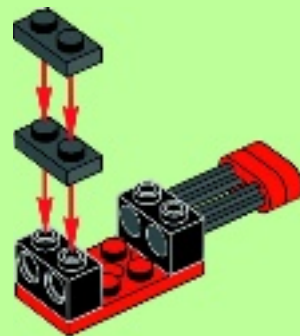

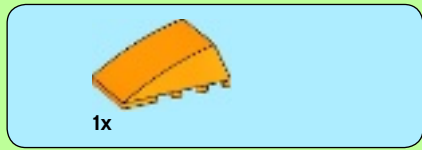

7

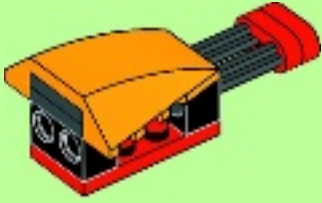

8

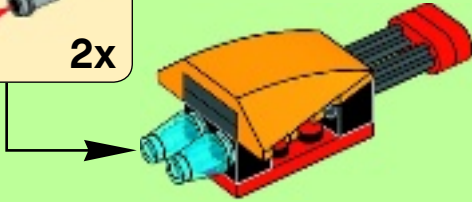
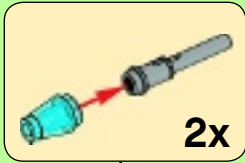

9

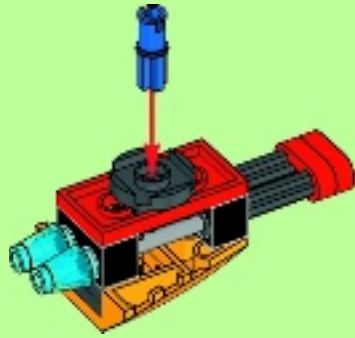
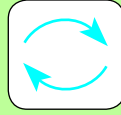

29



2x

30

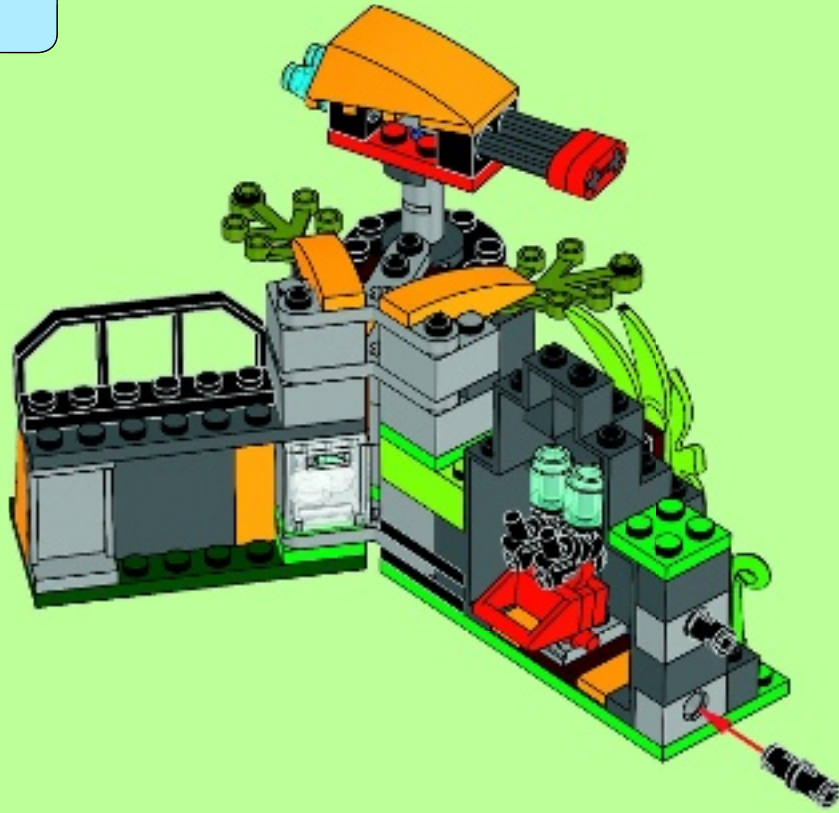

31

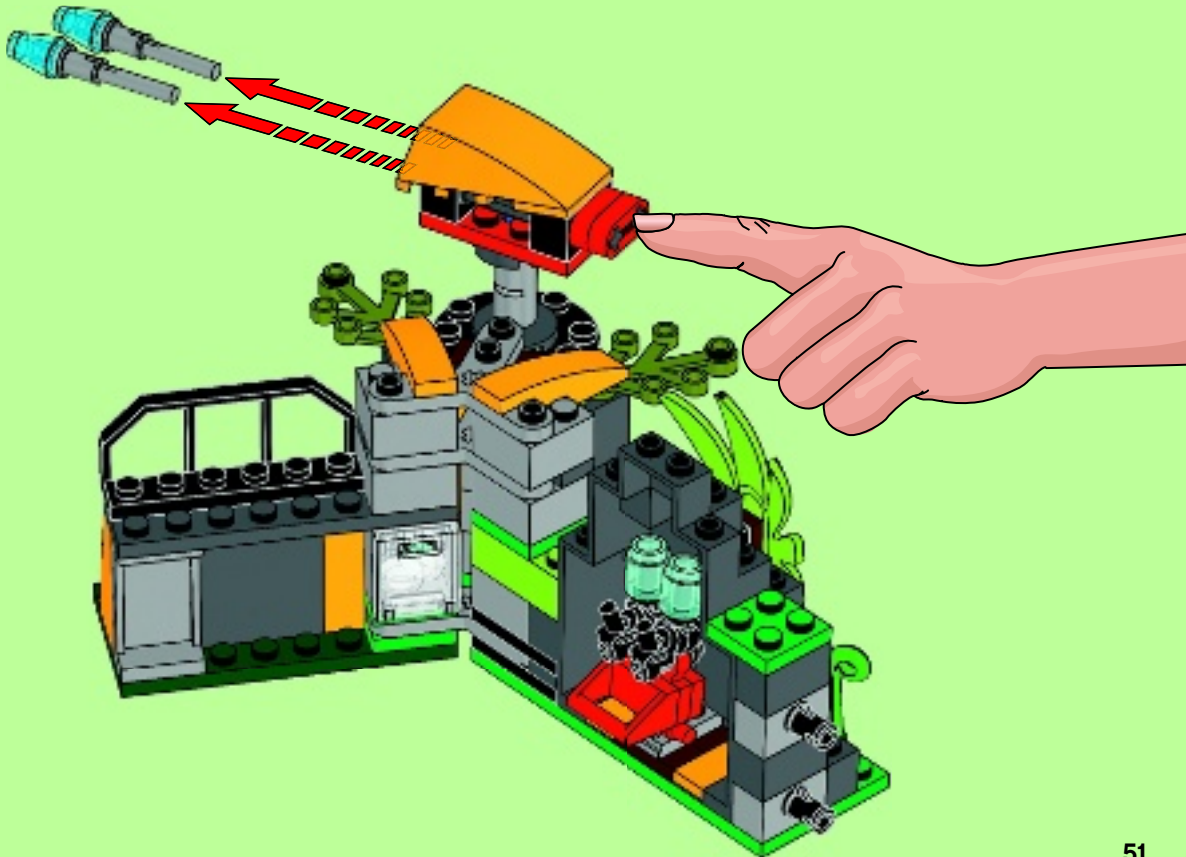



+

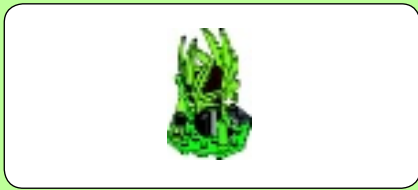

1

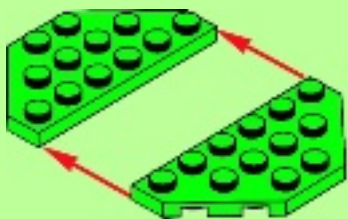

2

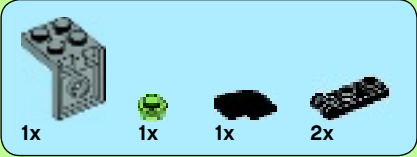

3

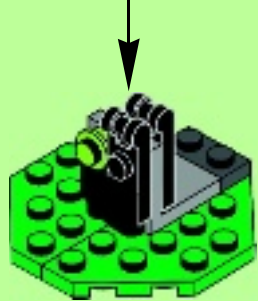
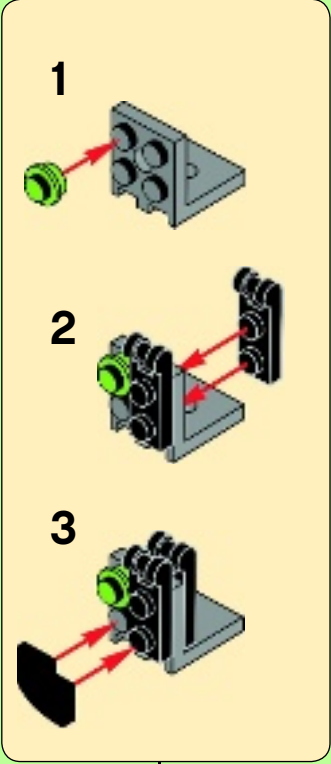



2x



2x

4



2x

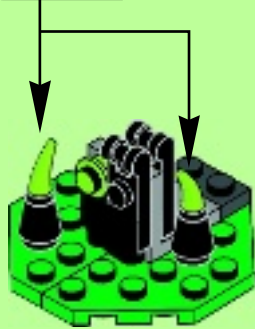

1x



2x

5



2x



2x

6



2x



7

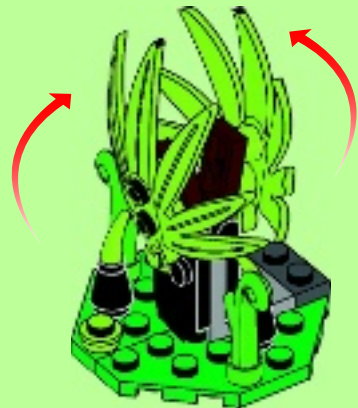



1



2

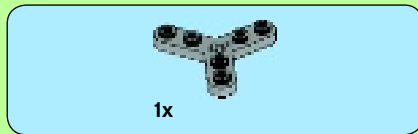

3



4



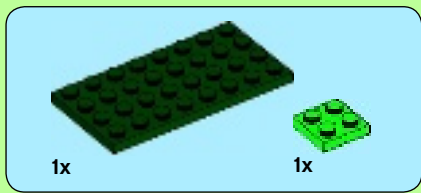

5

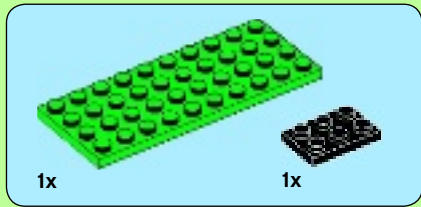
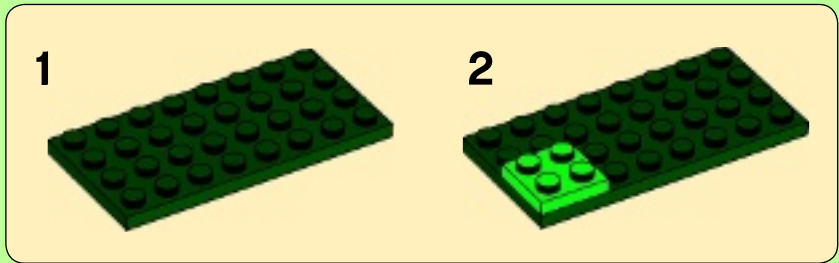

6

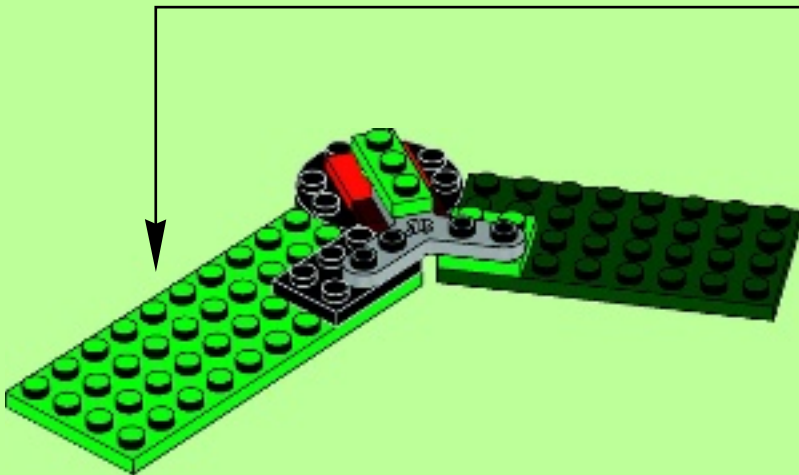
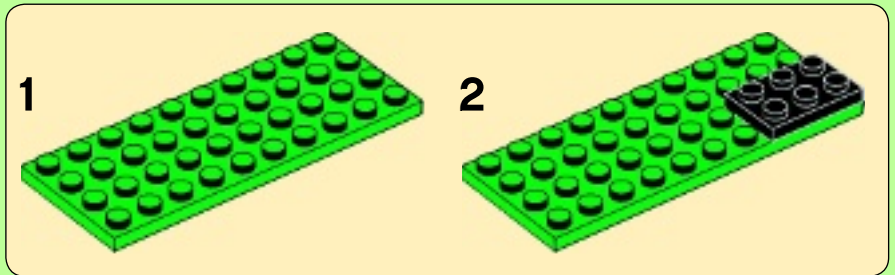

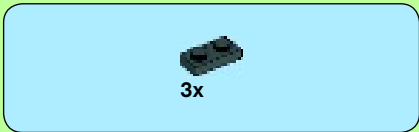

7

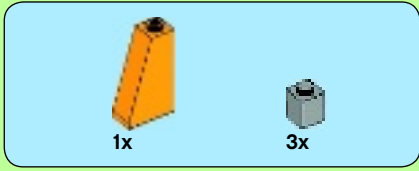
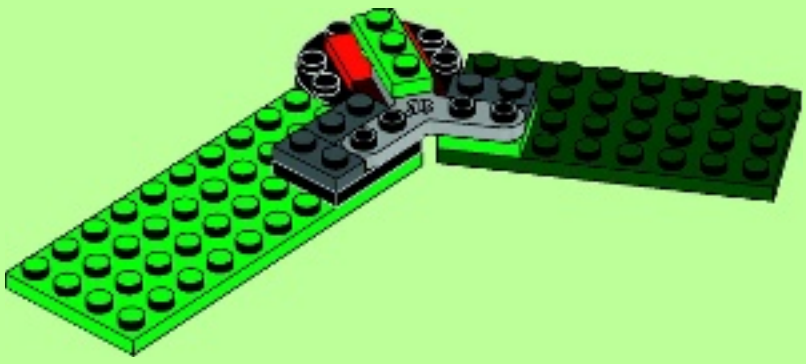

8

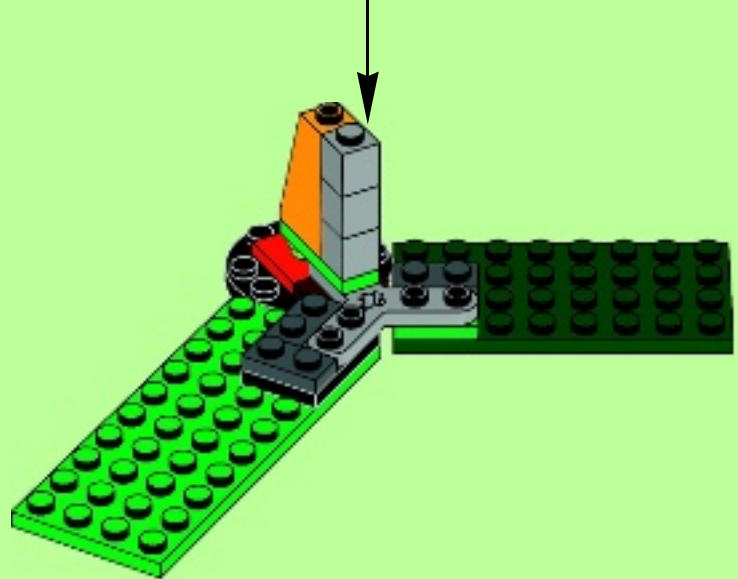
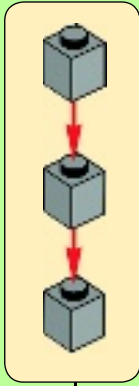



9

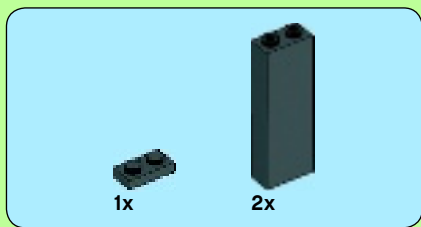
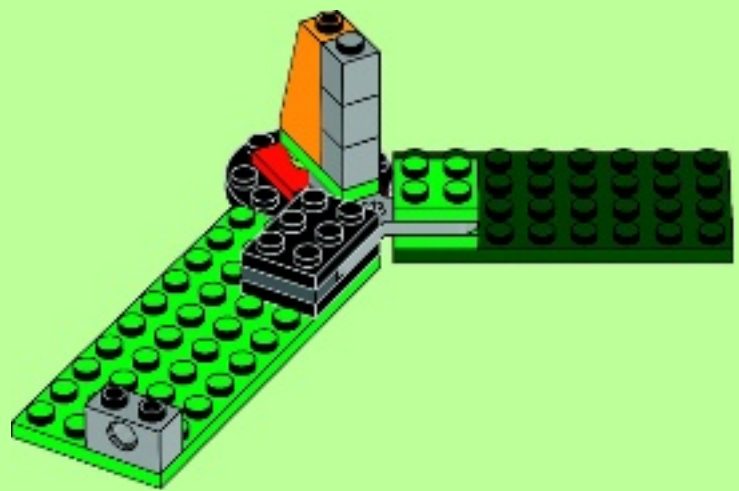

10

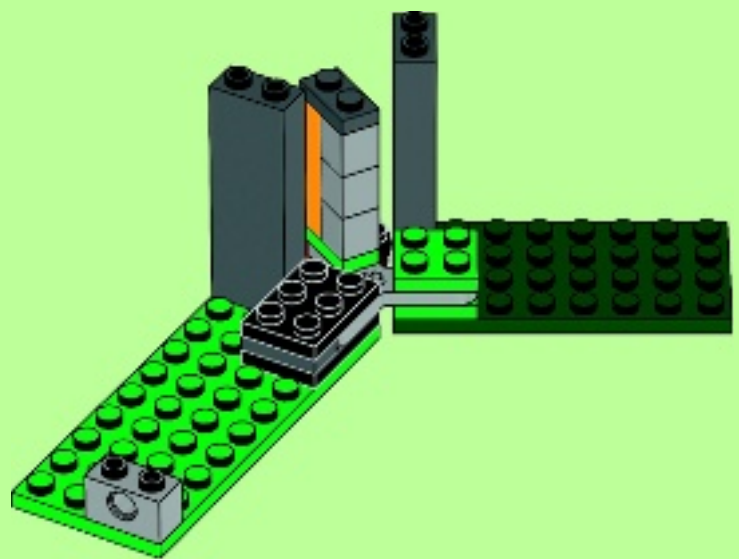



11

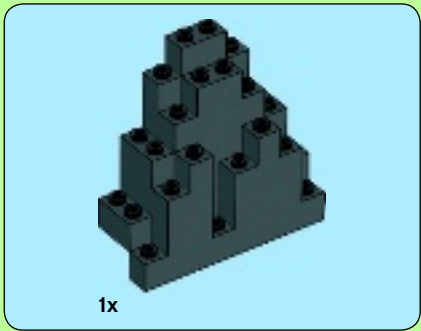
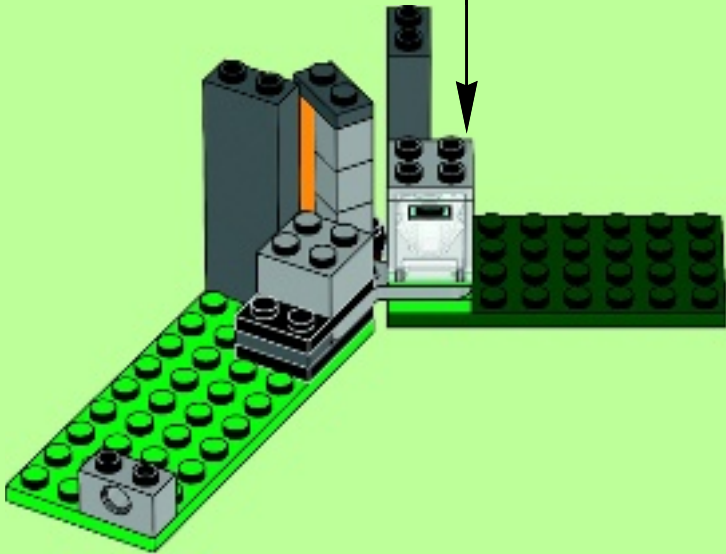
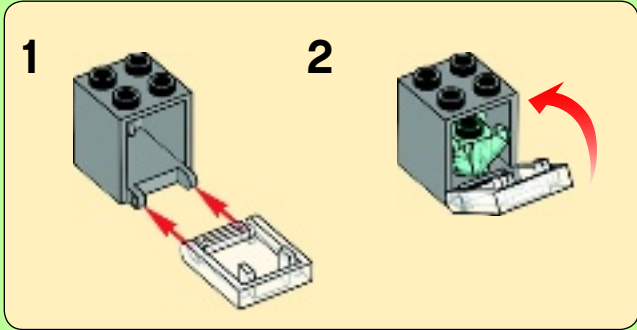

12

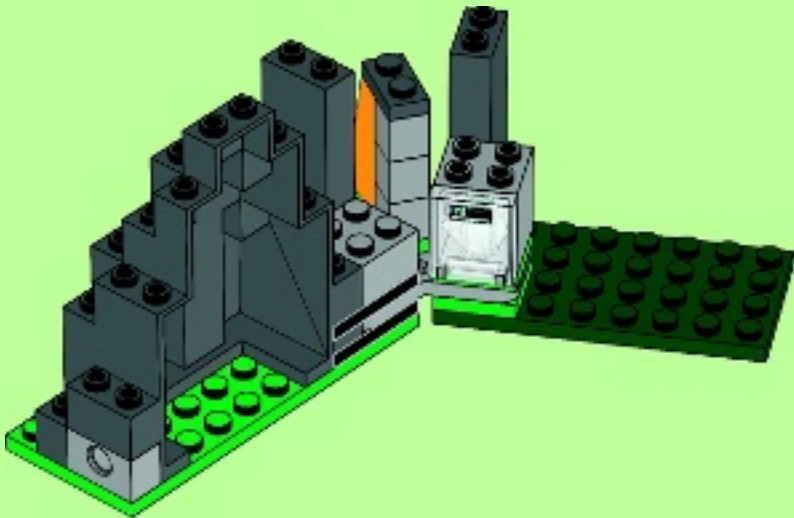

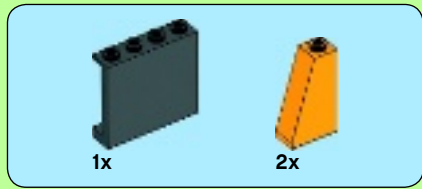

13

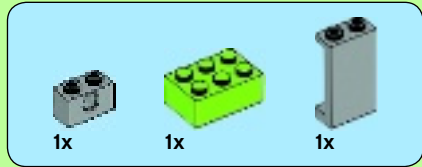
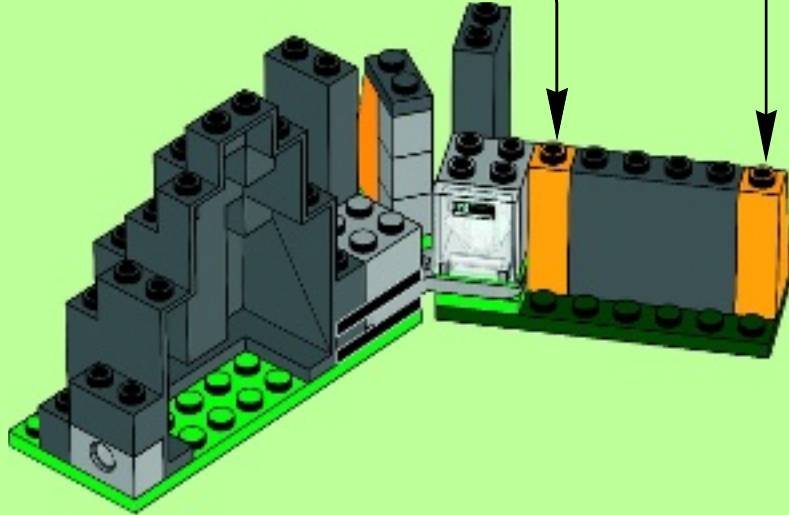

14

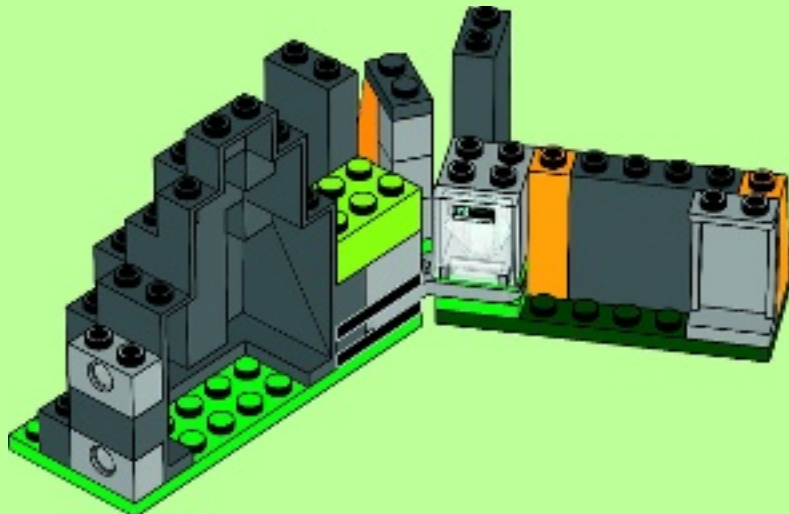

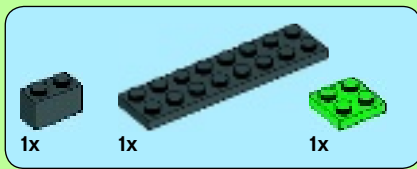

15

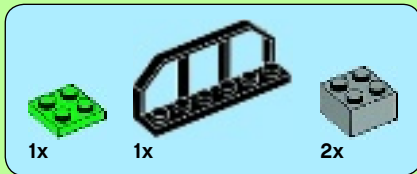
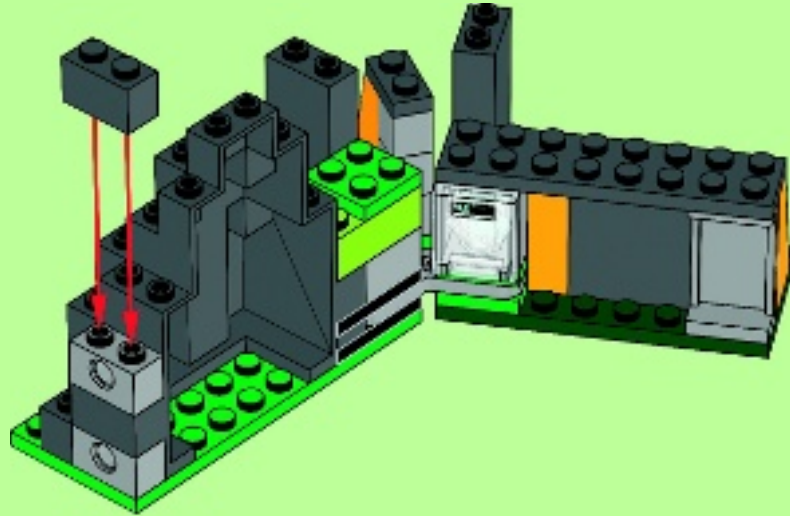

16

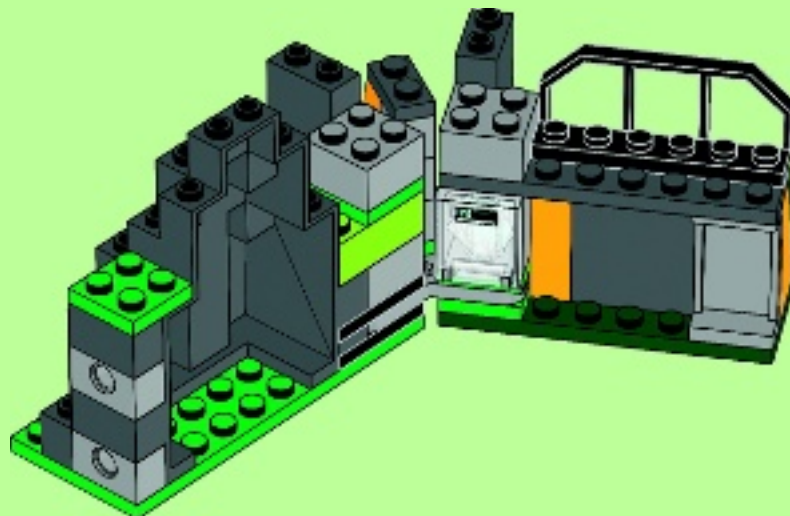

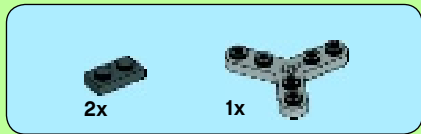

17

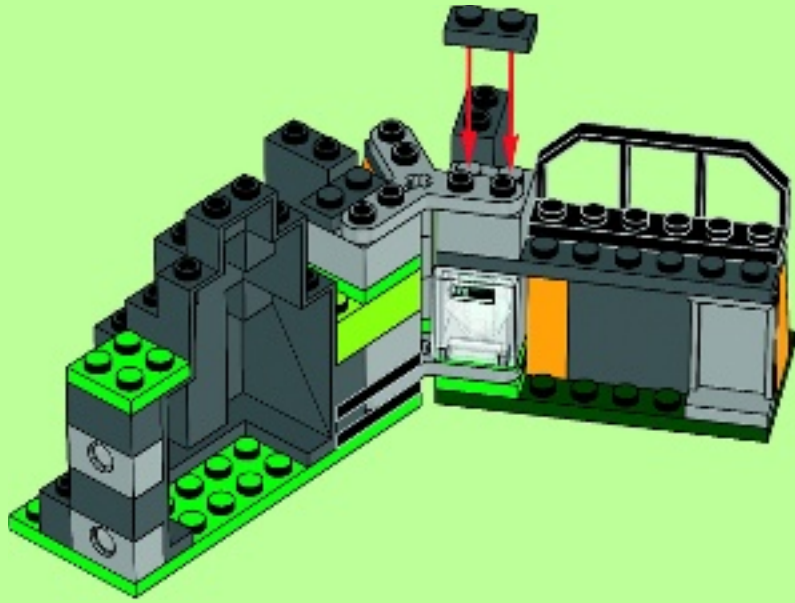

18

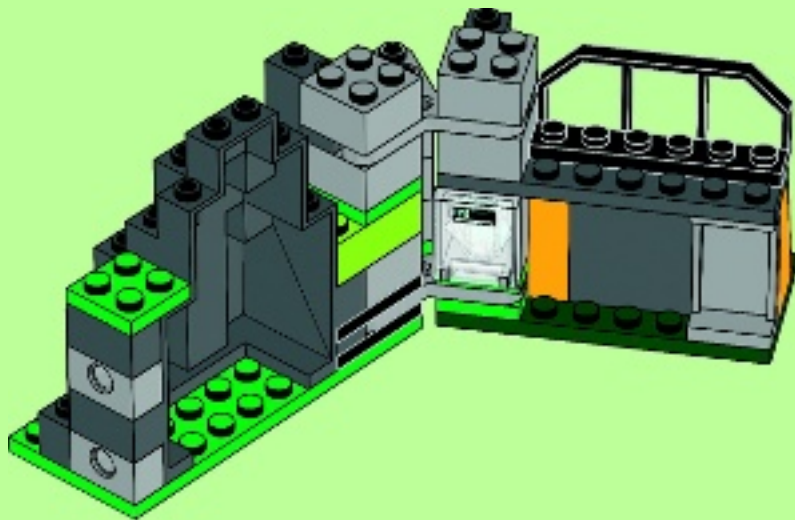



19



20





21



22





23

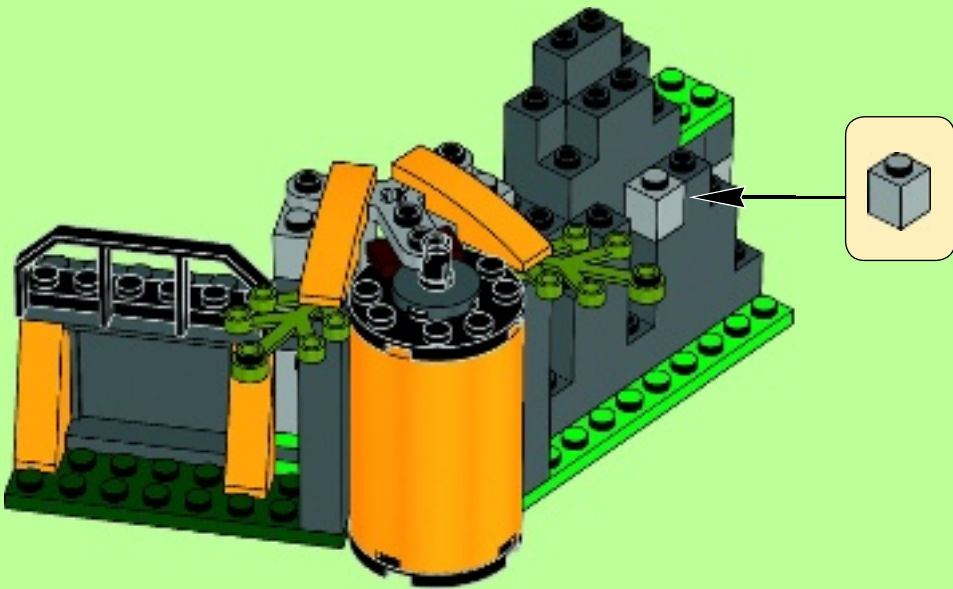

24

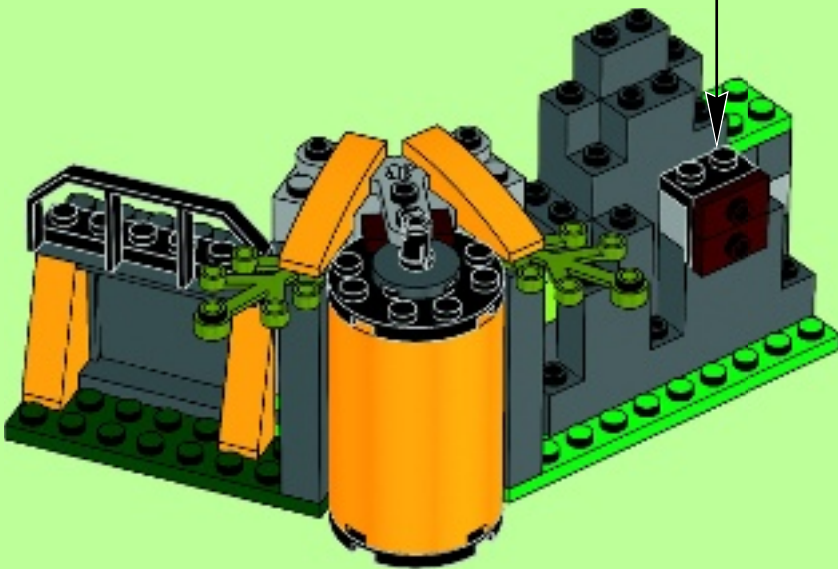
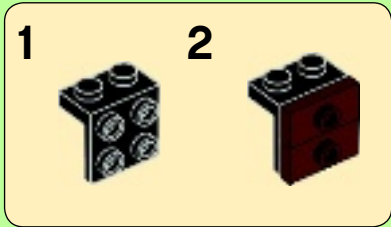



25

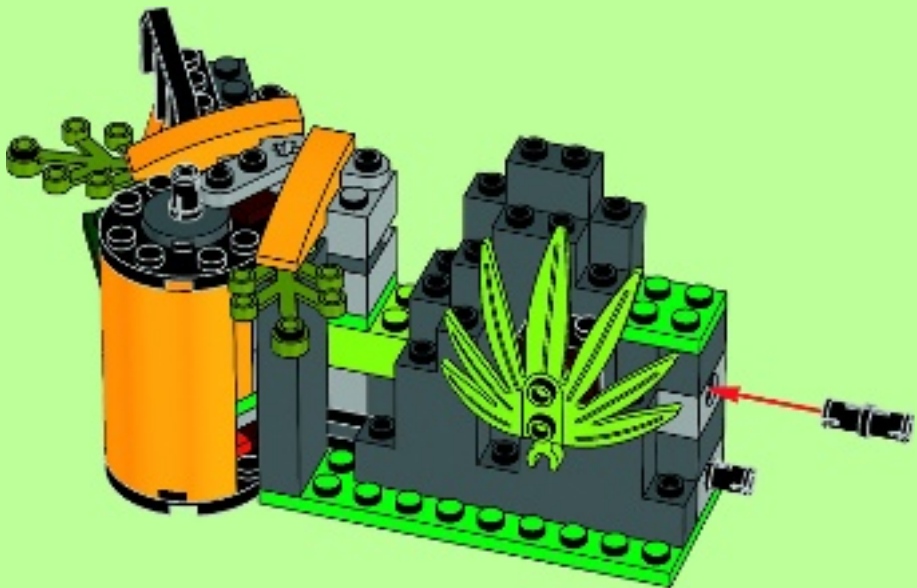



1

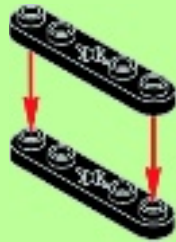

2



3



4

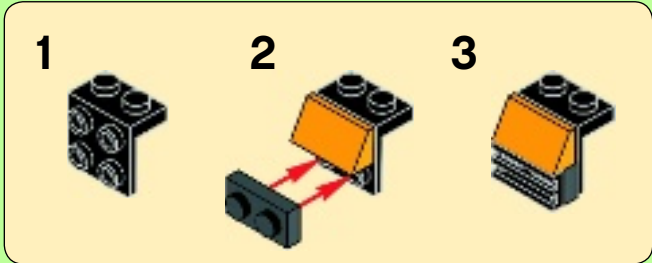

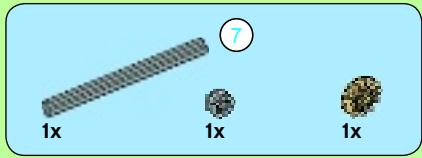

5

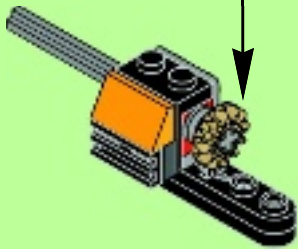
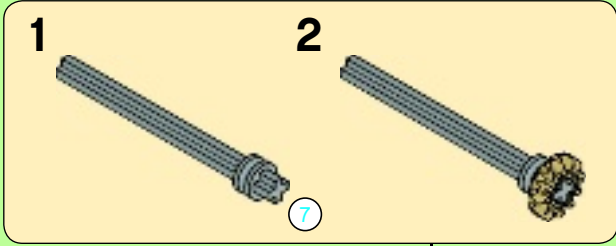

6

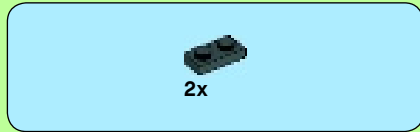
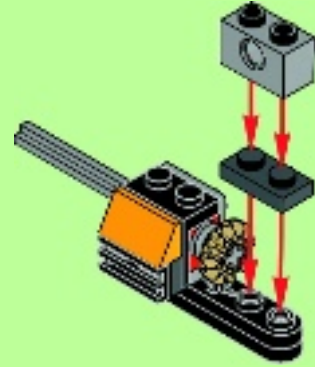

7

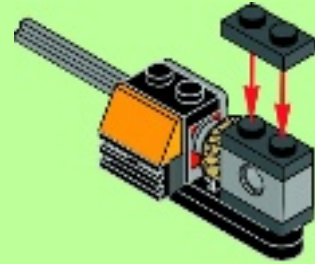

8





9

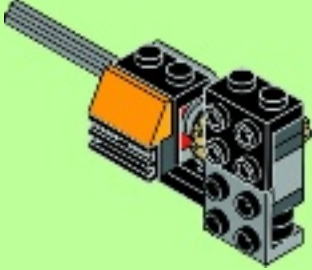

10

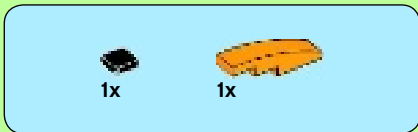
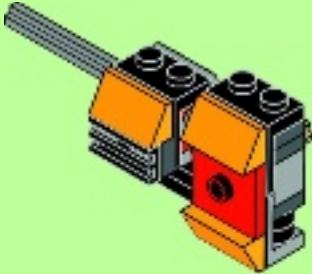

11



12

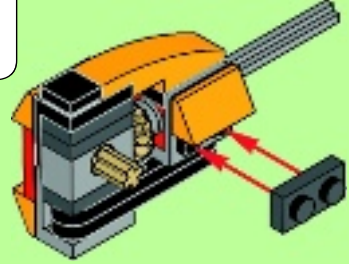

13

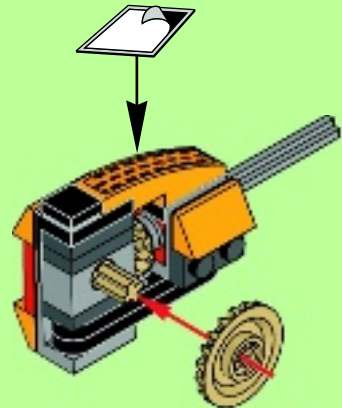



14

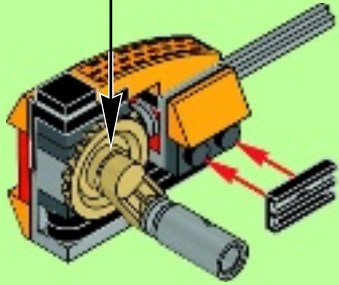
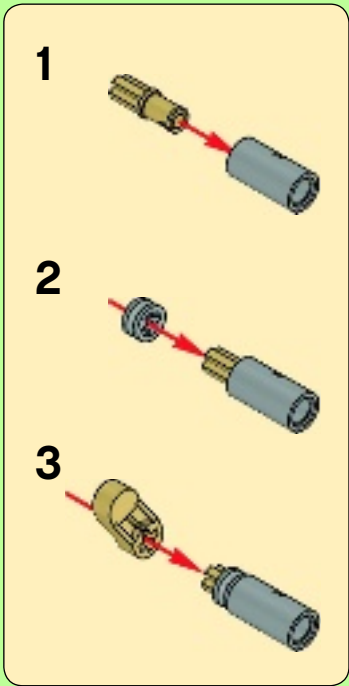

15

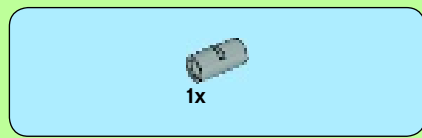
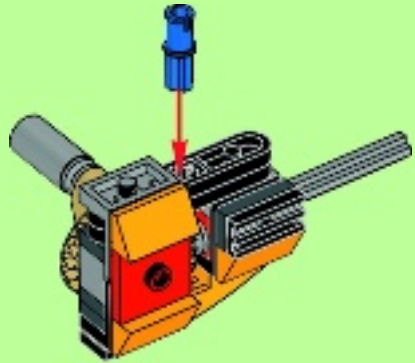
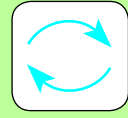

16

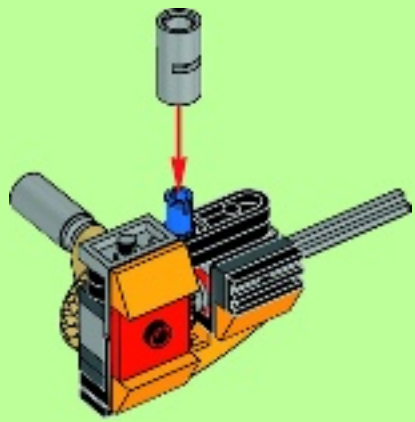

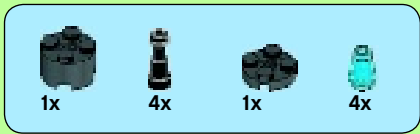

17

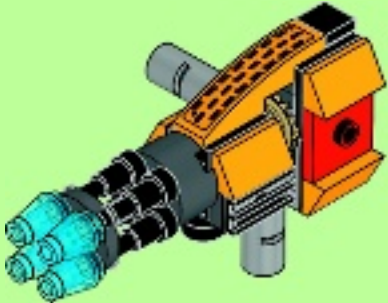
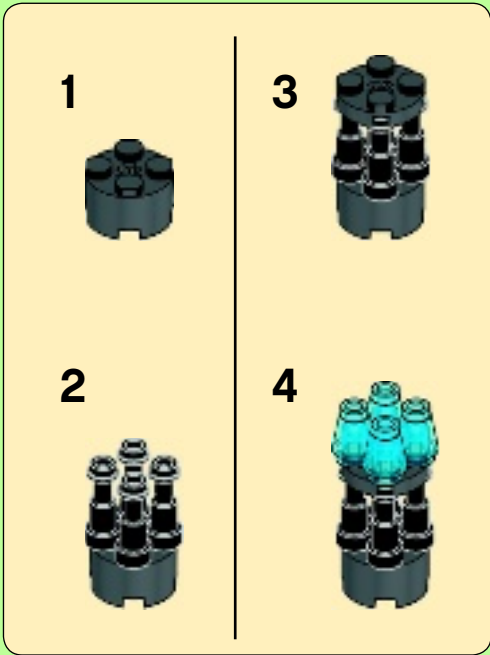

26

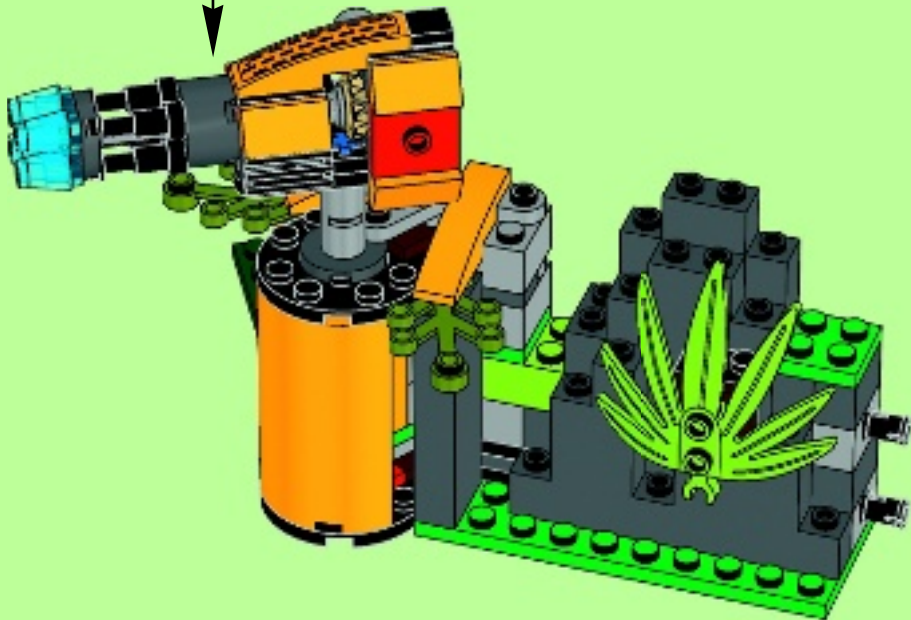

27









1x 6054950
 1x 6021599
 1x 6013937
 6x 4666579
 2x 4514554
 1x 4565452
 1x 6031962
 2x 4514555
 2x 654121
 3x 4651524
 5x 302321
 3x 4581308
 2x 366621
 6x 4588003
 1x 243221
 1x 4140585
 2x 370921
 4x 4186678
 1x 4227649
 3x 4513174

1x 6055116
 2x 4143005
 11x 4206482
 2x 407026
 3x 4162443
 11x 4529236
 5x 3200026
 10x 4504382
 2x 4251161
 1x 307026
 8x 241226
 8x 302126
 1x 243126
 4x 371026
 4x 6030718
 2x 4517925
 2x 6021512
 4x 6048855

2x 6016172
 2x 6061032
 5x 4515368
 1x 4523339
 2x 4114689
 1x 4278359
 3x 4180087
 5x 4515350
 2x 6006739
 6x 4538456
 2x 4537551
 1x 452226
 1x 400626
 1x 383526
 2x 4659662
 1x 6051527
 2x 6051532
 1x 4639695

3x 4619323
 2x 249626
 1x 3003126
 1x 4191191
 1x 4667463
 2x 6015891
 3x 4289538
 1x 4124096
 2x 4205760
 4x 4142236
 1x 4184169
 10x 4121715
 1x 4107084
 3x 370526
 1x 6061538
 1x 4538722



2x 4180576
 3x 300926
 3x 658326
 1x 4160108
 1x 4160130
 1x 6023165
 11x 4219726
 3x 4211211
 2x 6008297
 2x 4211159
 1x 6057376
 1x 6057918
 1x 6057369
 1x 6057699
 1x 6057365
 1x 6050817

1x 4610353
 2x 4223986
 1x 4543259
 1x 4543262
 8x 302228
 3x 242328
 2x 4107758
 2x 6007895
 2x 241928
 6x 302028
 1x 4109679
 4x 6050929
 2x 4505051

1x 4654448
 2x 6019570
 9x 4567331
 2x 6064461
 2x 6013676
 4x 6023173
 5x 6024286
 10x 6023161
 9x 6045944
 4x 6020141
 8x 4622062
 1x 4621543
 4x 4654129



Customer Service
Kundenservice
Service Consommateurs
Servicio Al Consumidor
LEGO.com/service or dial

00800 5346 5555 :     

1-800-422-5346 :  

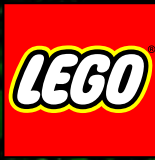

LEGENDS OF
CHIMATM



70129



70124



70130



70137



70131



70132



LEGO.COM/CHIMA



LEGENDS OF
CHIMA™



RINONA

70131



ROGON

70131 70133



LAVAL

70132 70134



LAVERTUS

70129 70134



SHADOWIND

70140



CRAGGER

70132



GORZAN

70130 70136



ERIS

70128 70133
70139



SCORM

70132



SCUTTER

70129



SCOLDER

70140



SPARRATUS

70130 70138



SPARACON

70131



BRAPTOR

70128



SPINLYN

70133



BLISTA

70134 70137



70132

70131



70130

70129

70128



70127



70126



70125



70124



70123



70140



70139



70138



70137



70136



LEGENDS OF

CHIMA

TM



LEGO.COM/CHIMA



LEGENDS OF

TM

CHIMA

LEGO.COM/CHIMA

**JOIN
THE QUEST!**

DAS ABENTEUER ERWARTET DICH!
REJOINS LA QUETE!
¡PARTICIPA EN LA AVENTURA!
JUNTA-TE A MISSÃO!
SEGITS TE IS A KERESÉSZEN!

1 SCAN

SCANNEN
SCANNE
ESCANER
FAZ SCAN
OLVASD BE



[http://www.lego.com/
Quest235](http://www.lego.com/Quest235)



2 WATCH

ANSEHEN · REGARDER
MIRA · VÊ · NÉZD MEG



LEGOLAND[®]

PARKS

BILLUND • DEUTSCHLAND
MALAYSIA • WINDSOR



LEGOLAND[®]

DISCOVERY CENTRE

MANCHESTER • TOKYO
BERLIN • OBERHAUSEN

LEGO, the LEGO logo and LEGENDS OF CHIMA are trademarks of the LEGO Group. ©2014 The LEGO Group.



LEGO.com



LEGO LEGENDS OF CHIMA[™]

FIND OUT MORE AND GET
SPECIAL OFFERS
AT LEGOLAND-CHIMA.COM

KIDS GO FREE

with full paid adult ticket

Purchase at LEGOLAND-CHIMA.com

See website for terms and offer details.

FREIER KINDER-EINTRITT

in Verbindung mit einem voll
zahlenden Erwachsenen.

Erhältlich bei LEGOLAND-CHIMA.com

Siehe Webseite für alle Angebotsdetails
und Konditionen.

ENTRÉE GRATUITE POUR LES ENFANTS

pour l'achat d'un billet adulte

Billets disponibles à la vente sur

LEGOLAND-CHIMA.com

Conditions et détails de l'offre disponibles sur le site Internet