



NINJAGO

Masters of Spinjitzu

30293

6114491



1

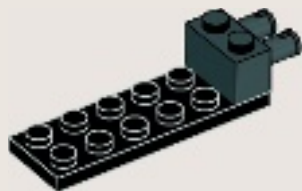

2

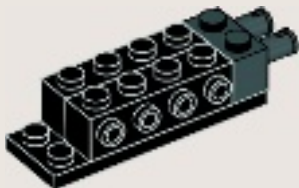

3

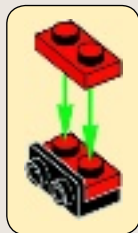

4

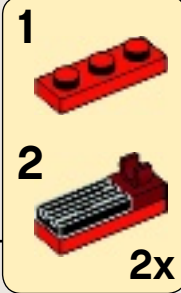
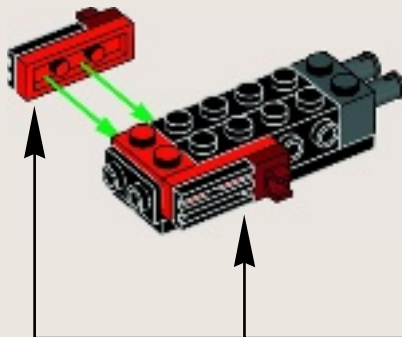

5



6



7



8



9

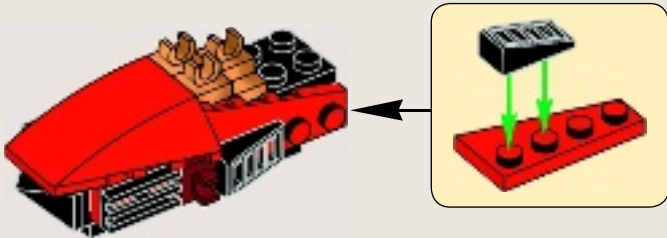

10

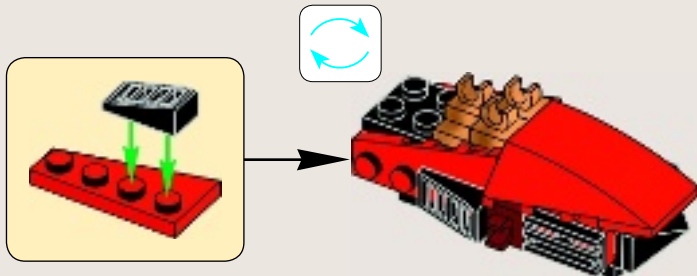

11

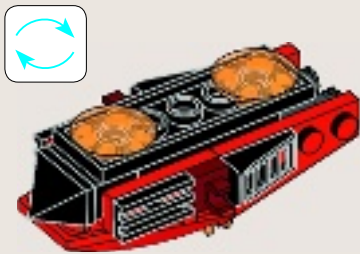

12

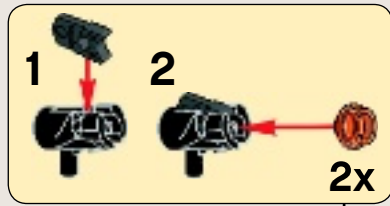
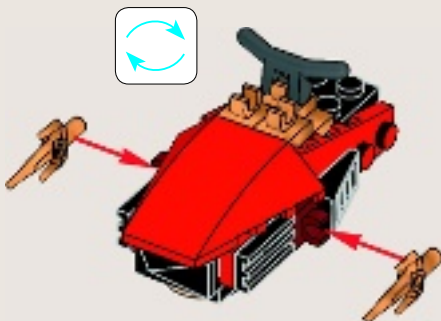

13

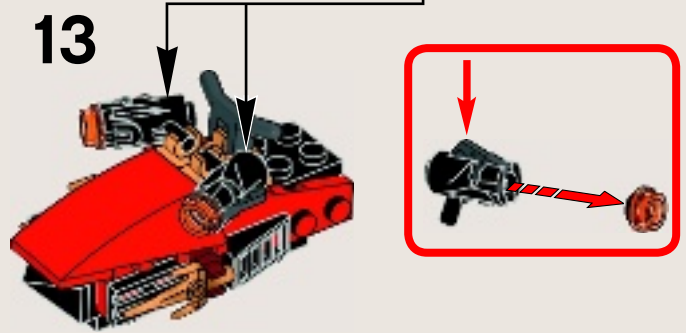

14



LEGO.com/service

LEGO.com/ninjago

LEGO and the LEGO logo are trademarks of the LEGO Group. ©2015 The LEGO Group. 6114491



LEGO.COM/NINJAGO