



# CREATOR

7346



1

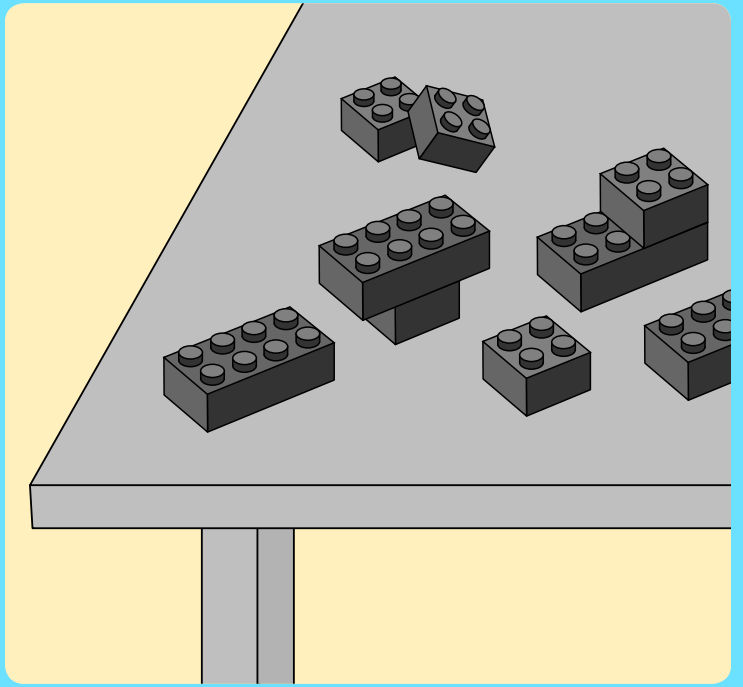
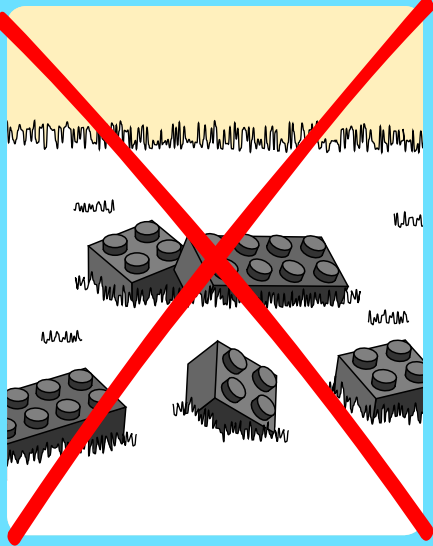

2

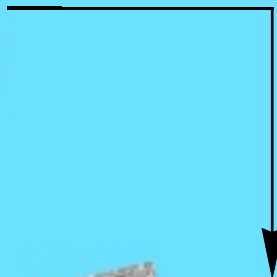





## Quick Build Construction Facile

Anfängermodelle  
Construcción rápida  
Construção Rápida  
Egyszerűen és gyorsan -  
kezdőknek



## Medium Build Construction moyenne

Fortgeschrittenenmodelle  
Construcción  
de nivel intermedio  
Construção  
Intermédia  
Egyszerűen  
és gyorsan - gyakorlóknak



## Advanced Build Construction avancée

Profimodelle  
Construcción de nivel avanzado  
Construção Avançada  
Egyszerűen és gyorsan -  
tapasztalt építőknek



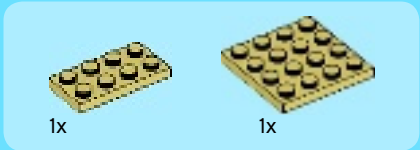
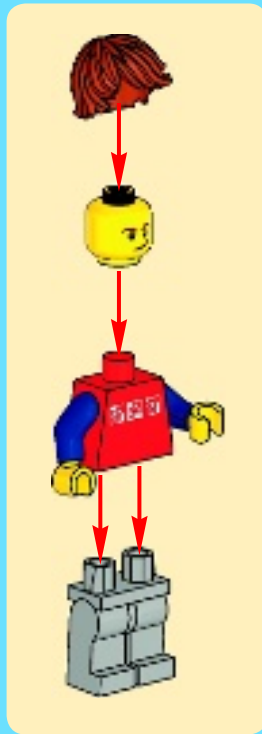

1

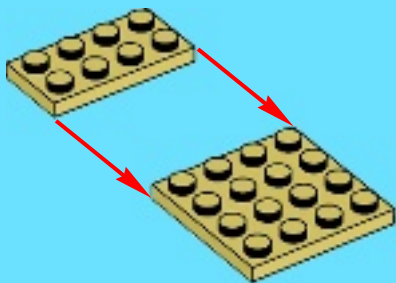

2

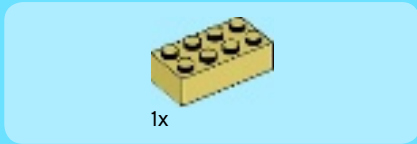





1x

3

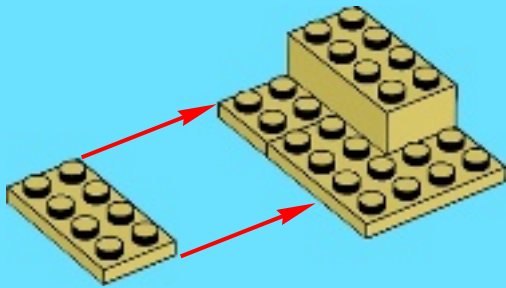

1x

4



2x

5

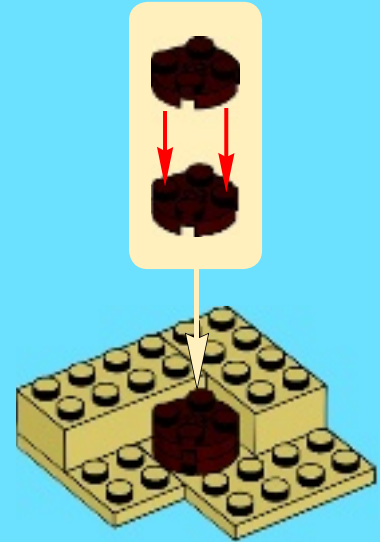

1x

6

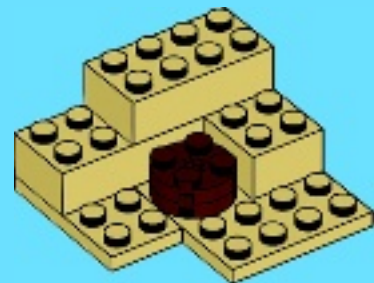



5x



1x

# 7

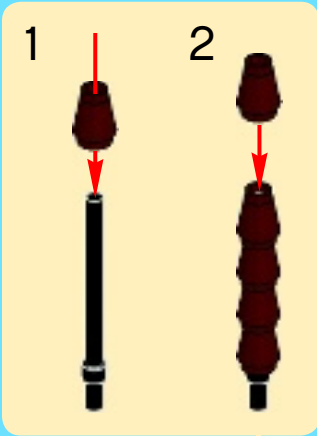

2x



4x

# 8

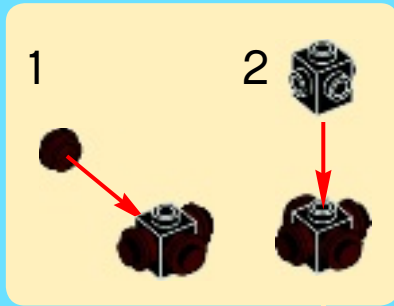



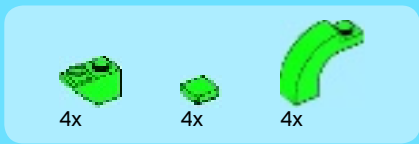

9

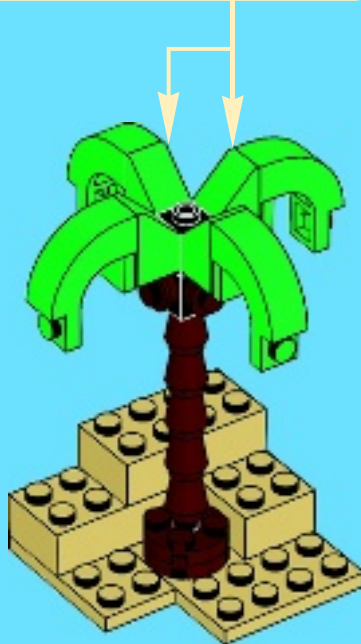
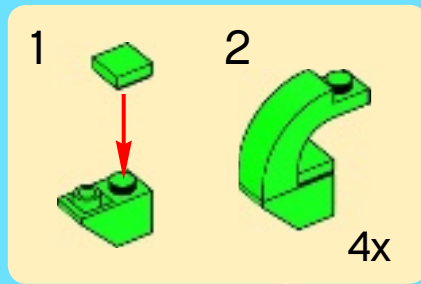

- 1x
- 1x
- 1x
- 2x
- 2x
- 1x
- 1x

# 10







1x

1

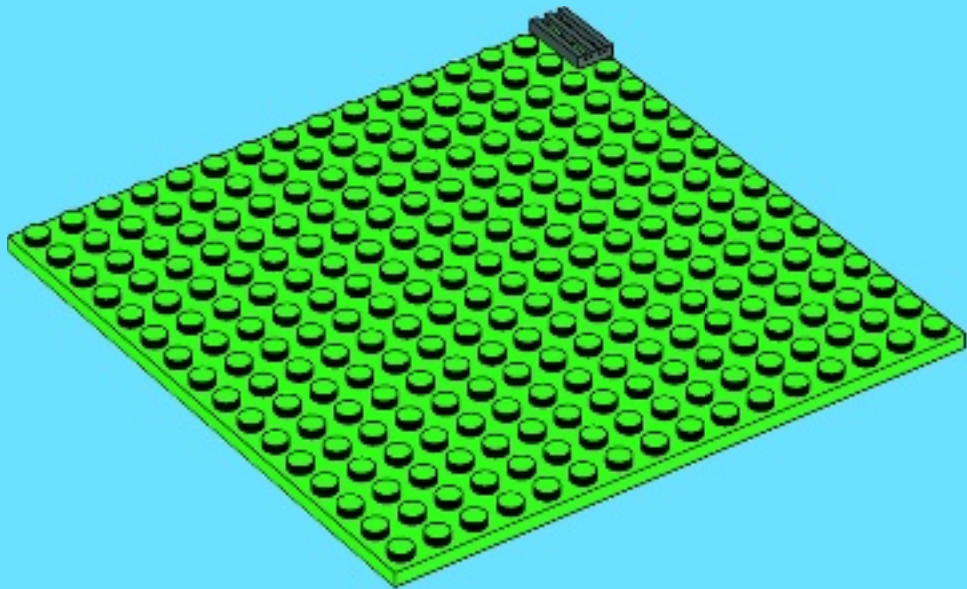



2x

# 2

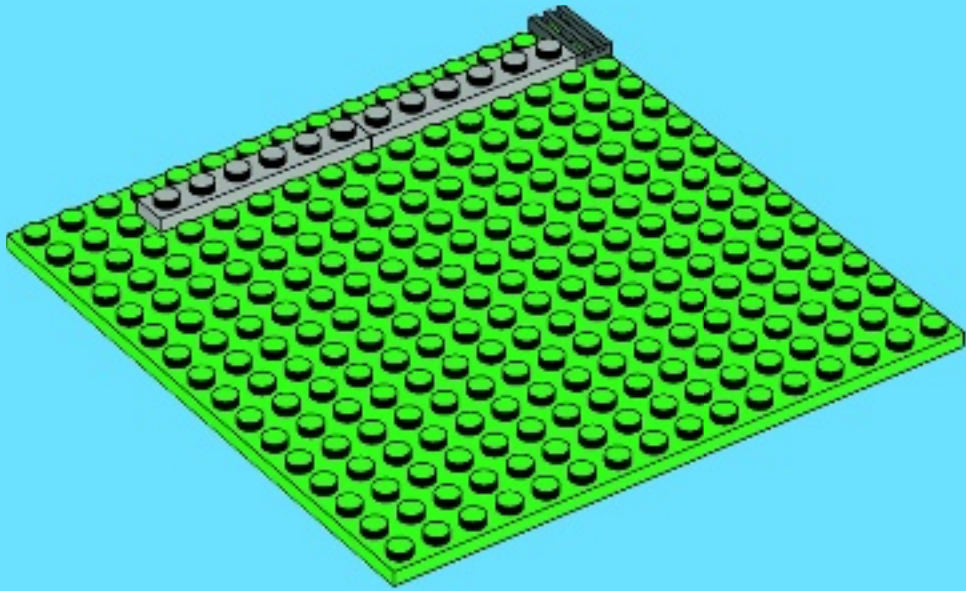

2x



2x

# 3

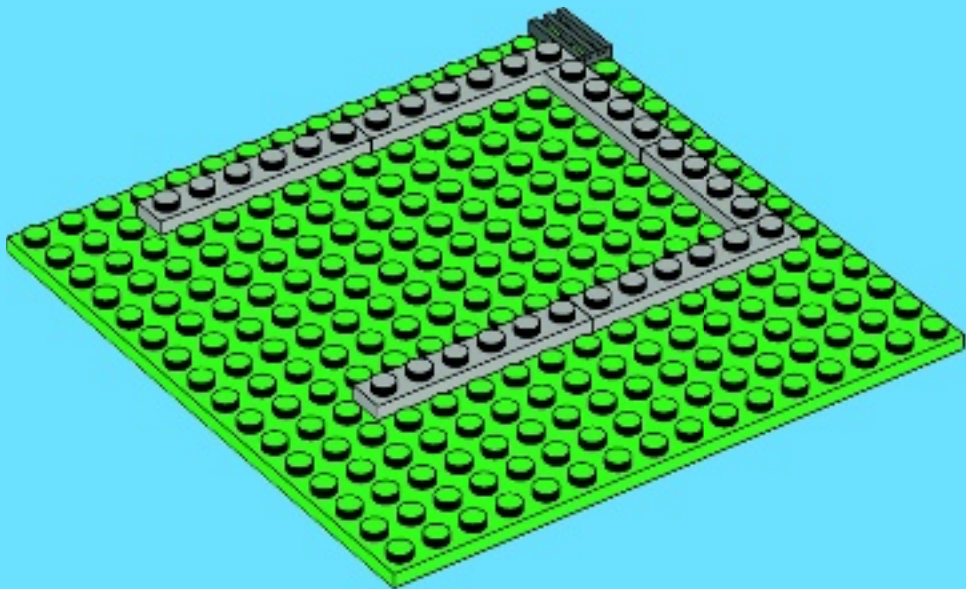



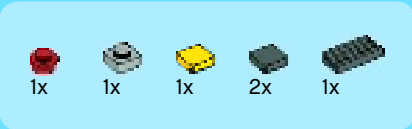

4

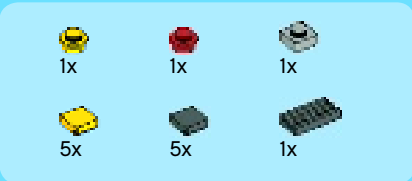
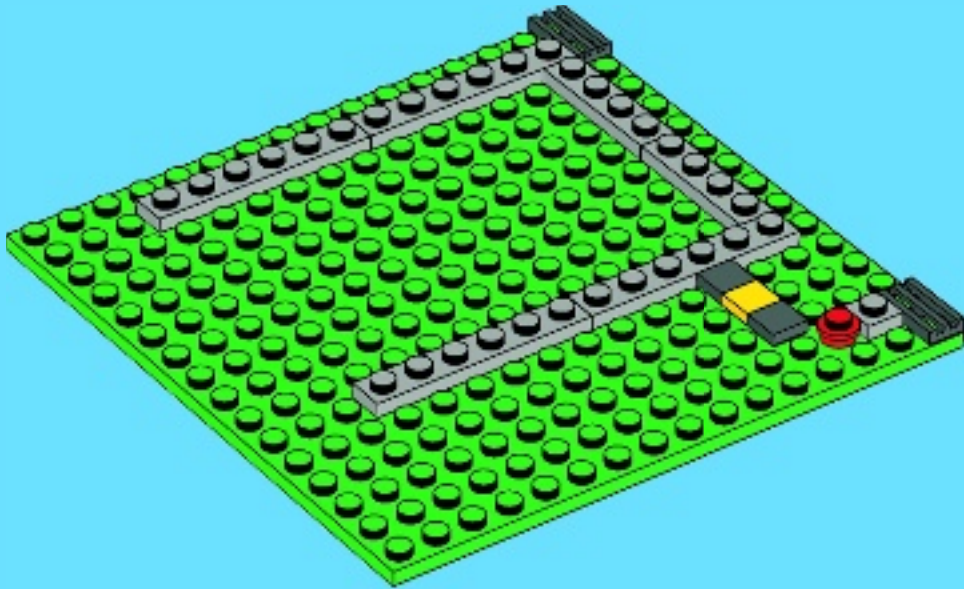

5

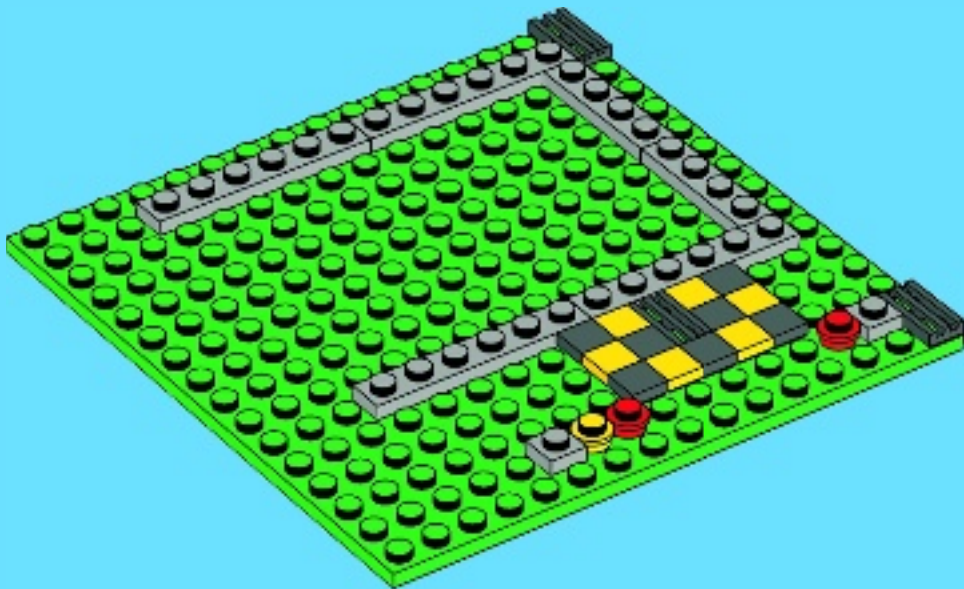

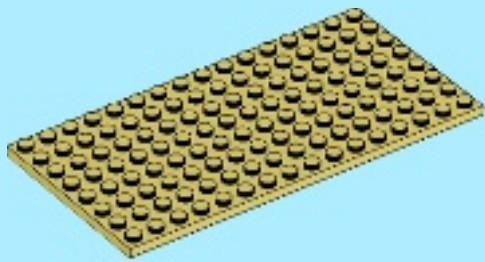

1x

6

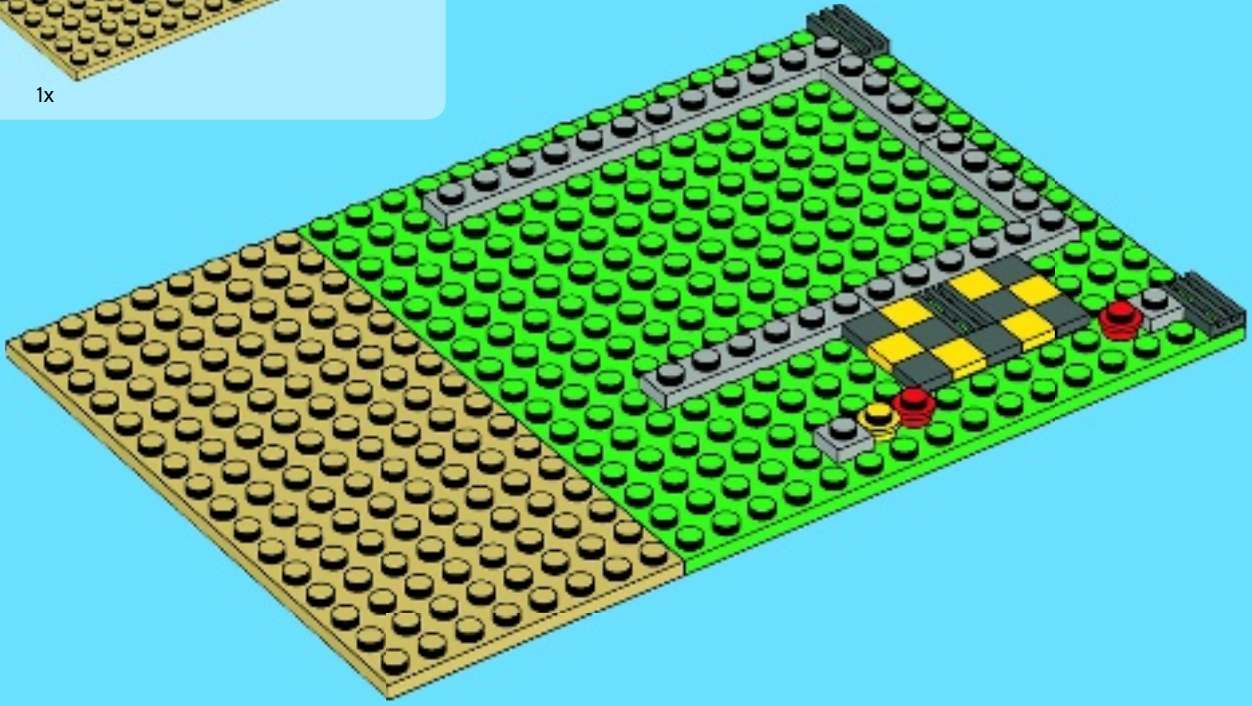

1x

7

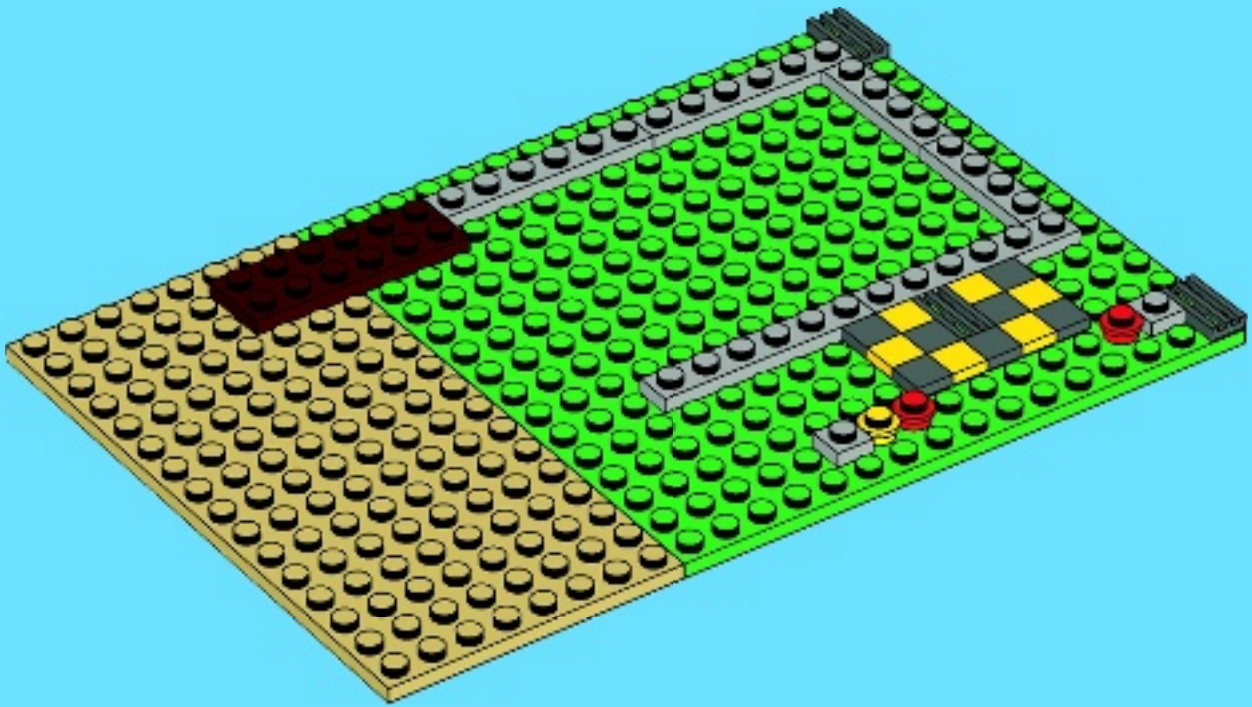

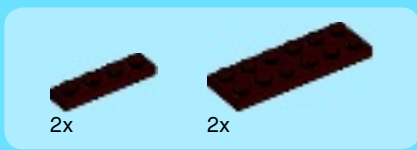

8

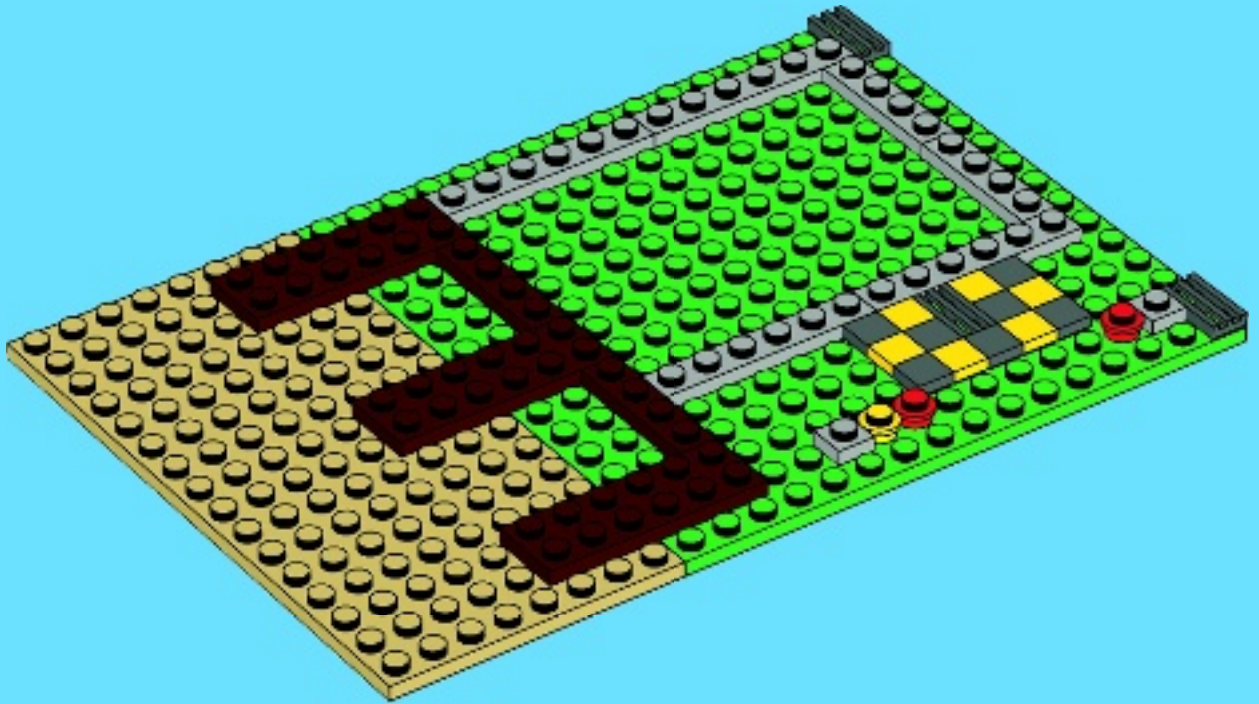



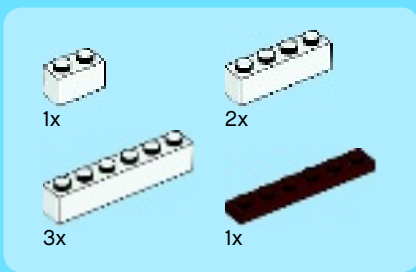

9

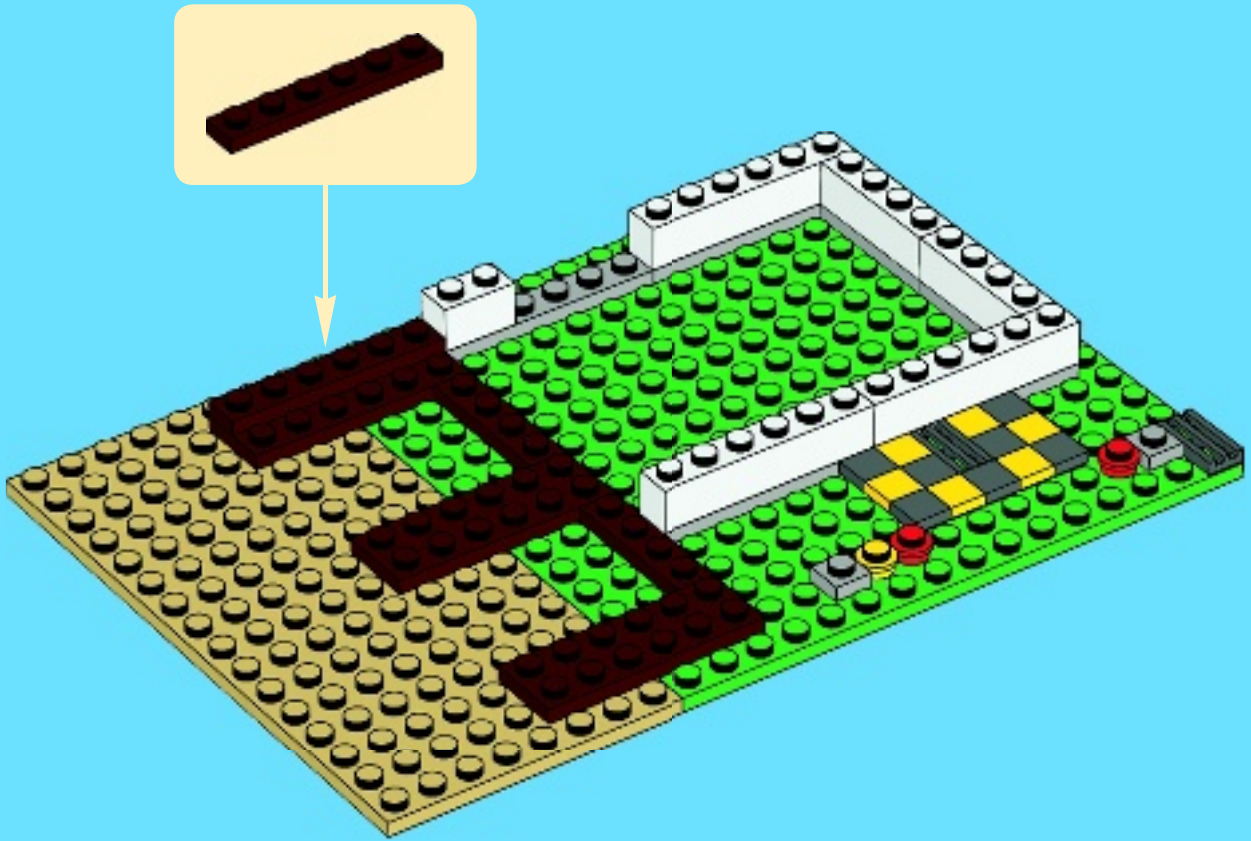



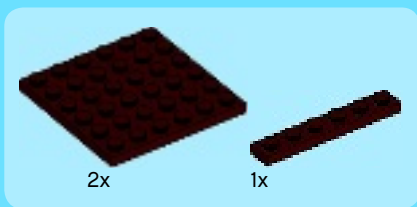

10

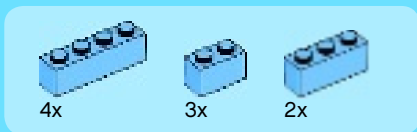

11

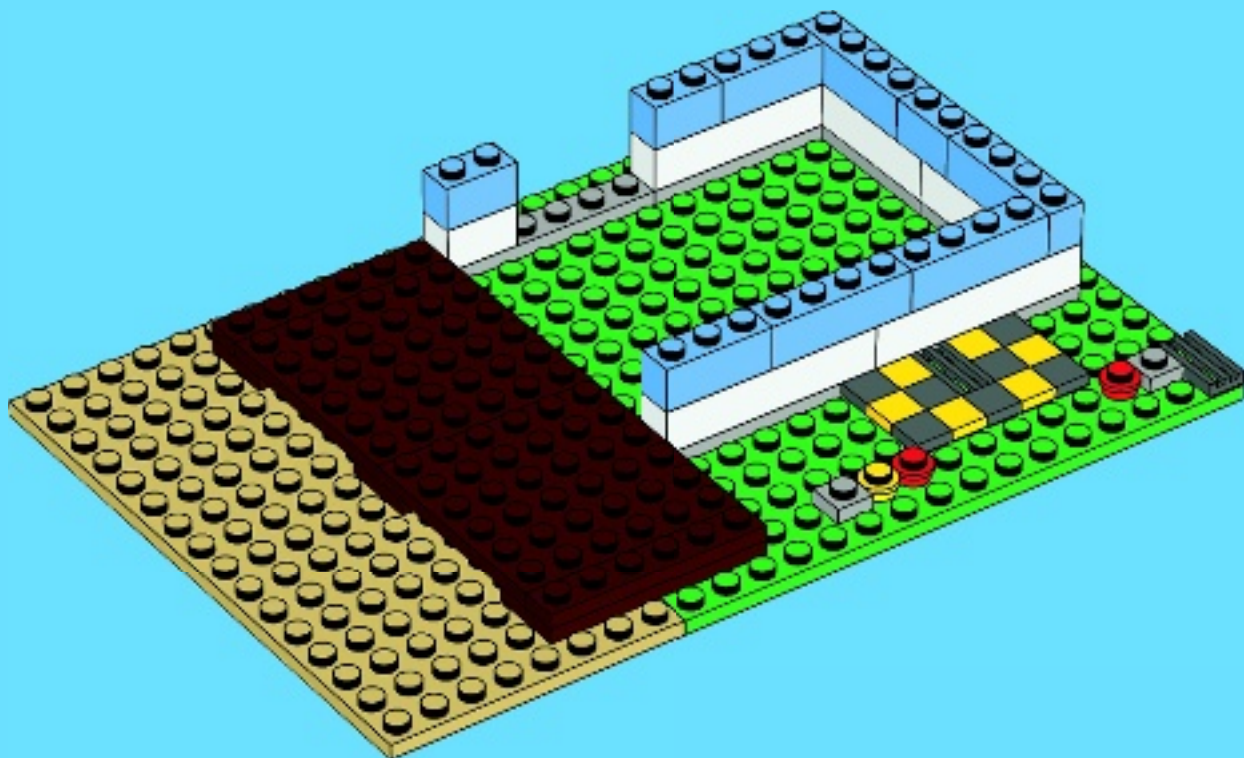



3x



2x

# 12

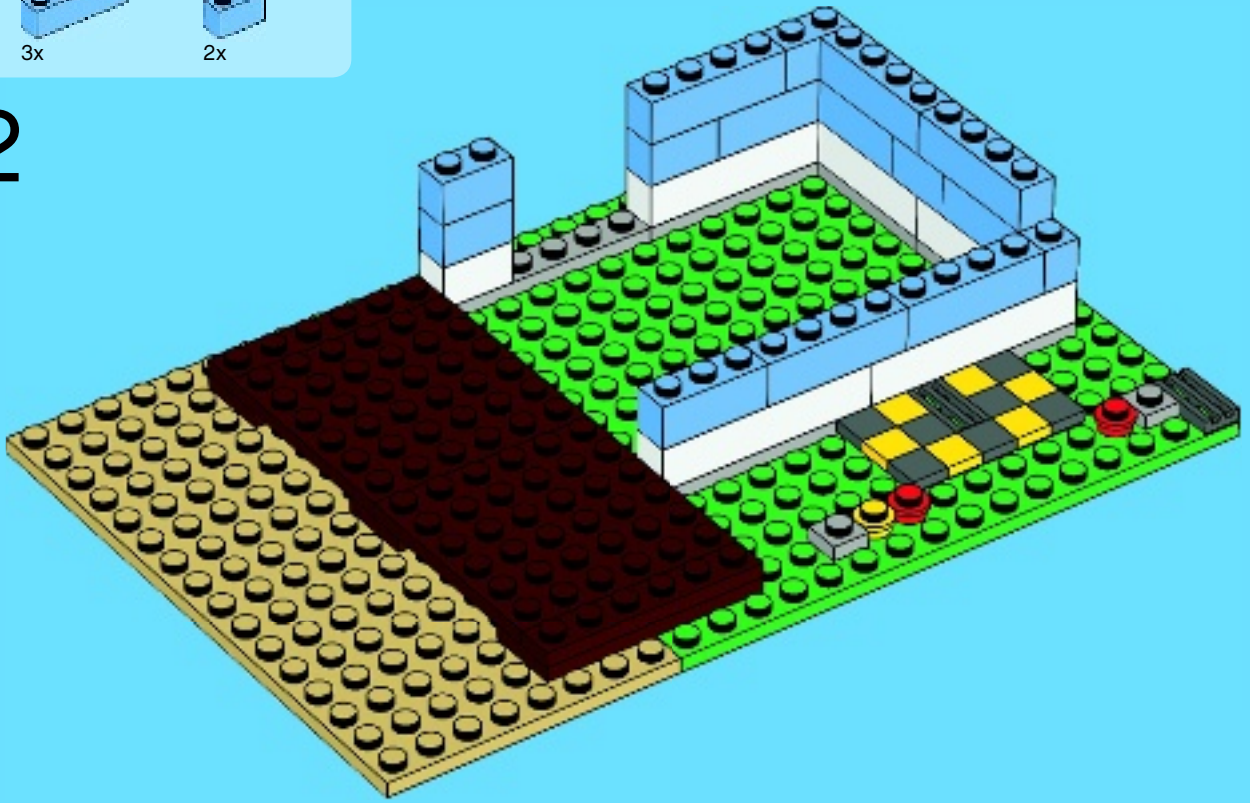

2x



1x



1x



2x



1x

# 13

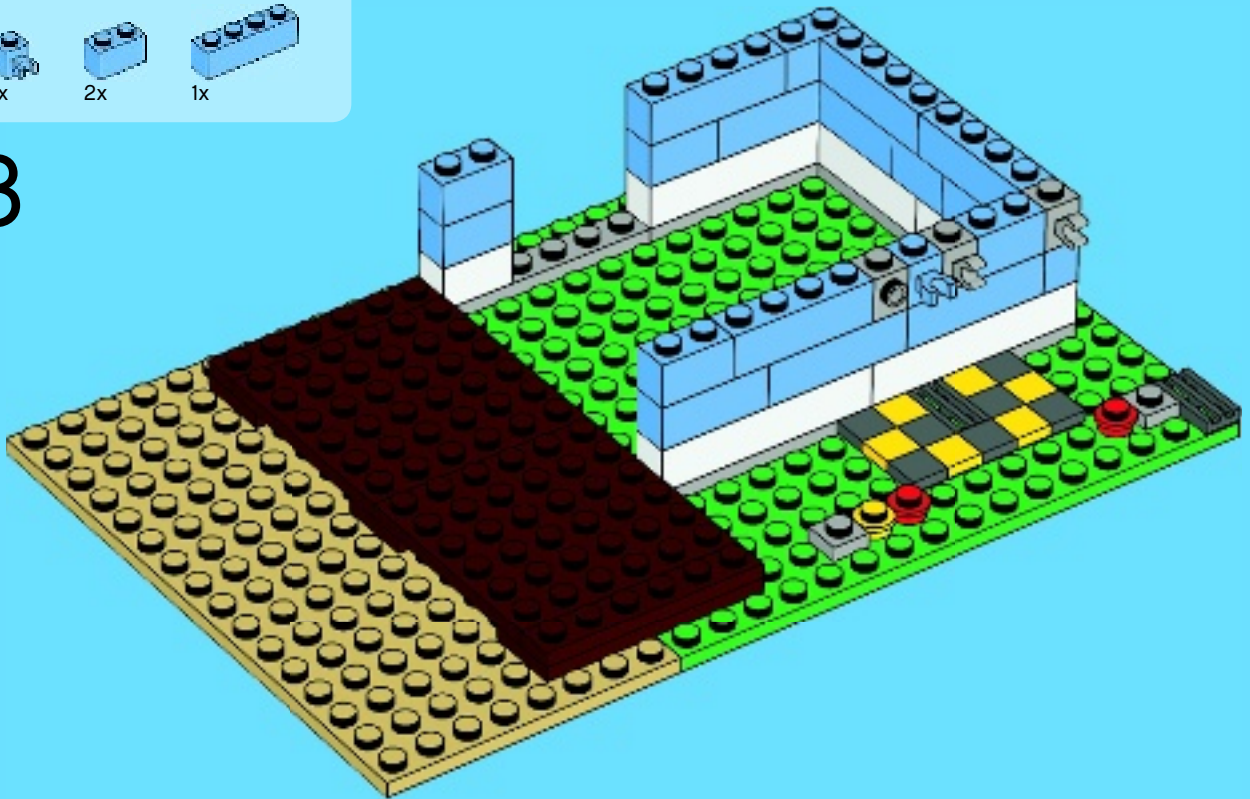





3x



2x



4x

# 14

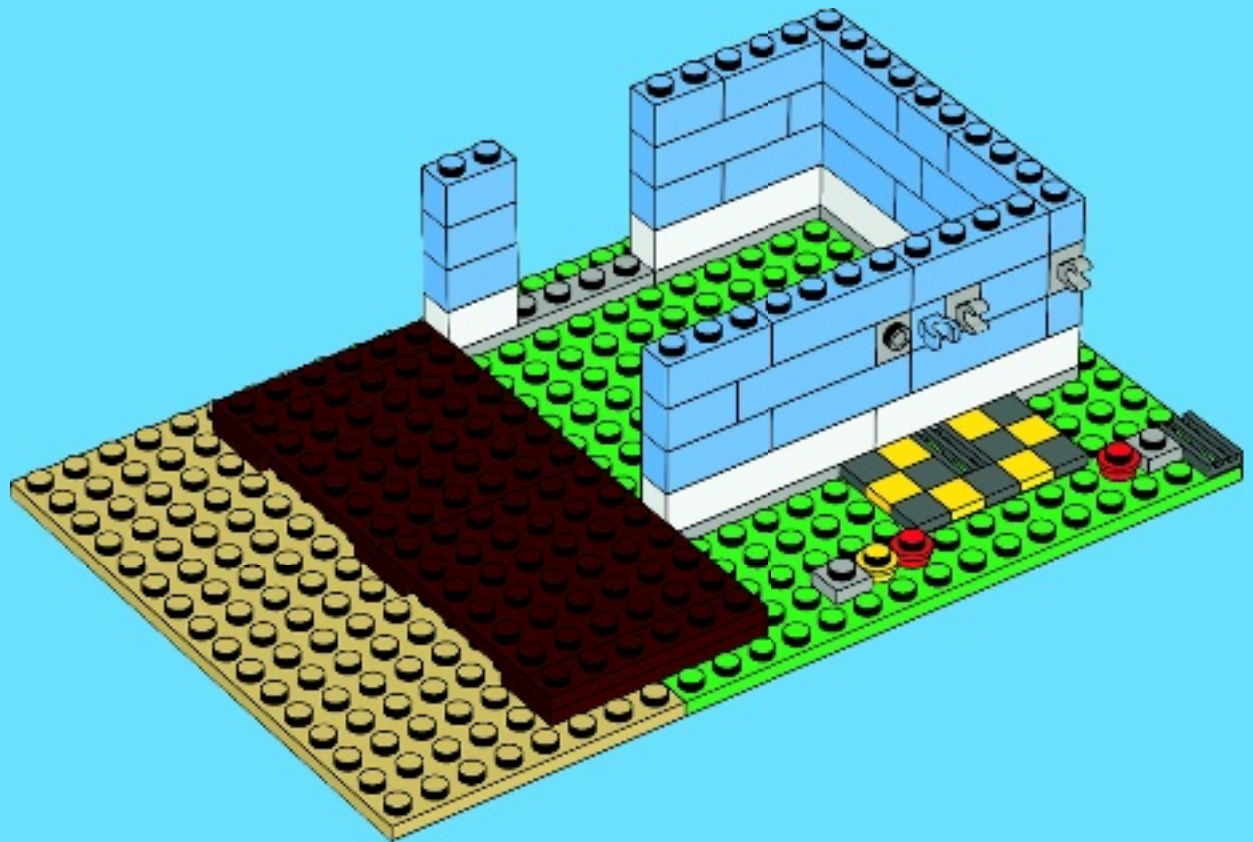

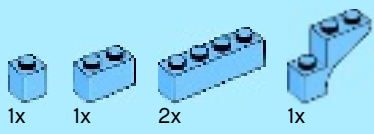

15

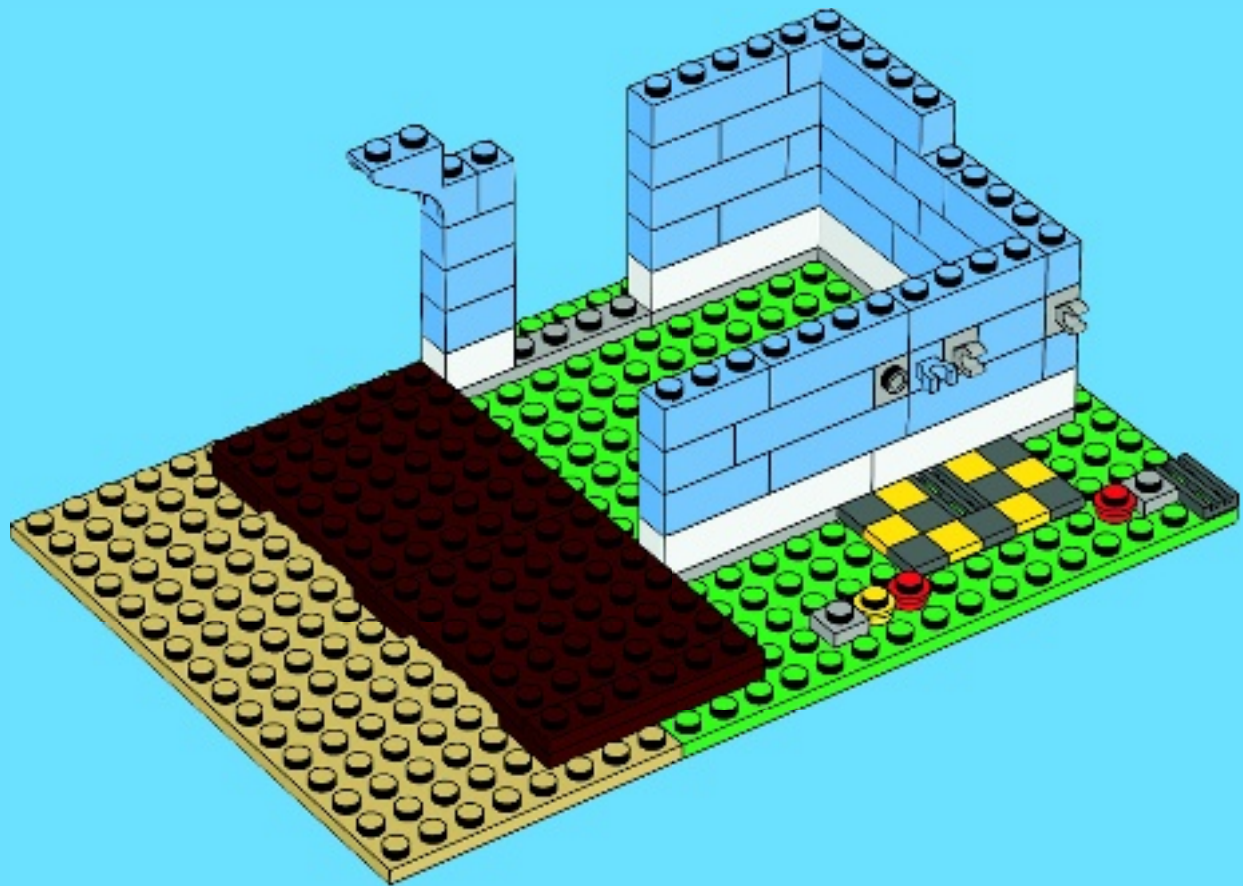





1x



2x

# 16

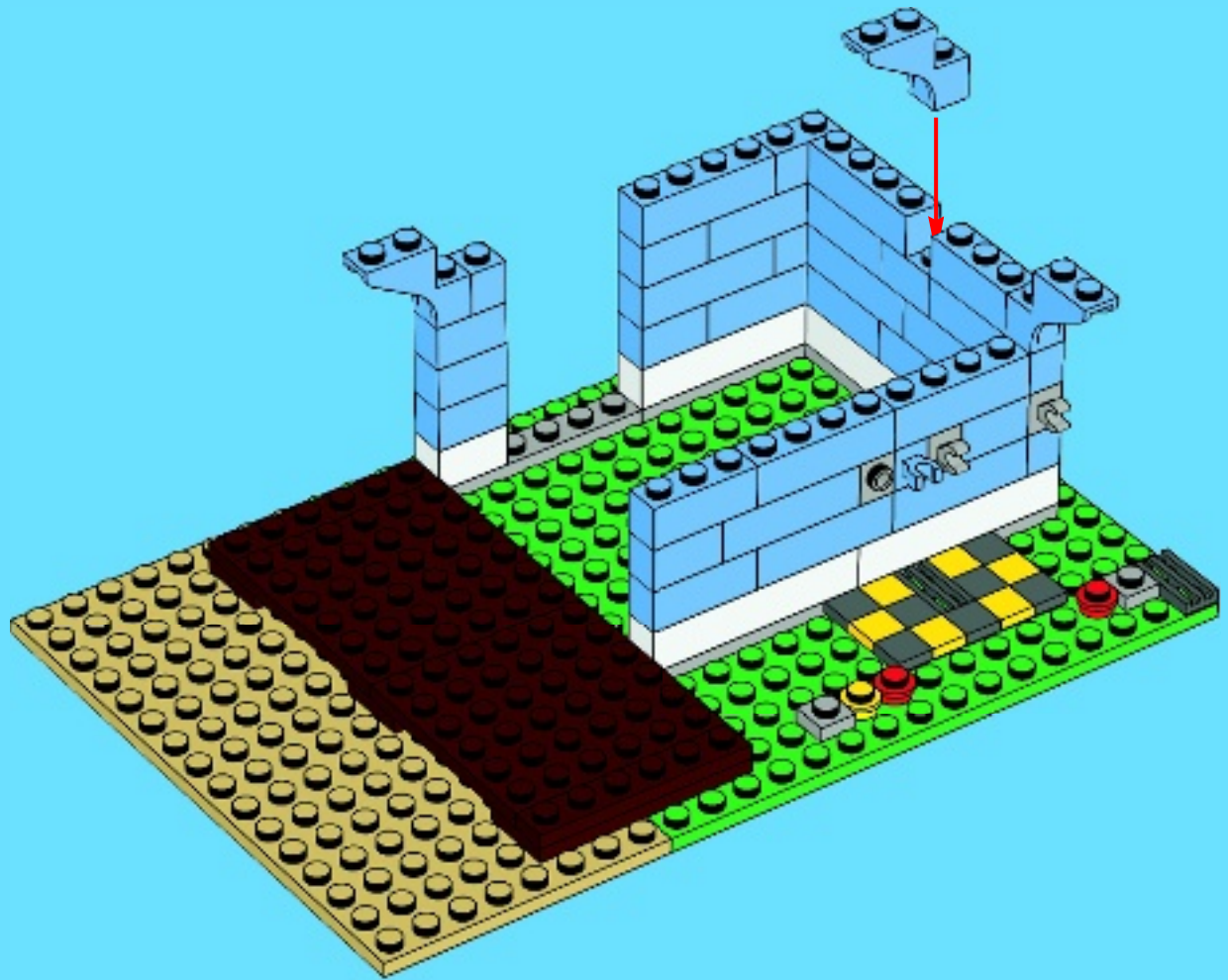



1x



1x



1x



2x



1x

# 17

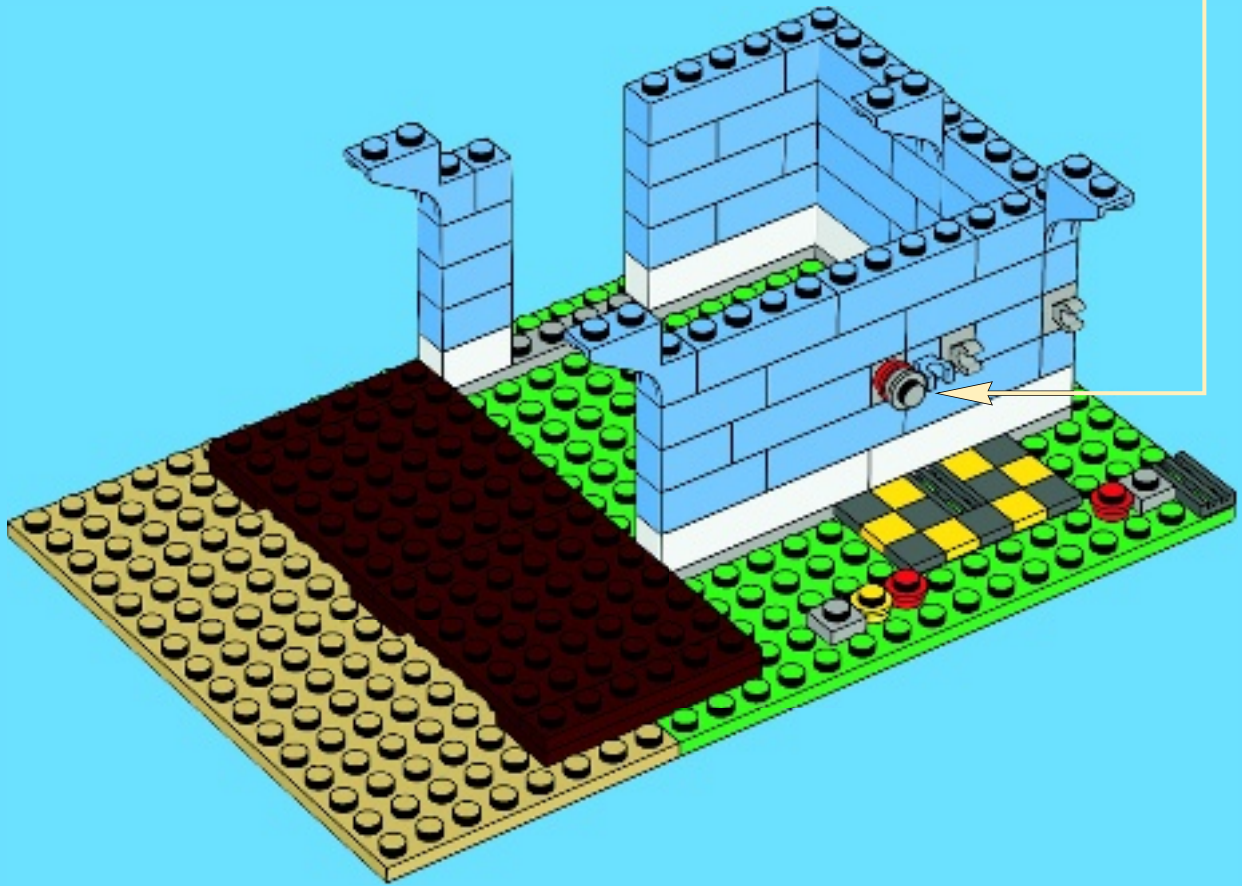
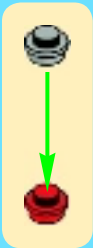



2x



4x



1x

# 18

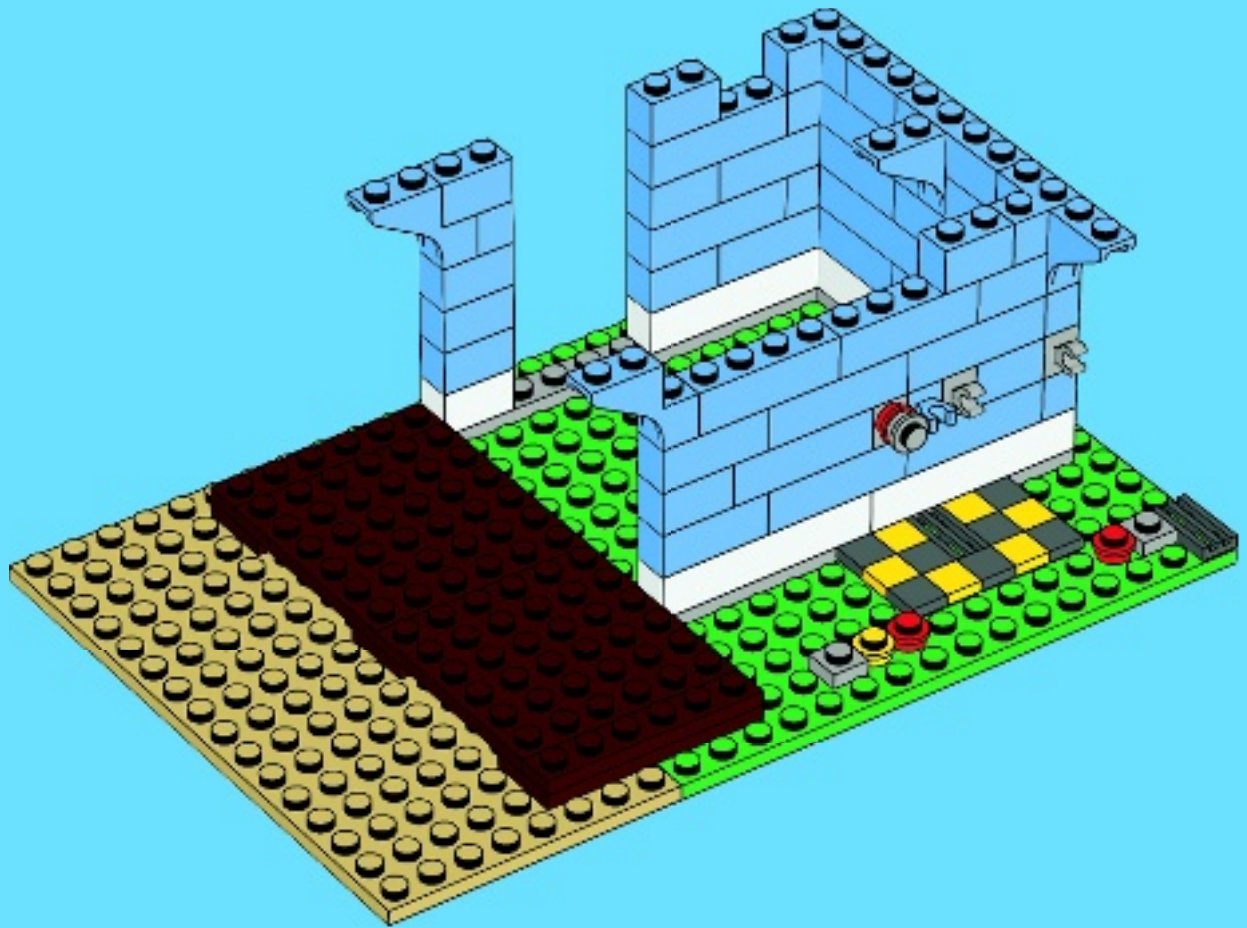

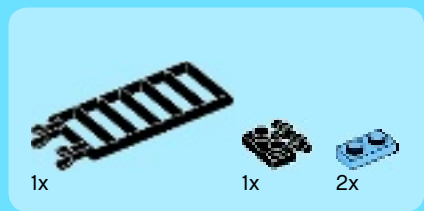

19

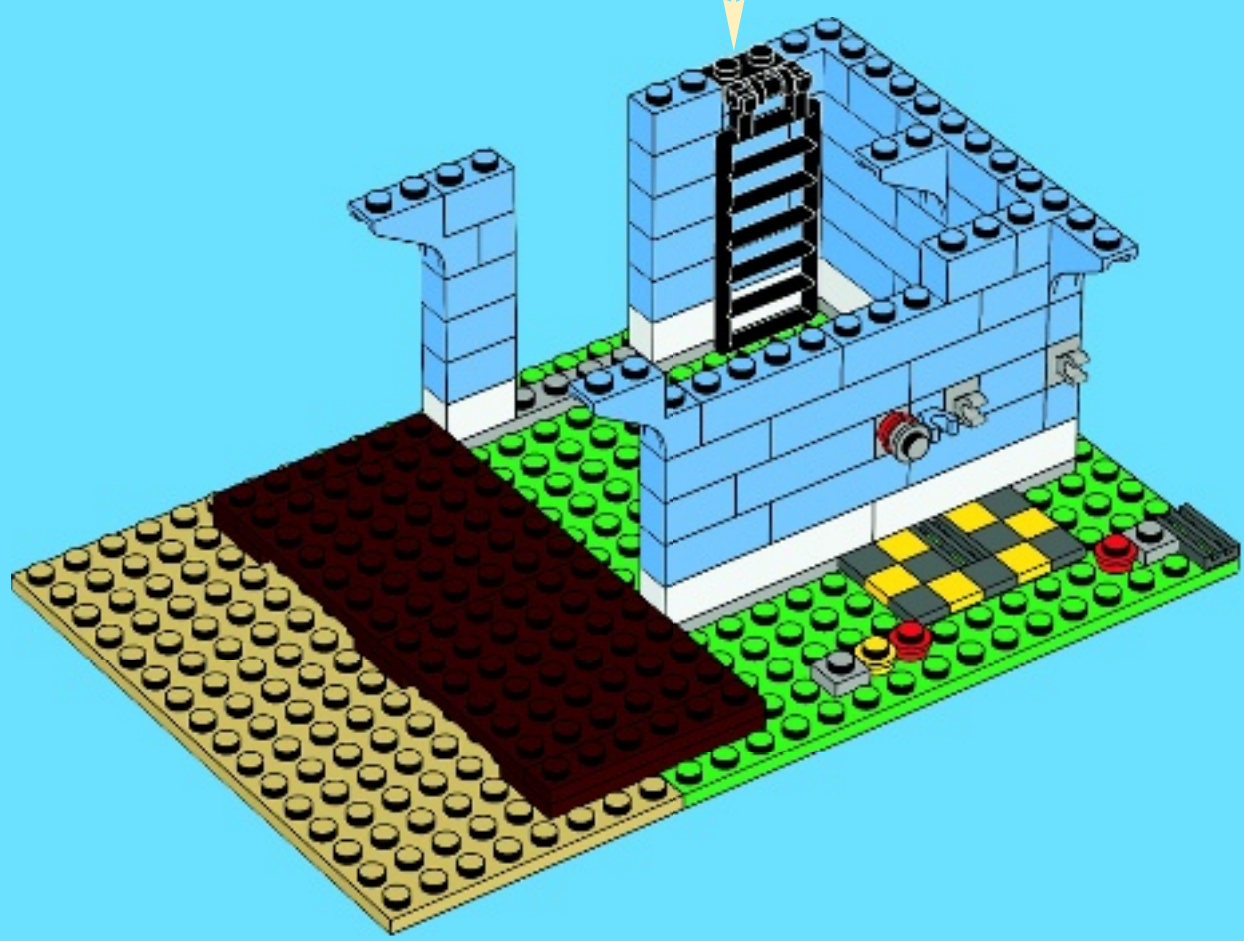
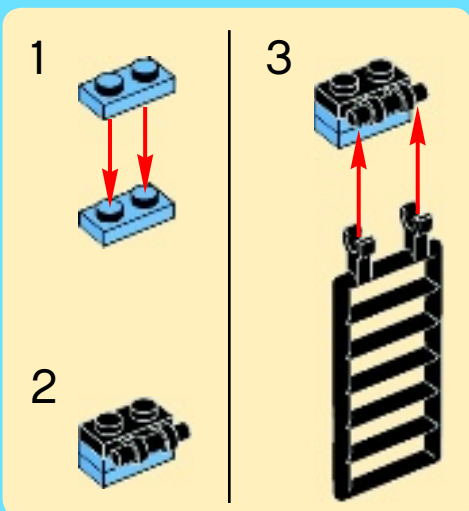



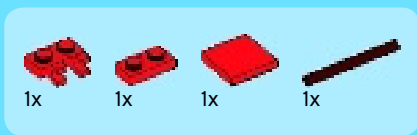

20

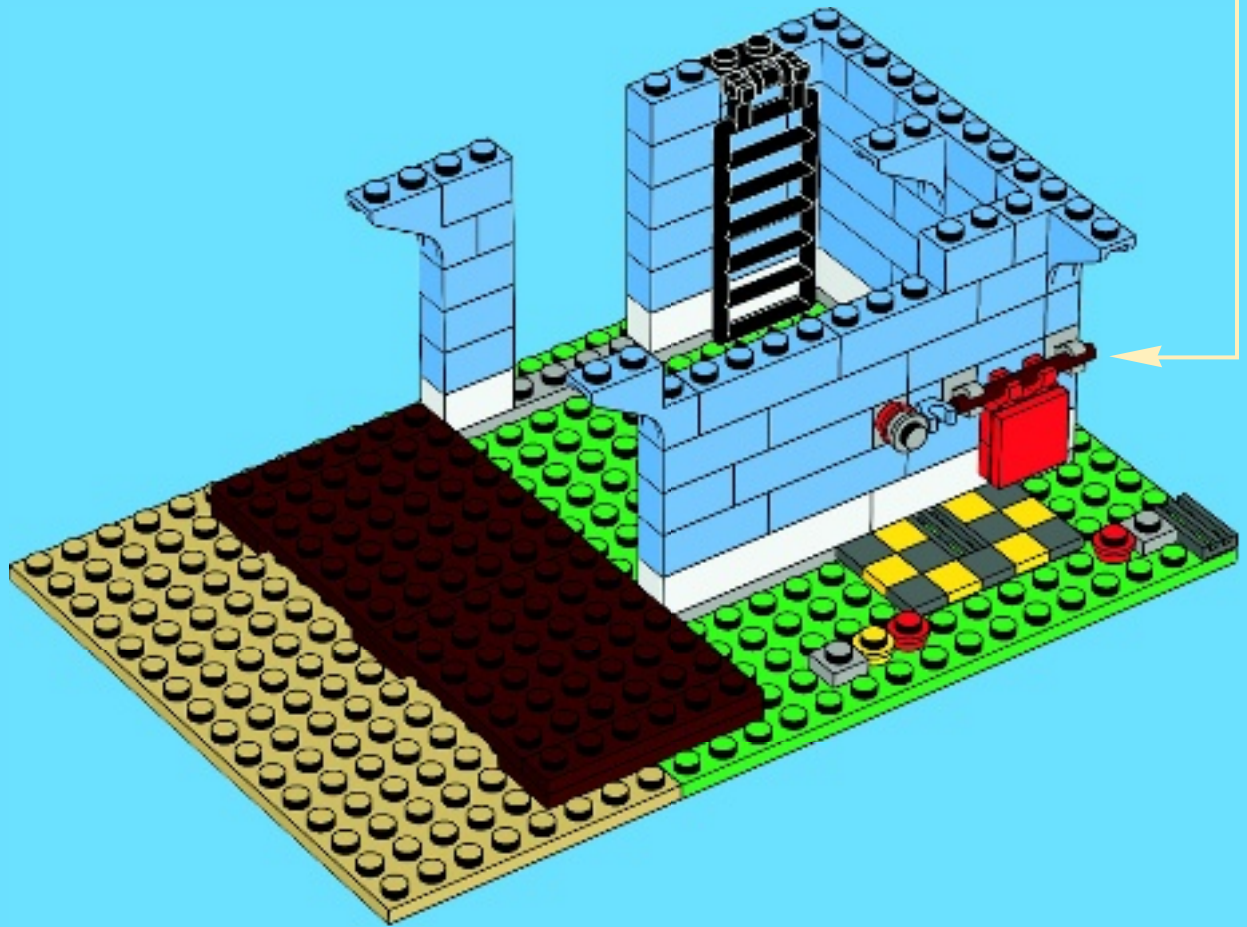
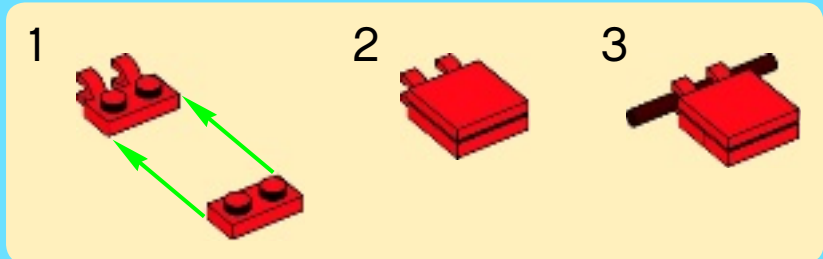



1x



1x

# 21

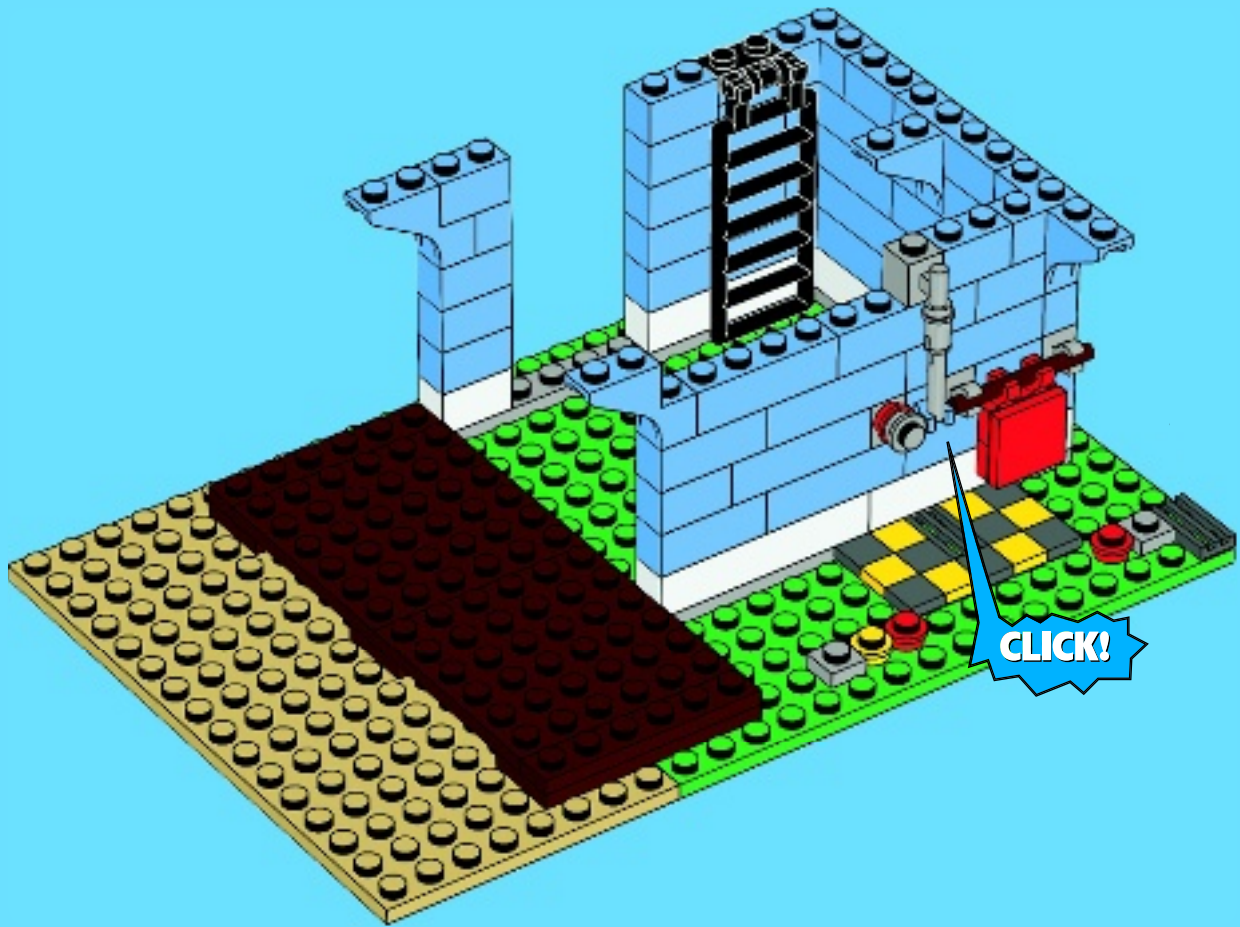

**CLICK!**

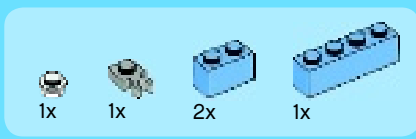

22

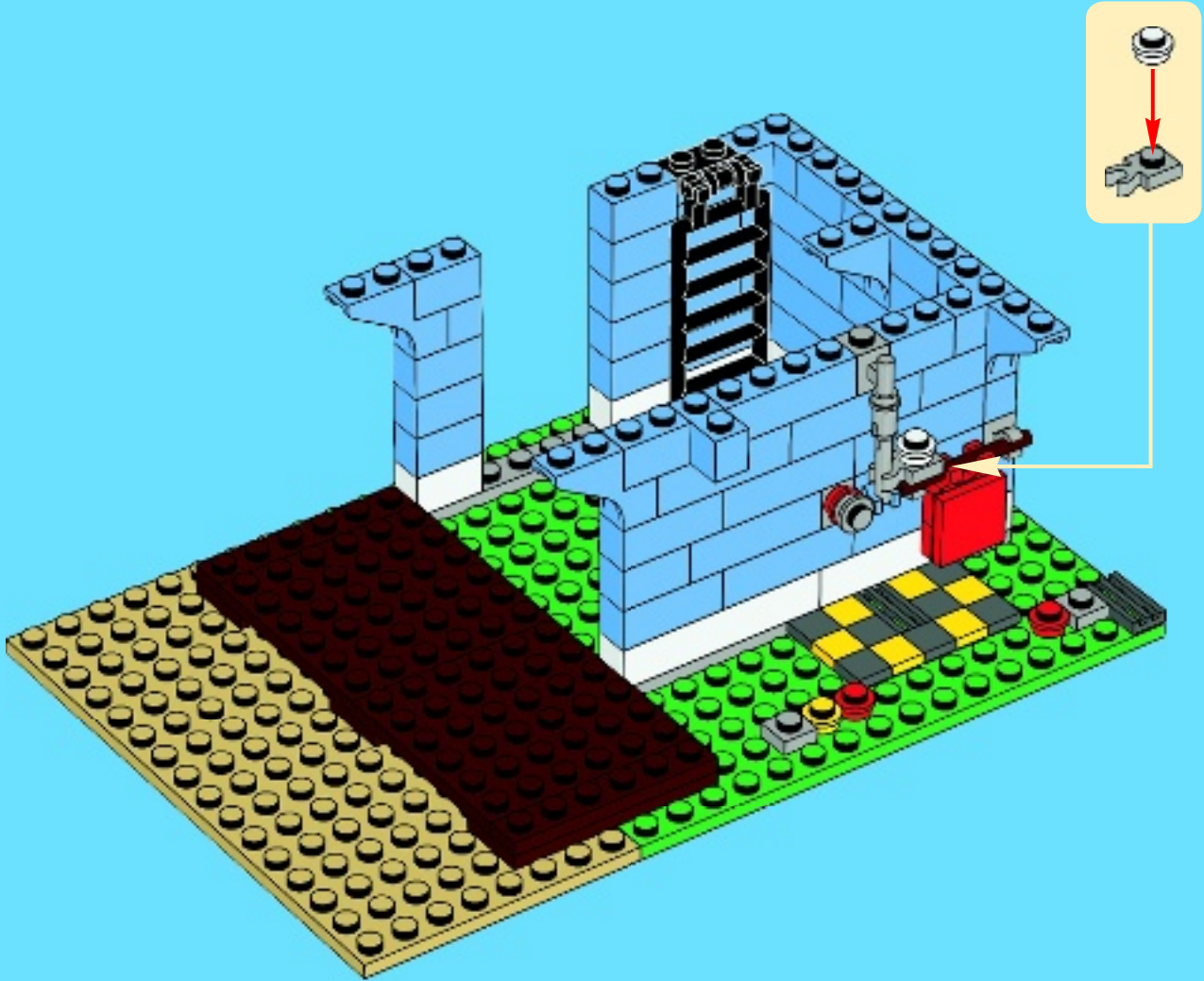



1x



1x

# 23

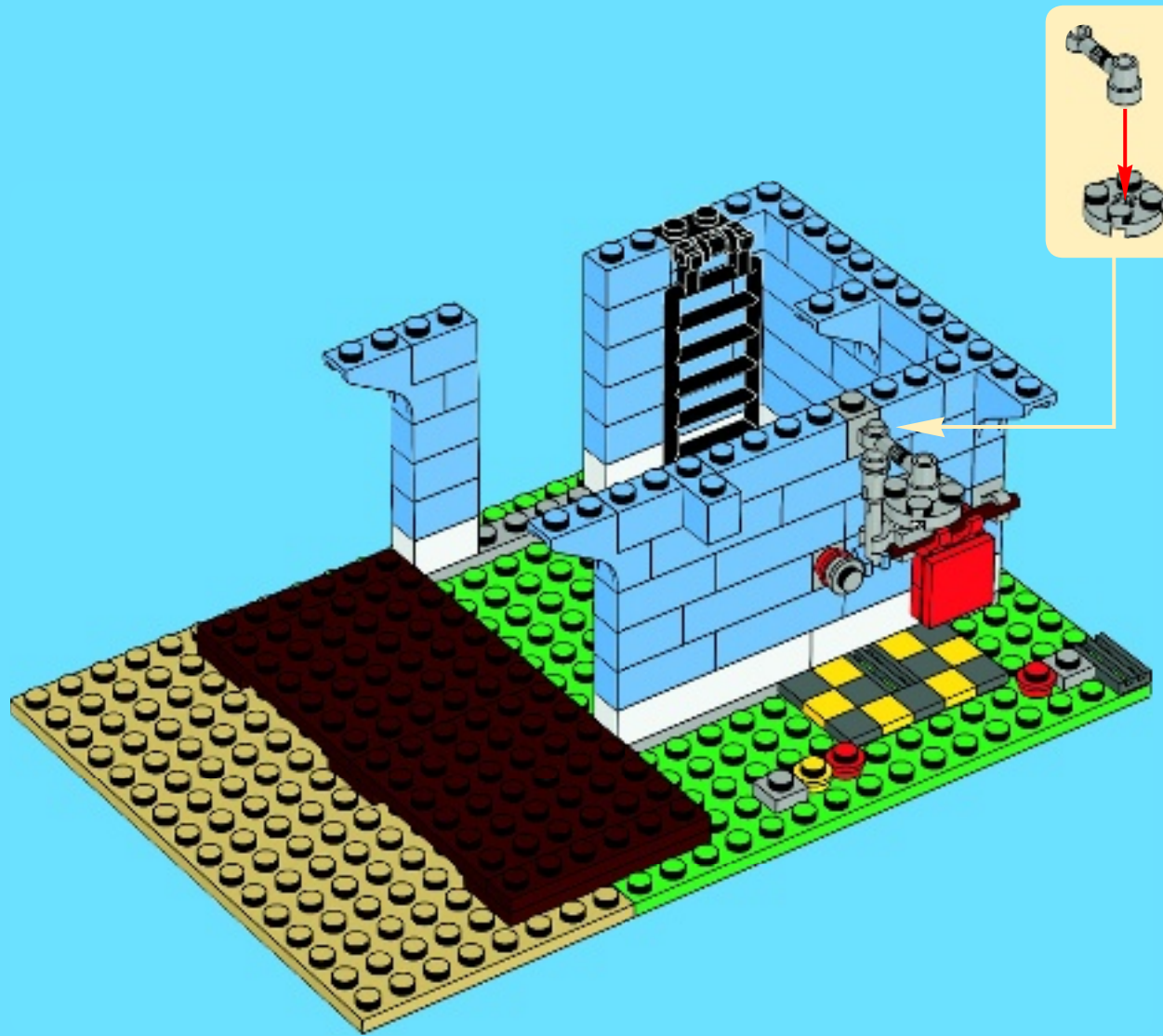



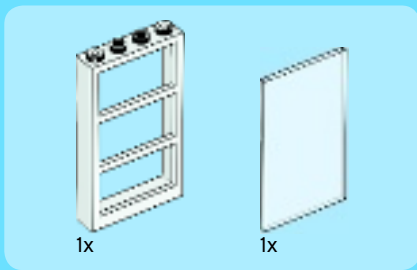

24

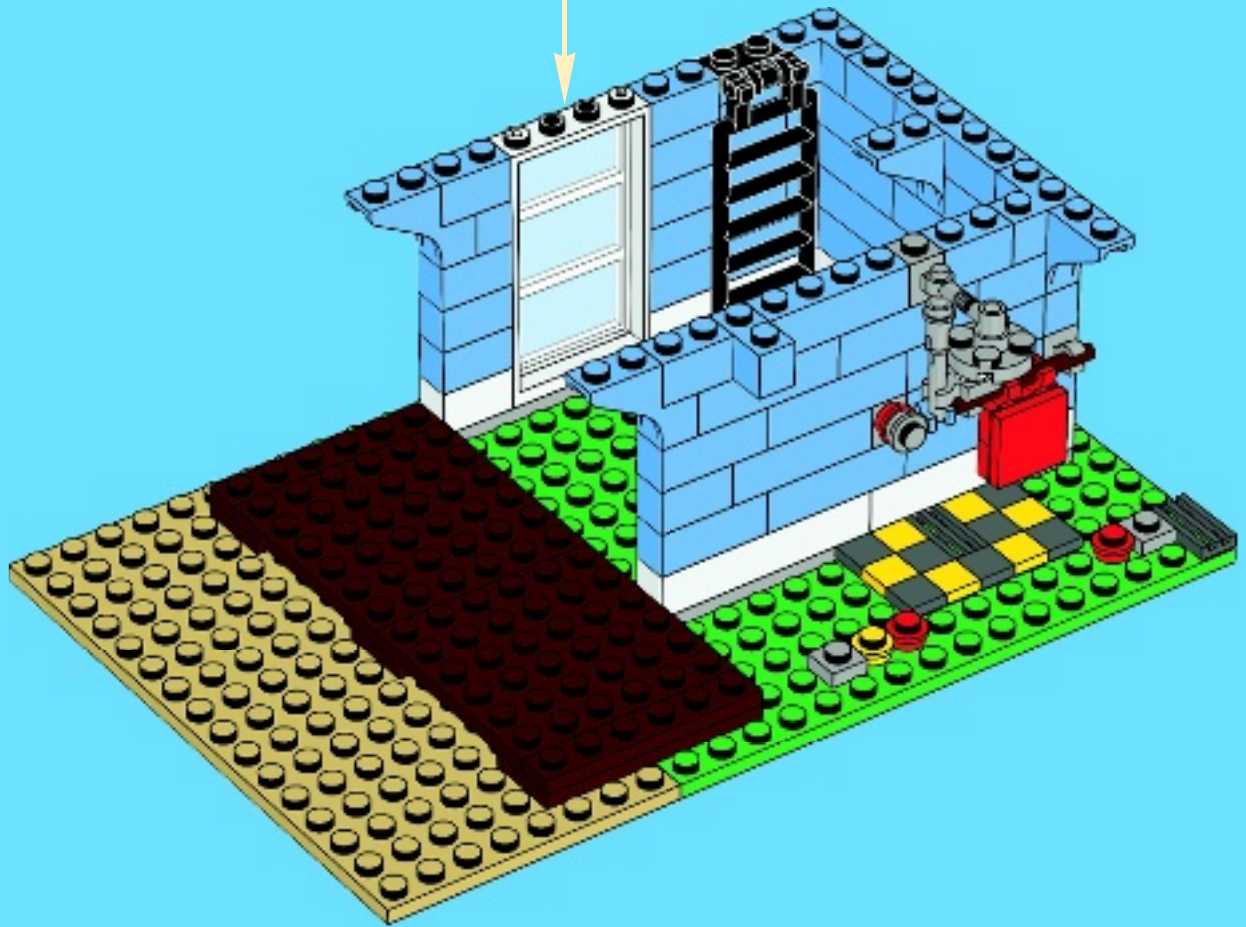
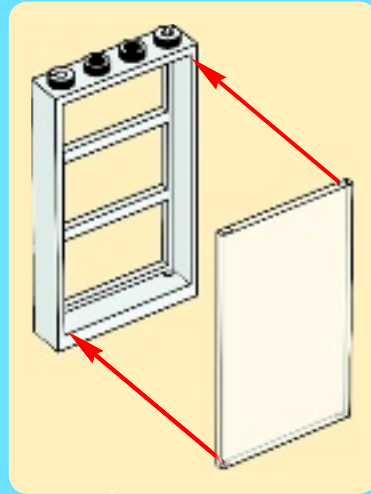

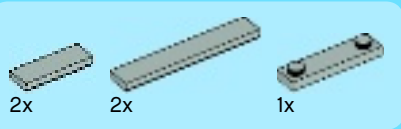

# 25

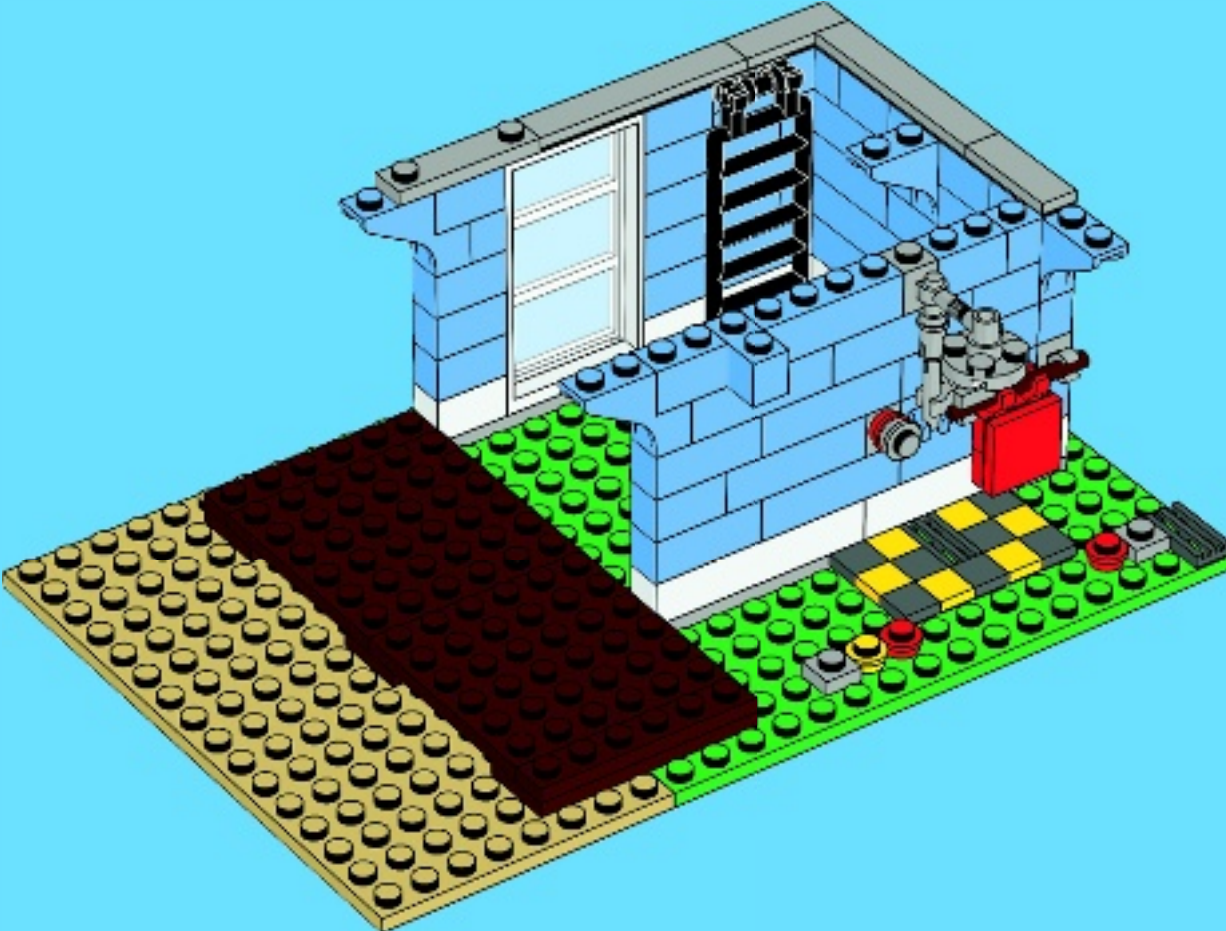

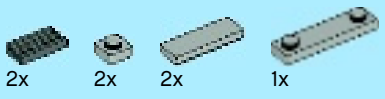

# 26

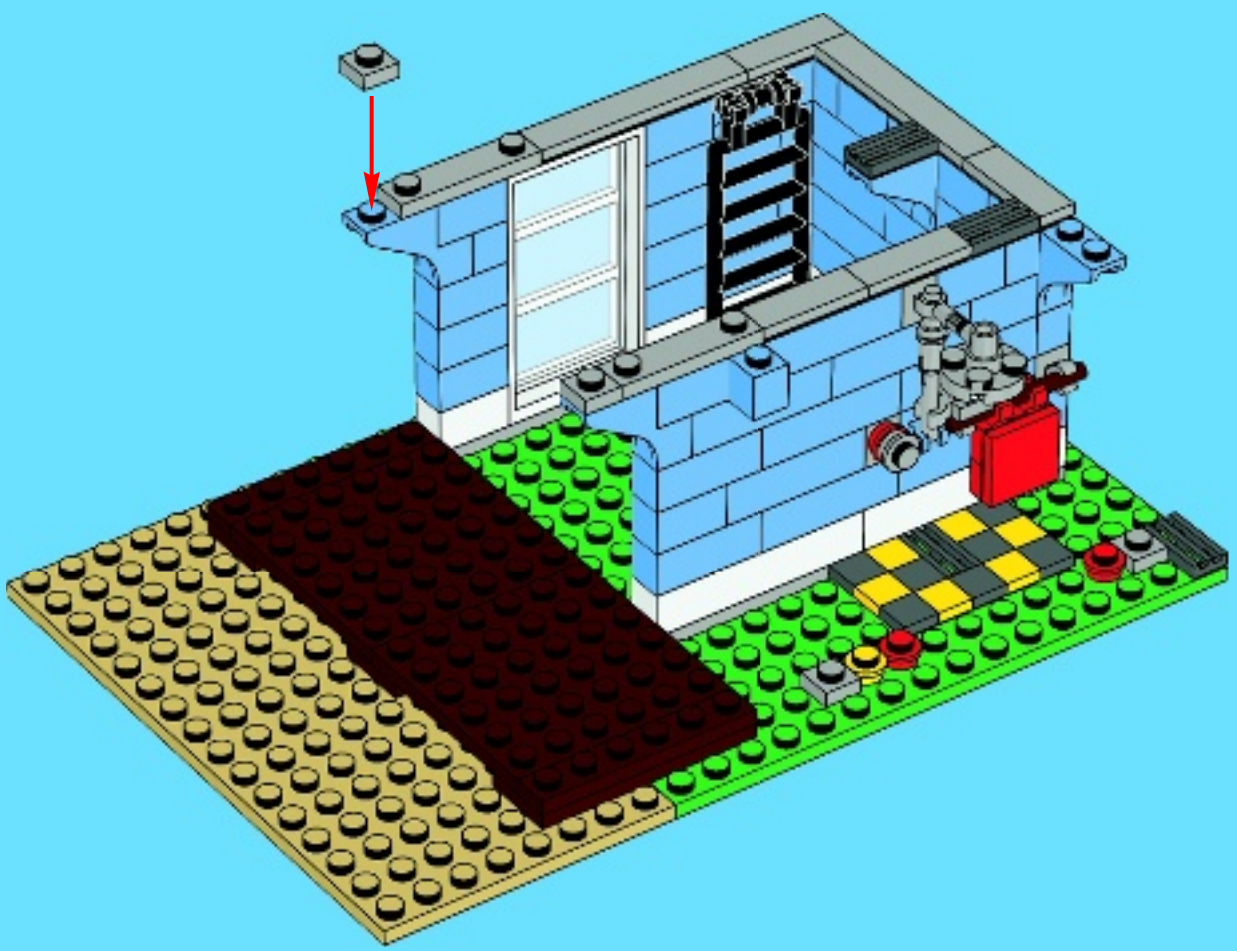



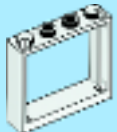

2x



2x

# 27

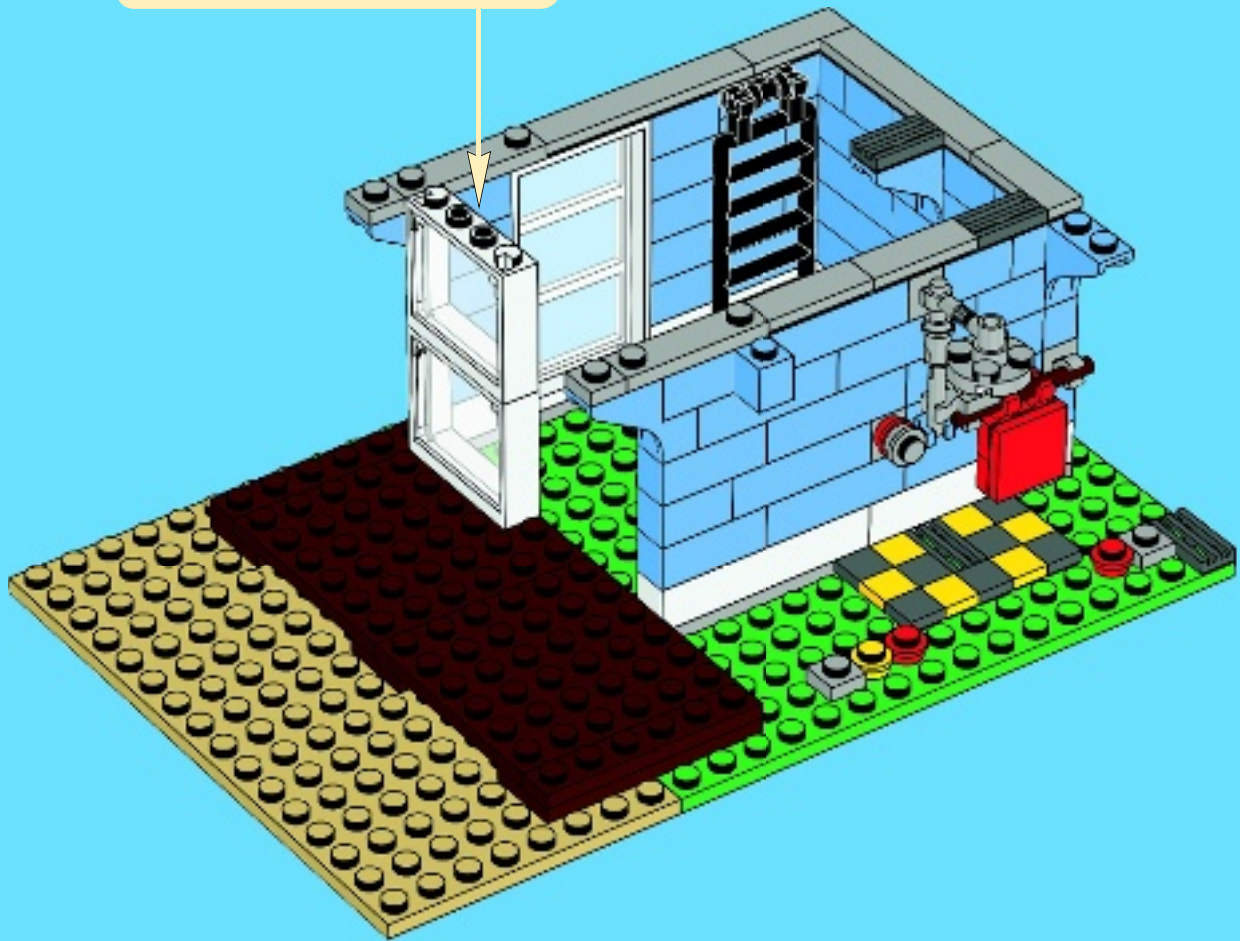
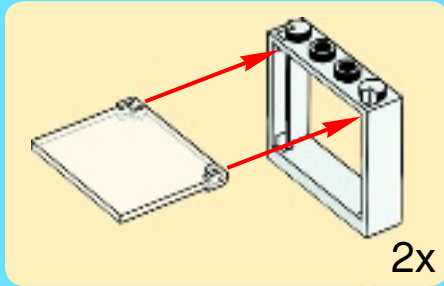

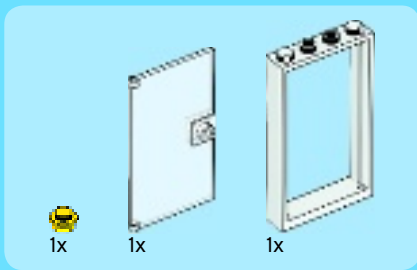

28

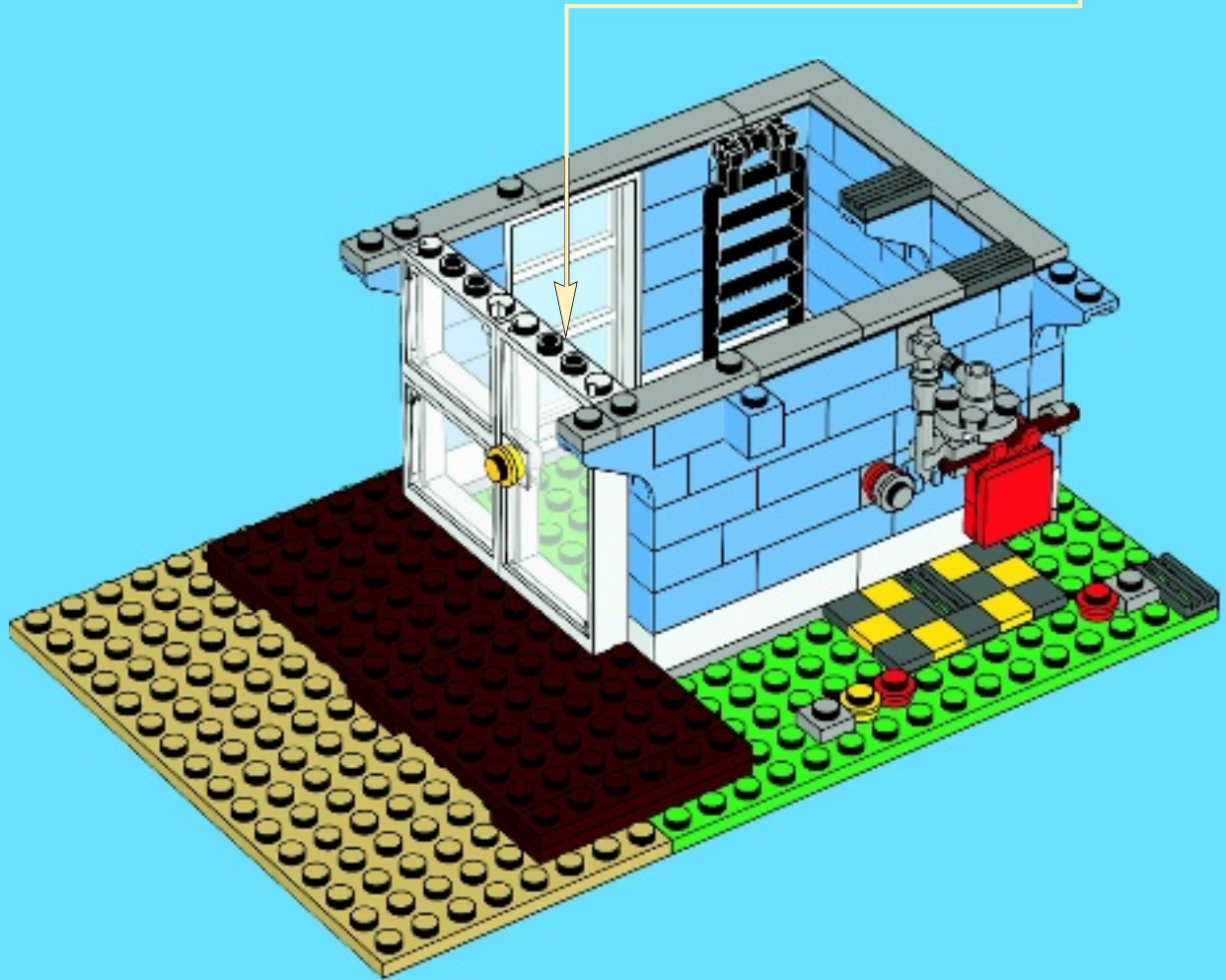
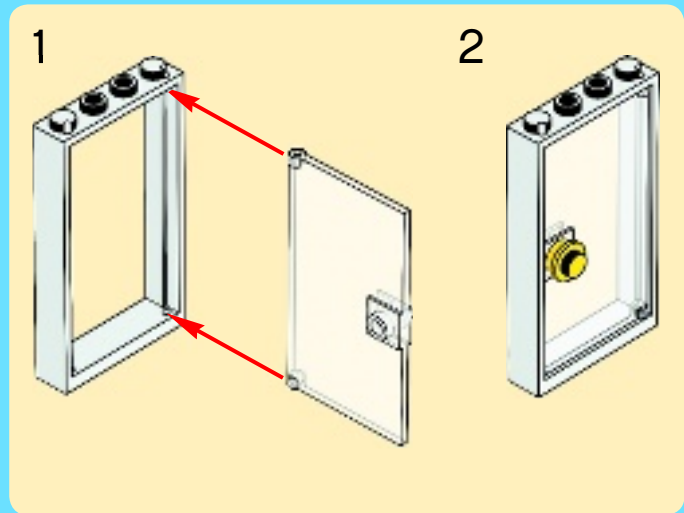



2x



10x

# 29

1



2



2x

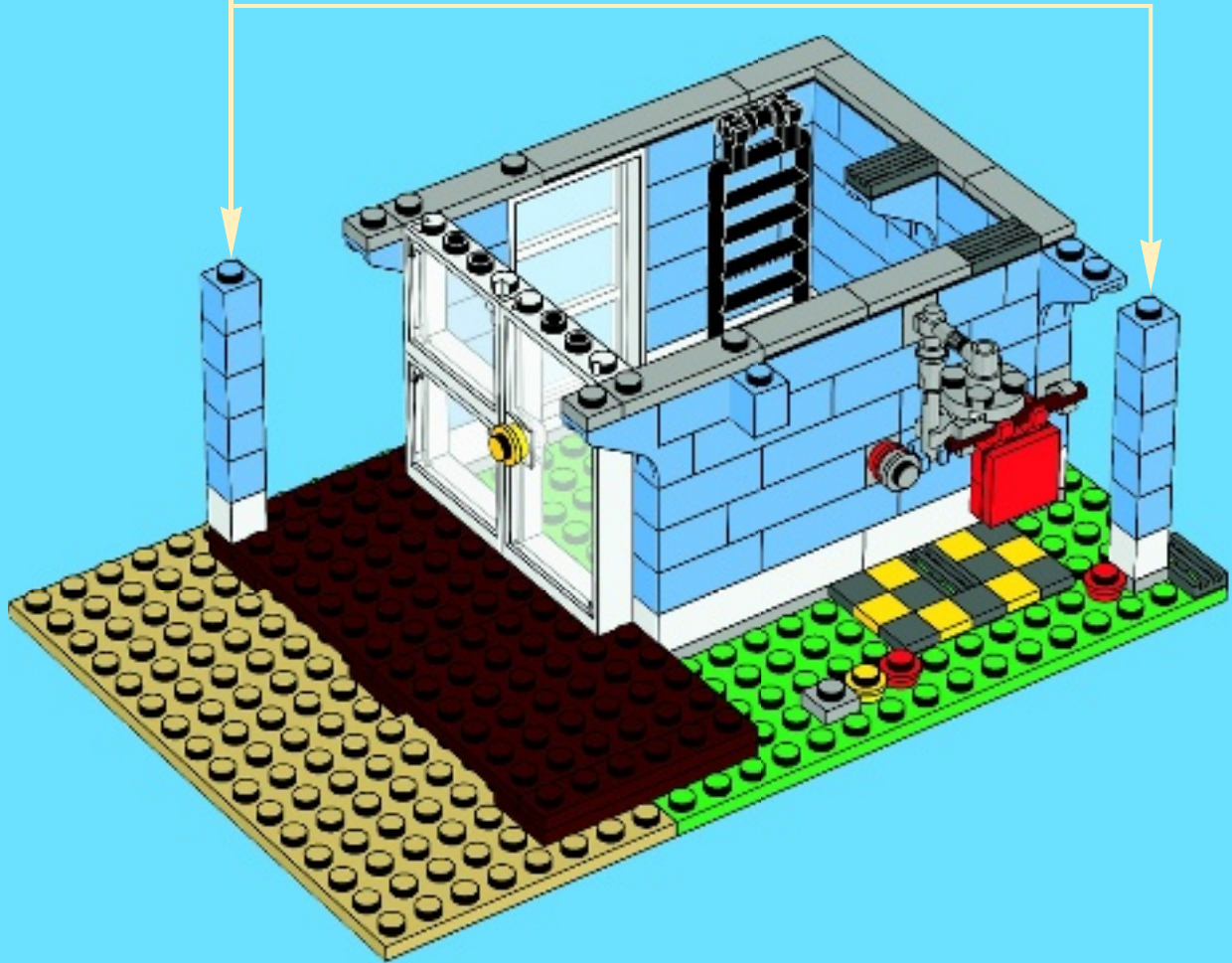





2x



8x



2x

# 30

1



2



3



2x

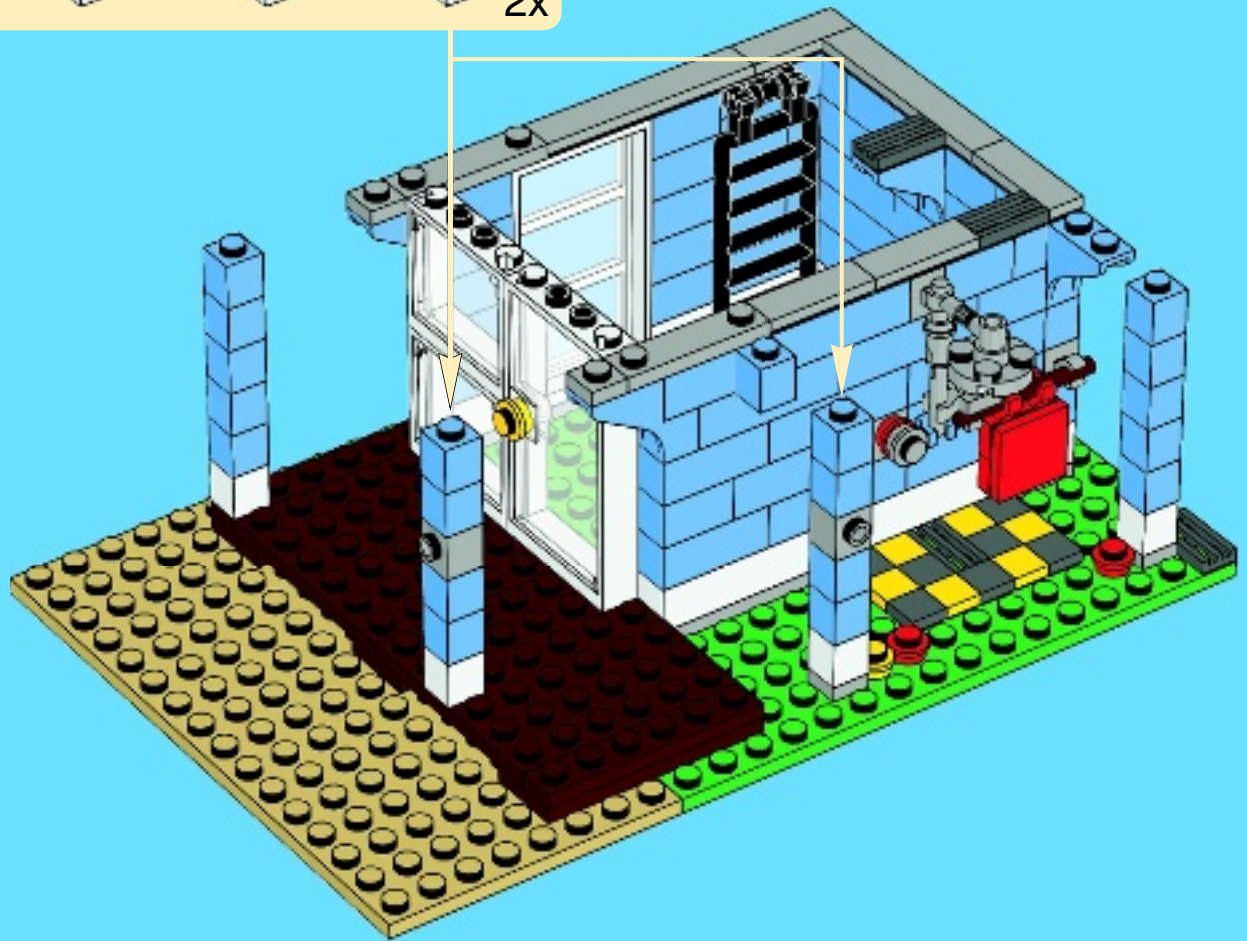

31

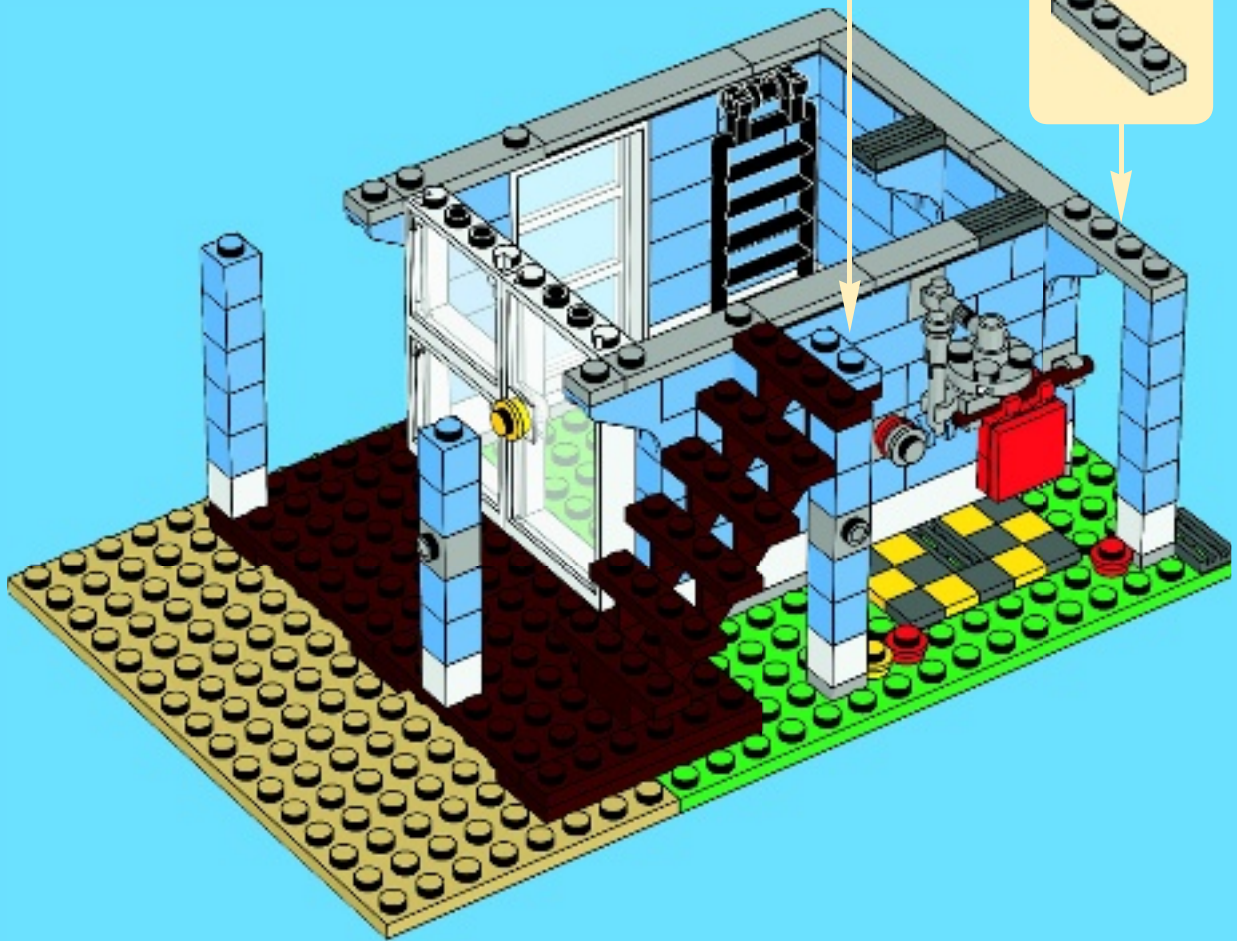
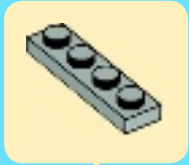
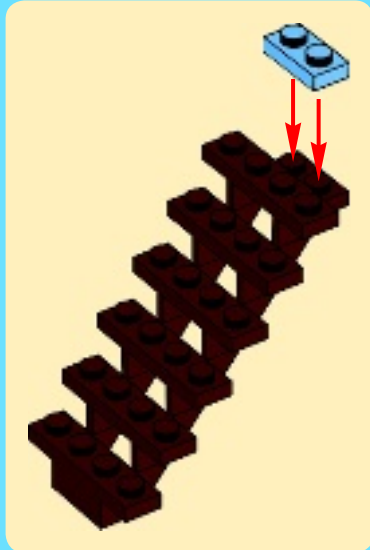
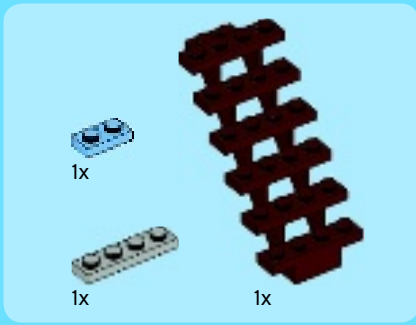

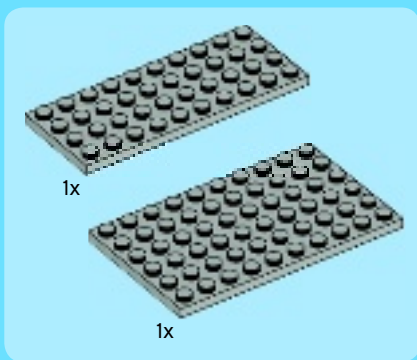

32

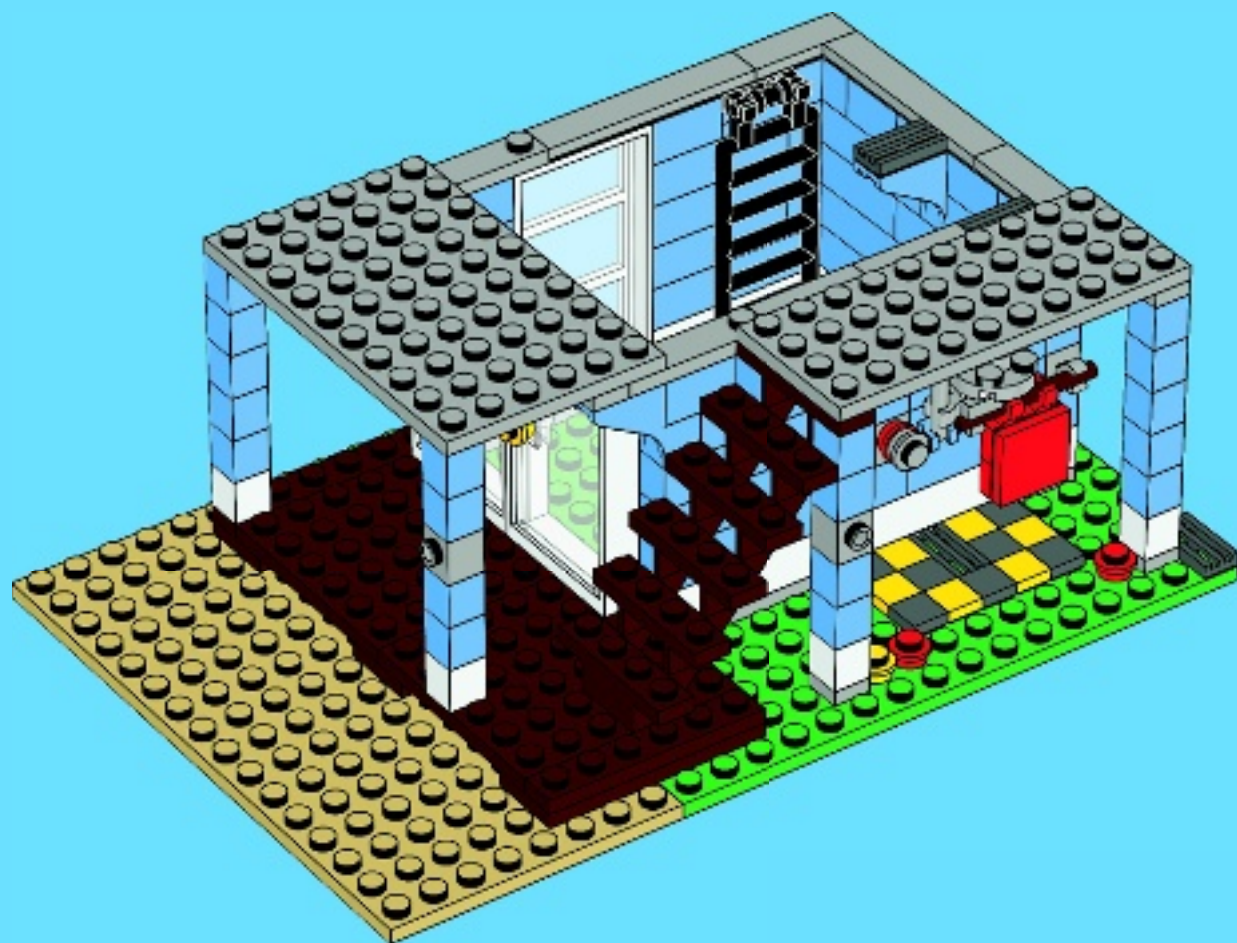



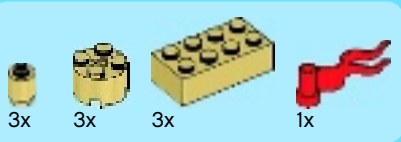

33

1

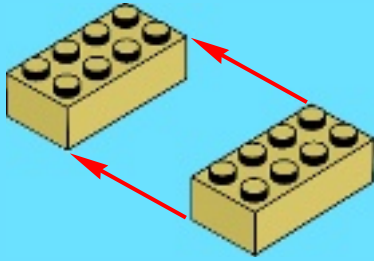

2



3

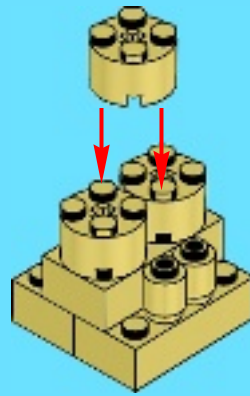

4



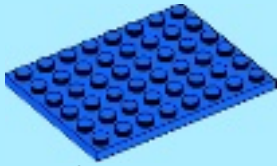

2x

# 34





2x

# 35





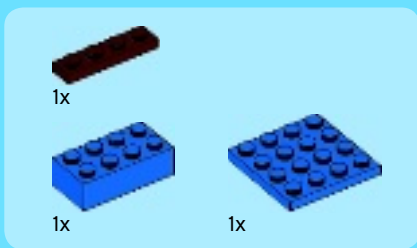

36





4x



4x

# 37

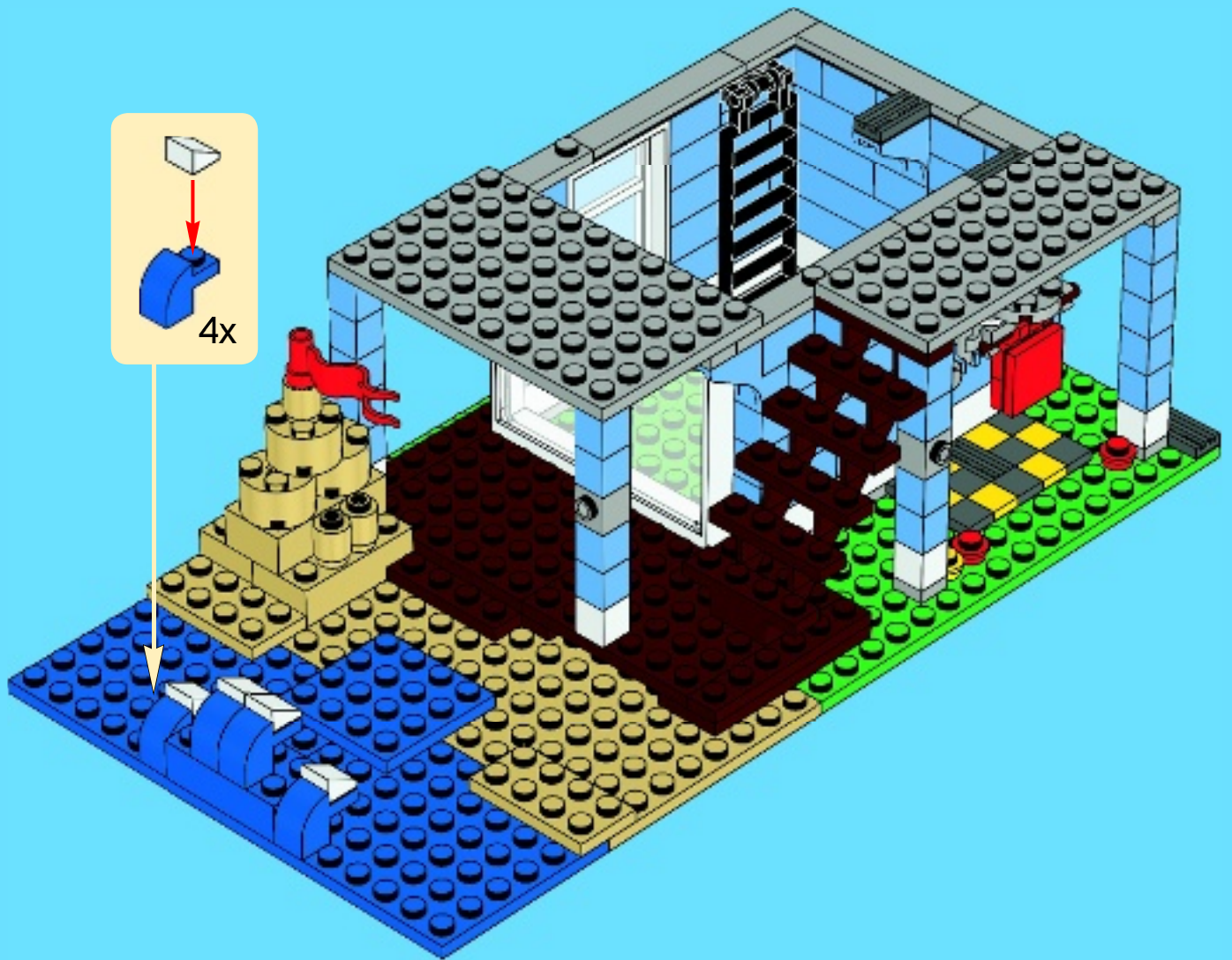
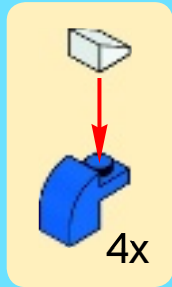



2x



4x

# 38

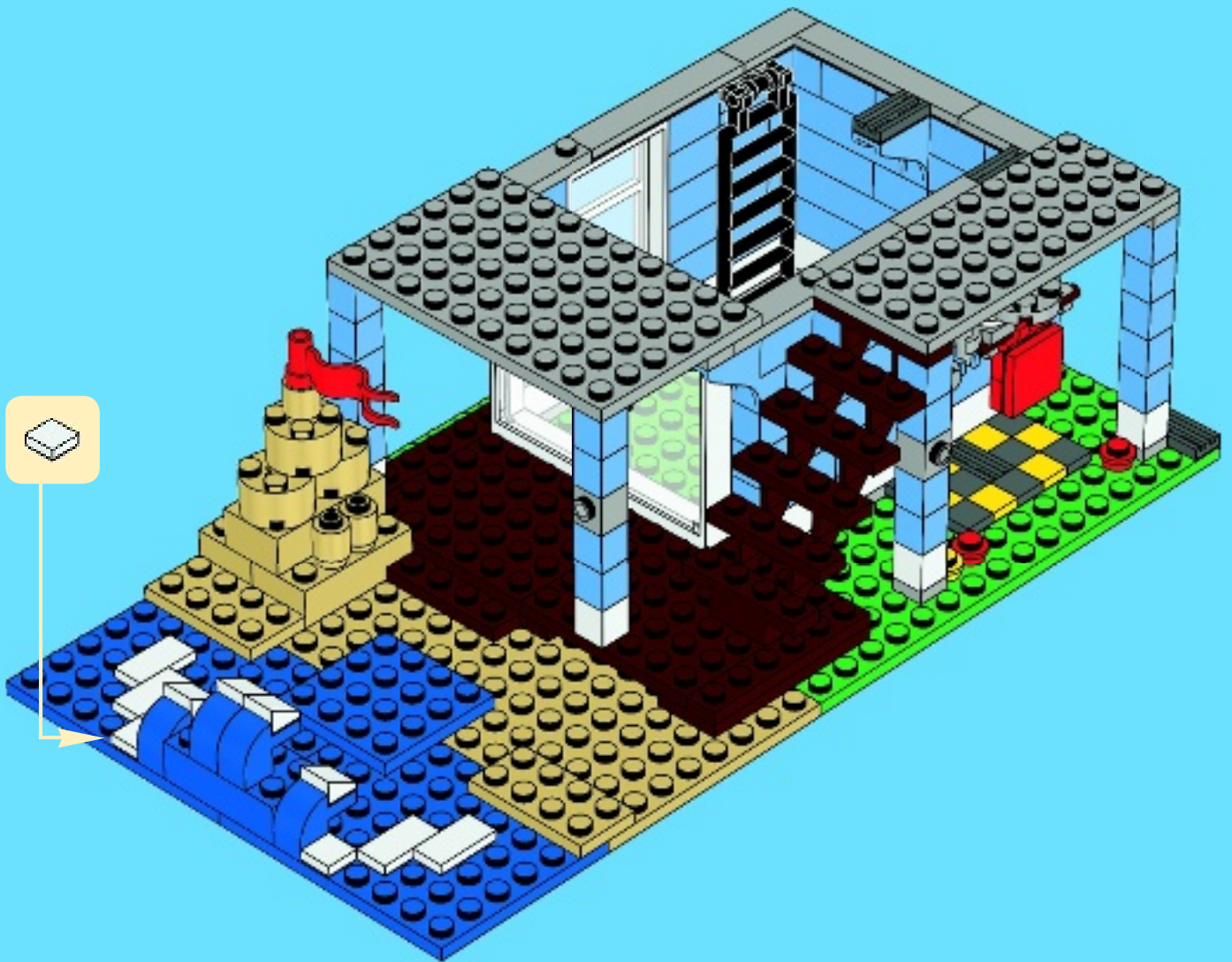





2x



2x

# 39

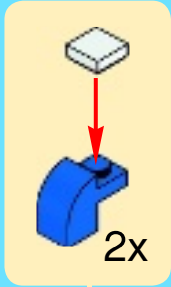



4x

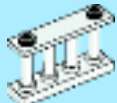

2x



2x

# 40

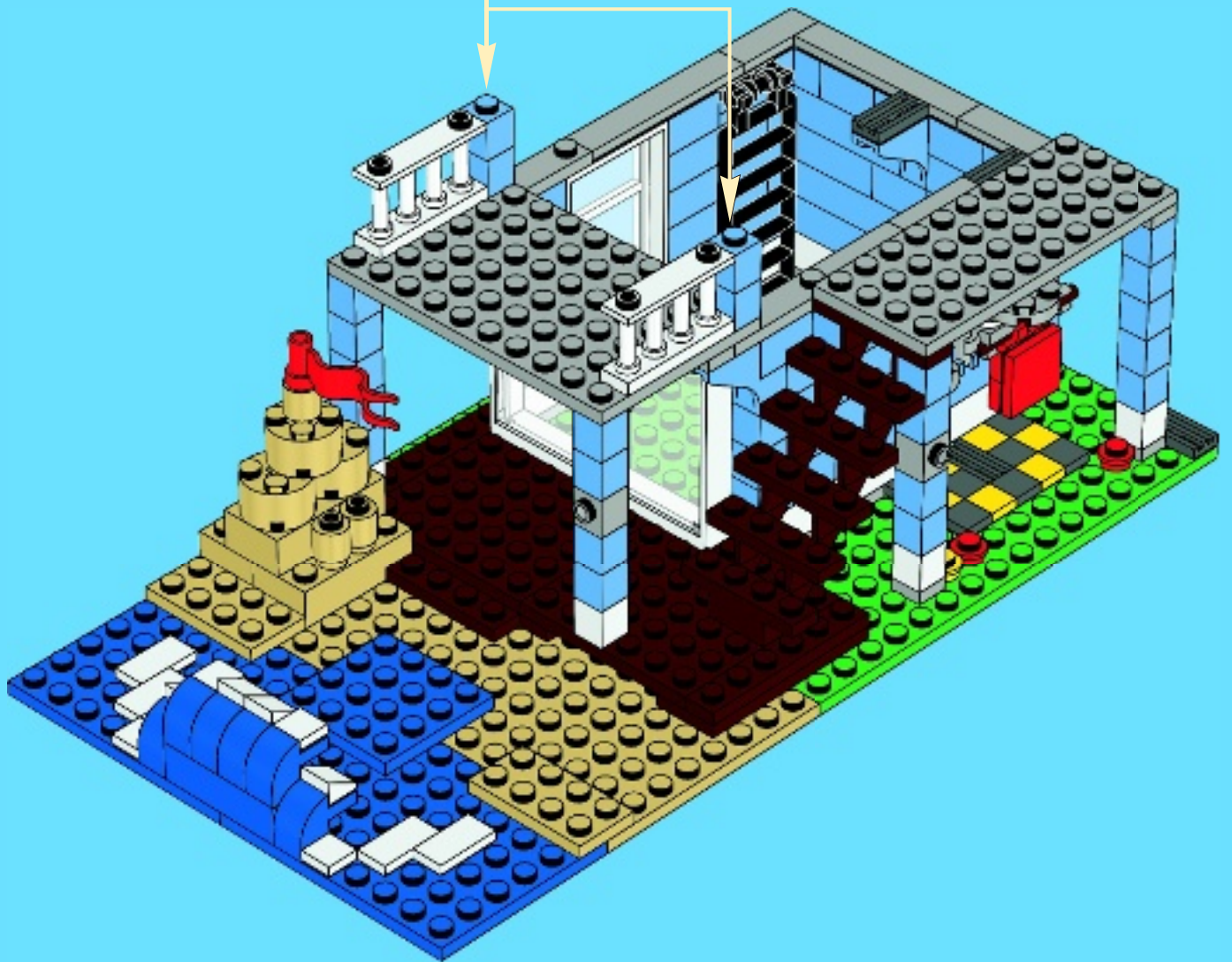



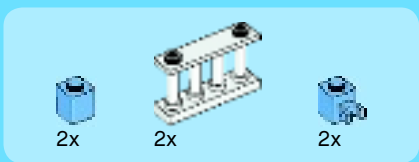

41

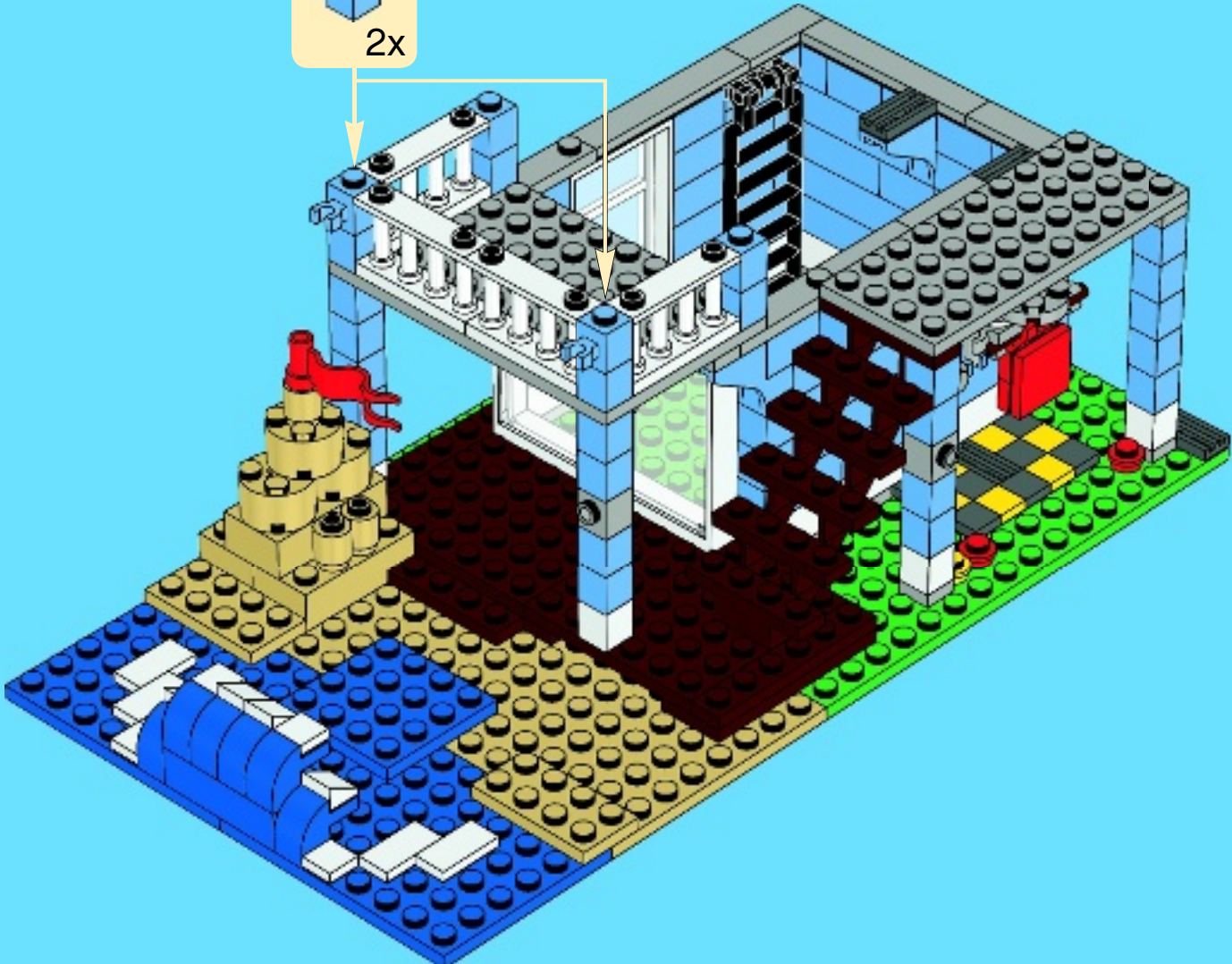
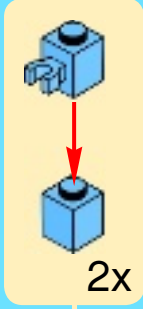





2x



1x



4x

# 42





2x



2x

# 43

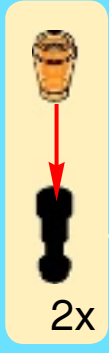





2x

# 44

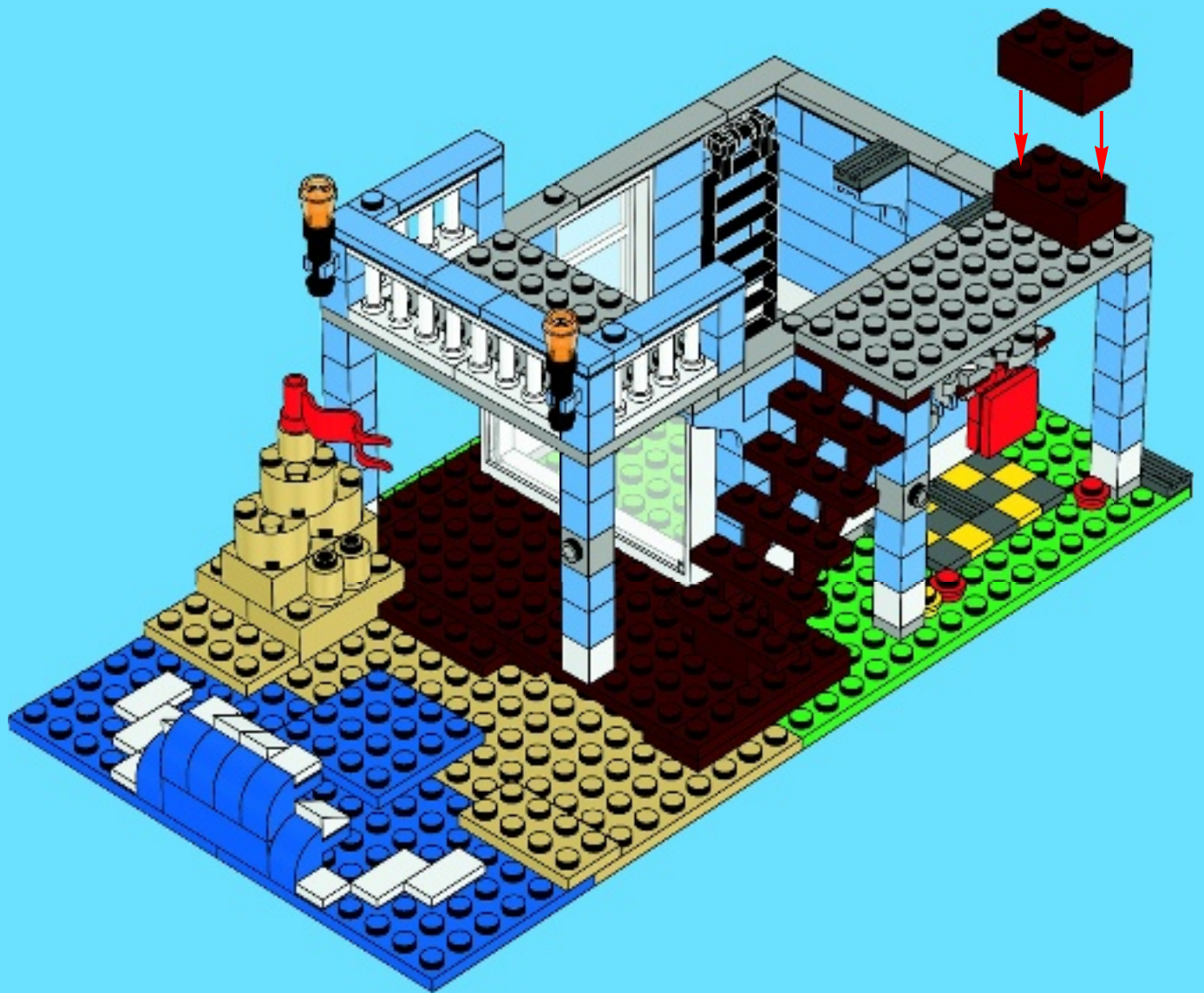





4x



2x

# 45



2x





1x



1x



2x

# 46







1x



1x



2x

# 47

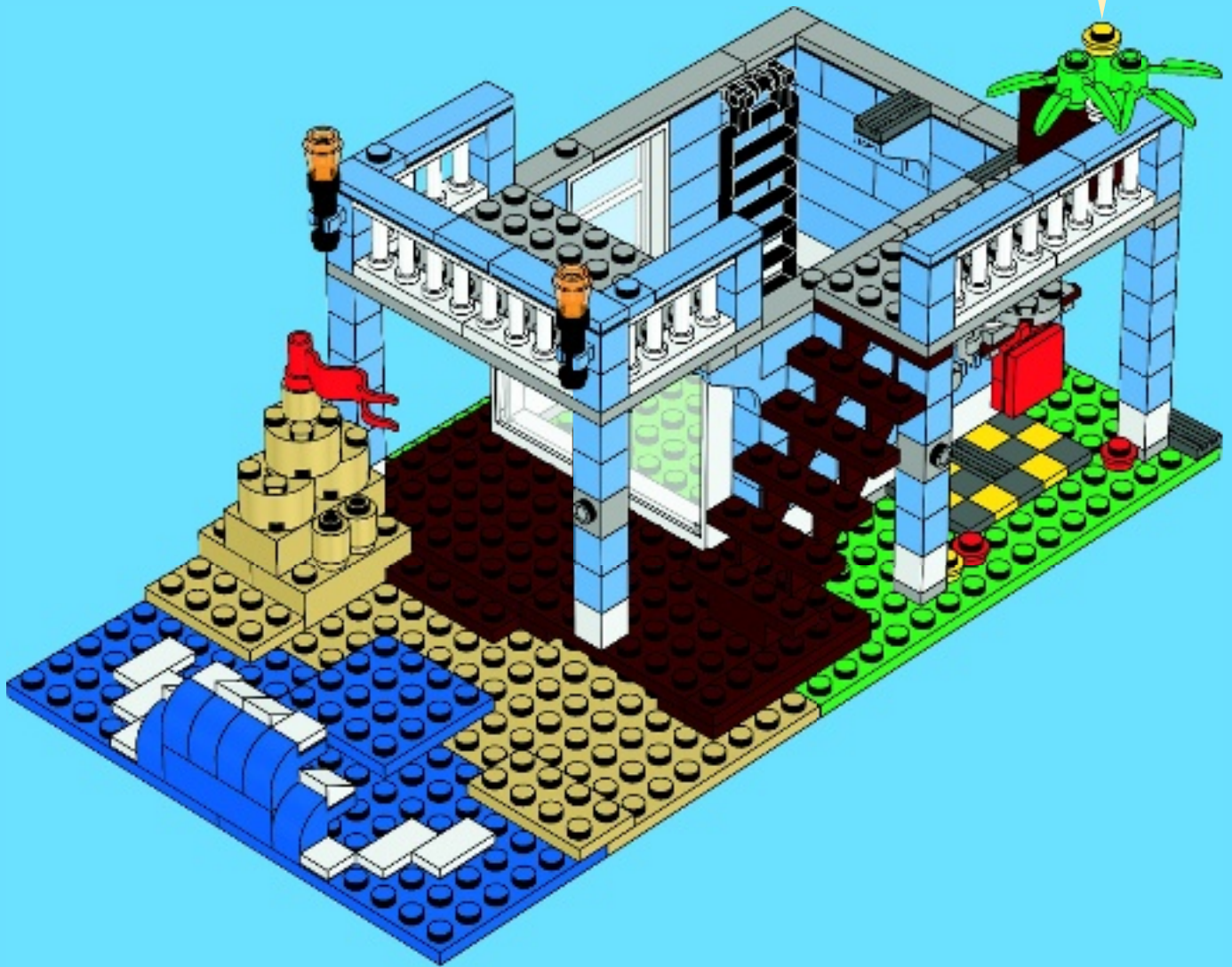
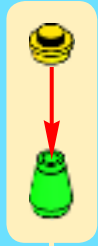



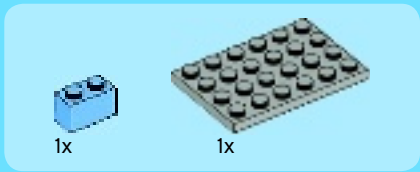
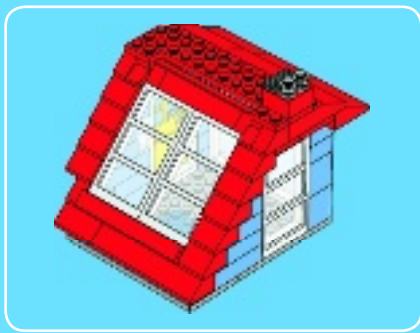

1

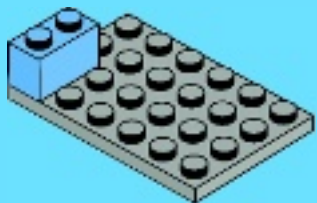

2

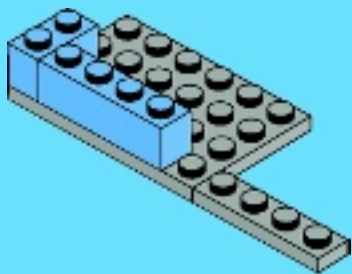

3

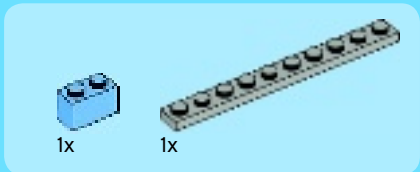
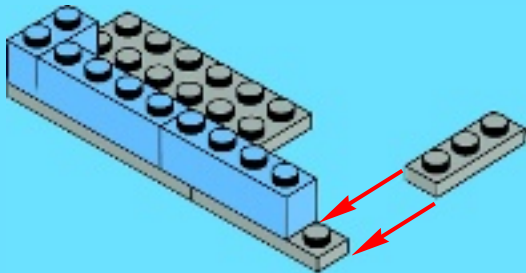

4

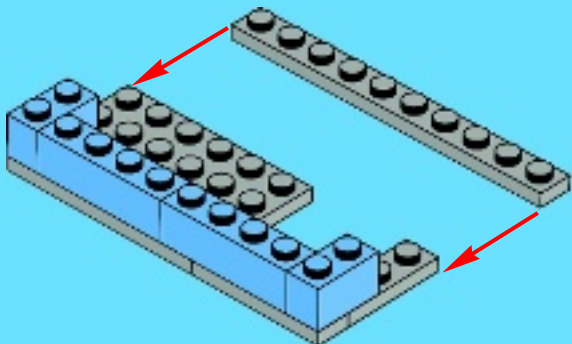



1x

5

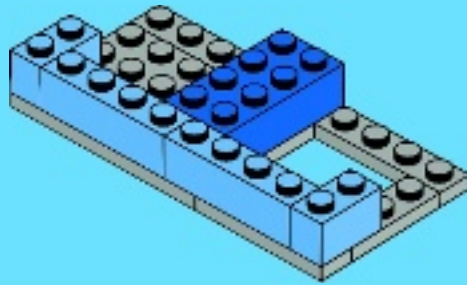

1x

6

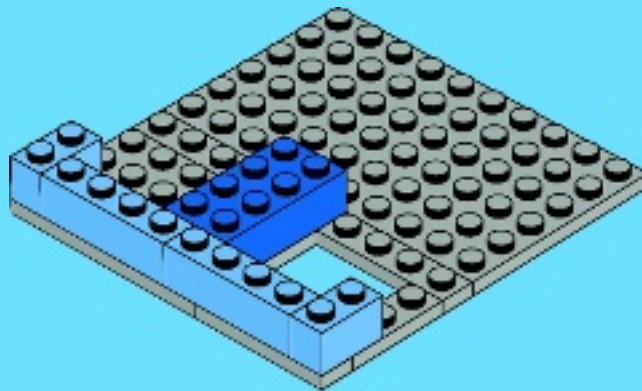

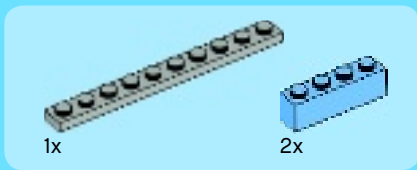

7

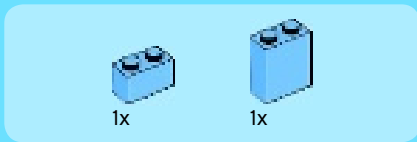
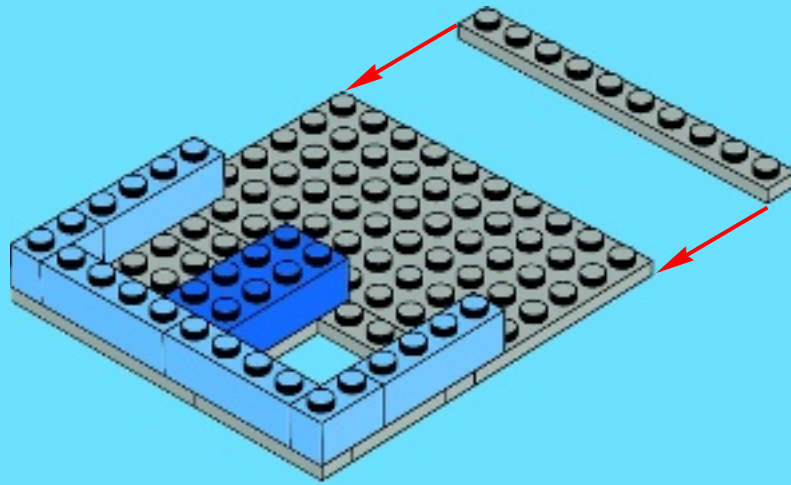

8

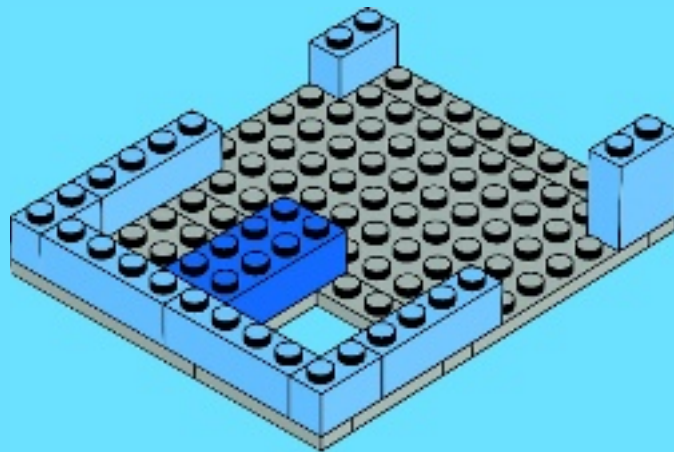



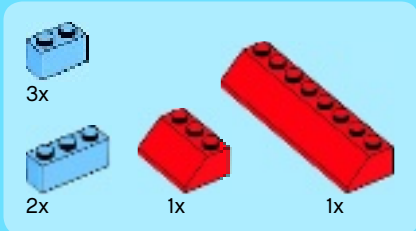

9

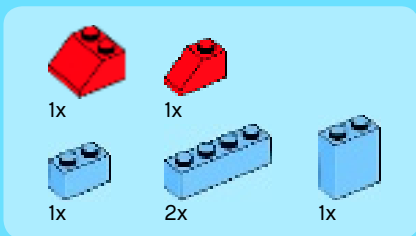
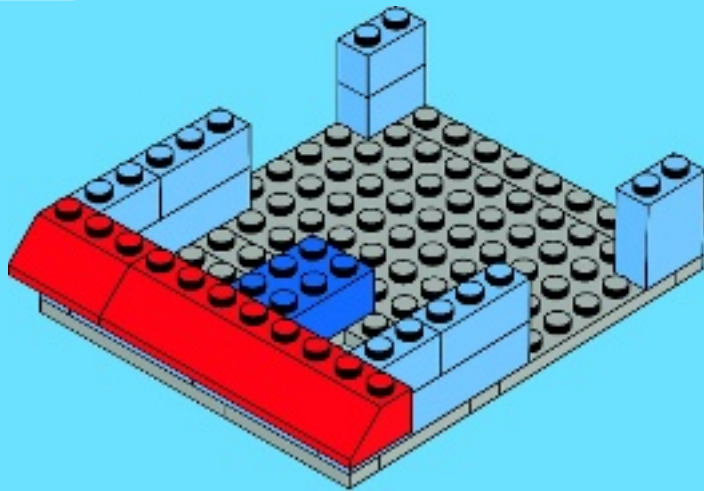

10

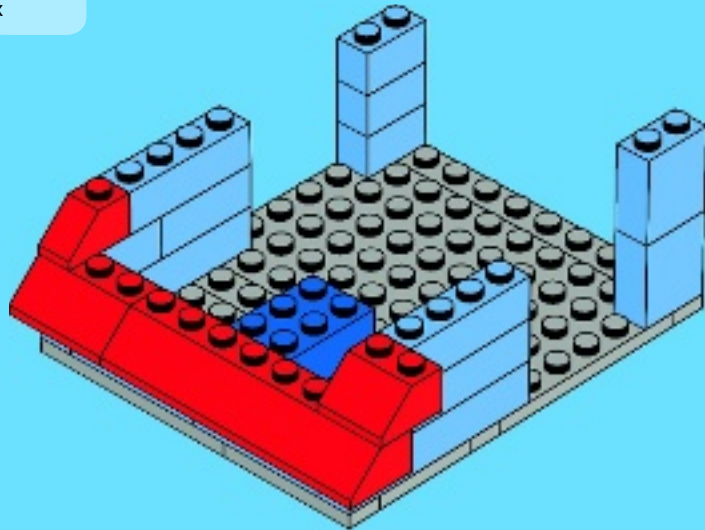



2x



2x



1x



1x



1x

# 11

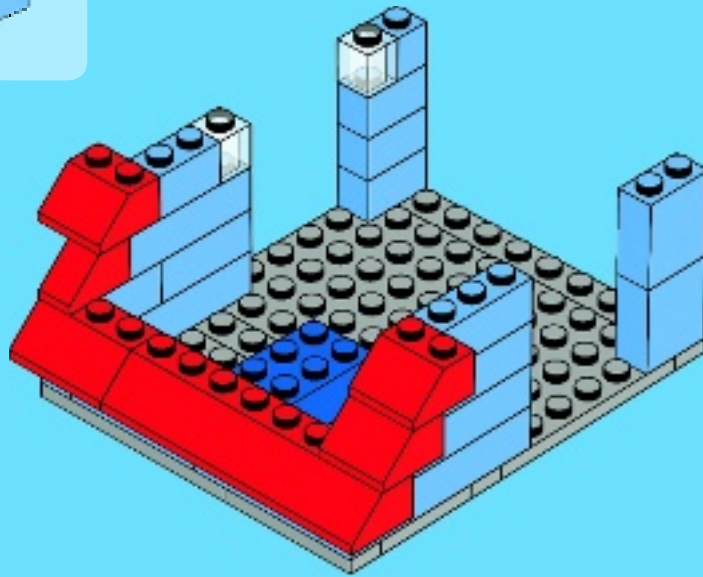

2x



2x



2x



2x

# 12

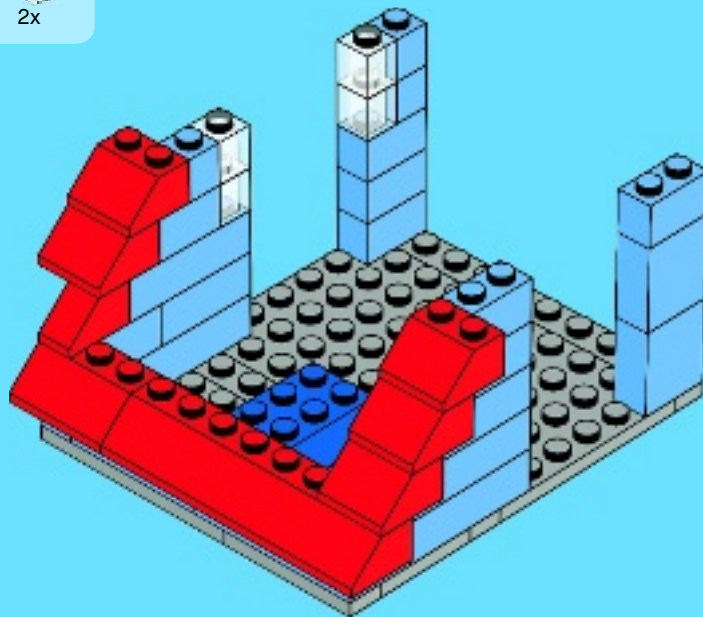

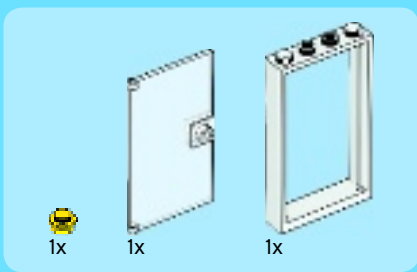

13

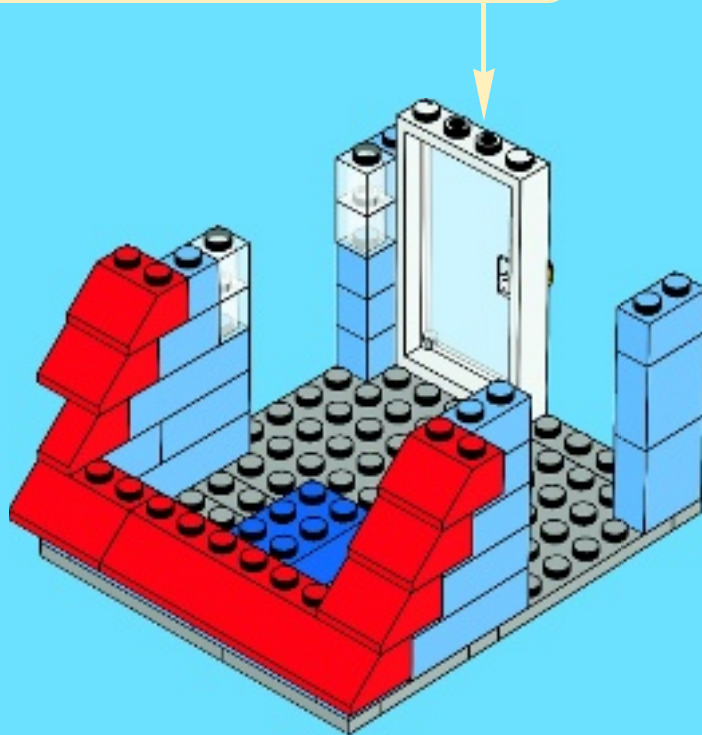
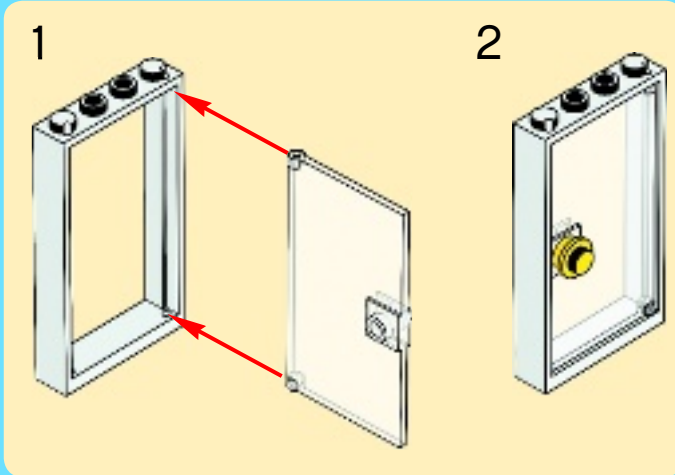



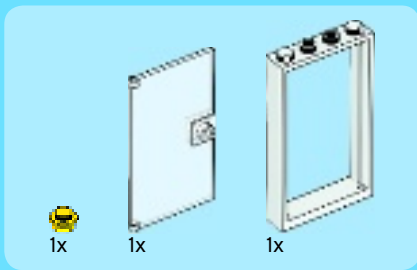

14

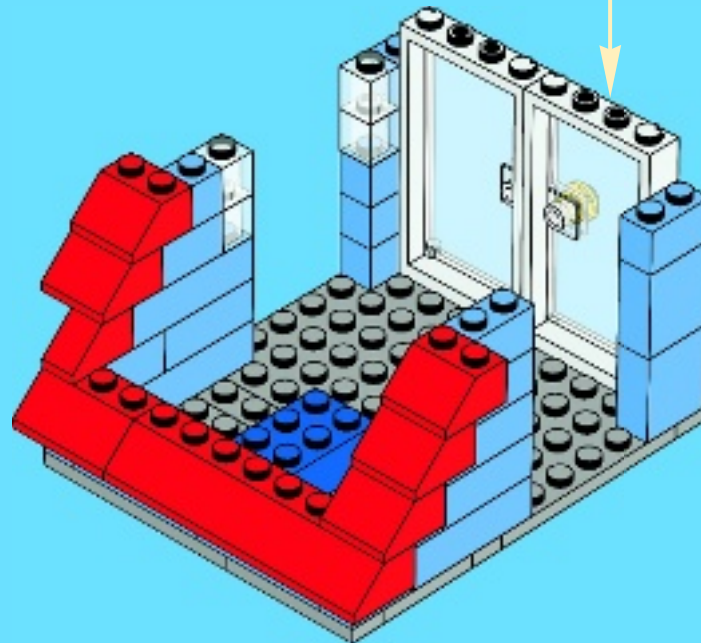
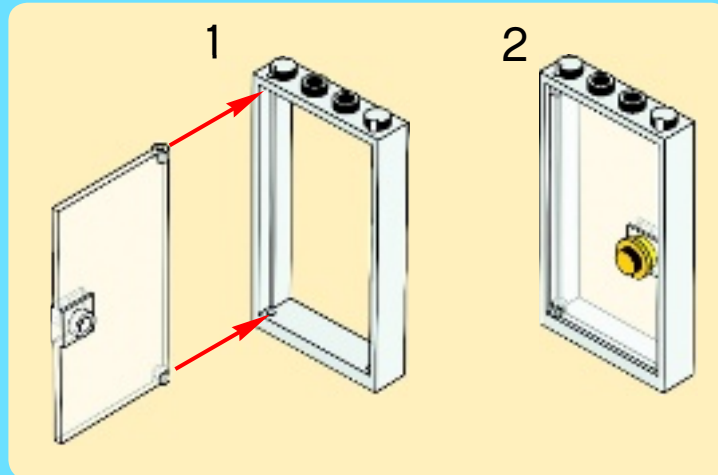



2x



2x



2x

# 15

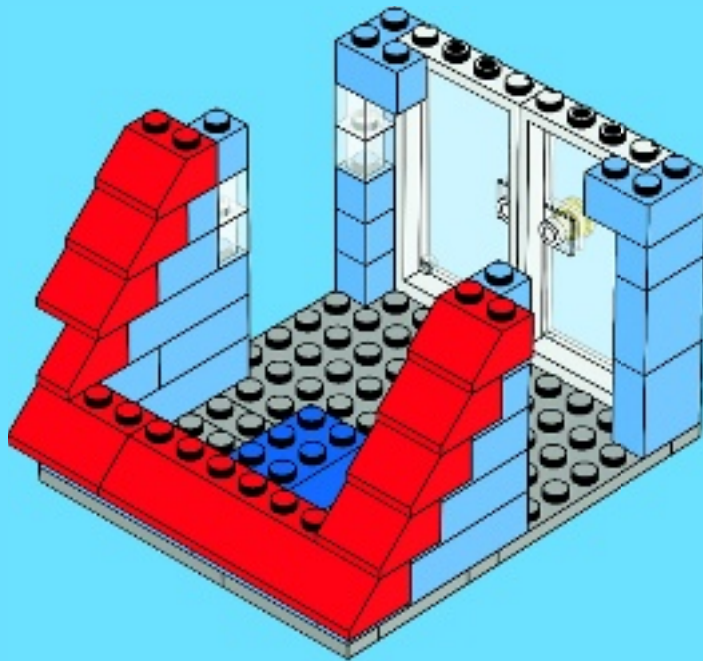

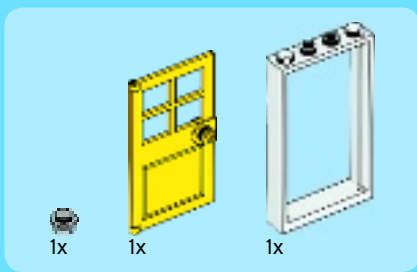

16

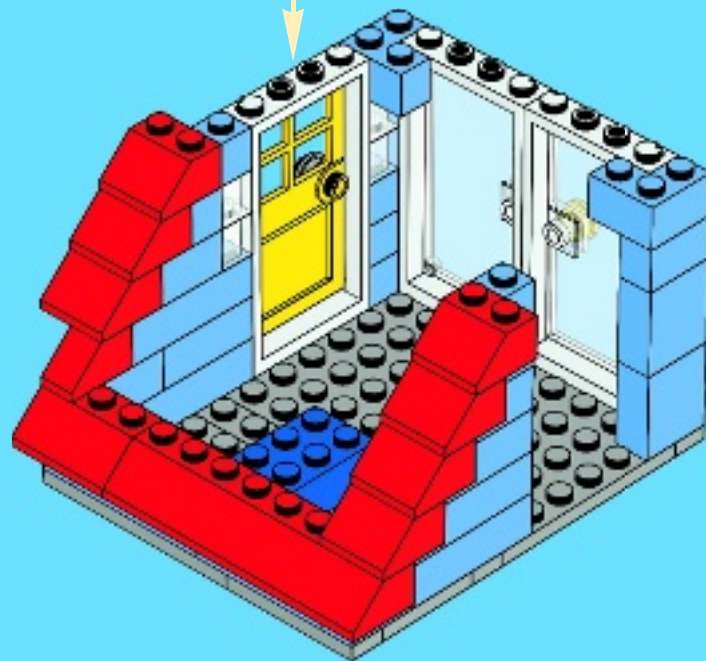
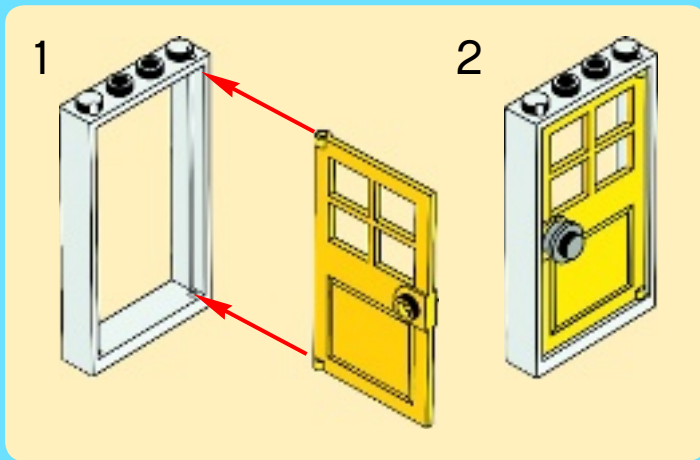



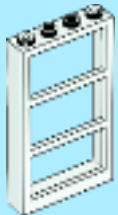

1x



1x

17

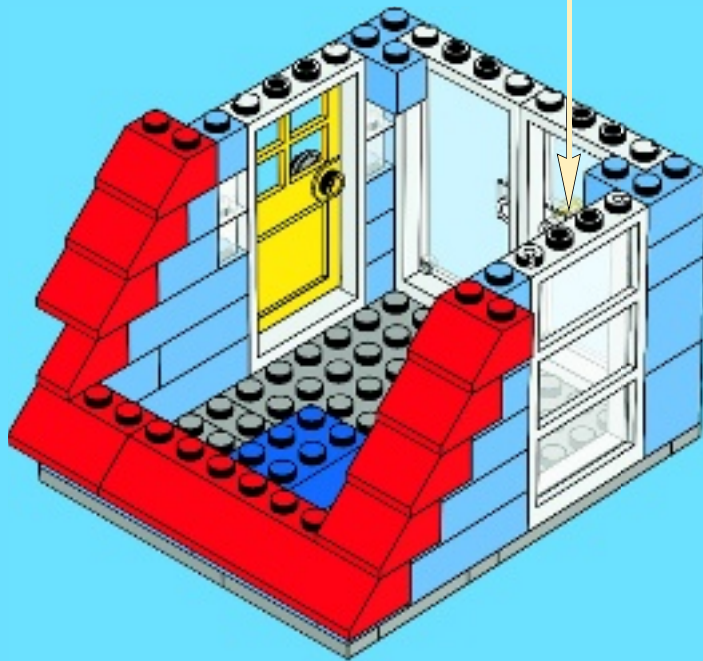
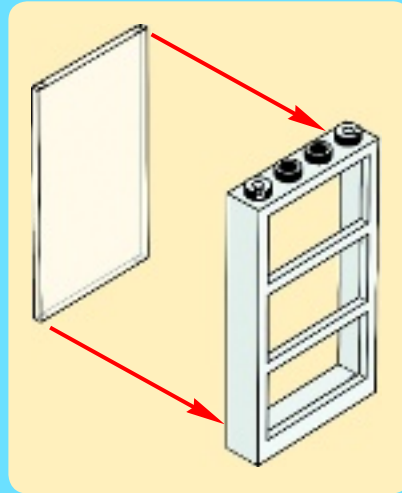

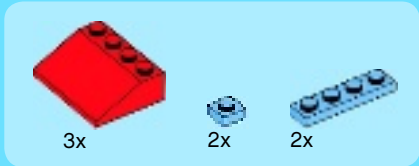

18

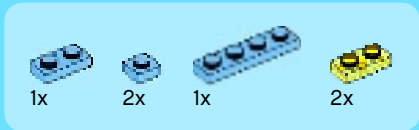
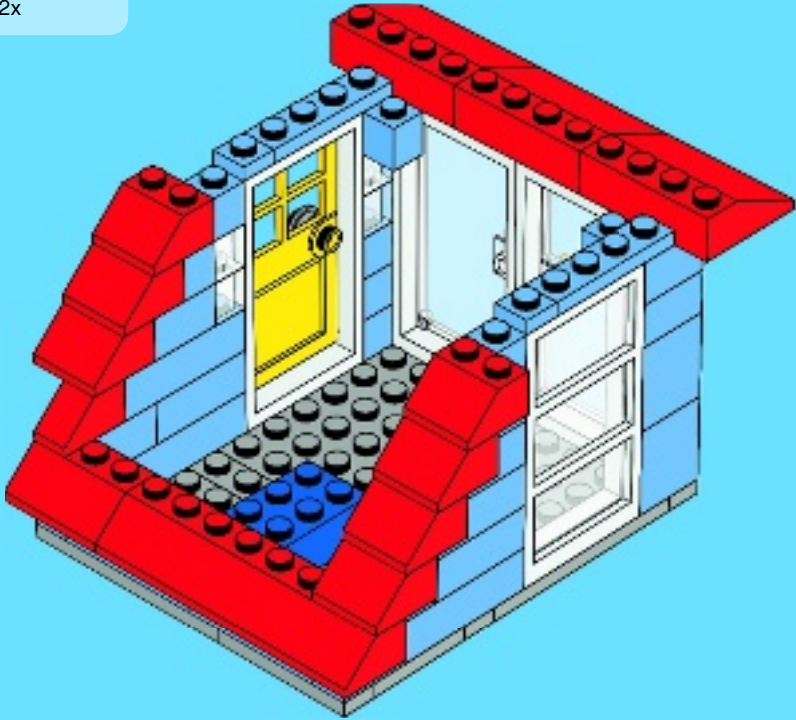

19

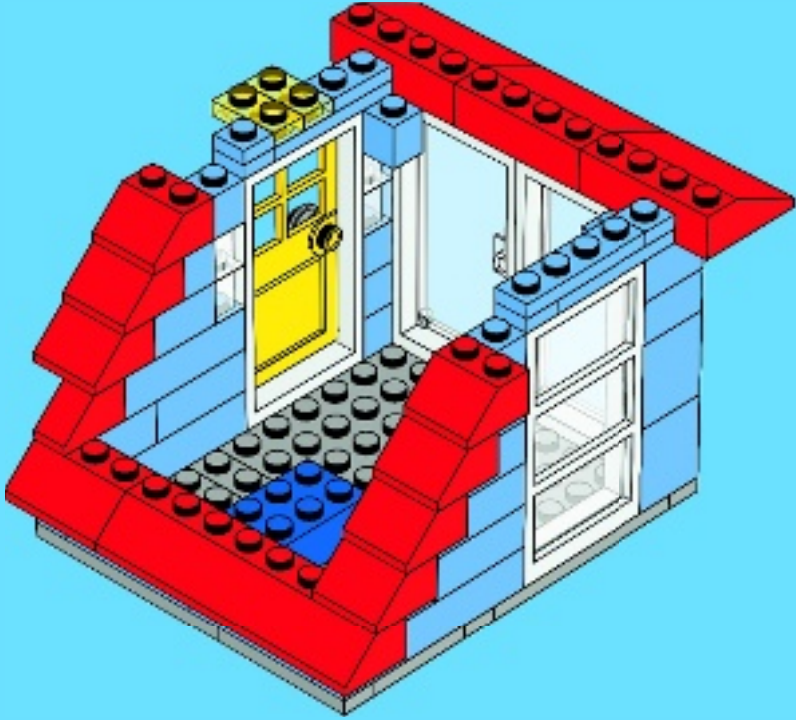

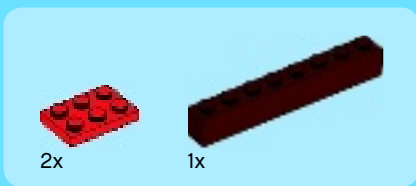

20

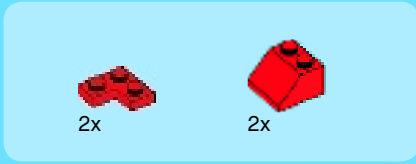
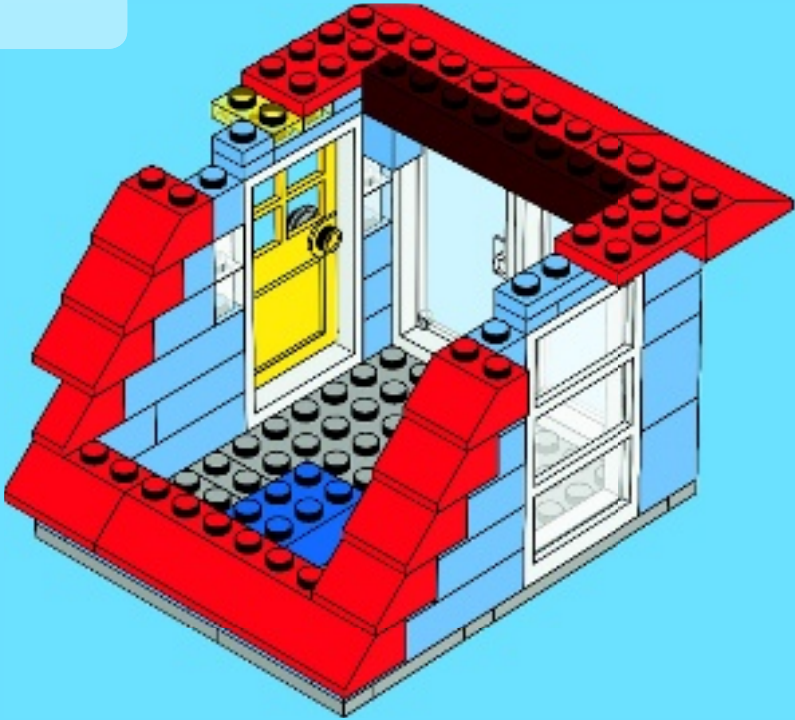

21

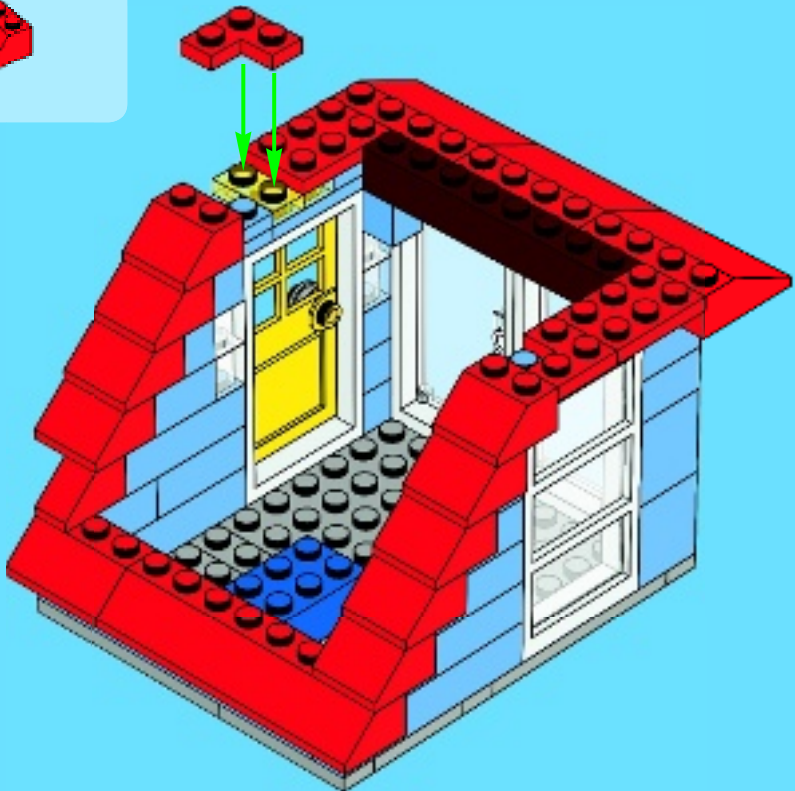





3x



2x

22

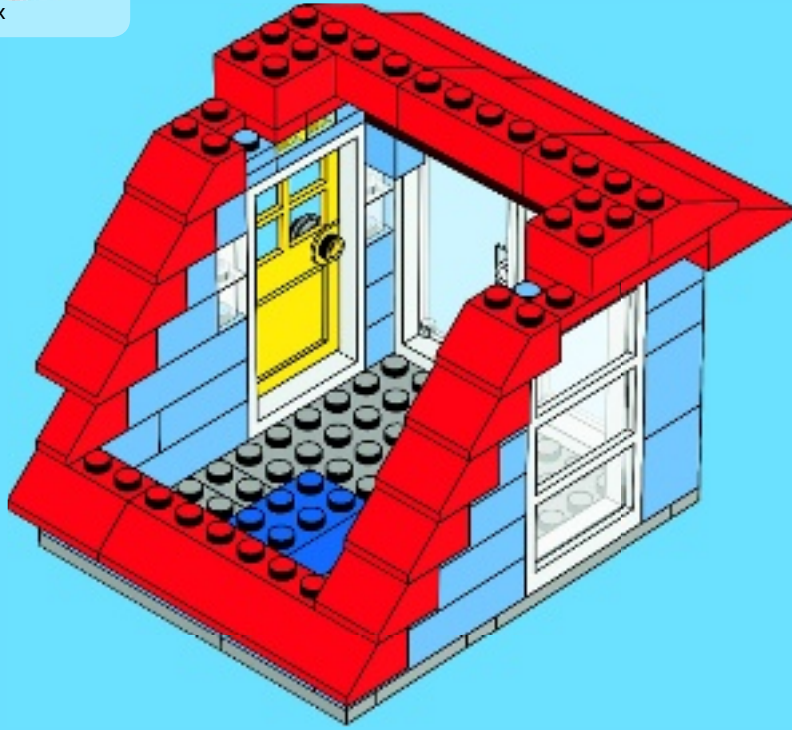

2x



2x

23

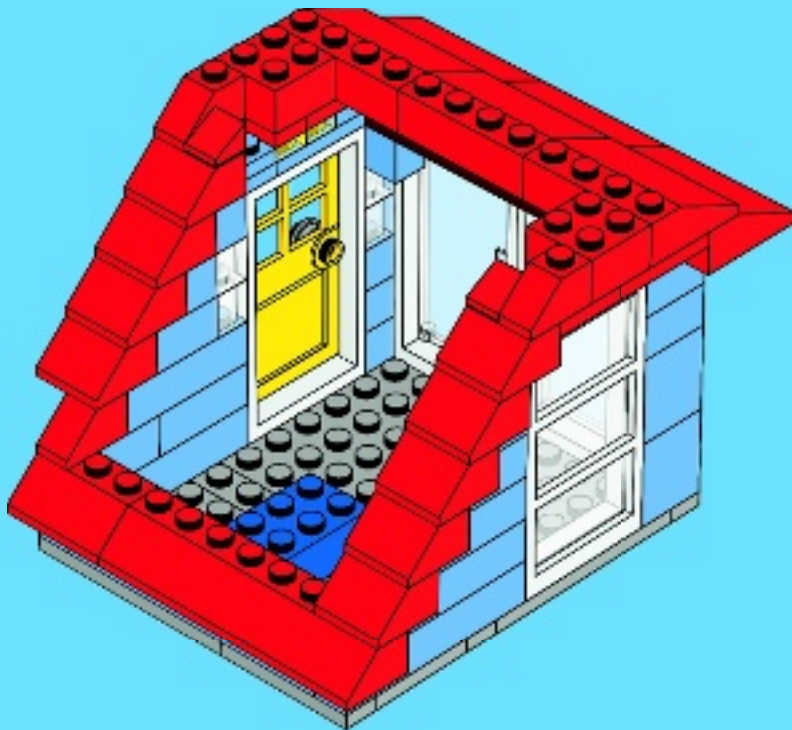



1x



2x

1

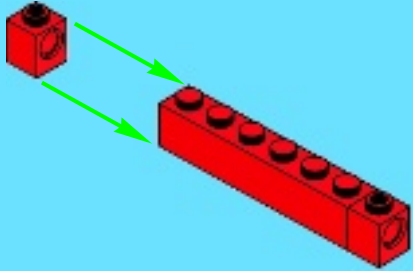

1x



2x

2

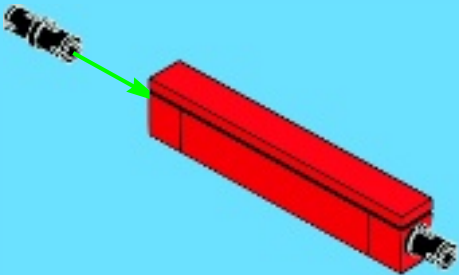

2x



2x

3

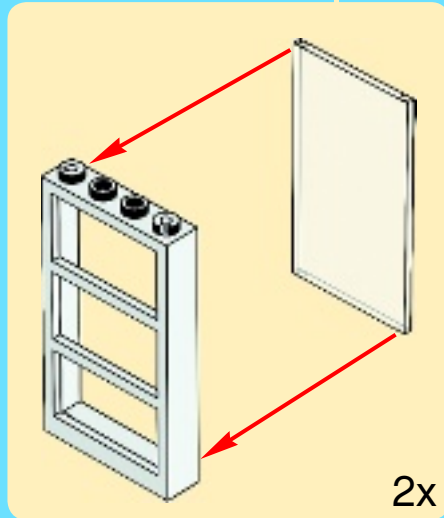



1x



2x

4



2x



2x



1x

5

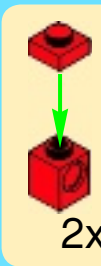
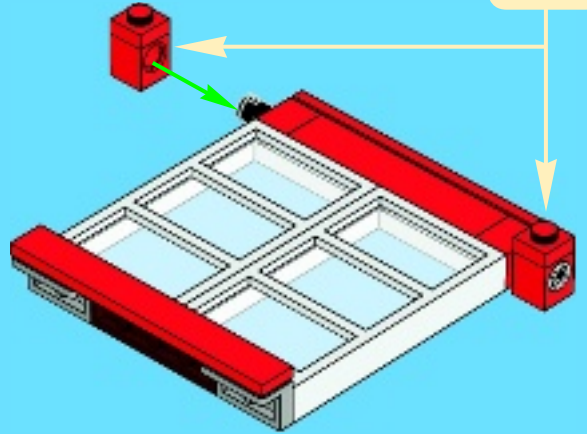

2x

24

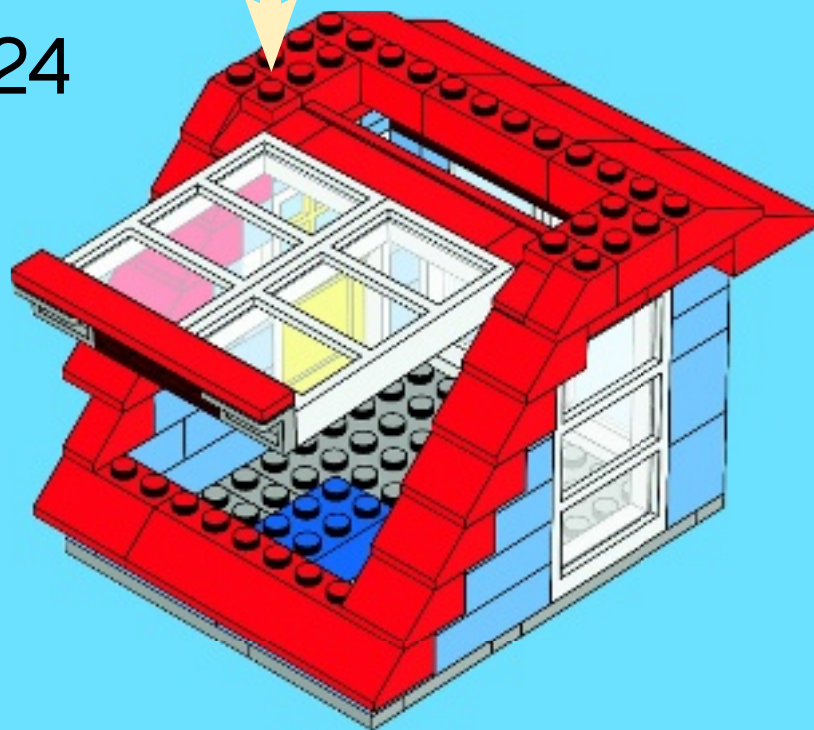



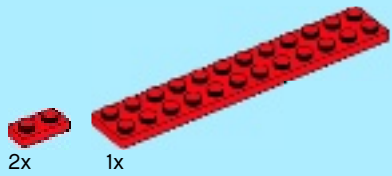

25

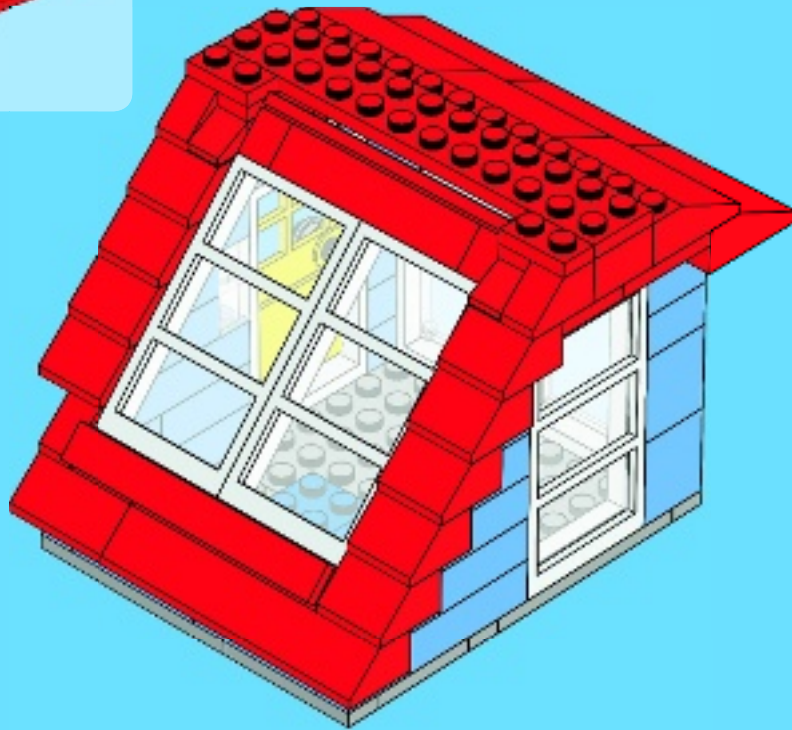

26

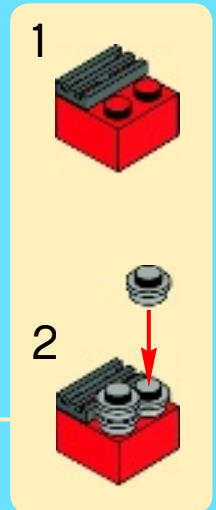
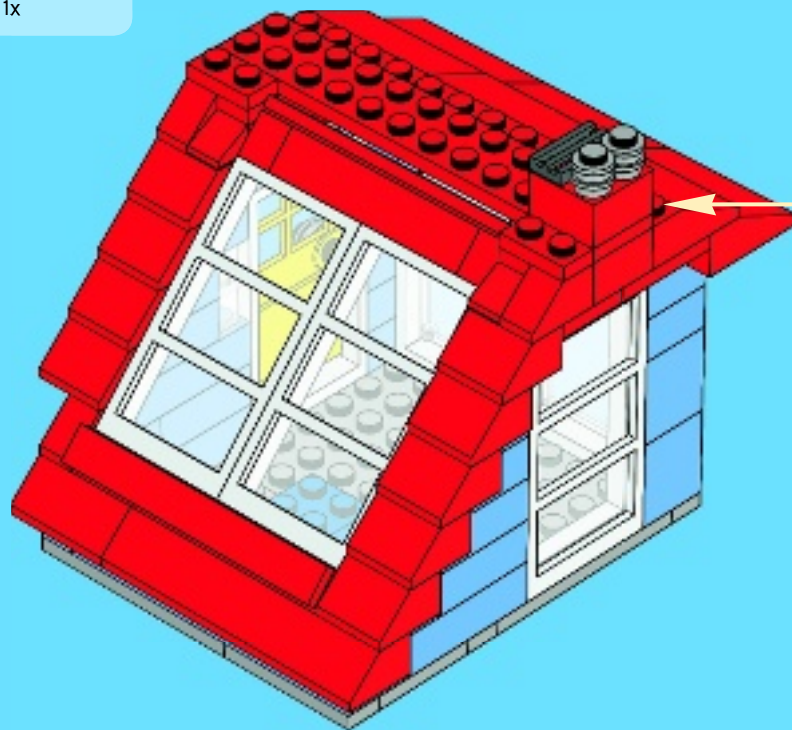

48

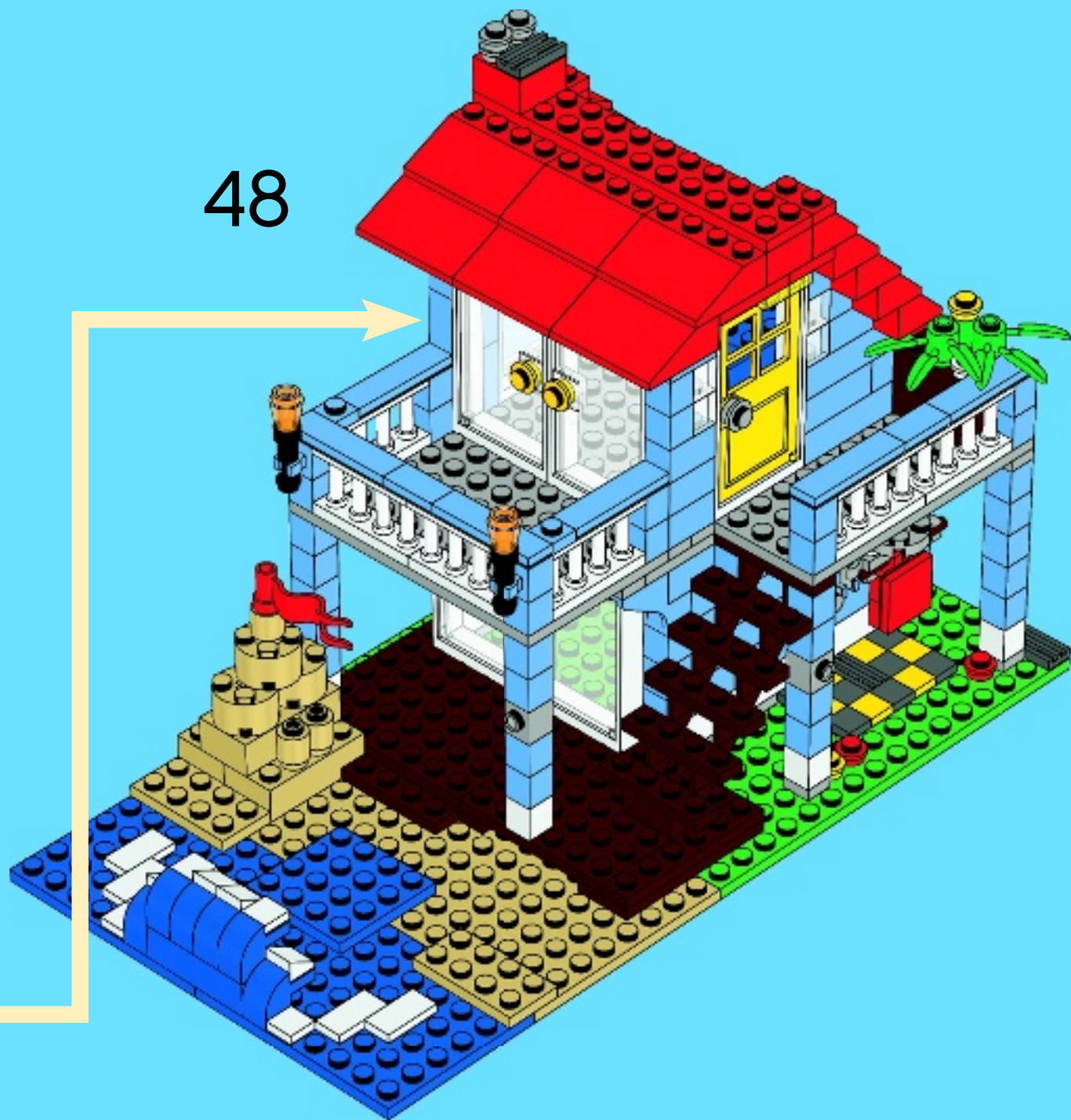



- 1x
- 2x
- 4x
- 2x
- 1x
- 1x
- 1x
- 1x

49

1

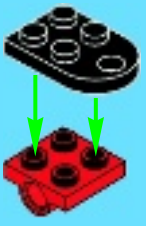

2

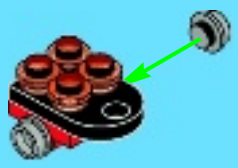

3

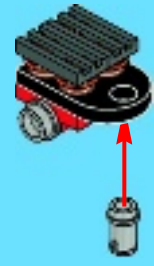

4

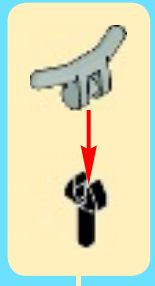





1x



1x



1x



1x

# 50



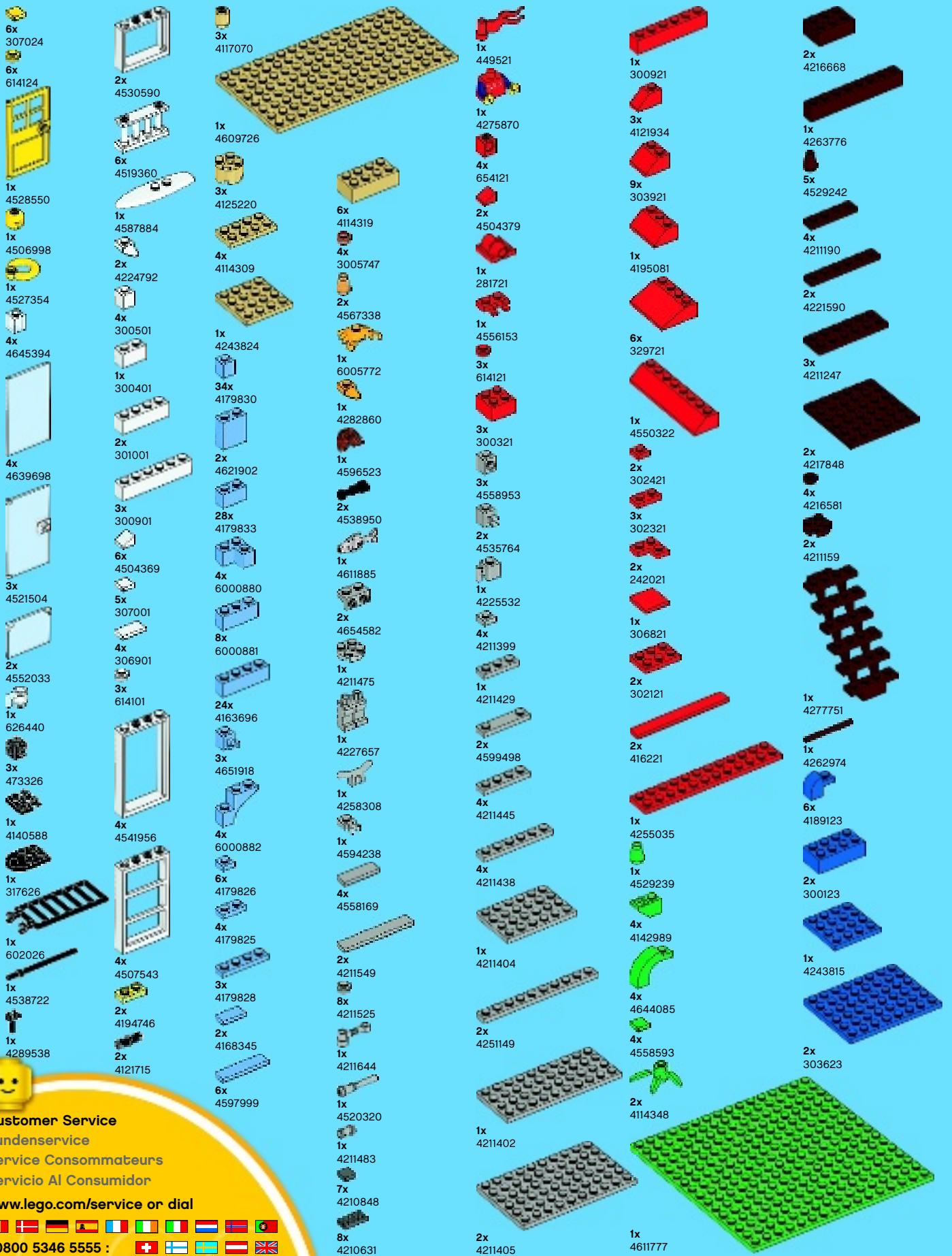

**Customer Service**  
**Kundenservice**  
**Service Consommateurs**  
**Servicio Al Consumidor**  
[www.lego.com/service](http://www.lego.com/service) or dial  
 00800 5346 5555 :   
 1-800-422-5346 :





# CREATOR

5891



5771



5770



5766



[creator.LEGO.com](http://creator.LEGO.com)







# WIN!

Go to [www.LEGOsurvey.com/product](http://www.LEGOsurvey.com/product) to fill out a survey for a chance to win a cool LEGO® Product.

No purchase necessary.

Open to all residents where not prohibited.



[www.LEGO.com](http://www.LEGO.com)



## [www.LEGOsurvey.com/product](http://www.LEGOsurvey.com/product)

### GEWINNE!

Nimm an der Umfrage auf [www.LEGOsurvey.com/product](http://www.LEGOsurvey.com/product) teil und hab die Chance ein cooles LEGO® Produkt zu gewinnen!

Die Teilnahme am Gewinnspiel führt zu keinerlei Kaufverpflichtungen. Teilnahme in allen nicht ausgeschlossenen Ländern möglich.

### WIN!

Ga naar [www.LEGOsurvey.com/product](http://www.LEGOsurvey.com/product), vul een enquêteformulier in en maak kans op een cool LEGO® product.

Geen aankoopverplichting. Iedereen mag deelnemen, uitgezonderd ingezetenden van landen waar een enquêteverbod geldt.

### GAGNE!

Visite [www.LEGOsurvey.com/product](http://www.LEGOsurvey.com/product) pour répondre à un questionnaire et avoir une chance de gagner un produit LEGO® très cool!

Aucune obligation d'achat. Ouvert à tous les résidents des pays autorisés.

### 当てよう!

[www.LEGOsurvey.com/product](http://www.LEGOsurvey.com/product) にアクセスして、アンケートにご記入ください。当選者にはレゴ製品を差し上げます。

お買い上げの必要はありません。禁止されていない限り、すべての皆様にご利用いただけます。



# CREATOR

7346





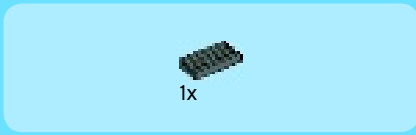
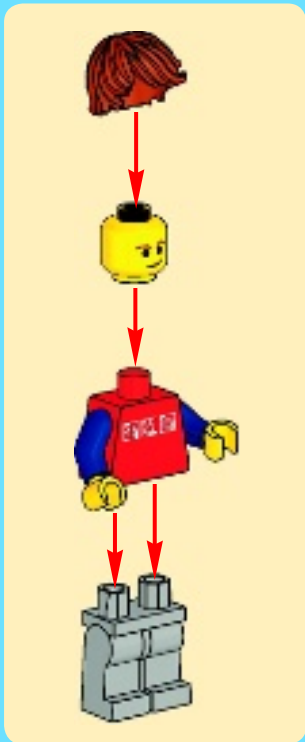

1

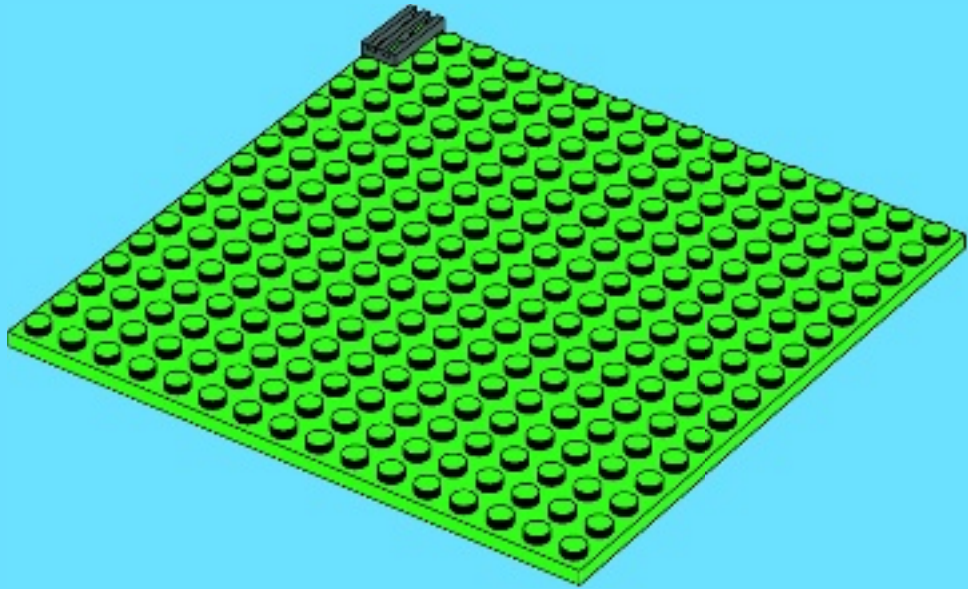





1x



1x

# 2

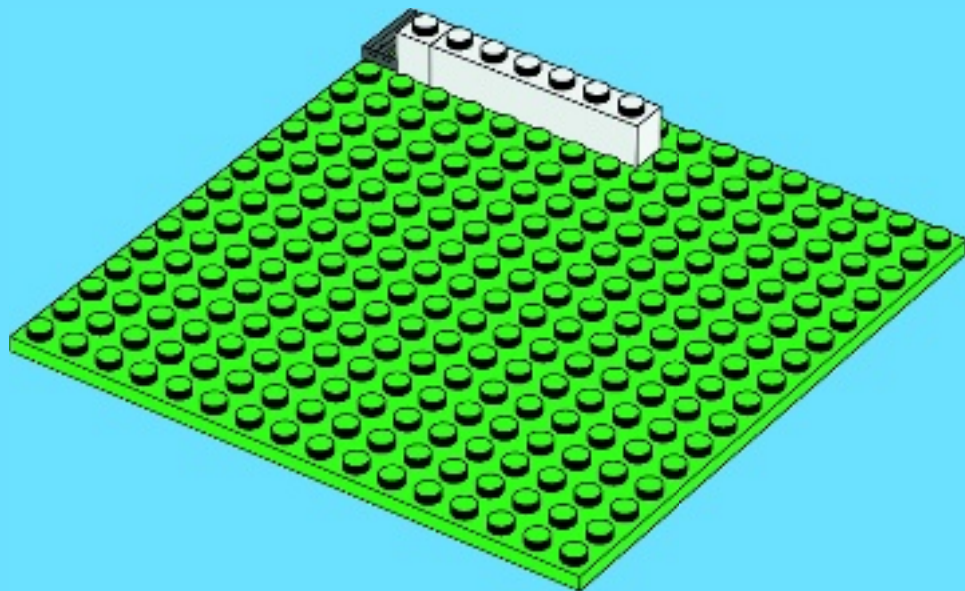

1x



2x

# 3

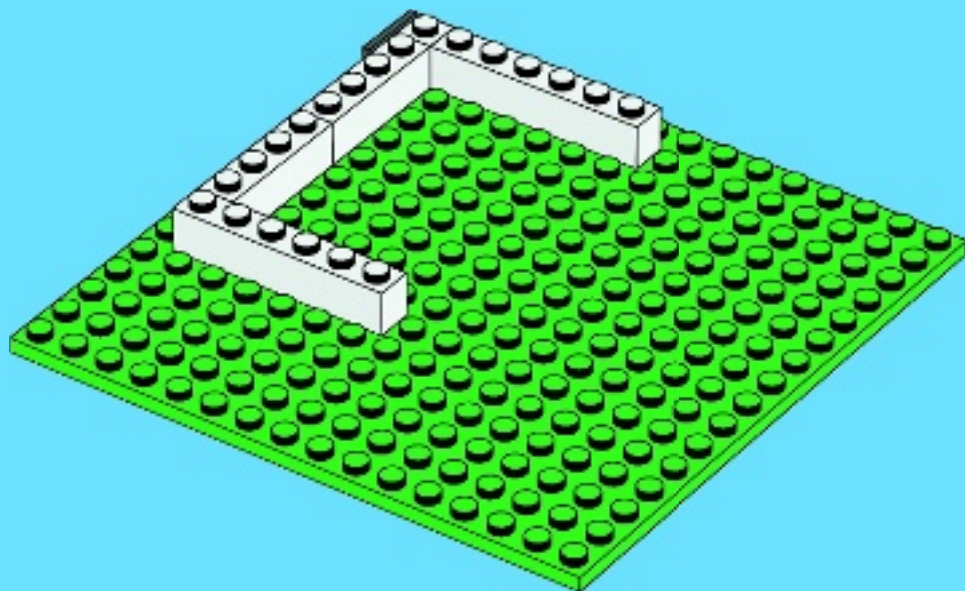

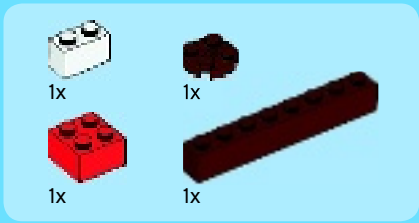

4

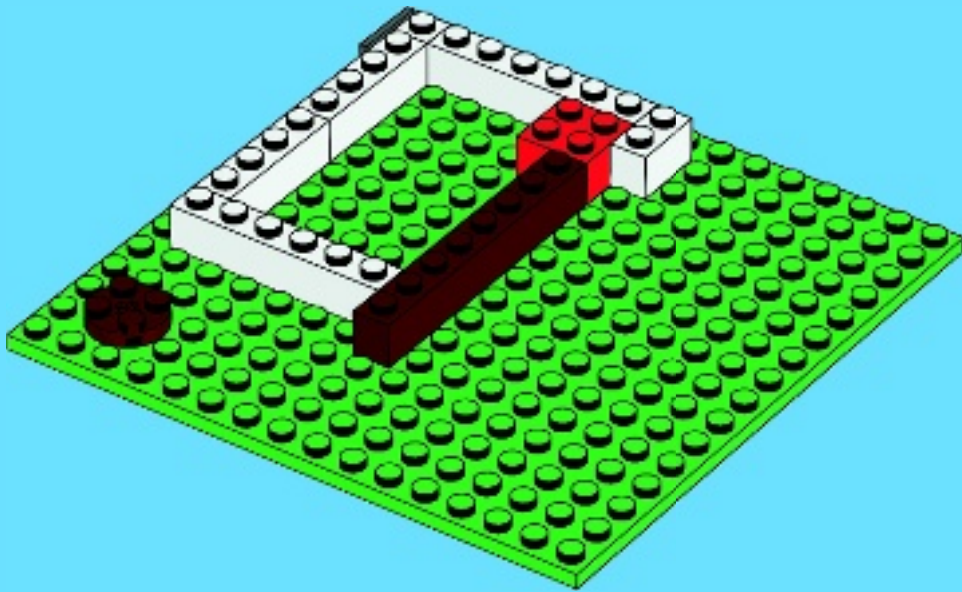



1x



2x

# 5

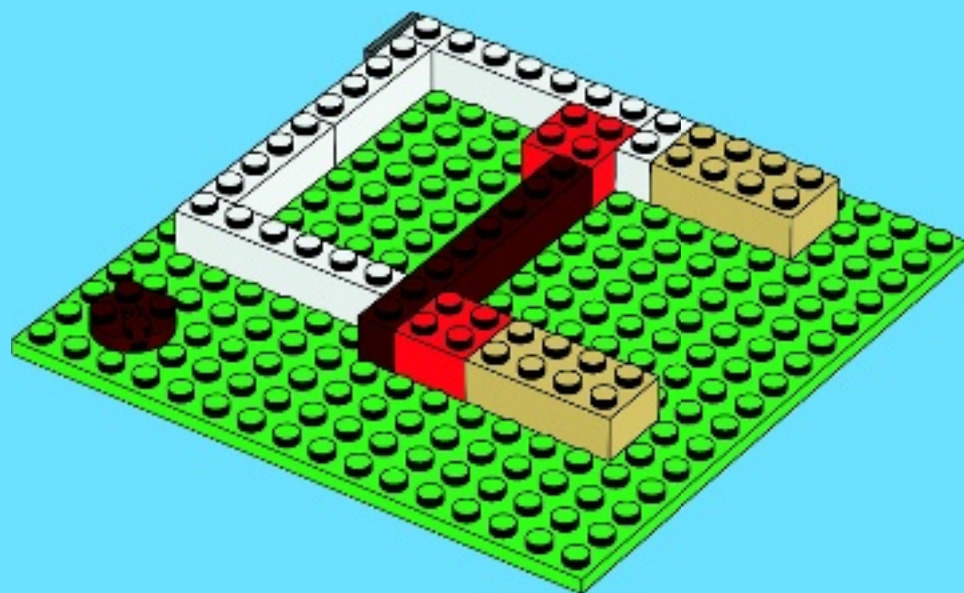

1x



2x



2x

# 6

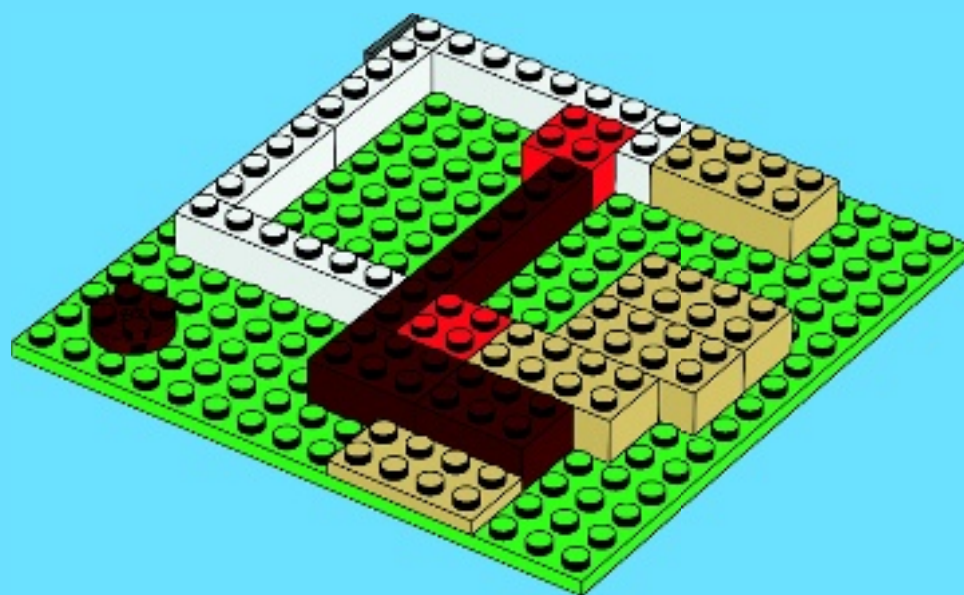



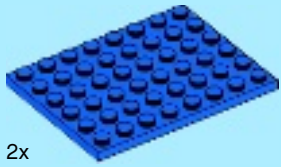

2x

7

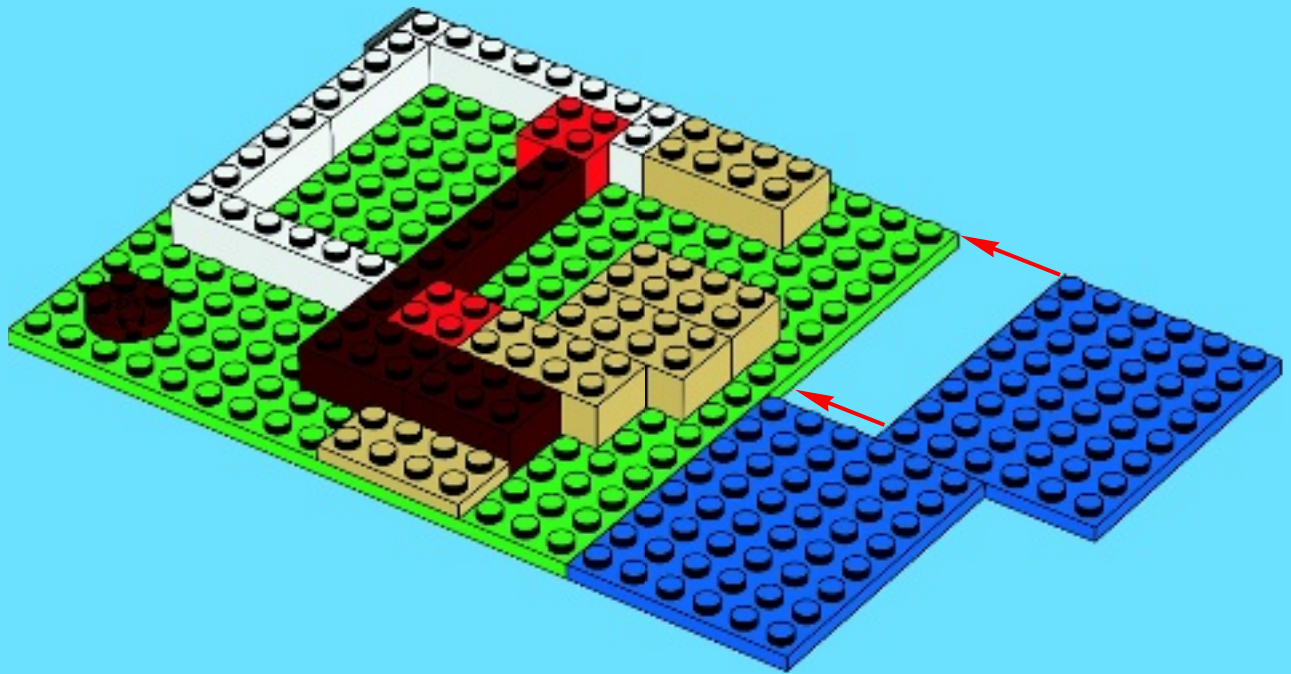

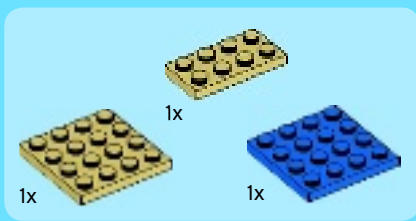

8

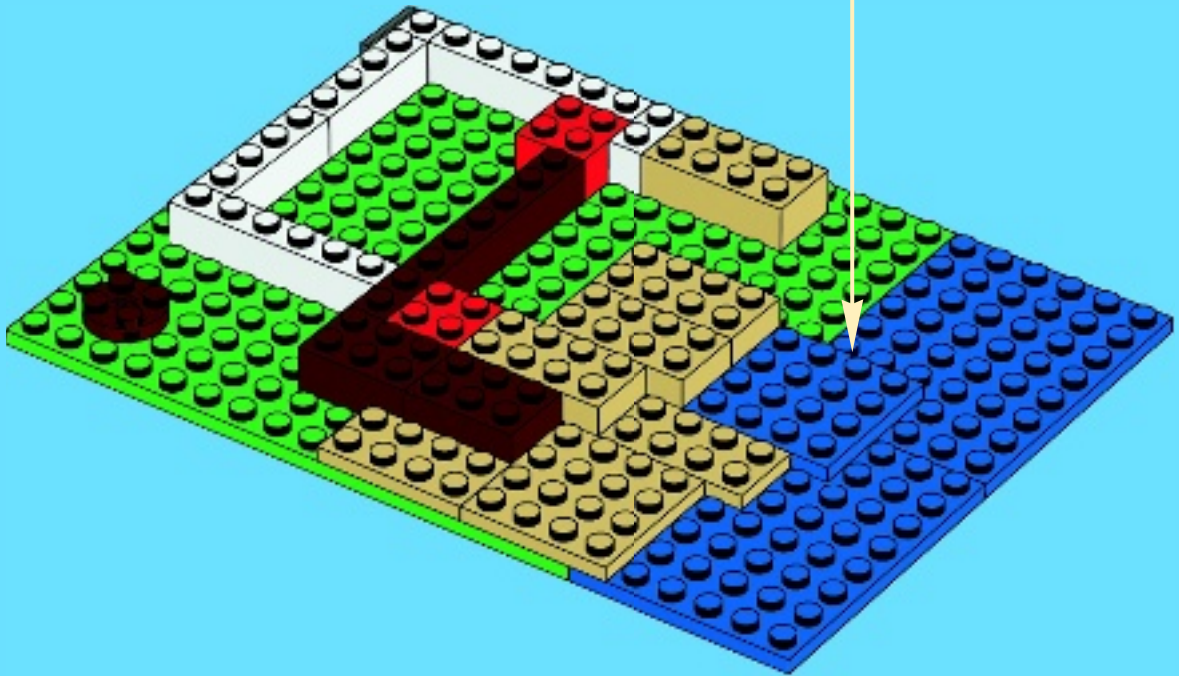



1x



2x

9

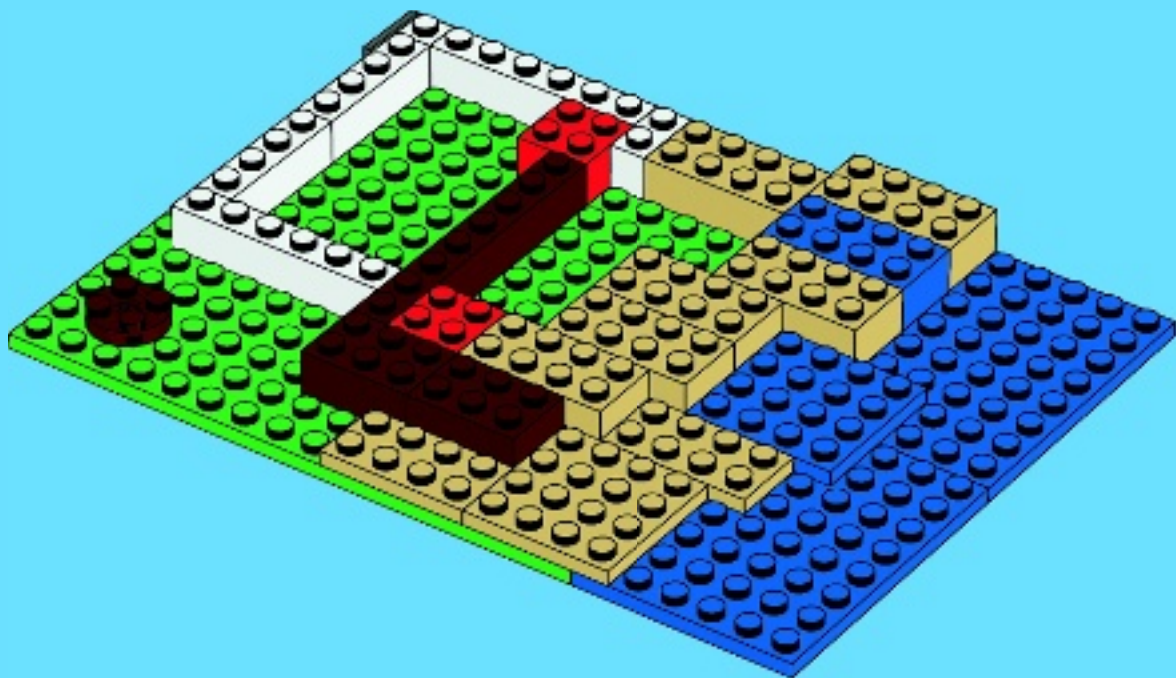





1x



2x

# 10

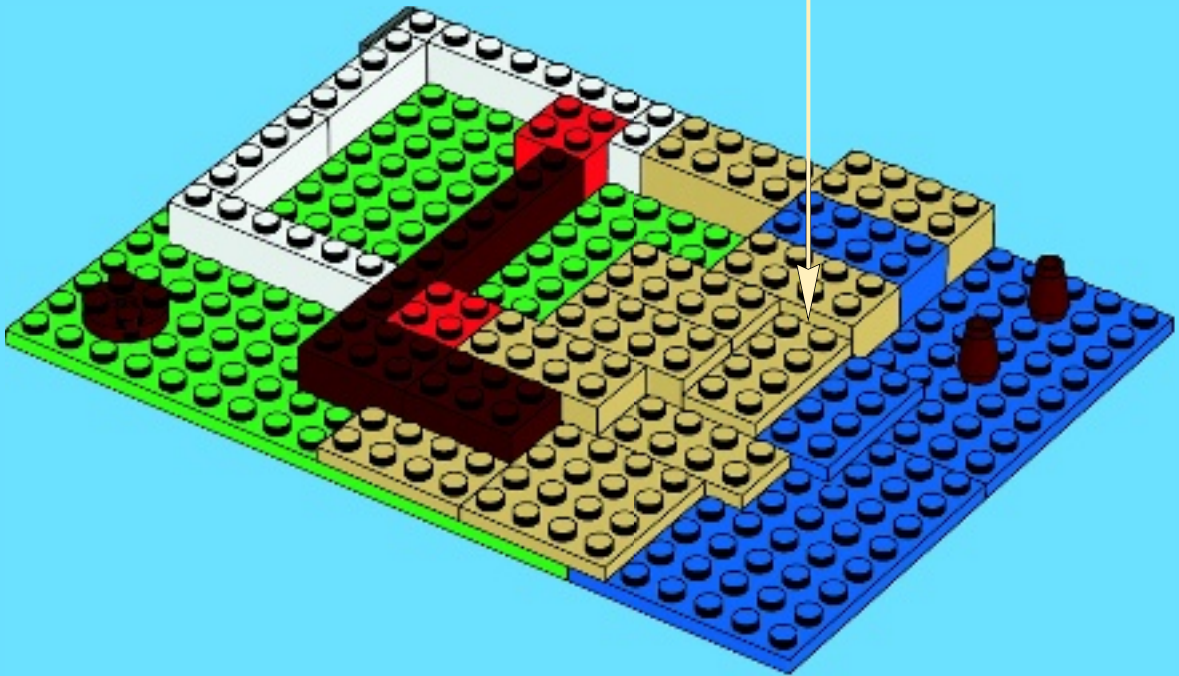

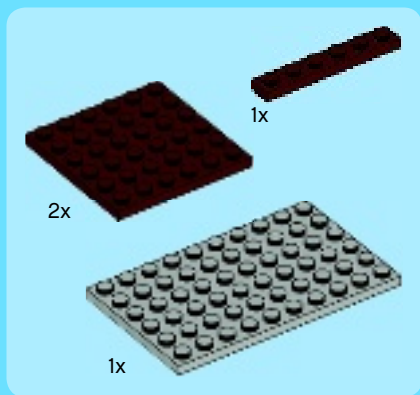

11

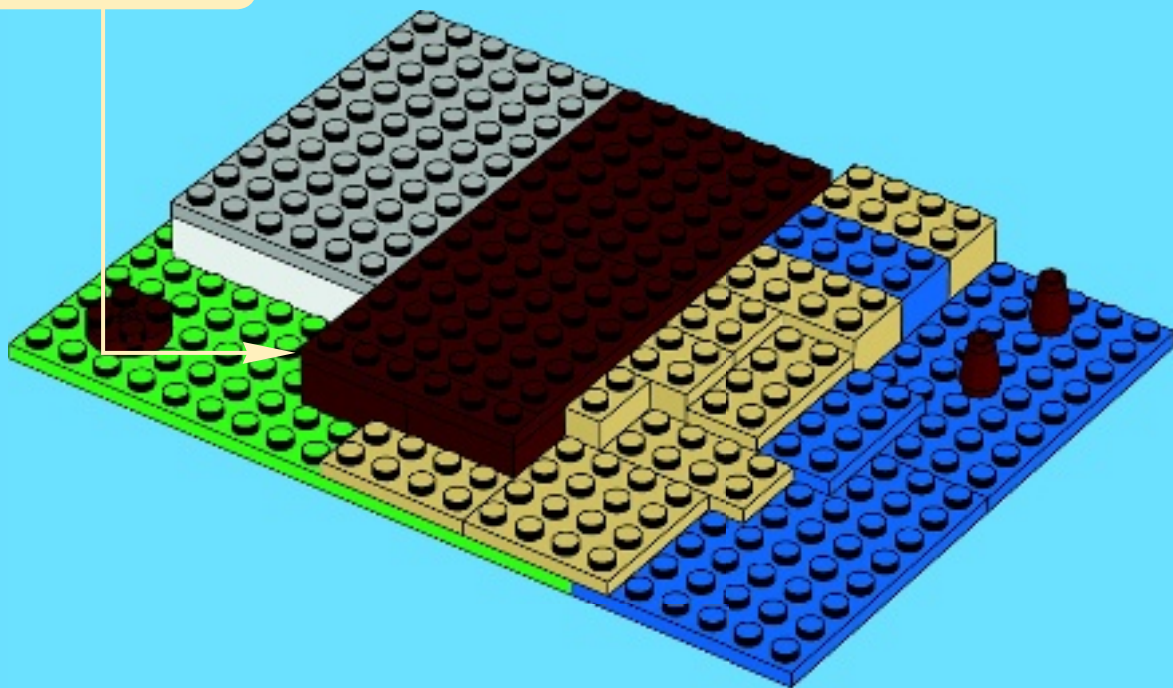

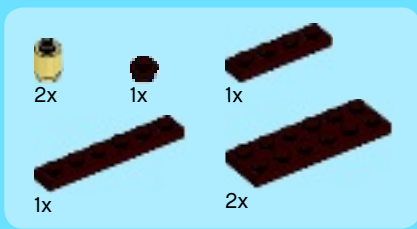

12

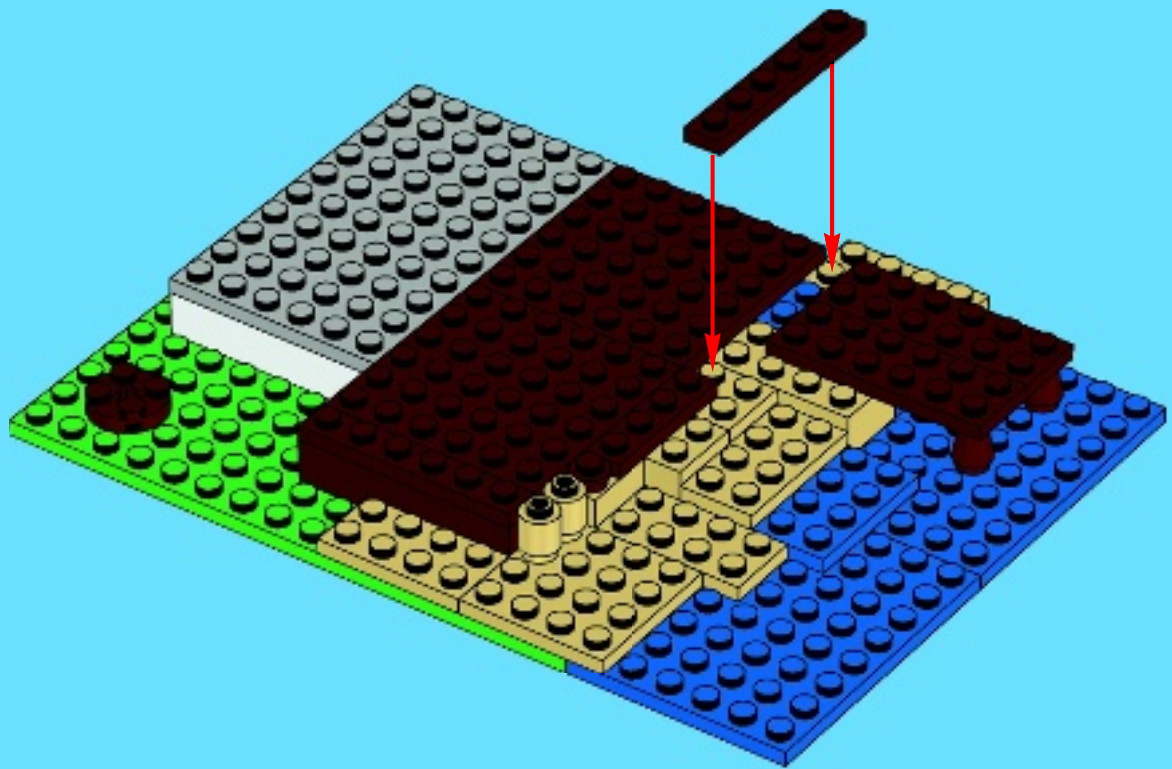





1x



3x

# 13

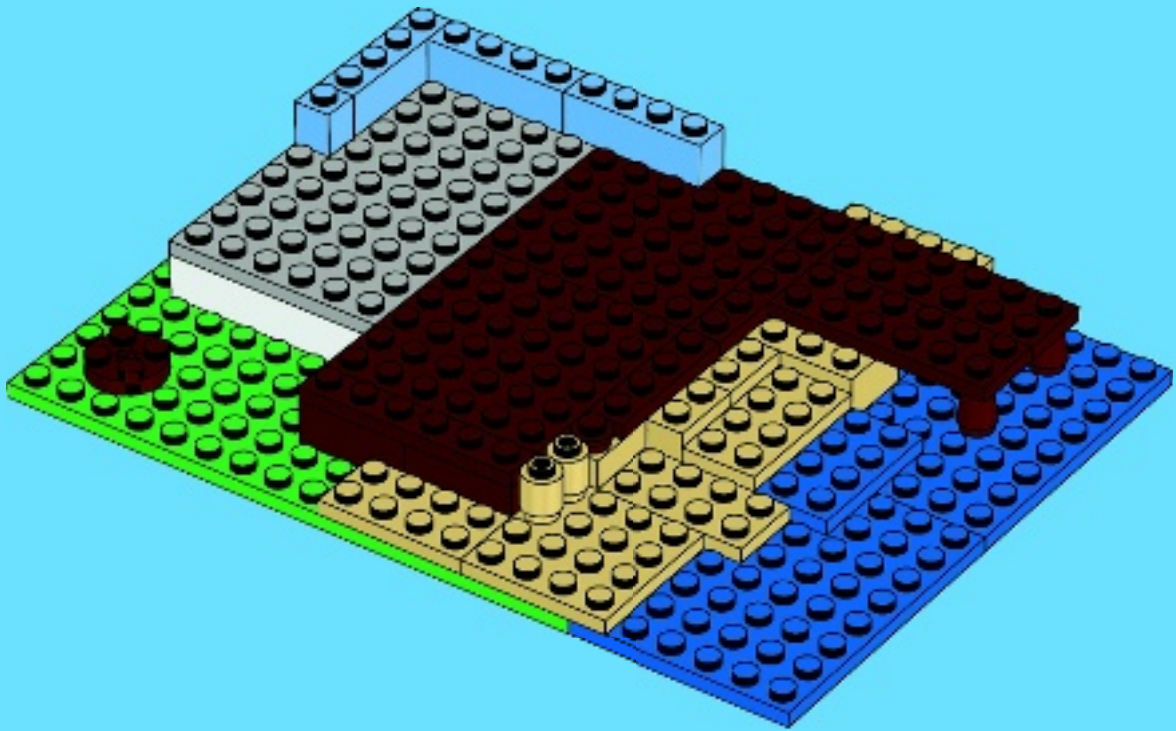

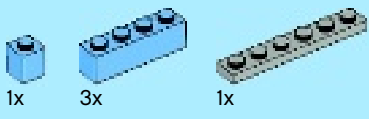

14

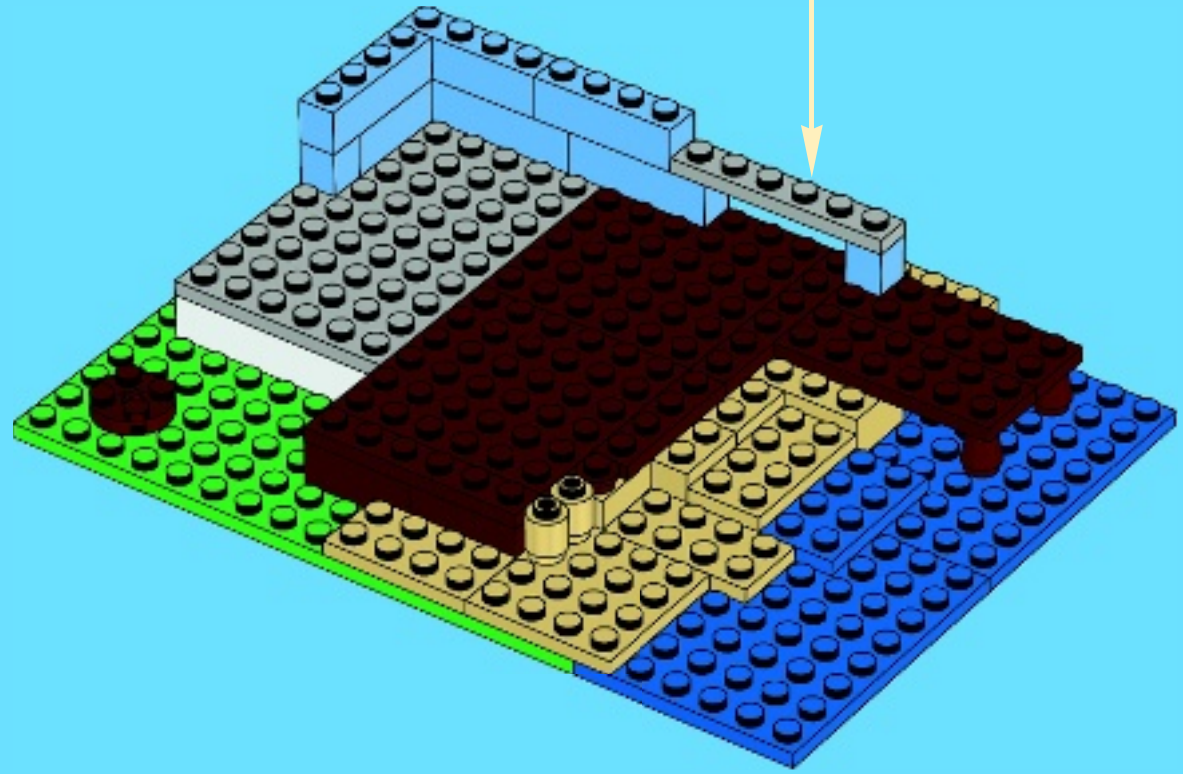
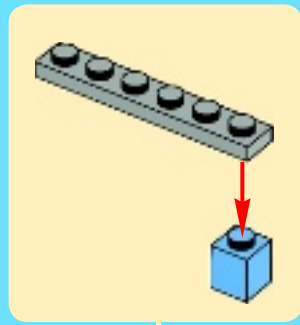



3x



3x

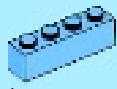

1x



2x

# 15

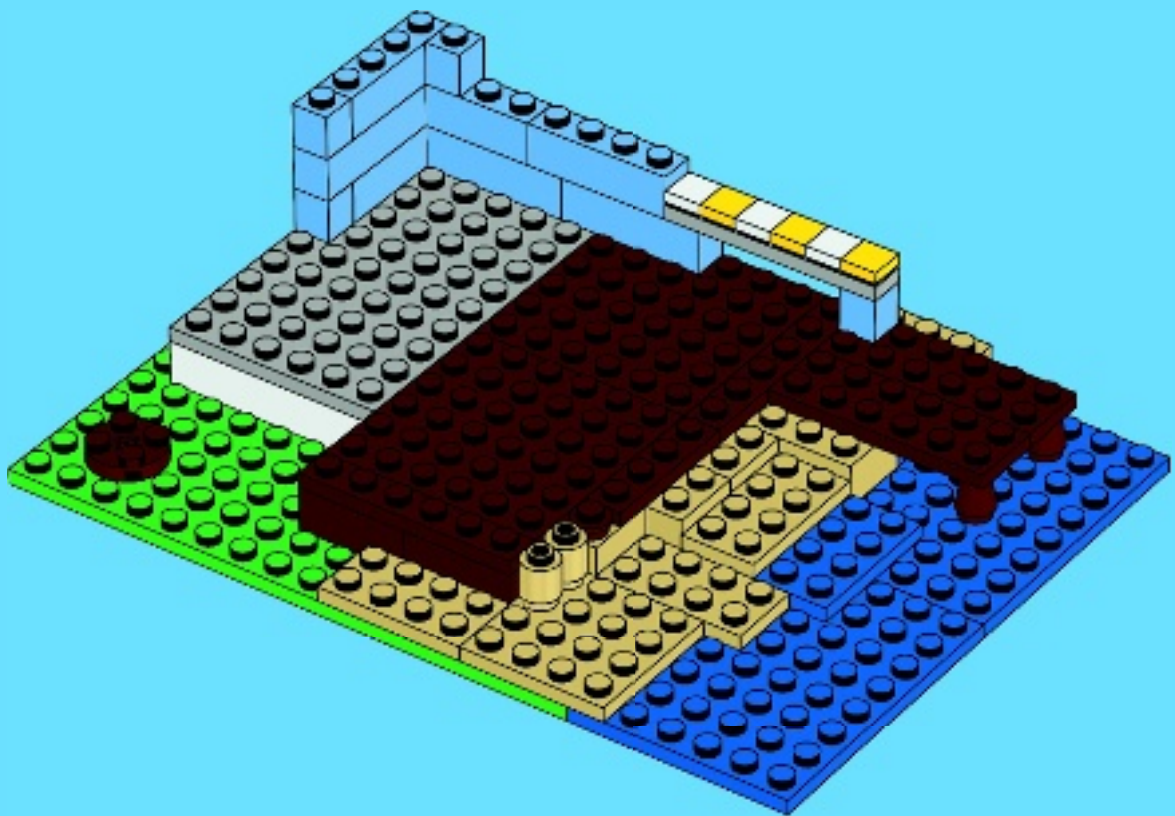



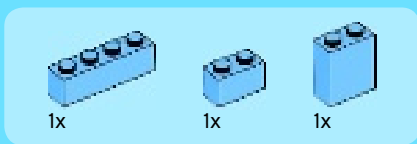

16

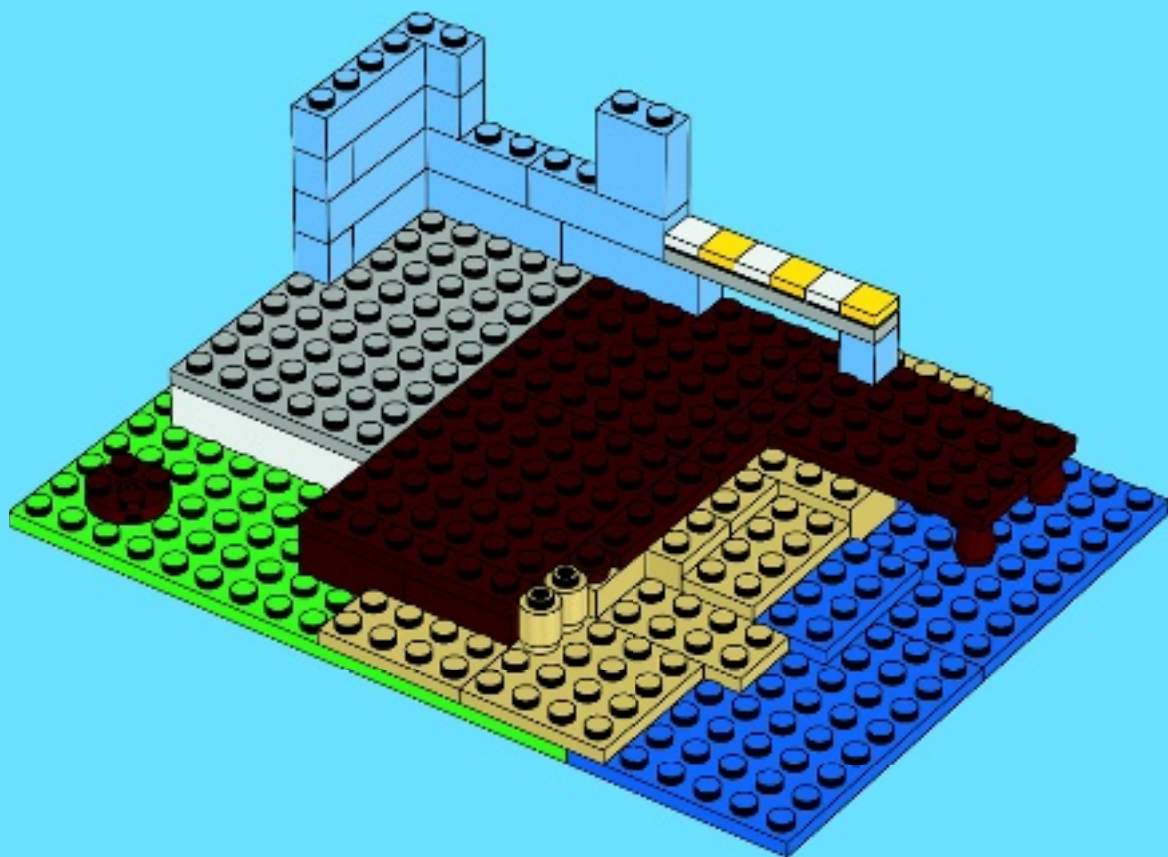

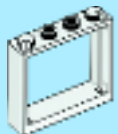

1x



1x

# 17

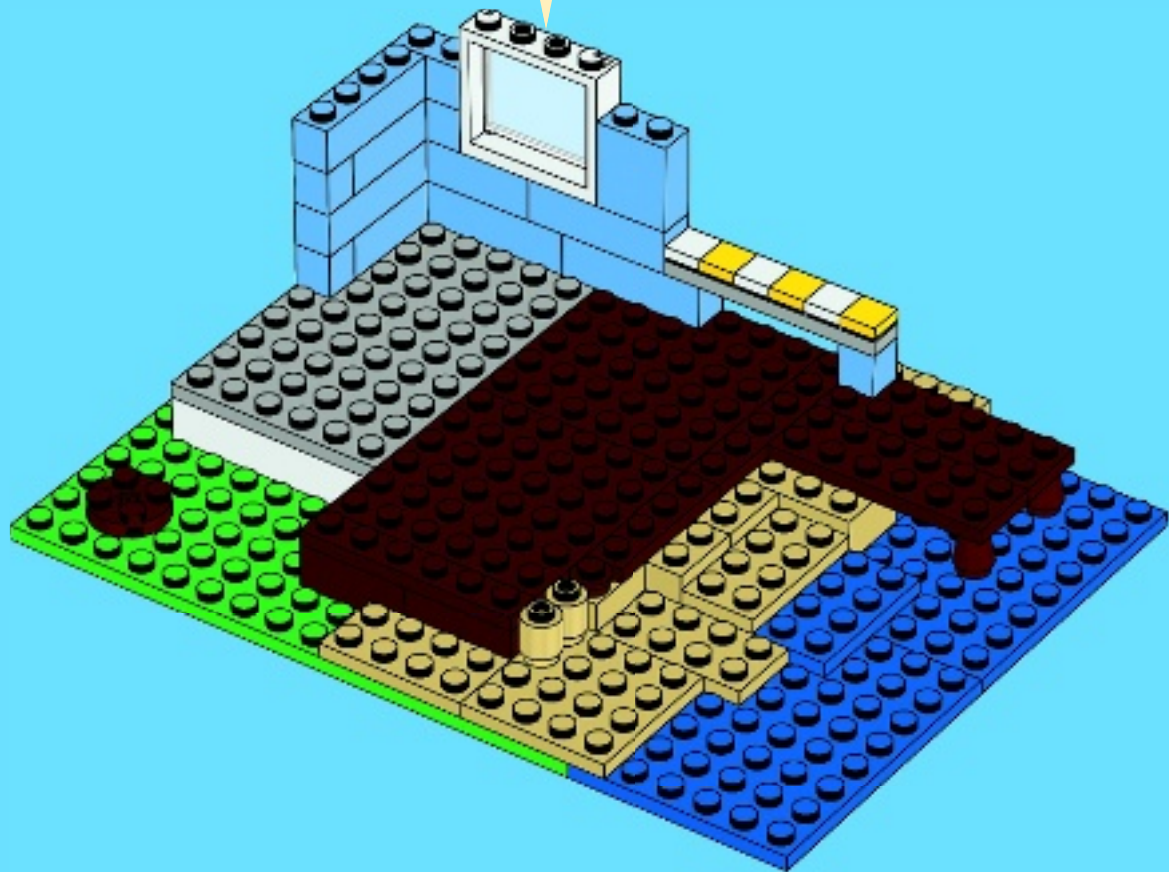
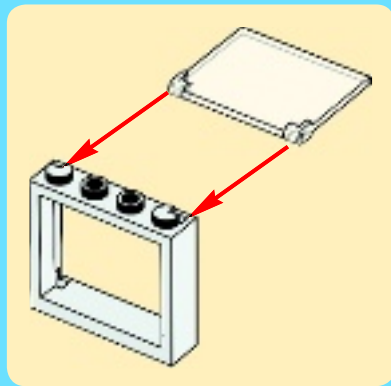



2x



1x



2x

# 18

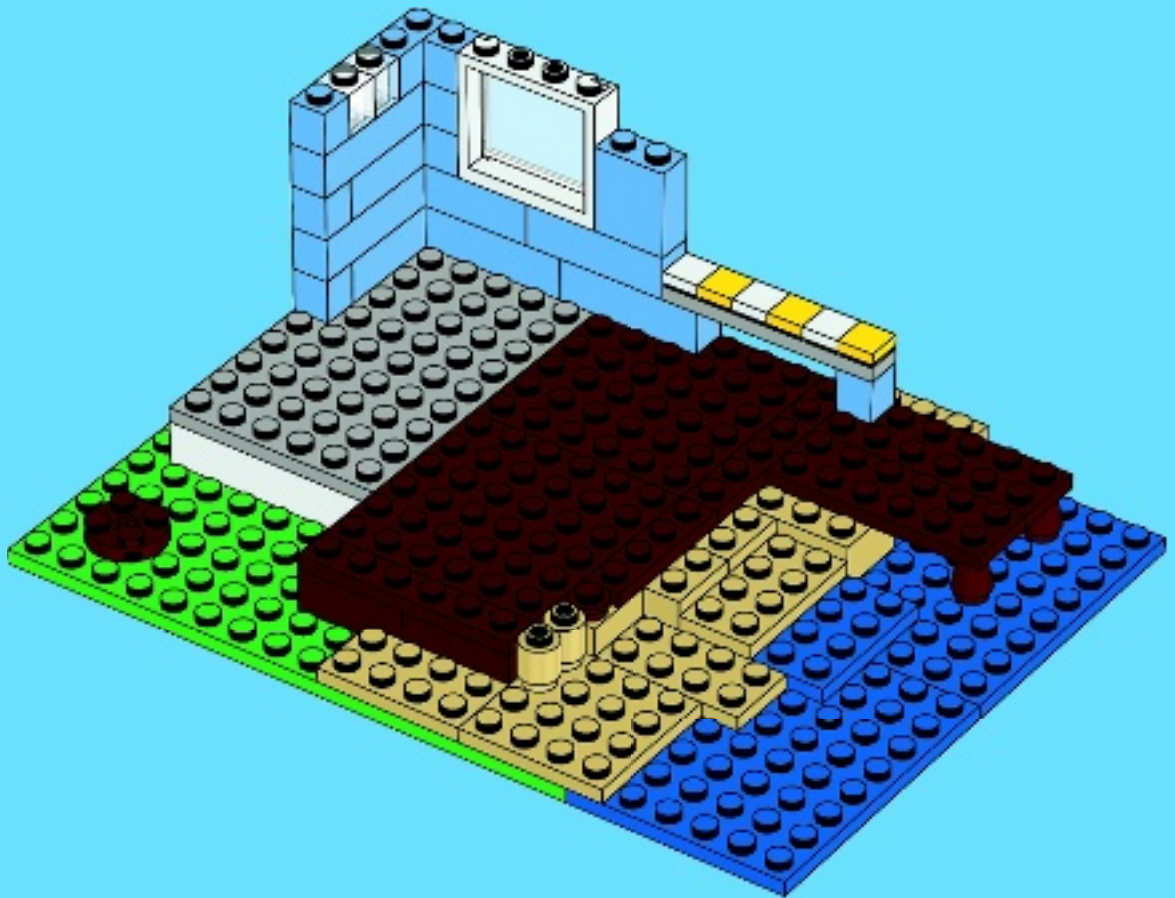





1x



4x



1x

# 19

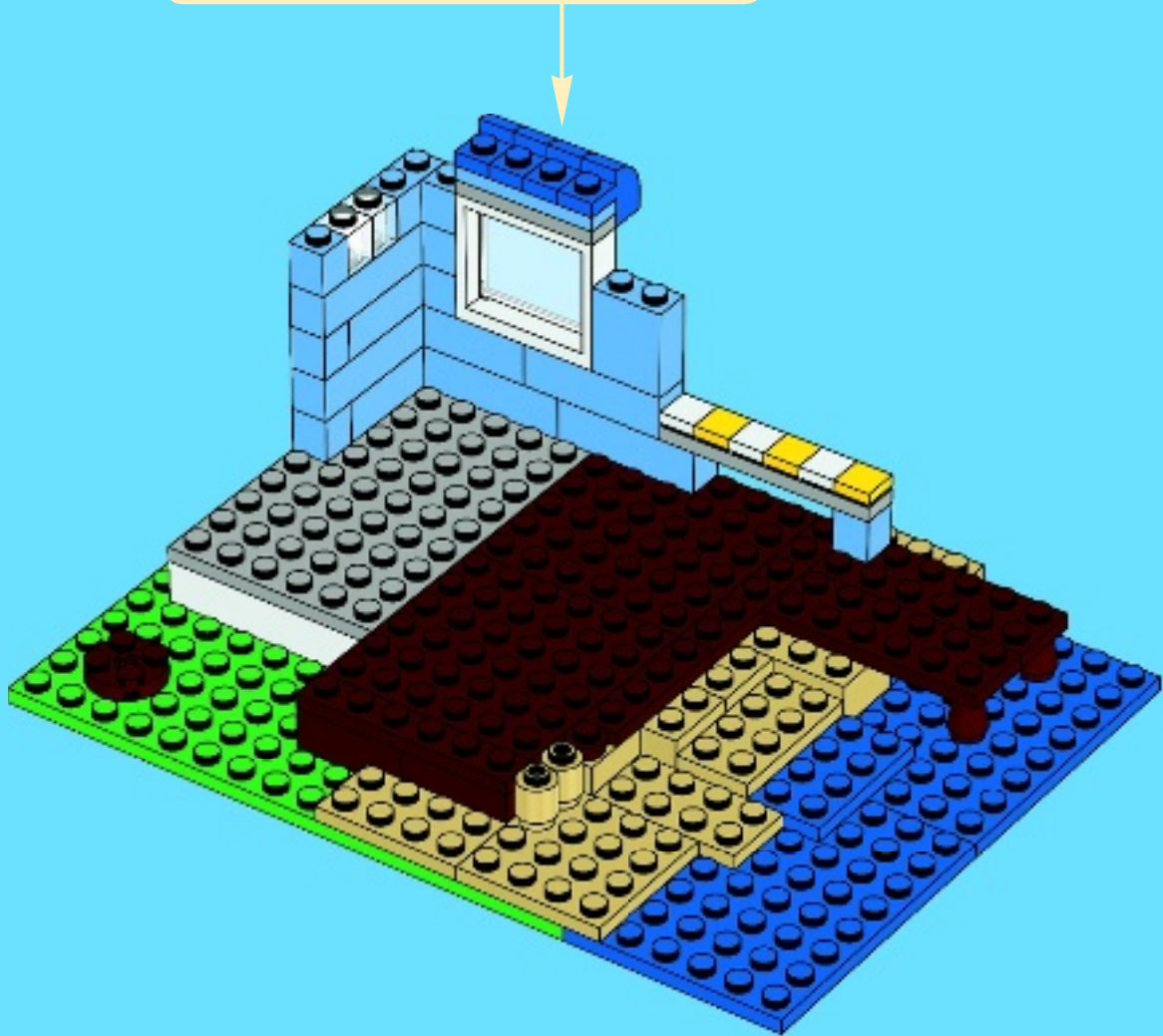
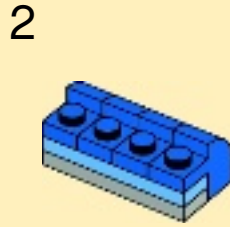
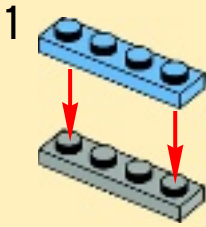



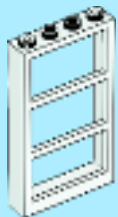

1x



1x

# 21

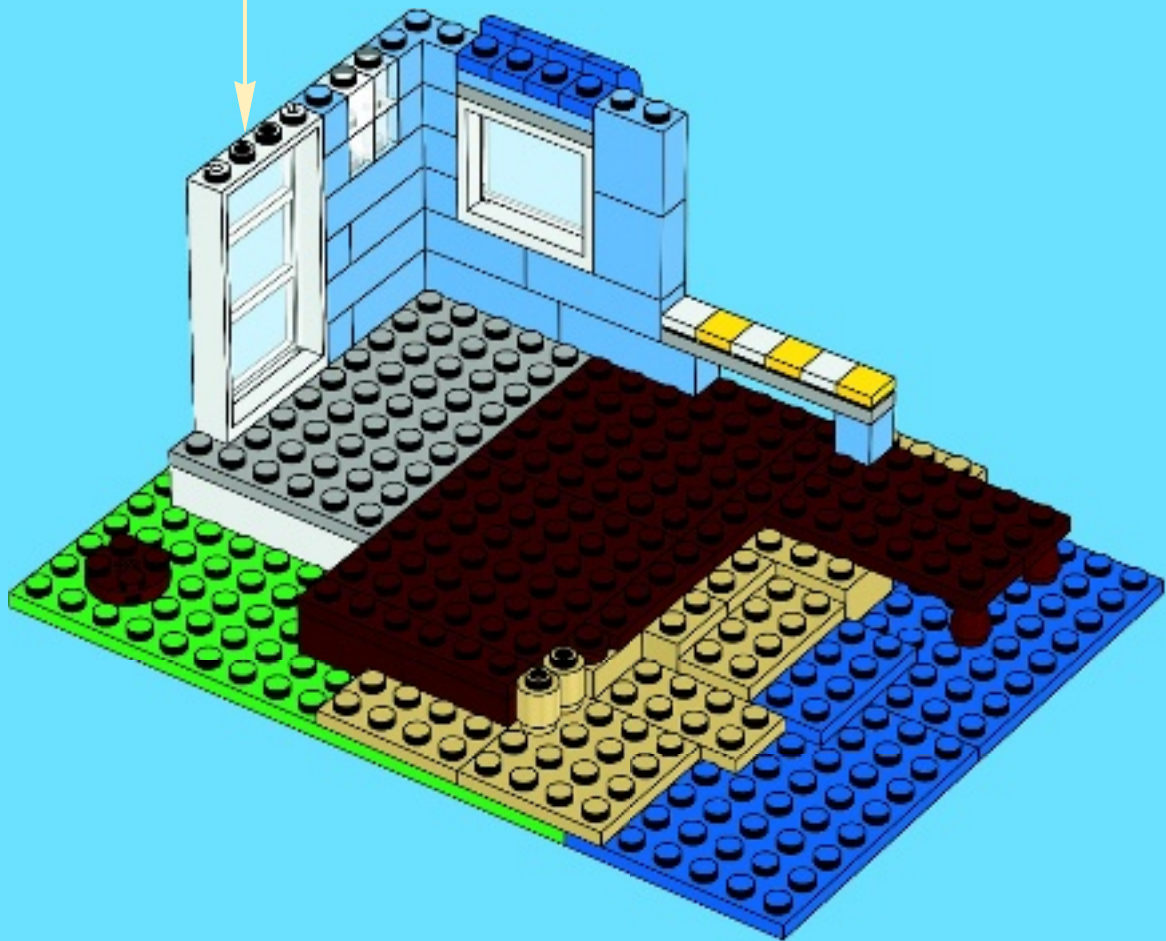
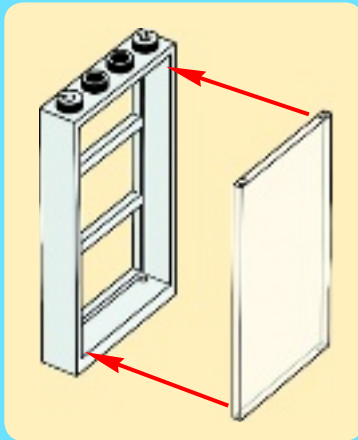





5x



1x

# 22

1



2

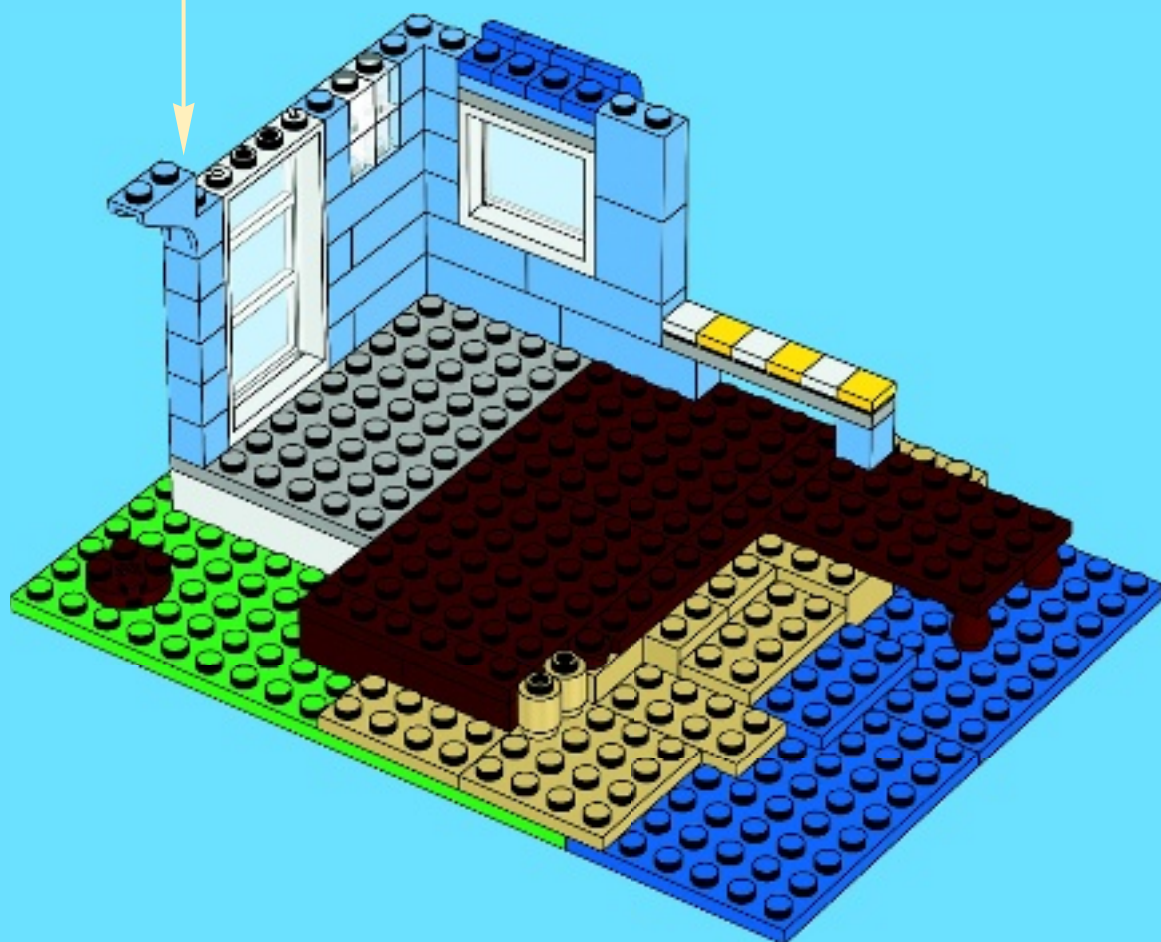
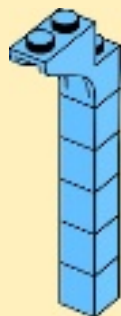

# 23

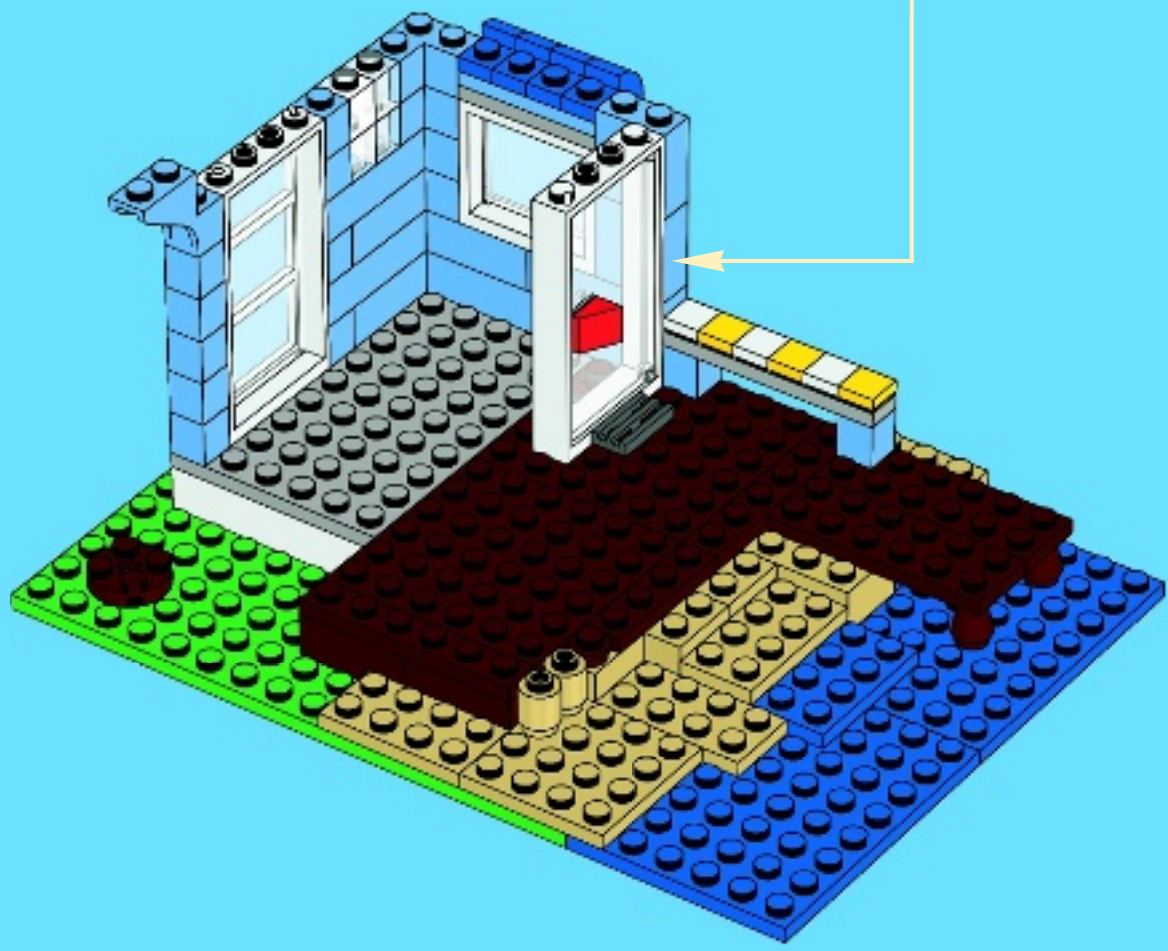
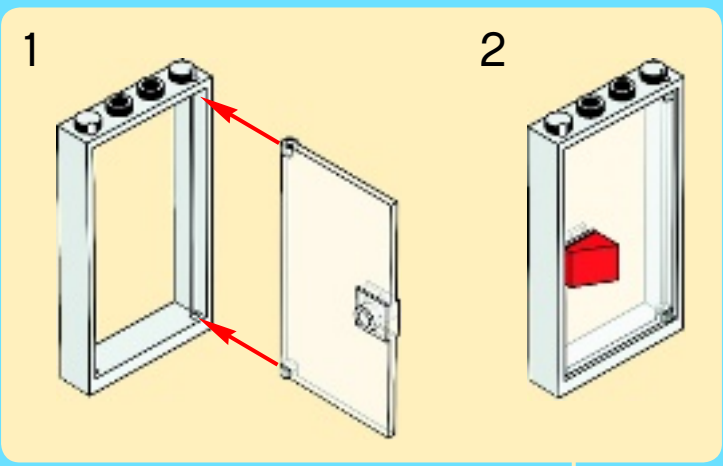
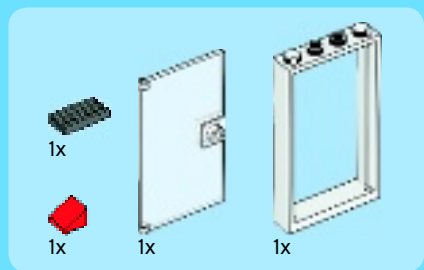

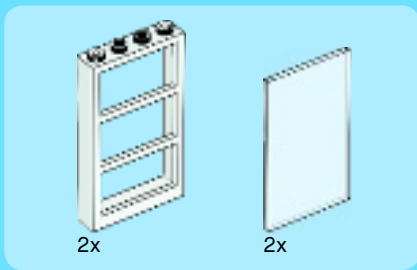

24

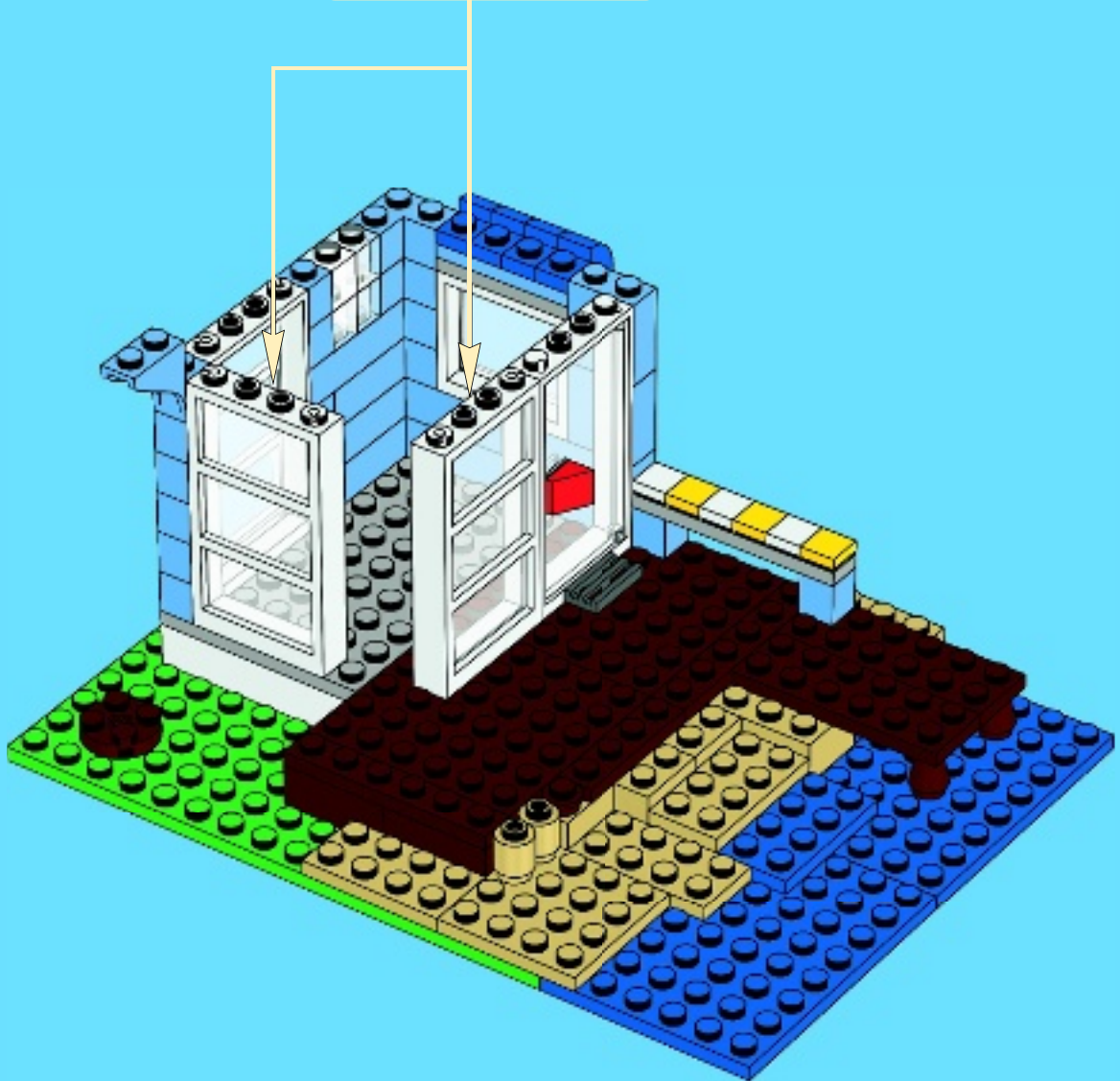
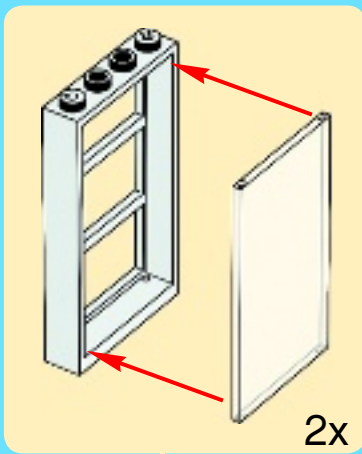





4x



6x



1x

# 25

1

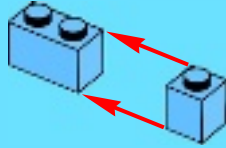

2

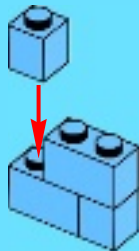

3

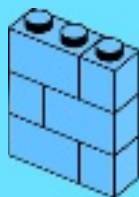

4



5

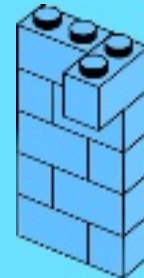

6



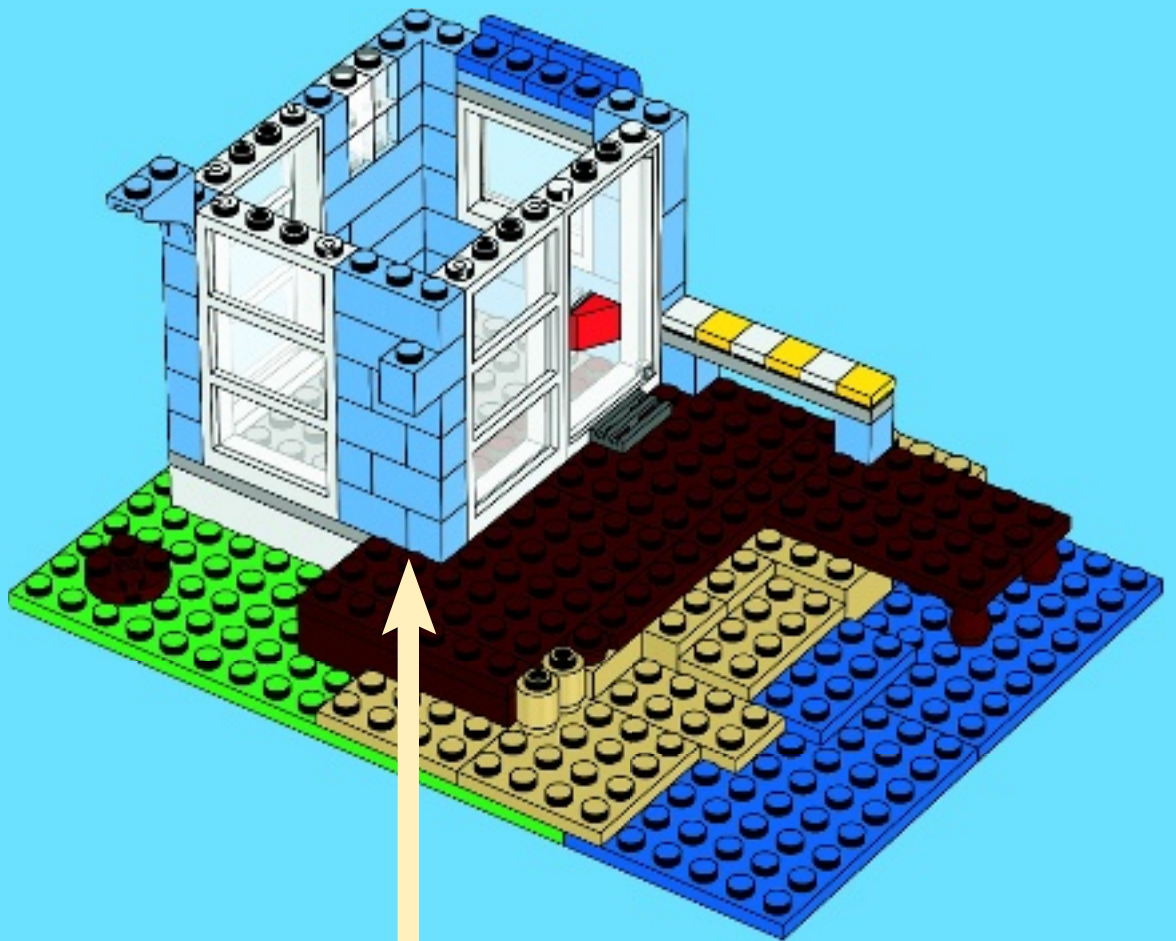



1x



2x



1x

# 26

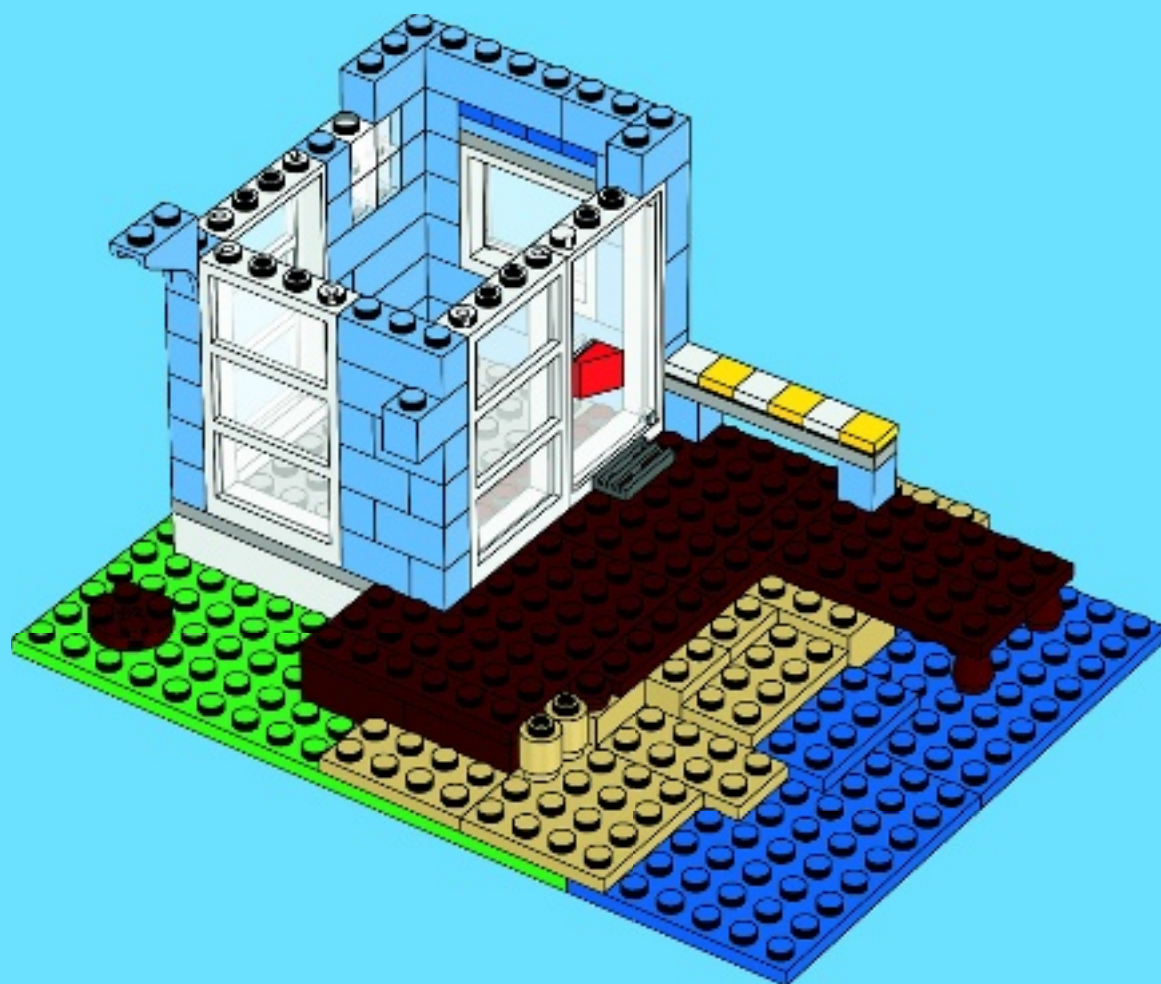





1x



2x



1x



1x



1x

# 27

1

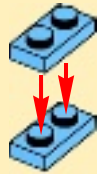

2

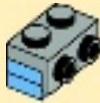

3

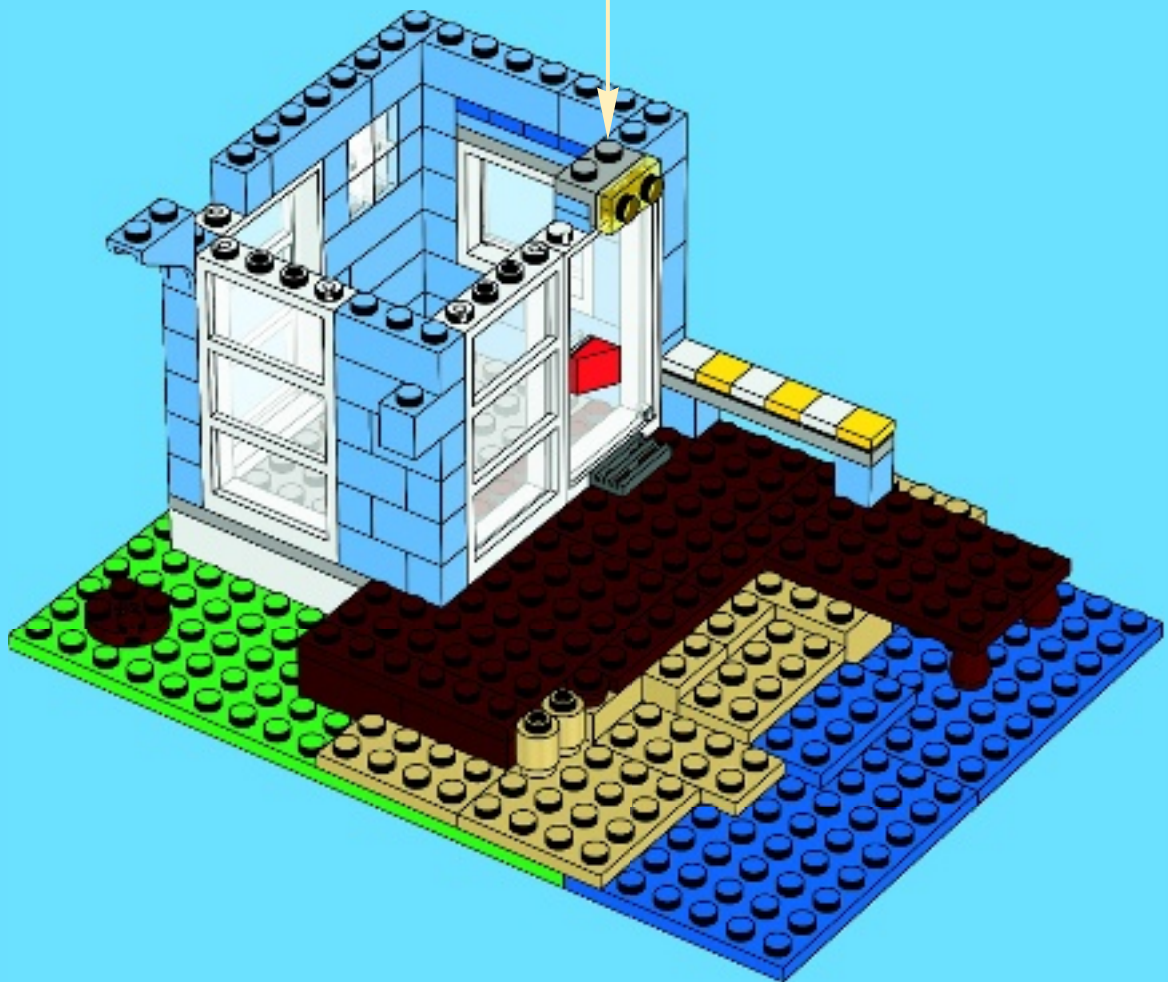



1x



1x



3x

# 28

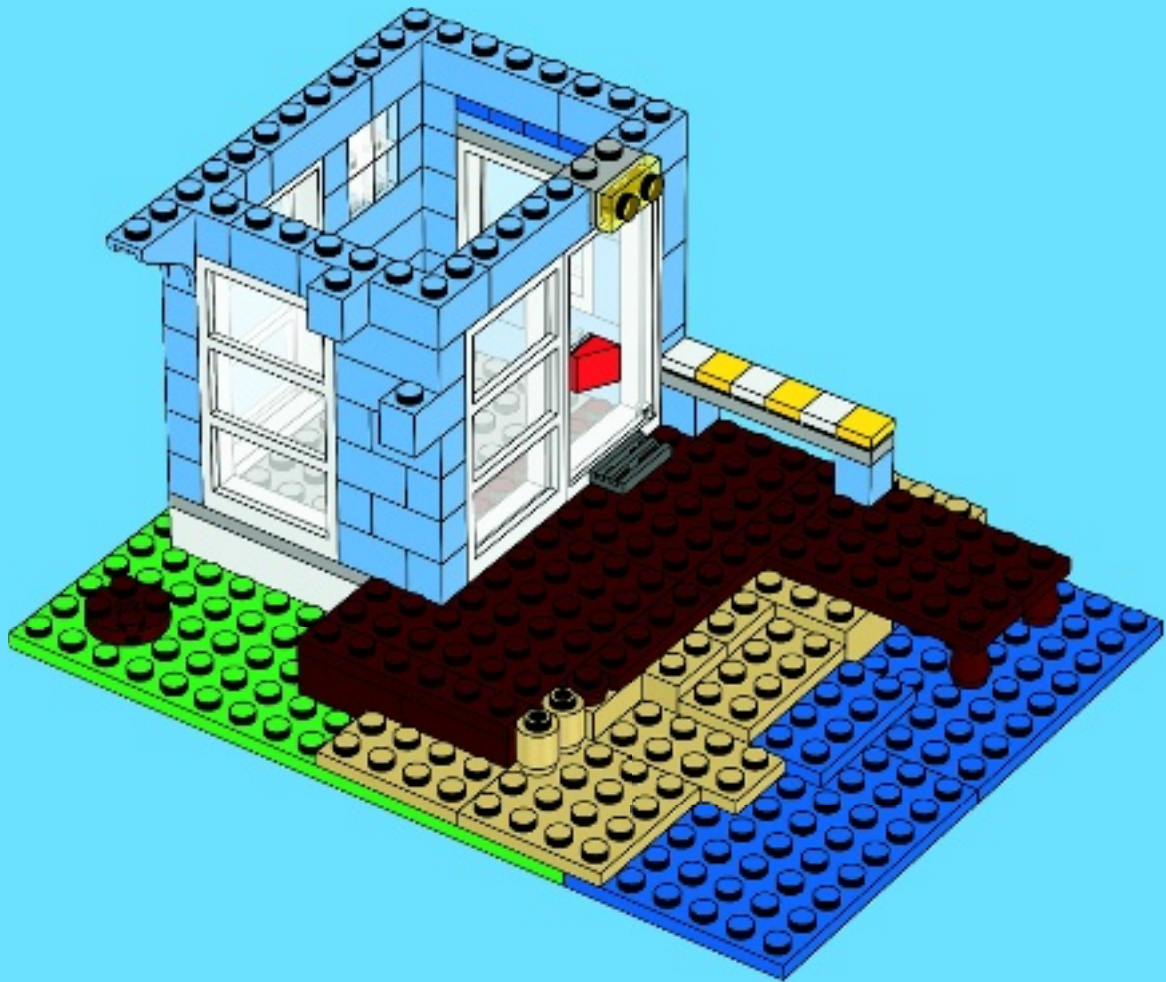

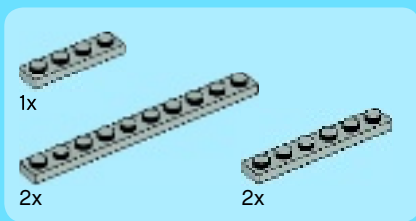

29

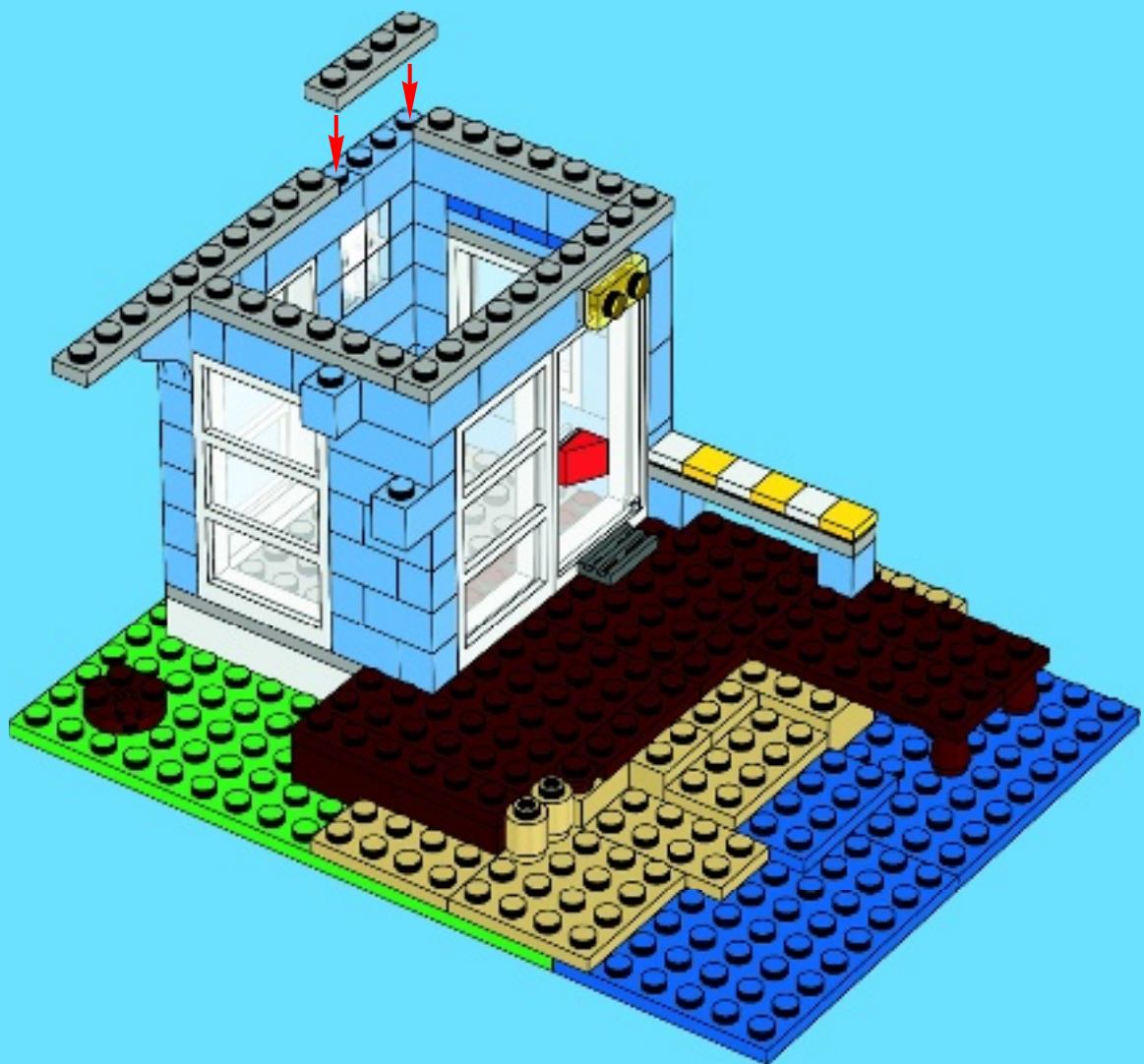





2x



4x



2x

# 30

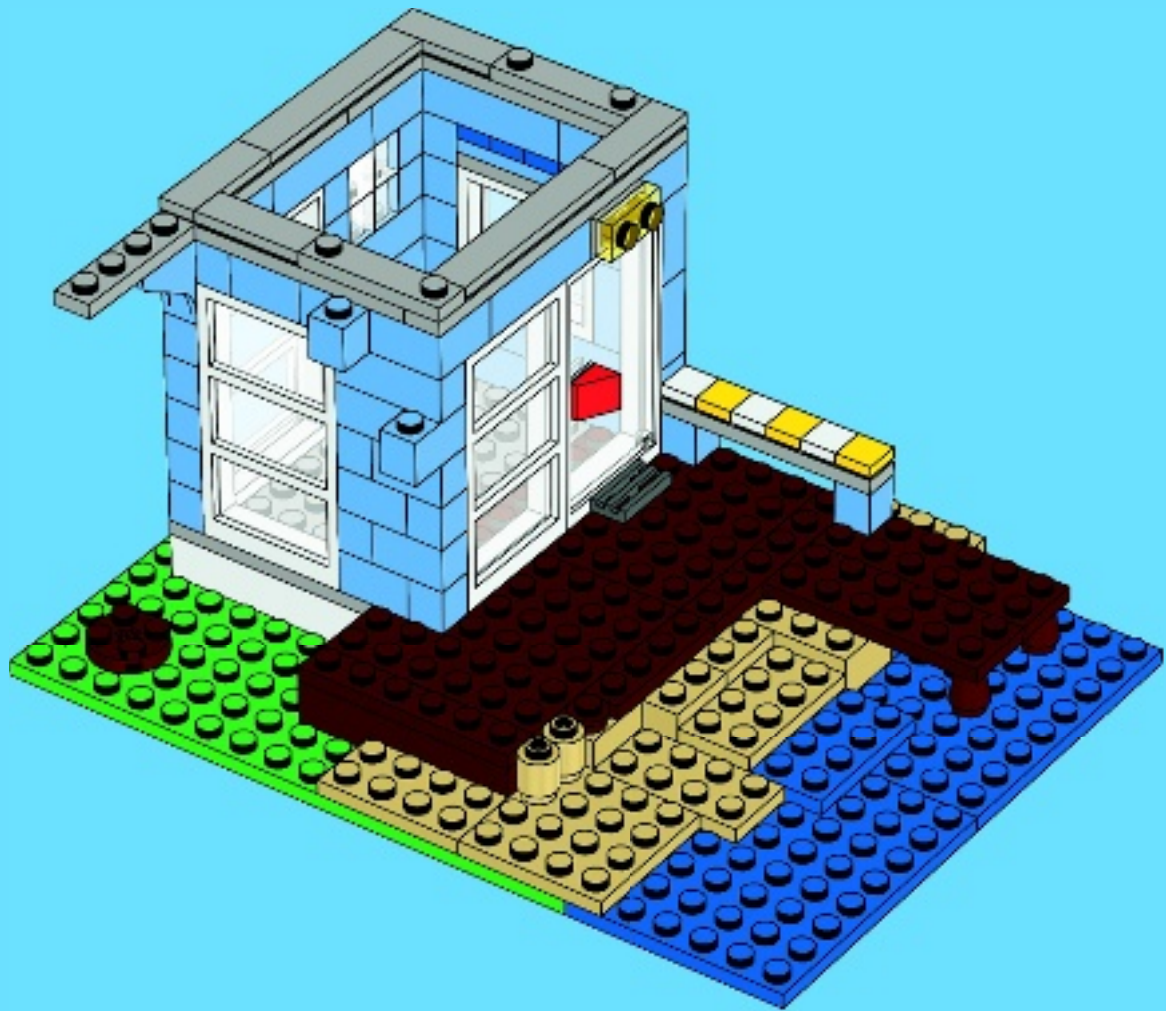



1x



2x



3x

# 31

1



2

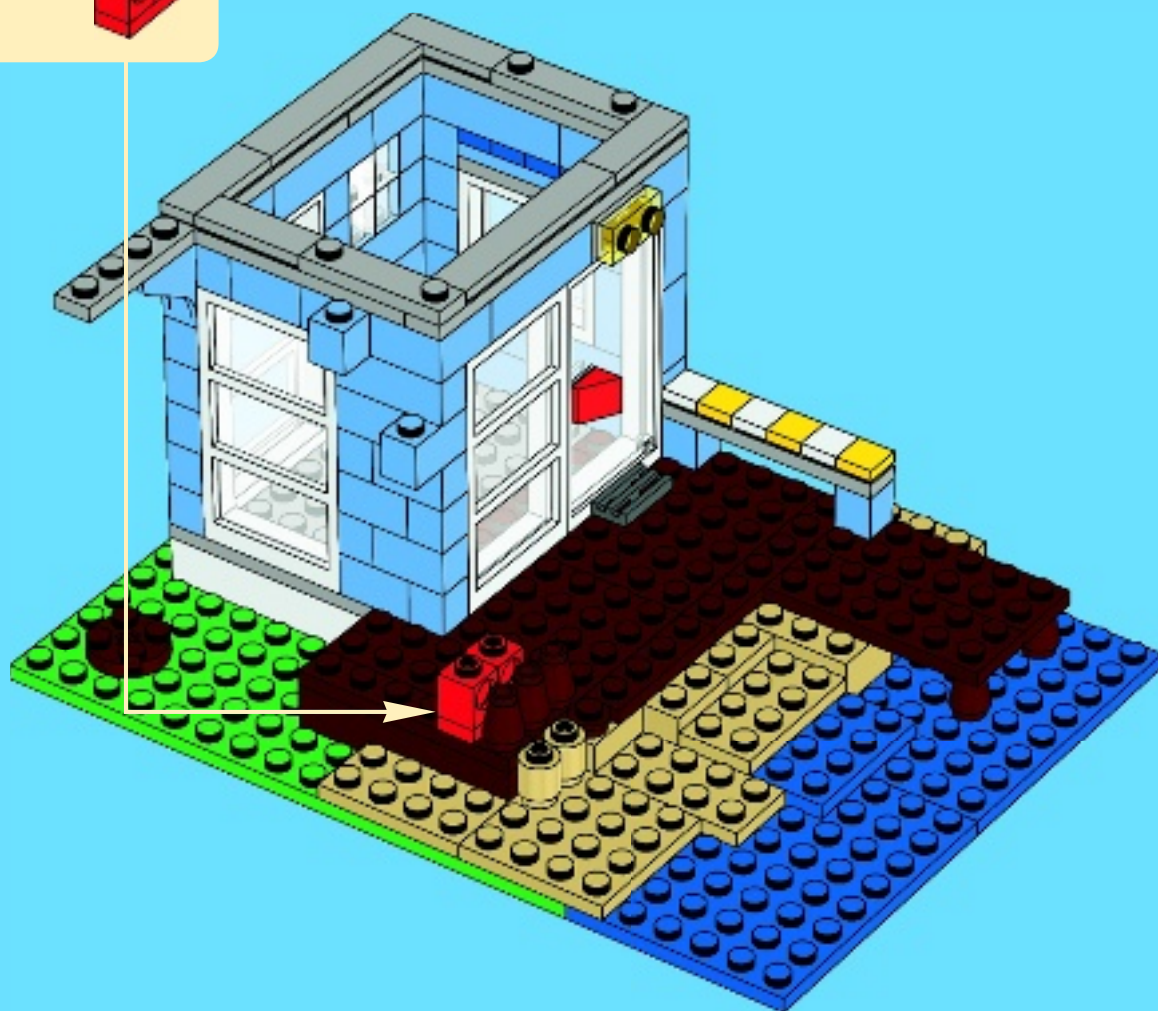

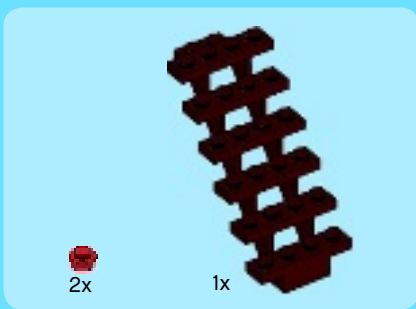

32

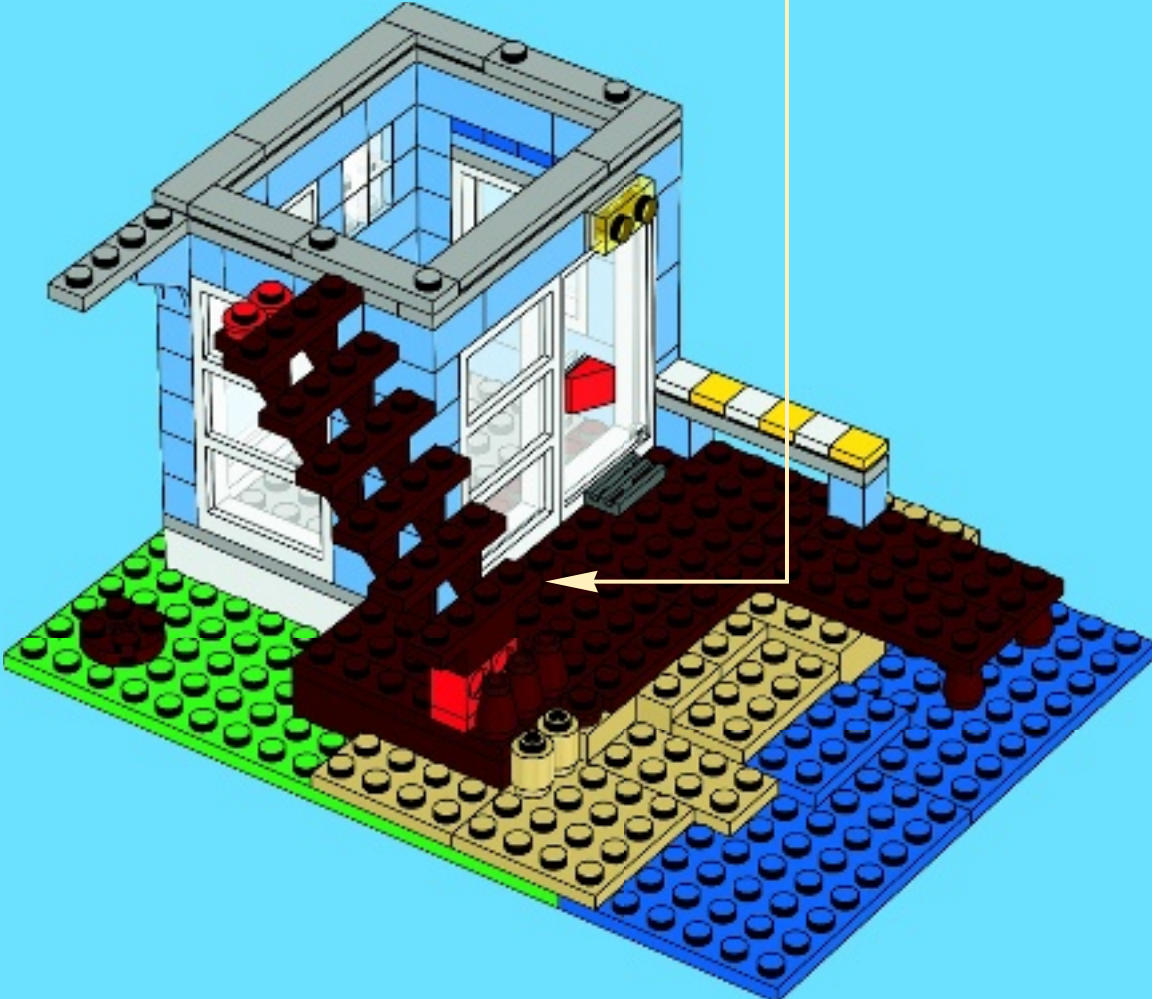
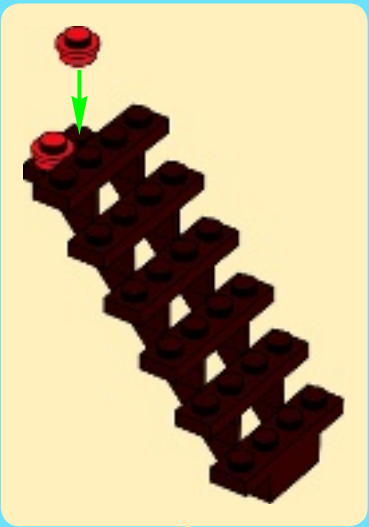





3x



1x

# 33

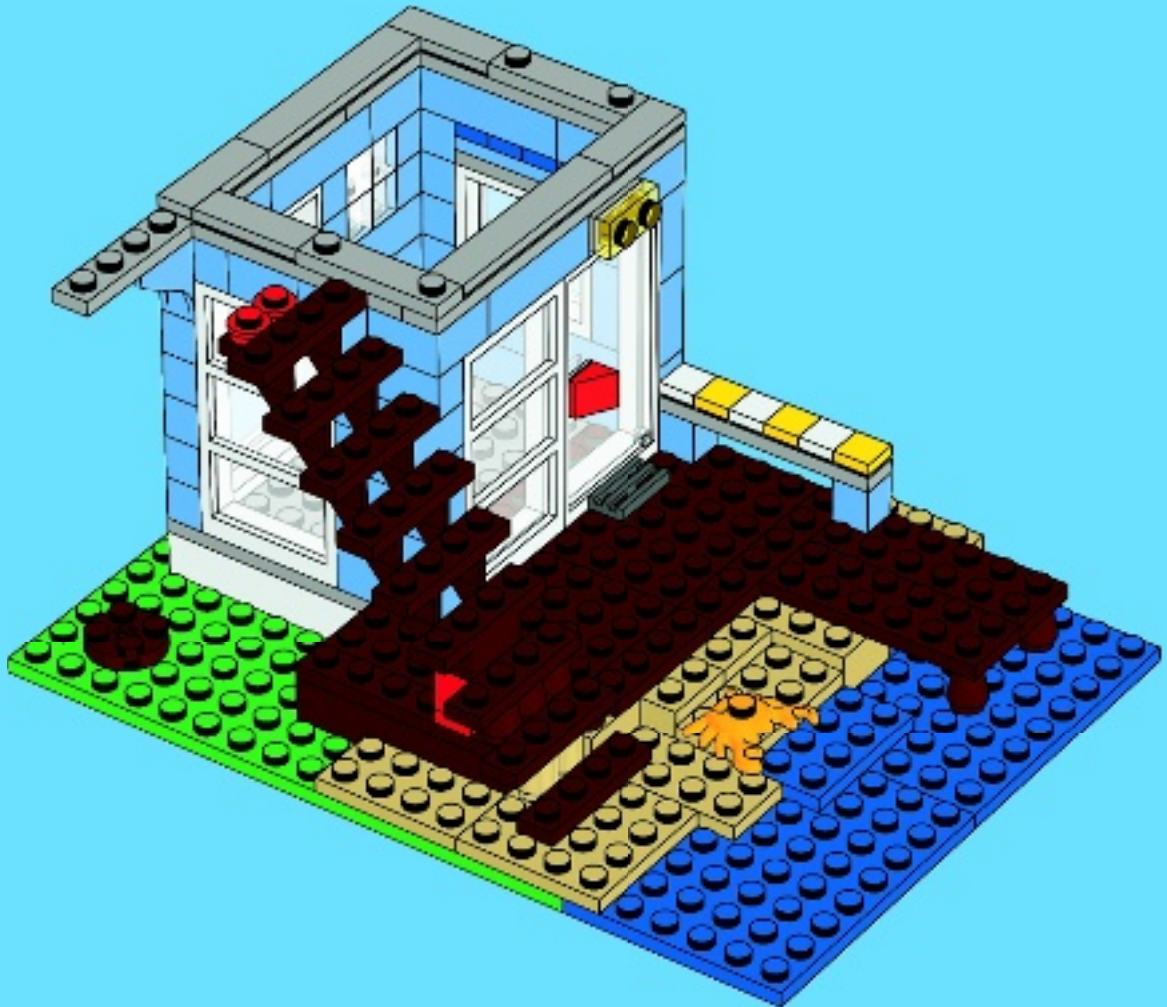



34

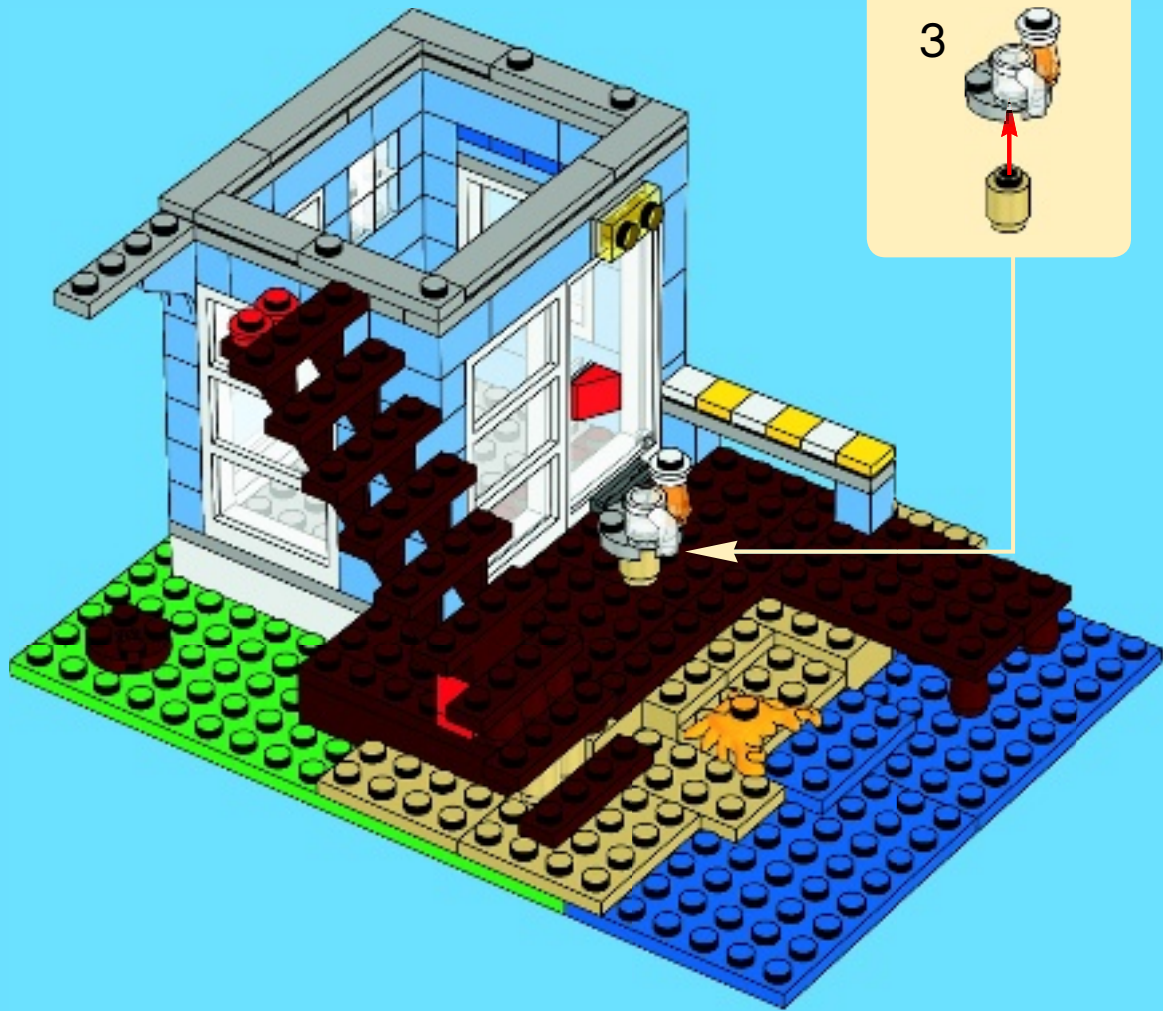

1

2

3

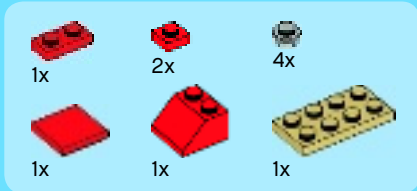

# 35



1

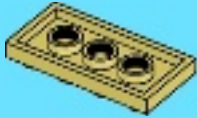

2

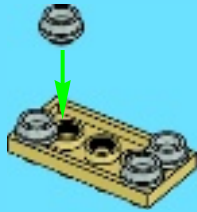

3

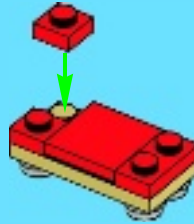

4

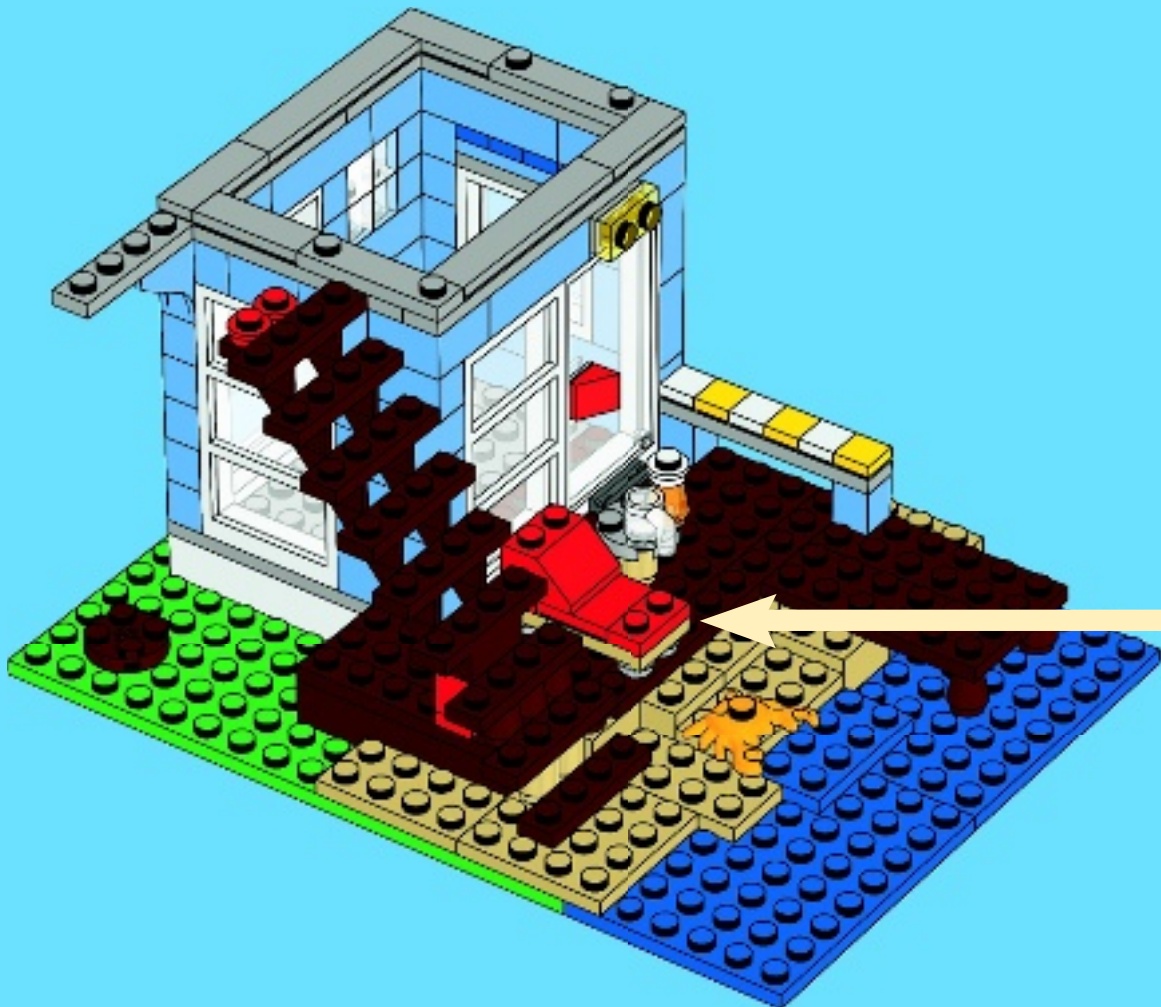



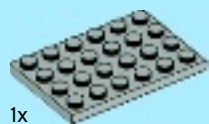

1x

# 36

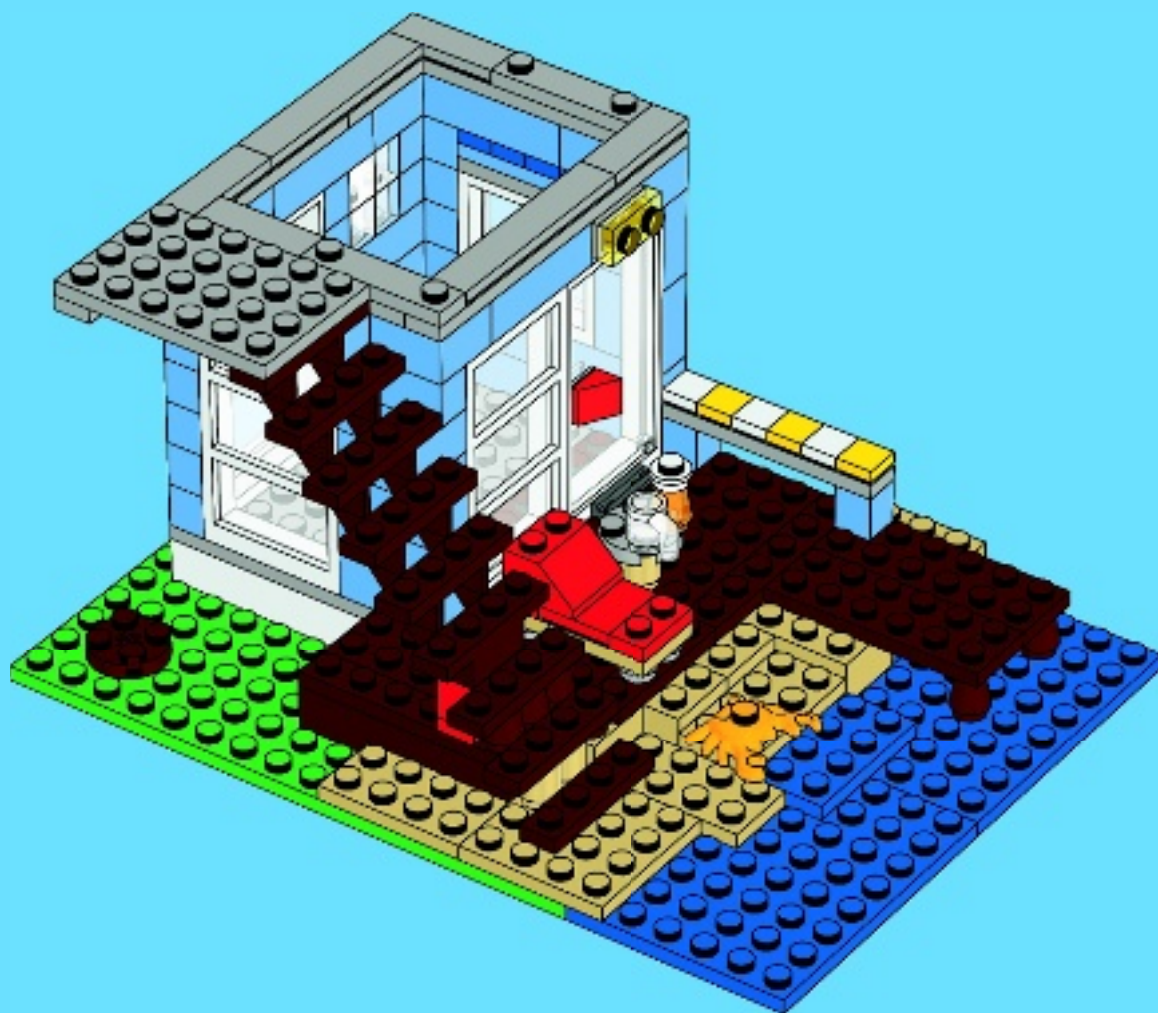



1x



2x

# 37

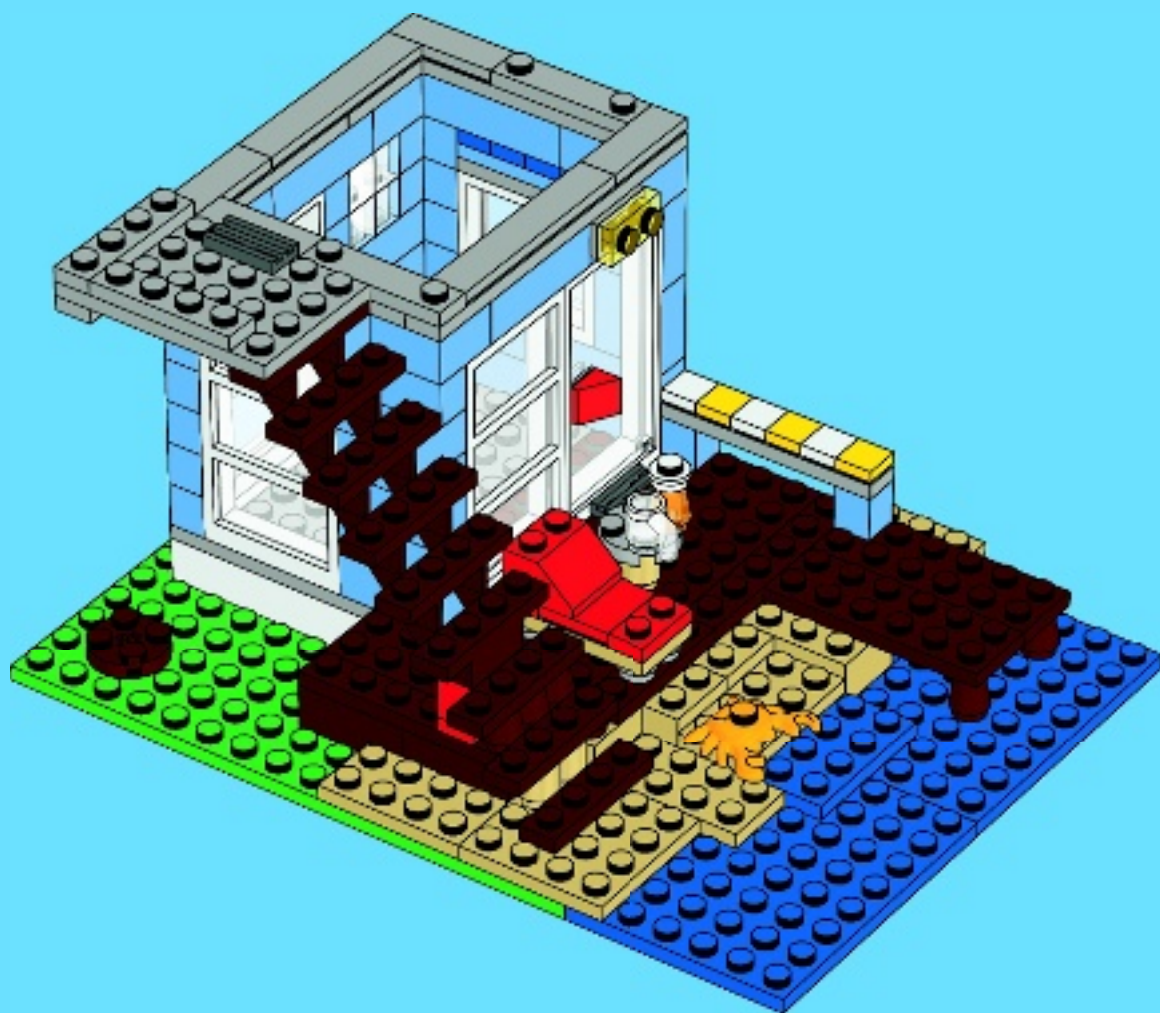

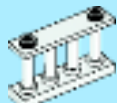

2x

# 38

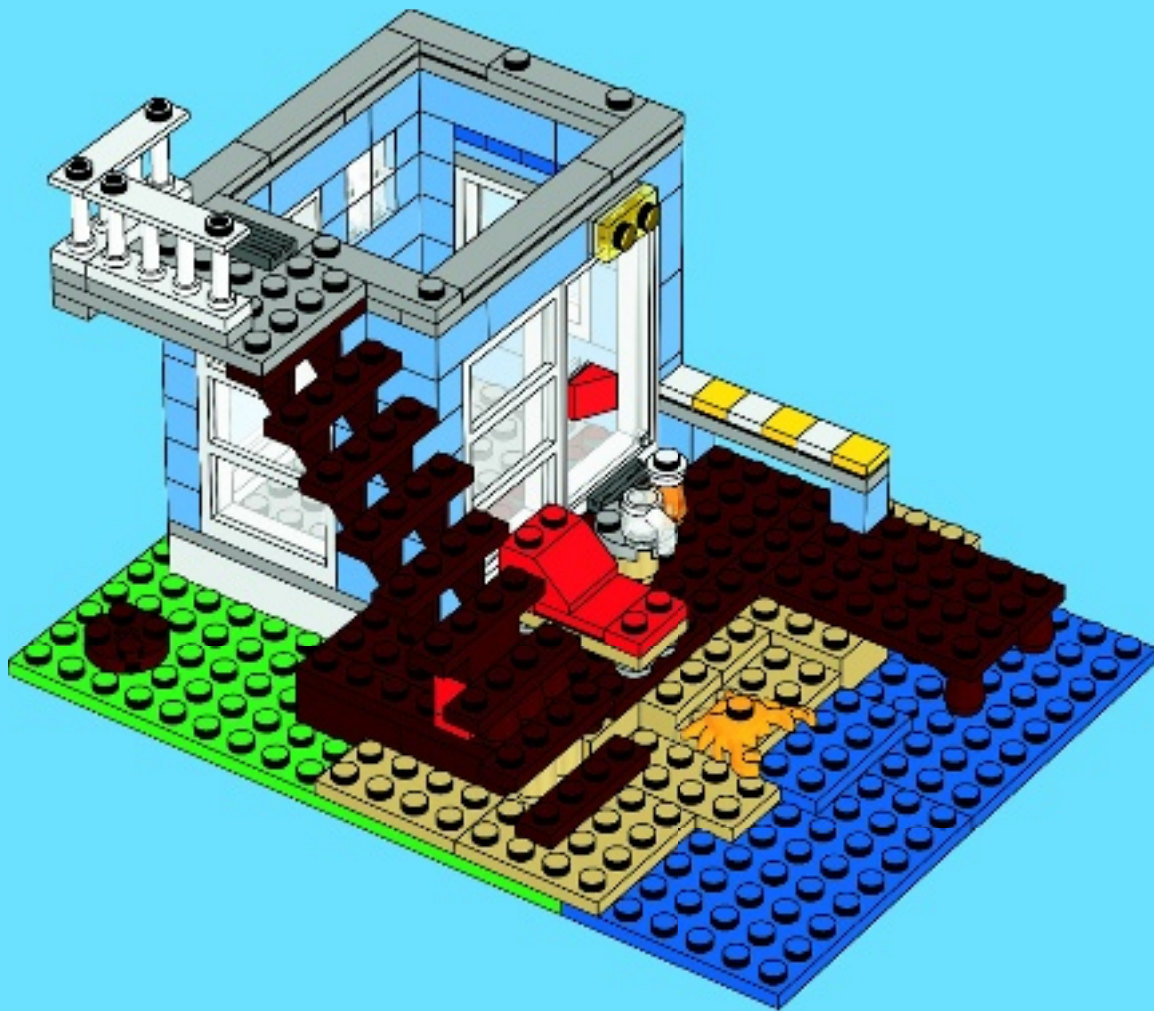





1x

1x

1



4x

4x

2

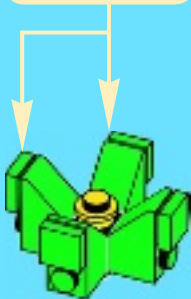
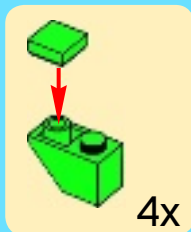

1x

1x

4x

3

1



2



3

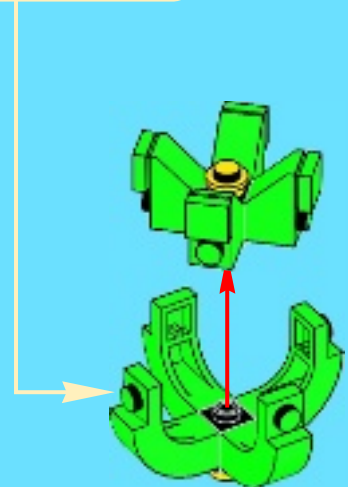
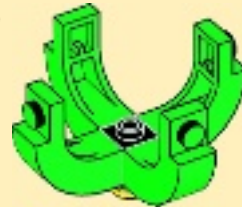



4



39

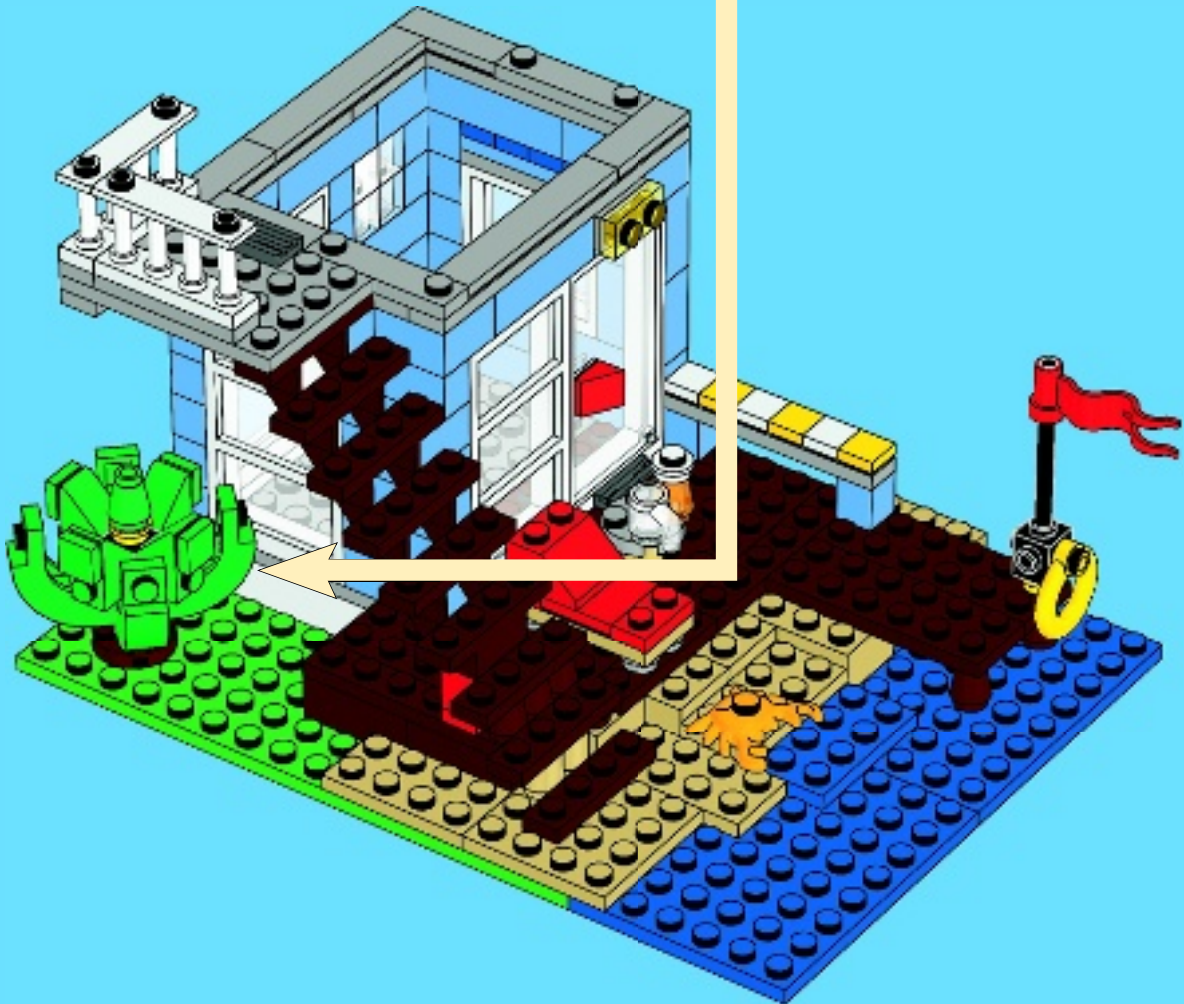

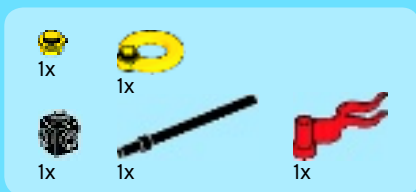

40

1



2



3



4

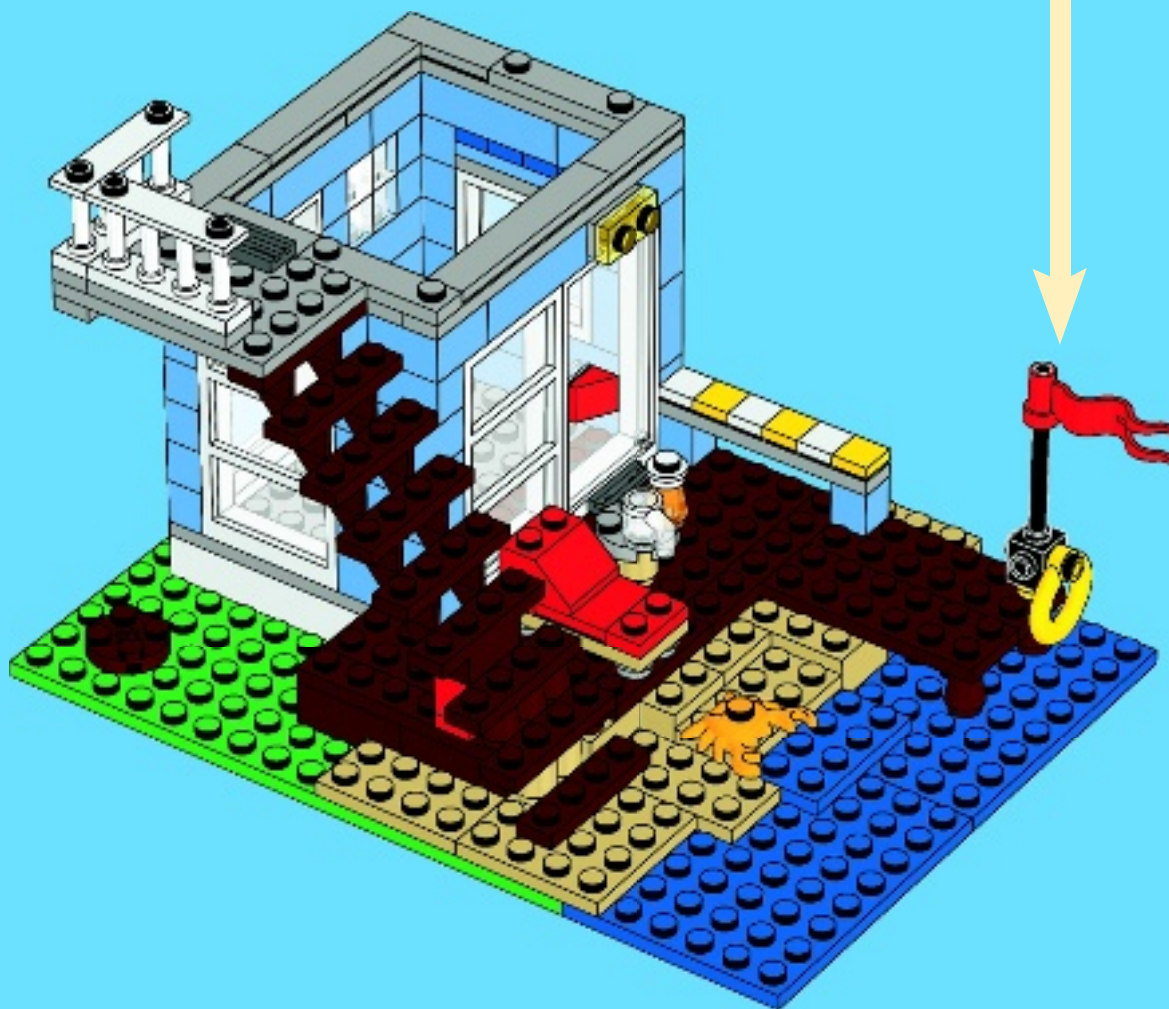
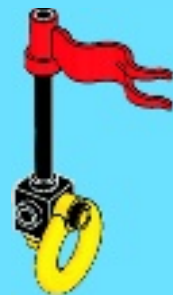



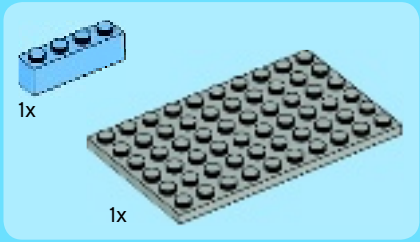

1

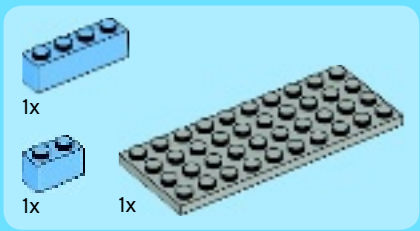
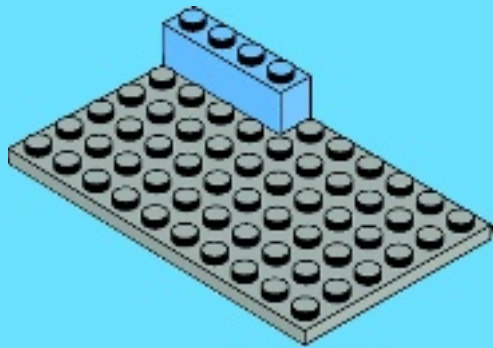

2

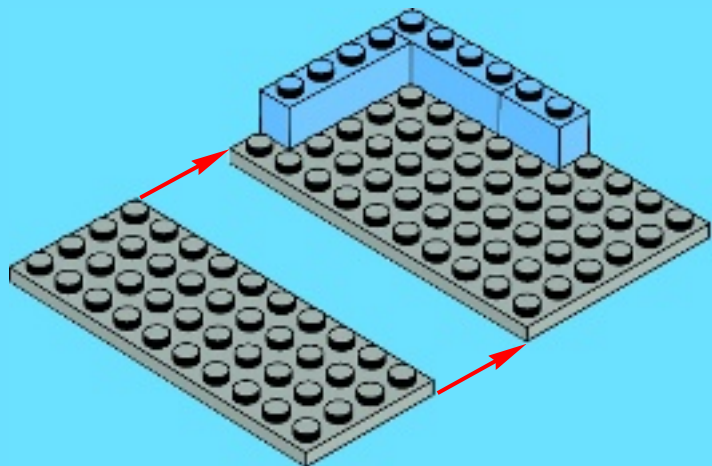



1x



1x

3

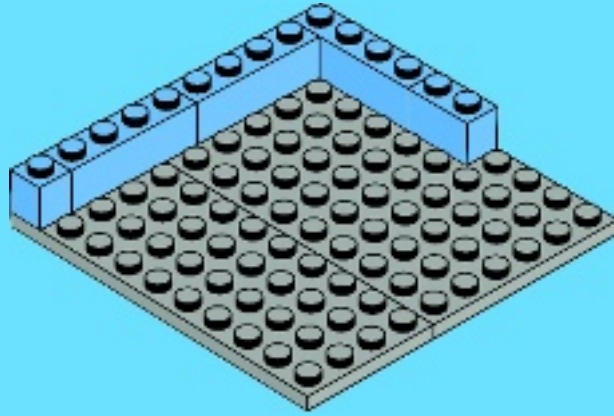

3x



1x



1x

4

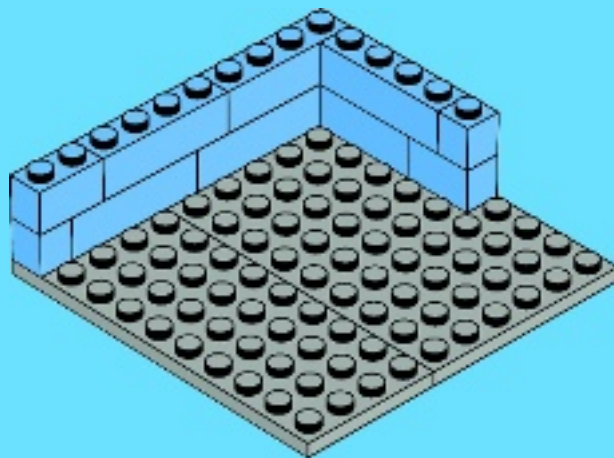



2x



1x



1x

# 5

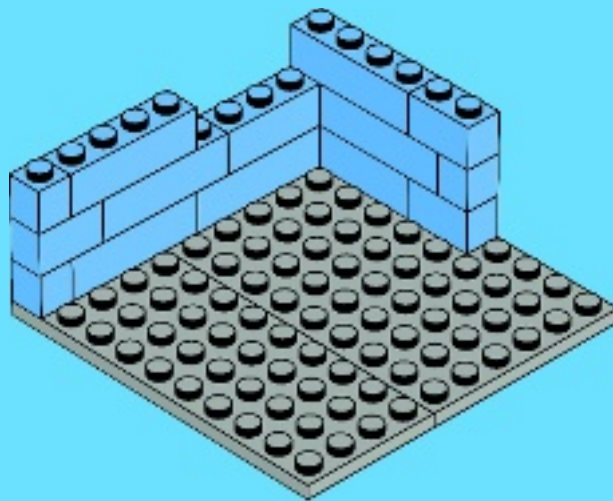

1x



2x



1x



1x

# 6

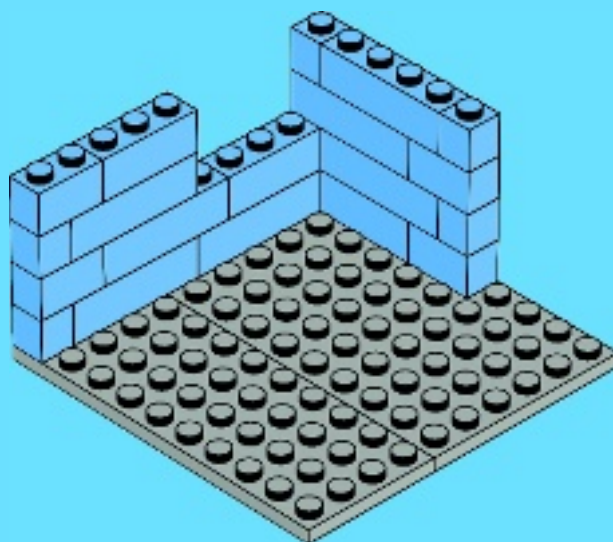



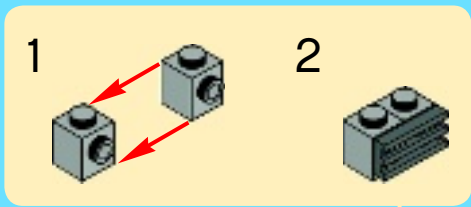

7

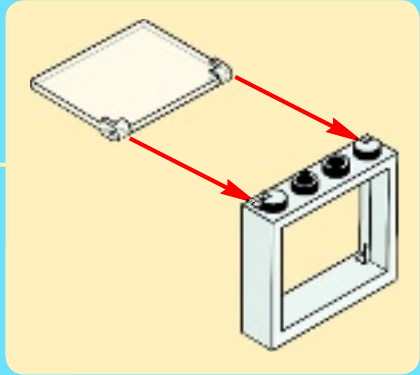
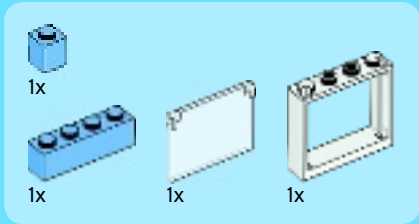
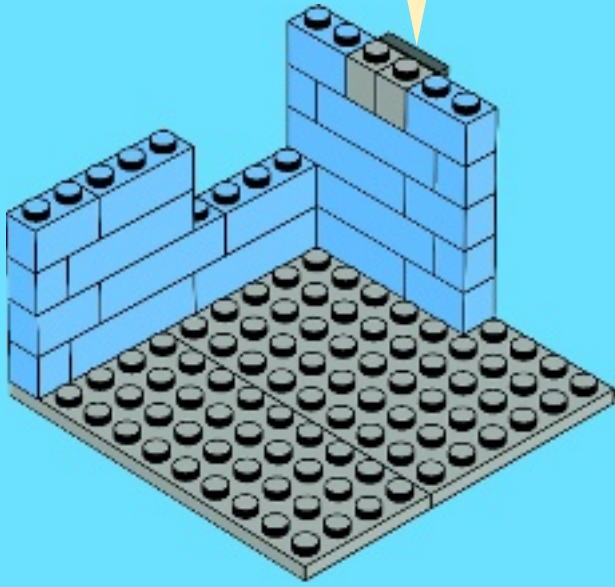

8





1x



3x



1x

9

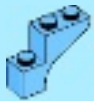
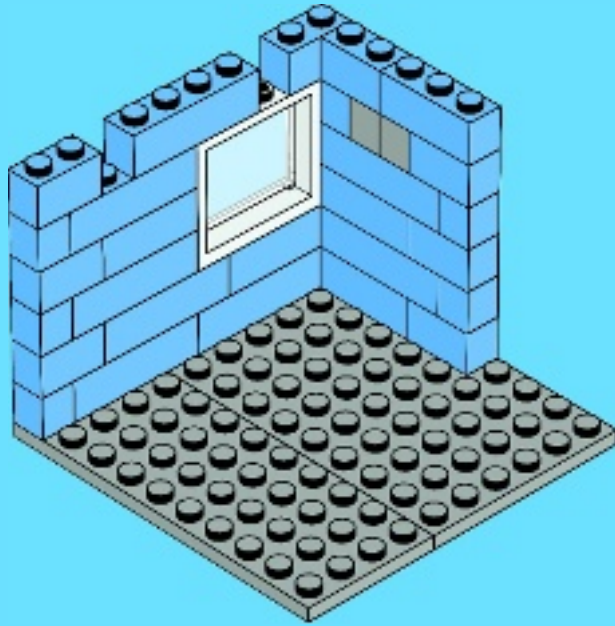

2x

10

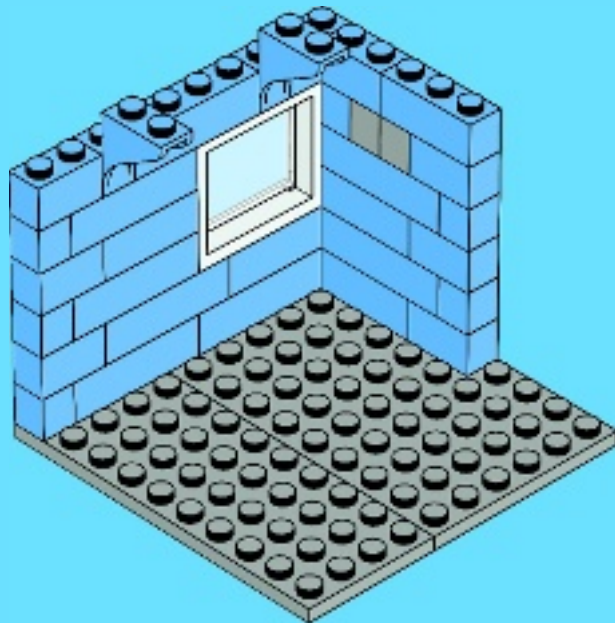

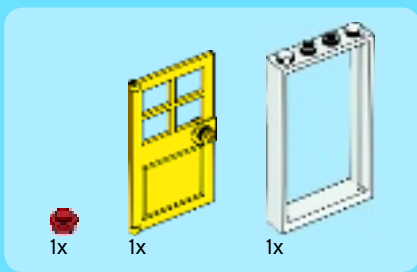

11

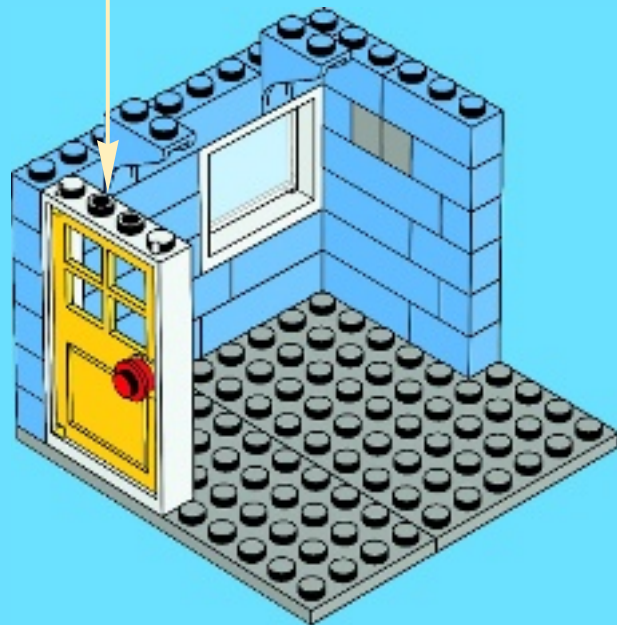
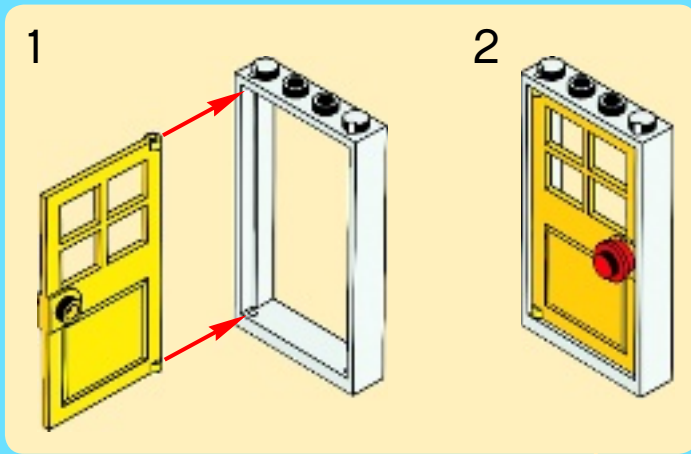





6x

12

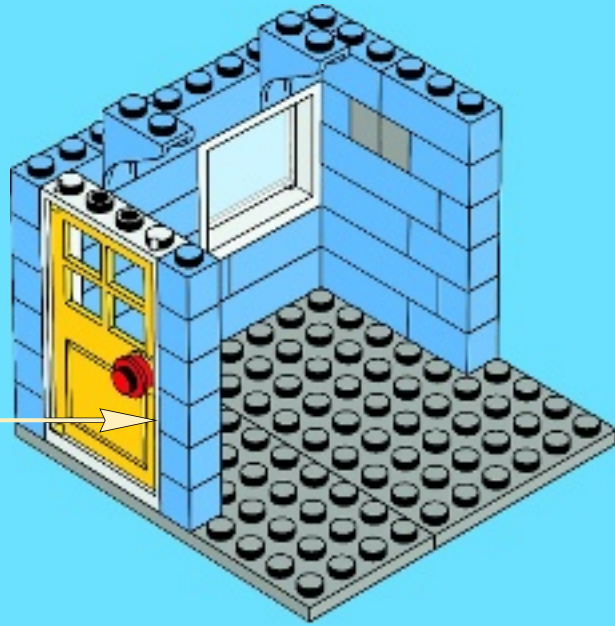
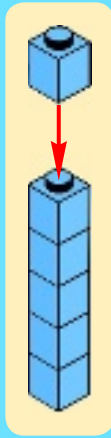

6x

13

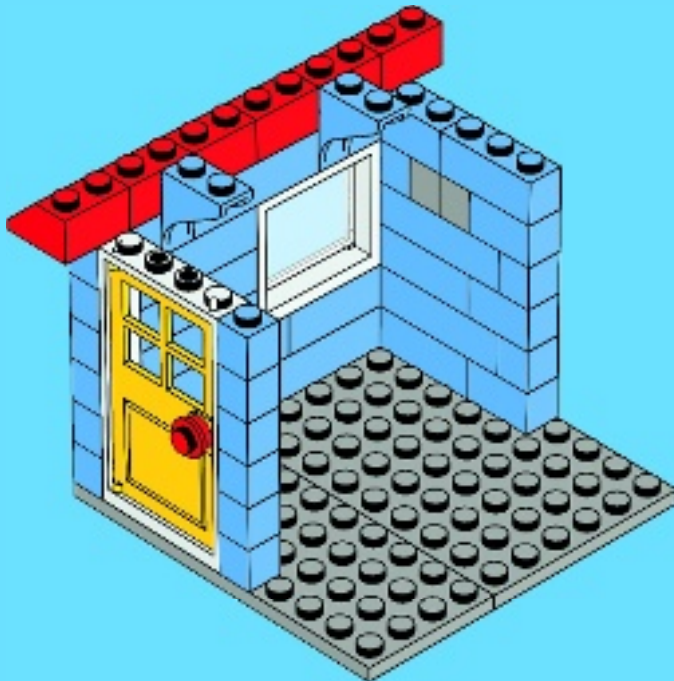

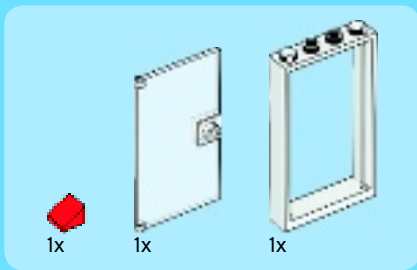

14

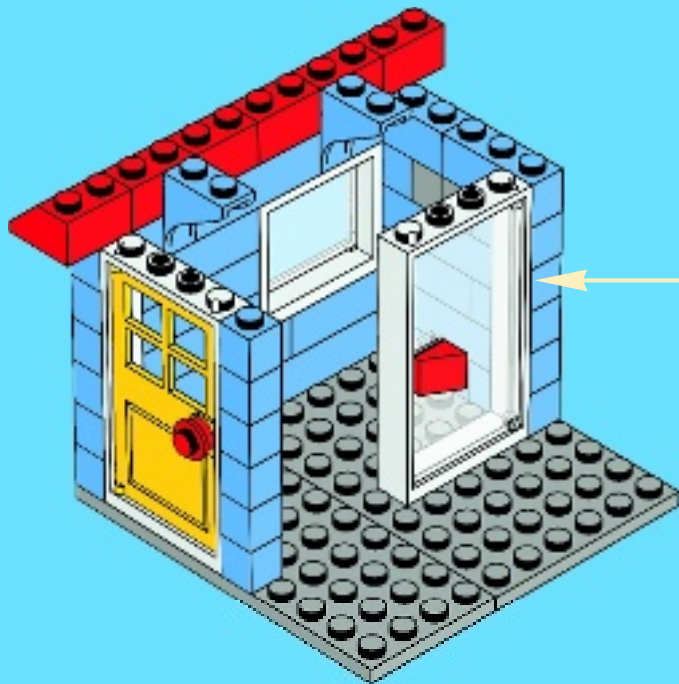
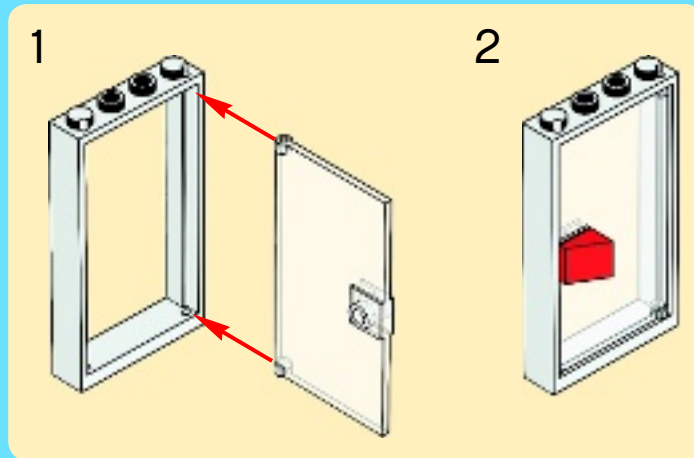

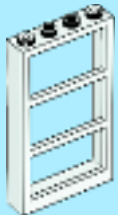

1x



1x

15

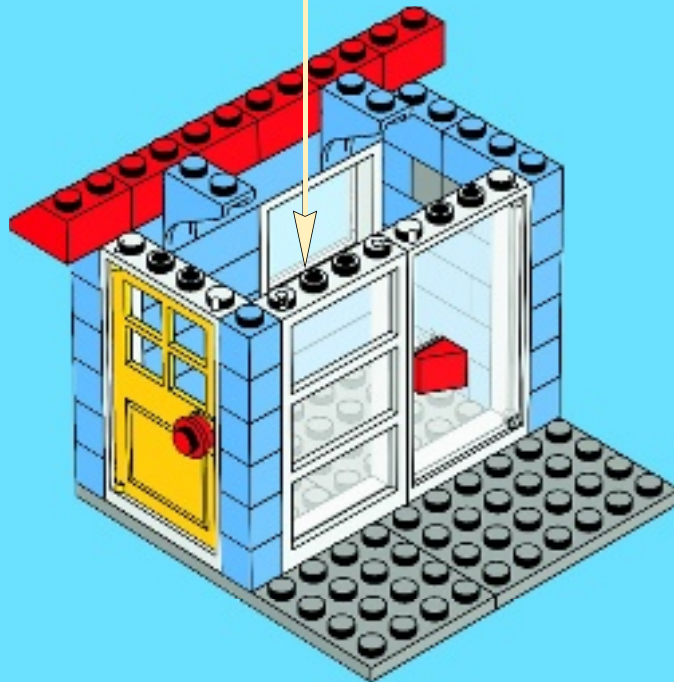
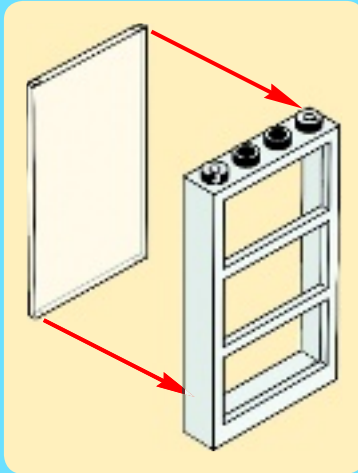



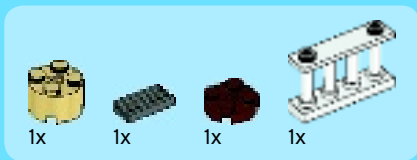

16

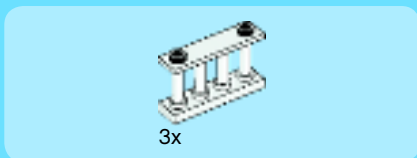
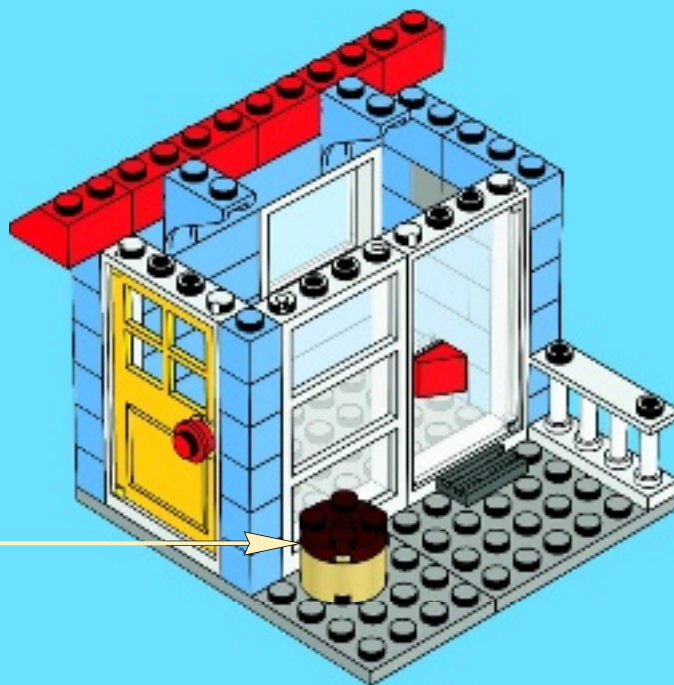
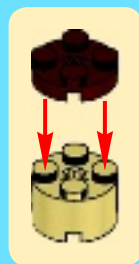

17

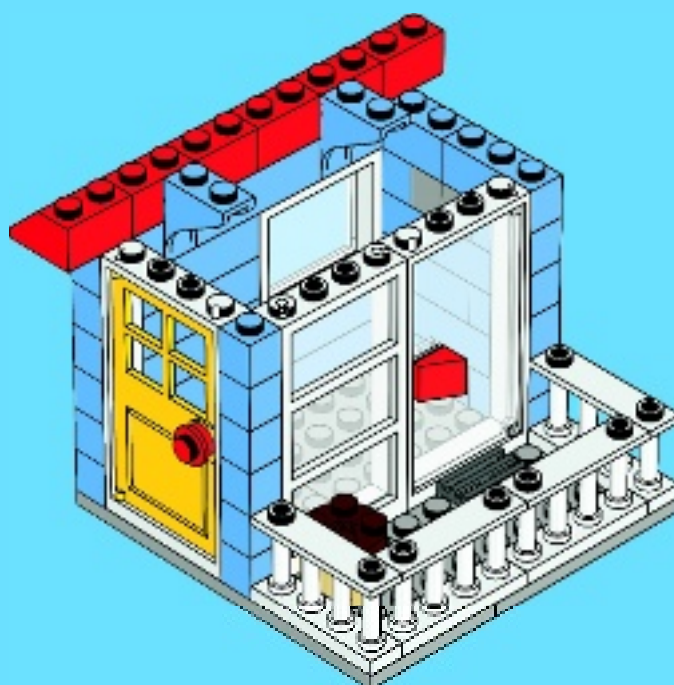



1x



2x

# 18

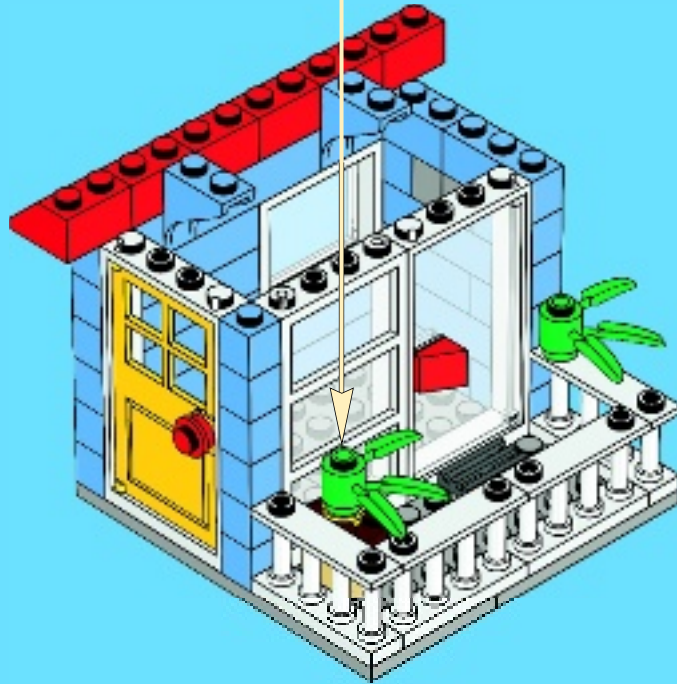
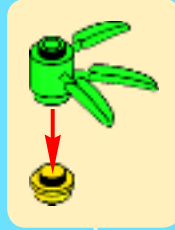



1x



2x



3x



1x



2x



1x

# 19

1

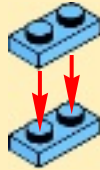

2



3

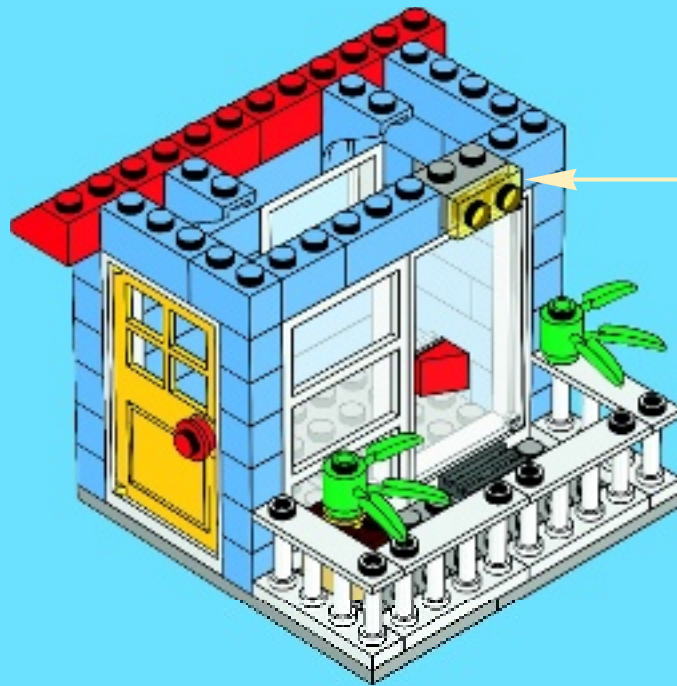



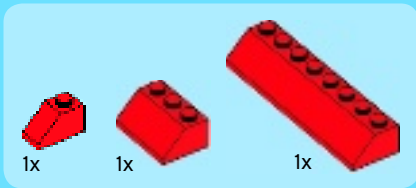

20

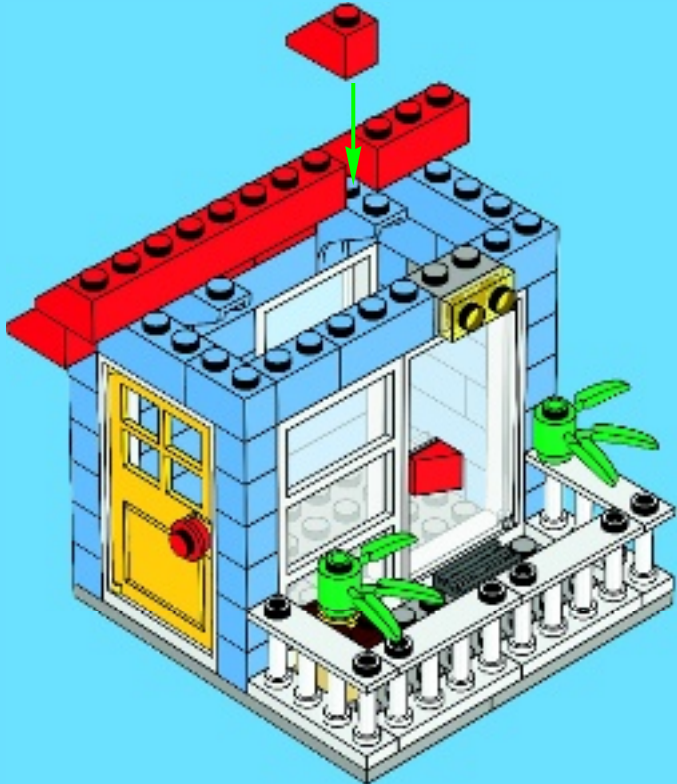



2x



3x



1x



1x

# 21

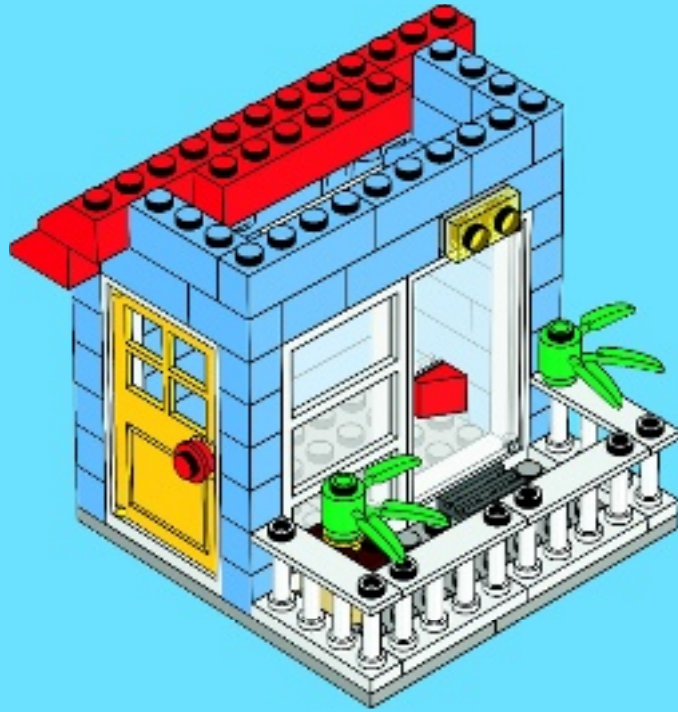

3x

# 22





3x

23

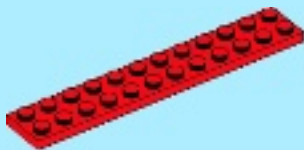

1x

24







2x



1x



1x



2x

# 25

1



2



3



4





1x

# 41

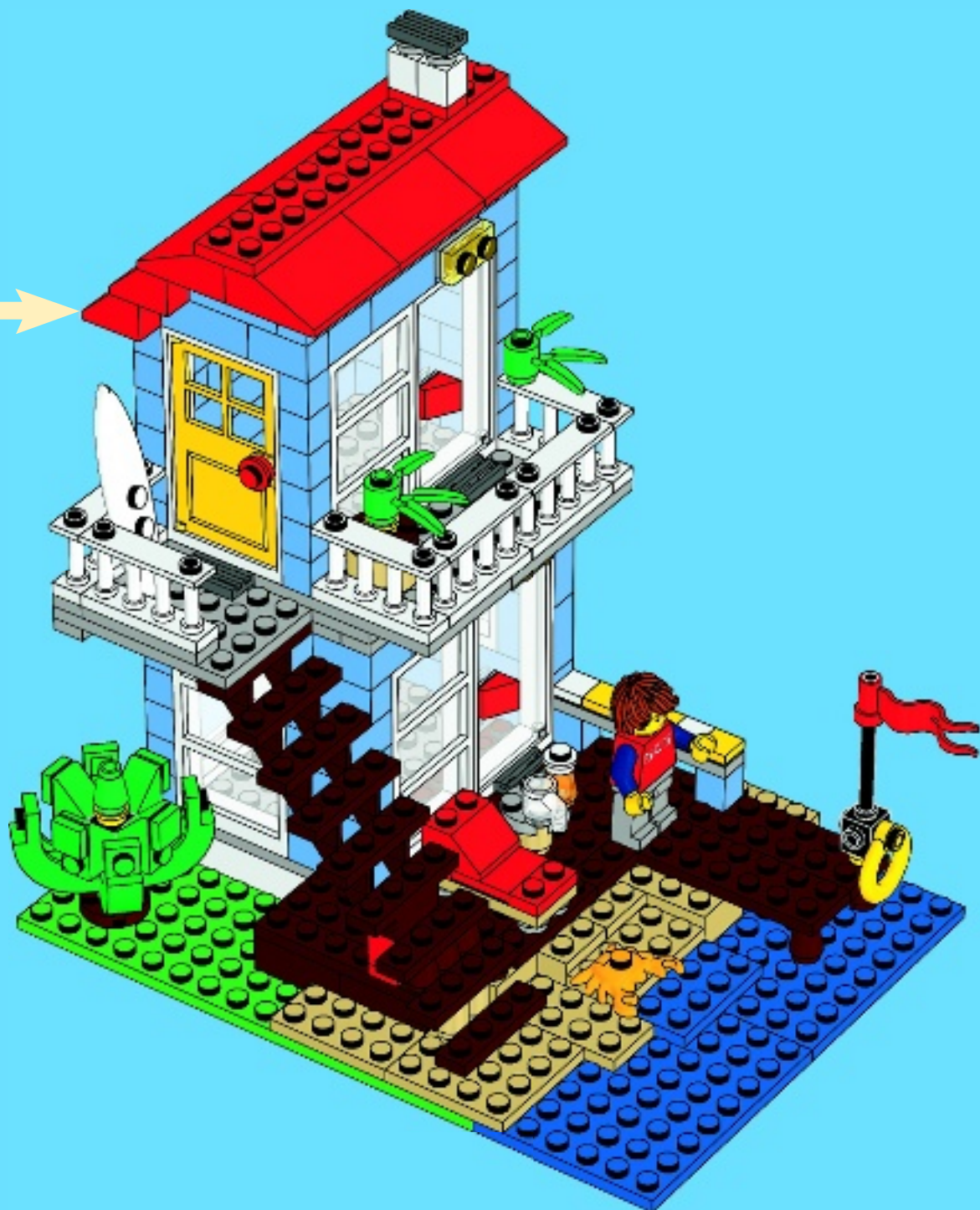



FREE! GRATIS! GRATUIT!



www.LEGOclub.com



LEGO Club Magazine

LEGO Club Email

VISIT THE WORLD'S BIGGEST LEGO SHOP!

www.LEGOshop.com

GO TO

www.LEGOclub.com

00800 5346 5555



1-866-534-6258 • 1-877-518-5346

US & Canada only

Canada seulement



\* Freephone. Mobile charges may apply. \* Numéro sans frais. Des frais peuvent s'appliquer avec les téléphones cellulaires. \* Gebührenfrei. Kosten für Anrufe aus Mobilfunknetzen können abweichen. \* Gratis telefonnummer vanaf vaste lijn. \* Det er et gratis nummer, når du ringer fra fasttelefon. \* Det är gratis, när du ringer från en fast telefon. \* Numéro sans frais. Des frais peuvent s'appliquer avec les téléphones portables.

YES! I want to join the LEGO Club FREE! OUI! Je veux m'abonner au LEGO Club GRATUITEMENT! Ja! Ich möchte Mitglied im kostenlosen LEGO Club werden. Ja! Ik wil graag GRATIS lid worden van de LEGO Club. Ja! Jeg ønsker å melde meg inn i LEGO Club gratis! Ja! Jag vill gå med i LEGO Club GRATIS!

Registration form with fields for name, address, birth date, gender, and contact information.

Mail to: / Poster à: LEGO Club, P.O. Box 1157, Enfield, CT USA, 06083-1157

Send til: LEGO Club Norge, Postboks 58, 1314 Vøyenenga

Skickas till: LEGO Club Sverige, Ubox 841, 202 29 Malmö

Poster à: LEGO Club, 21 rue de la banque, 75 002 PARIS, FRANCE

Mail to: LEGO Club, 33 Bath Road, Slough SL1 3UF, United Kingdom

Per Post an: LEGO Club, Postfach 14 15, D-36243 Niederaula

Stuur op naar: LEGO Club, Postbus 40250, 3504 AB Utrecht

- Fill in your email address and we will send you a membership confirmation and monthly email newsletters. If you do not wish to receive the newsletters please tick here. Remplis ton adresse e-mail et nous t'enversons une confirmation d'adhésion ainsi que le bulletin e-mail mensuel. Si tu ne désires pas recevoir le bulletin, coche cette case. Vül je e-mailadres in en we sturen je een bevestiging van je lidmaatschap en maandelijke e-mail nieuwsbrieven. Als je geen e-mail wilt ontvangen, kruis dan dit vakje aan. Om du vill få annan information från LEGO Gruppen, sätt ett kryss här. Dersom du ønsker å motta annen informasjon fra LEGO Gruppen, setter du et kryss her.

The English language version of the magazine can only be mailed to addresses in the US, Canada, the UK, and Republic of Ireland. Club membership is valid for two years and includes free copies of the LEGO Club Magazine and e-mail newsletters. In the US and Canada please allow up to 6 weeks for delivery of your first magazine. In the UK and Republic of Ireland please allow six to 14 weeks for delivery of your first magazine. By signing this form you consent the LEGO Club to use your child's data for LEGO mailings. The data will only be used for LEGO mailings and will not be sold, rented or otherwise disclosed to any company outside the LEGO Company except for disclosure to companies acting as our agents to help us provide services requested by the child. This coupon is valid for one free membership per person, group or organization. Photocopied coupons are accepted. La version française du magazine peut être postée uniquement au Canada. L'abonnement est valide pour 2 ans et inclut des exemplaires gratuits du Magazine LEGO. Aux É.-U. et au Canada, allouer 6 semaines pour la livraison initiale. En remplissant ce formulaire, vous consentez à ce que LEGO utilise les informations de votre enfant pour des envois postaux de LEGO. L'information sera utilisée uniquement pour des envois postaux par LEGO et ne sera en aucun cas, vendue, louée, échangée ou divulguée à d'autres compagnies autres que la compagnie LEGO, à l'exception des compagnies affiliées qui nous procurent des services auxquels l'enfant en a fait la demande. Formulaire photocopié accepté. Mit der folgenden Unterschrift erkläre ich, für mein Kind den Beitritt als Mitglied zum kostenlosen LEGO Club, der von der LEGO GmbH, D-85627 Grasbrunn, betrieben wird. Die Mitgliedschaft beinhaltet die Zusendung des LEGO Club Magazins und kann beiderseits jederzeit beendet werden. Die Mitgliedschaft im LEGO Club sind keinerlei Verpflichtungen verbunden. Das deutschsprachige LEGO Club Magazin wird nur an Adressen in Deutschland, Österreich und der Schweiz versendet. Eine Anmeldebestätigung kann nur per E-Mail geschickt werden. Das Magazin erscheint fünfmal jährlich. Daher kann die Zustellung des ersten Heftes bis zu drei Monate dauern. Die Mitgliedschaft ist beidseitig jederzeit kündbar, ohne dass Ihnen Kosten entstehen. Sie können der werblichen Nutzung Ihrer Daten jederzeit widersprechen, Kündigung und Widerspruch können Sie telefonisch erklären (00800 / 5346 5555, Anruf gebührenfrei. Kosten für Anrufe aus dem Mobilfunknetz können abweichen) oder an die LEGO GmbH senden. Het Nederlandse LEGO Club Magazine kan alleen worden gestuurd naar adressen in Nederland. Het lidmaatschap is 2 jaar geldig en geeft recht op toezending van het gratis LEGO Club Magazine en LEGO Club e-mails. Het eerste magazine zal binnen 12 tot 14 weken toegezonden worden. Het lidmaatschap kan op ieder moment opgezegd worden en kan na 2 jaar gratis worden verlengd, tenzij LEGO met deze activiteit stopt. Uw gegevens worden uitsluitend gebruikt voor mailings van LEGO en zullen niet worden verkocht, verhuurd of op welke wijze dan ook verstrekt aan derden buiten de LEGO Groep, uitgezonderd de organisaties die namens ons optreden om de informatie te sturen waarvoor toestemming is verleend. Den norske utgaven av magasinet sendes kun til adresser i Norge. Medlemskap i klubben gjelder i 2 år og inkluderer gratisutgaver av LEGO Club Magazine. Påreg minimum opp til seks uker leveringstid for første magasin. Ved å undertegne dette skjemaet, gir du ditt samtykke til at LEGO Club kan bruke opplysningene om barnet ditt i LEGO Club til å sende deg gratis LEGO Club Magazine og LEGO Club e-mails. Det første magasinet vil bli levert innen 12 til 14 uker etter at du har fylt ut skjemaet. Du kan når som helst avslutte ditt medlemskap i LEGO Club uten å betale noe. Medlemskapet i LEGO Club er gyldig i 2 år og inkluderer gratisutgaver av LEGO Club Magazine. Påreg minimum opp til seks uker leveringstid for første magasin. Ved å undertegne dette skjemaet, gir du ditt samtykke til at LEGO Club kan bruke opplysningene om barnet ditt i LEGO Club til å sende deg gratis LEGO Club Magazine og LEGO Club e-mails. Den svenska versionen av tidningen kan endast skickas till adresser i Sverige. Club-medlemskapet är giltigt i 2 år och innefattar gratis exemplar av LEGO Club Magazine. Vänligen räkna med minimum 6 veckor för leverans av din första tidning. Genom att skicka in det här formuläret godkänner du att LEGO Club använder barnets uppgifter för LEGO utskick. Uppgifterna kommer bara att användas för LEGO utskick och kommer inte att säljas, hyras ut eller vidarebefordras till något företag som inte tillhör LEGO Gruppen, med undantag av företag som våra ombud för att tillhandahålla tjänster som barnet har begärt. Den här kupongen gäller för ett gratis medlemskap per person, grupp eller organisation. En kompletterad av bulletin d'adhésion, vous acceptez que LEGO Club utilise les données relatives à votre enfant pour l'envoi de courriers concernant LEGO. Ces données seront uniquement utilisées pour l'envoi d'information concernant LEGO et ne seront ni vendues, ni louées, ni utilisées par d'autres sociétés que le groupe LEGO, à l'exception des sociétés agissant pour le compte de LEGO en tant que sous-traitant de services divers. L'abonnement au LEGO Club est valable pour une période de 2 ans. Il inclut l'envoi par courrier du magazine LEGO Club et par email des newsletters. Un délai de 6 à 14 semaines est à prévoir pour la réception de votre premier magazine. Ce bulletin d'adhésion grant est valable pour l'inscription d'une seule personne. Les photocopies sont acceptées. ATTENTION! Le bulletin d'adhésion doit être rempli et signé par un parent ou un tuteur.

Parent's signature · Signature d'un parent ou d'un tuteur · Unterschrift Erziehungsberechtigte/r · Handtekening ouders · Foreldre/foresattes underskrift · Föräldars /förmyndares underskrift

Date Datum





# CREATOR

7345



7347



[www.LEGO.com](http://www.LEGO.com)



[creator.LEGO.com](http://creator.LEGO.com)







# CREATOR

7346



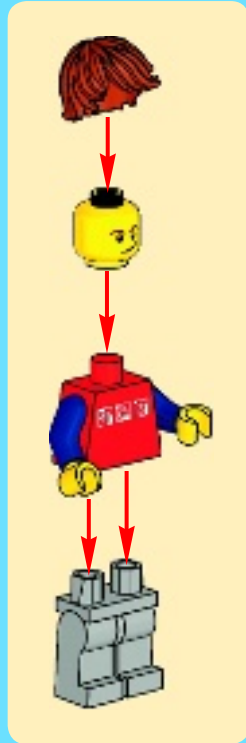





1x

1

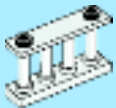
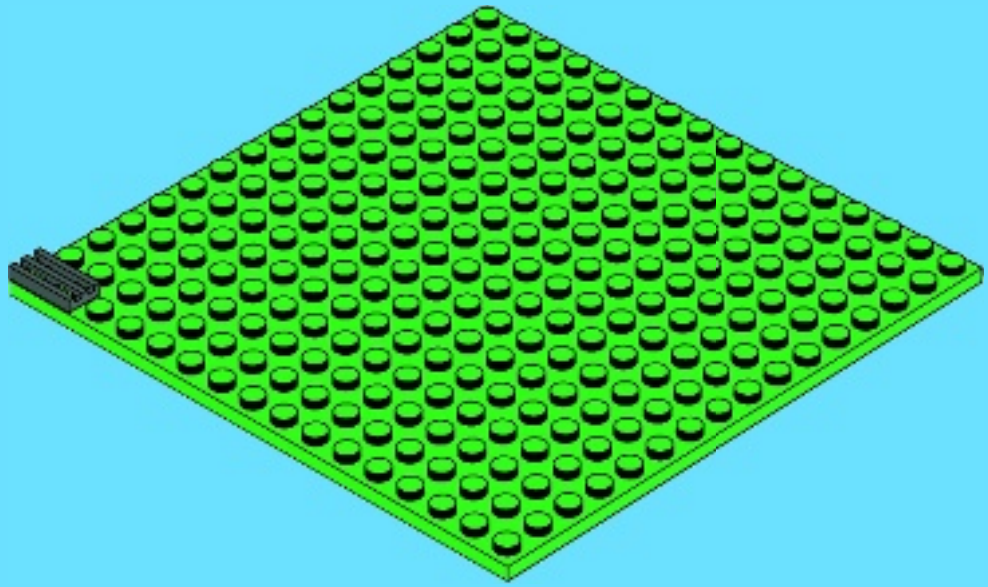

1x



1x



1x

2

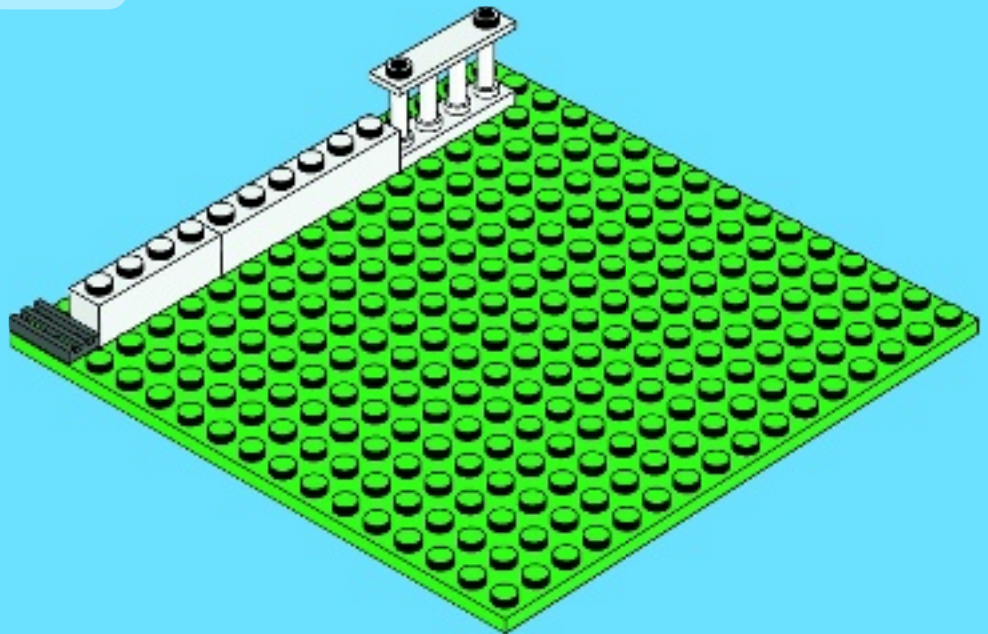



5x



5x



1x



4x

# 3

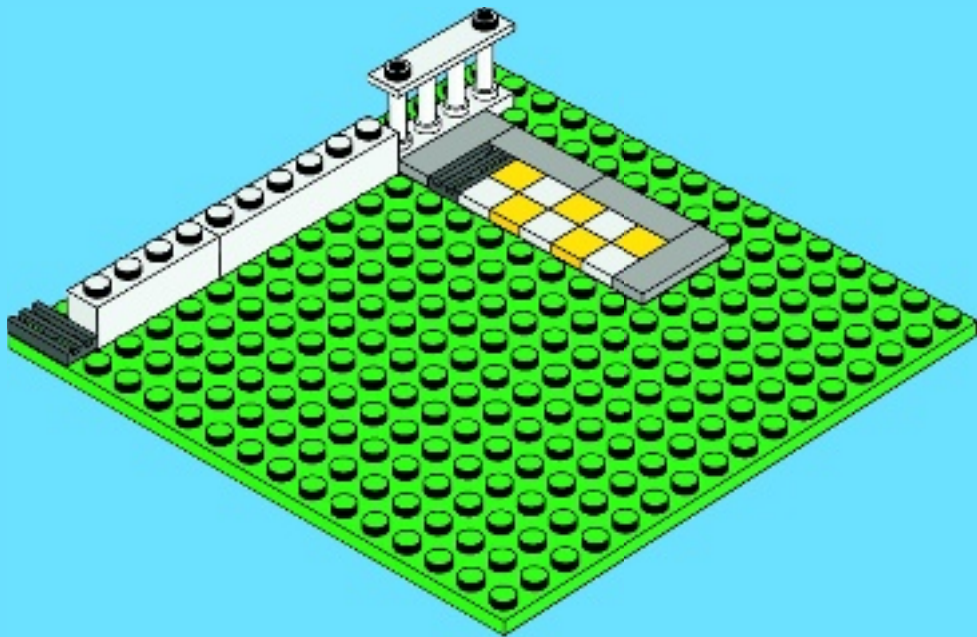



2x



1x

4

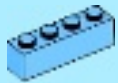
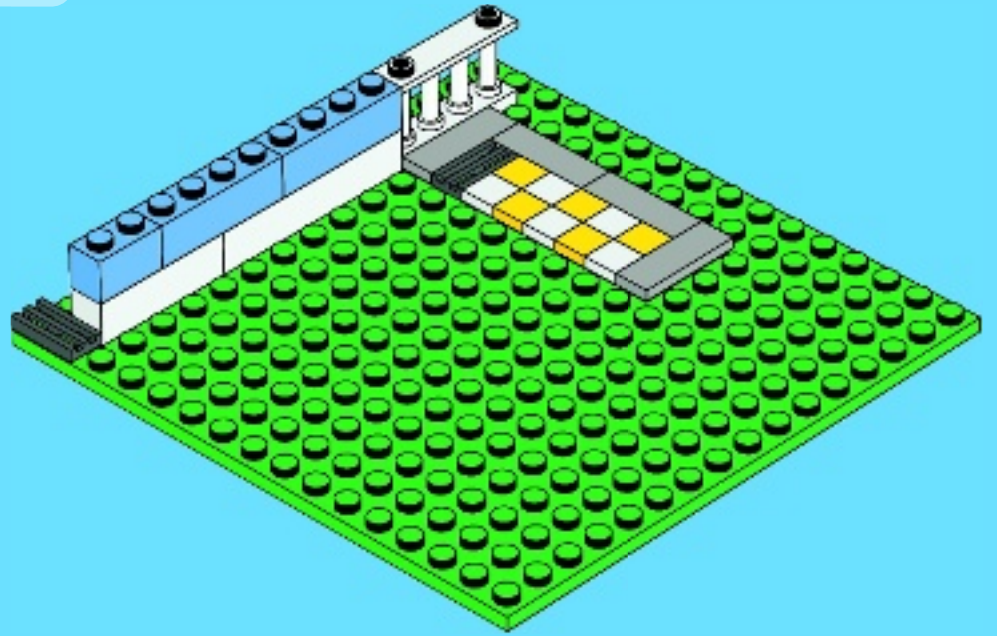

2x



1x

5

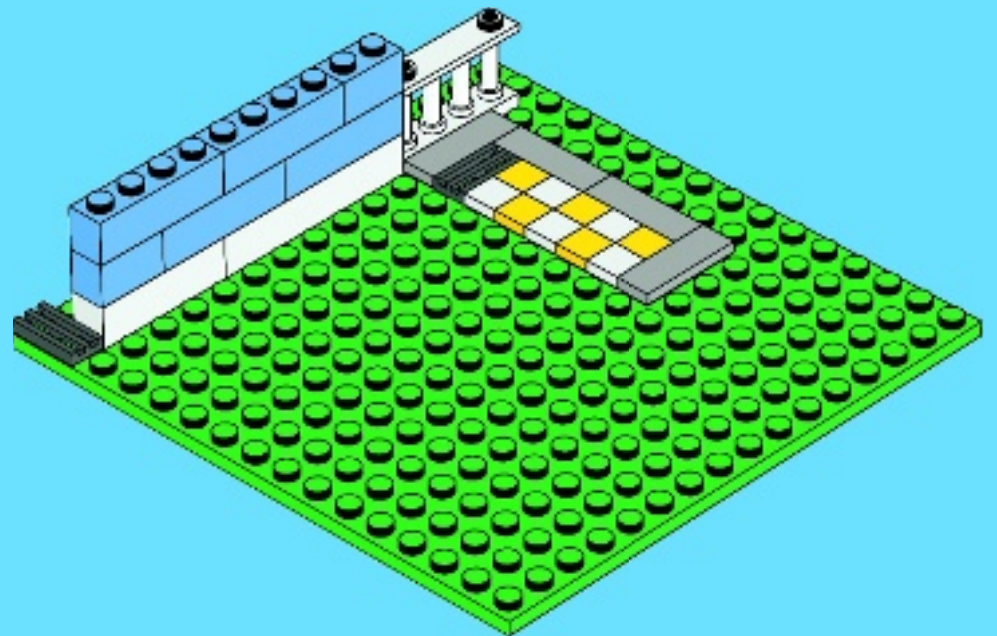





6x

# 6

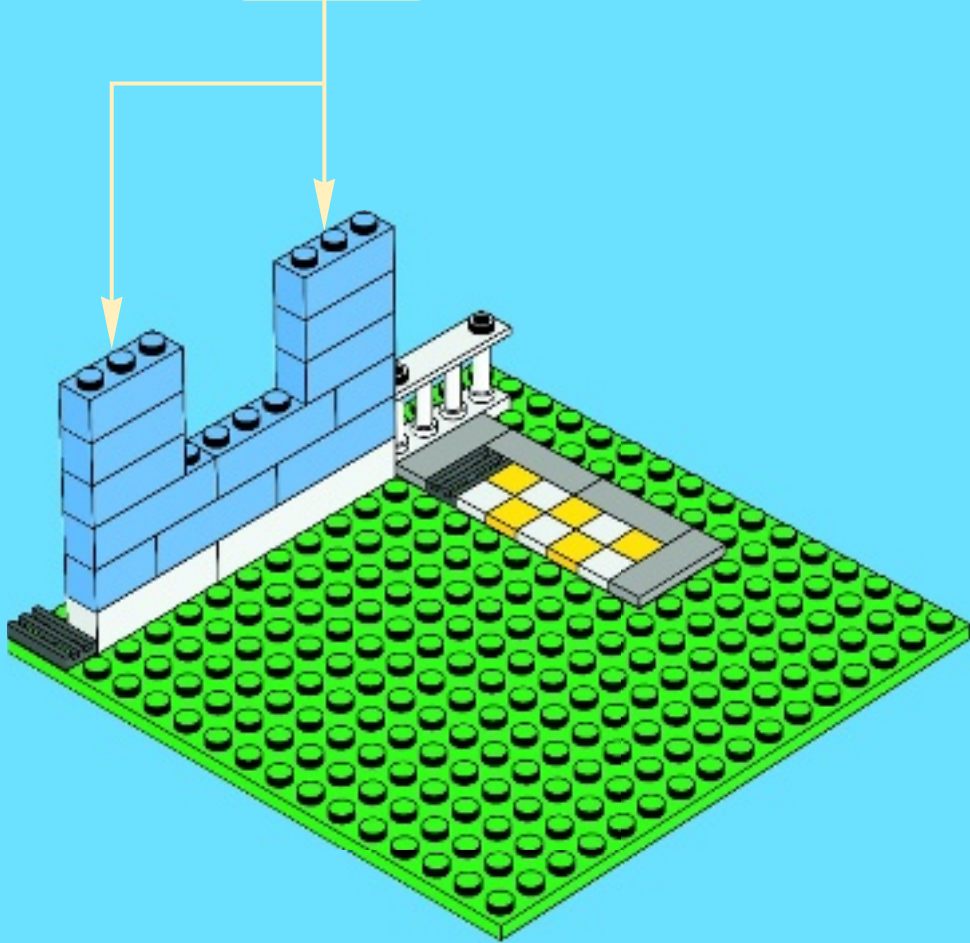
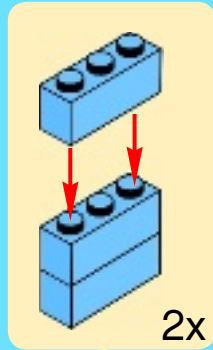

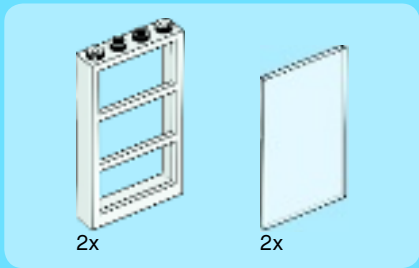

7

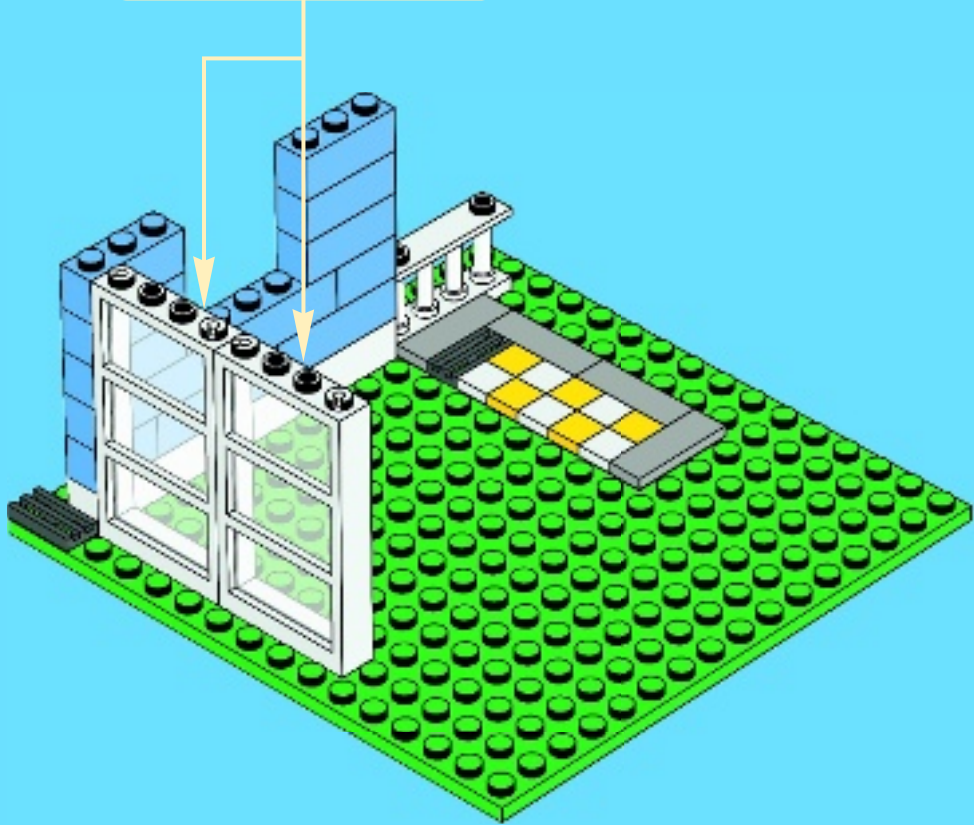
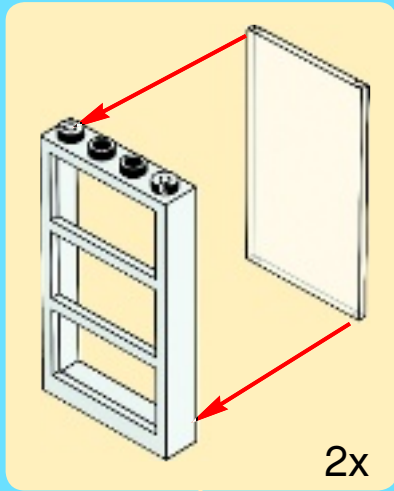

1x

1x

4x

1x

# 8

1



2

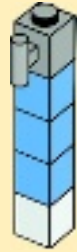

3

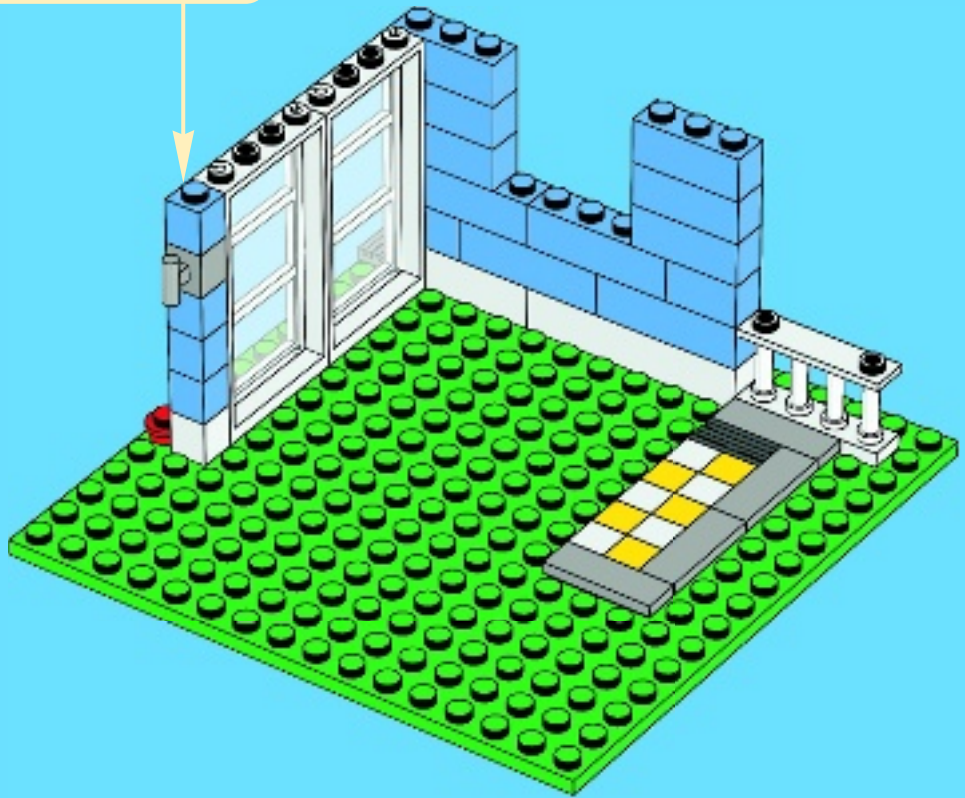



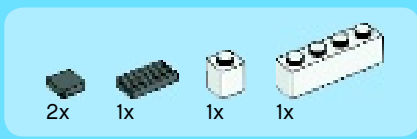

9

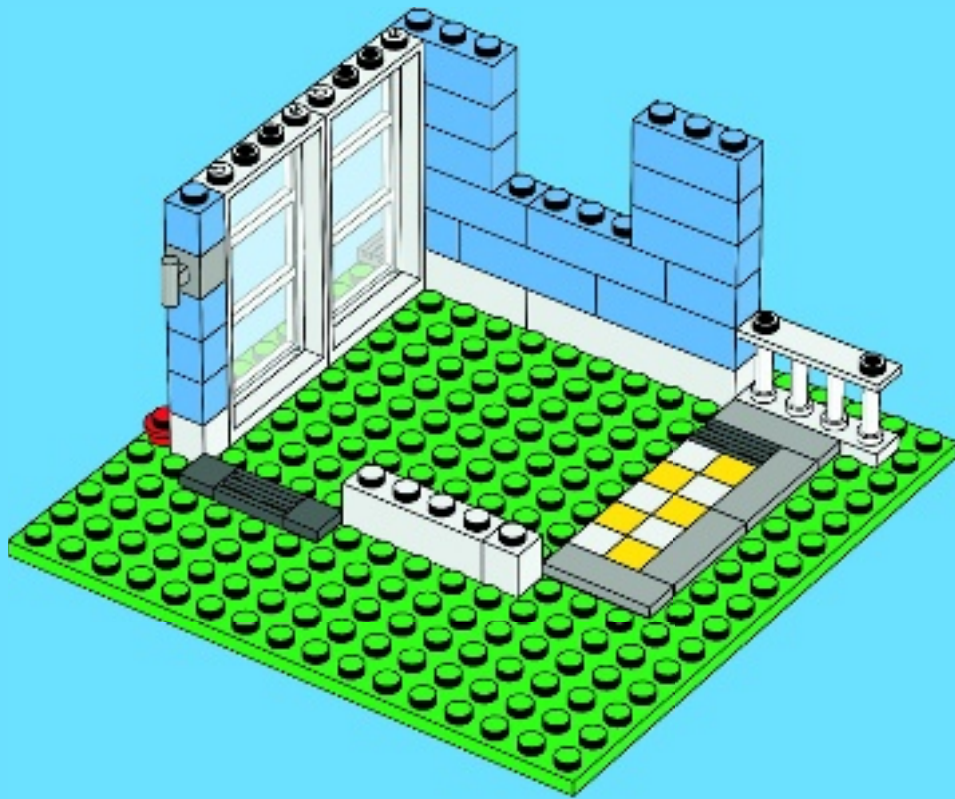



# 10

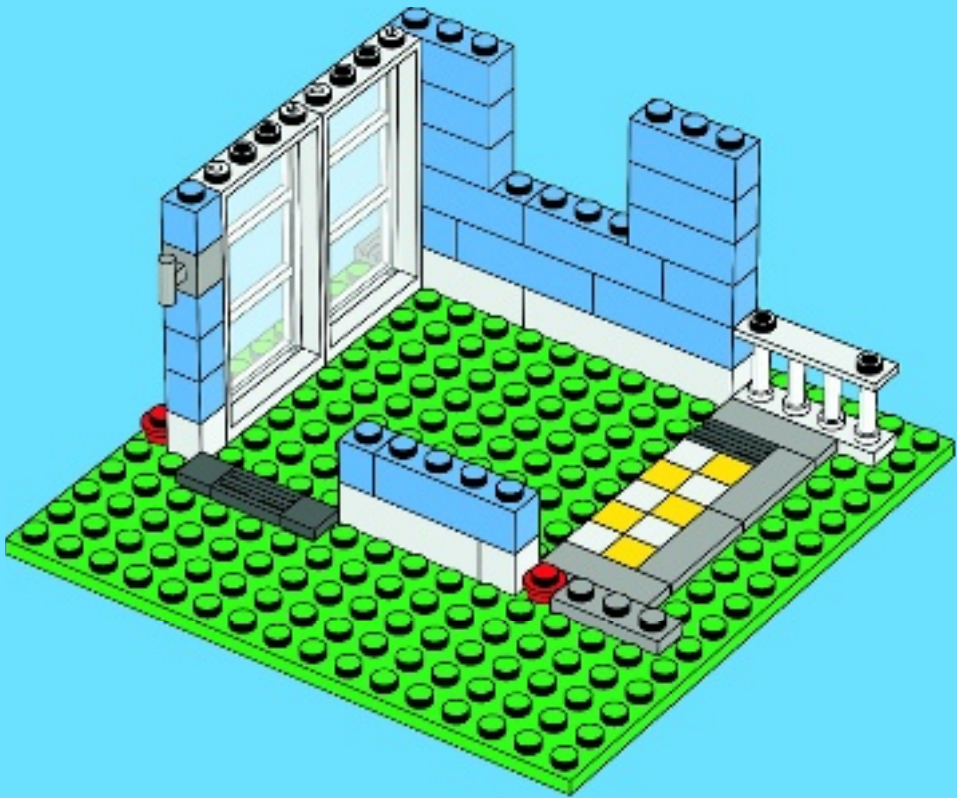



11

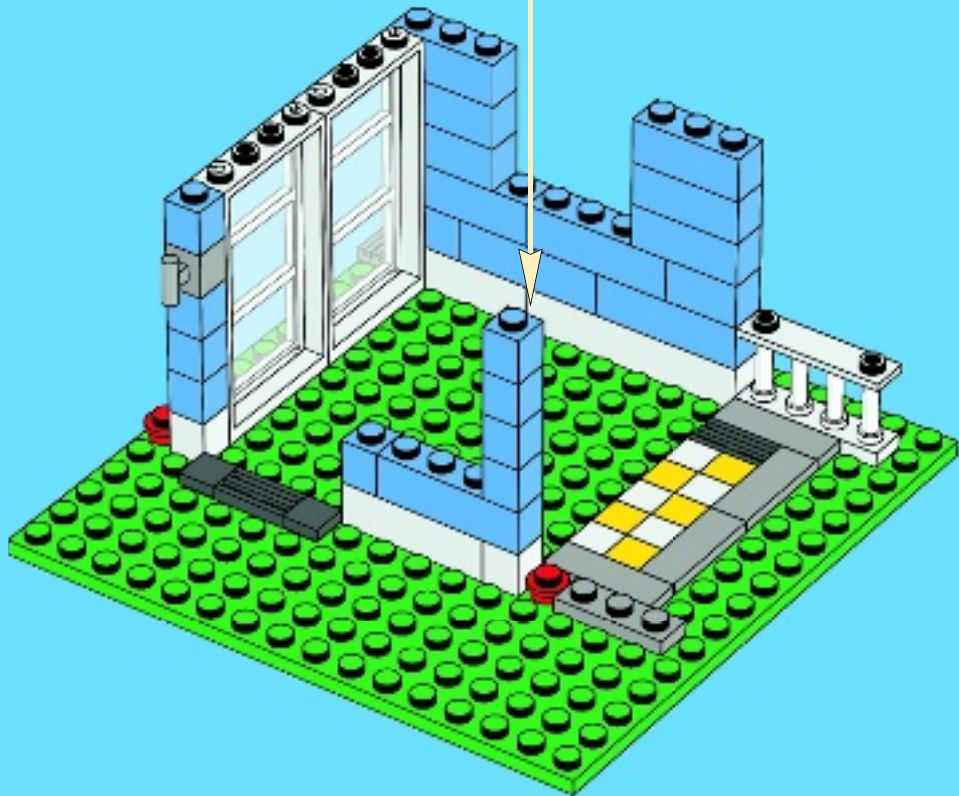
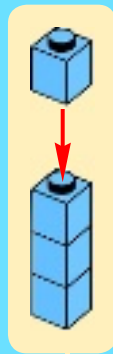



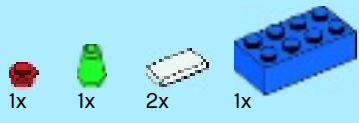

# 12

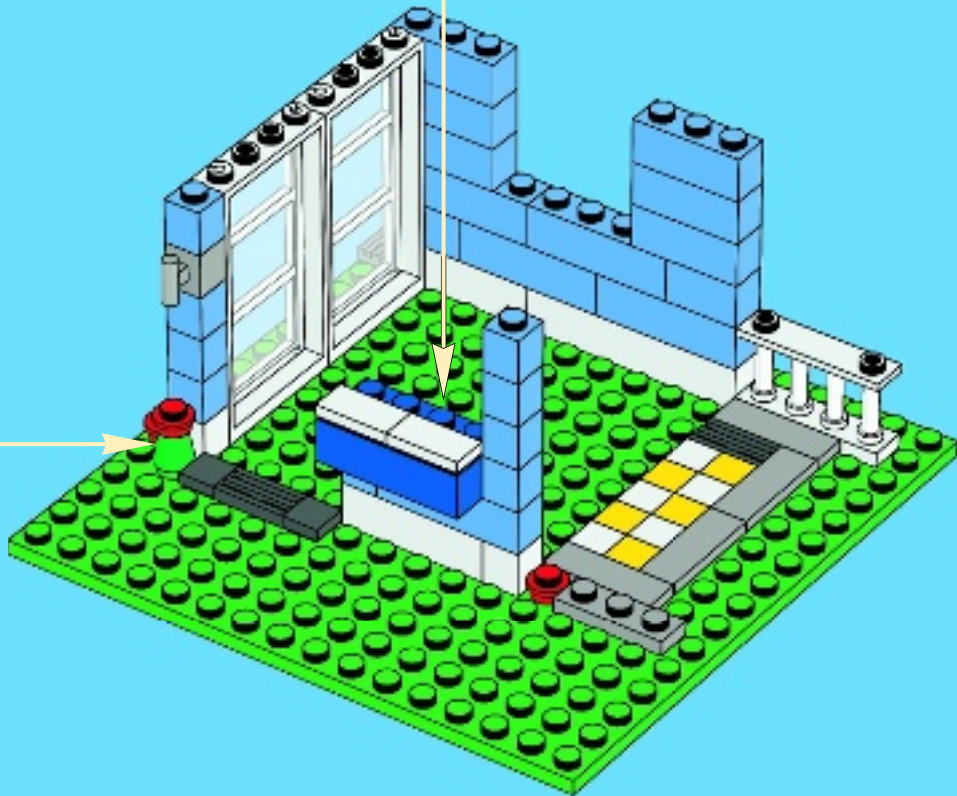
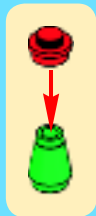
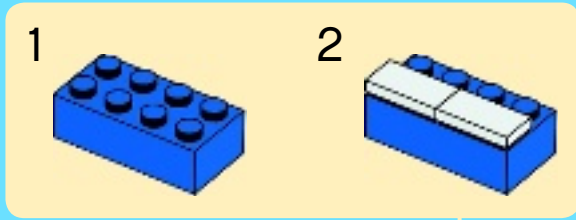

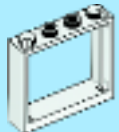

2x



2x

# 13

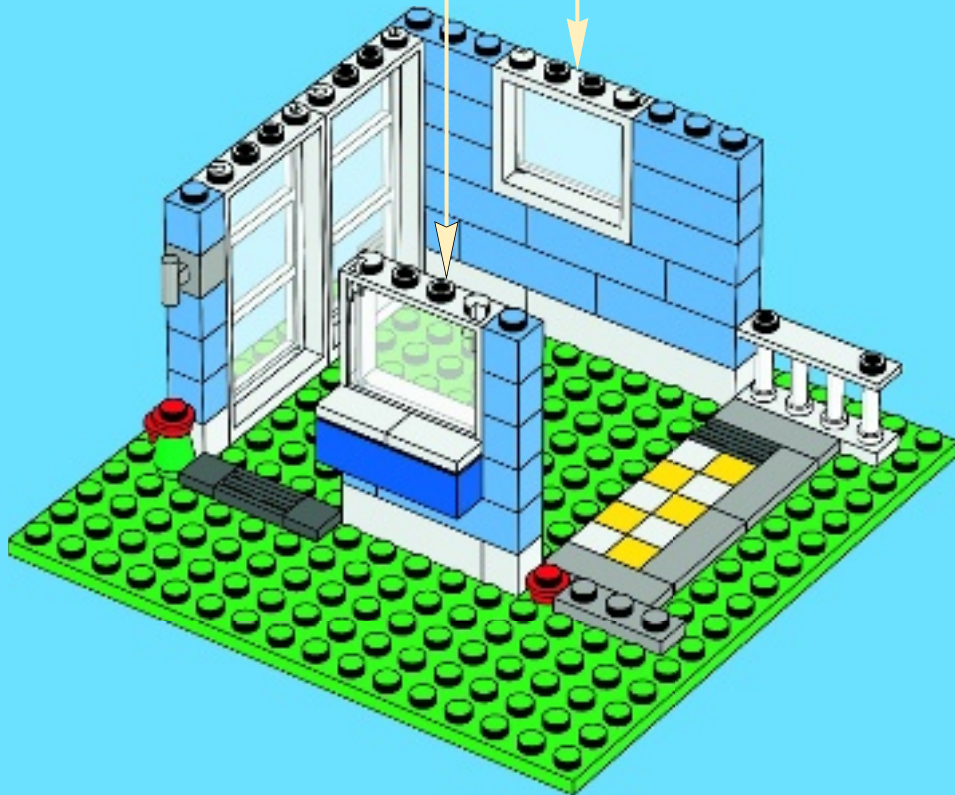
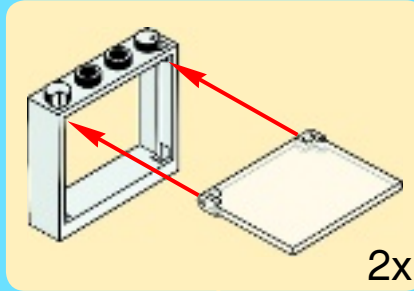

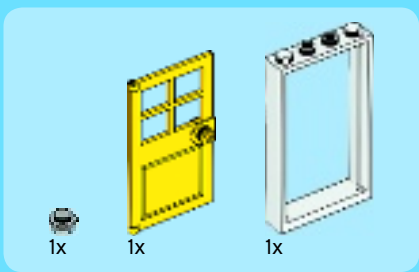

14

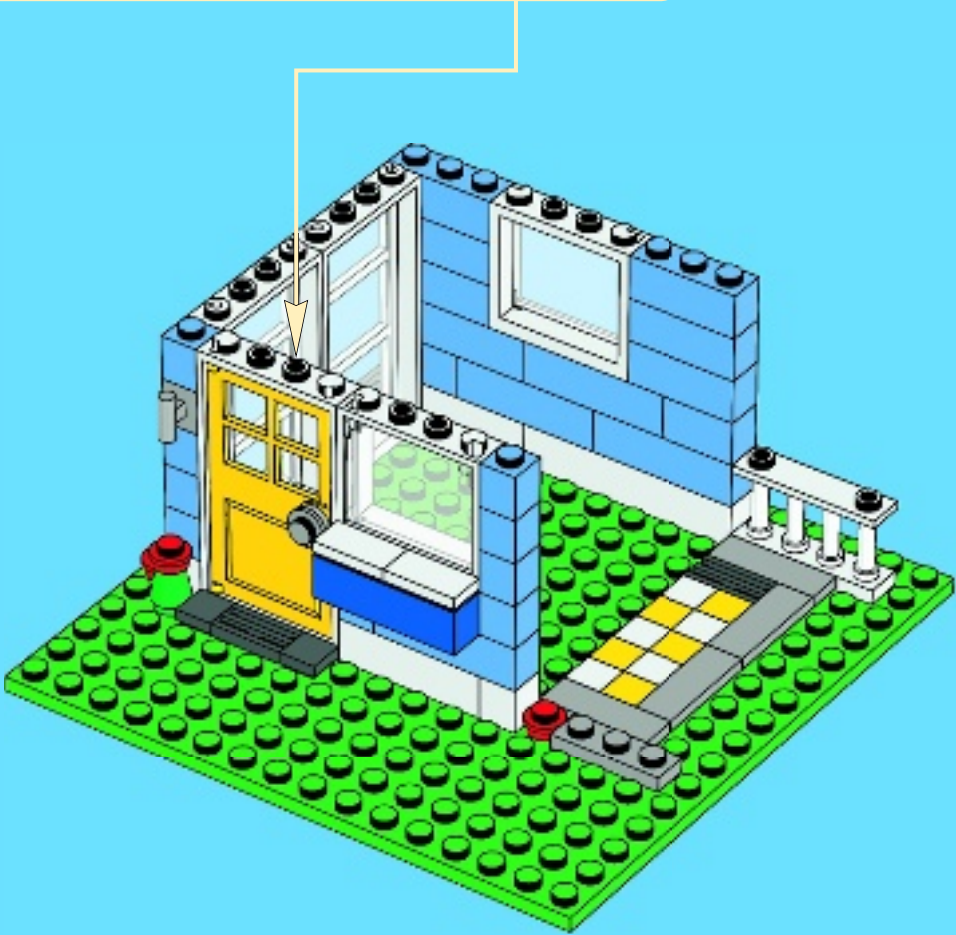
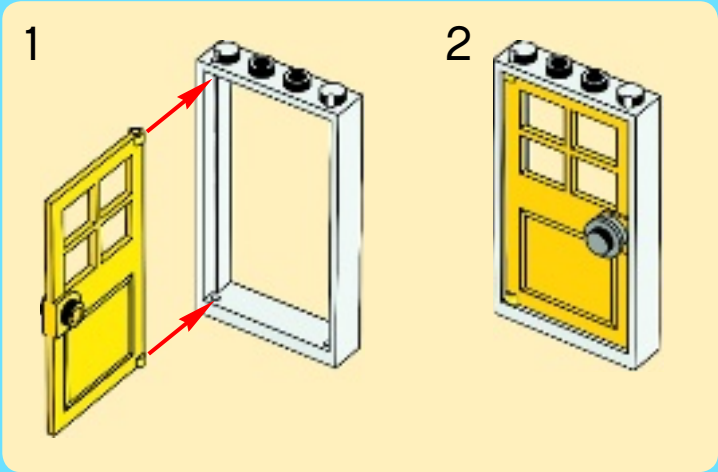



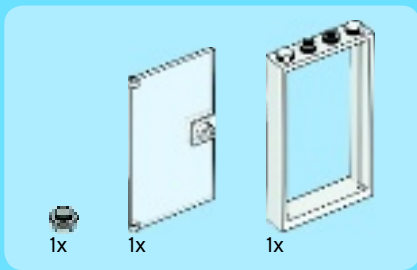

15

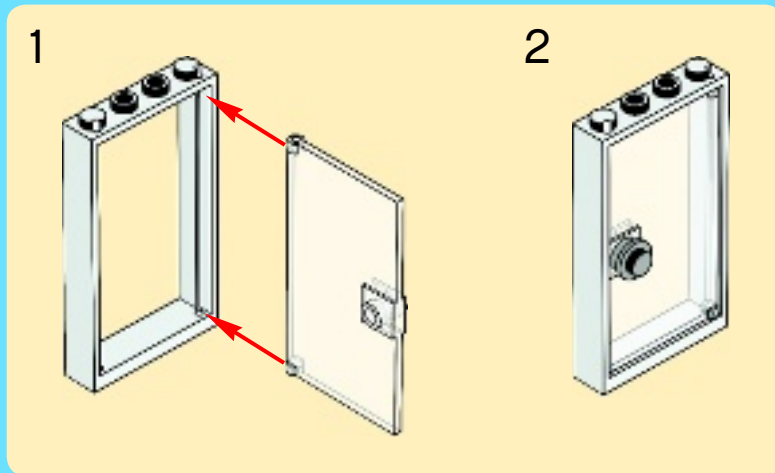

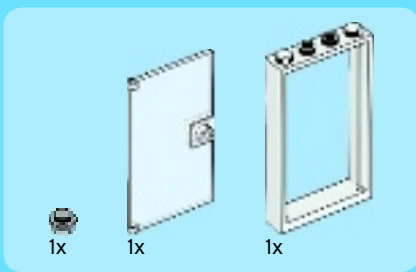

16

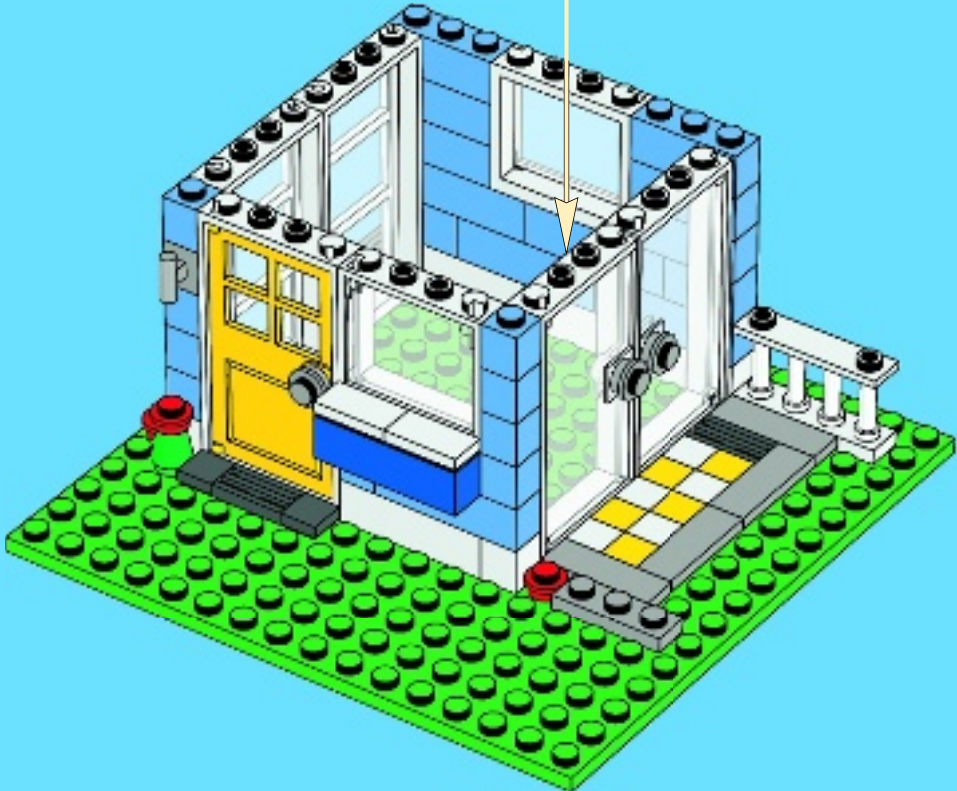
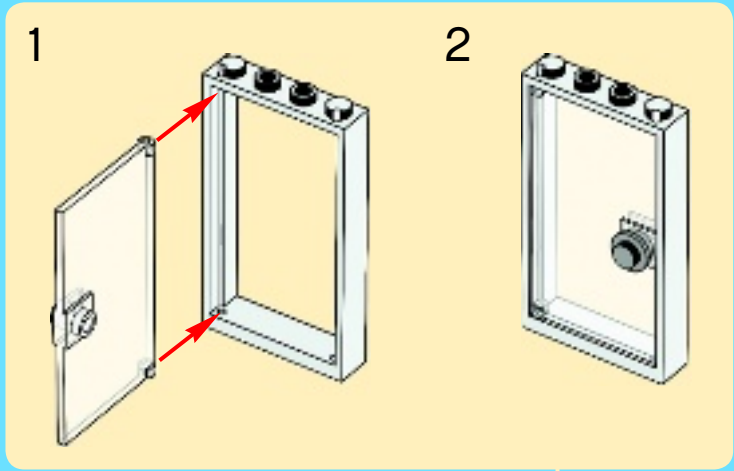



6x



1x



1x



1x

# 17

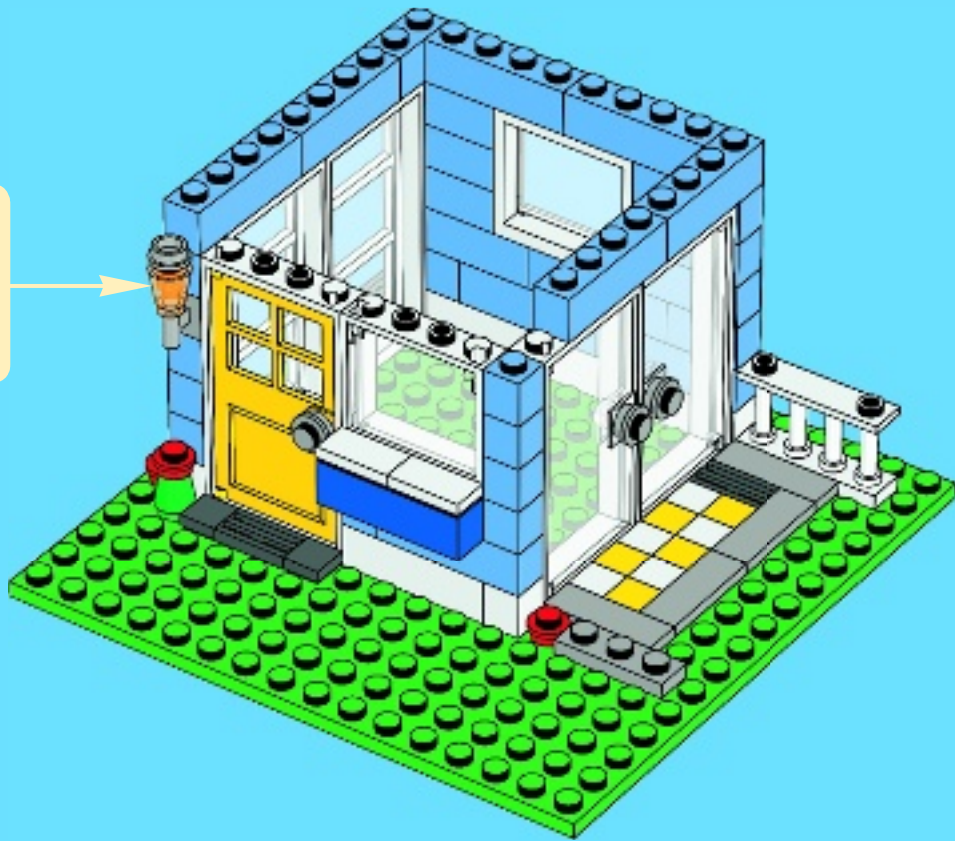



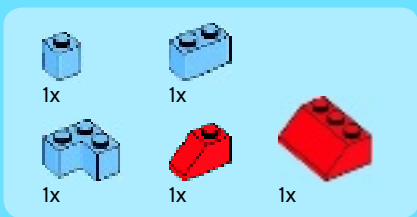

18

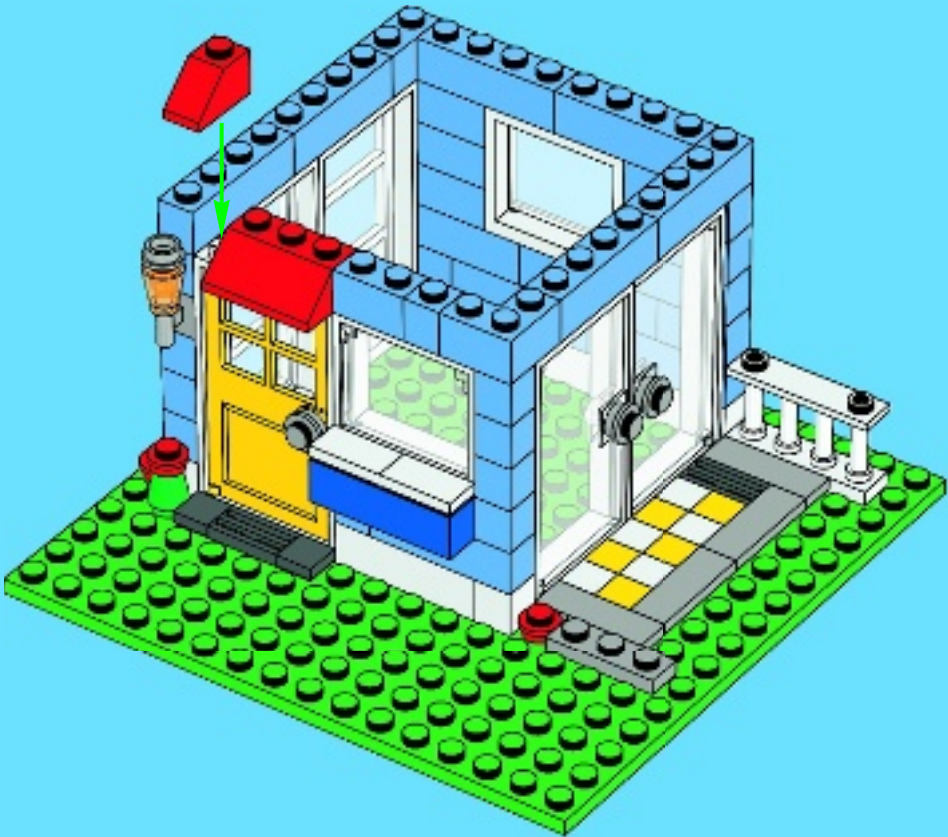

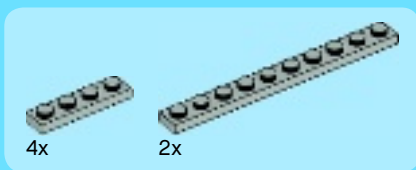

19





2x



4x



4x



2x

# 20





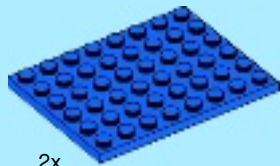

2x

# 21

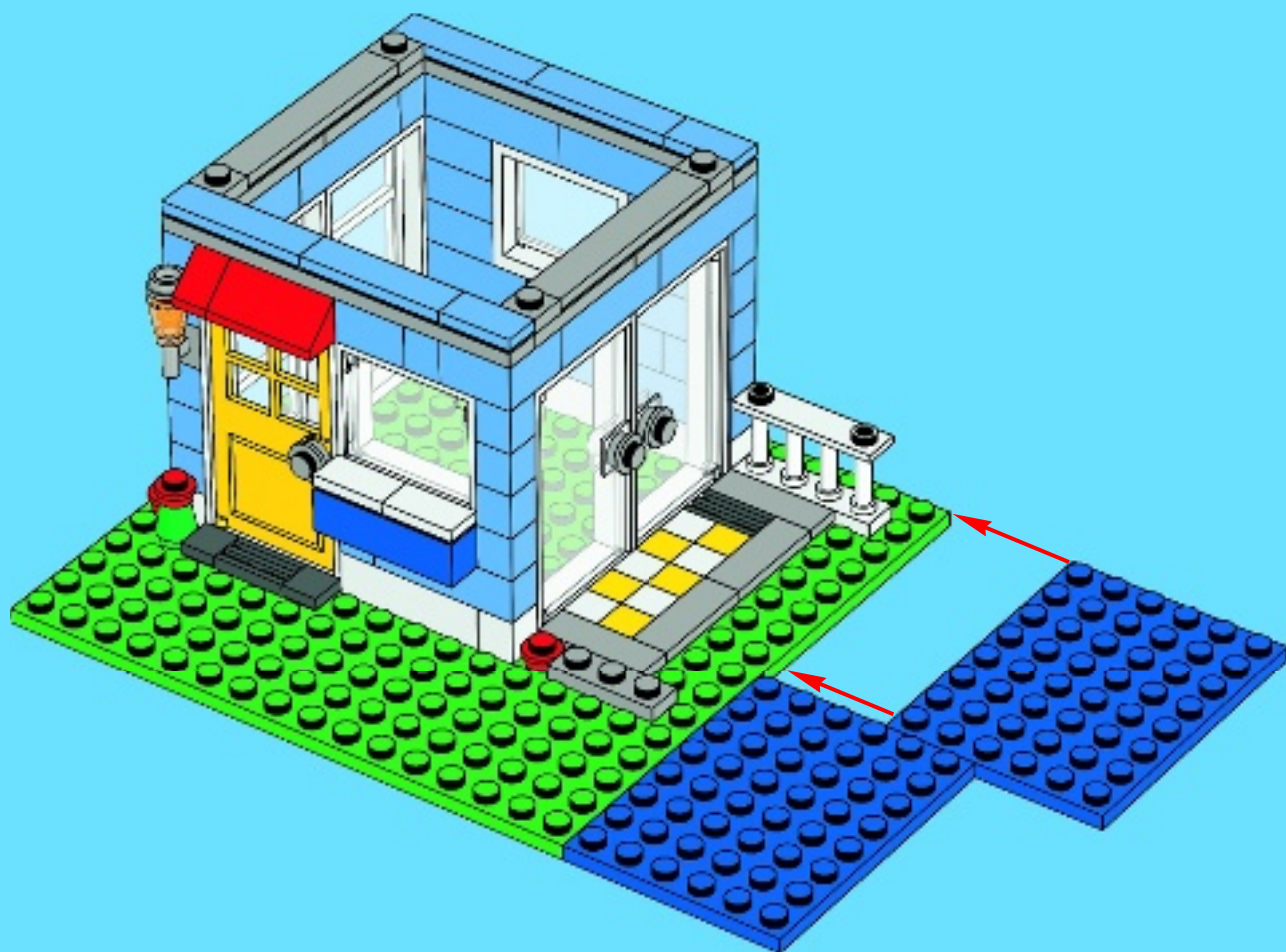



1x



1x

# 22

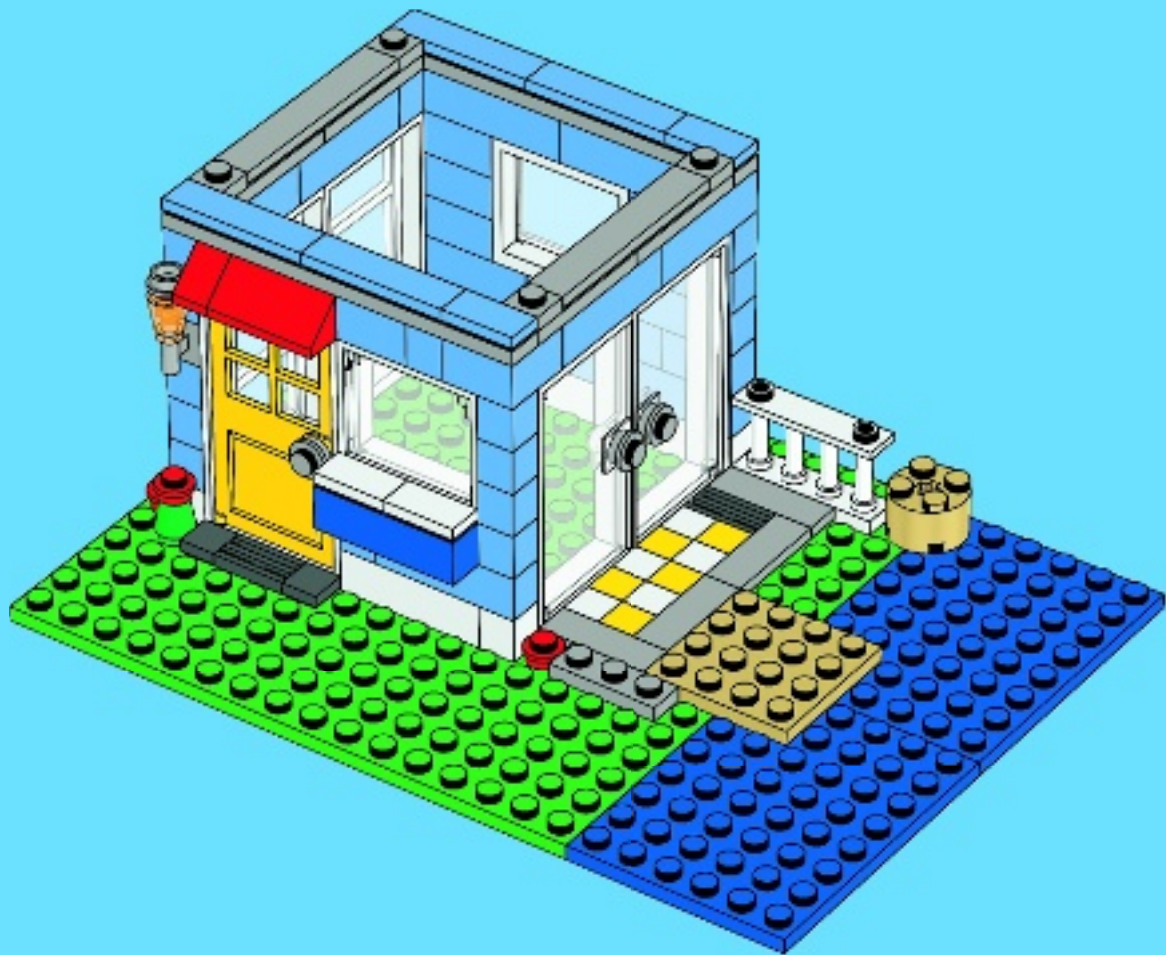

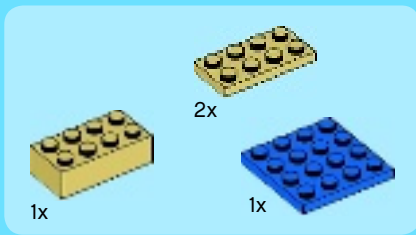

23

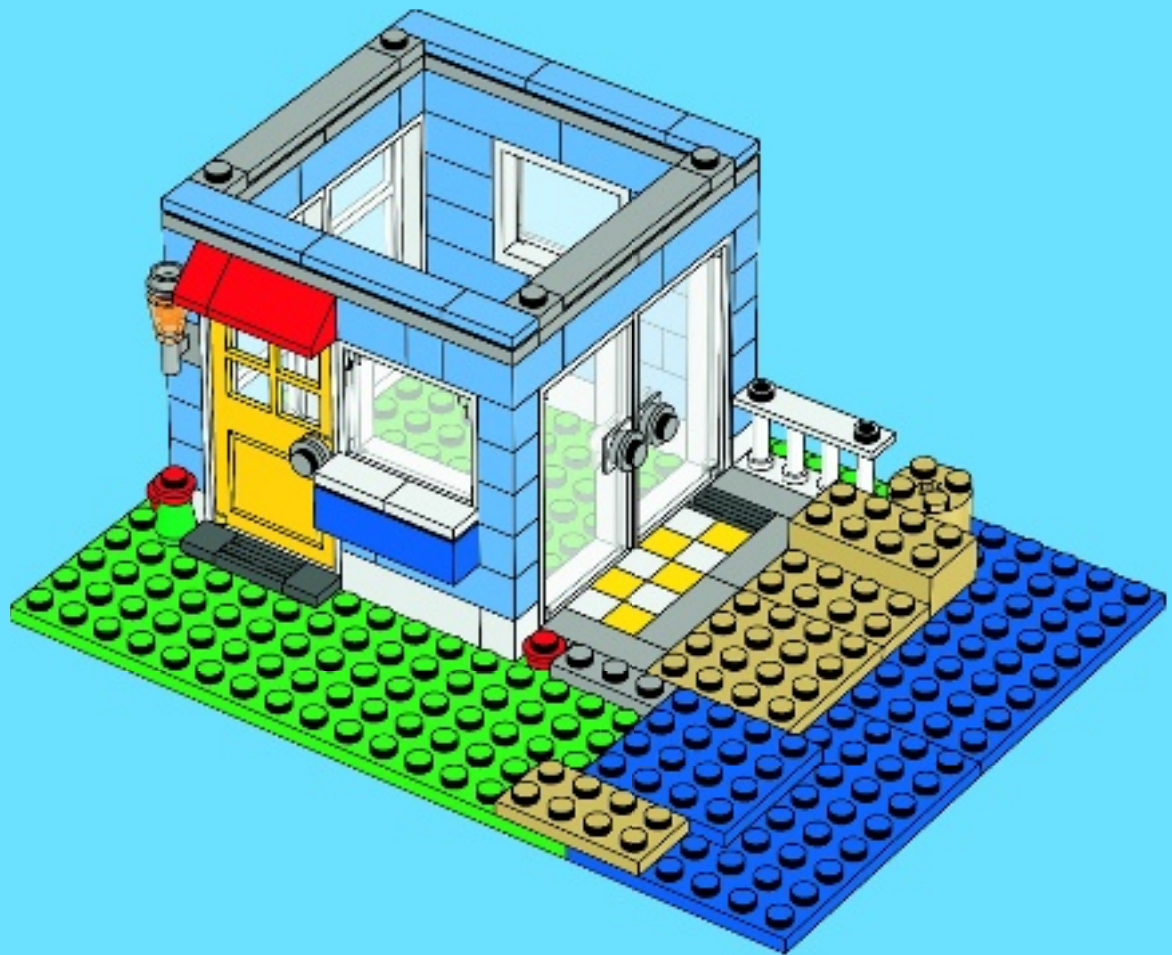



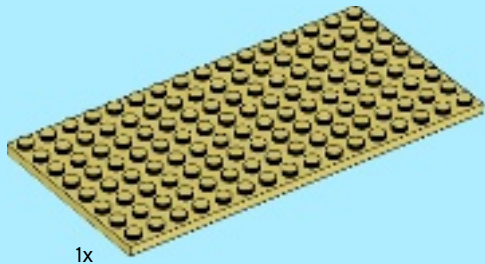

1x

# 24

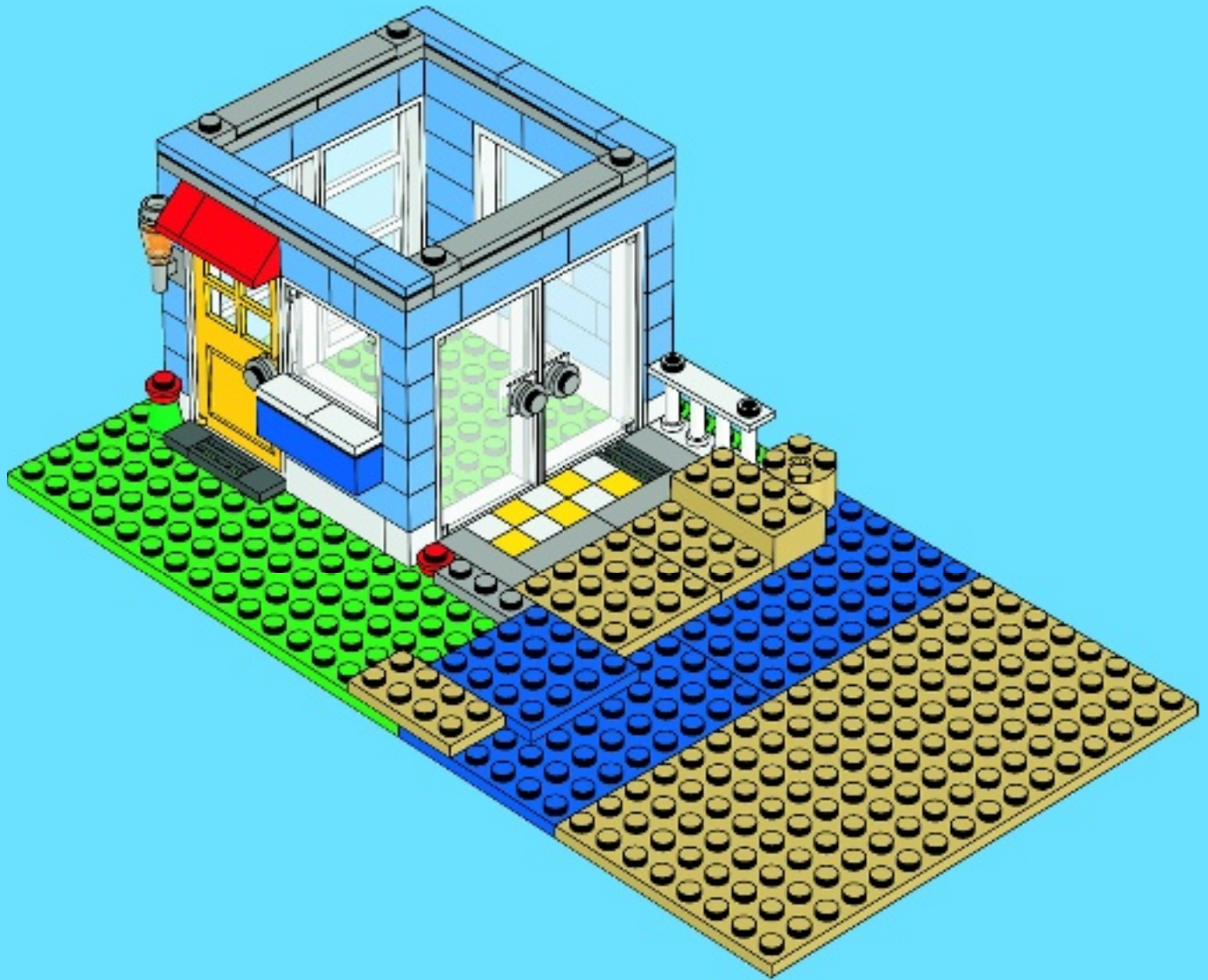



1x

# 25

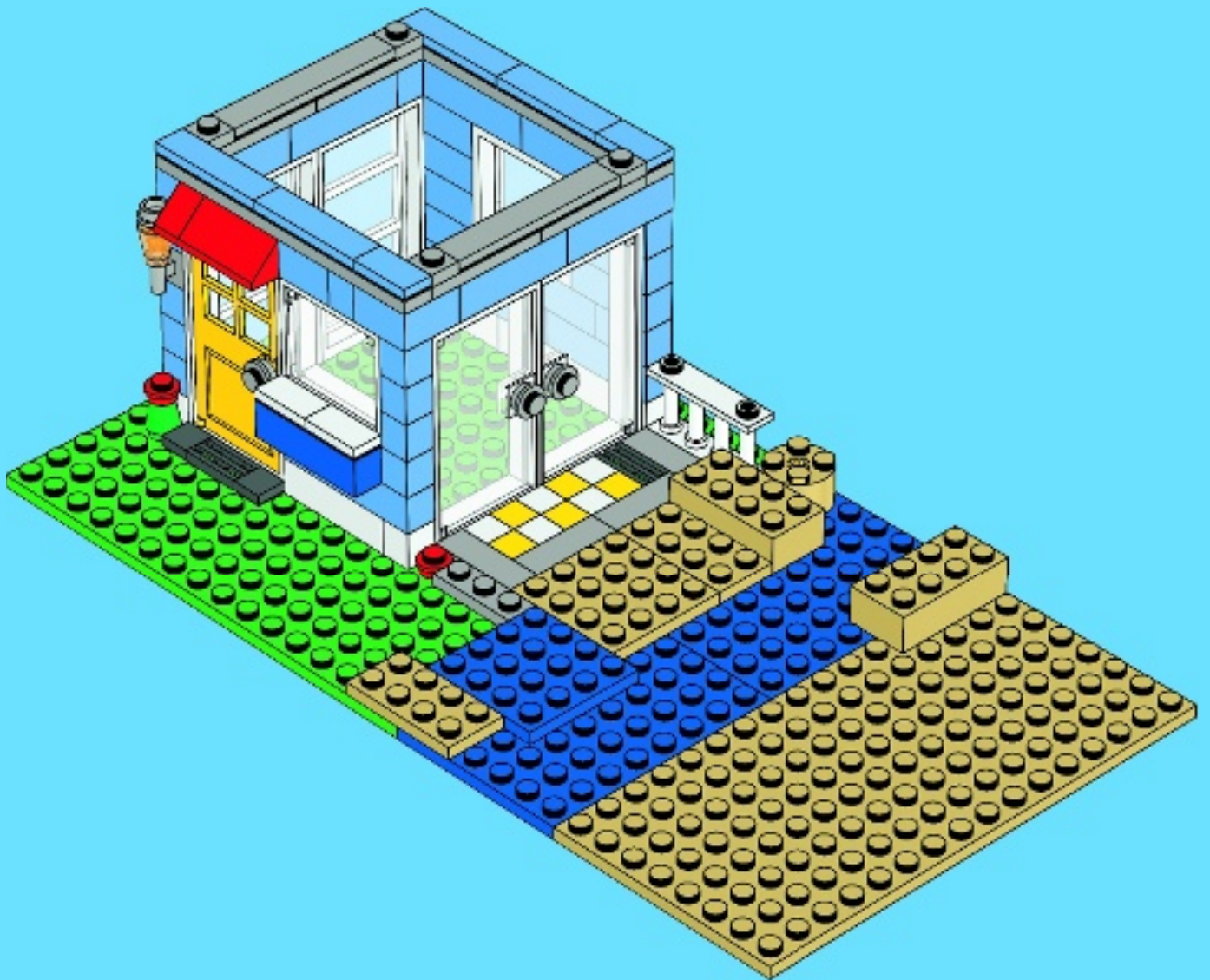



2x



2x

# 26

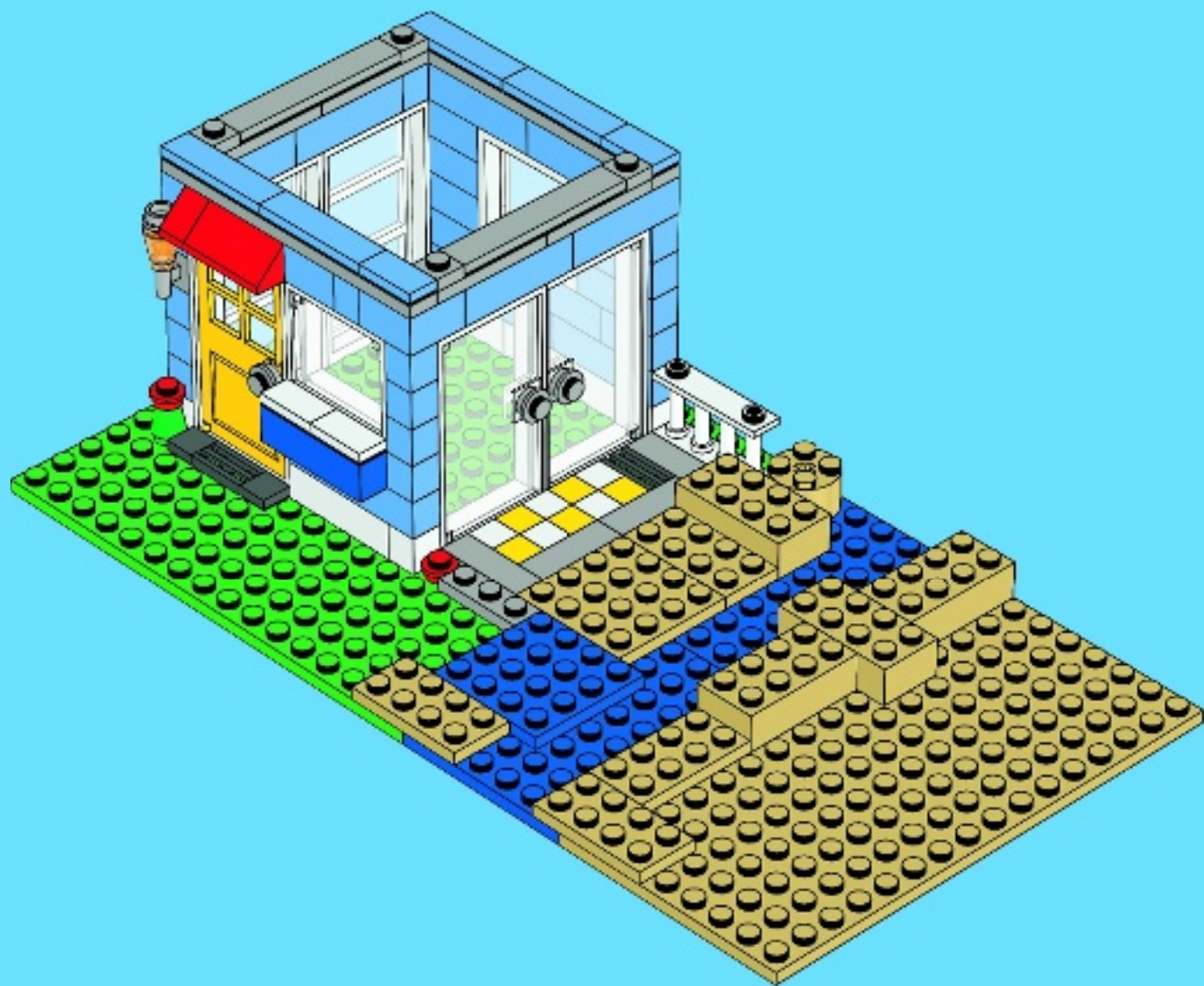





4x



2x

# 27

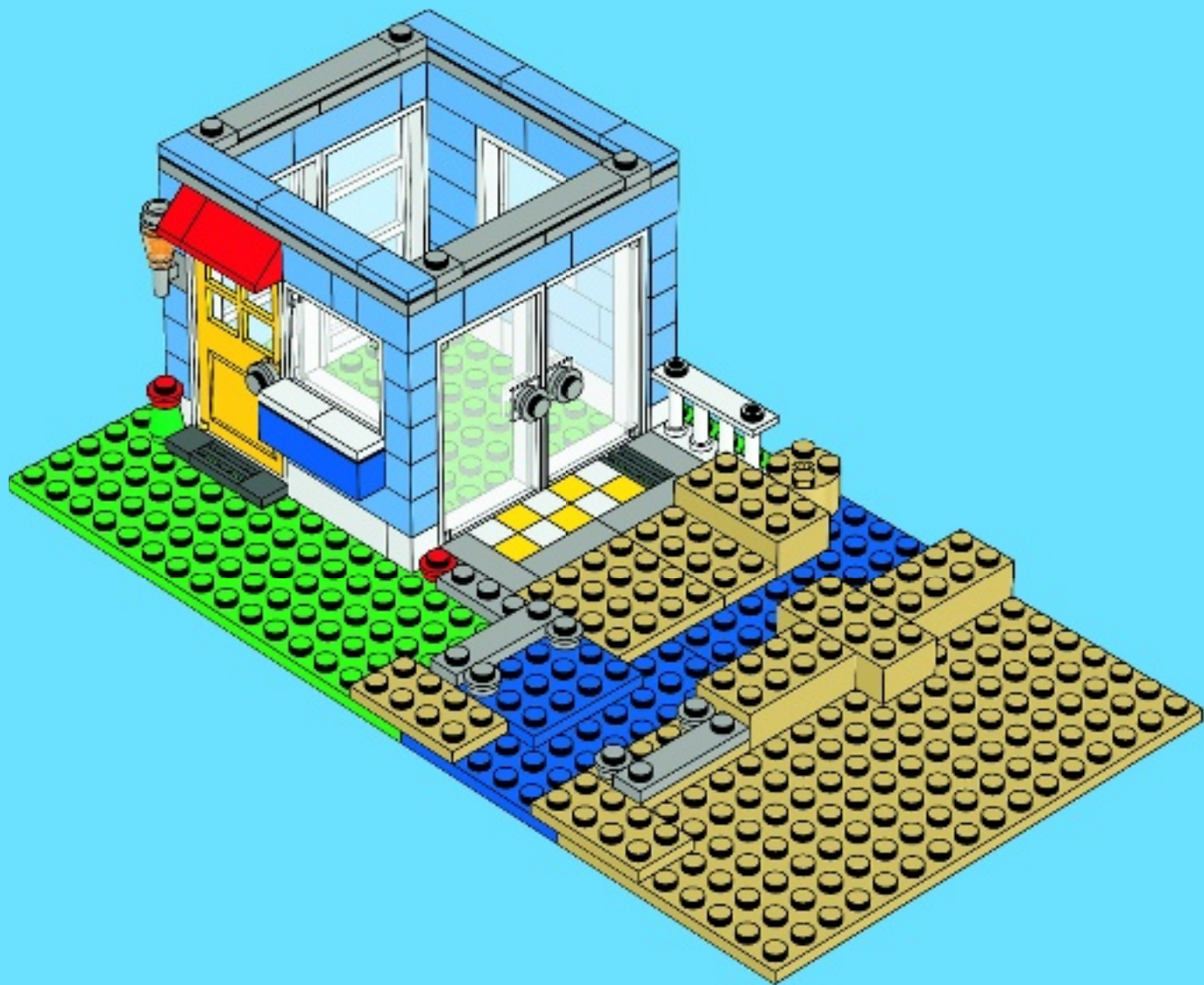



1x



2x



2x

# 28

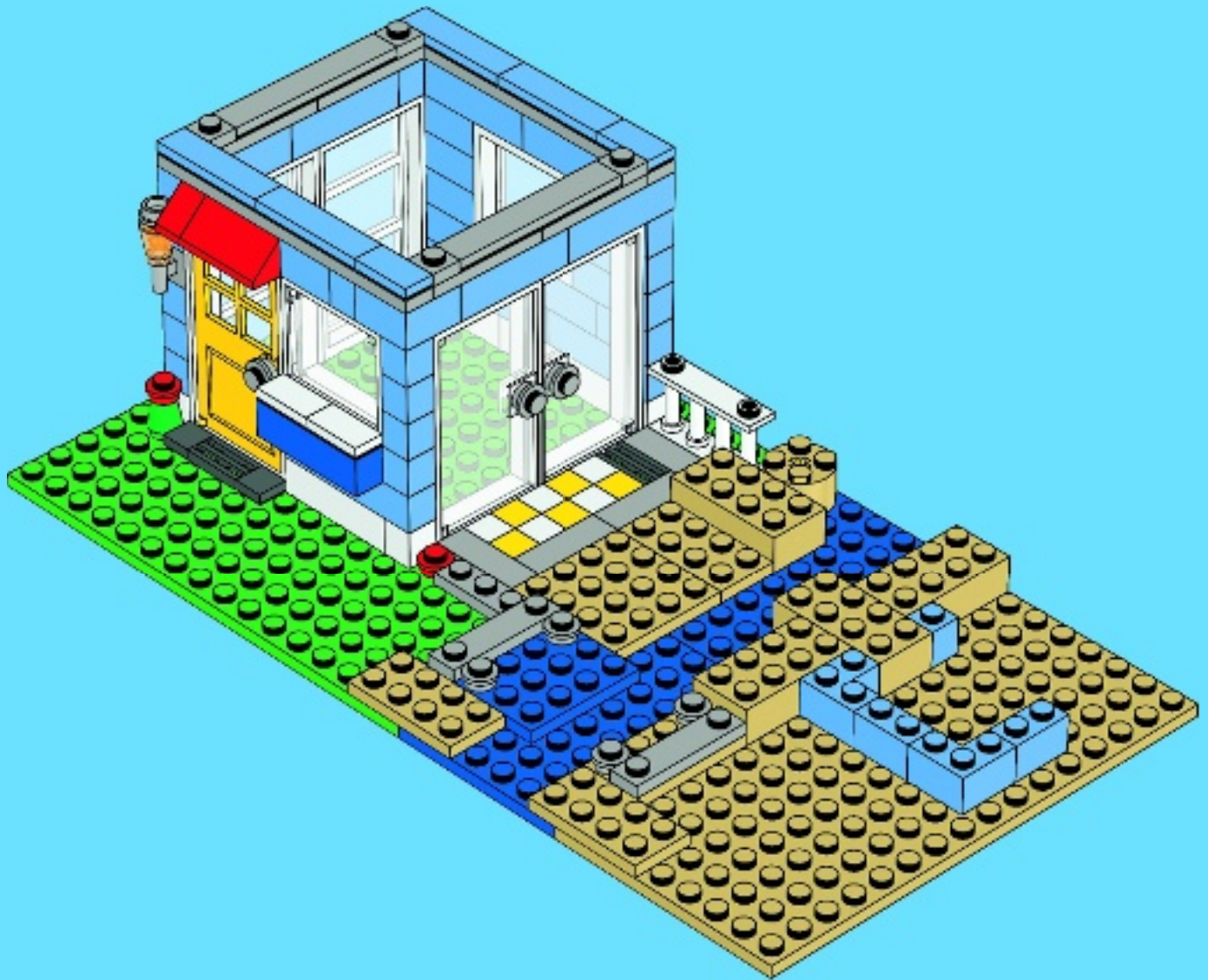



2x



1x

# 29

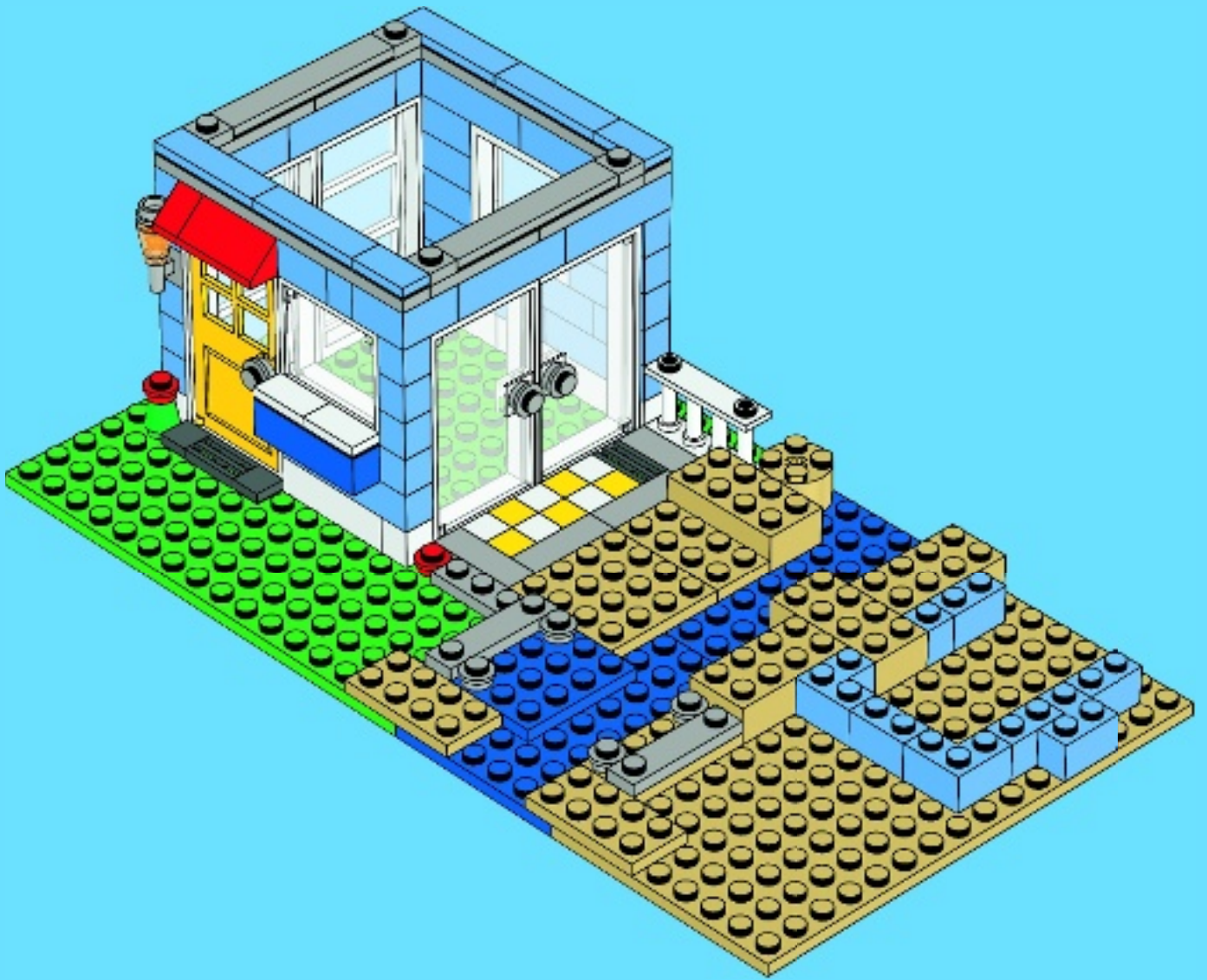



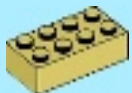

1x

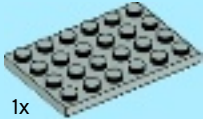

1x

# 30

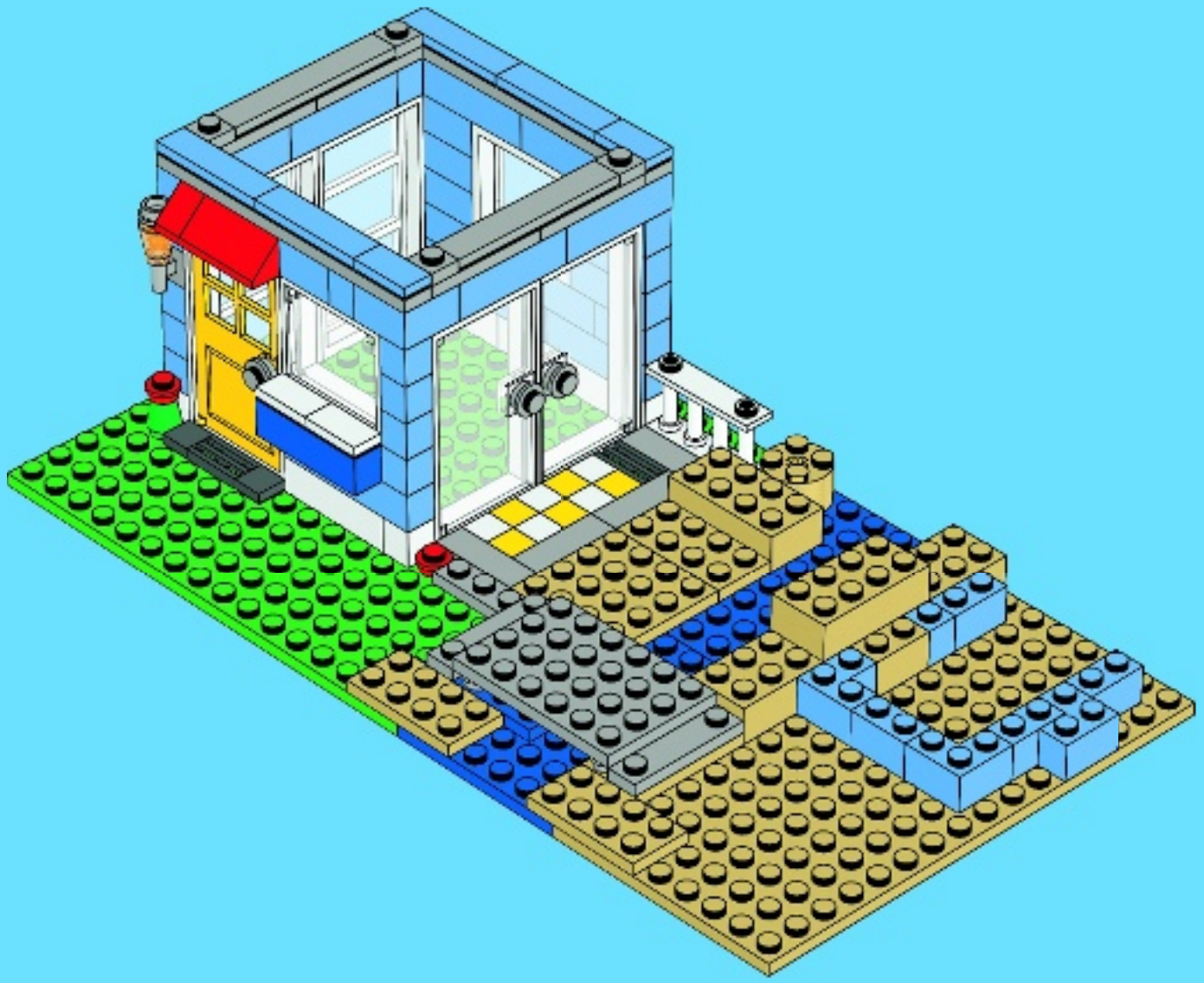



1x



1x



2x



3x

# 31

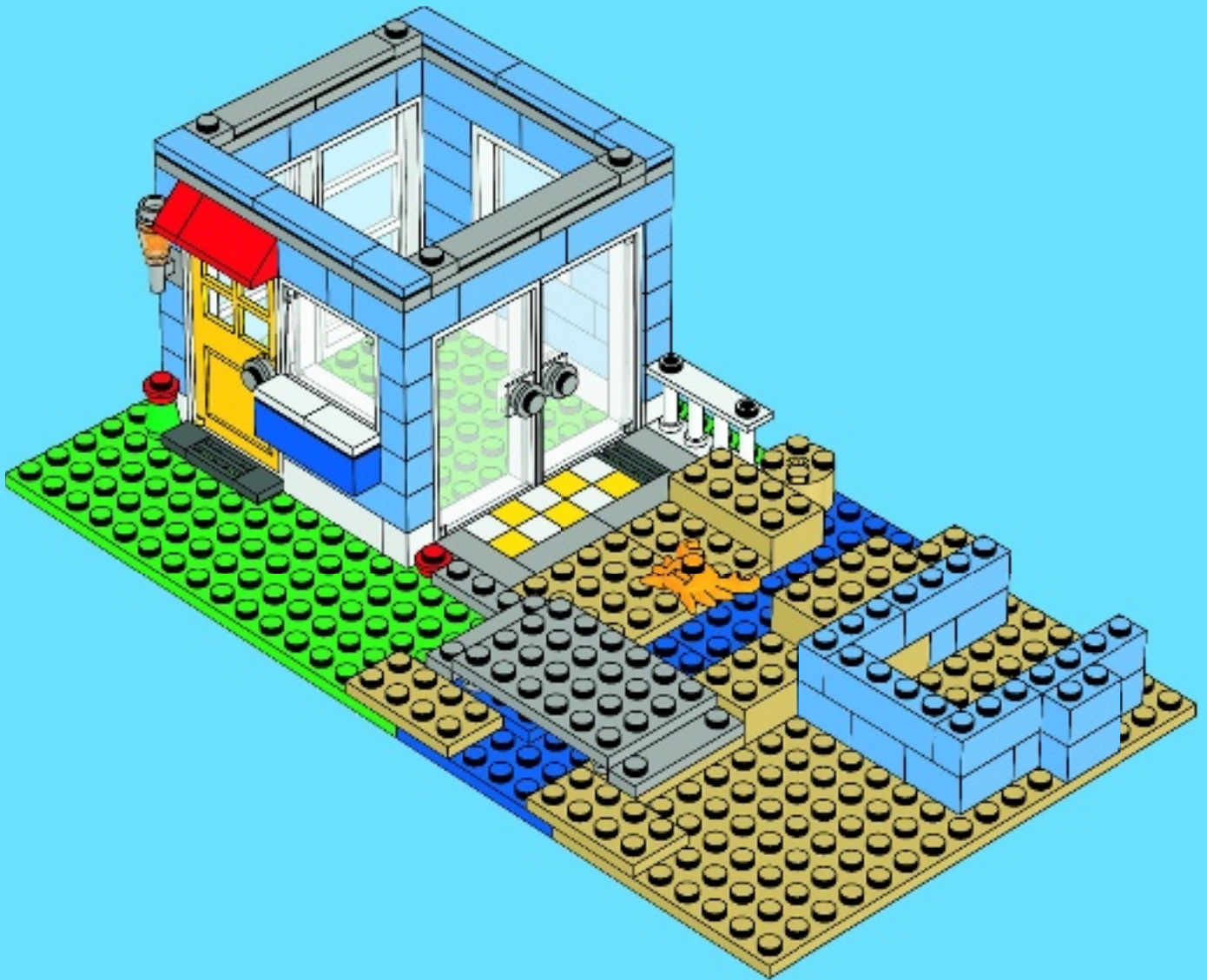

3x

1x

2x

# 32

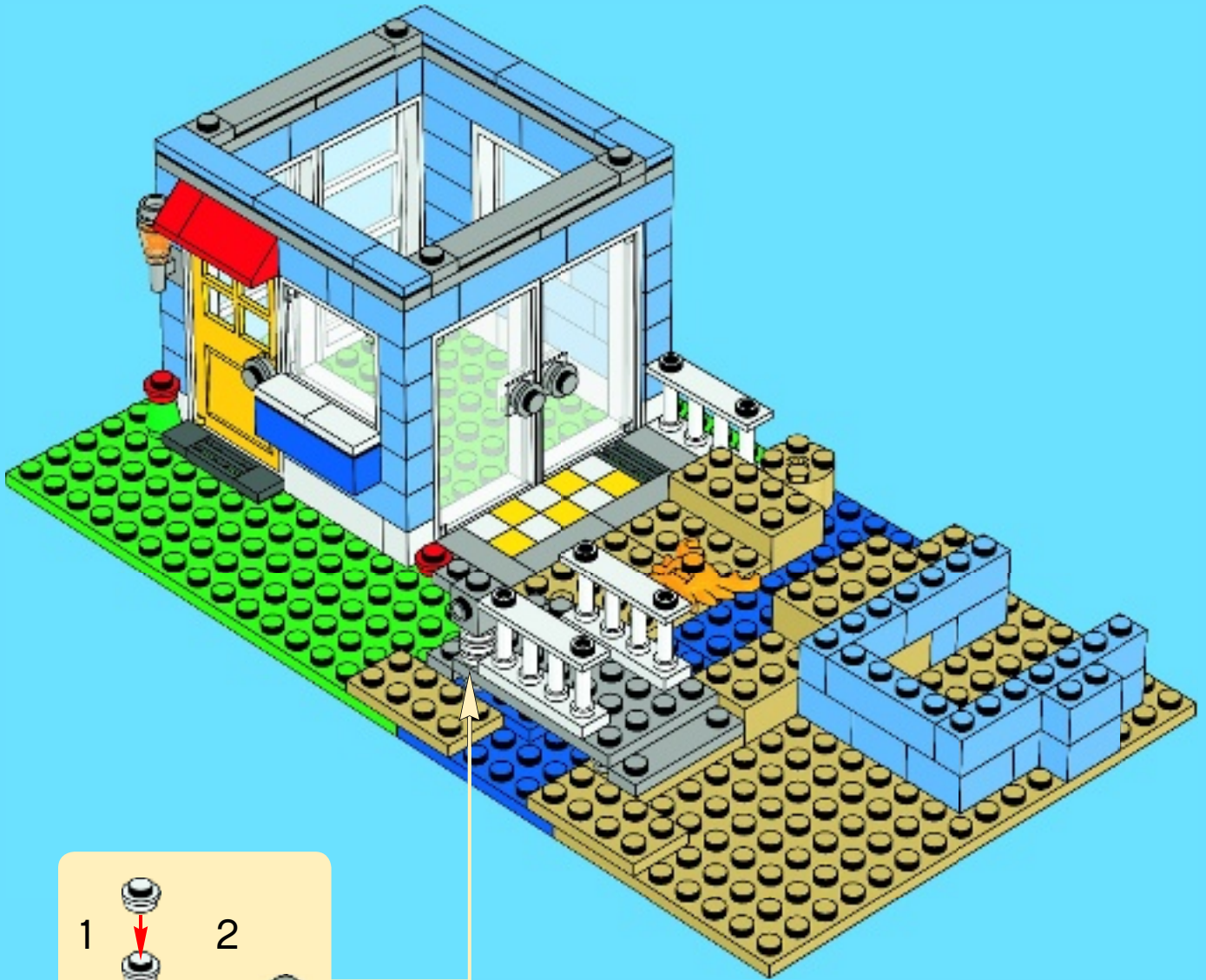

1



2







6x



1x

# 33

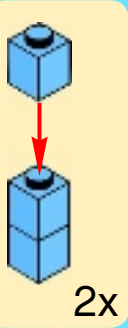
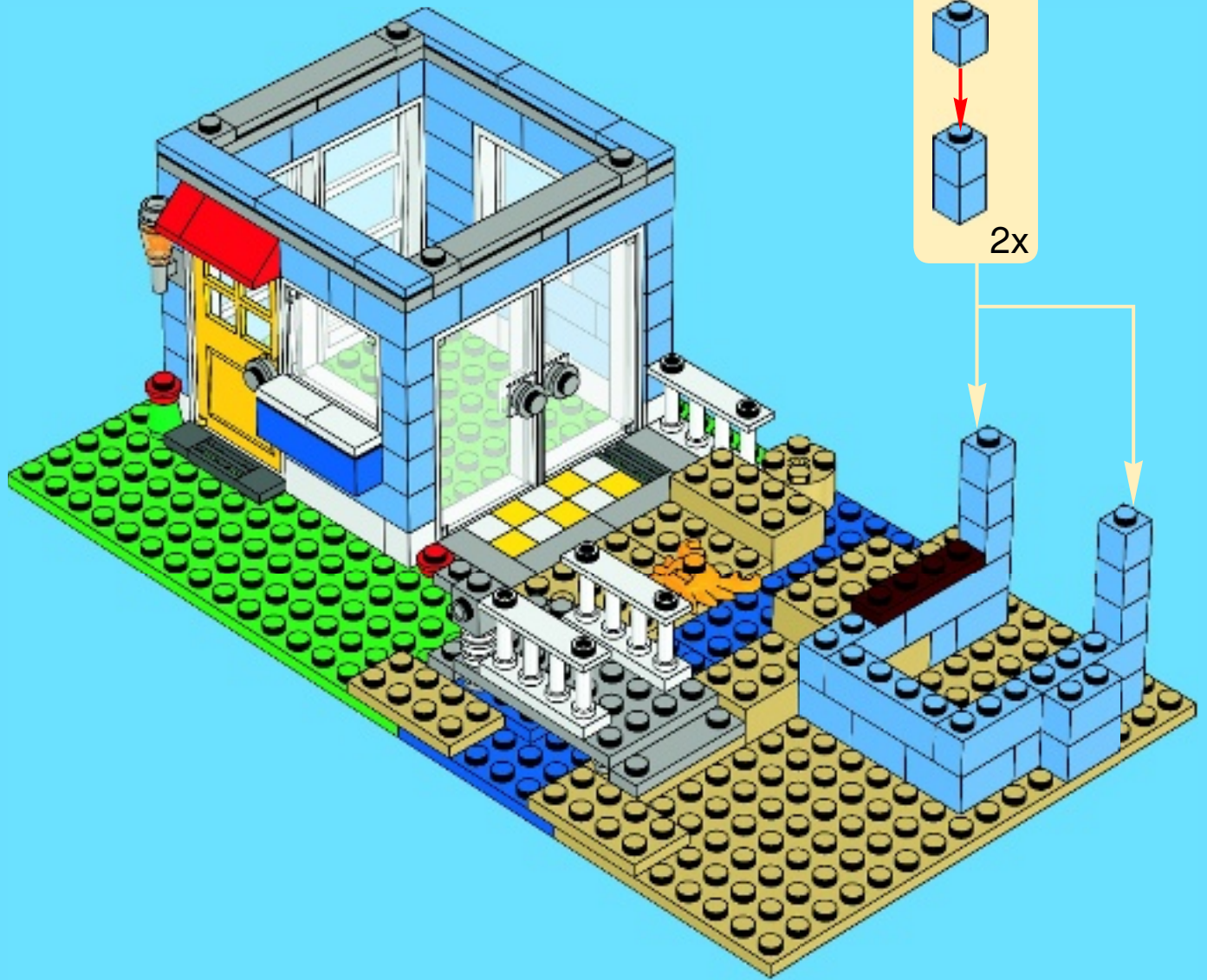

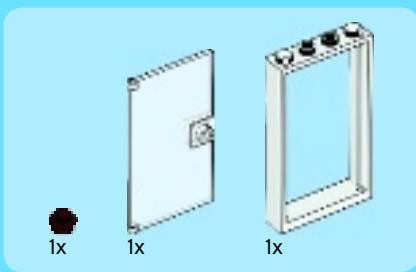

34

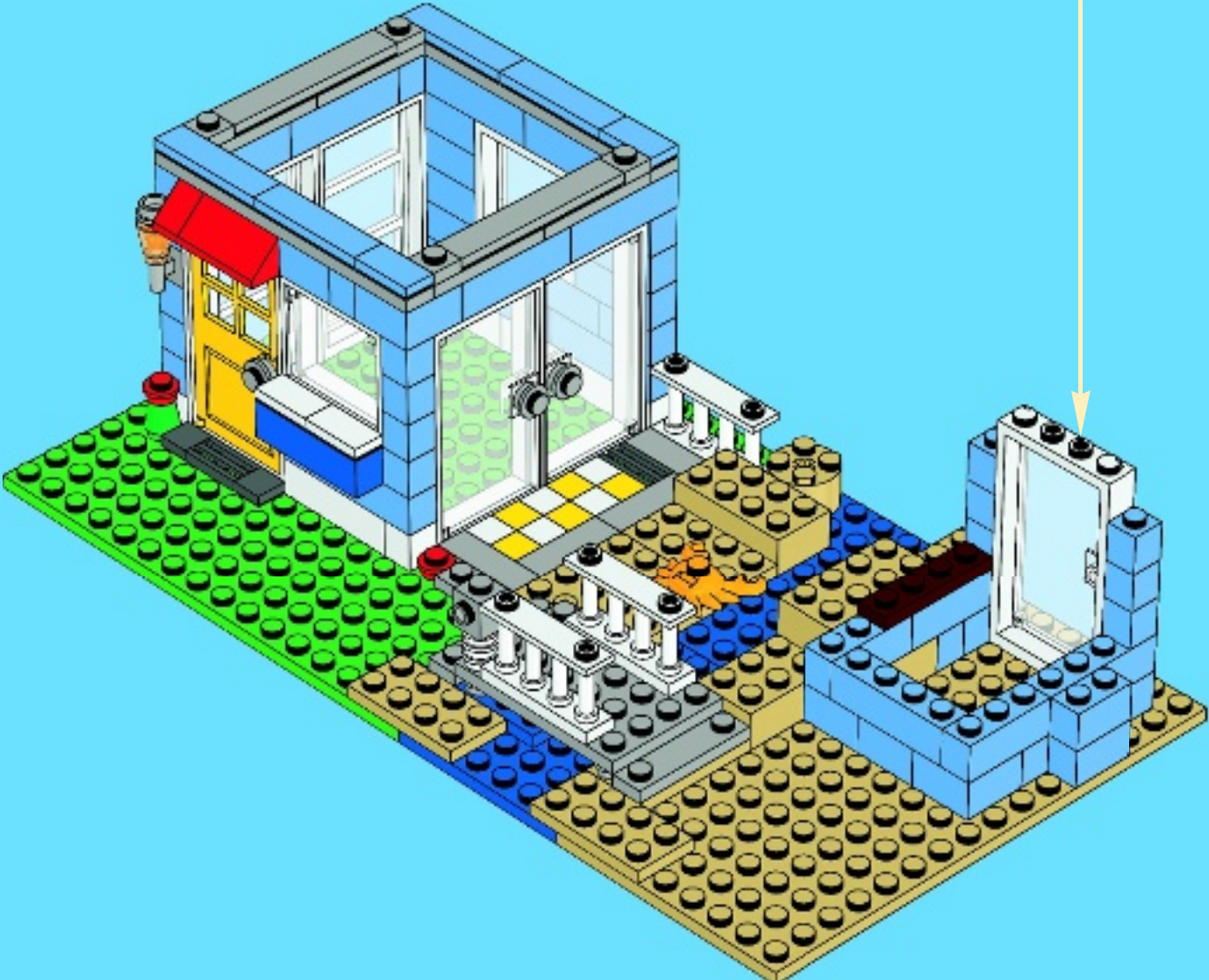
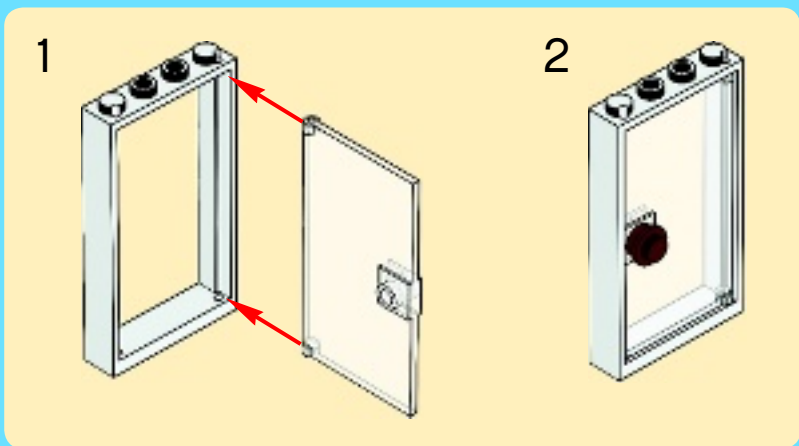



1x



1x

1

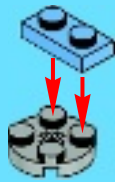

1x

2



1x



1x



1x

3



1x



1x

4

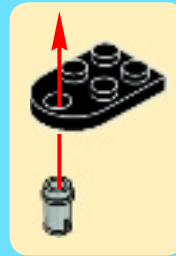

4x

5



1x

6







1x



1x

7

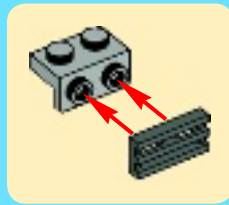

35





36

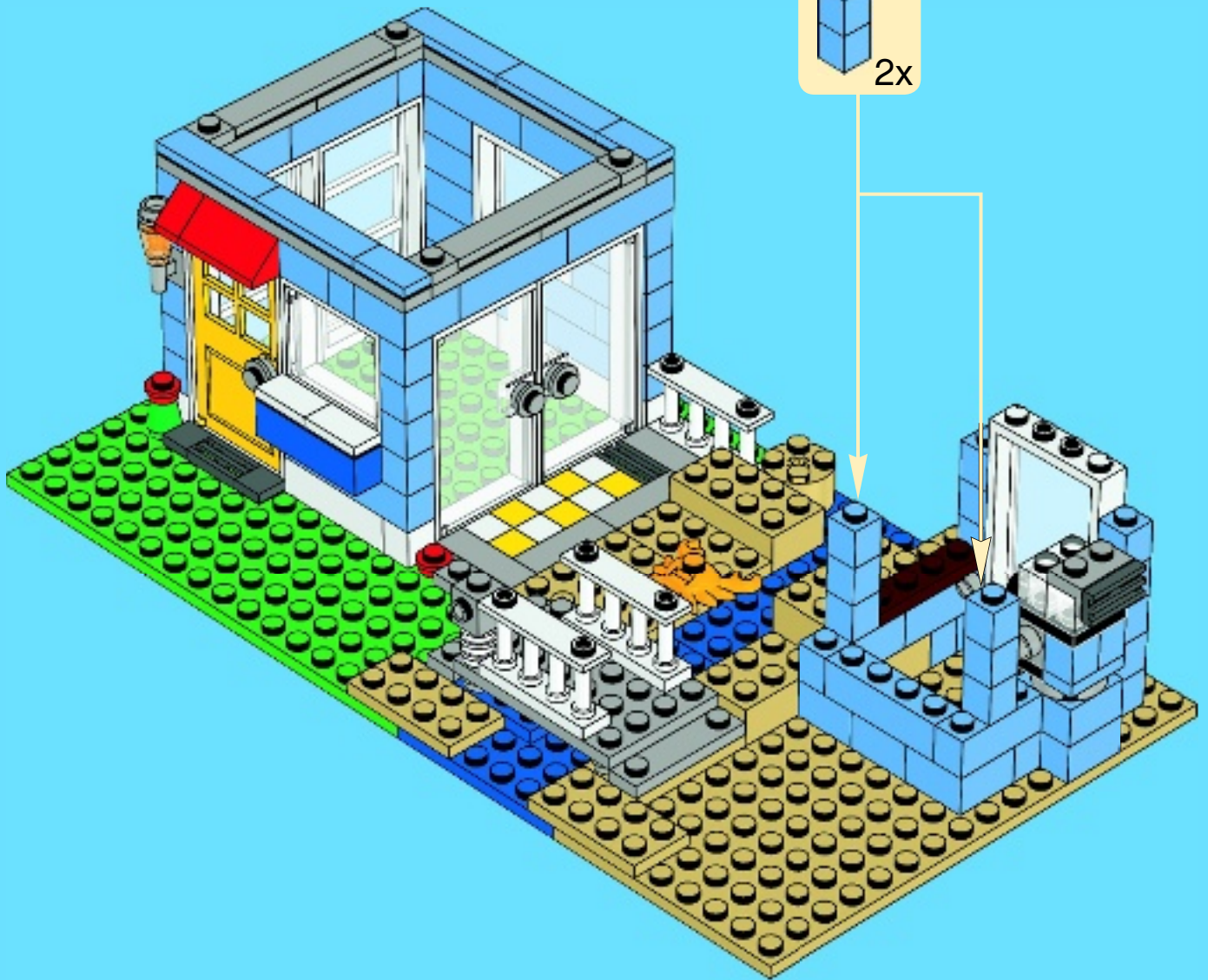
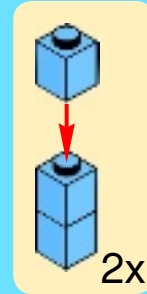





1x



2x

# 37

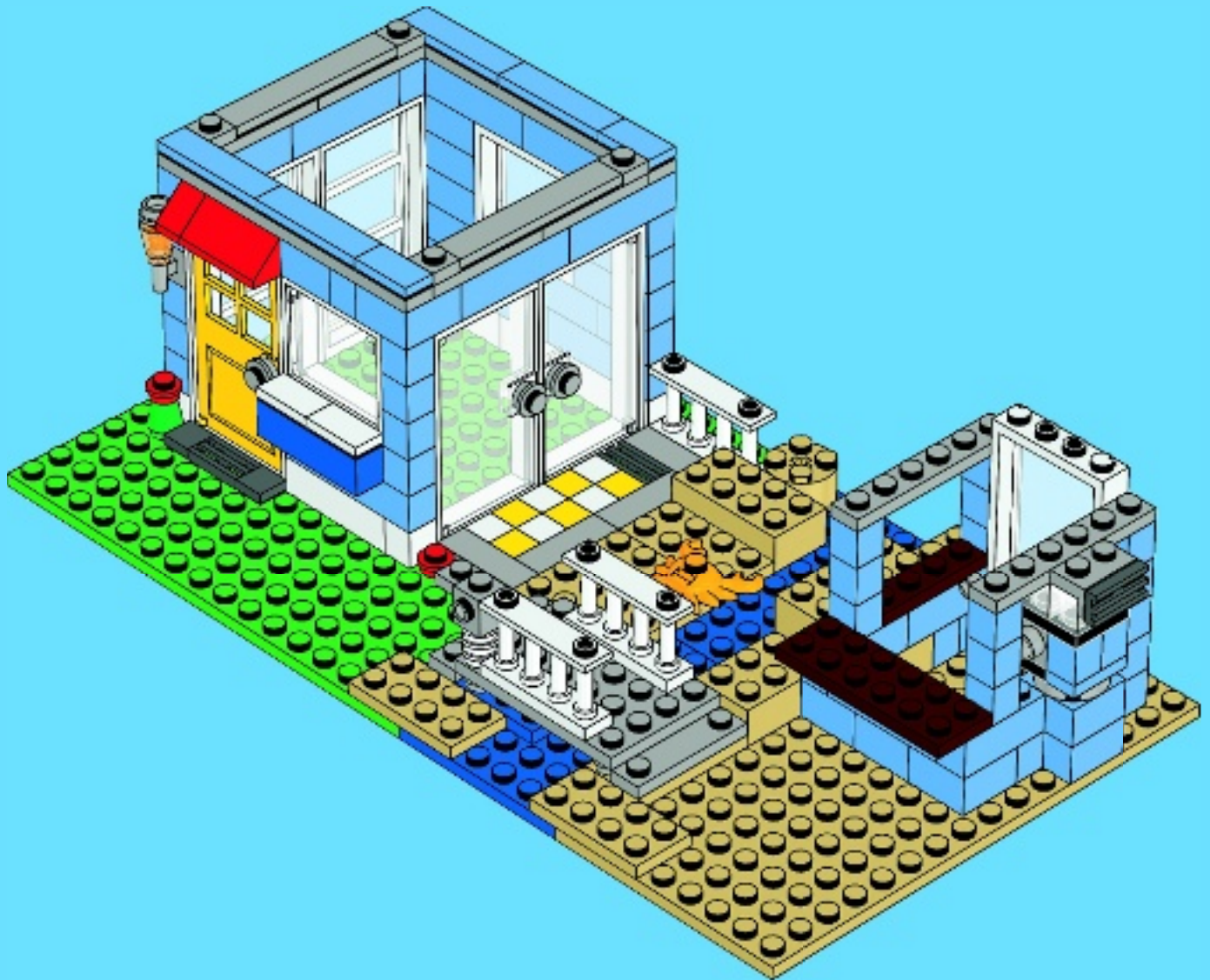



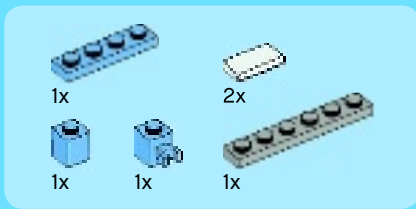

38





39

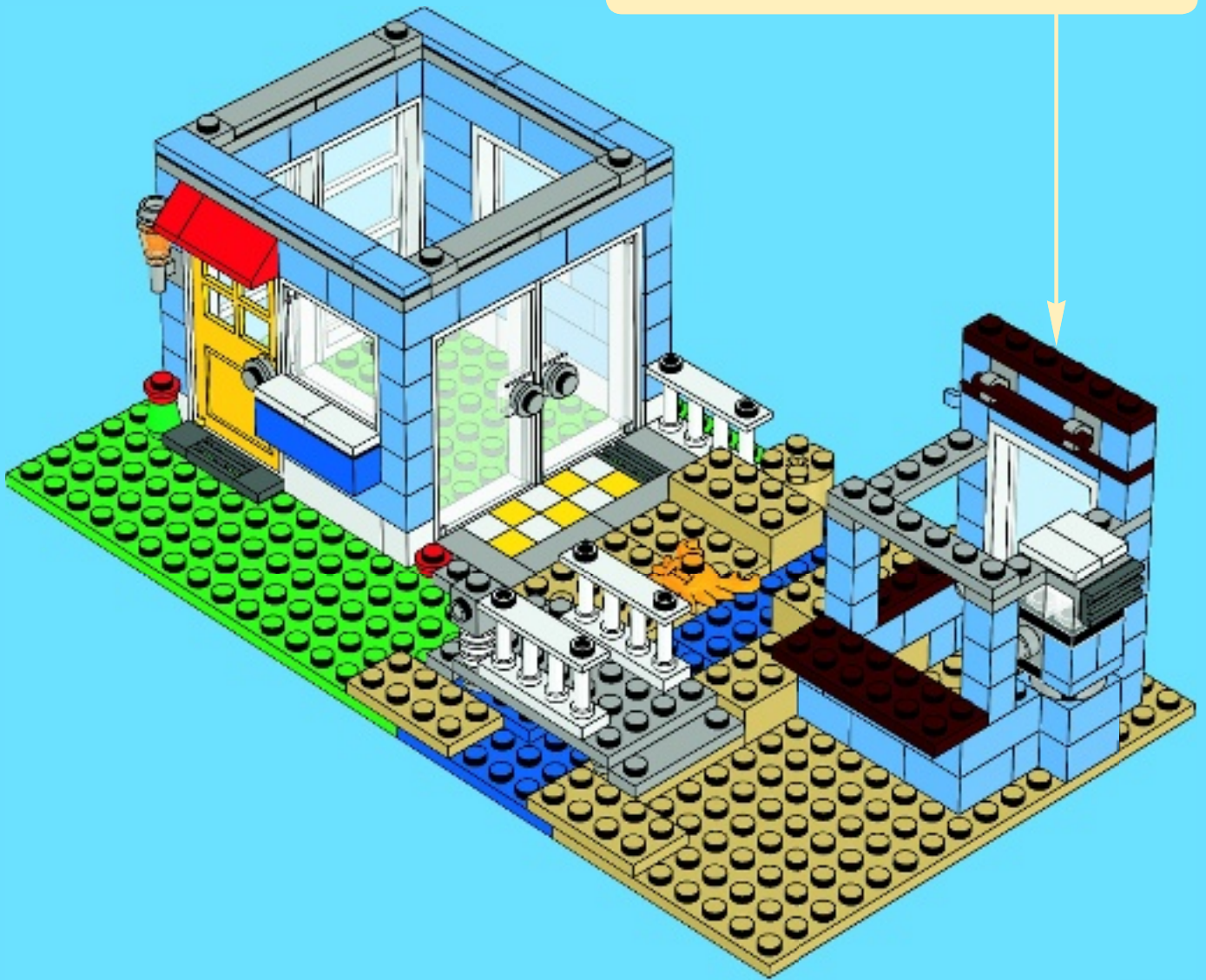
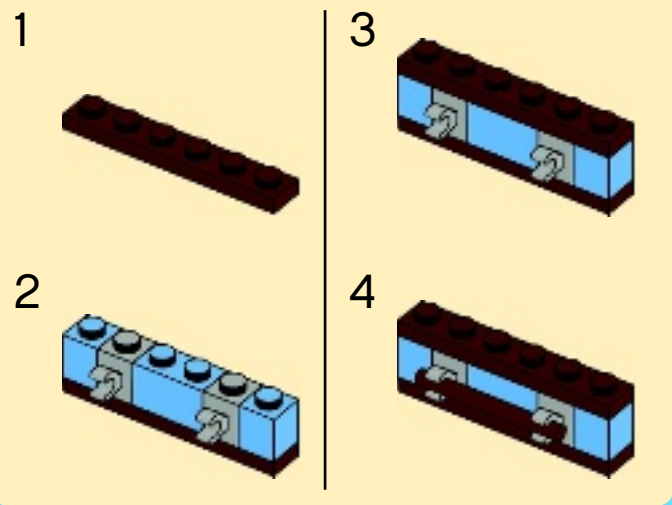





40

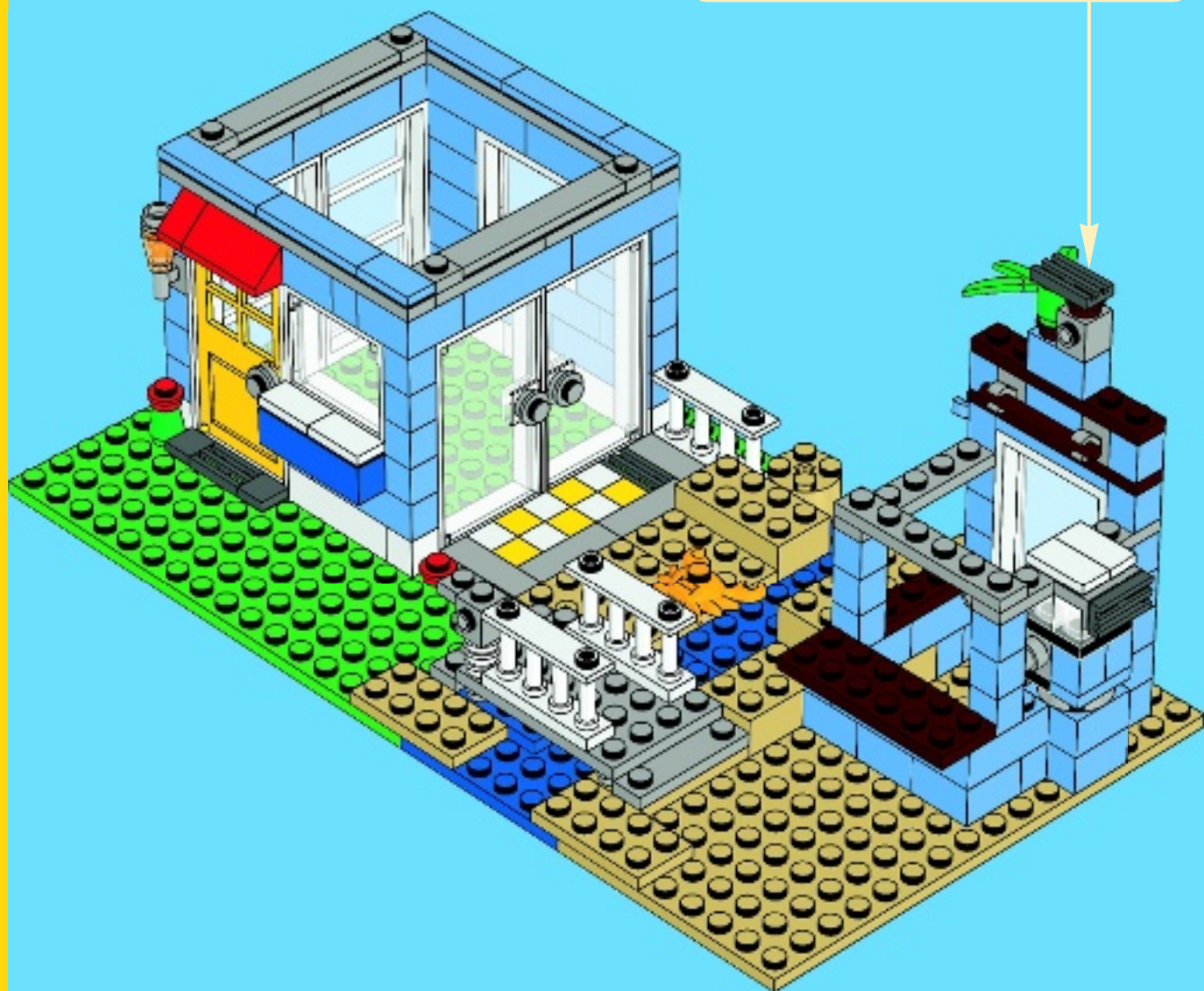
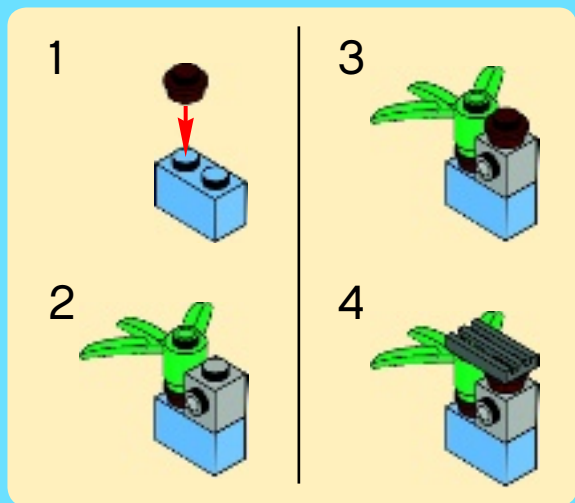





2x



1x



1x



1x

# 41

1



2



3

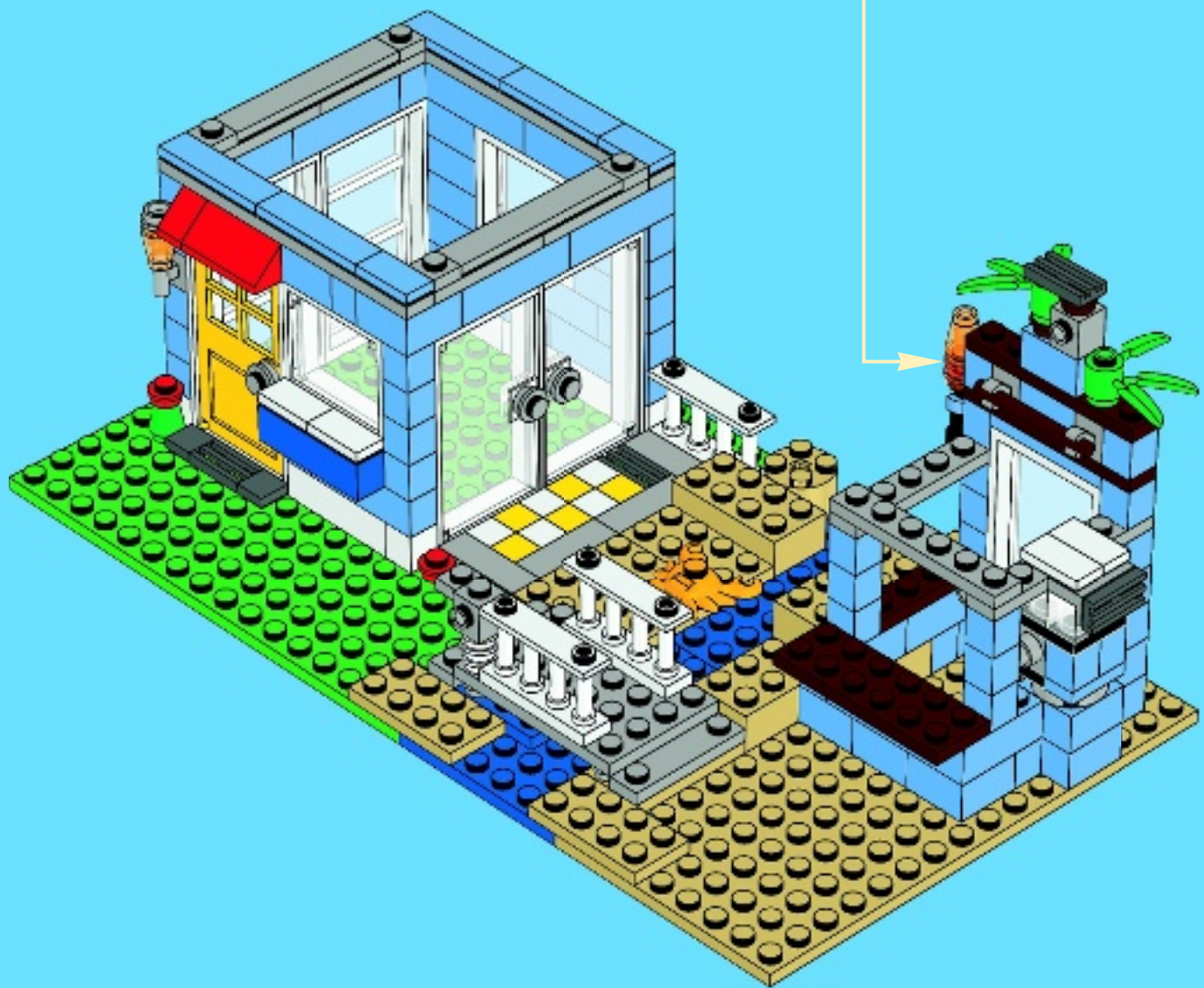

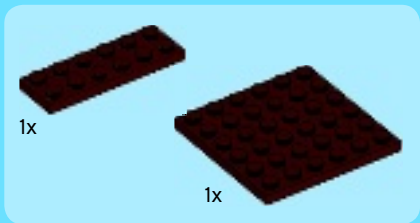

1

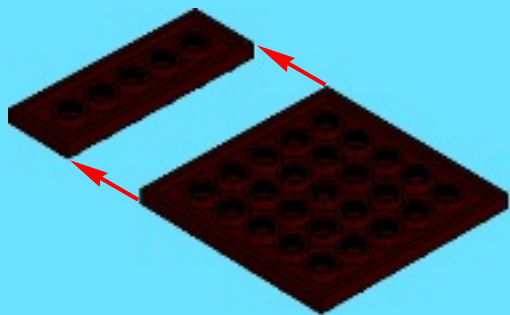

2

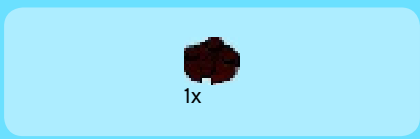

3



4

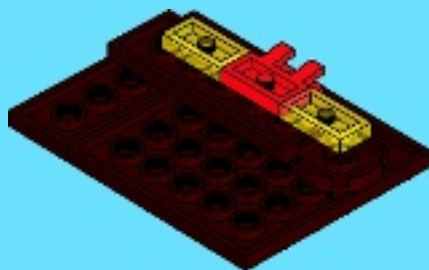

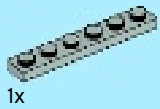

1x

5



2x

6

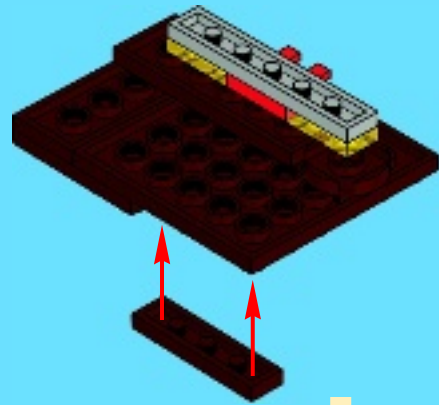

42

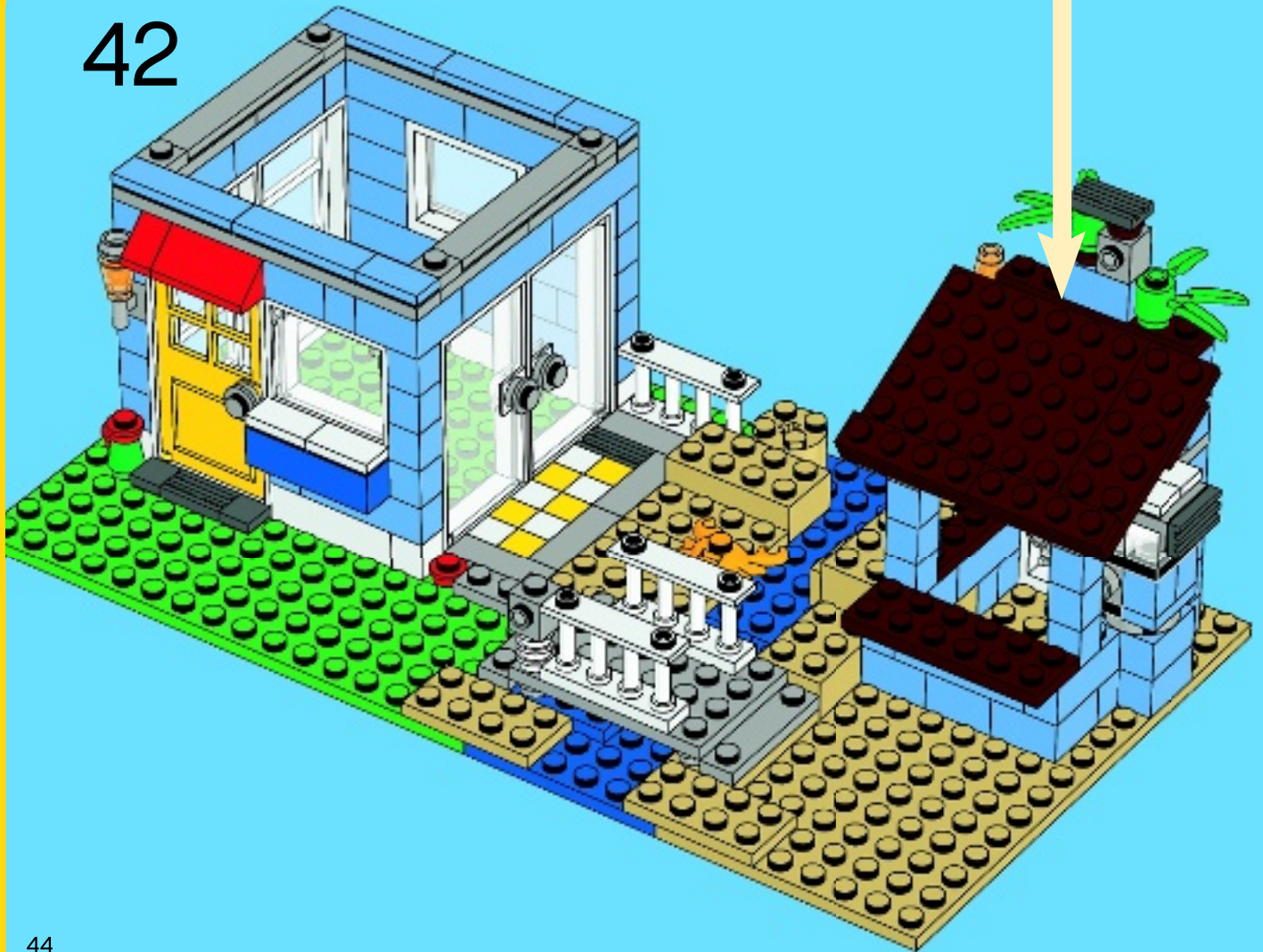





5x



1x



4x



1x

# 43

1



2



3



4



5



6

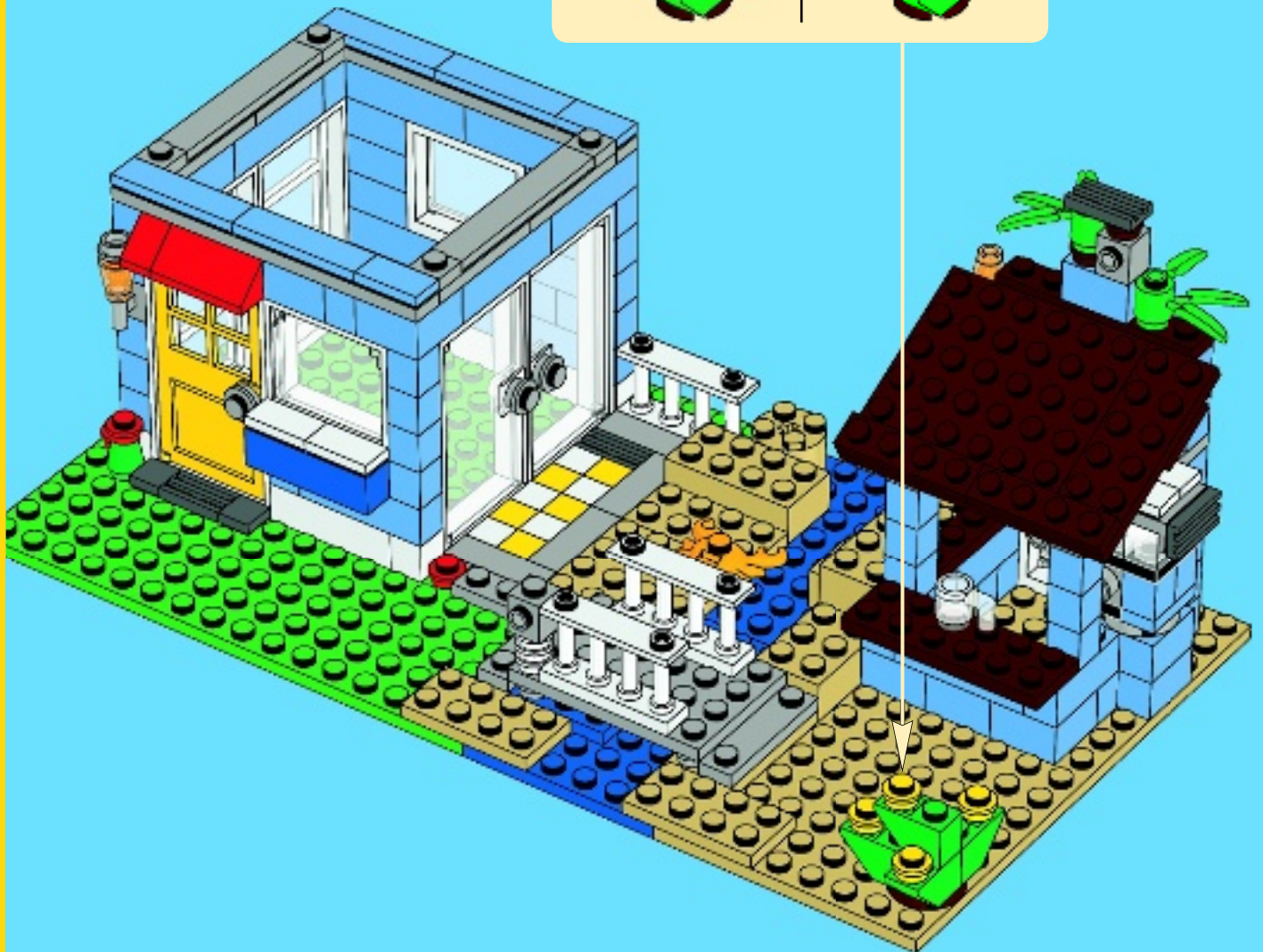

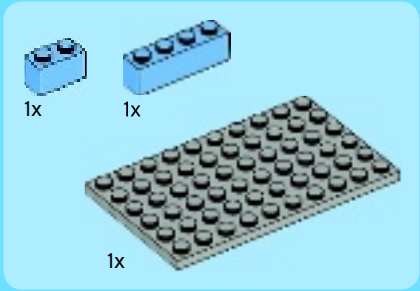

1

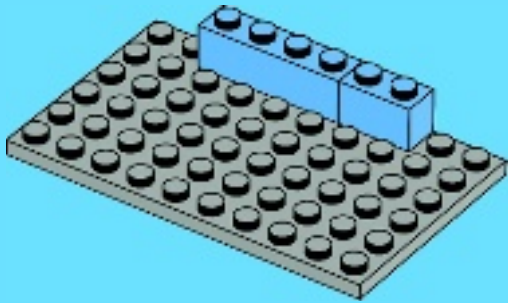

2

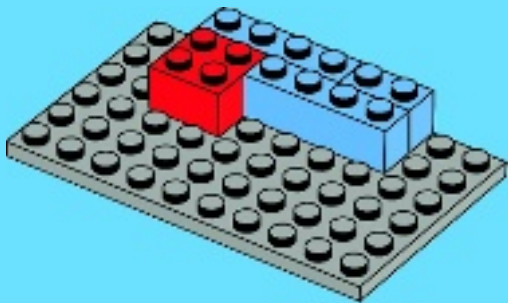

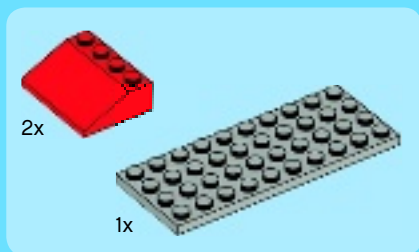

3

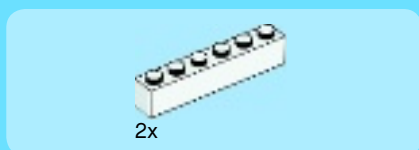
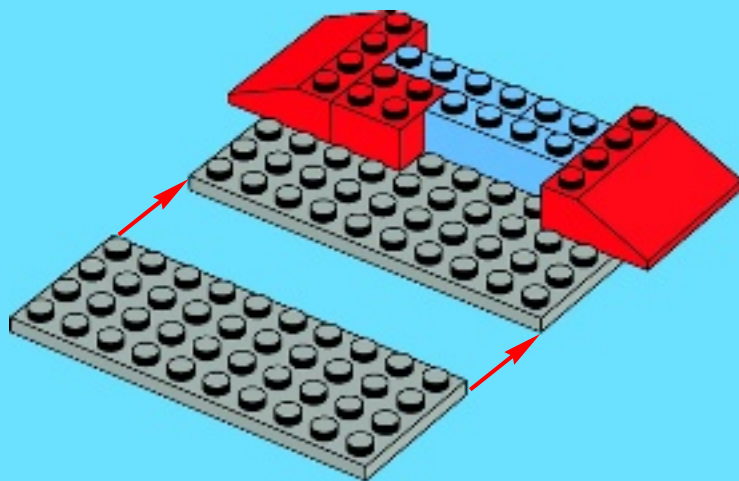

4

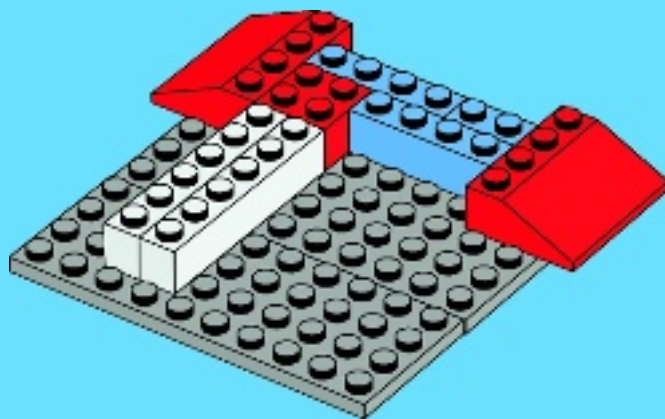





1x



2x

5

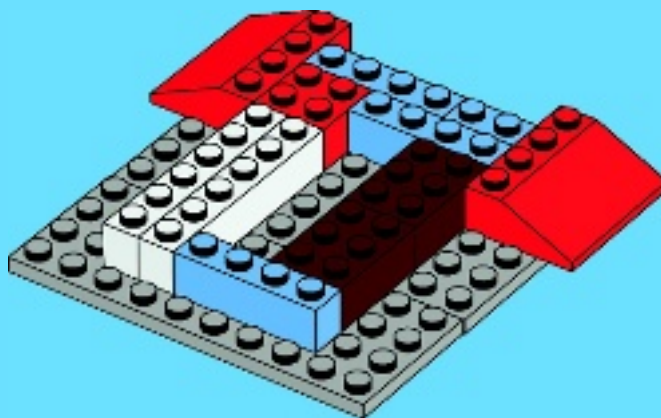

4x

6

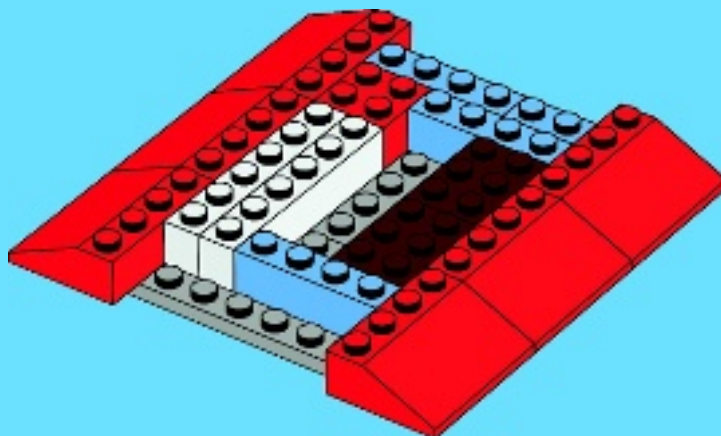



1x



1x





2x



2x

# 7

1  2  3 

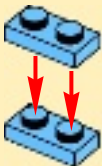
1 

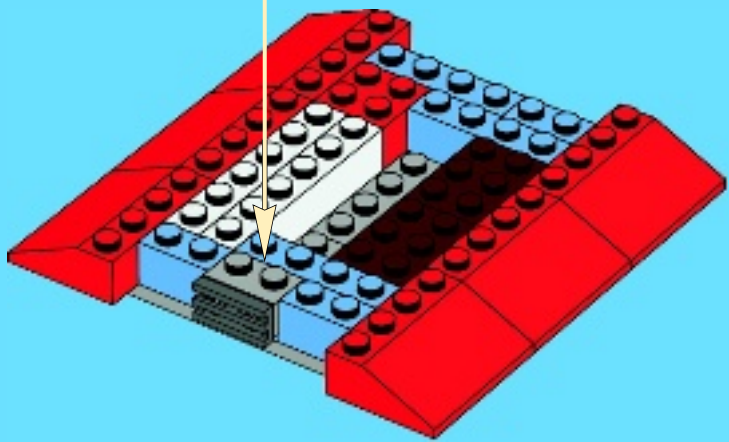

6x

# 8

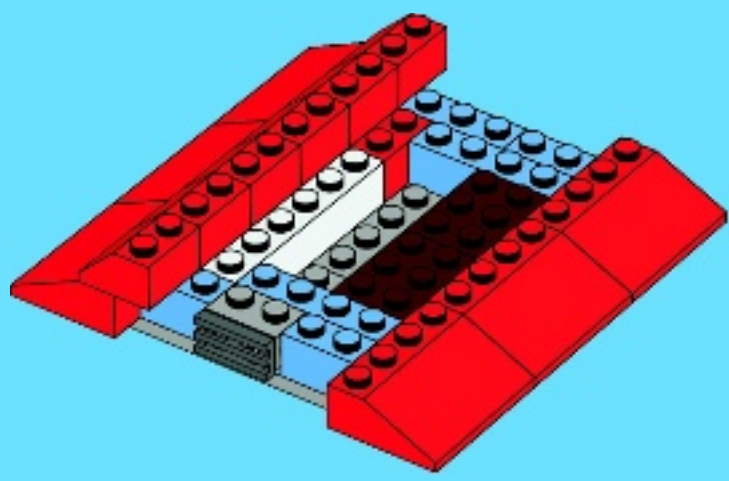

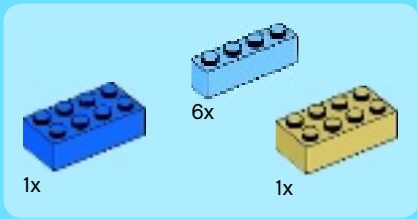

9

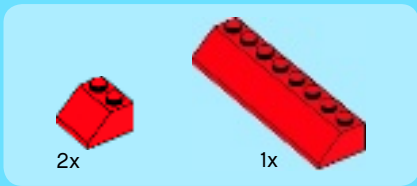
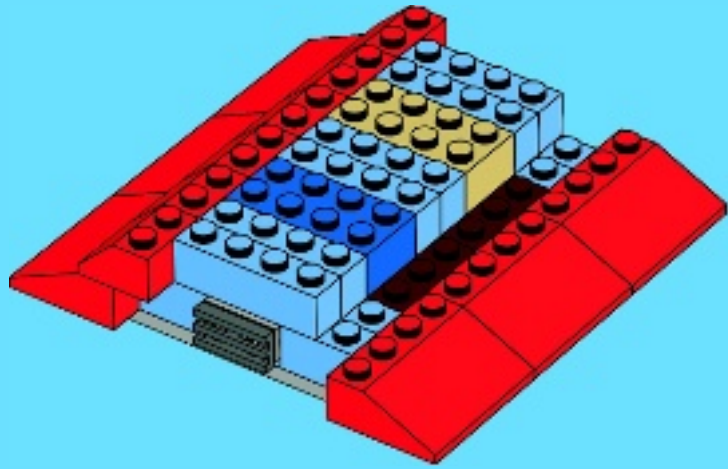

10

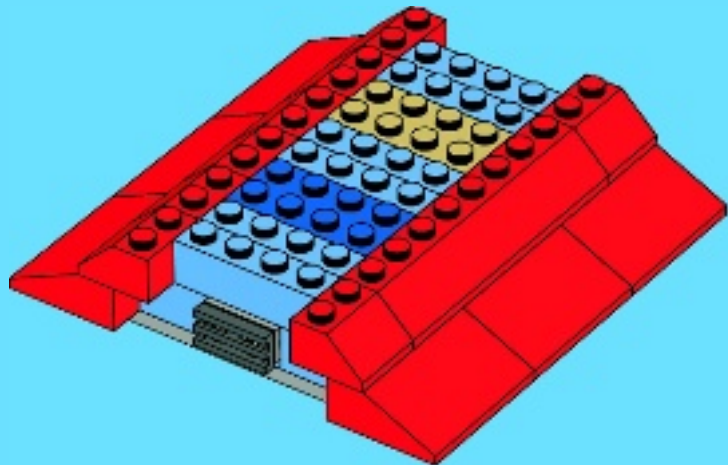



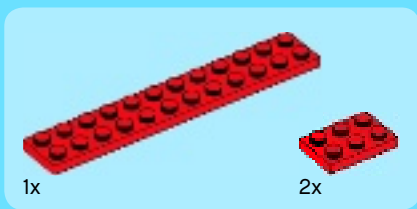

11

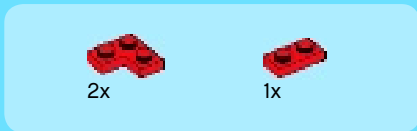
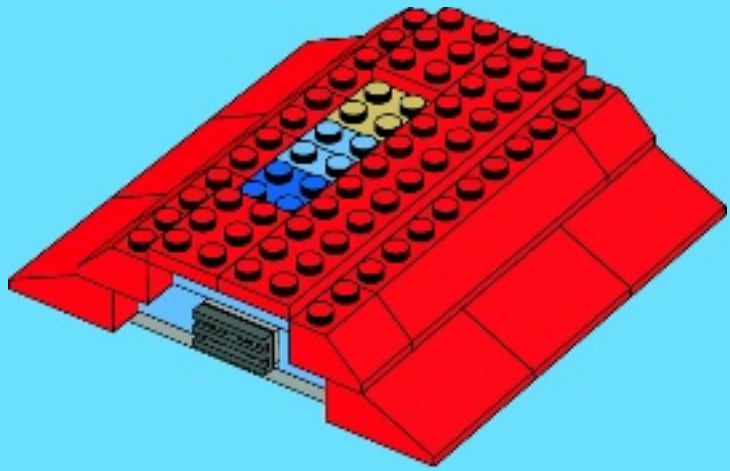

12

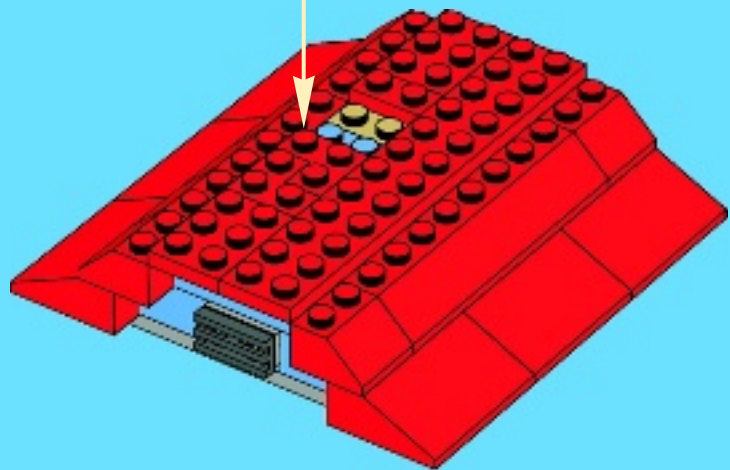



2x



2x

# 13

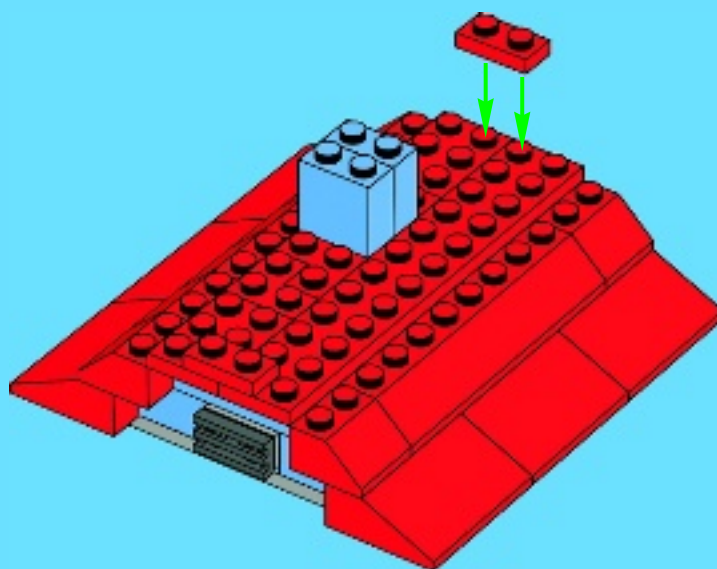

1x



2x

# 14

1



2

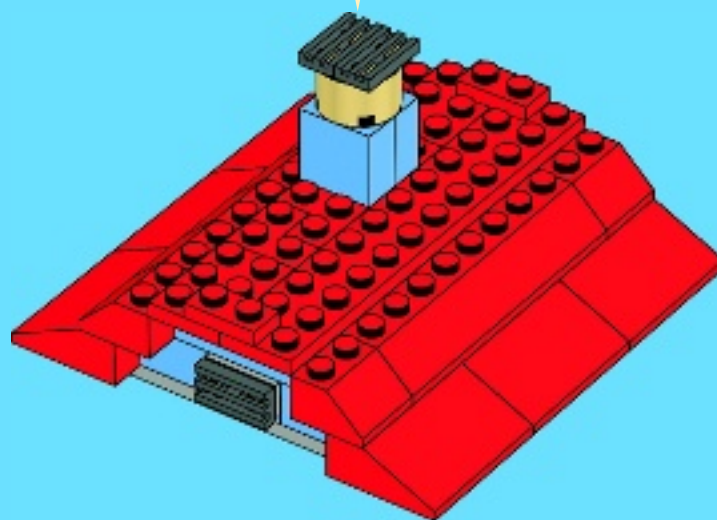



15

1  
2  
3  
4  
5

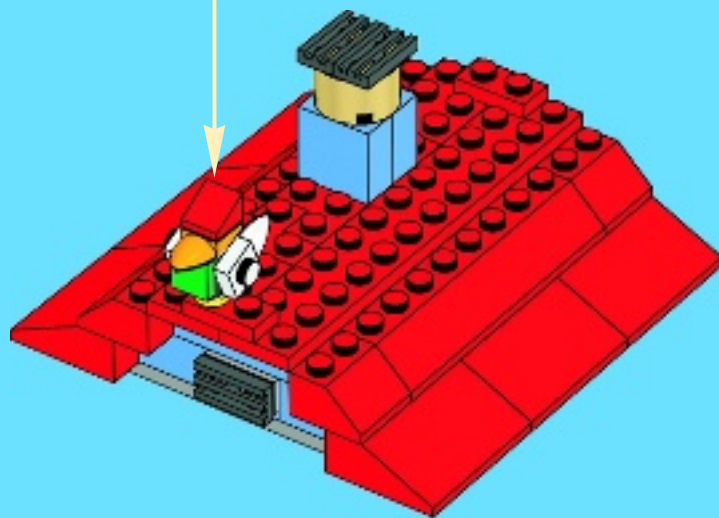



44



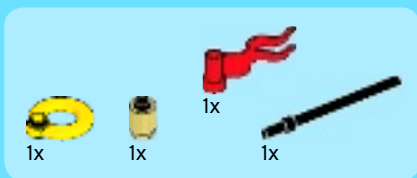

45

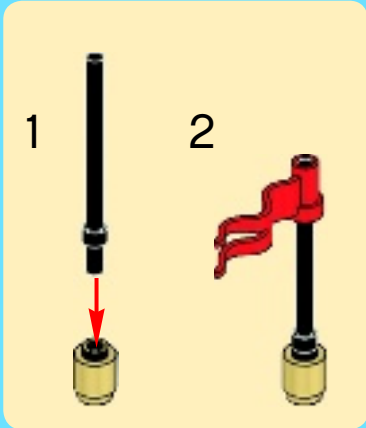



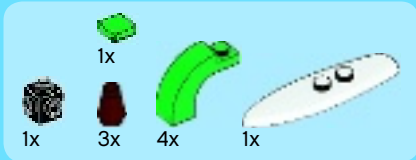

# 46

