

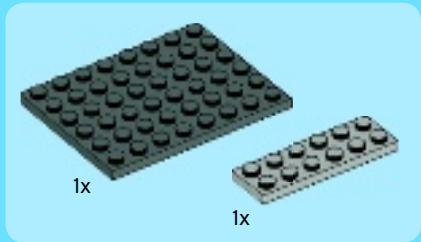

10226

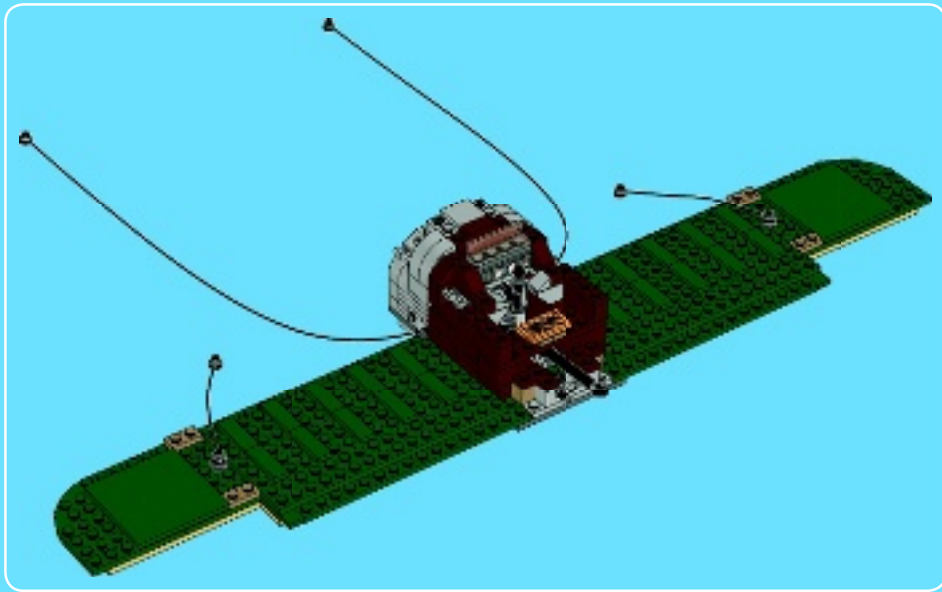



1

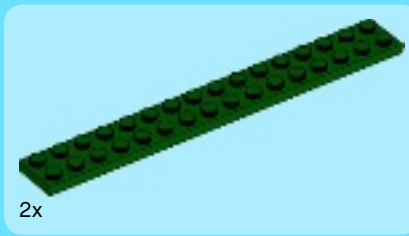

2

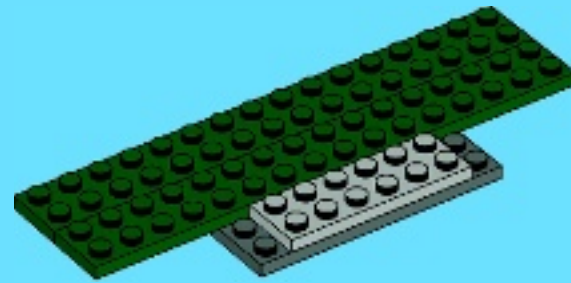

<http://lego.com/brickseparator>

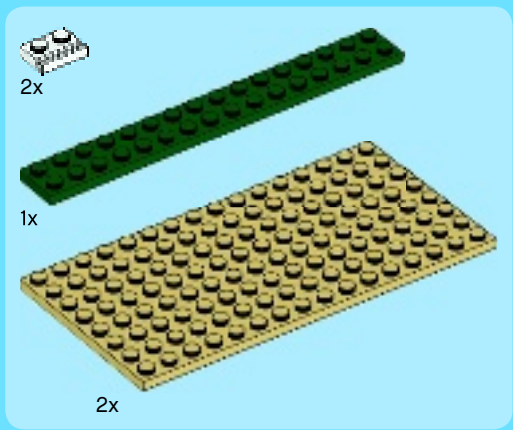

3

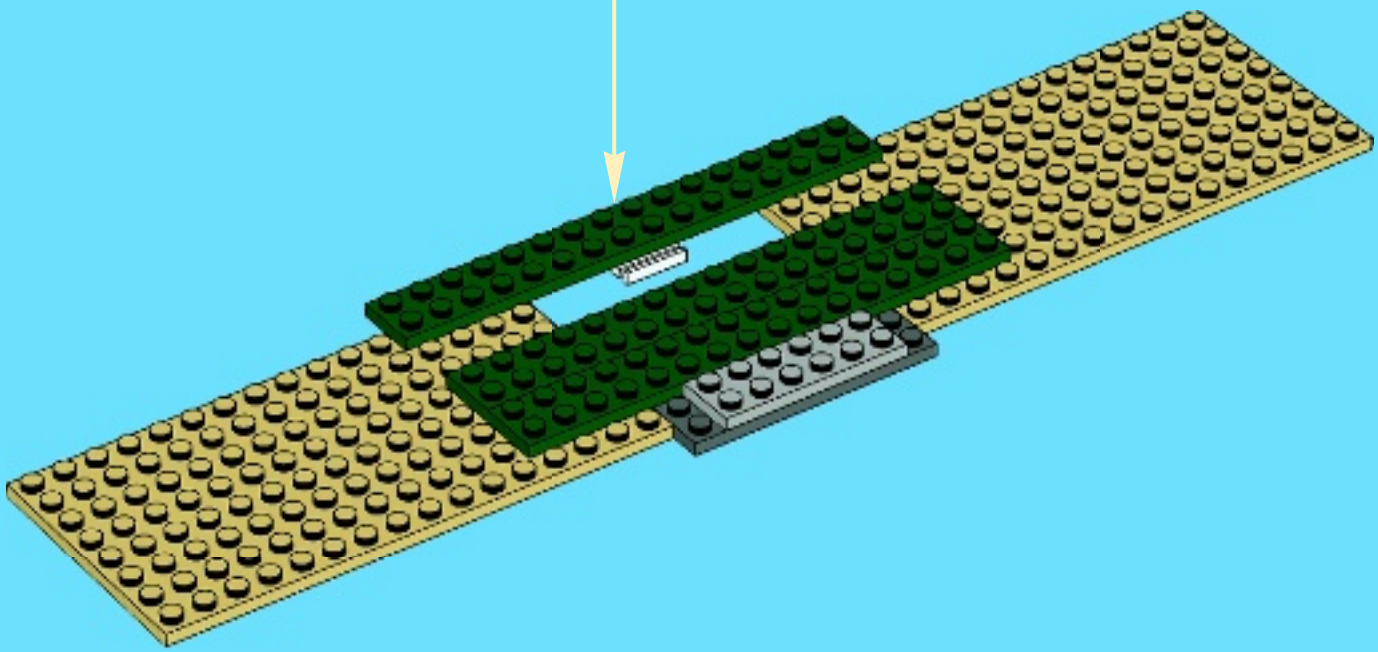
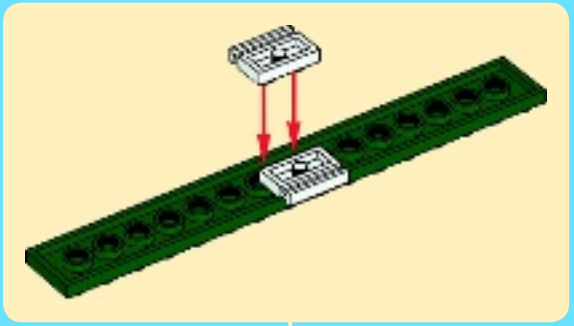

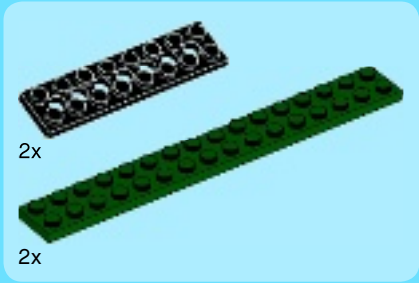

4

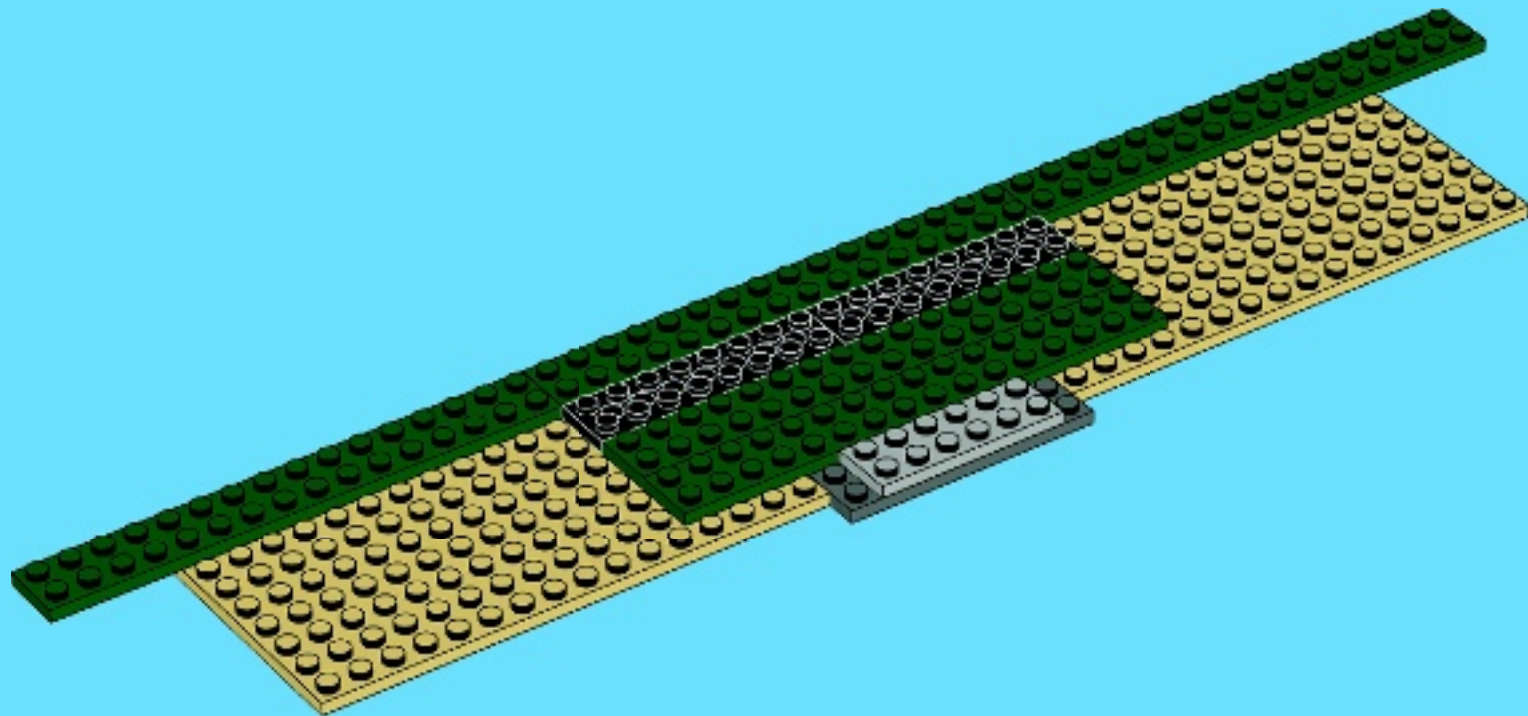



4x



6x



2x



2x

6

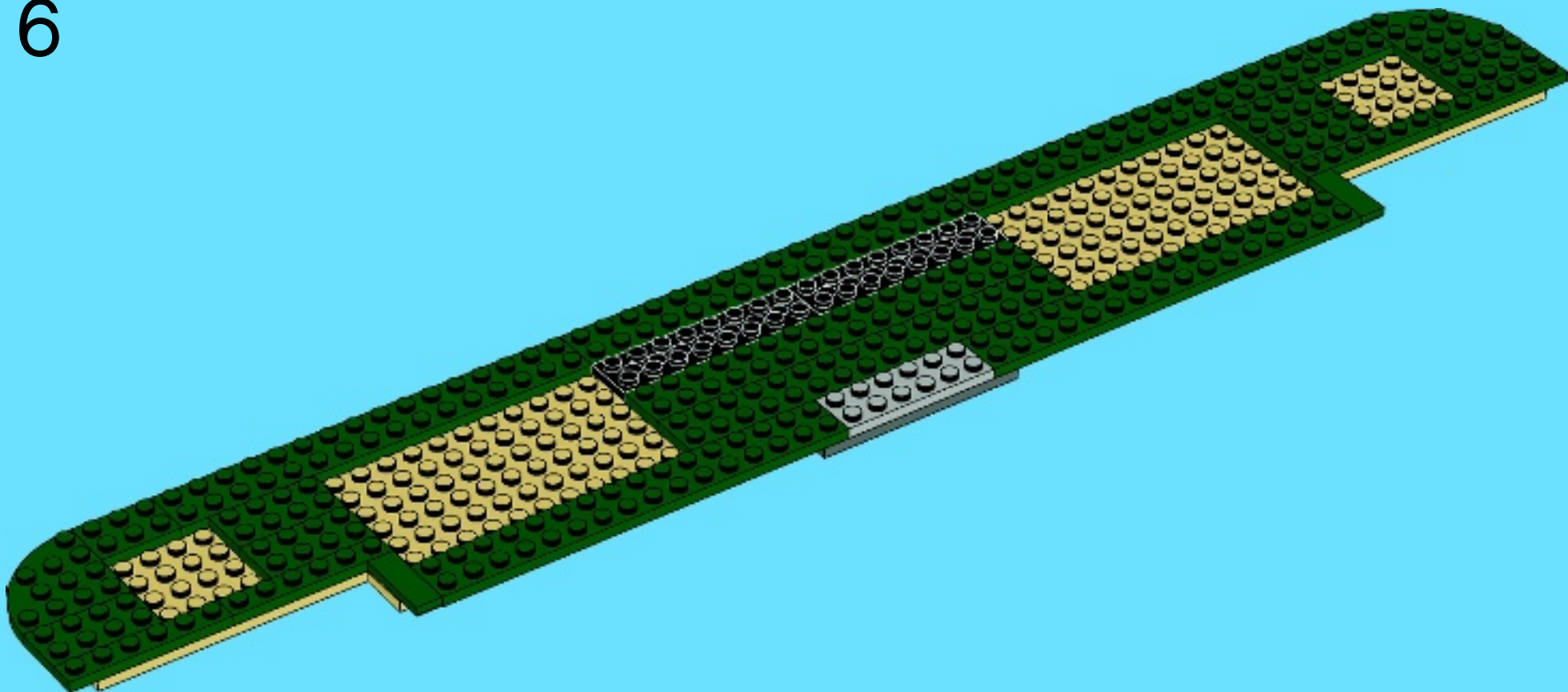

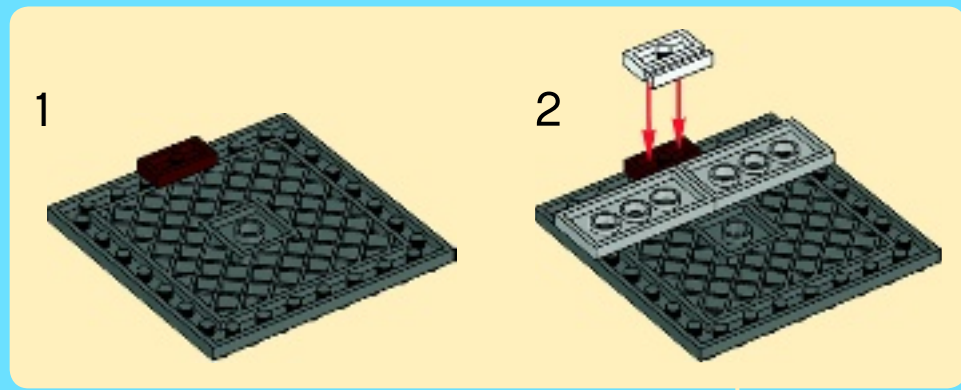
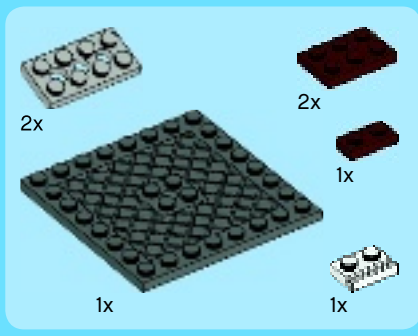

7

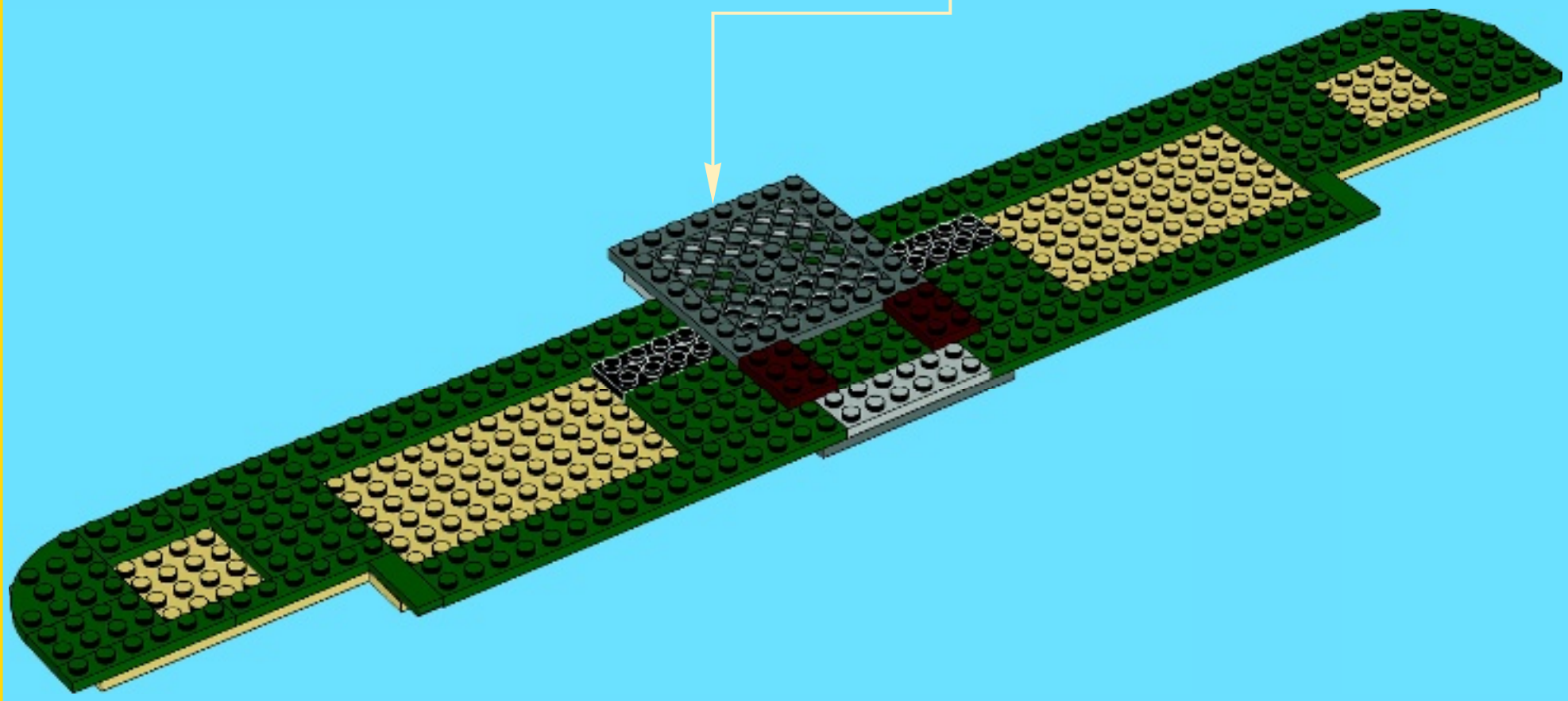

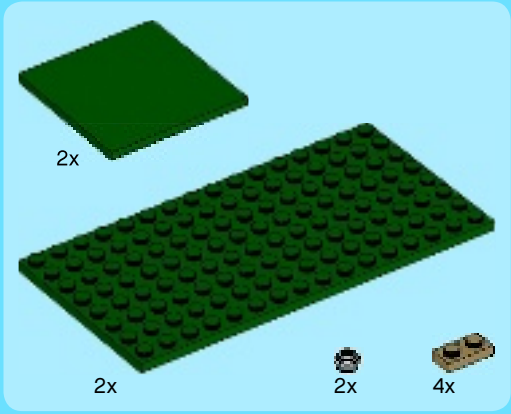

8

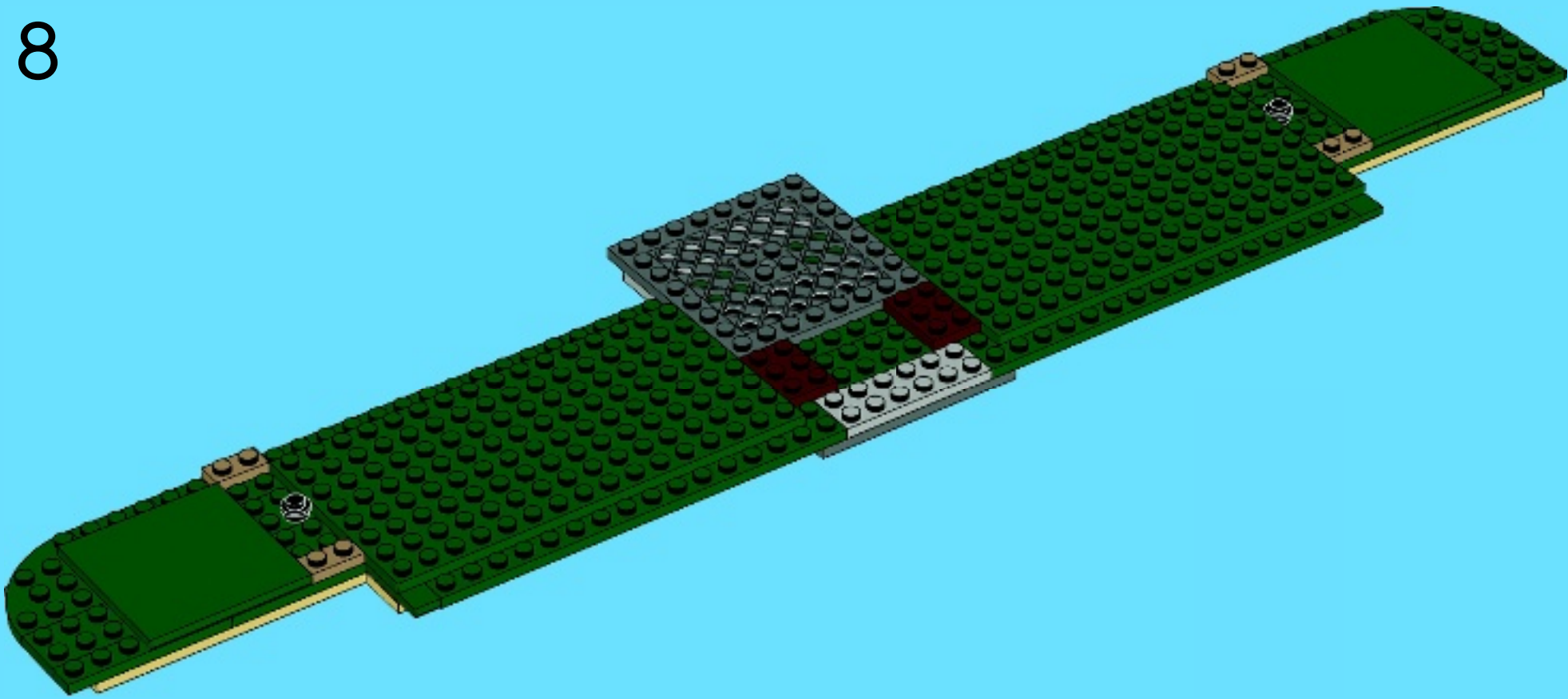

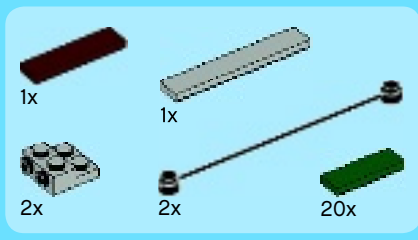

9

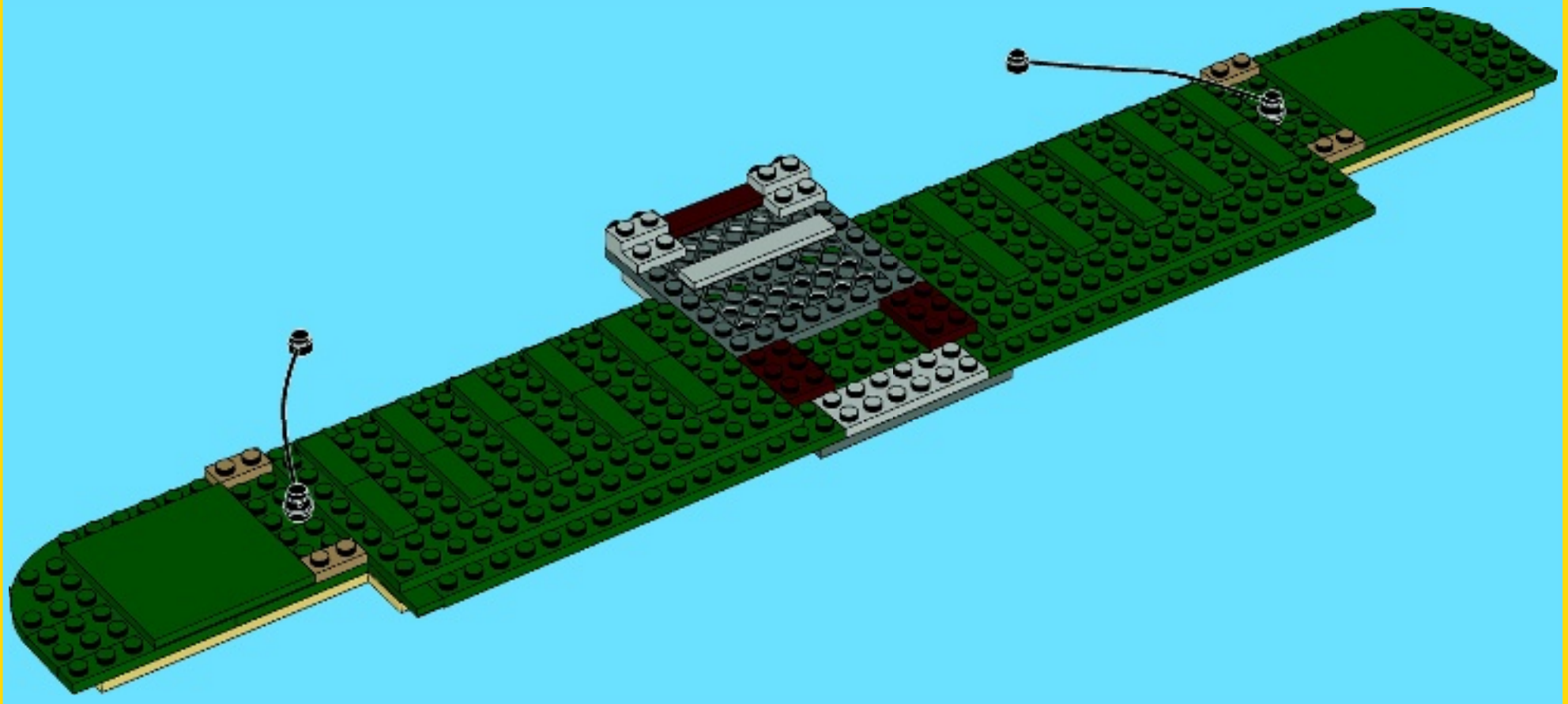



2x



1x

10



2x

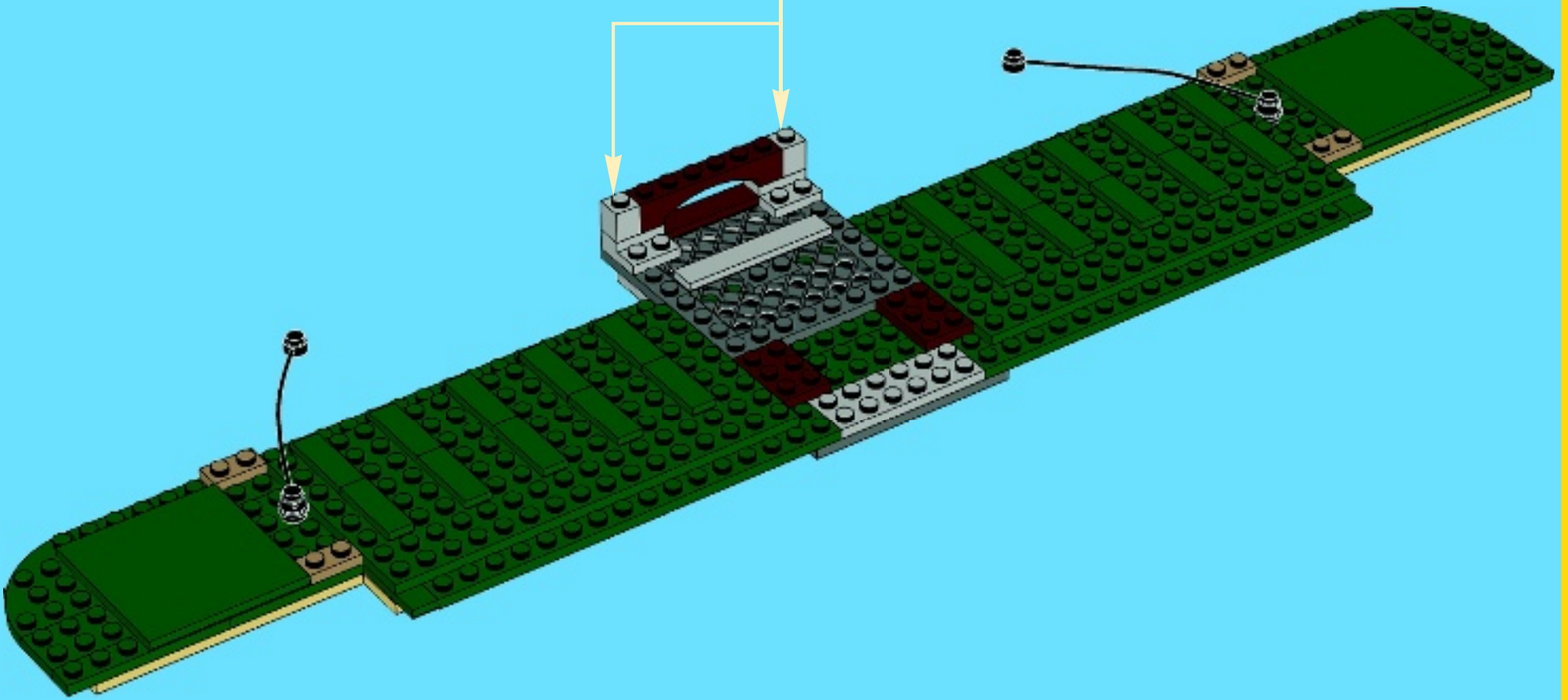

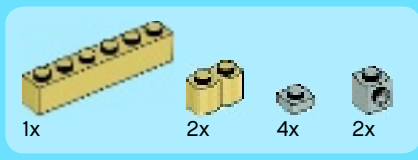

11

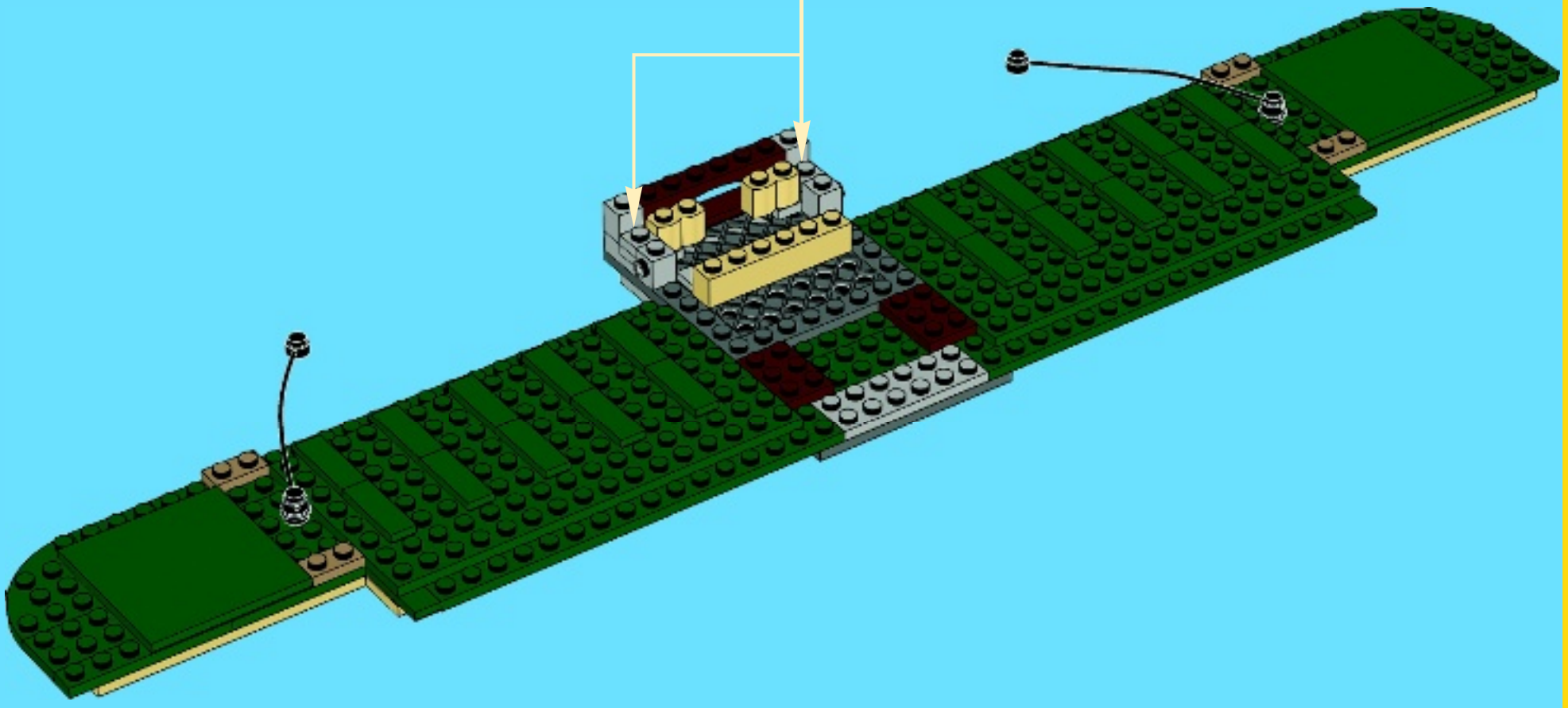
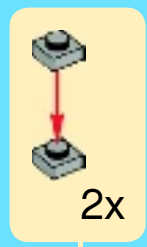

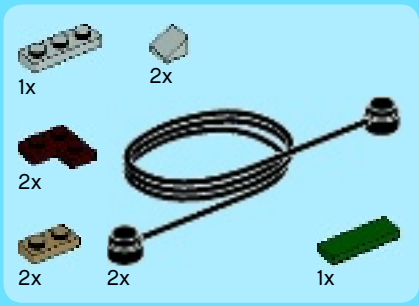

12

1



2

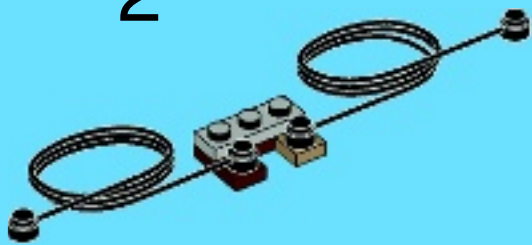

3

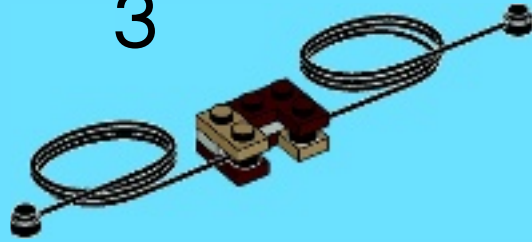

4

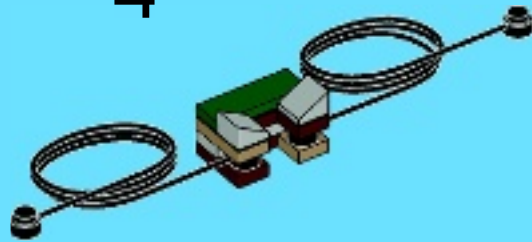

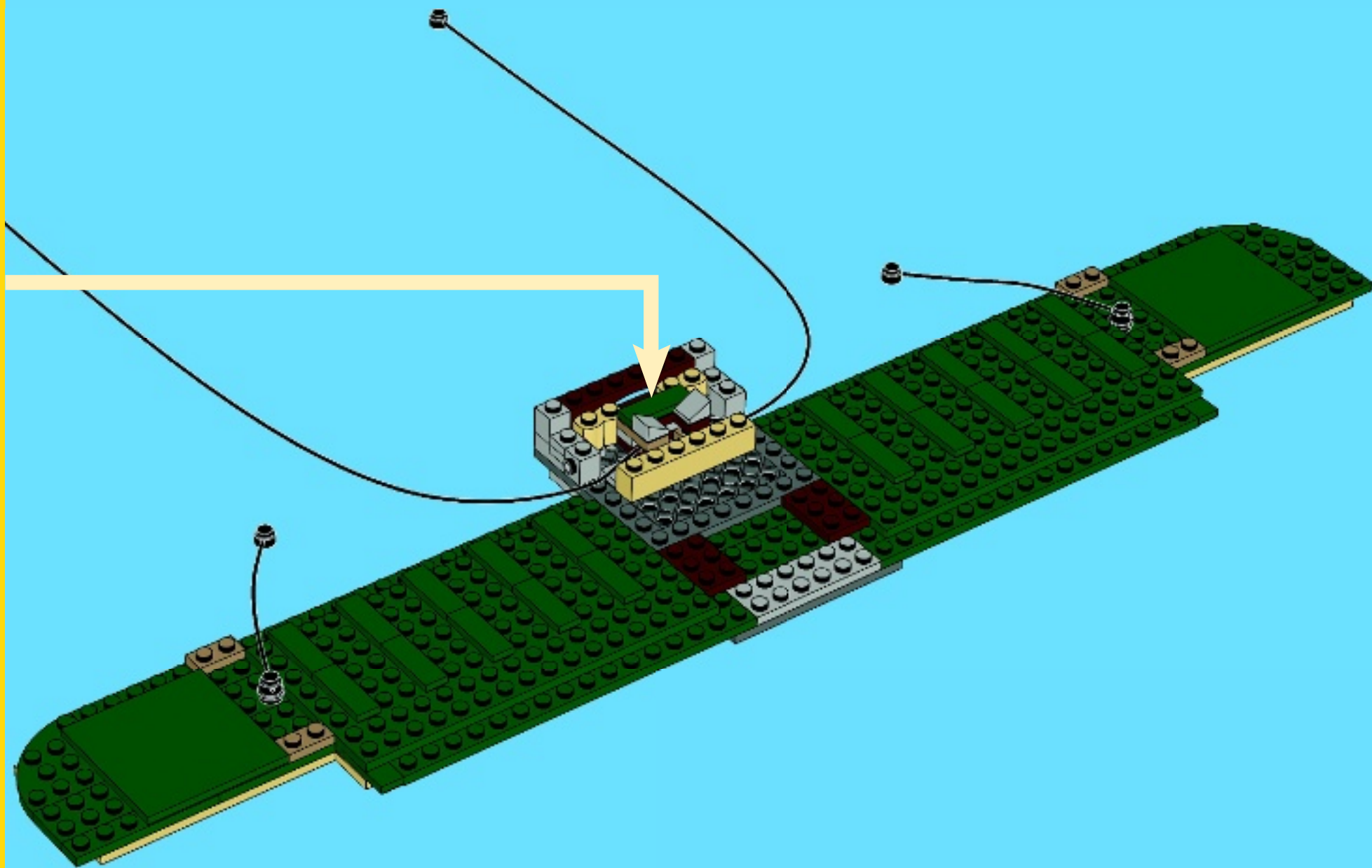



13

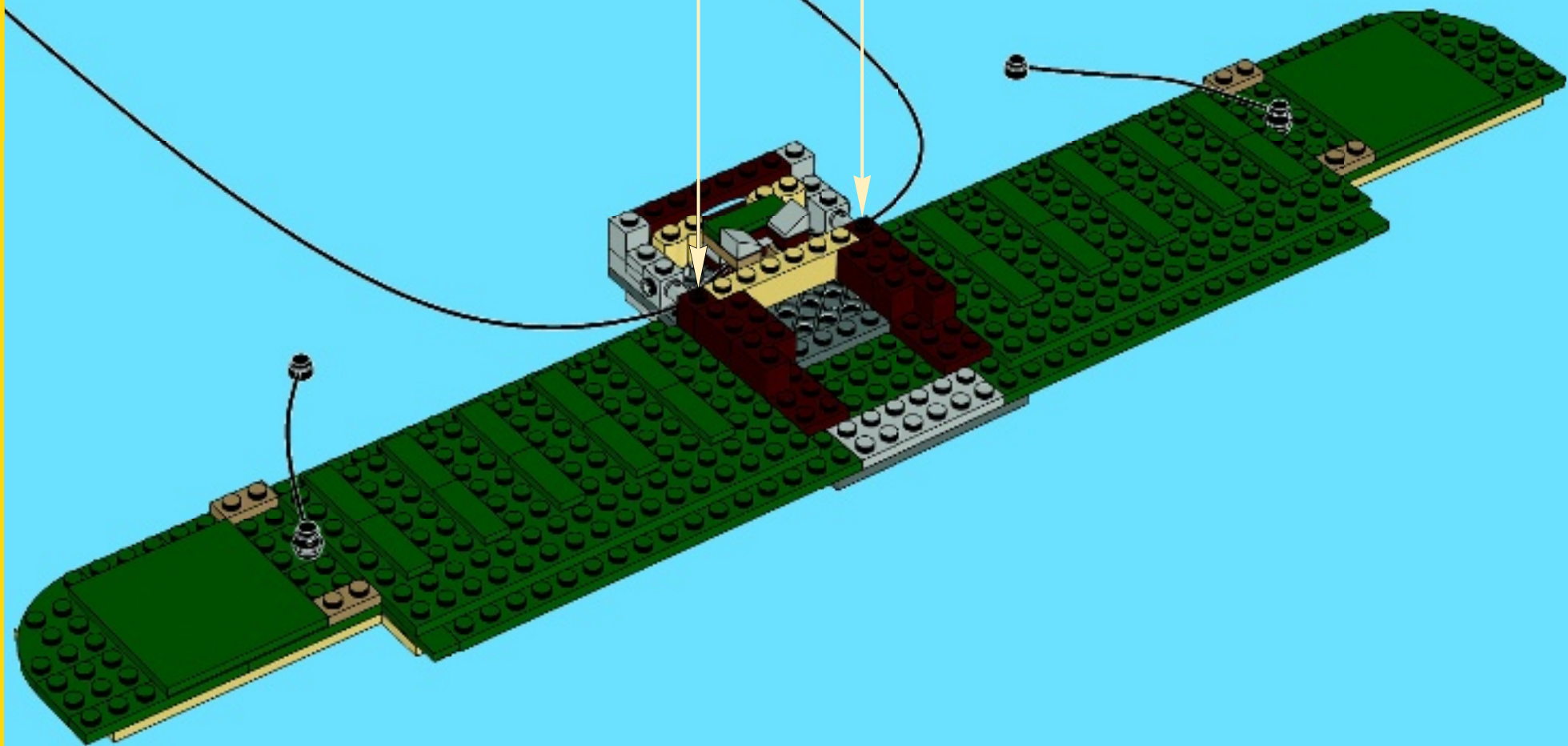
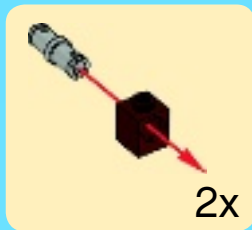

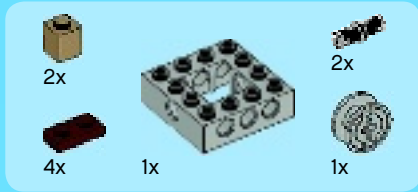

14

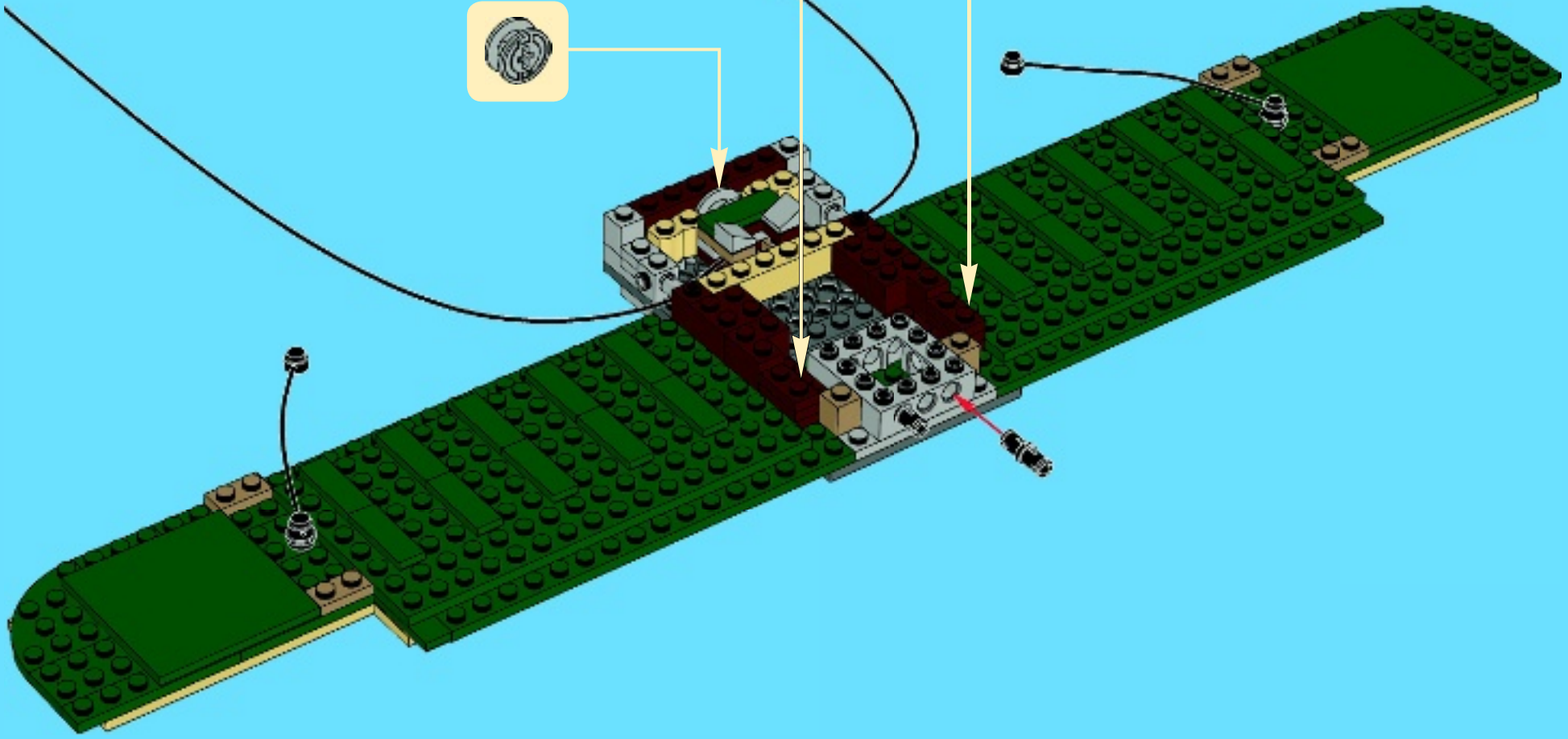
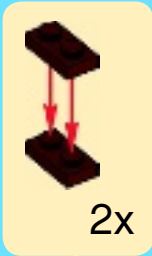

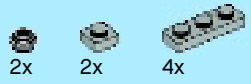

15

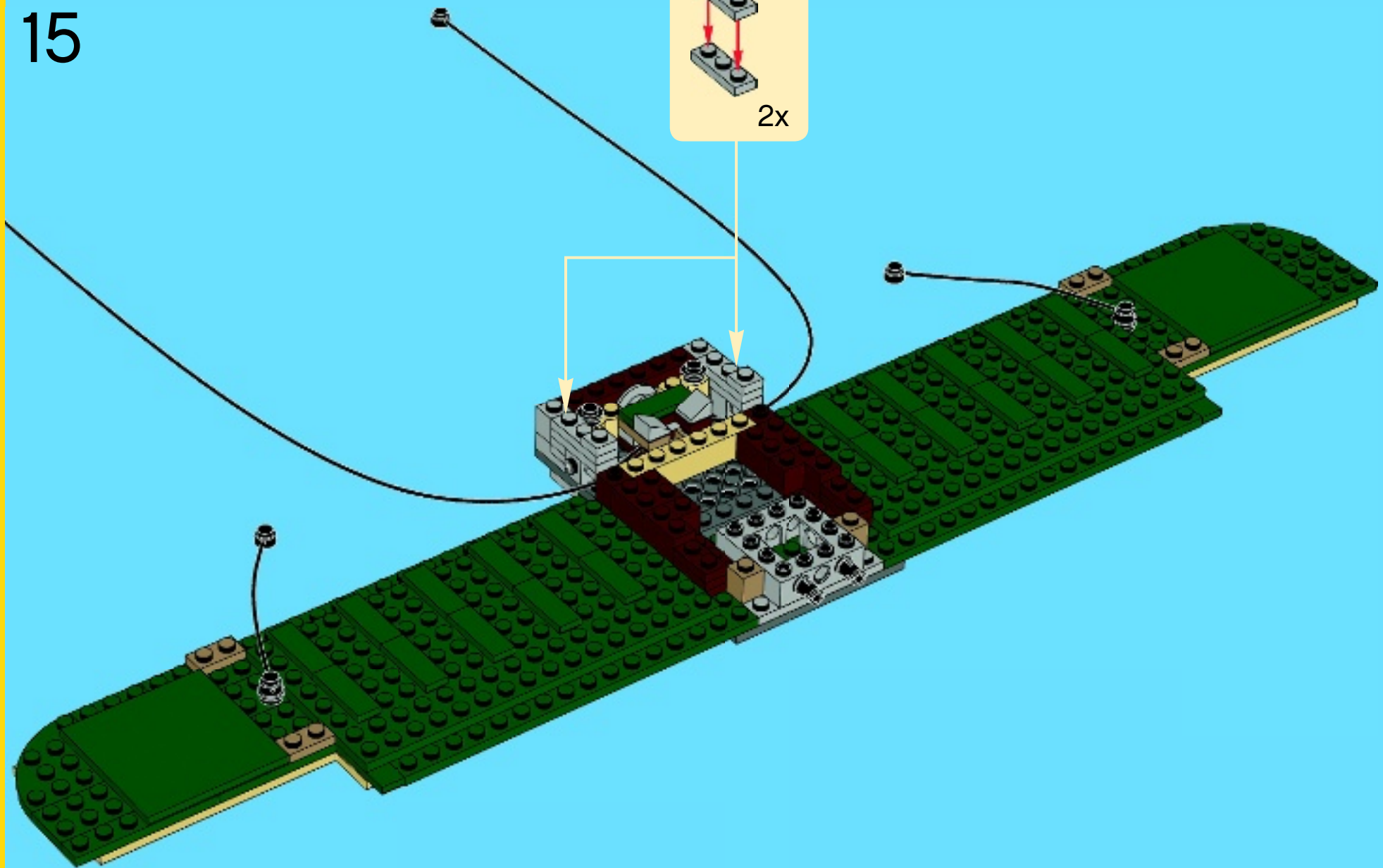
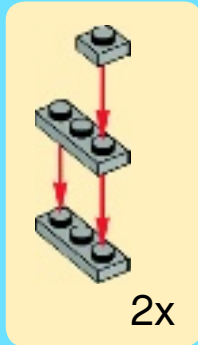

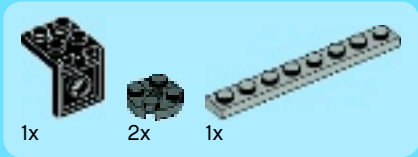

16

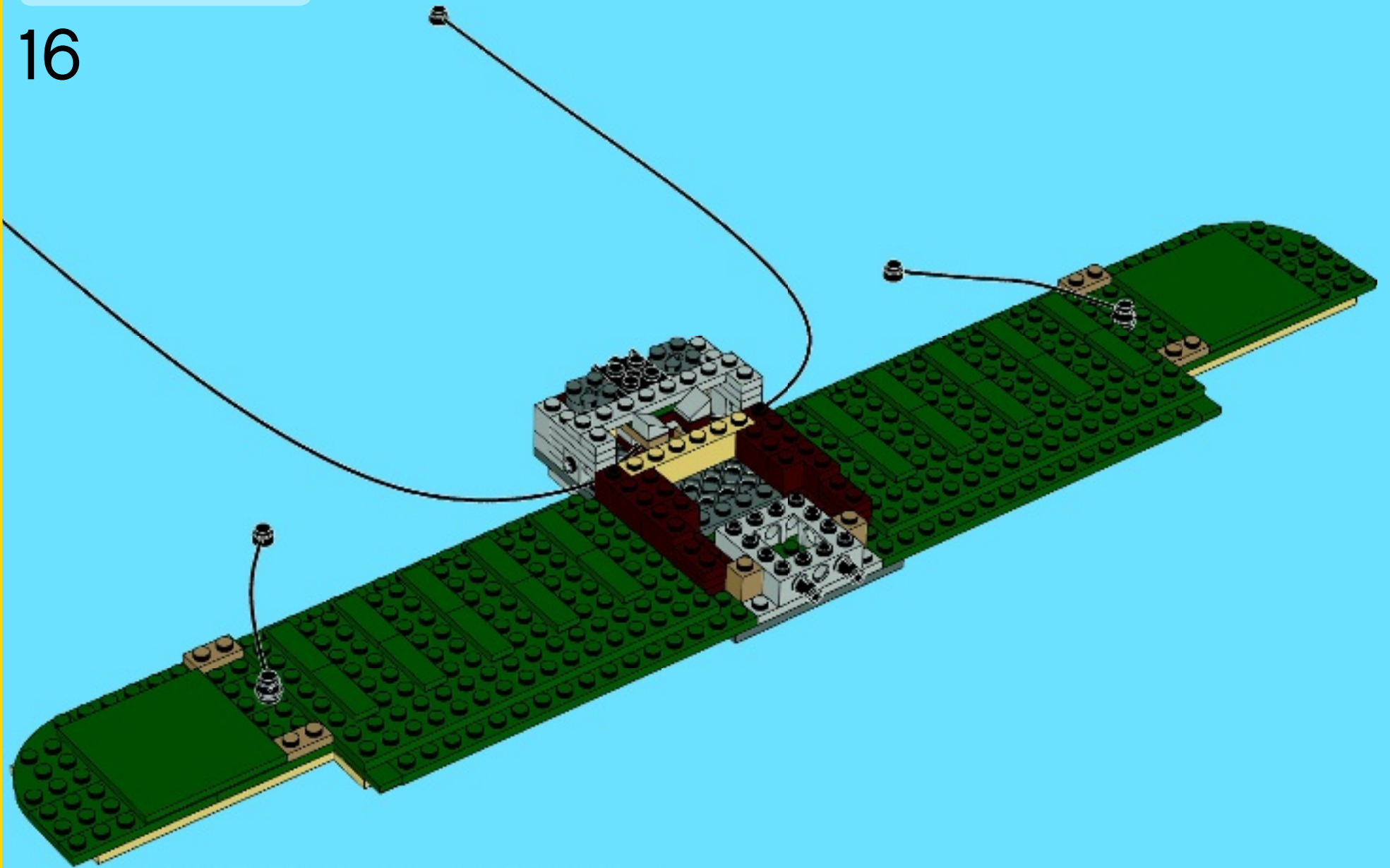

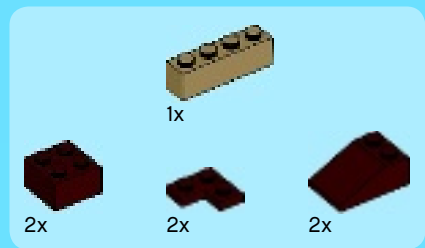

17

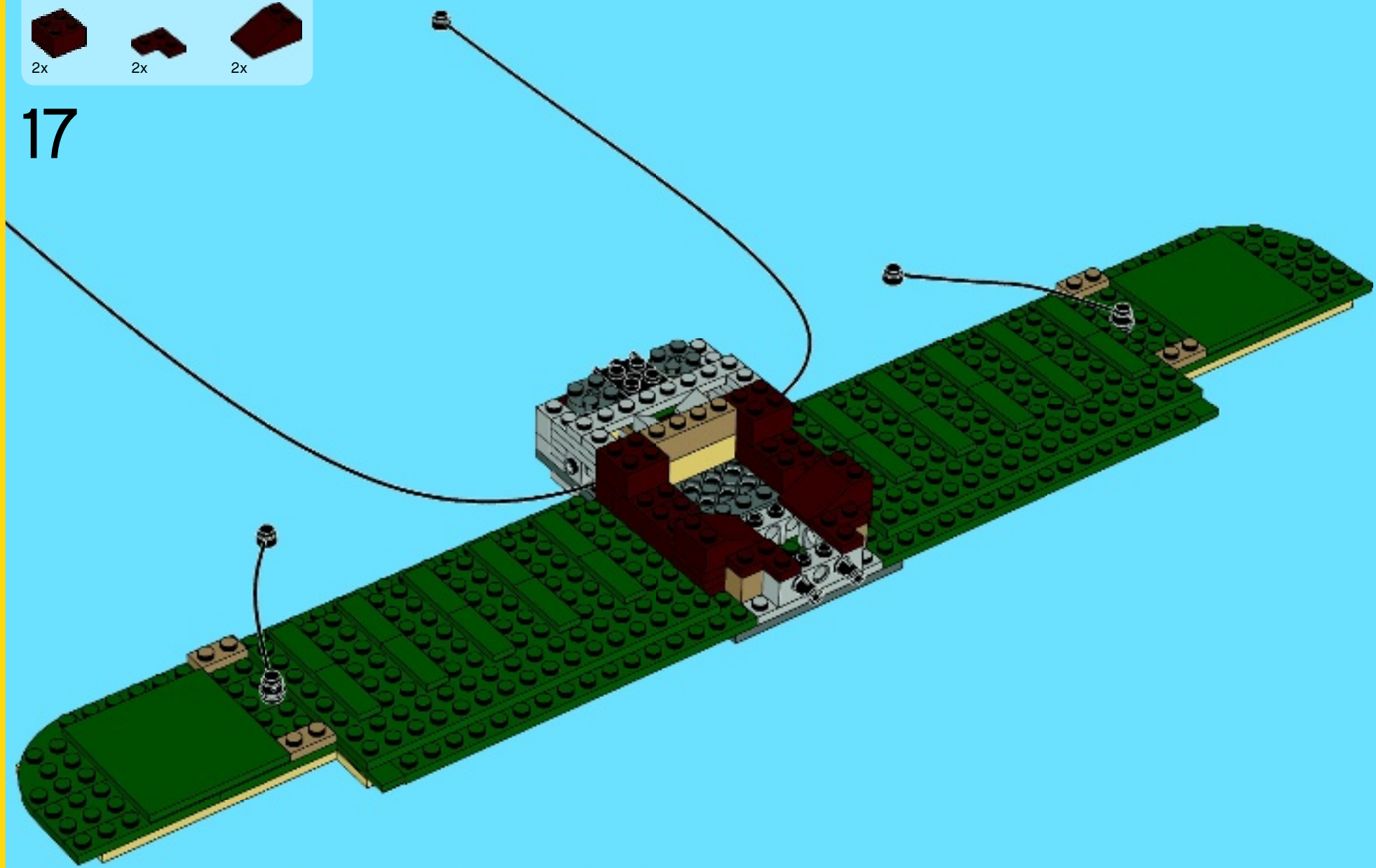

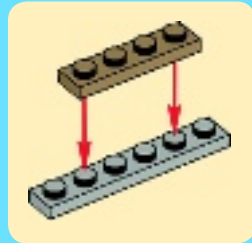
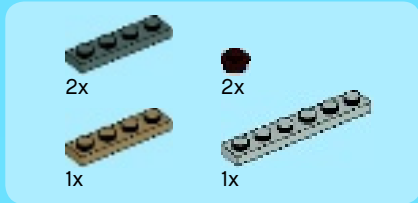

18

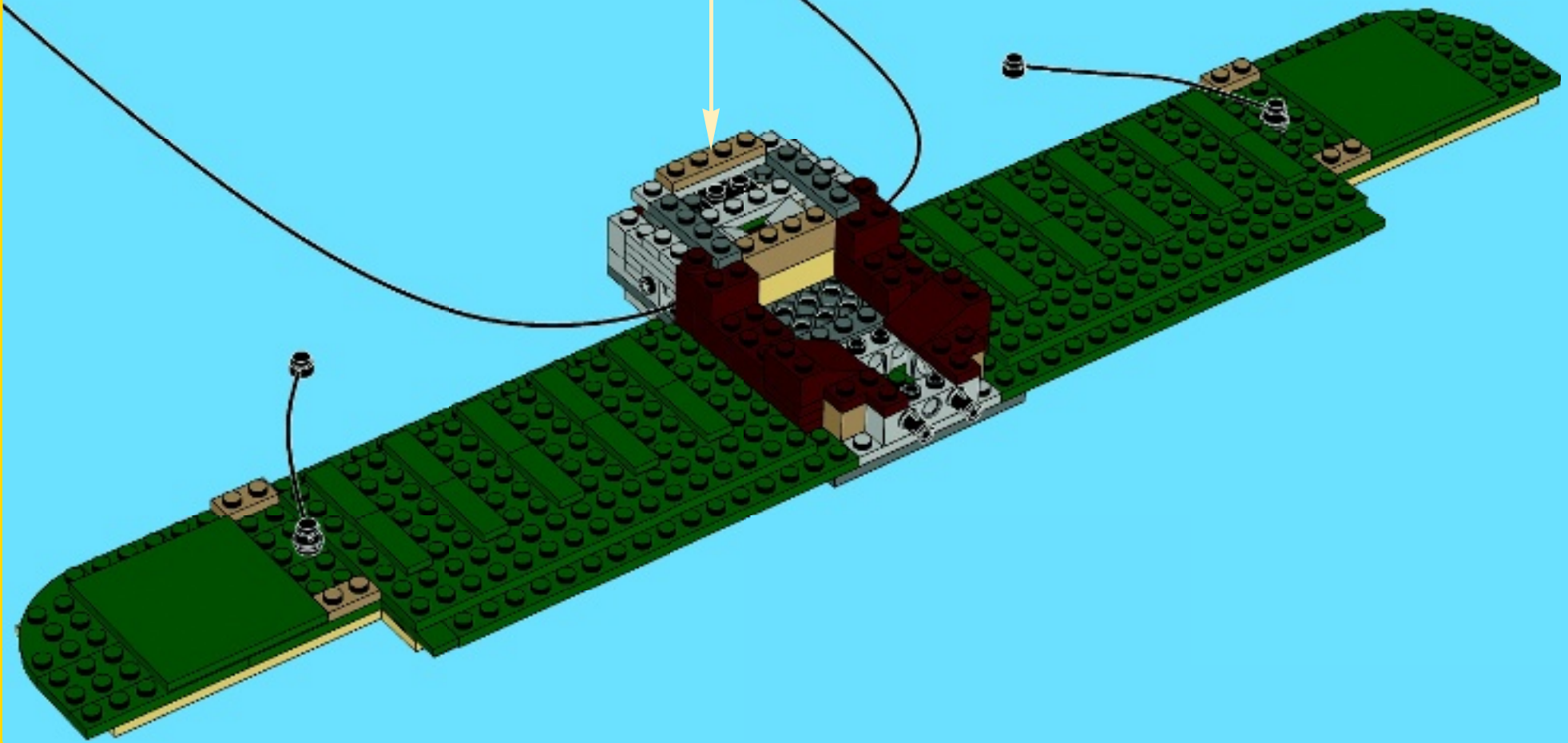

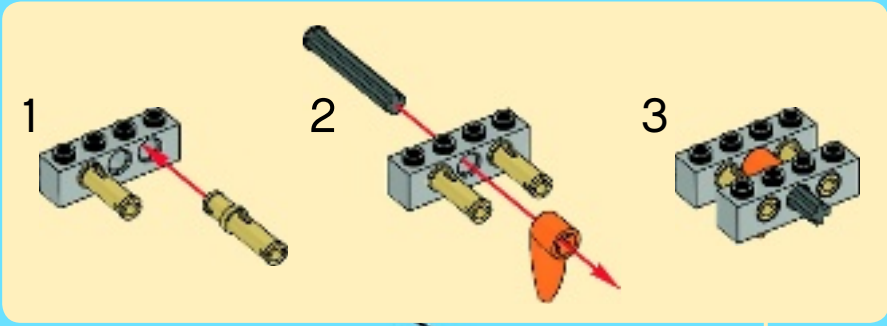
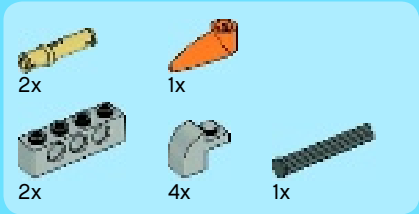

19

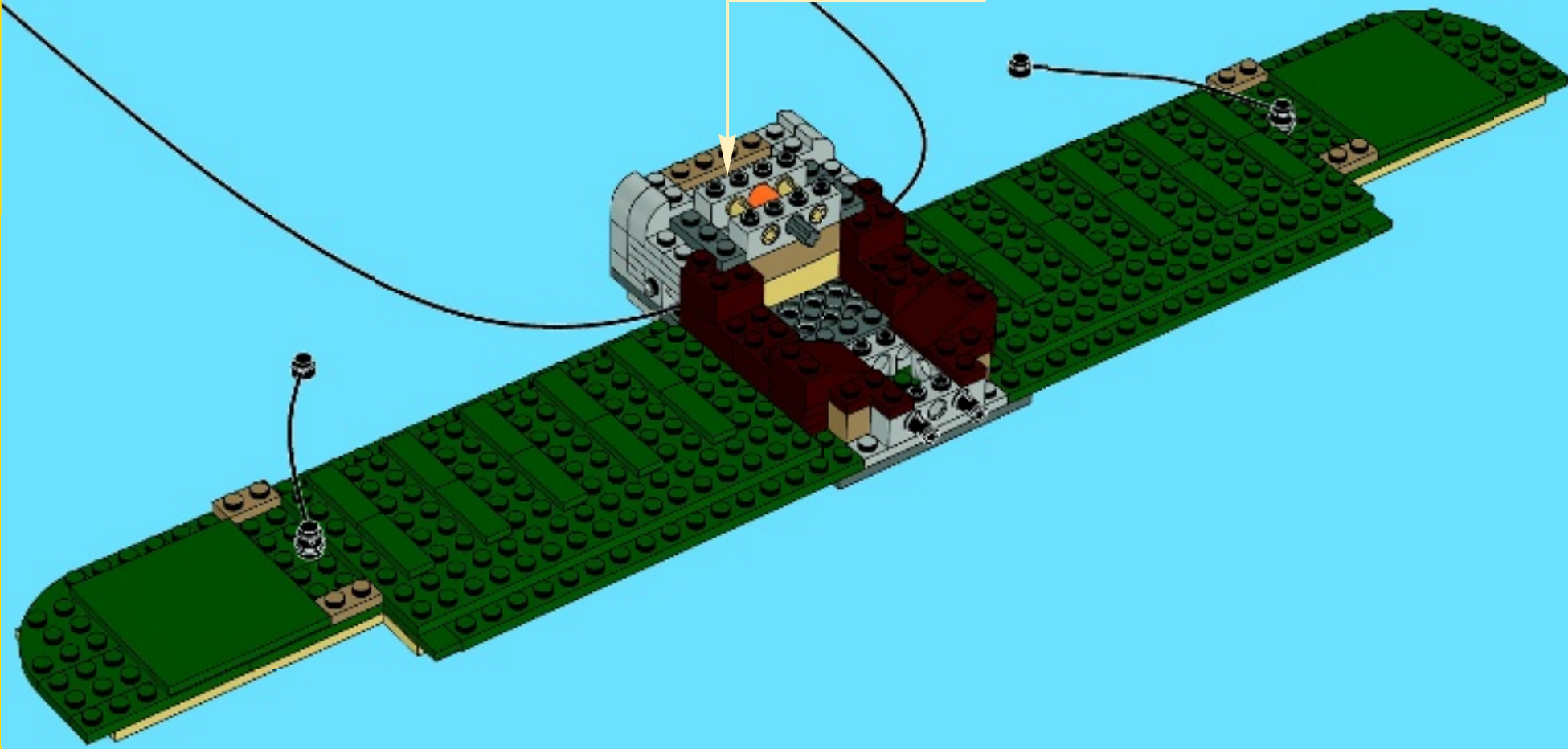



2x



2x



2x

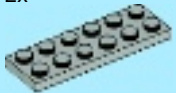

1x

20

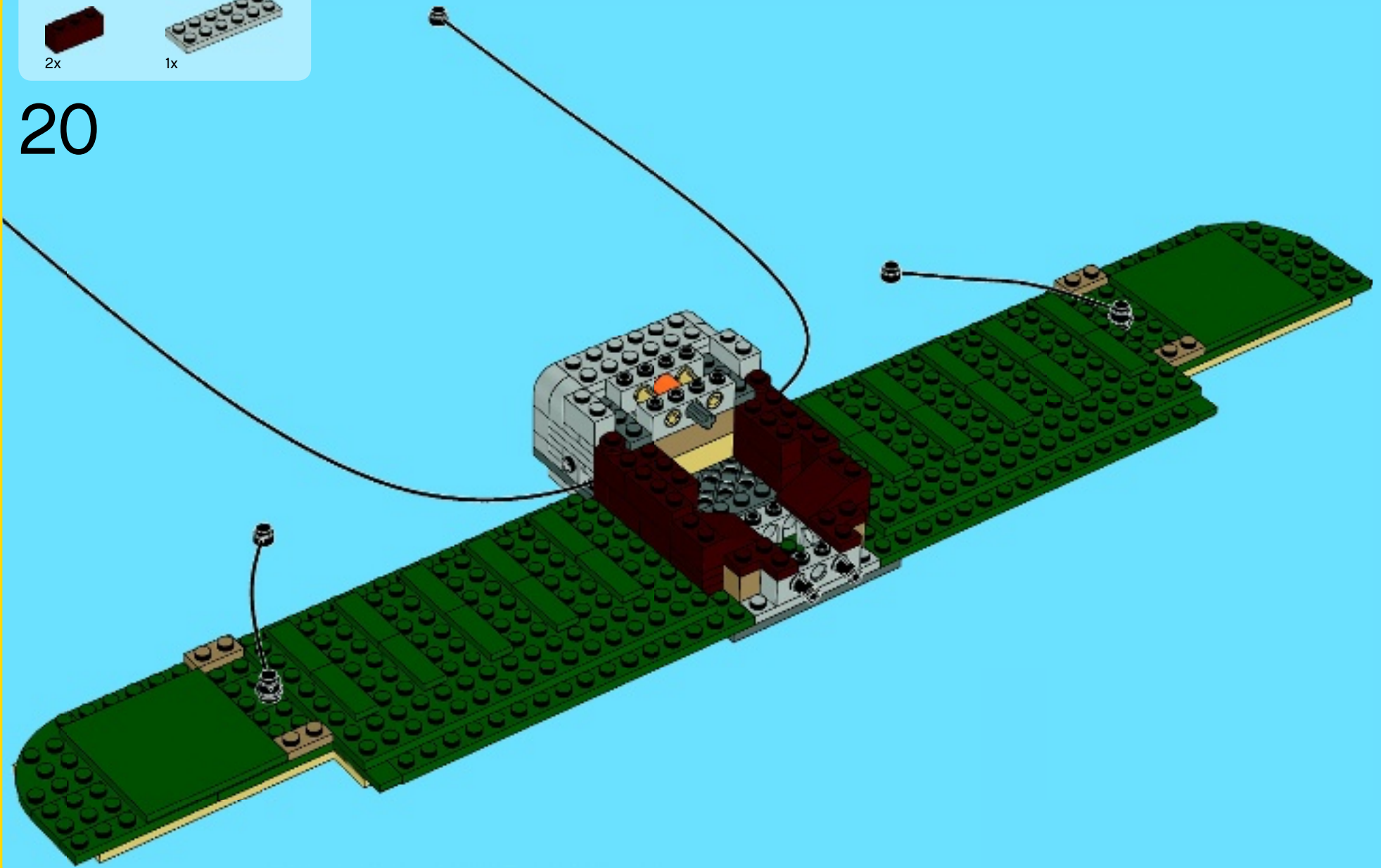

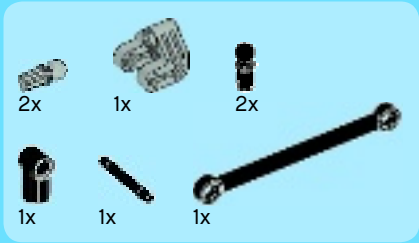

21

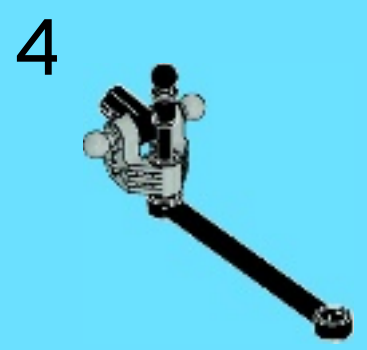
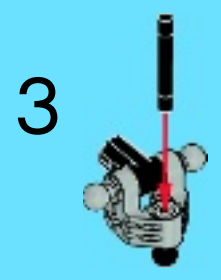
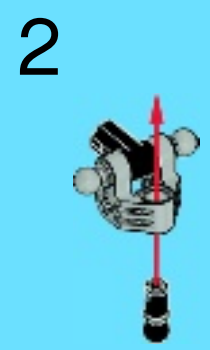
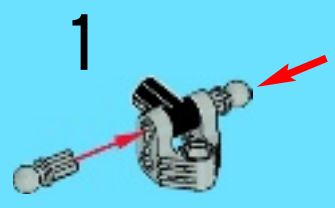

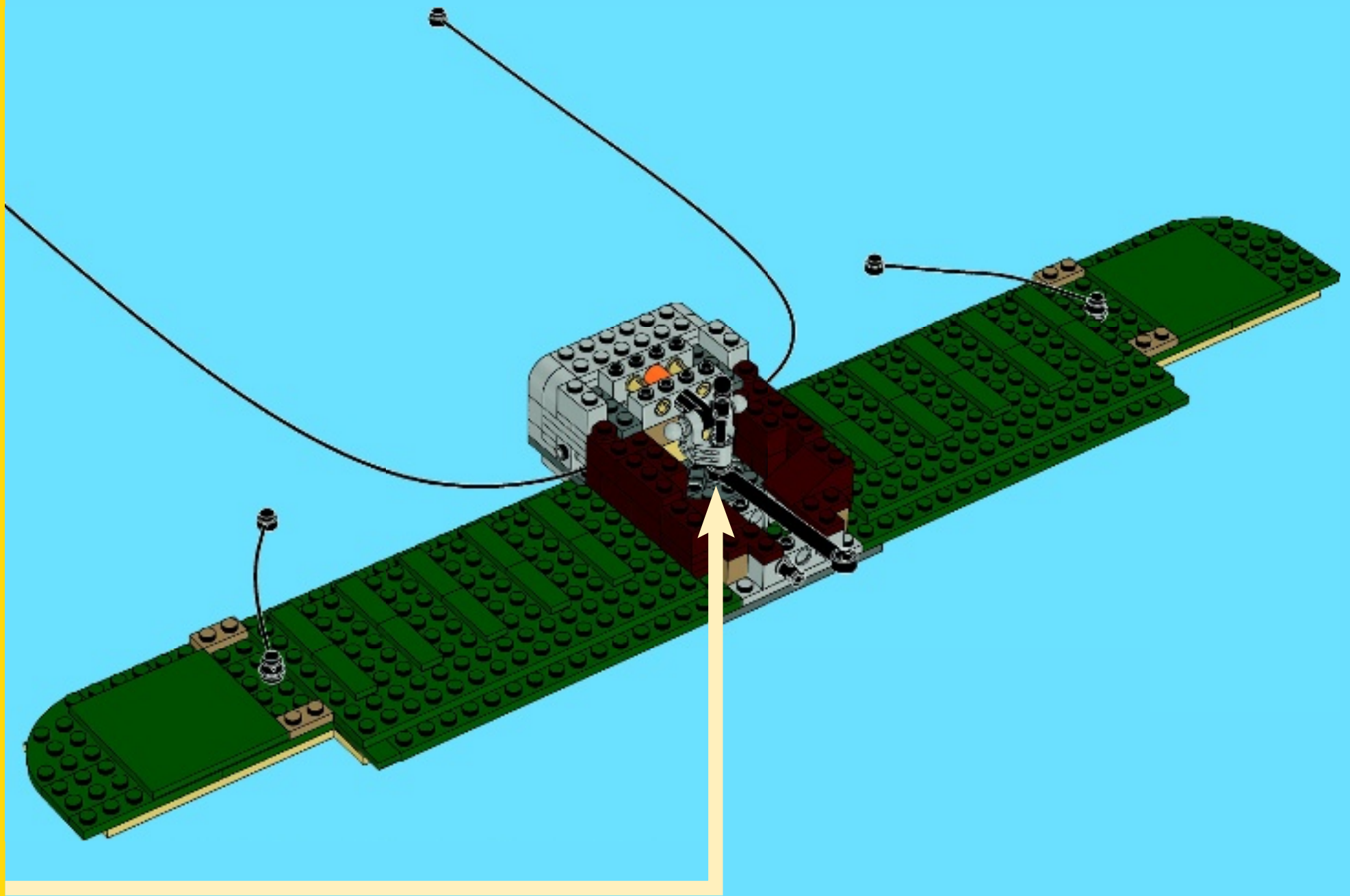

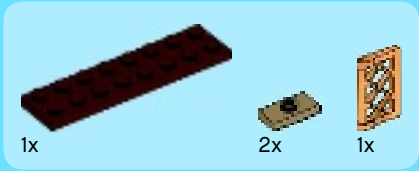

22

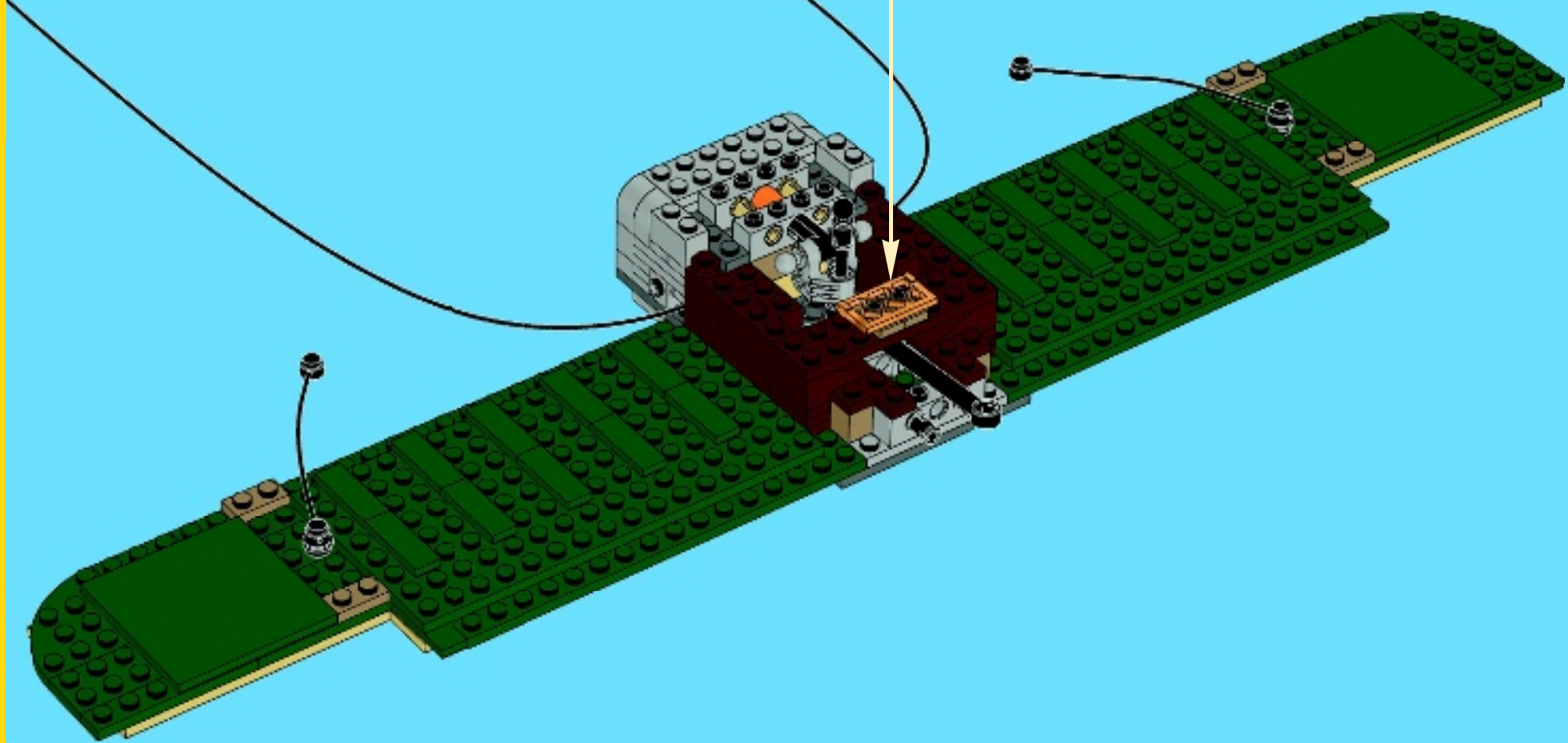
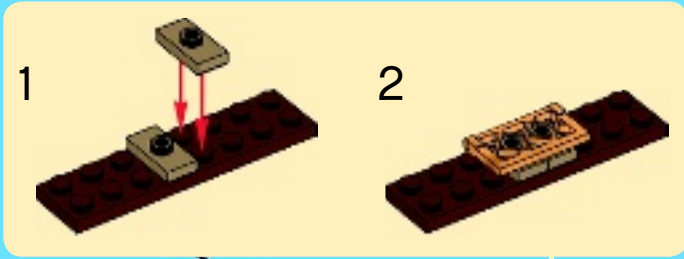

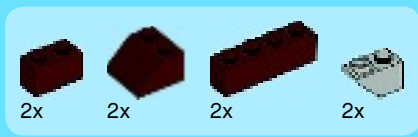

23

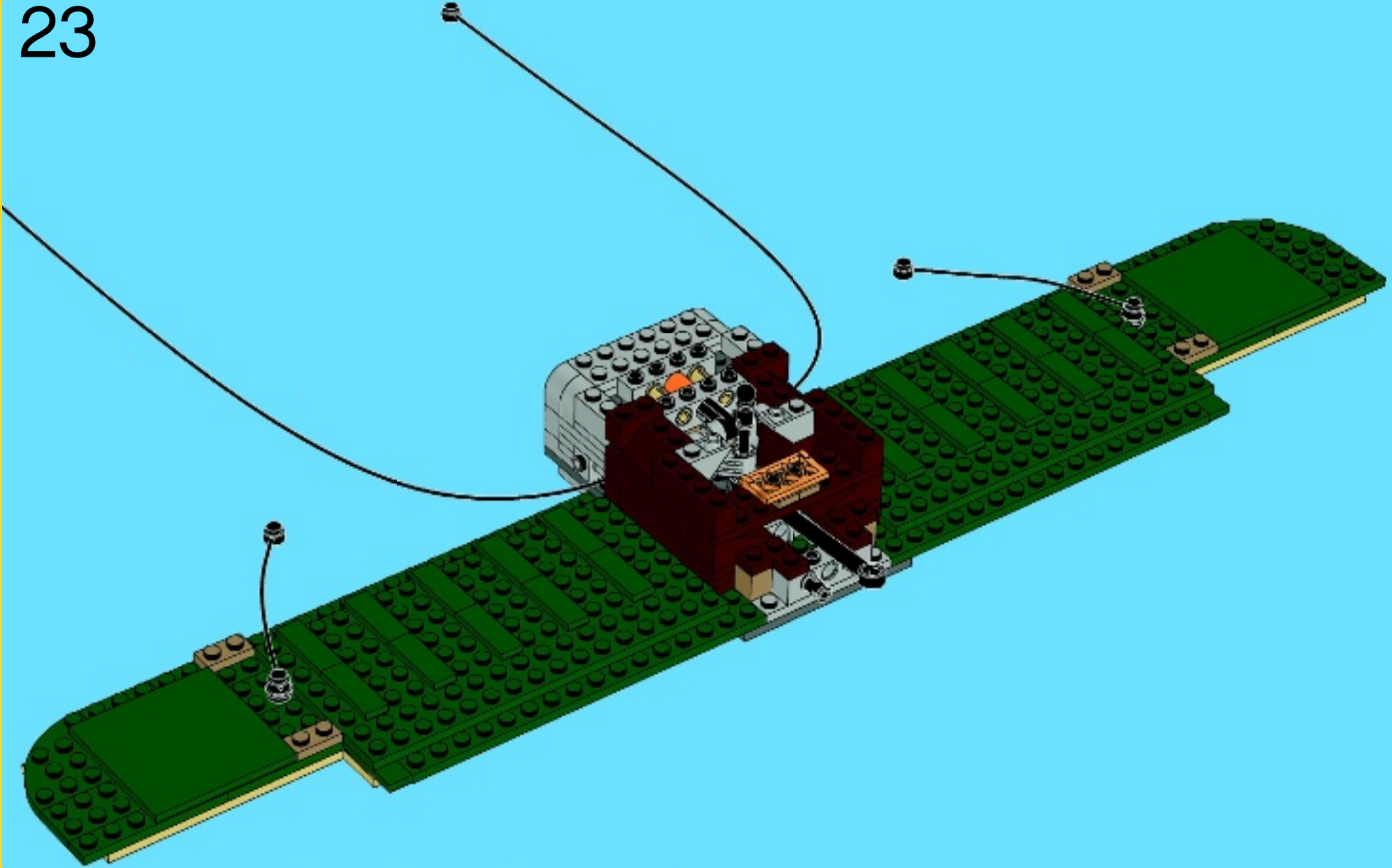



2x



2x



4x



2x

24

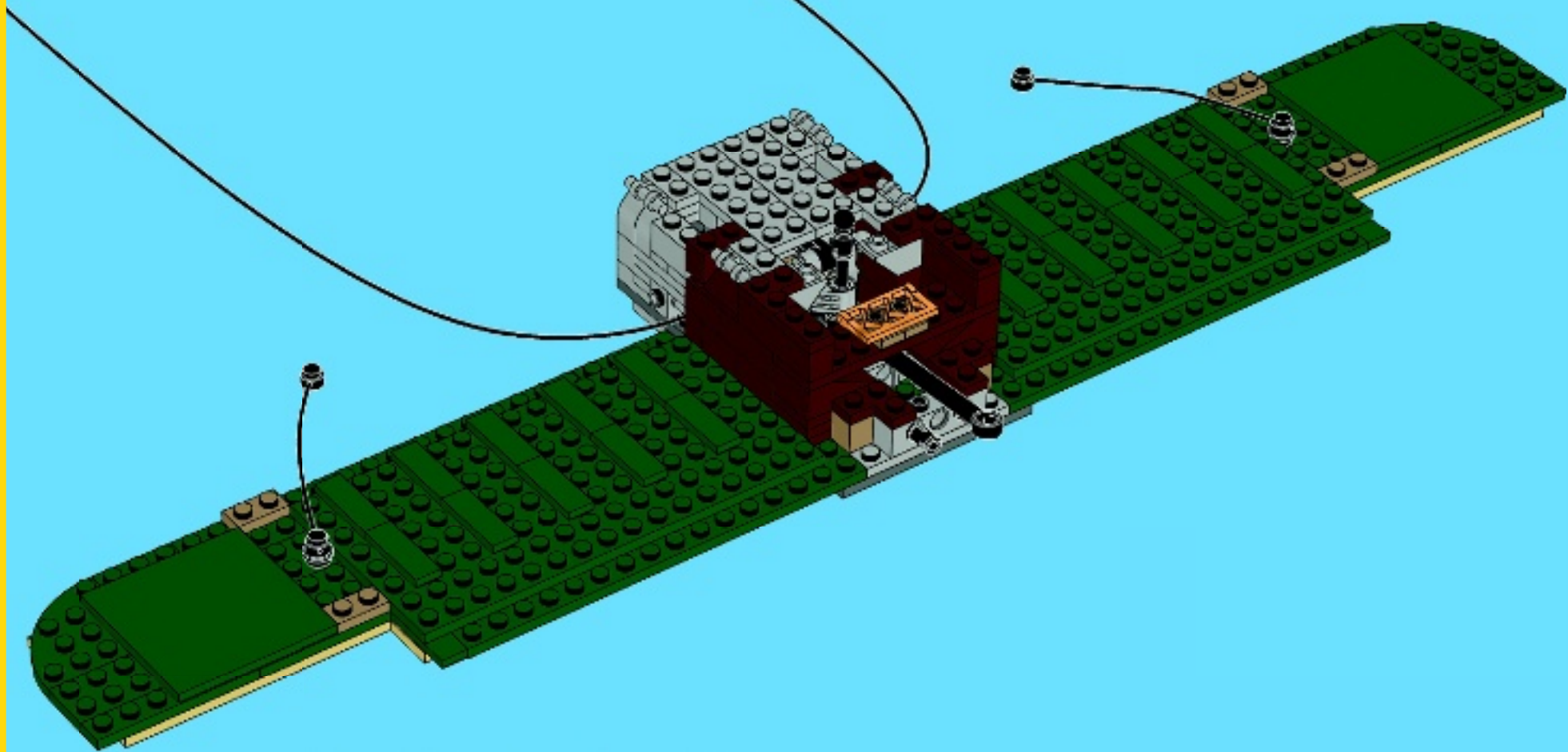

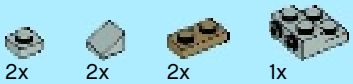

25

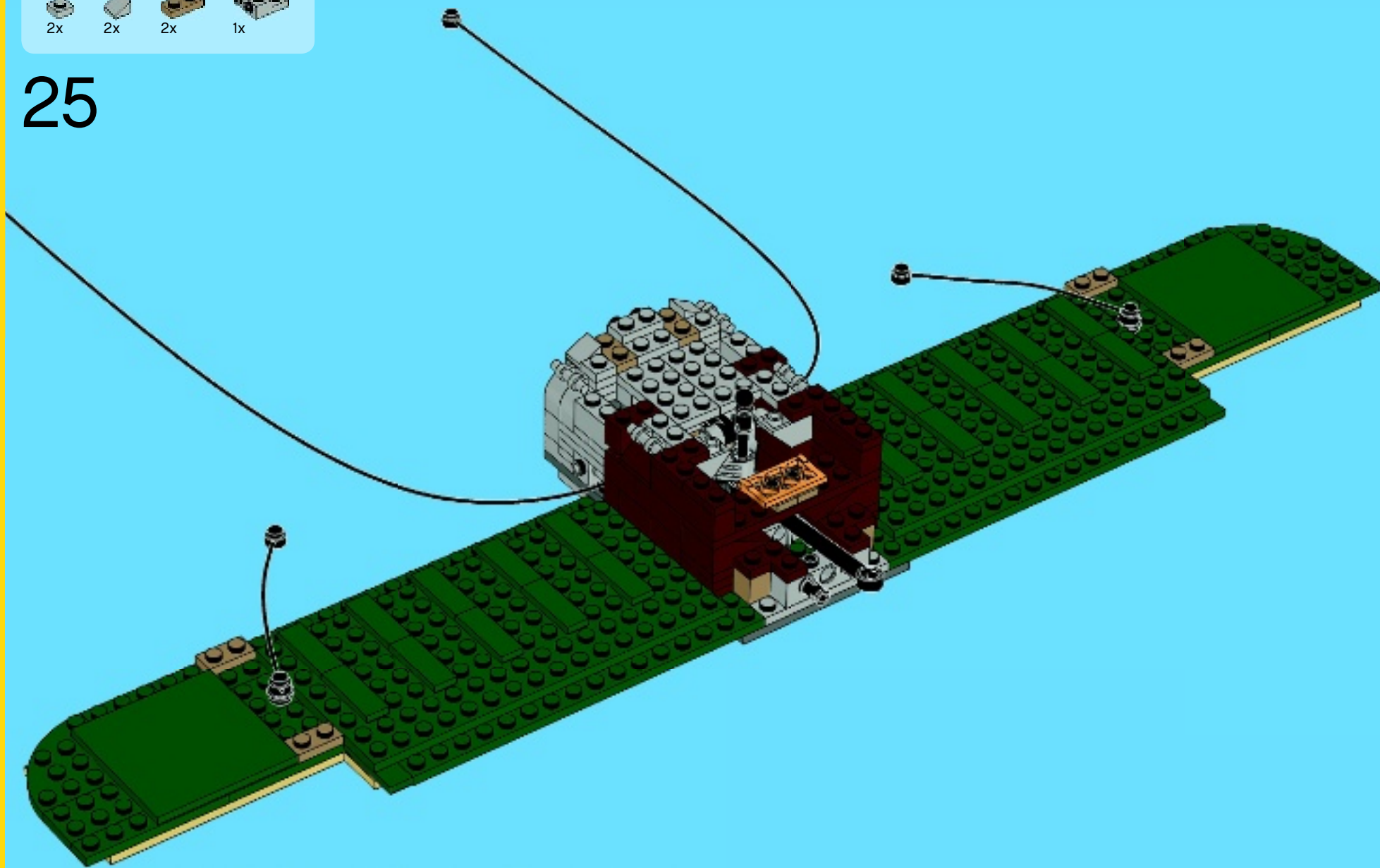



2x



1x

26

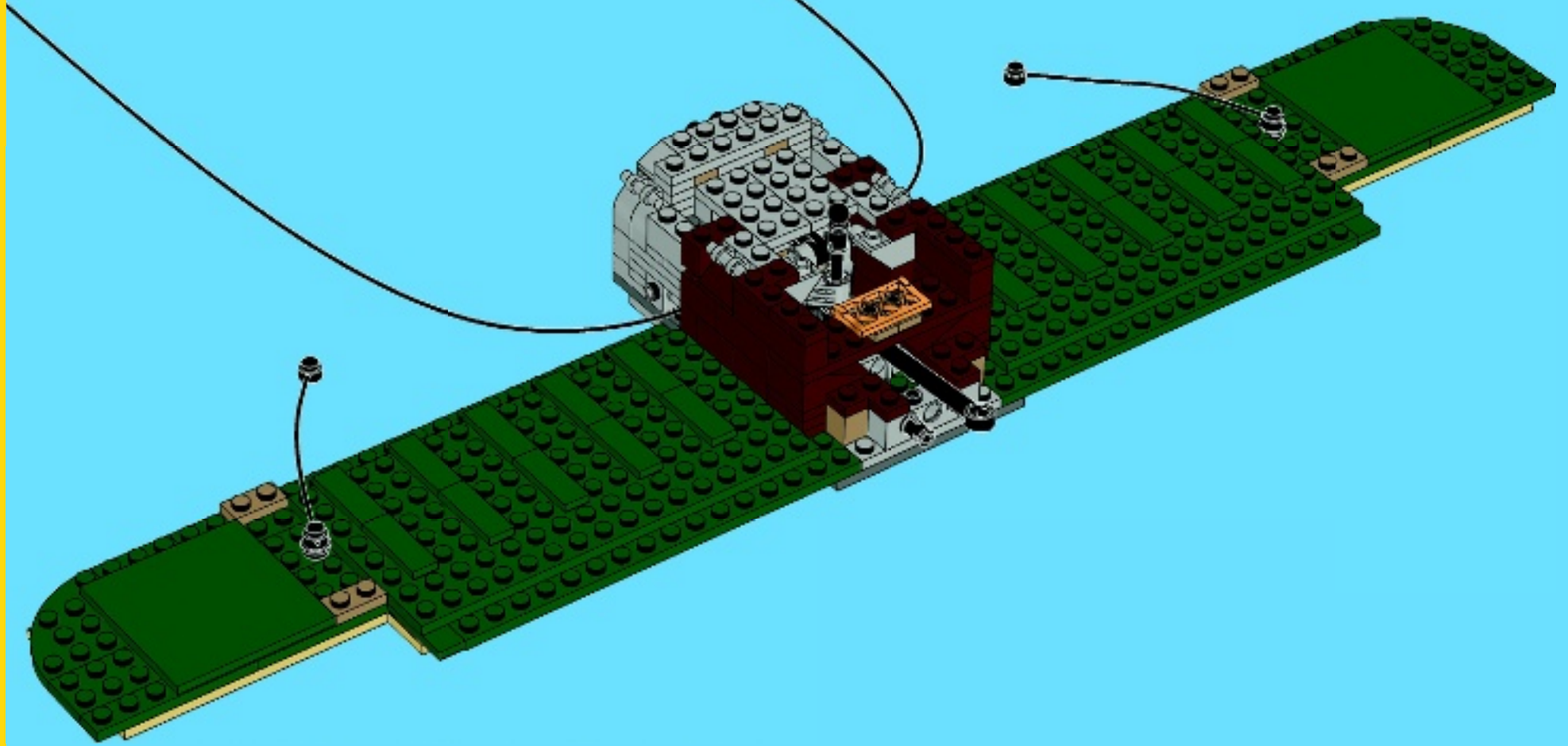



27

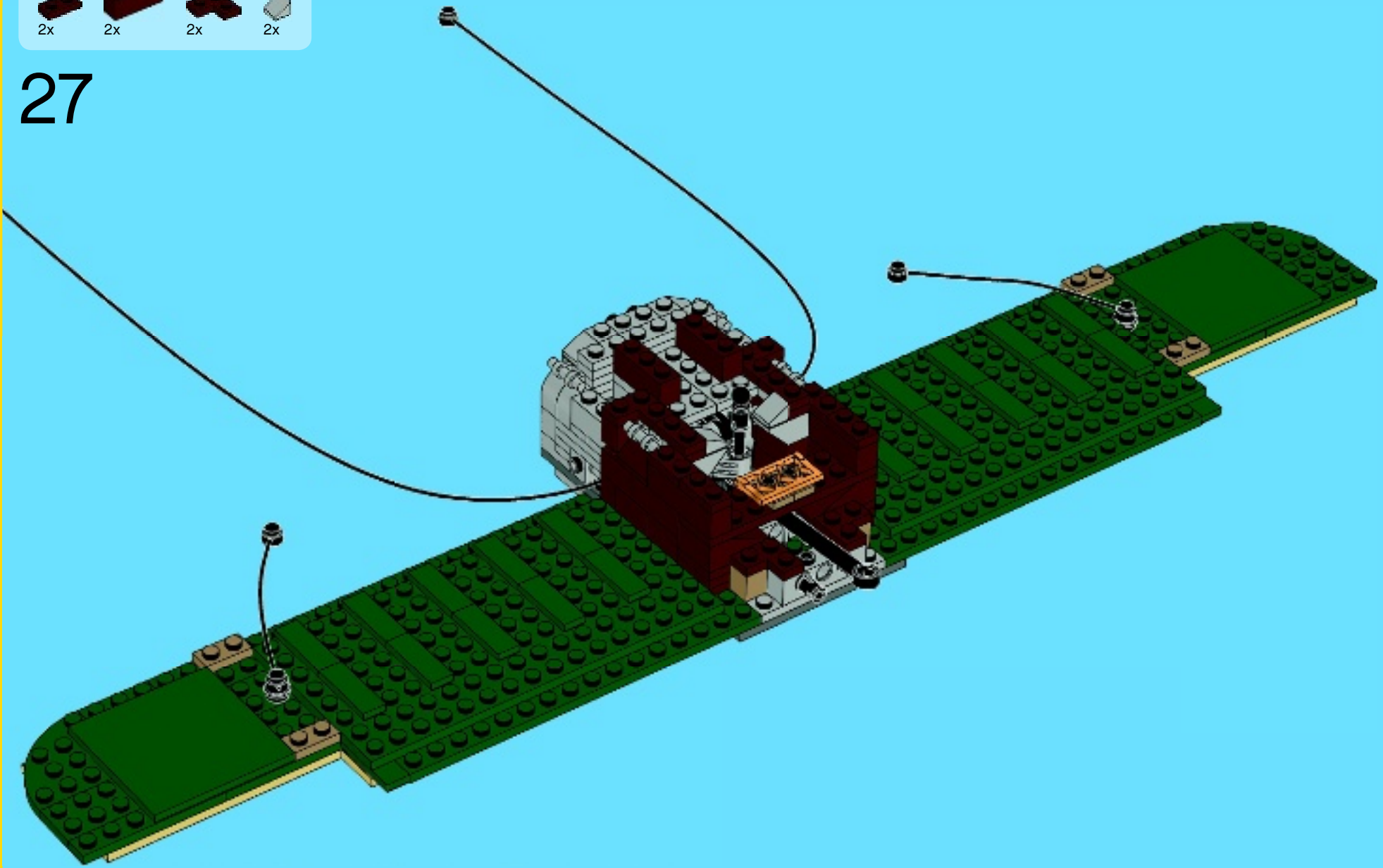

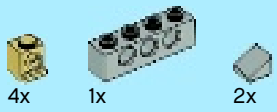

28

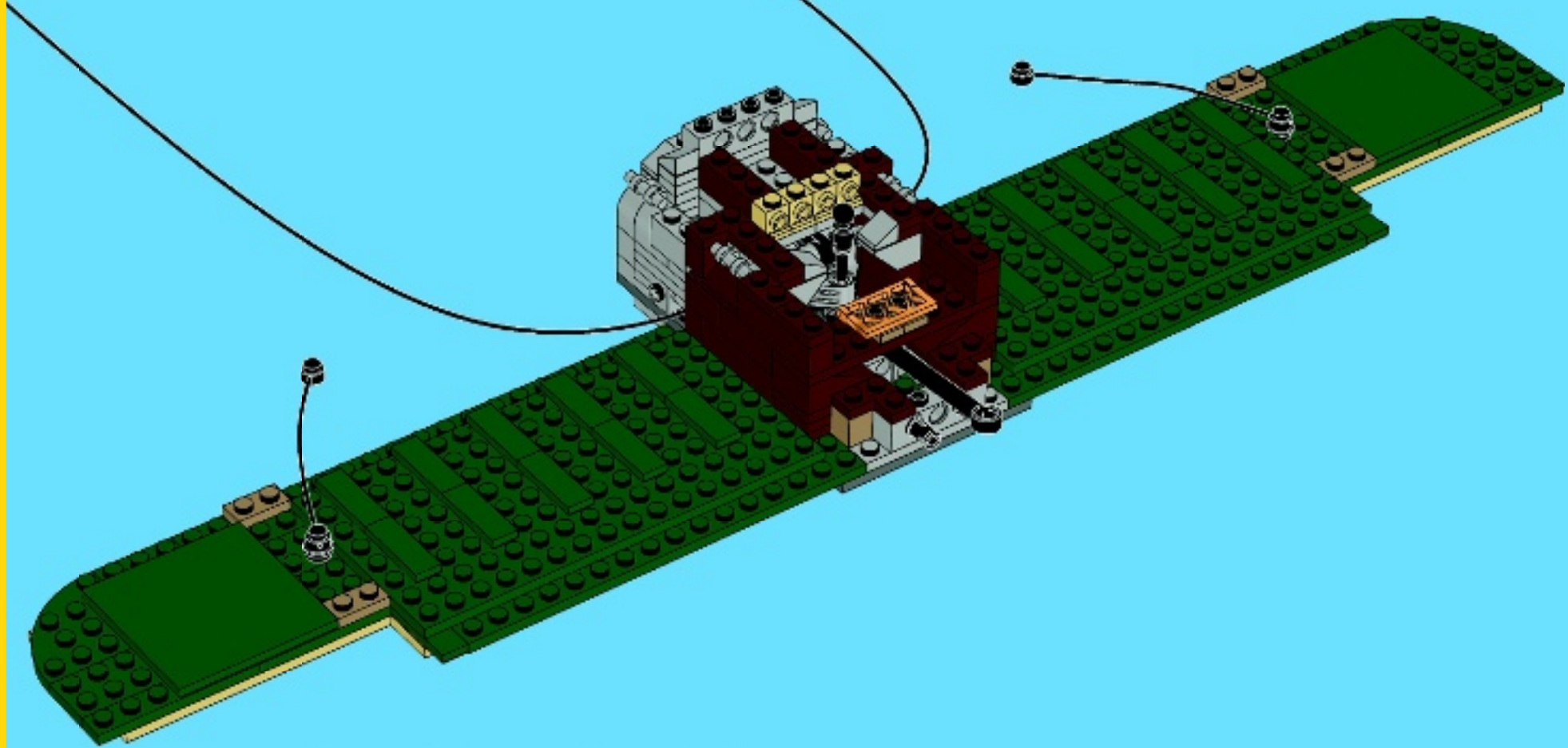



1x



4x

29

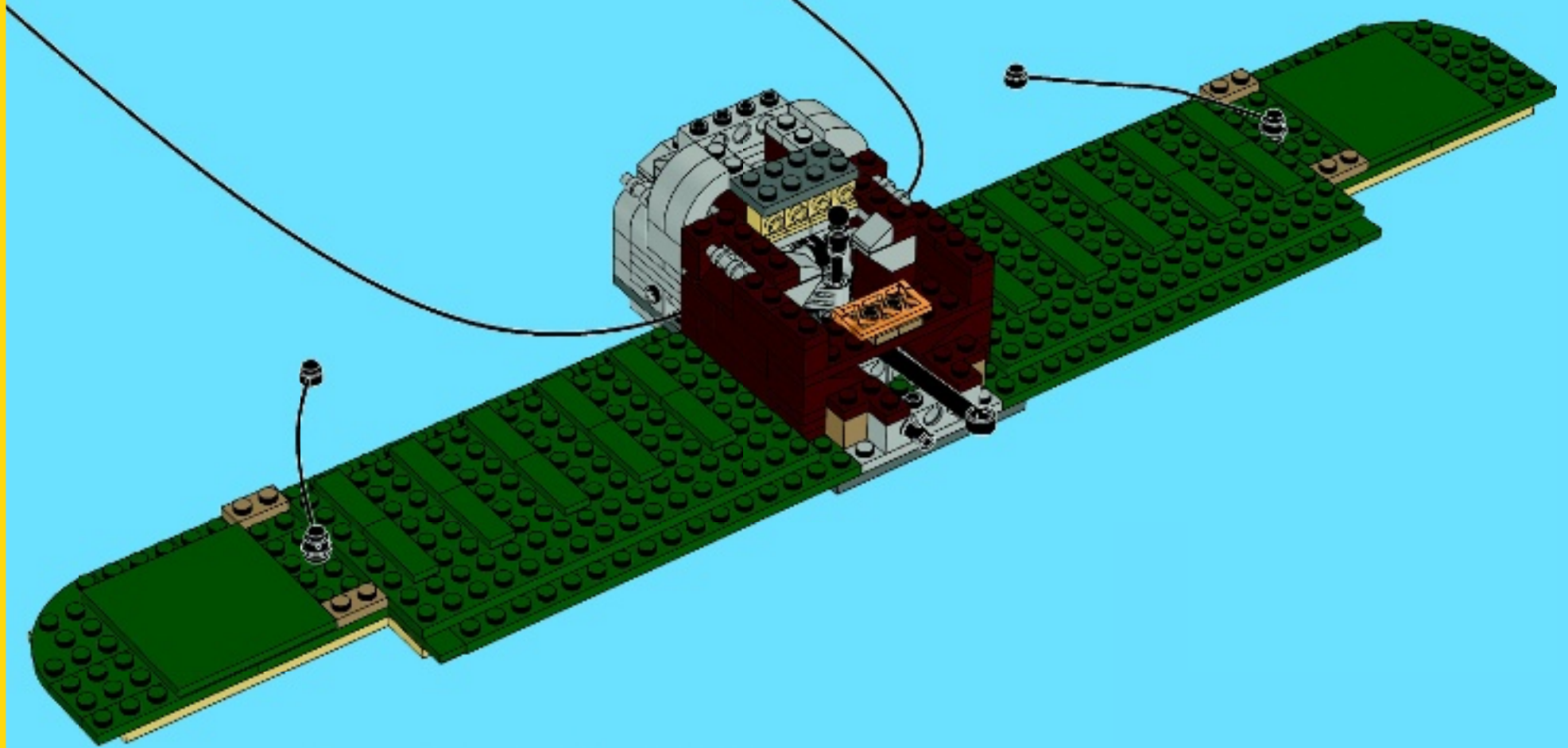



1x



1x



4x



2x

30

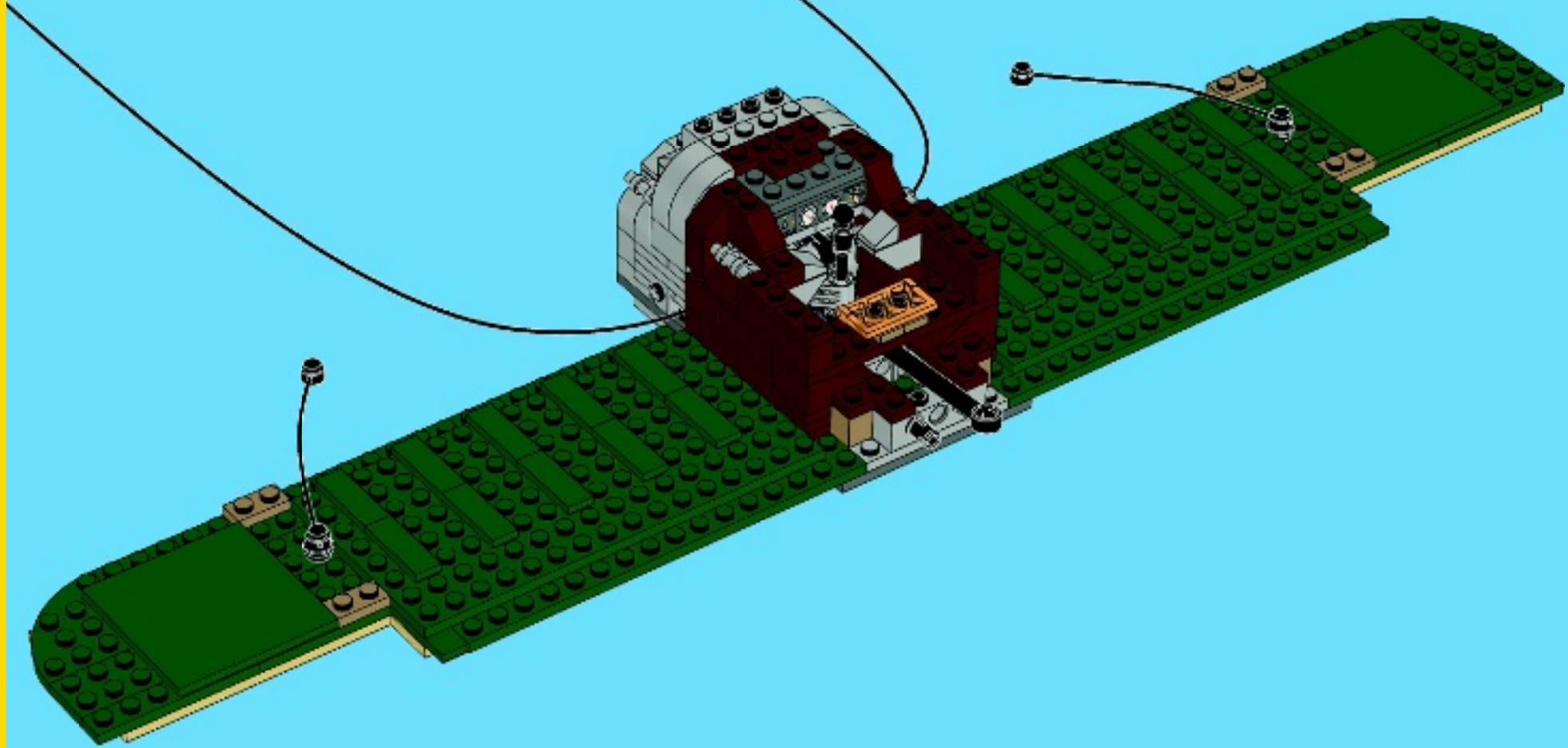

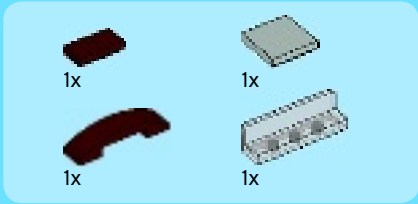

31

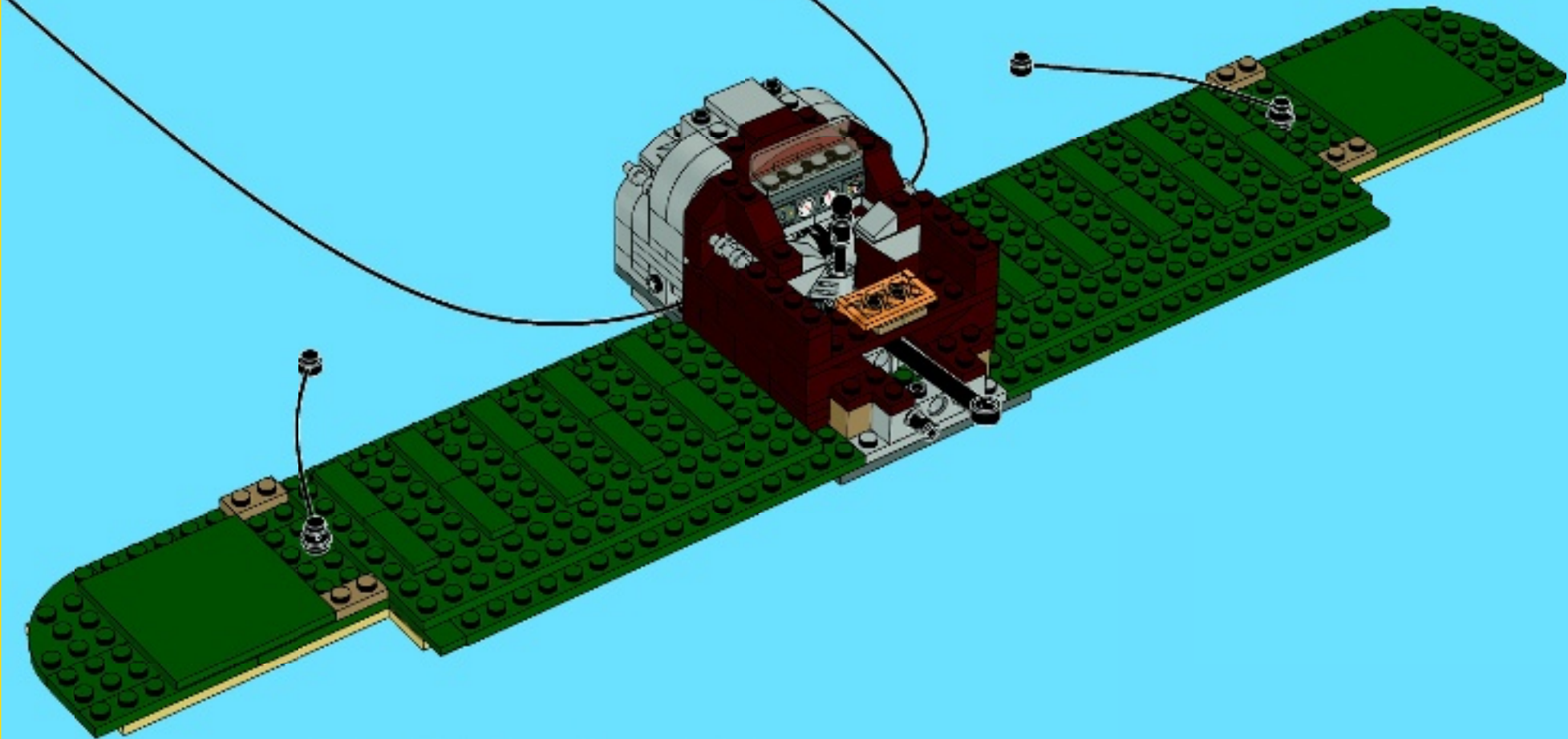

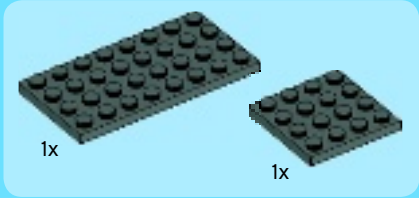
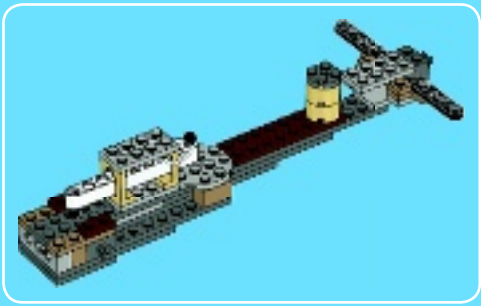

1

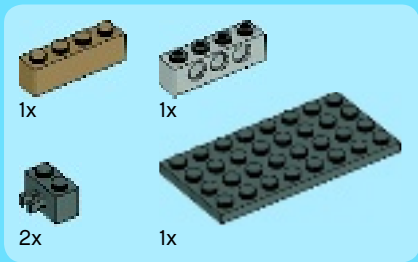
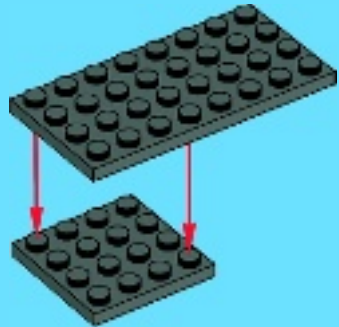

2

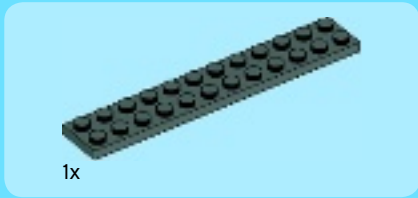
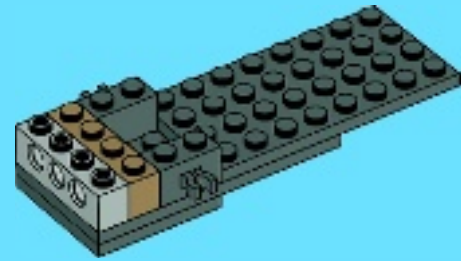

3

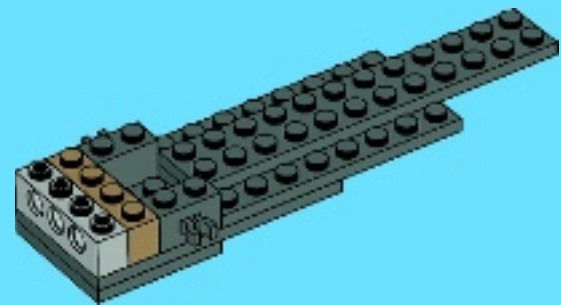

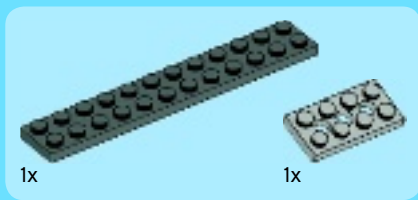

4

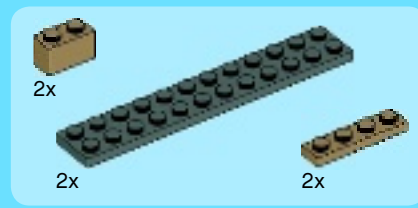
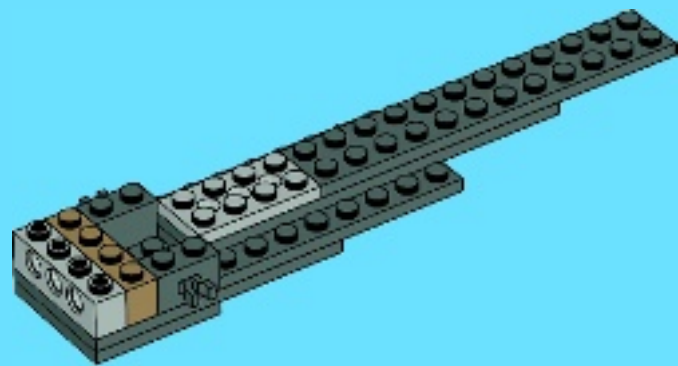

5

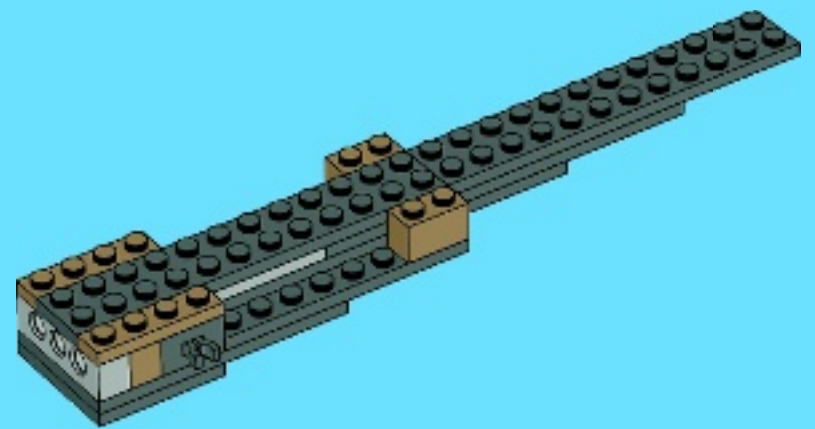

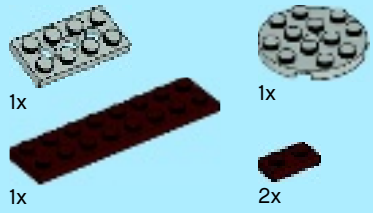

6

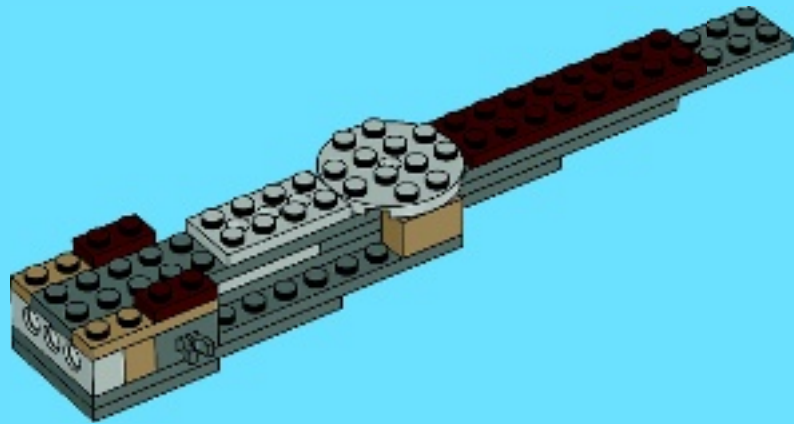

2x

7

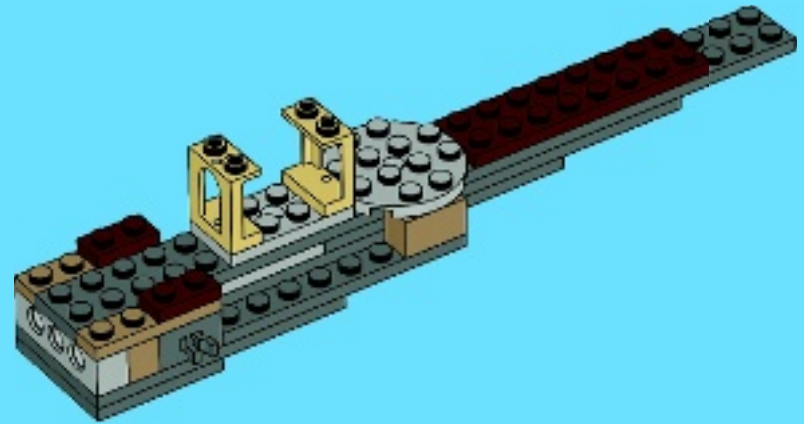



8

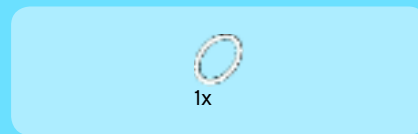
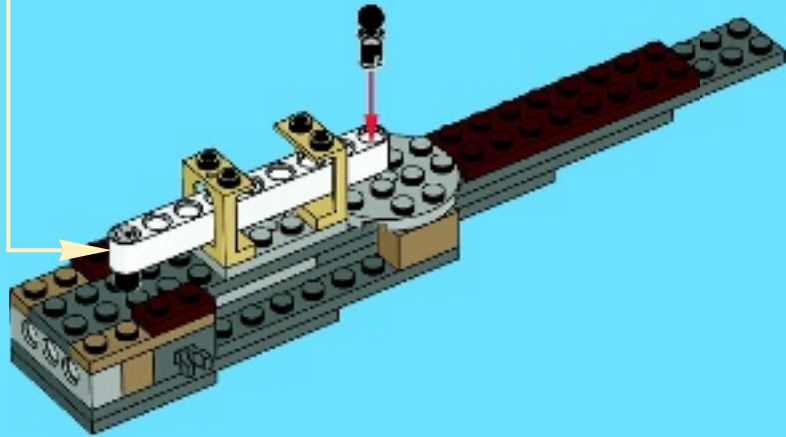
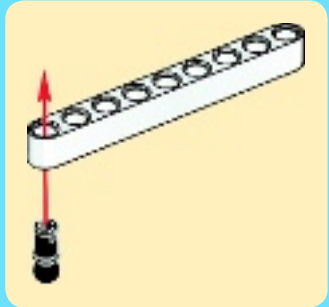

9

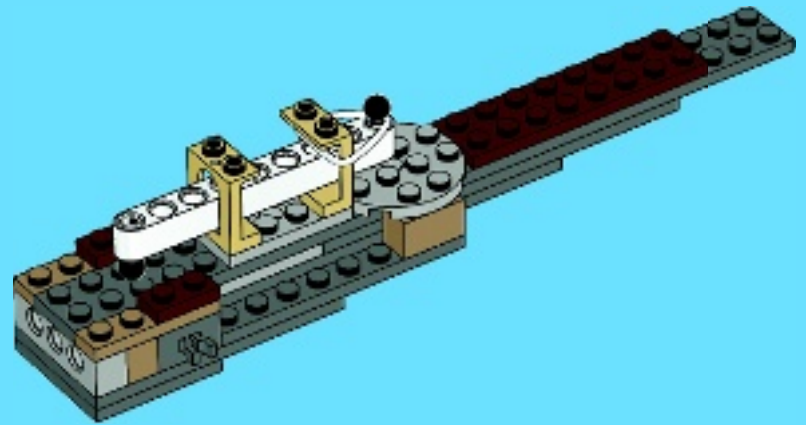



2x



1x



1x

10

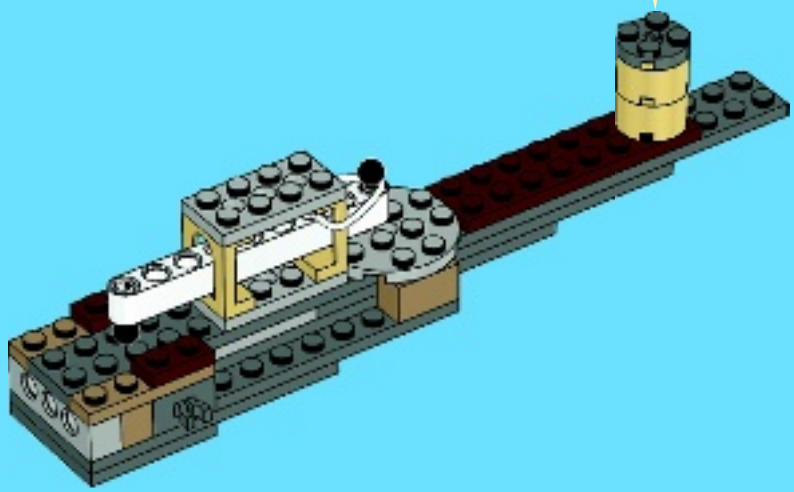

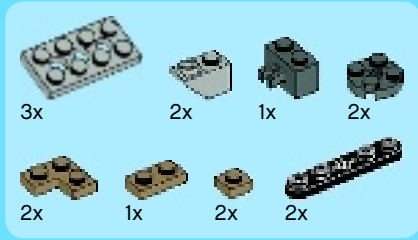

11

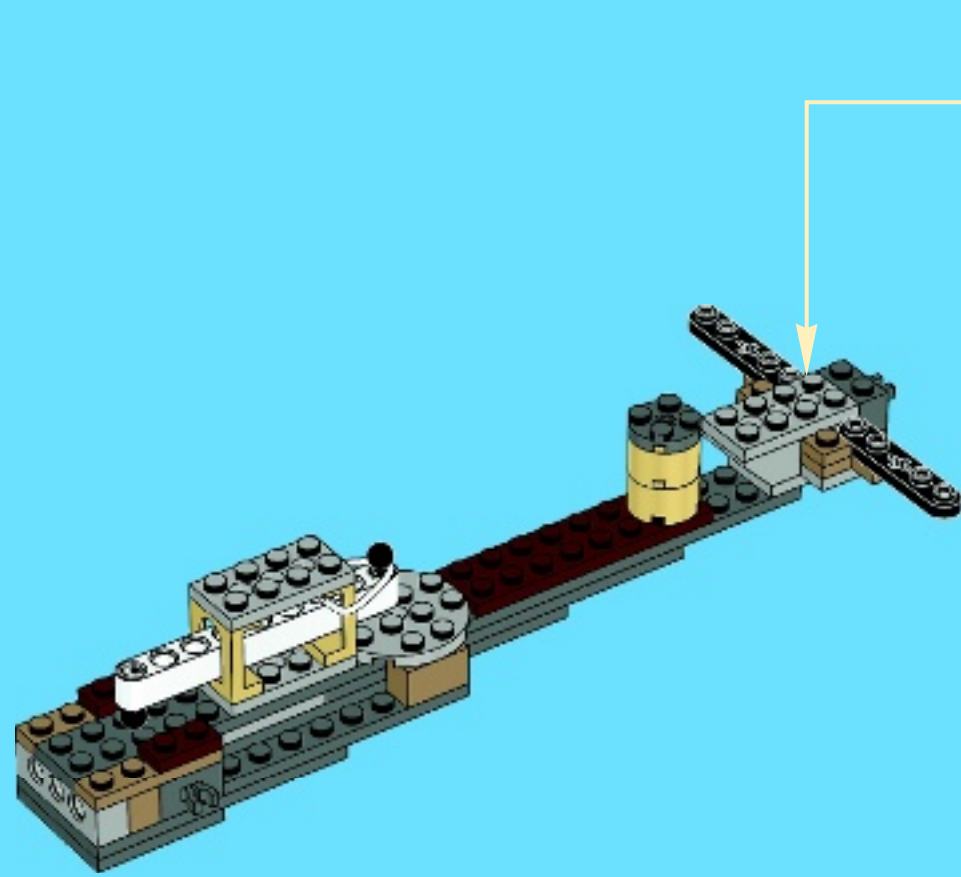
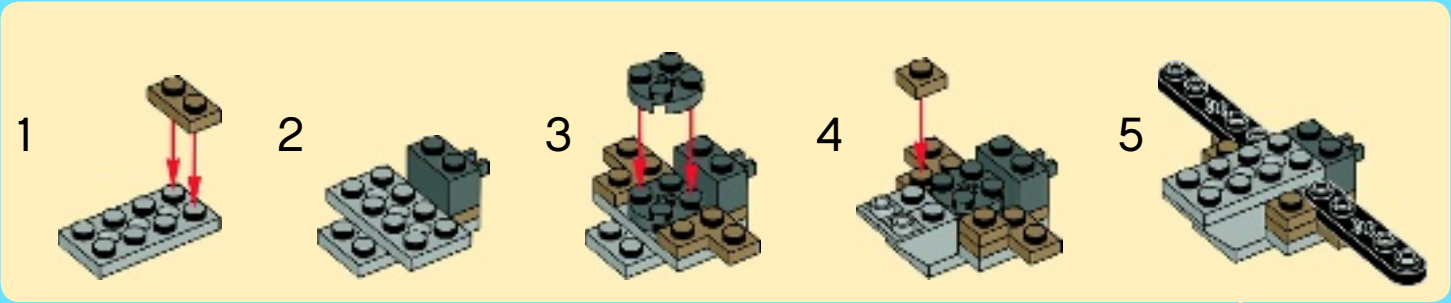

32

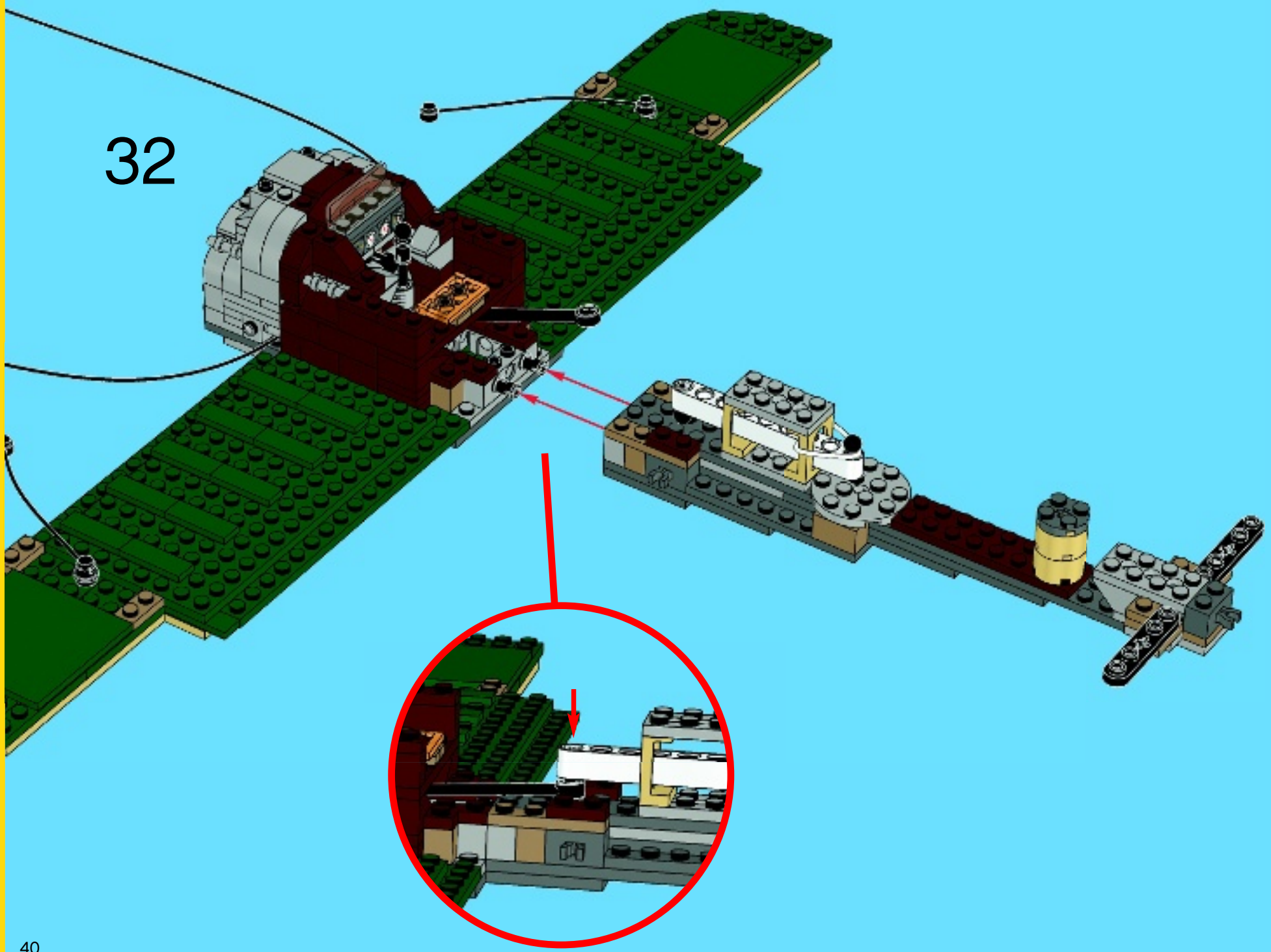

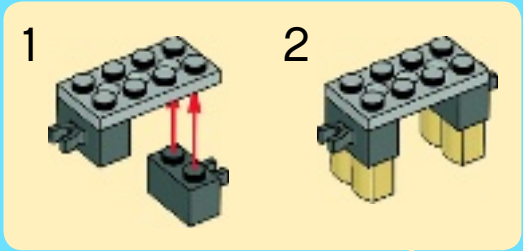
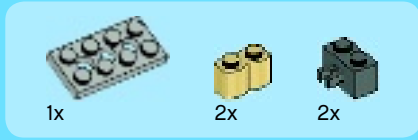

33

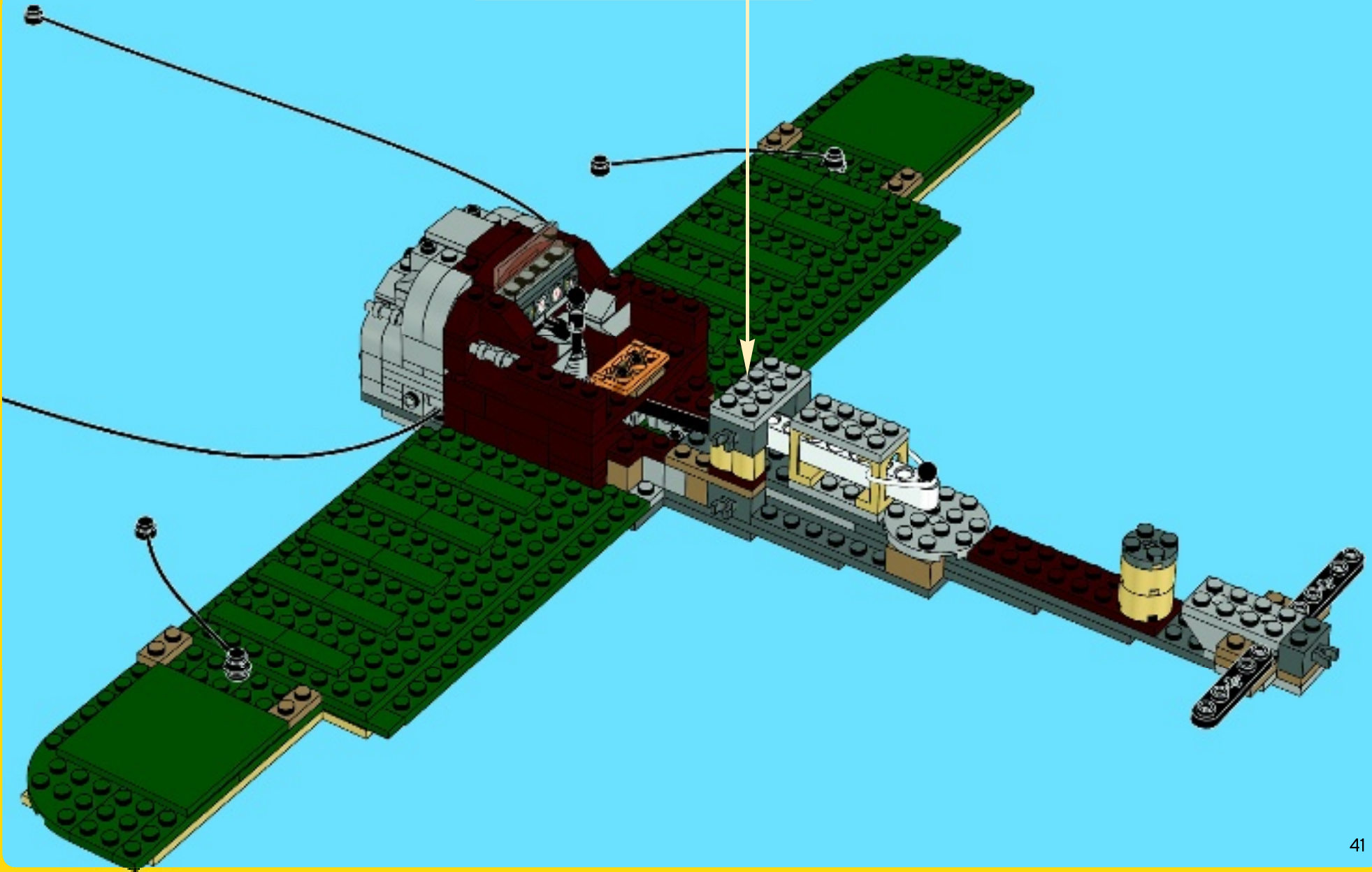

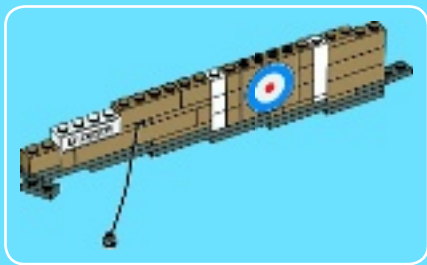

1

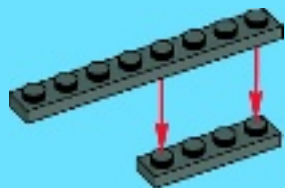

2

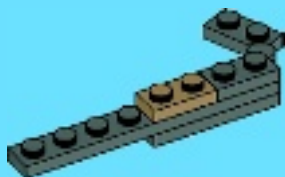

3

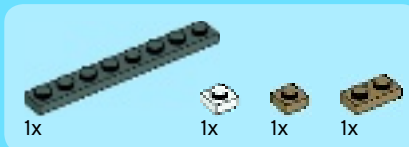
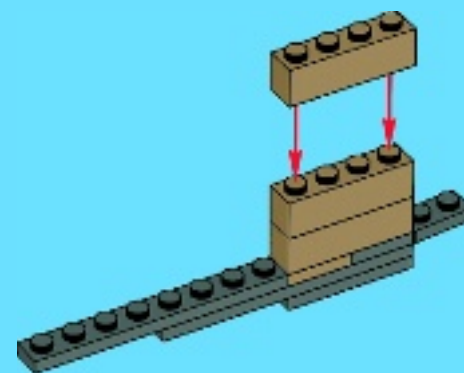

4

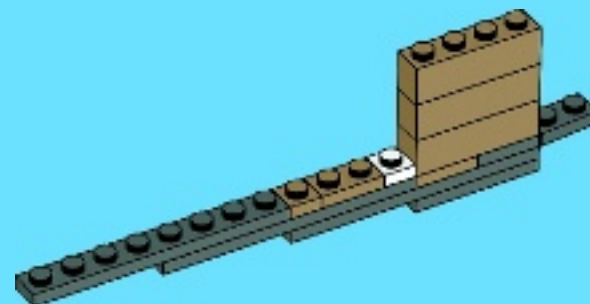

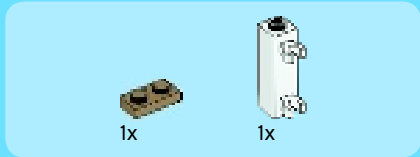

5

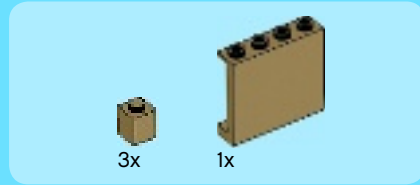
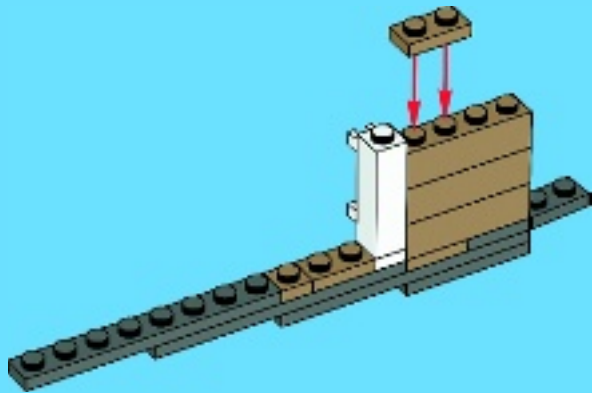

6

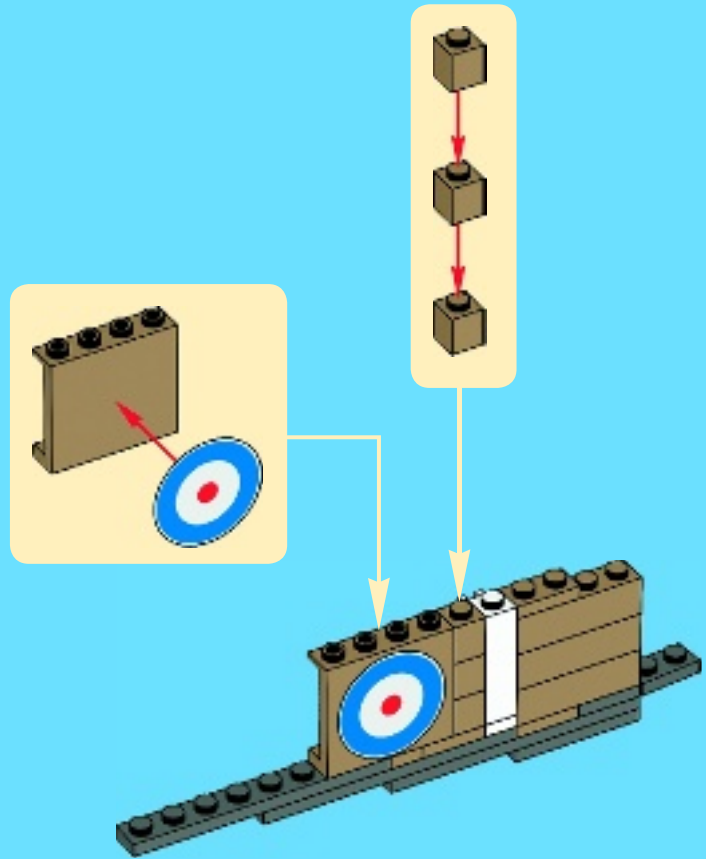



3x



3x

7

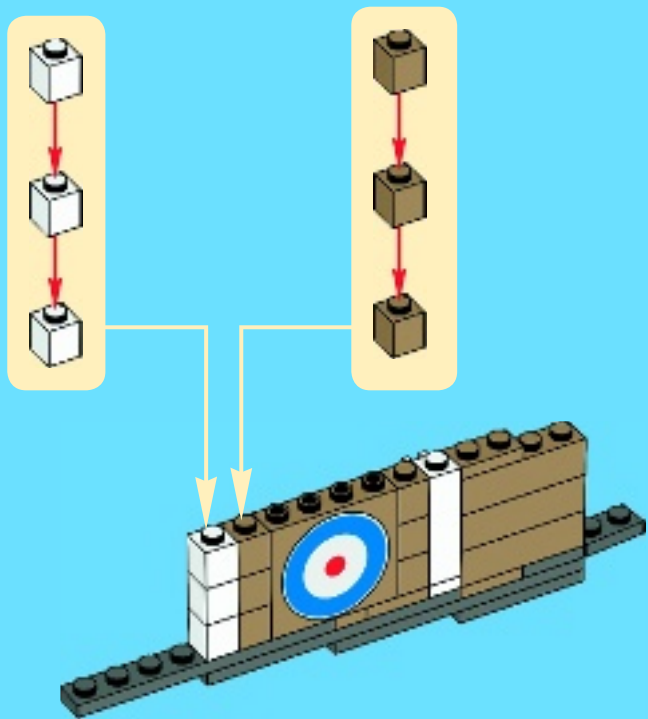

1x



2x



2x



2x

8

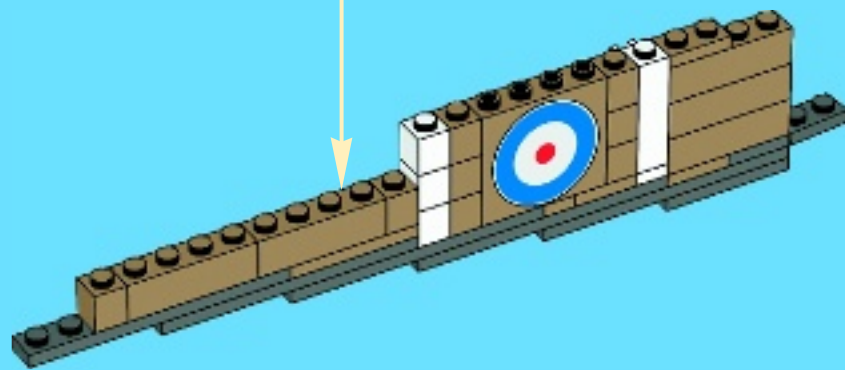
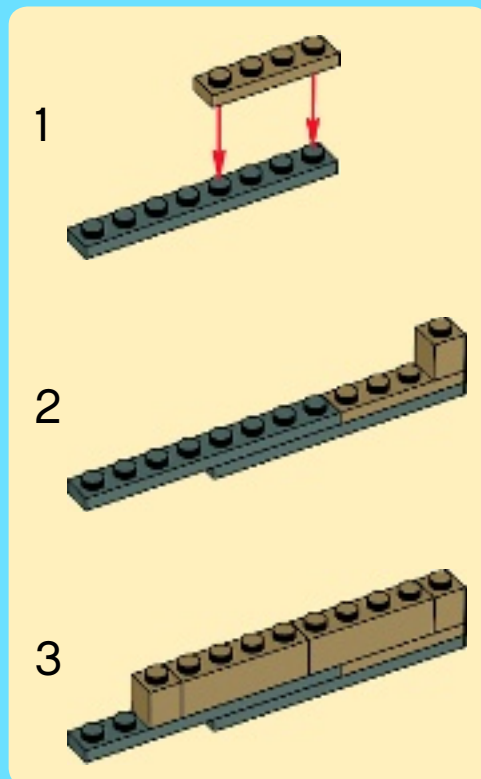

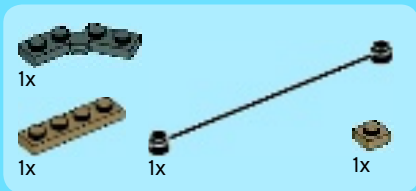

9

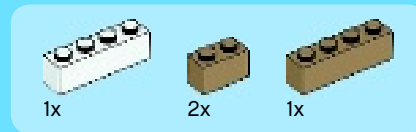
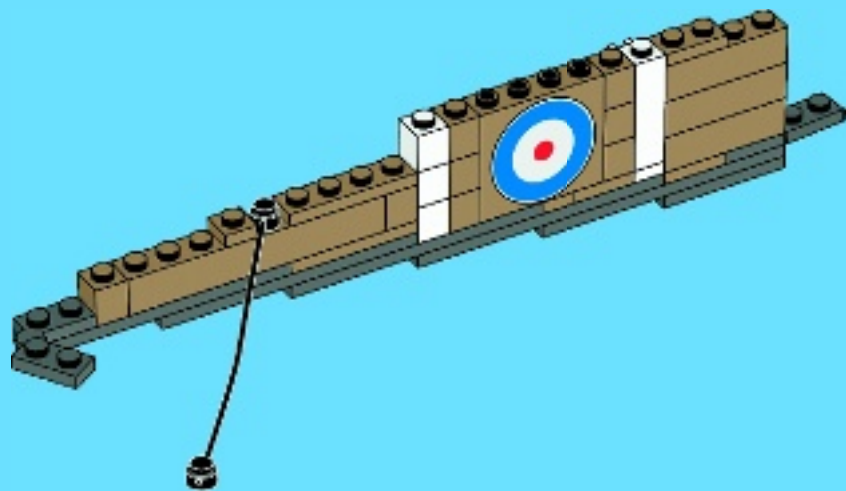

10

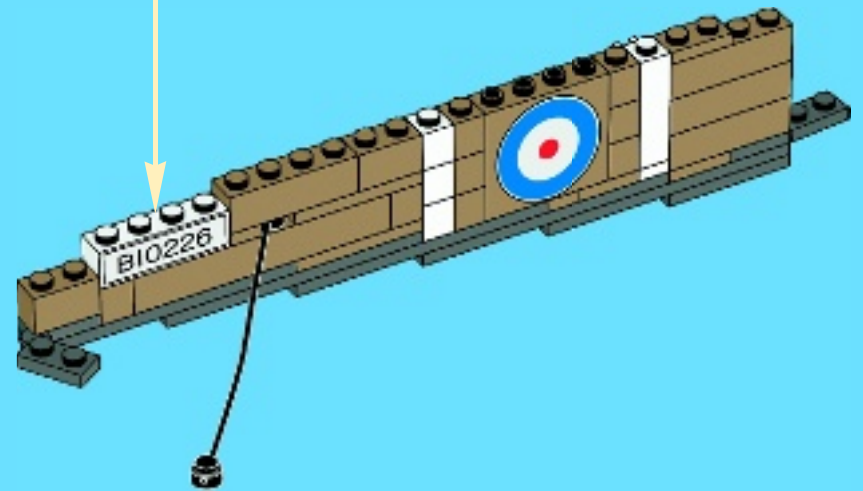
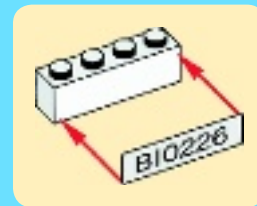

34

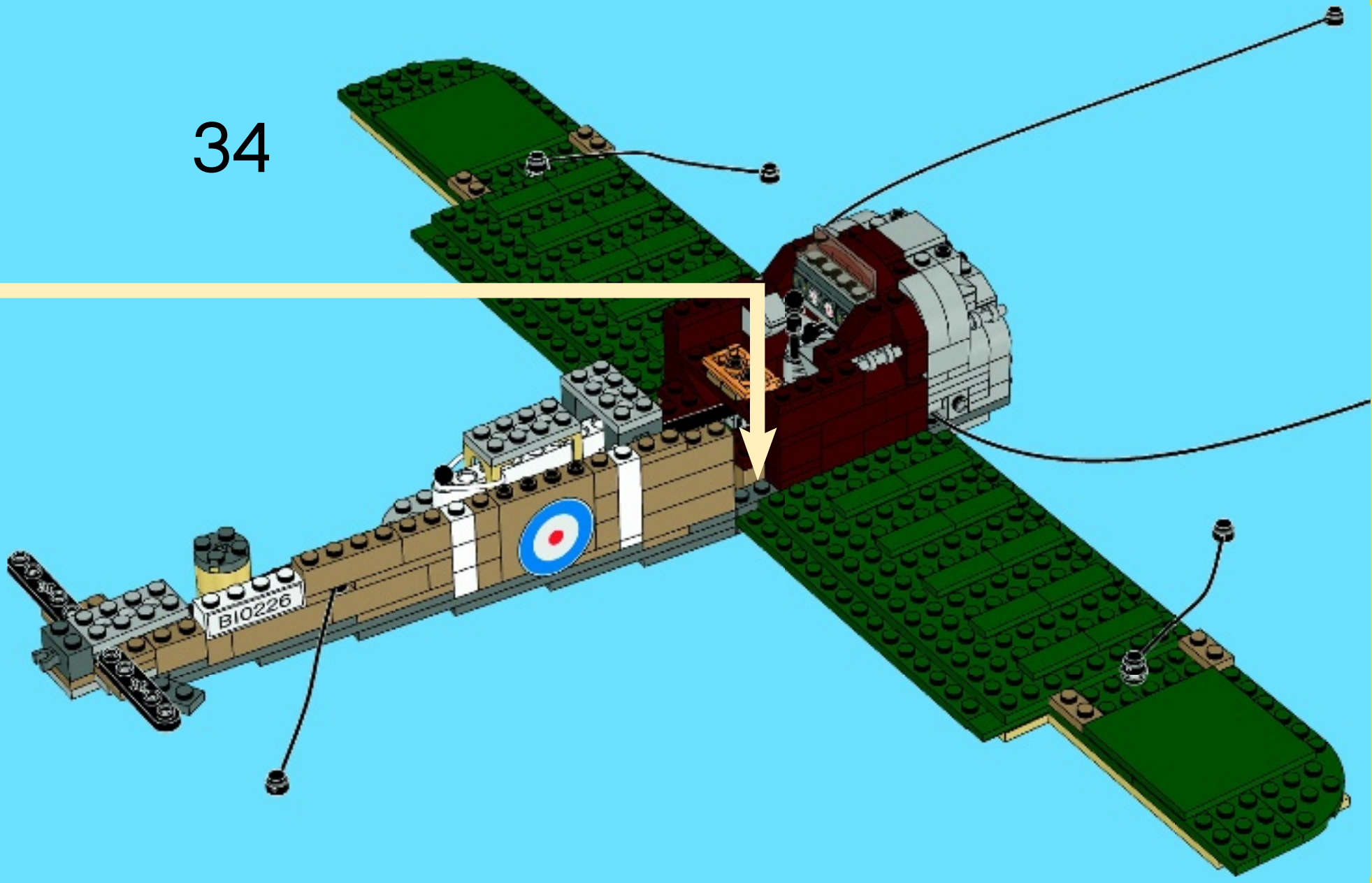

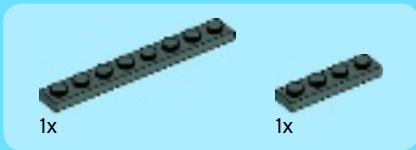
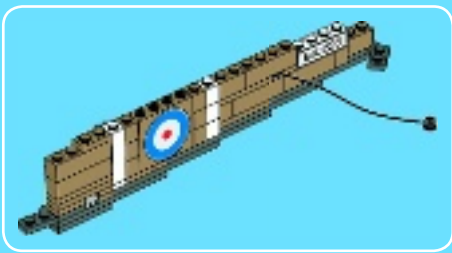

1

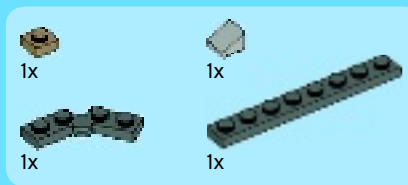
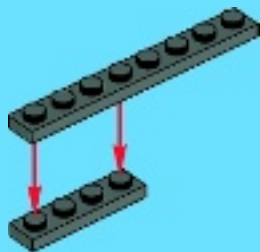

2

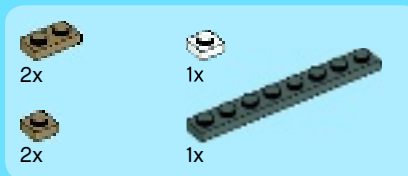
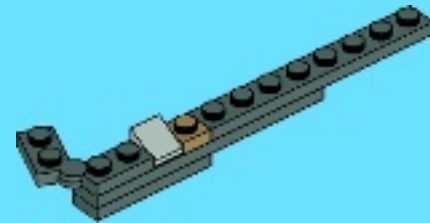

3

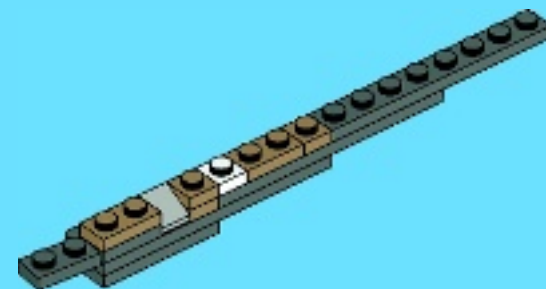

4

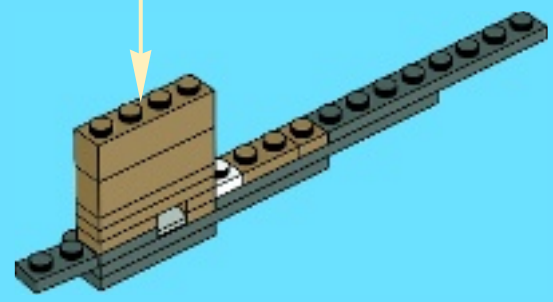
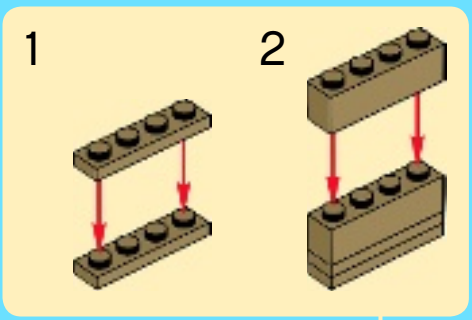

5

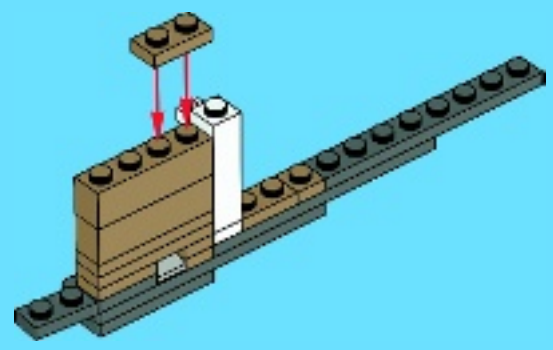
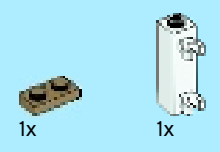

6

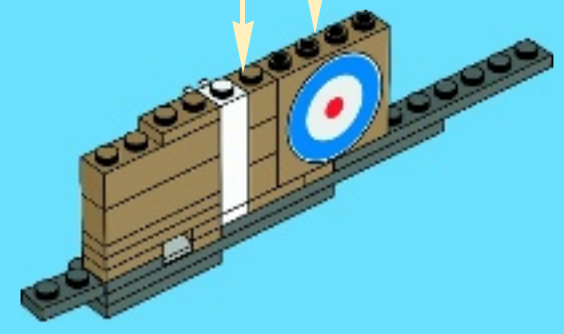
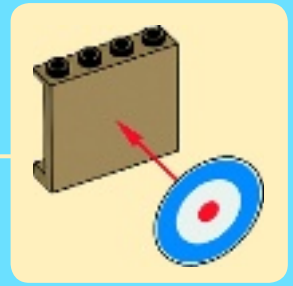
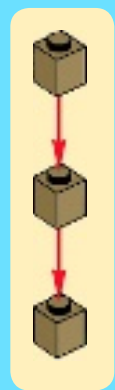
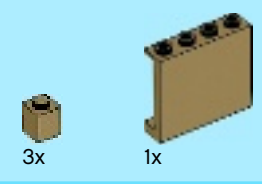



3x



3x

7

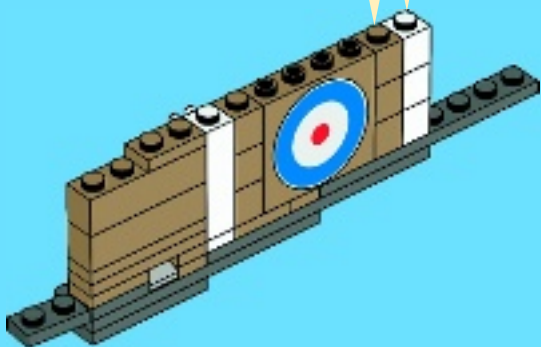
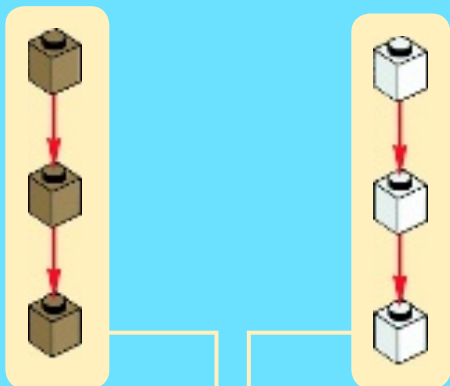

1x



2x



2x



2x

8

1

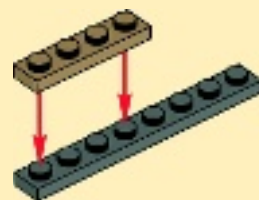

2

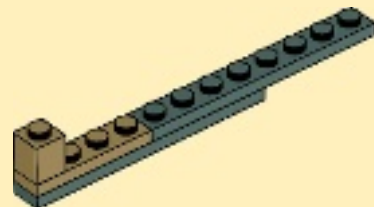

3

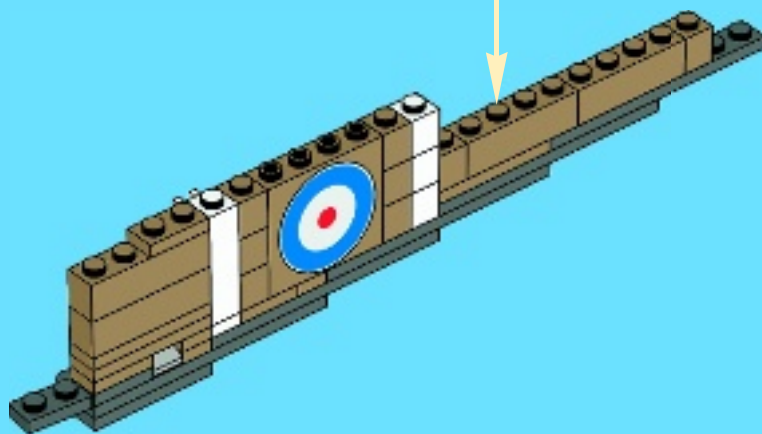
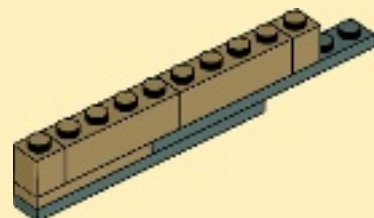

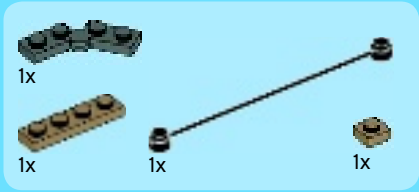

9

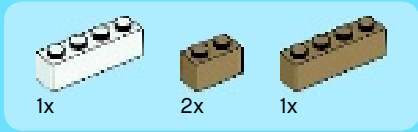
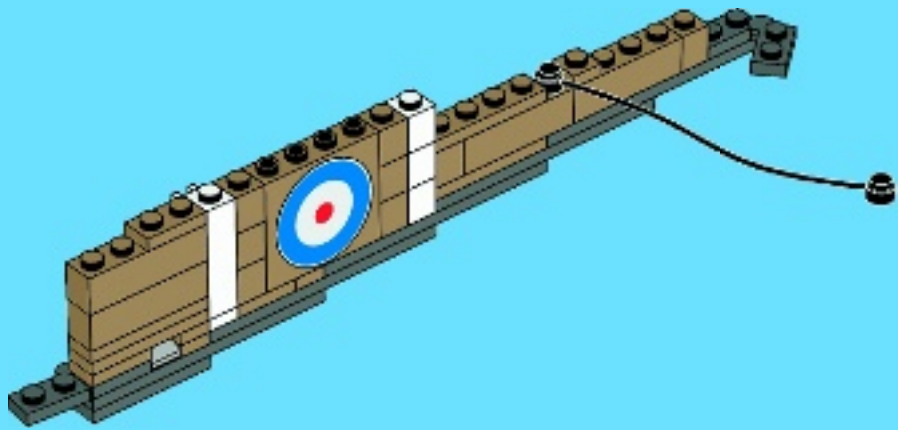

10

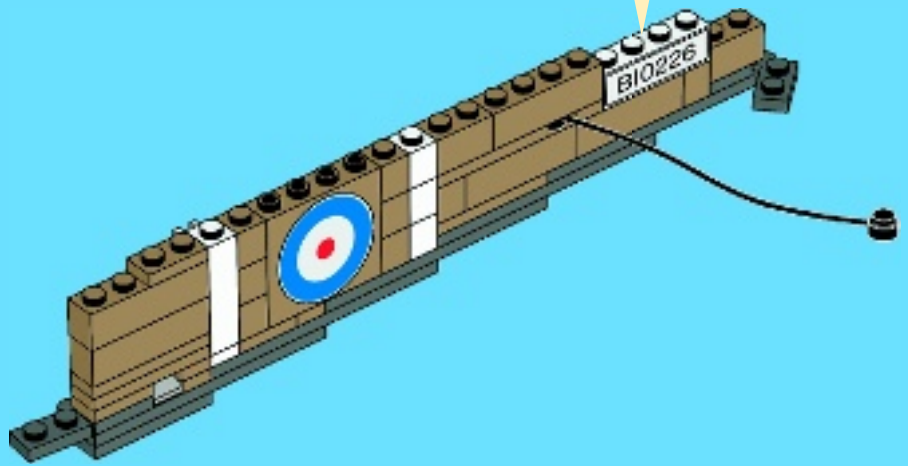
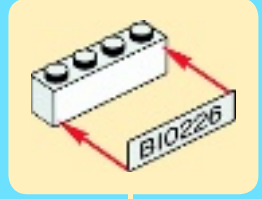

35

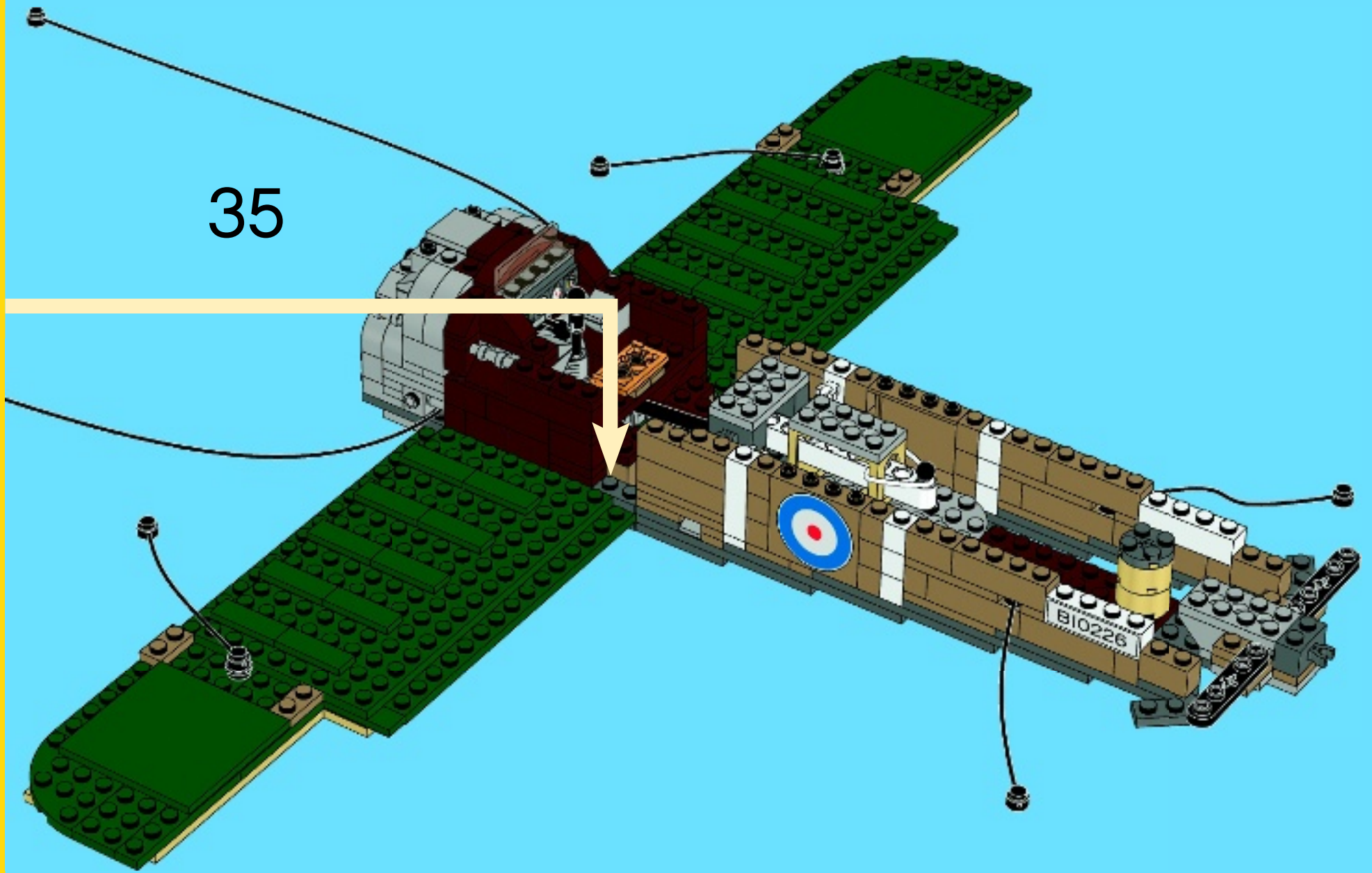



2x



4x

36



2x

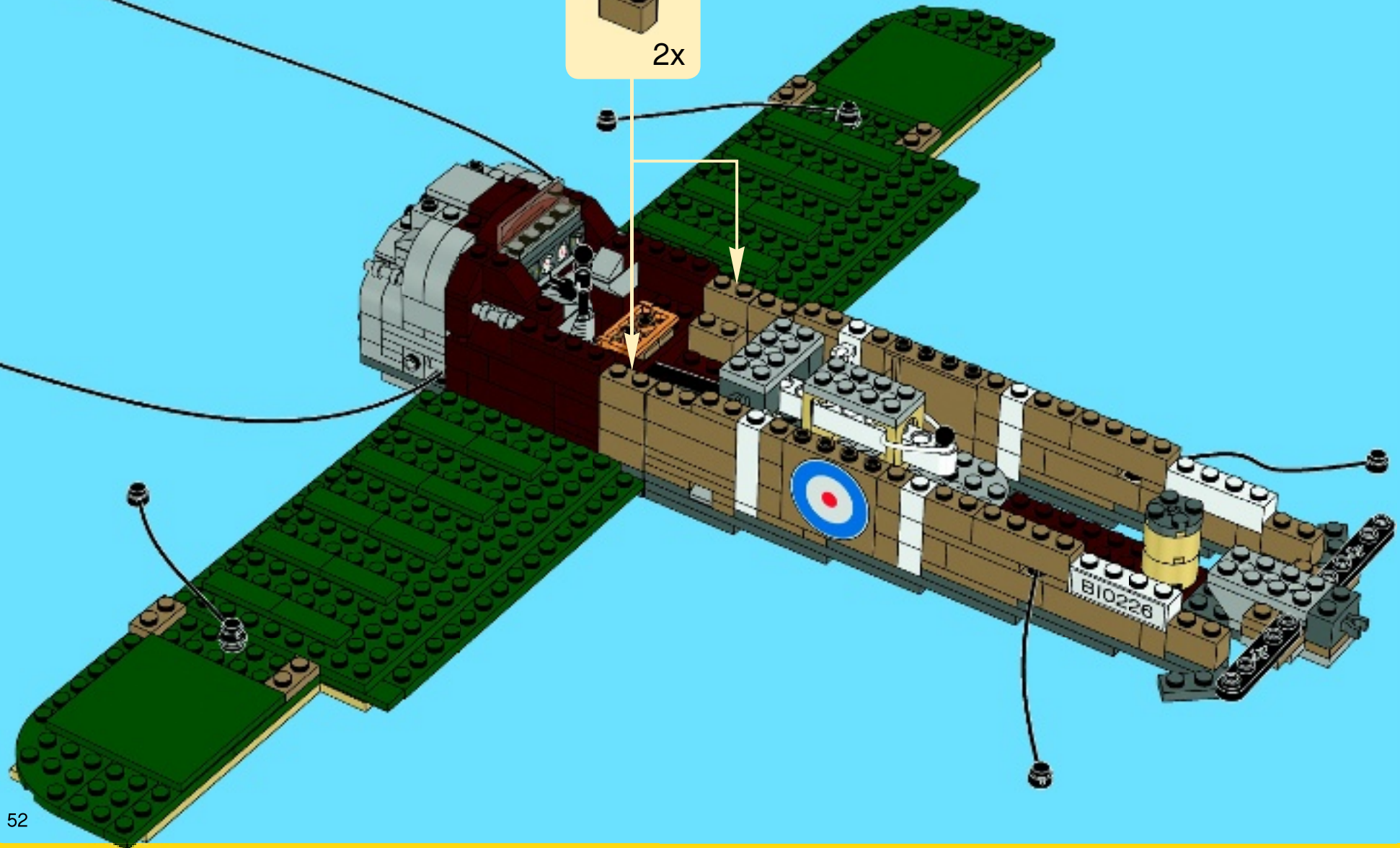



2x



1x

37

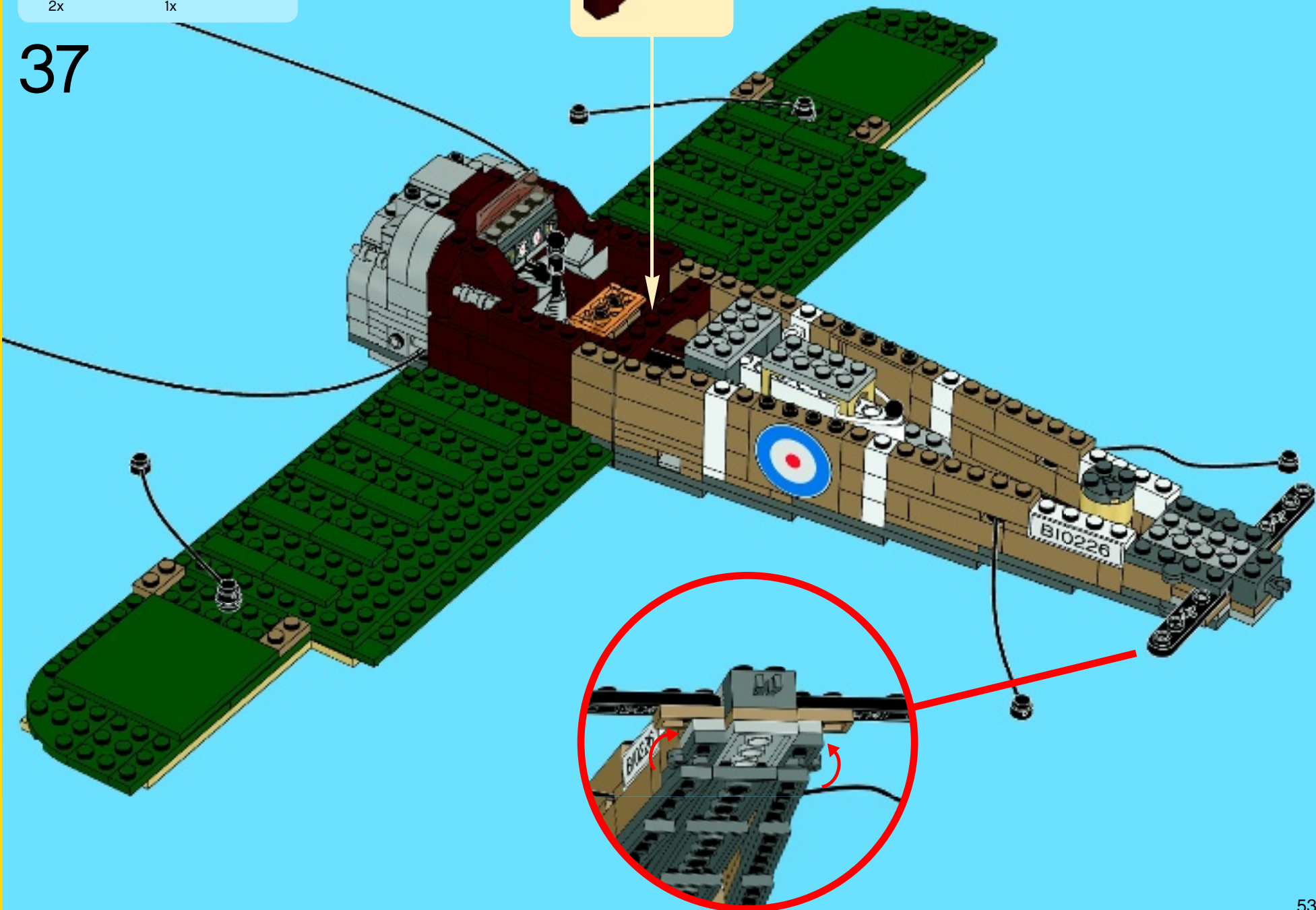
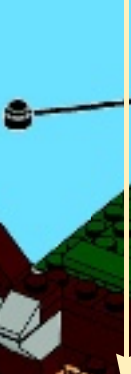

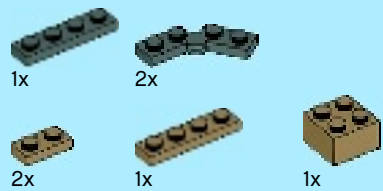

38

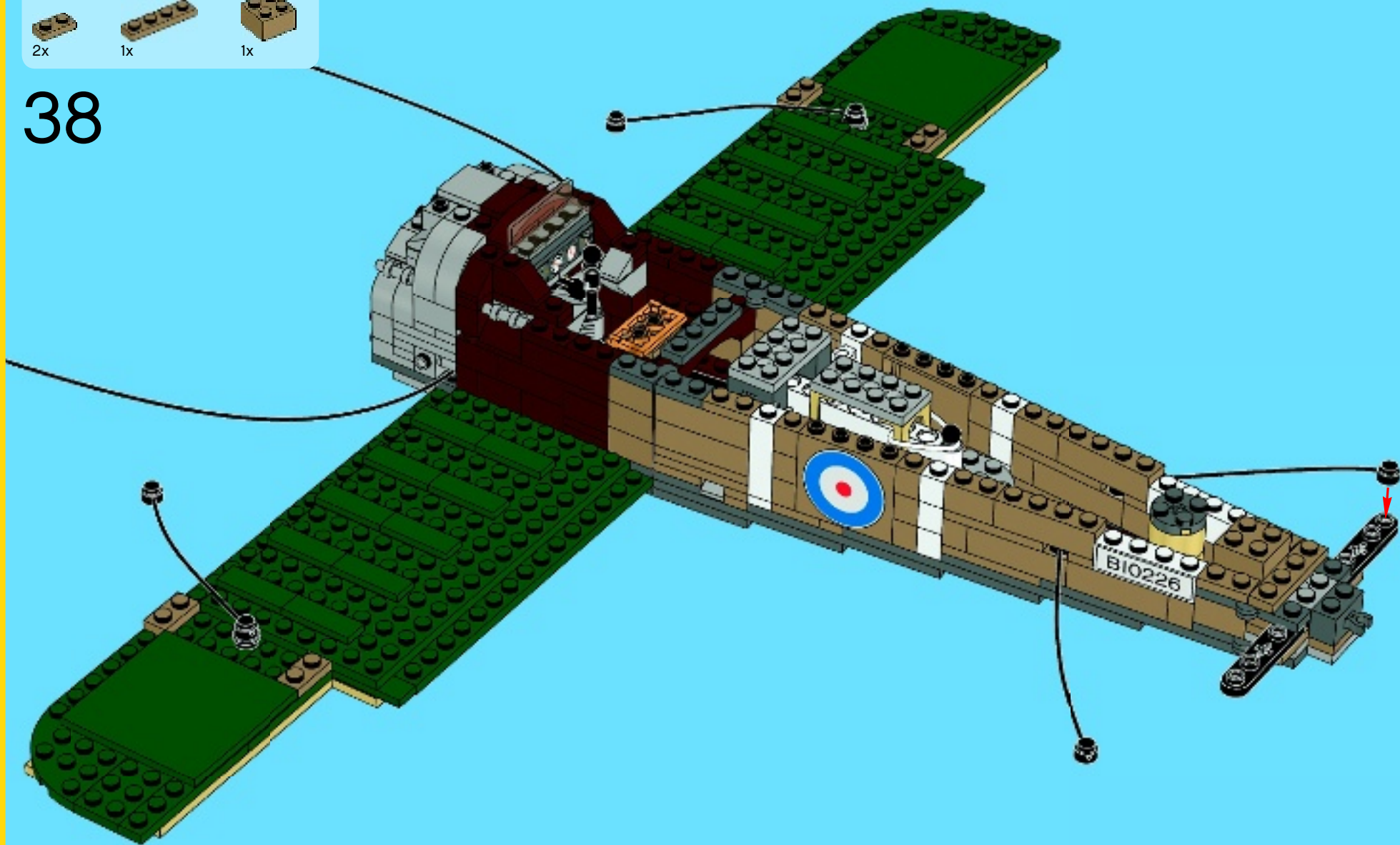

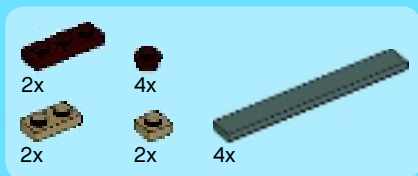

39

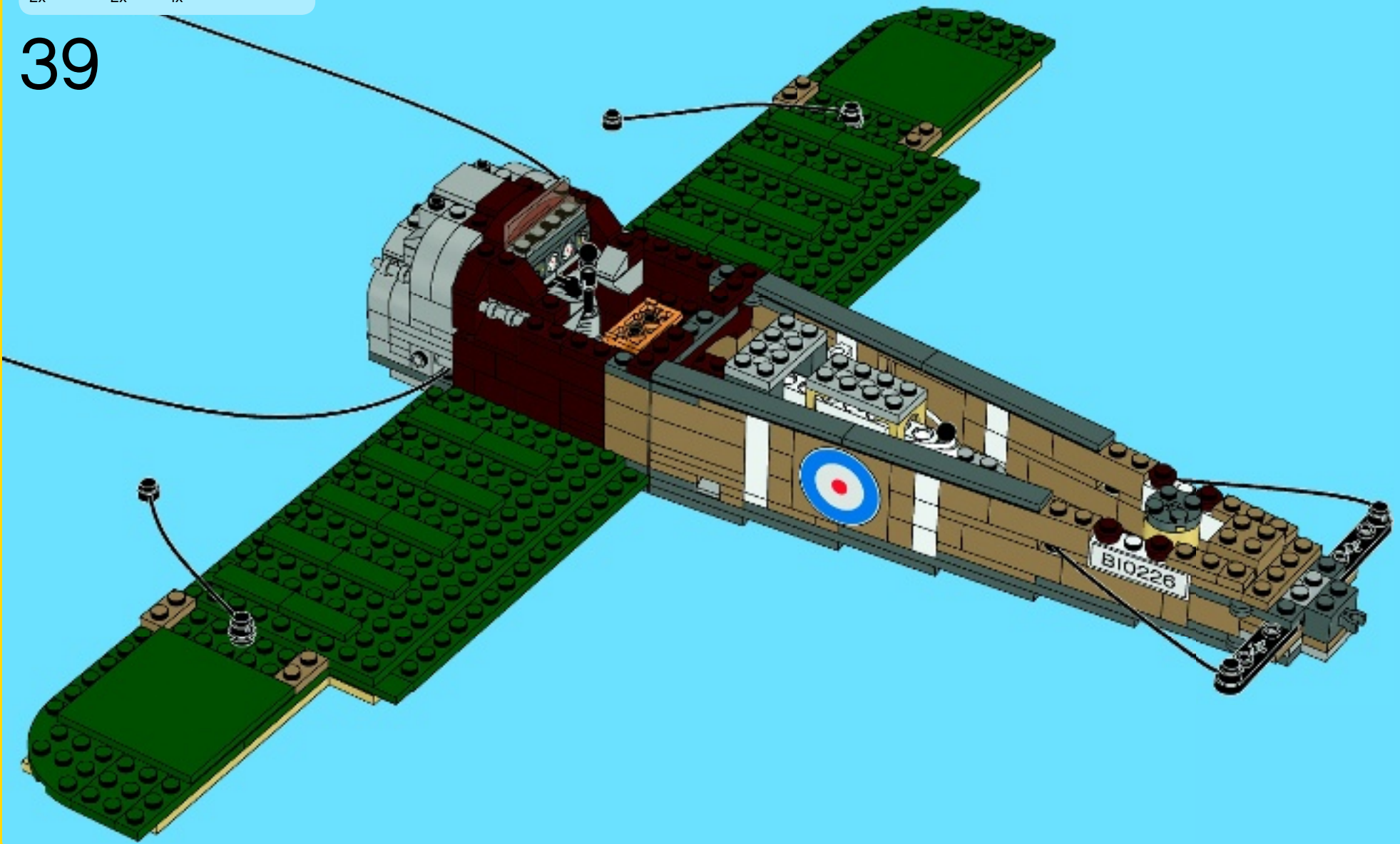

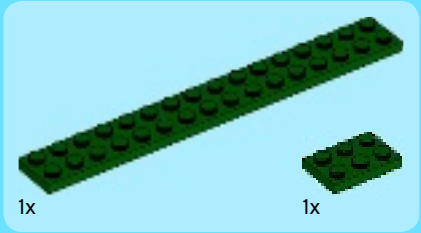
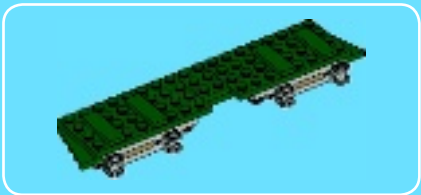

1

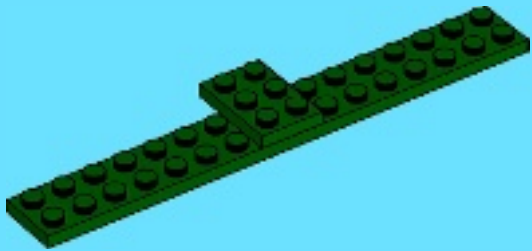

2

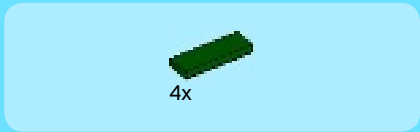
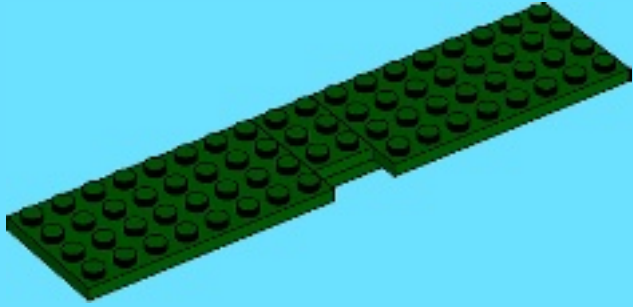

3

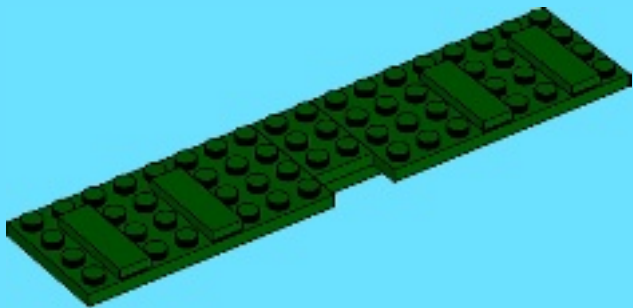

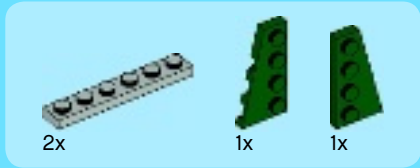

4

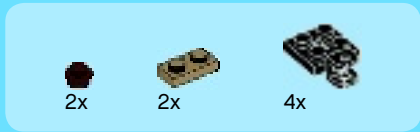
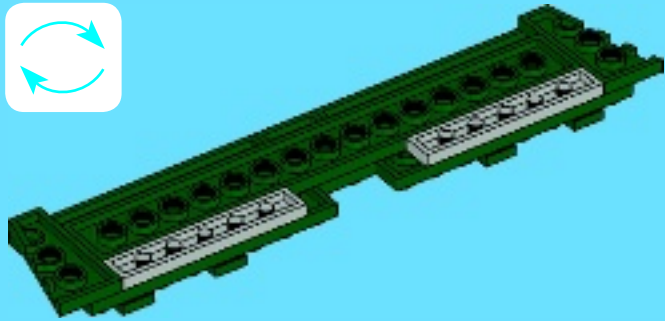

5

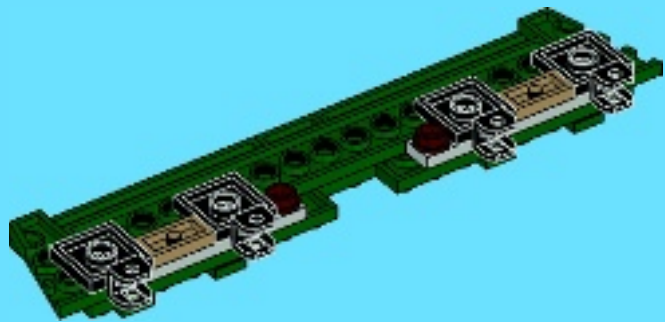

6

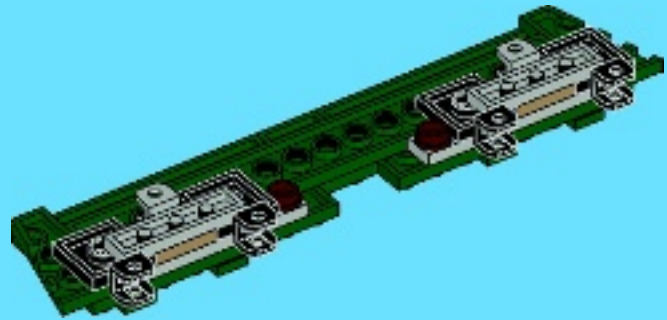

40

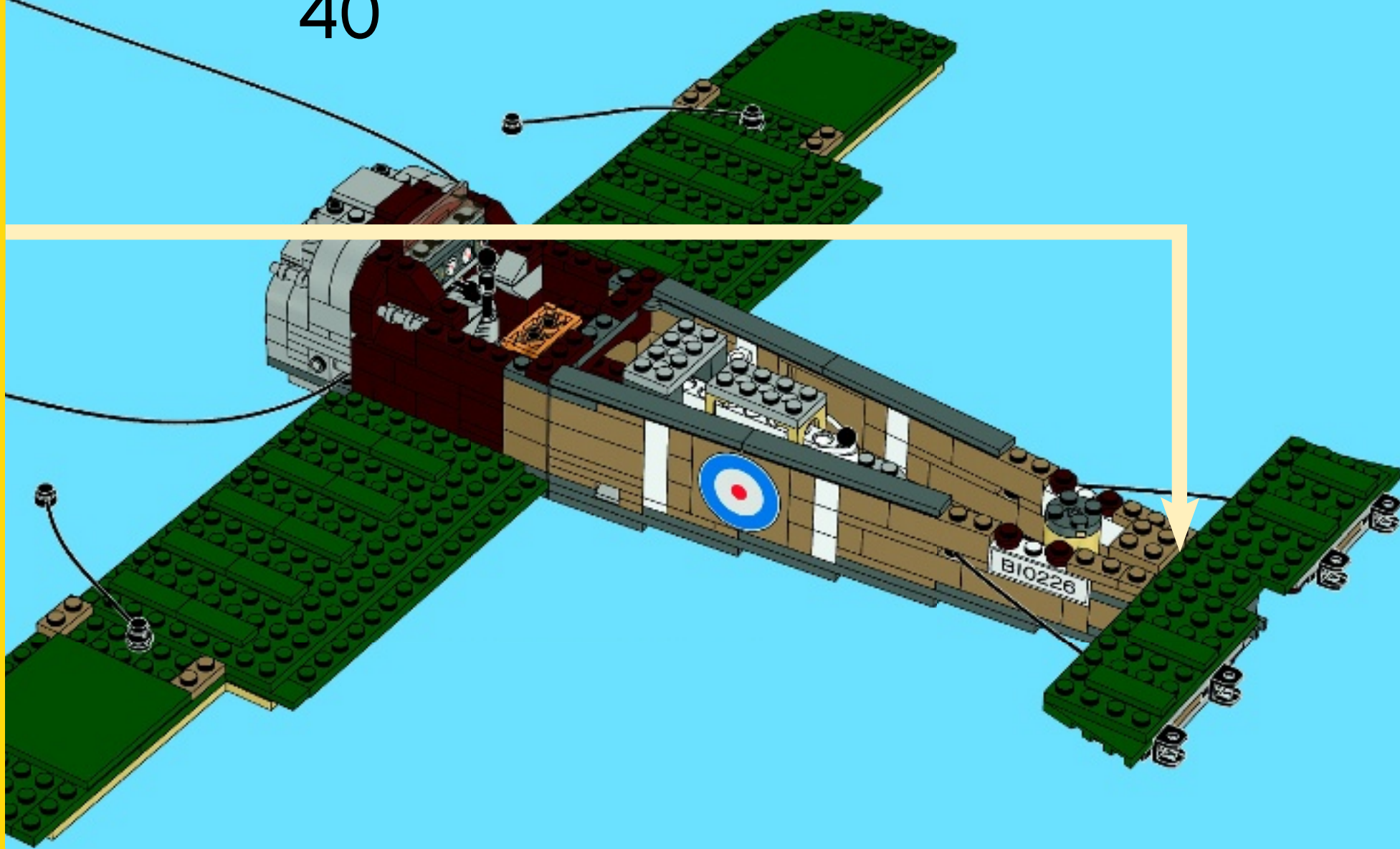

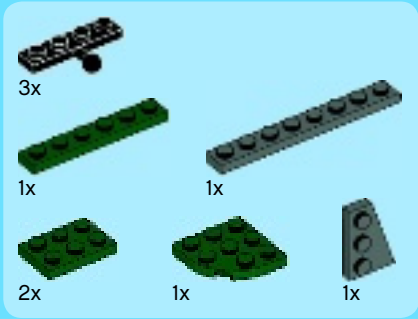

41

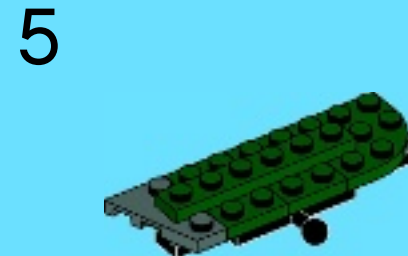
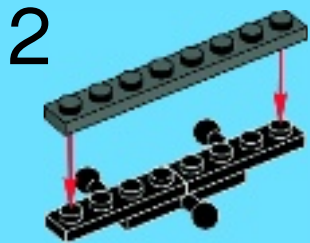
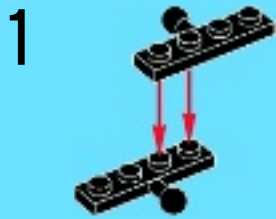

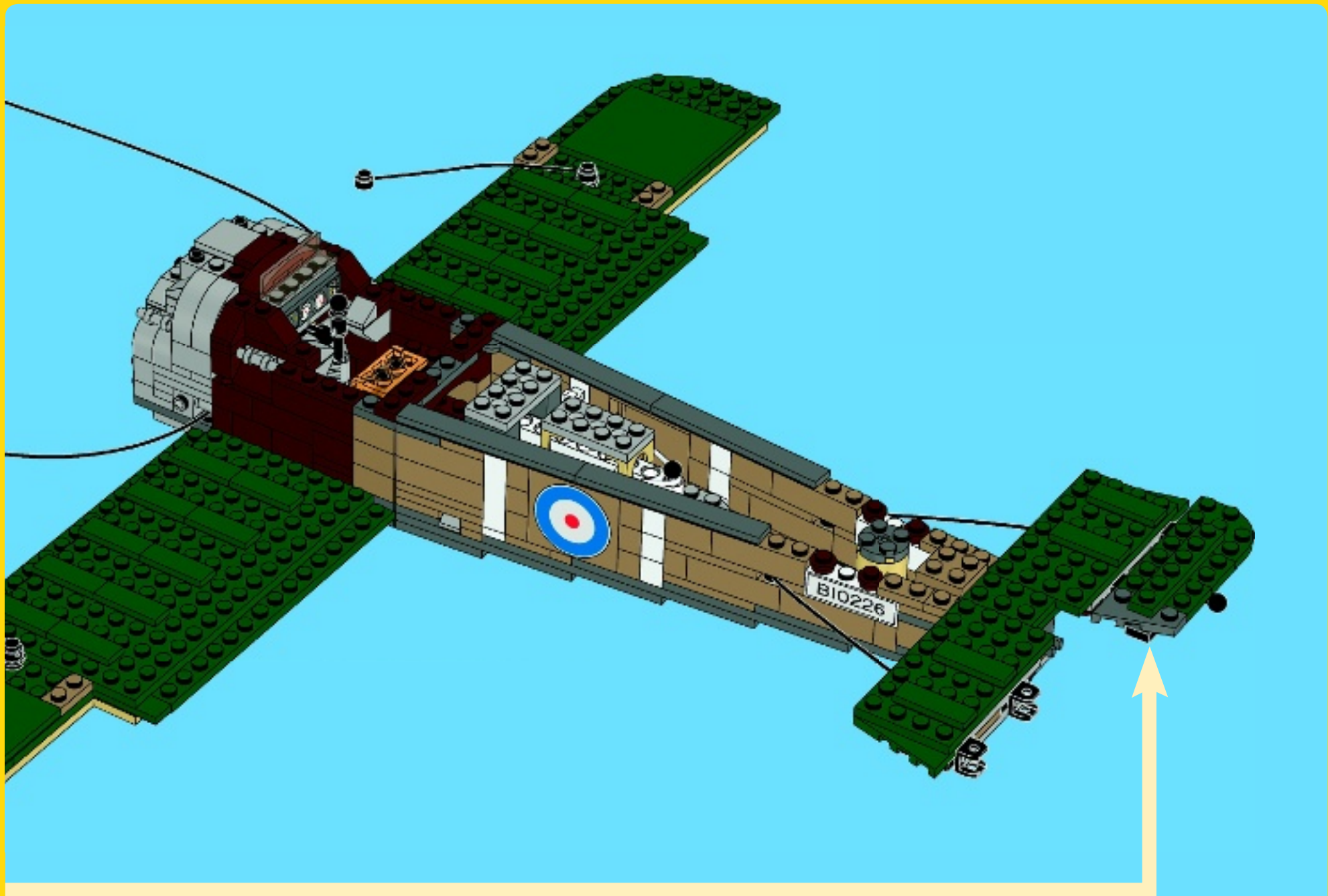

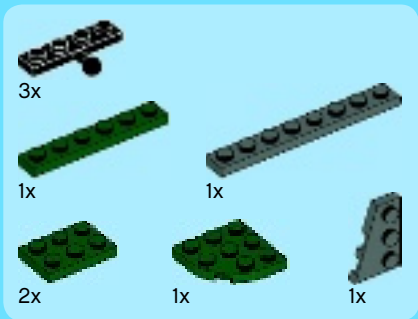

42

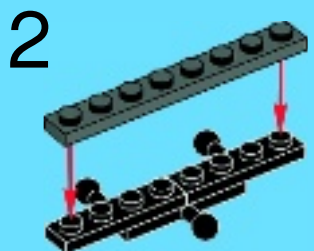
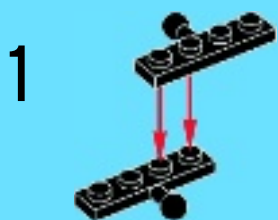

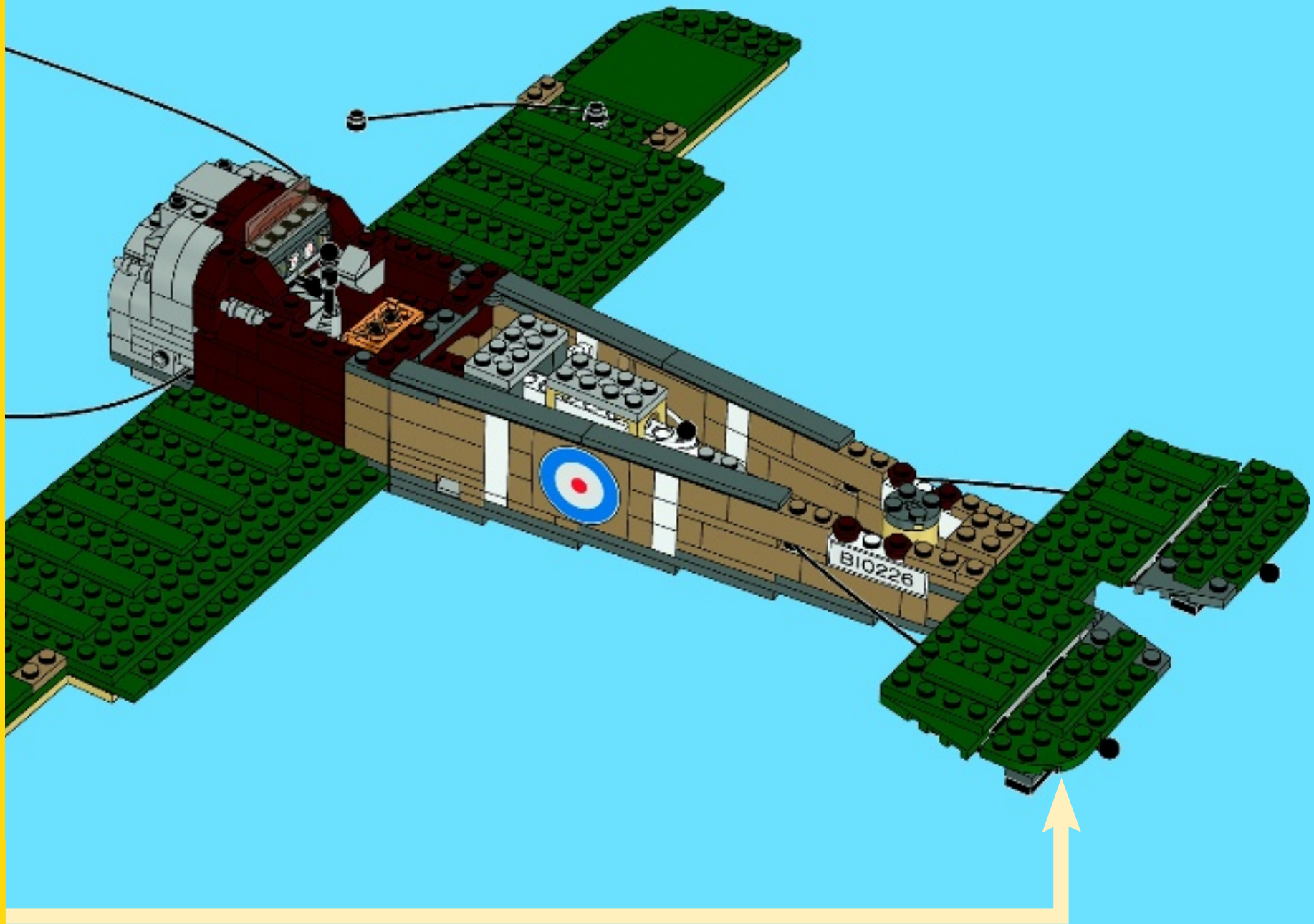

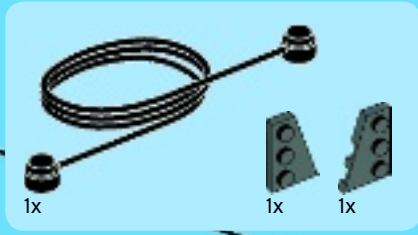

43

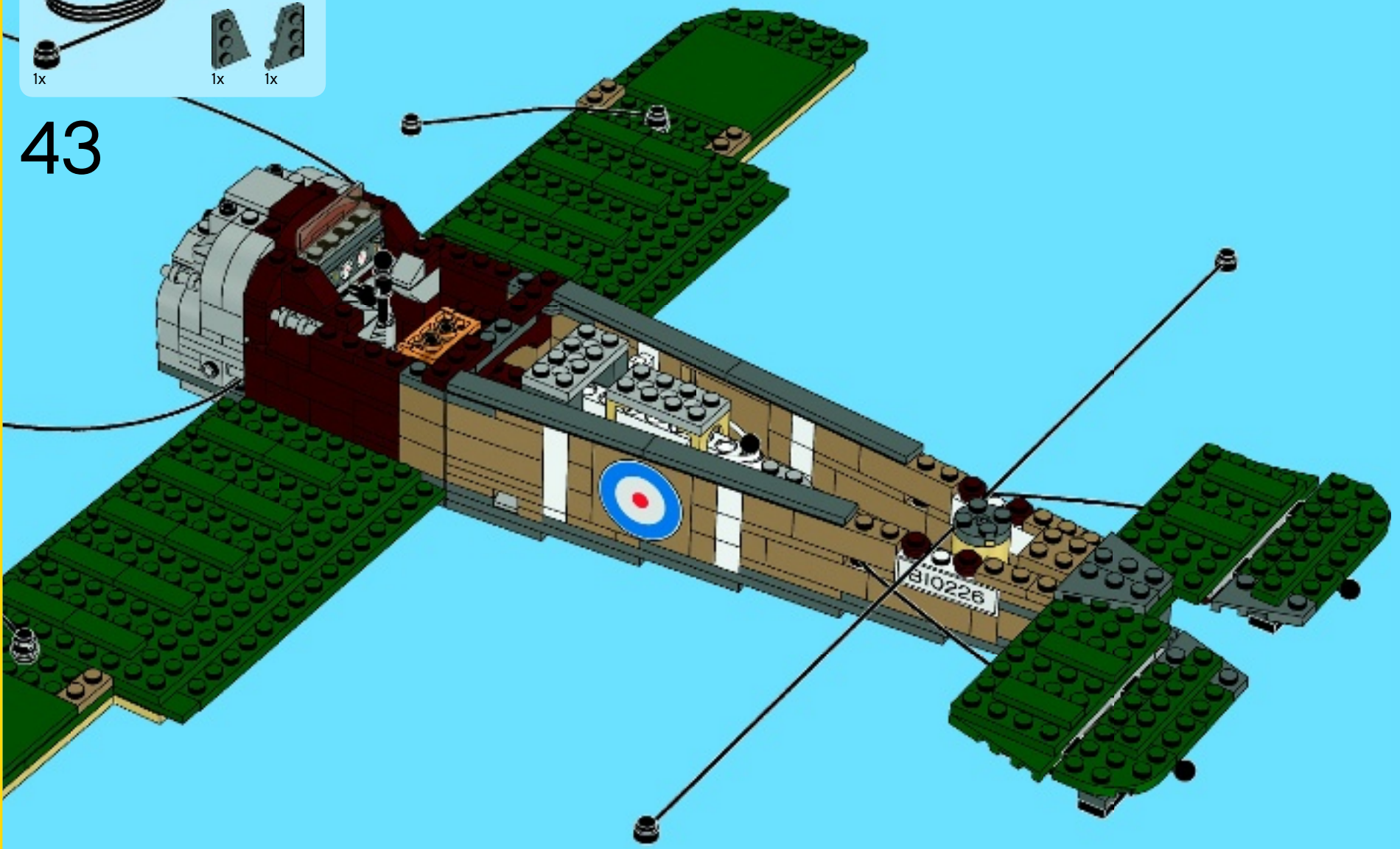



2x



4x

44

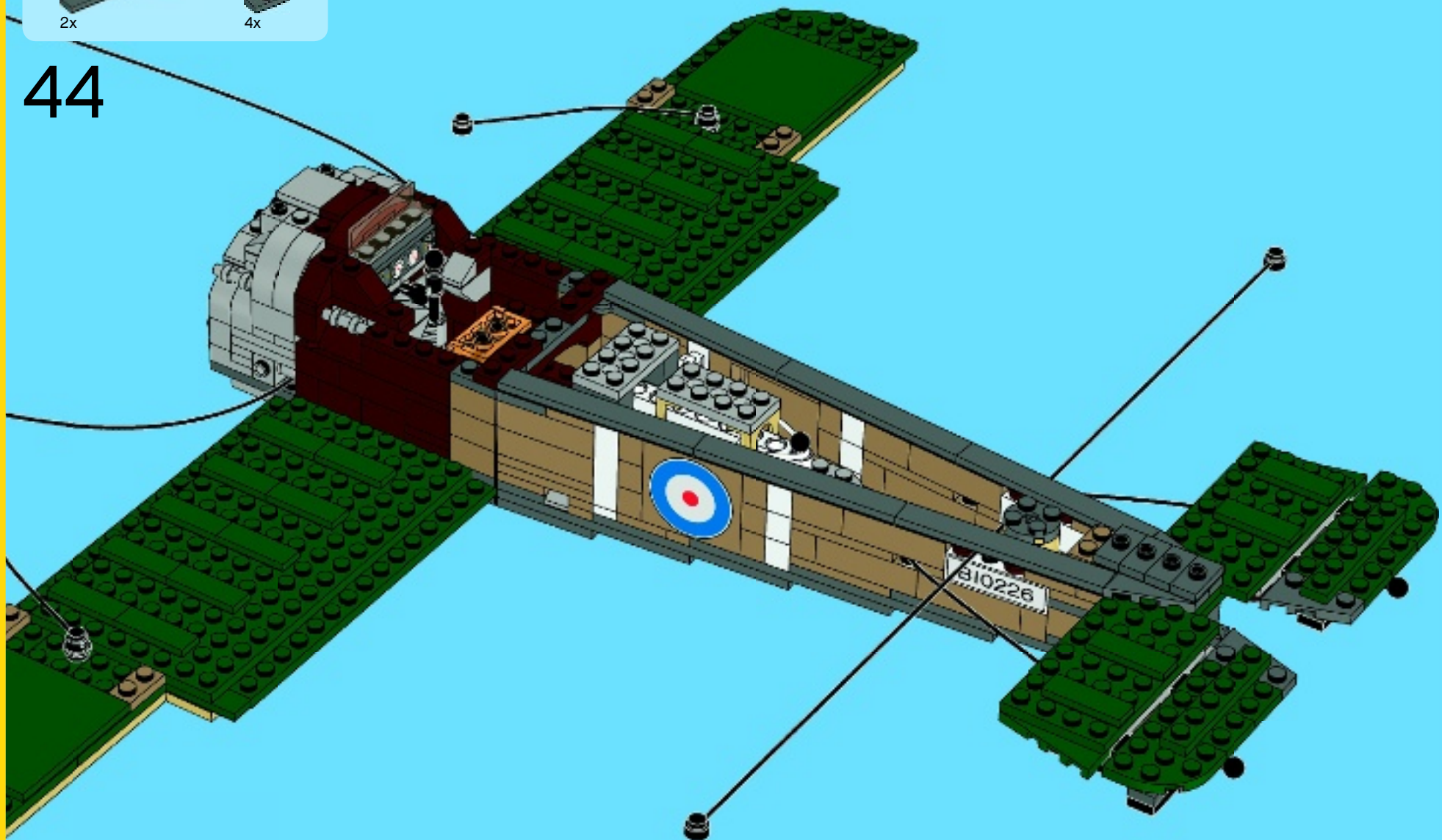

45

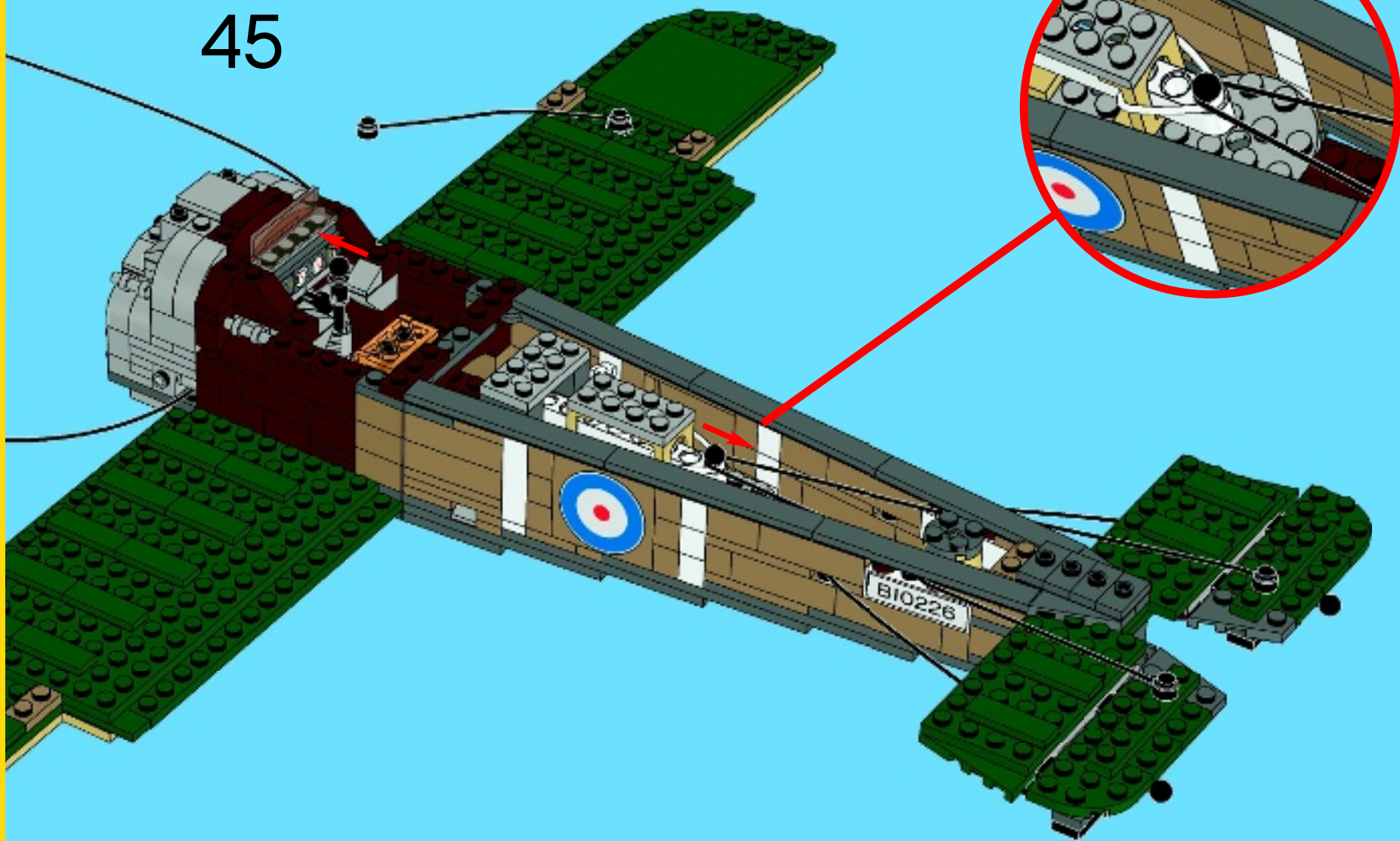

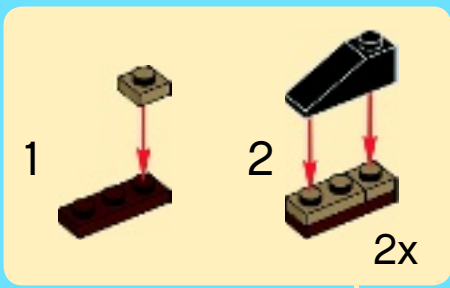
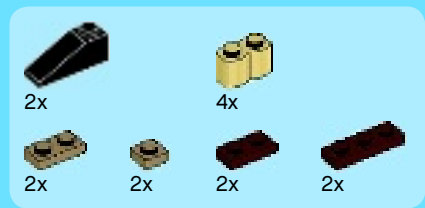

46

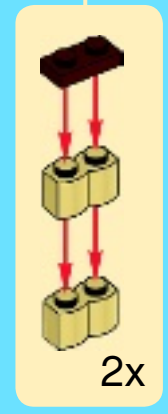
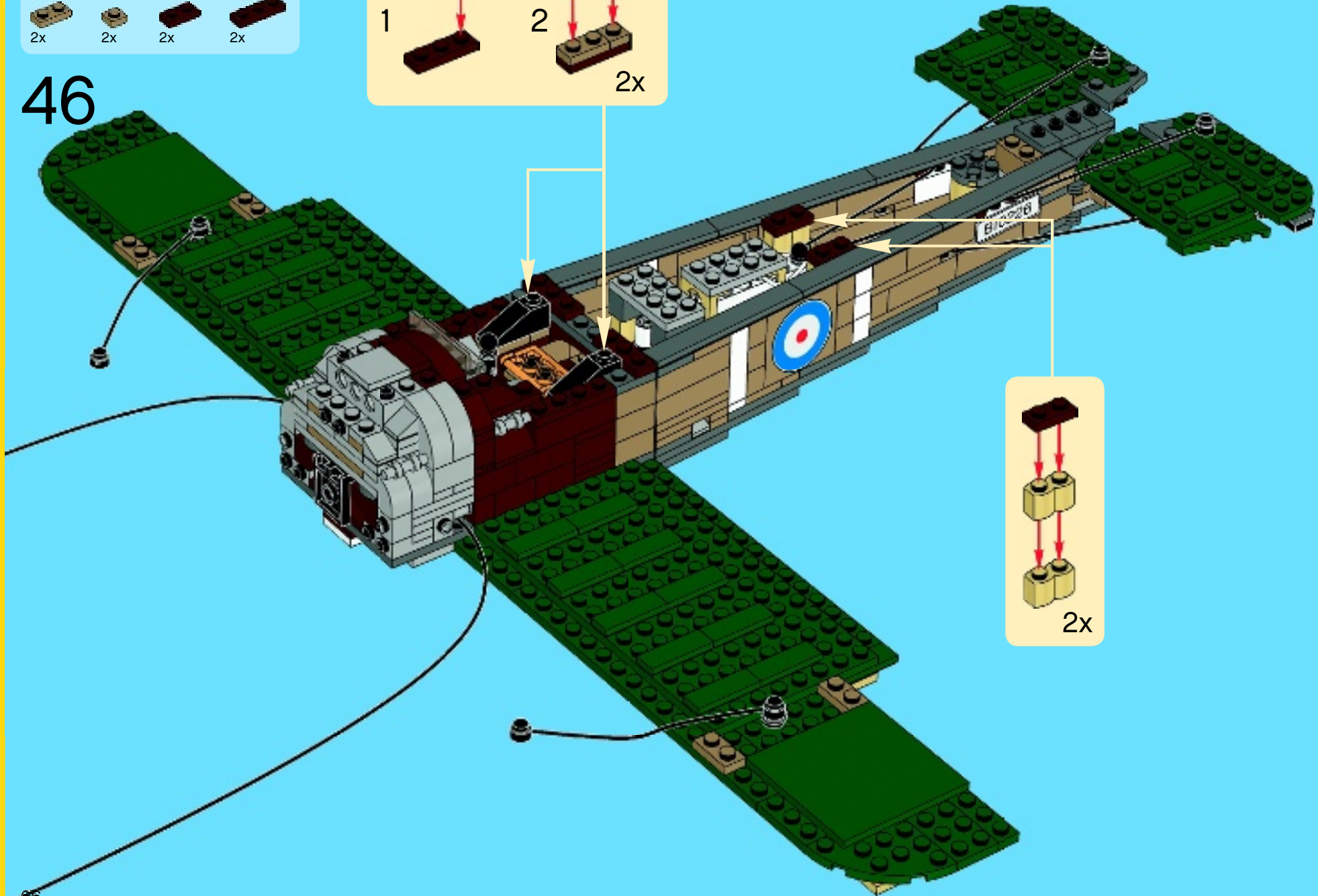

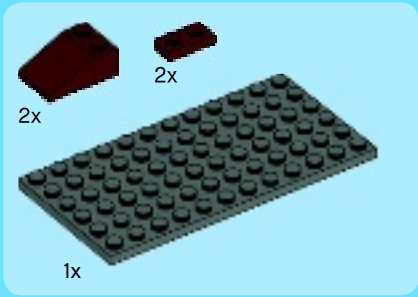
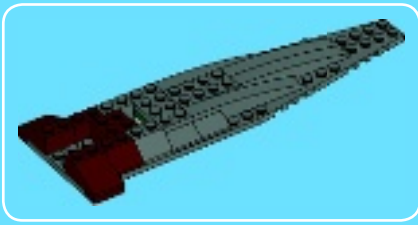

1

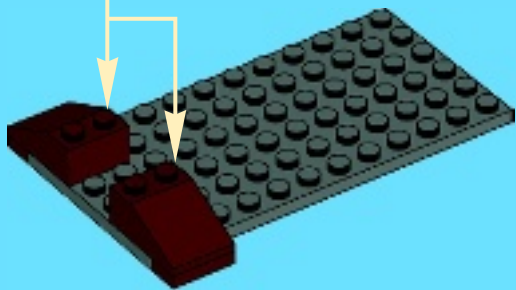
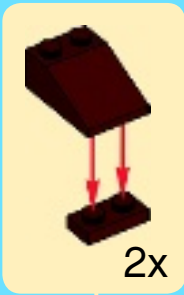

2

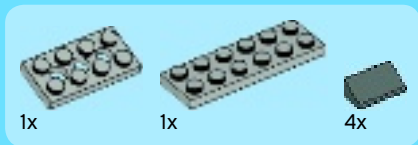
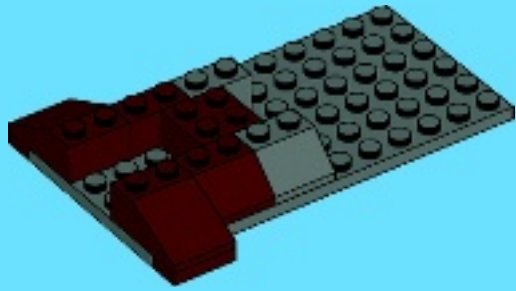

3

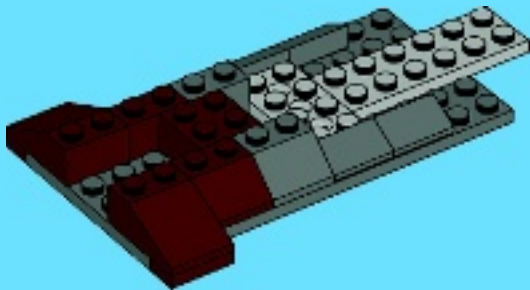

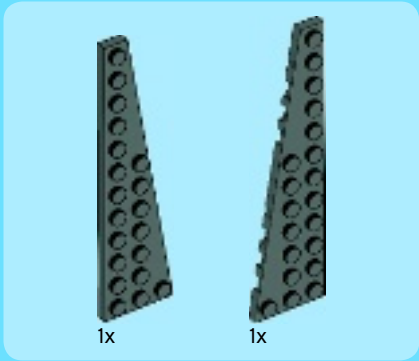

4

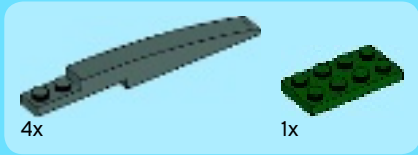
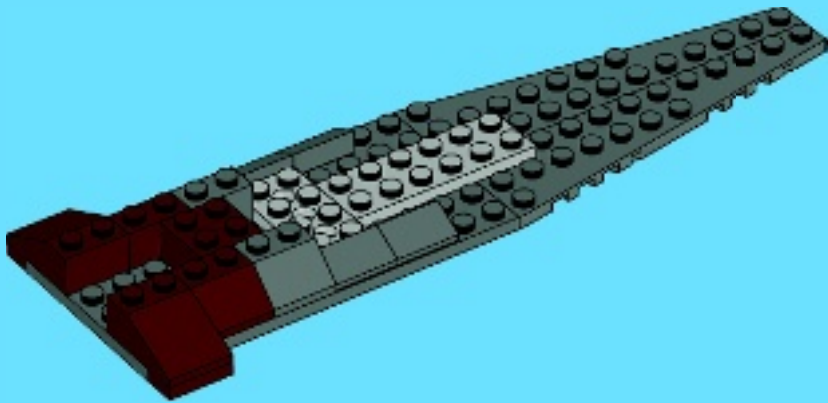

5

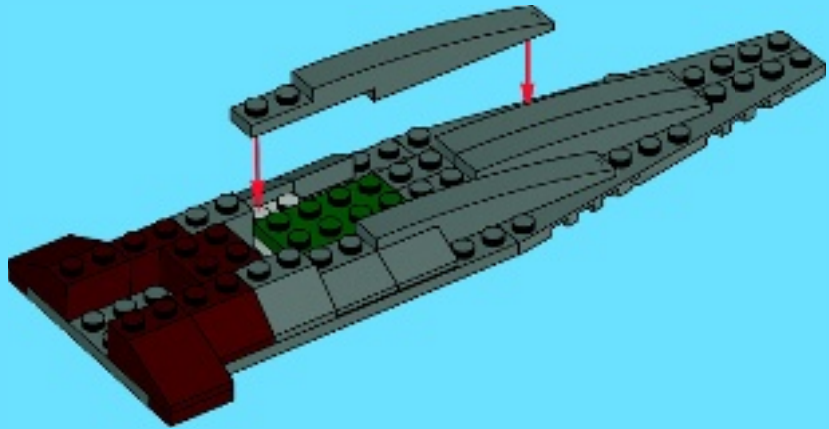

6

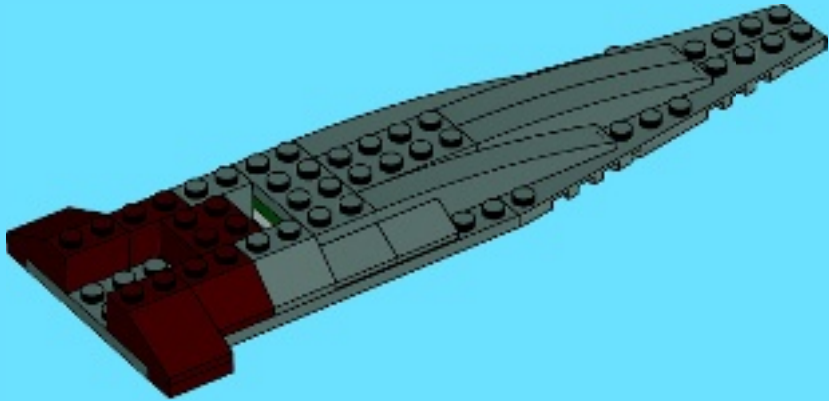

47

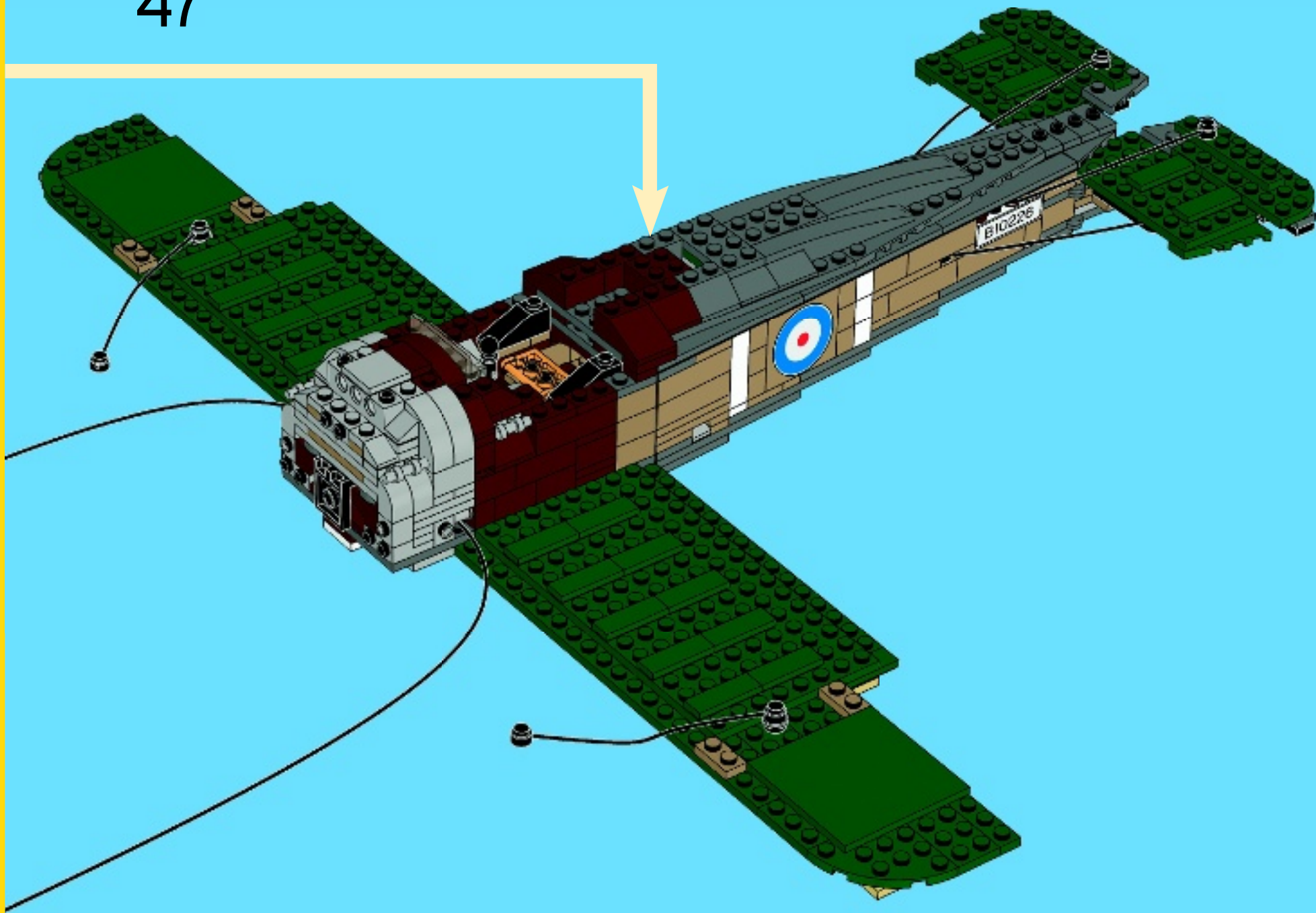

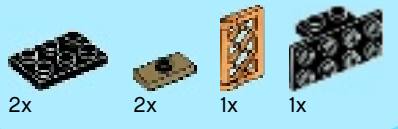

48

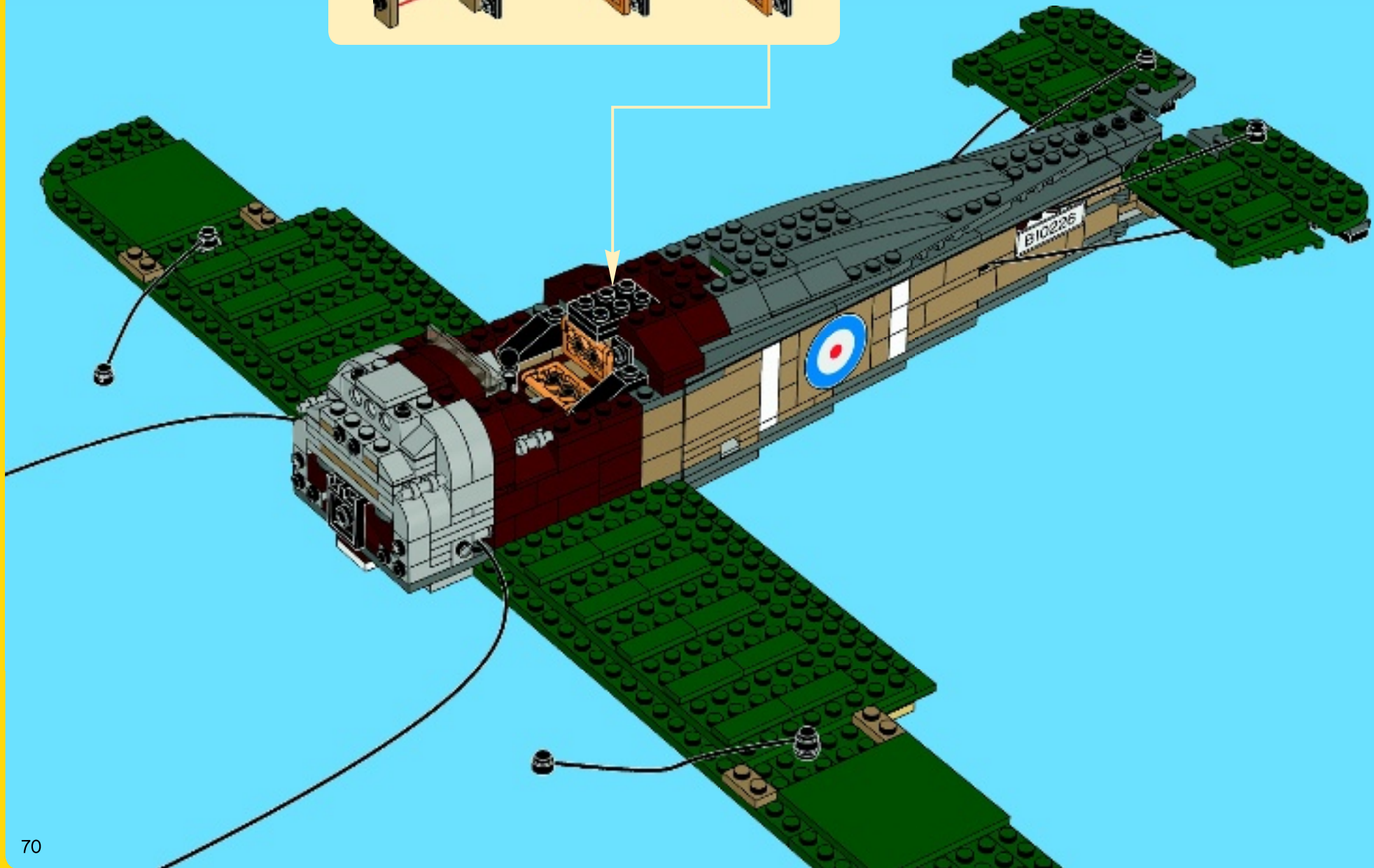
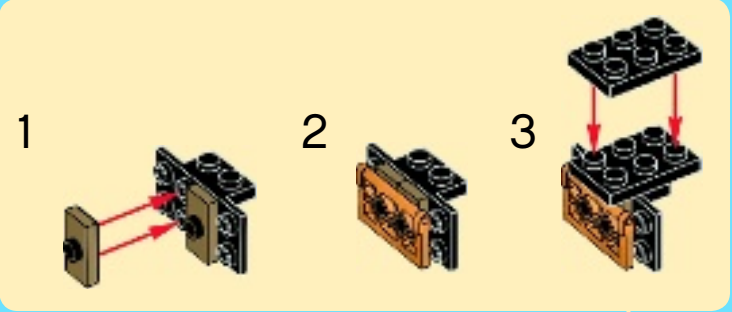

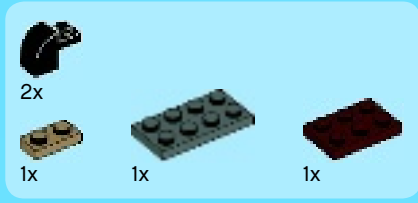

49

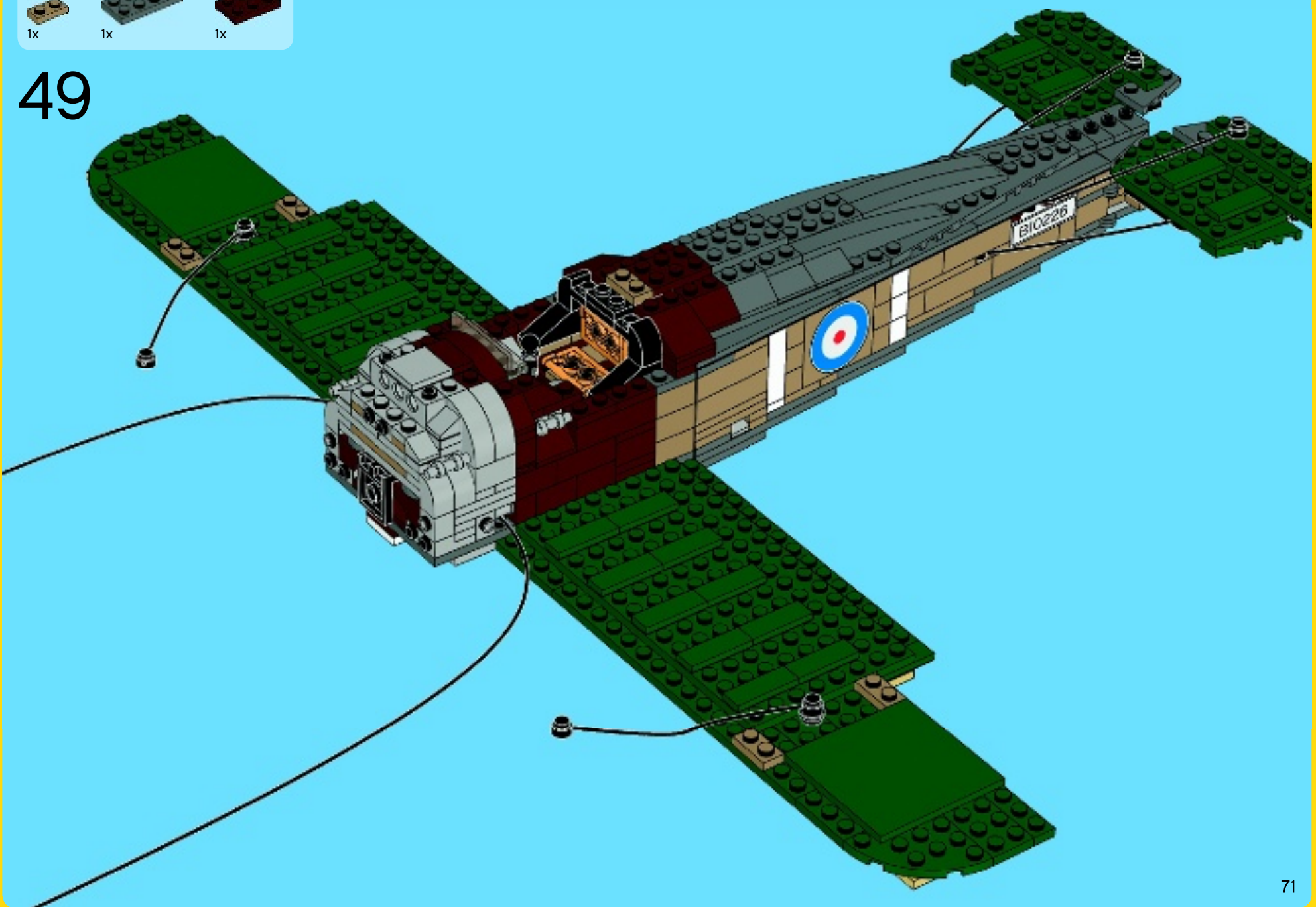



50

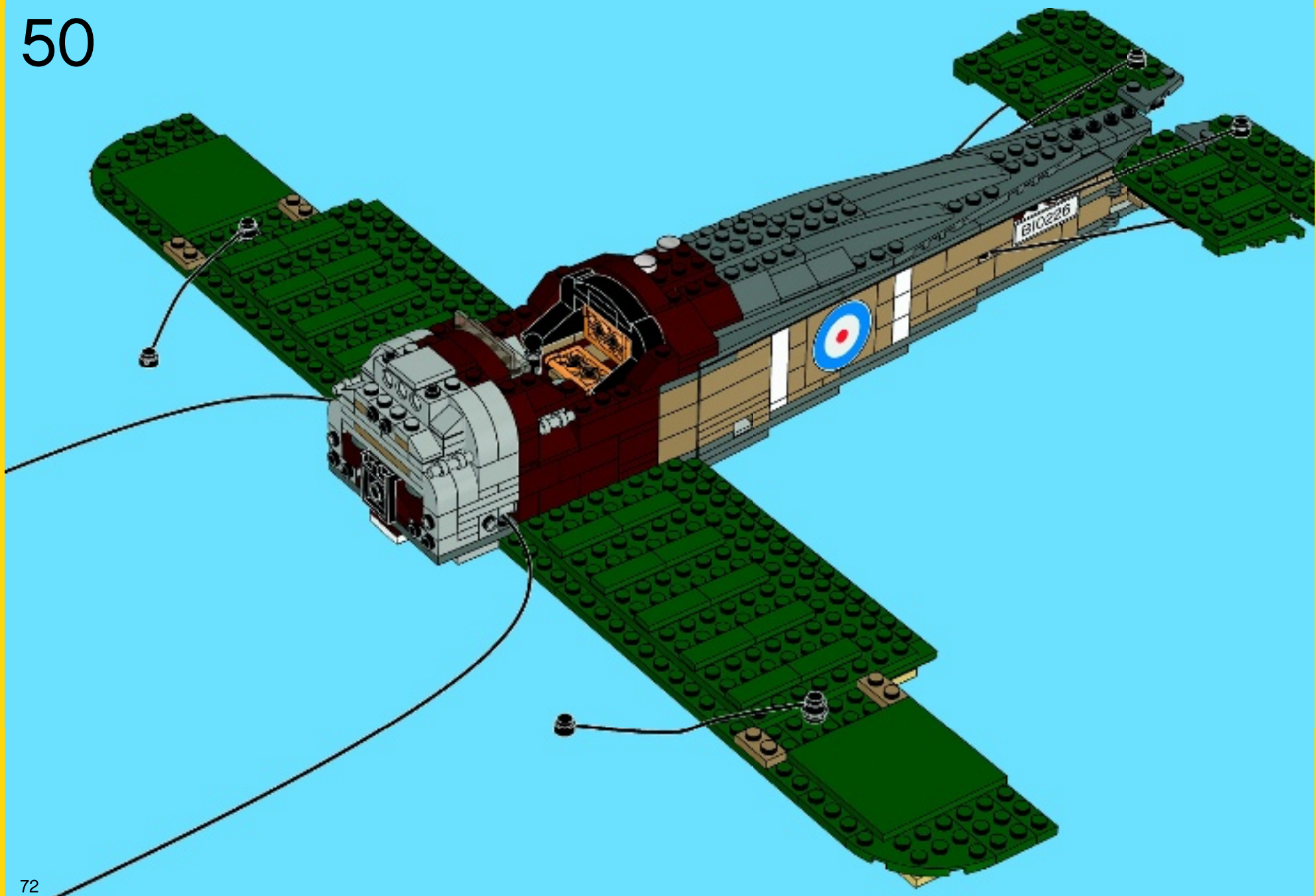

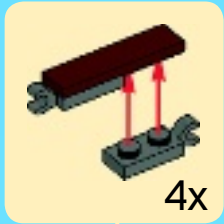

51

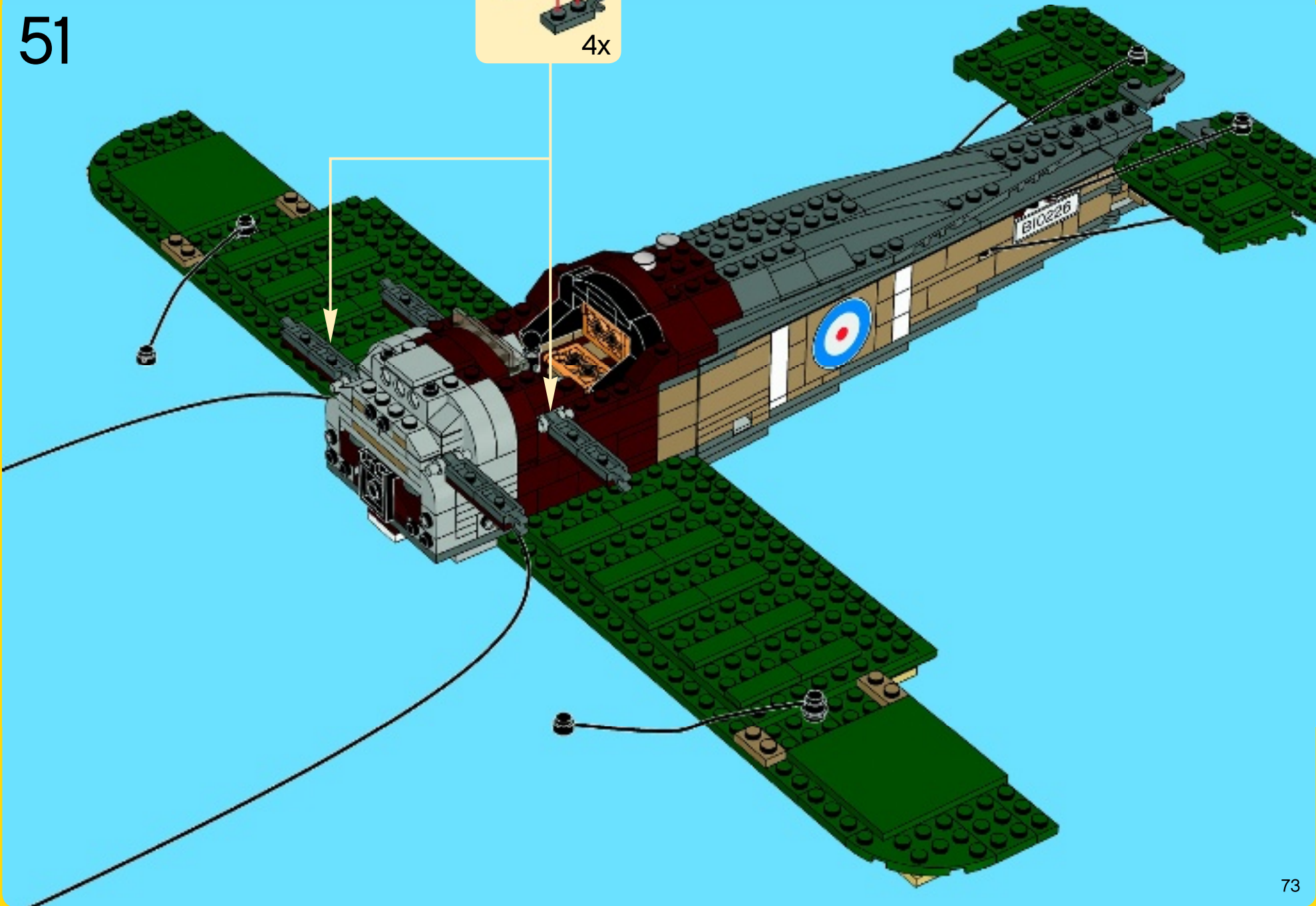

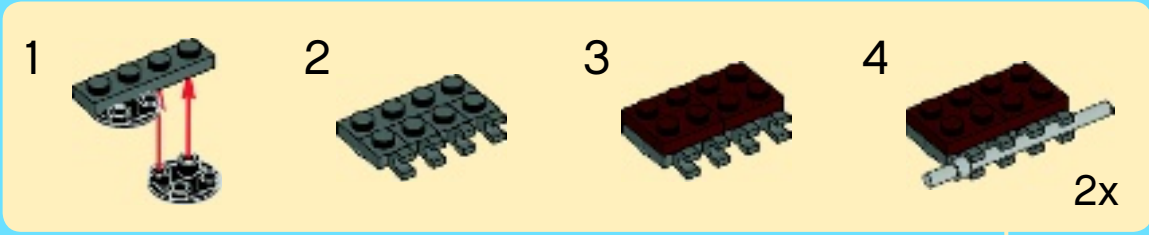
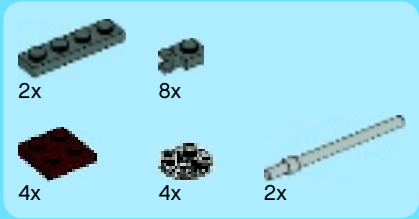

52

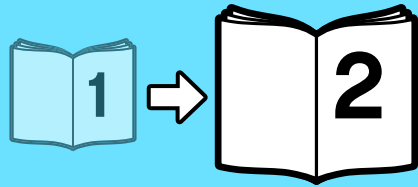
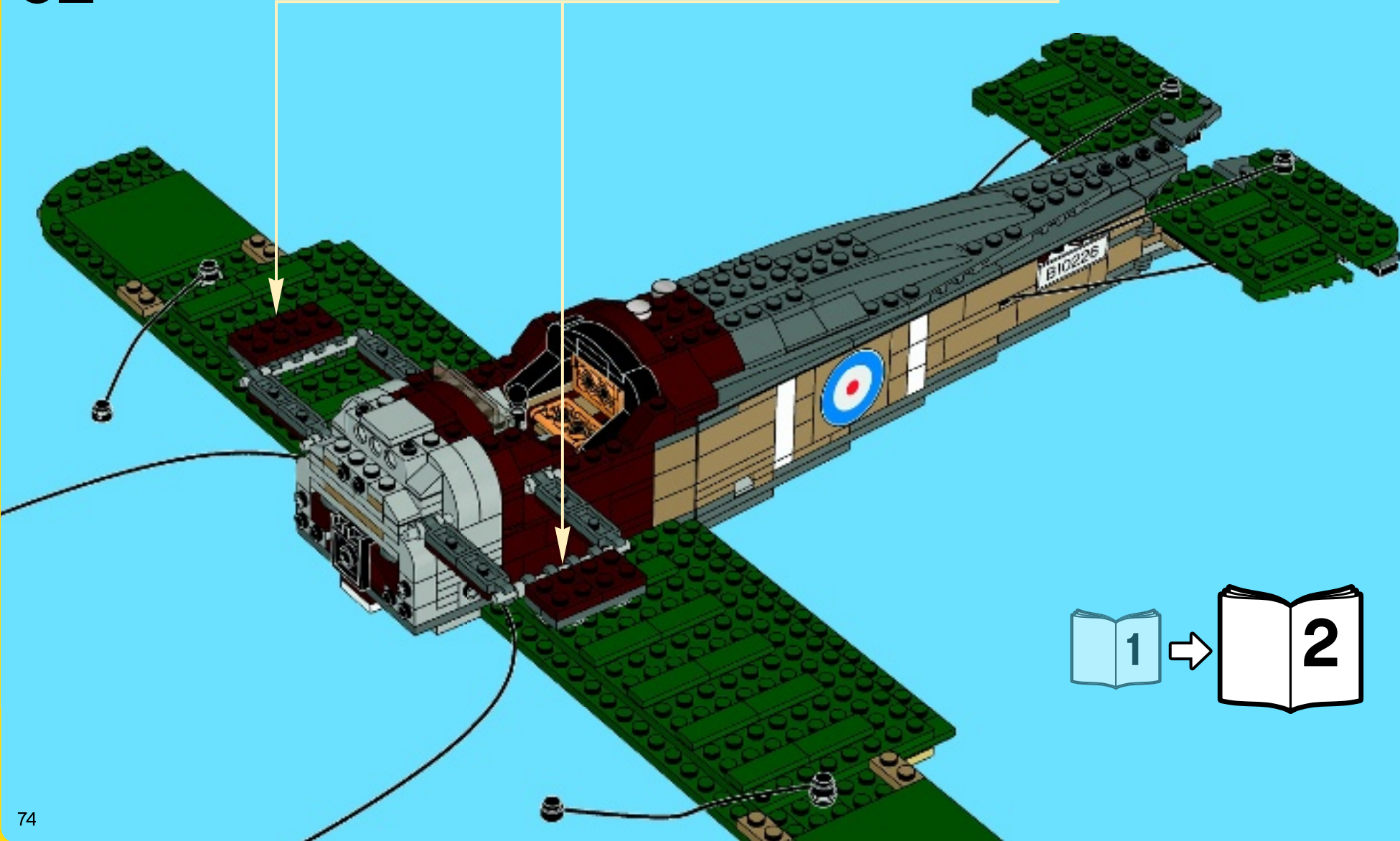



VIP Program Programme VIP



Earn VIP Points every time you shop directly with us and enjoy valuable rewards

Gagnez des points VIP à chaque achat et profitez de Formidables avantages



Earn 100 VIP Points and get a reward off your next purchase!

Gagnez 100 points VIP et bénéficiez d'une réduction sur votre prochain achat !

Access exclusive LEGO® sets just for VIPs

Accédez aux ensembles LEGO® exclusifs réservés aux membres VIP



VIP.LEGO.com





LEGO club

FREE! GRATIS! GRATUIT!

www.LEGOclub.com

LEGO Club Magazine

LEGO Club Email

YES! I want to join the LEGO® Club FREE! **OUI!** Je veux m'abonner au LEGO® Club GRATUITEMENT!
Ja! Ich möchte Mitglied im kostenlosen LEGO® Club werden. **Ja!** Ik wil graag GRATIS lid worden van de LEGO® Club.
Ja! Jeg ønsker å melde meg inn i LEGO® Club gratis! **Ja!** Jag vill gå med i LEGO® Club GRATIS!

First name · Prénom
 Vorname · Voornaam
 Fornavn · Förnamn

Last name · Nom de famille
 Name · Achternaam
 Etternavn · Efternamn

Date of Birth · Date de naissance
 Geburtstag · Geboortedatum
 Fødselsdato · Födelsedatum

Boy · Garçon · Junge ·
 Jongen Gutt · Pojke Girl · Fille Mädchen ·
 Meisje Jente · Flicka

Street · Adresse
 Straße, Hausnr.
 Straat, huisnr.
 Adress

City · Ville
 Ort · Woonplaats
 Poststed · Postort

State
 Prov.
 County

Zip/Postcode · Code
 Postal · PLZ · Postcode ·
 Postnummer

Country
 Pays
 Land

Email · Courriel
 E-Mail · E-post

- Fill in your email address and we will send you a membership confirmation and monthly email newsletters. If you do not wish to receive the newsletters please tick here. Remplis ton adresse e-mail et nous t'enversons une confirmation d'adhésion ainsi que le bulletin e-mail mensuel. Si tu ne désires pas recevoir le bulletin, coche cette case. Vül je e-mailadres in en we sturen je een bevestiging van je lidmaatschap en maandelijks e-mail nieuwsbrieven. Als je geen e-mail wilt ontvangen, kruis dan dit vakje aan.
- Ich möchte per E-Mail den monatlichen LEGO Club Newsletter erhalten. Ønsker du at vi skal sende en liten hilsen til barnet ditt for å bekrefte medlemskapet, ber vi deg krysse av i feltet, samt oppgi e-postadressen som hilsenen skal sendes til. Om du vill att vi ska skicka en bekräftelse på ditt barns medlemskap, ber vi dig sätta ett kryss i rutan och skriva den e-post adress som bekräftelsen ska skickas till.
- If you do not wish to receive additional mailings from the LEGO Club please tick here. Si tu ne désires pas recevoir de courrier supplémentaire du Club LEGO, coche cette case. Als je geen verdere post van de LEGO Club wilt ontvangen, kruis dan dit vakje aan.
- Dersom du ønsker å motta annen informasjon fra LEGO Gruppen, setter du et kryss her.

Mail to: / Poster à: LEGO® Club
 P.O. Box 1157
 Enfield, CT USA
 06083-1157

Per Post an: LEGO® Club
 Postfach 14 15
 D-36243 Niederaula

Send til: LEGO® Club Norge
 Postboks 58
 1314 Vøyenenga

Mail to: LEGO® Club
 33 Bath Road
 Slough SL1 3UF
 United Kingdom

Stuur op naar: LEGO® Club
 Postbus 40250
 3504 AB Utrecht

Skickas till: LEGO® Club Sverige
 Ubox 841
 202 29 Malmö

Poster à: LEGO® Club
 21 rue de la banque
 75 002 PARIS
 FRANCE

The English language version of the magazine can only be mailed to addresses in the US, Canada, the UK, and Republic of Ireland. Club membership is valid for two years and includes free copies of the LEGO Club Magazine and e-mail newsletters. In the US and Canada please allow up to 6 weeks for delivery of your first magazine. In the UK and Republic of Ireland please allow six to 14 weeks for delivery of your first magazine. By signing this form you consent the LEGO Club to use your child's data for LEGO mailings. The data will only be used for LEGO mailings and will not be sold, rented or otherwise disclosed to any company outside the LEGO Company except for disclosure to companies acting as our agents to help us provide services requested by the child. This coupon is valid for one free membership per person, group or organization. Photocopied coupons are accepted. La version française du magazine peut être postée uniquement au Canada. L'abonnement est valide pour 2 ans et inclut des exemplaires gratuits du Magazine LEGO. Aux E-U et au Canada, allouer 6 semaines pour la livraison initiale. En remplissant ce formulaire, vous consentez à ce que LEGO utilise les informations de votre enfant pour des envois postaux de LEGO. L'information sera utilisée uniquement pour des envois postaux par LEGO et ne sera en aucun cas, vendue, louée, échangée ou divulguée à d'autres compagnies autres que la compagnie LEGO, à l'exception des compagnies affiliées qui nous procurent des services auxquels l'enfant en a fait la demande. Formulaires photocopiés acceptés. Mit der folgenden Unterschrift erkläre ich, für mein Kind den Beitritt als Mitglied zum kostenlosen LEGO Club, der von der LEGO GmbH, D-85627 Grasbrunn, betrieben wird. Die Mitgliedschaft beinhaltet die Zusendung des LEGO Club Magazines und kann beiderseits jederzeit beendet werden. Mit der Mitgliedschaft im LEGO Club sind keinerlei Verpflichtungen verbunden. Das deutschsprachige LEGO Club Magazin wird nur an Adressen in Deutschland, Österreich und der Schweiz versendet. Eine Anmeldebestätigung kann nur per E-Mail geschickt werden. Das Magazin erscheint fünfmal jährlich. Daher kann die Zustellung des ersten Hefes bis zu drei Monate dauern. Die Mitgliedschaft ist beidseitig jederzeit kündbar, ohne dass Ihnen Kosten entstehen. Sie können der werblichen Nutzung Ihrer Daten jederzeit widersprechen. Kündigung und Widerspruch können Sie telefonisch erklären (00800 / 5346 5555, Anruf gebührenfrei, Kosten für Anrufe aus dem Mobilfunknetz können abweichen) oder an die LEGO GmbH senden. Het Nederlandse LEGO Club Magazine kan alleen worden gestuurd naar adressen in Nederland. Het lidmaatschap is 2 jaar geldig en geeft recht op toezending van het gratis LEGO Club Magazine en LEGO Club e-mails. Het eerste magazine zal binnen 12 tot 14 weken toegestuurd worden. Het lidmaatschap kan op ieder moment opgezegd worden en kan na 2 jaar gratis worden verlengd, tenzij LEGO met deze activiteit stopt. Uw gegevens worden uitsluitend gebruikt voor mailings van LEGO en zullen niet worden verkocht, verhuurd of op welke wijze dan ook verstrekt aan derden buiten de LEGO Groep, uitgezonderd de organisaties die namens ons optreden om de informatie te sturen waarvoor toestemming is verleend. Den norske utgaven av magasinet sendes kun til adresser i Norge. Medlemskap i klubben gjelder i 2 år og inkluderer gratisutgaver av LEGO Club Magazine. Pårign minimum opp til seks uker leveringstid for første magasin. Ved å undertegne dette skjemaet, gir du ditt samtykke til at LEGO Club kan bruke opplysningene om barnet ditt i LEGO forsendelser. Dataene vil utelukkende bli brukt i LEGO forsendelser og vil ikke bli solgt, utleid eller på annen måte gjøres tilgjengelig for selskaper utenfor LEGO gruppen, unntatt selskaper som er våre agenter og som hjelper oss å tilby tjenestene barnet etterspør. Dette skjemaet gjelder for ett gratis medlemskap per person, gruppe eller organisasjon. Den svenska versionen av tidingen kan endast skickas till adresser i Sverige. Club-medlemskapet är giltigt i 2 år och innefattar gratis exemplar av LEGO Club Magazine. Vänligen räkna med minimum 6 veckor för leverans av din första tiding. Genom att skicka in det här formuläret godkänner du att LEGO Club använder barnets uppgifter för LEGO utskick. Uppgifterna kommer bara att användas för LEGO utskick och kommer inte att säljas, hyras ut eller vidarebefordras till något företag som inte tillhör LEGO Gruppen, med undantag av företag som agerar som våra ombud för att tillhandahålla tjänster som barnet har begärt. Den här kupongen gäller för ett gratis medlemskap per person, gruppe eller organisation. En complétant ce bulletin d'adhésion, vous acceptez que LEGO Club utilise les données relatives à votre enfant pour l'envoi de courriers concernant LEGO. Ces données seront uniquement utilisées pour l'envoi d'information concernant LEGO et ne seront ni vendues, ni louées, ni utilisées par d'autres sociétés que le groupe LEGO, à l'exception des sociétés agissant pour le compte de LEGO en tant que sous-traitant de services divers. L'abonnement au LEGO Club est valable pour une période de 2 ans. Il inclut l'envoi par courrier du magazine LEGO Club et par email des newsletters. Un délai de 6 à 14 semaines est à prévoir pour la réception de votre premier magazine. Ce bulletin d'adhésion gratuit est valable pour l'inscription d'une seule personne. Les photocopies sont acceptées. ATTENTION! Le bulletin d'adhésion doit être rempli et signé par un parent ou un tuteur.

Parent's signature · Signature d'un parent ou d'un tuteur
 • Unterschrift Erziehungsberechtigter / Handtekening ouders
 • Foreldres/foresattes underskrift · Förälders /förmyndares underskrift

Date
 Datum
 Date

00800 5346 5555
 1-866-534-6258 · 1-877-518-5346

* Freephone. Mobile charges may apply. * Numéro sans frais. Des frais peuvent s'appliquer avec les téléphones cellulaires. * Gebührenfrei. Kosten für Anrufe aus Mobilfunknetzen können abweichen. * Gratis telefonnummer vanaf vaste lijn. * Det er et gratis nummer, når du ringer fra fasttelefon. * Det är gratis, när du ringer från en fast telefon.
 * Numéro sans frais. Des frais peuvent s'appliquer avec les téléphones portables.





10226



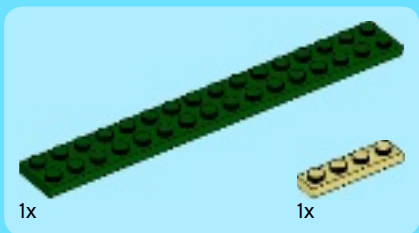
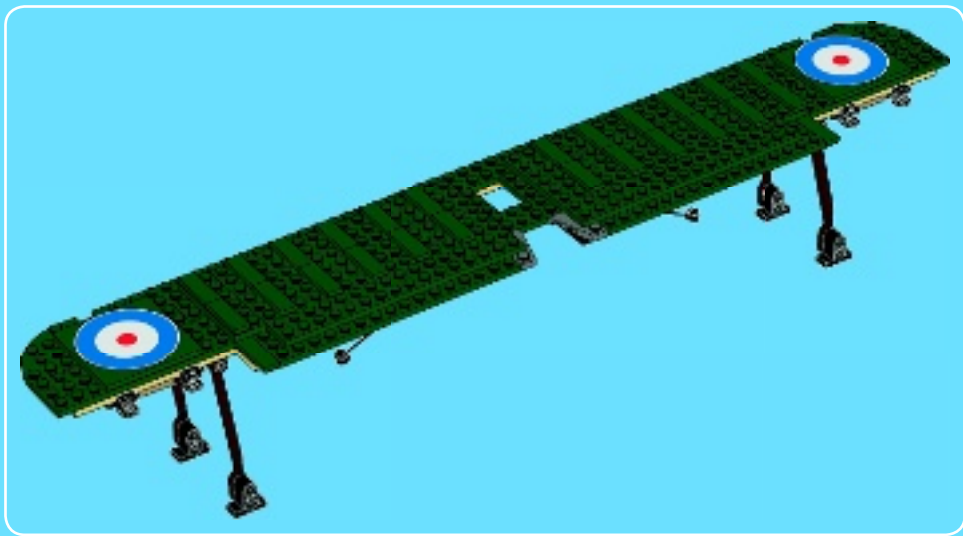

1

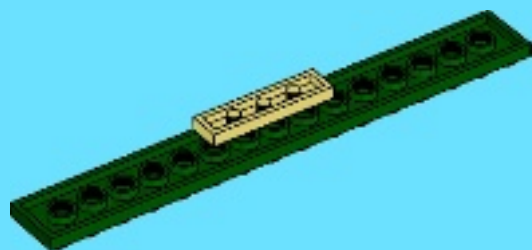

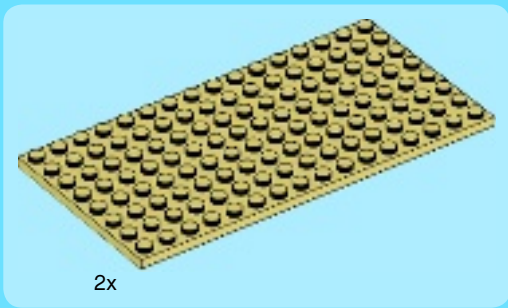

2

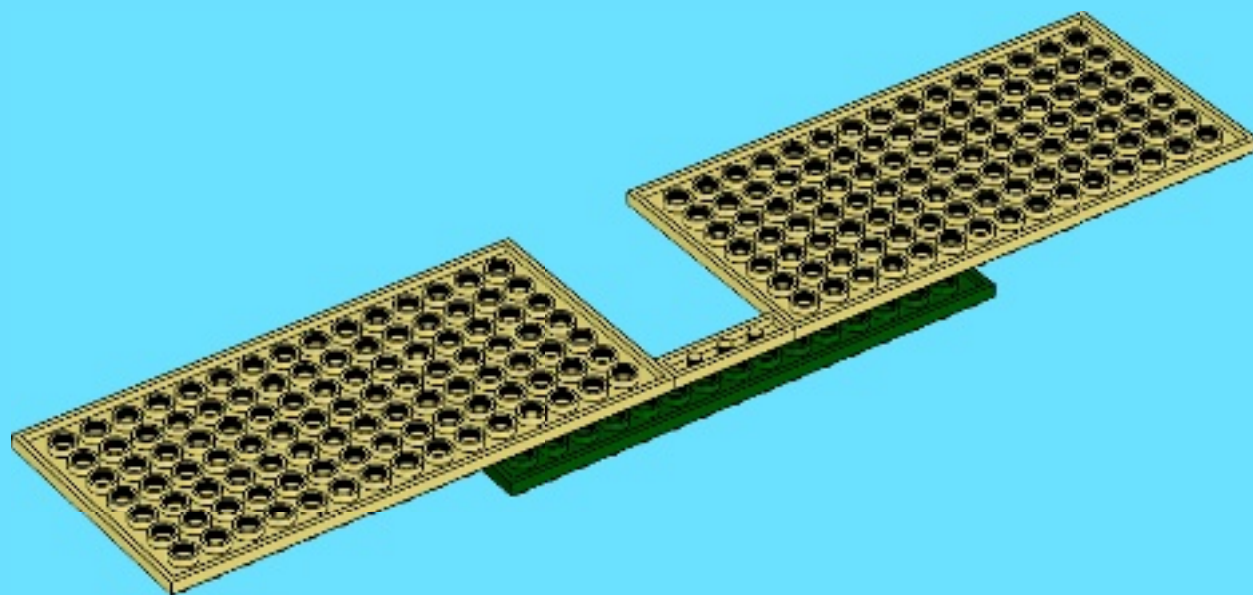

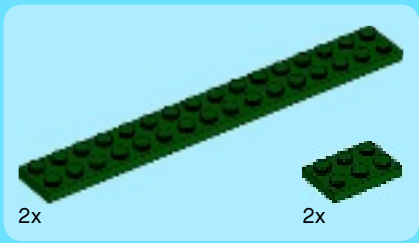

3

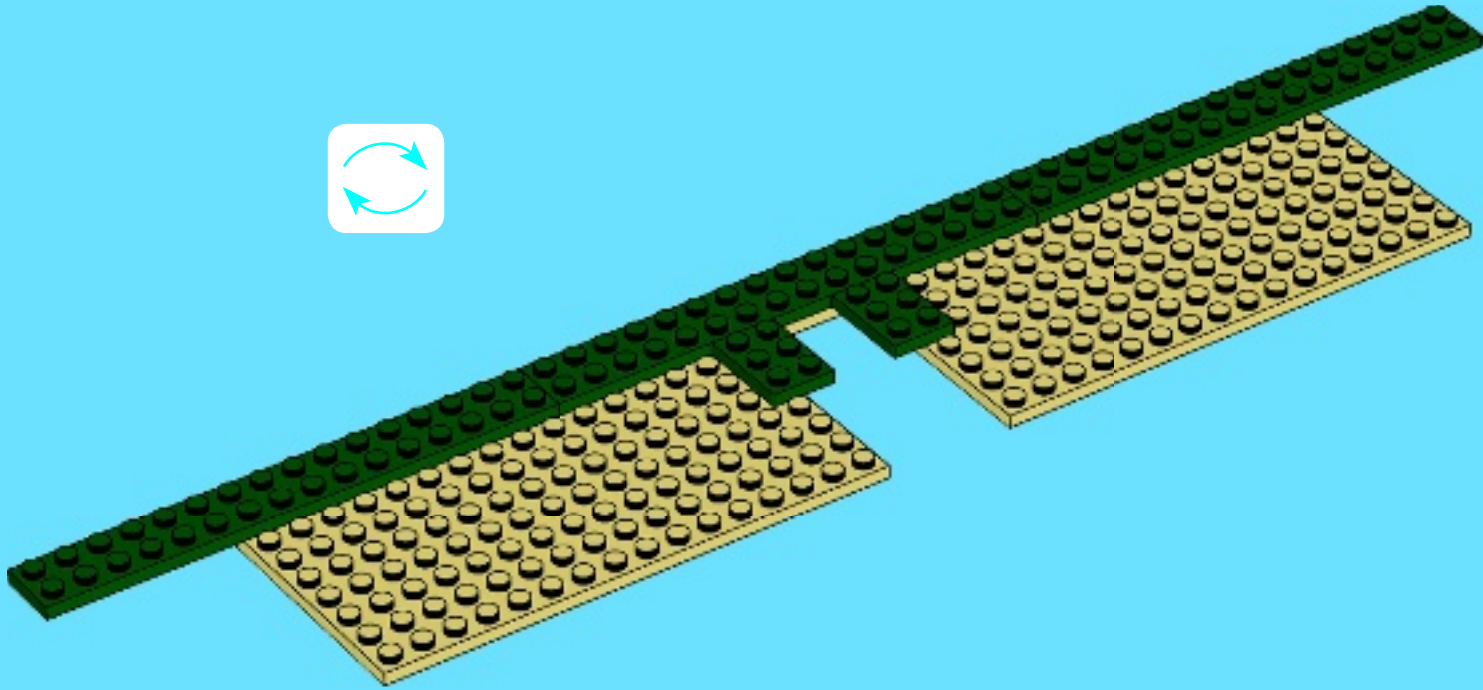

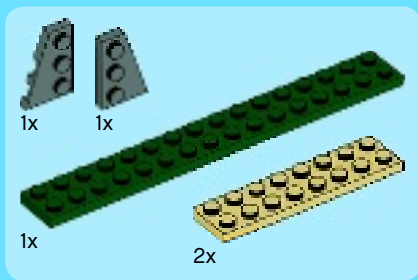

4

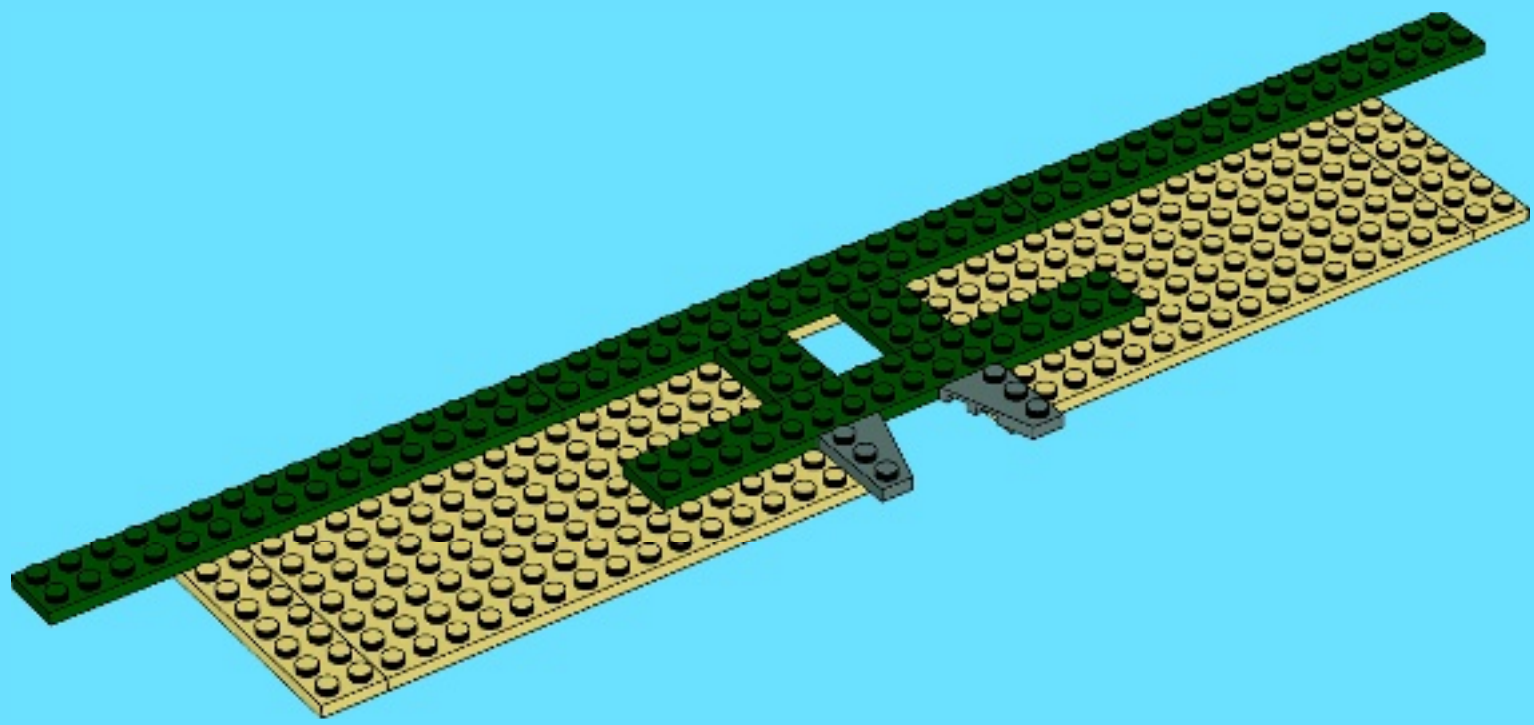

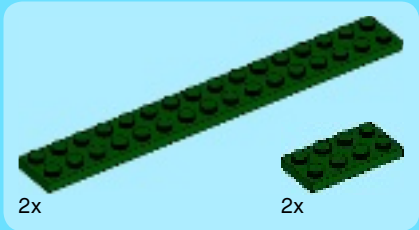

5

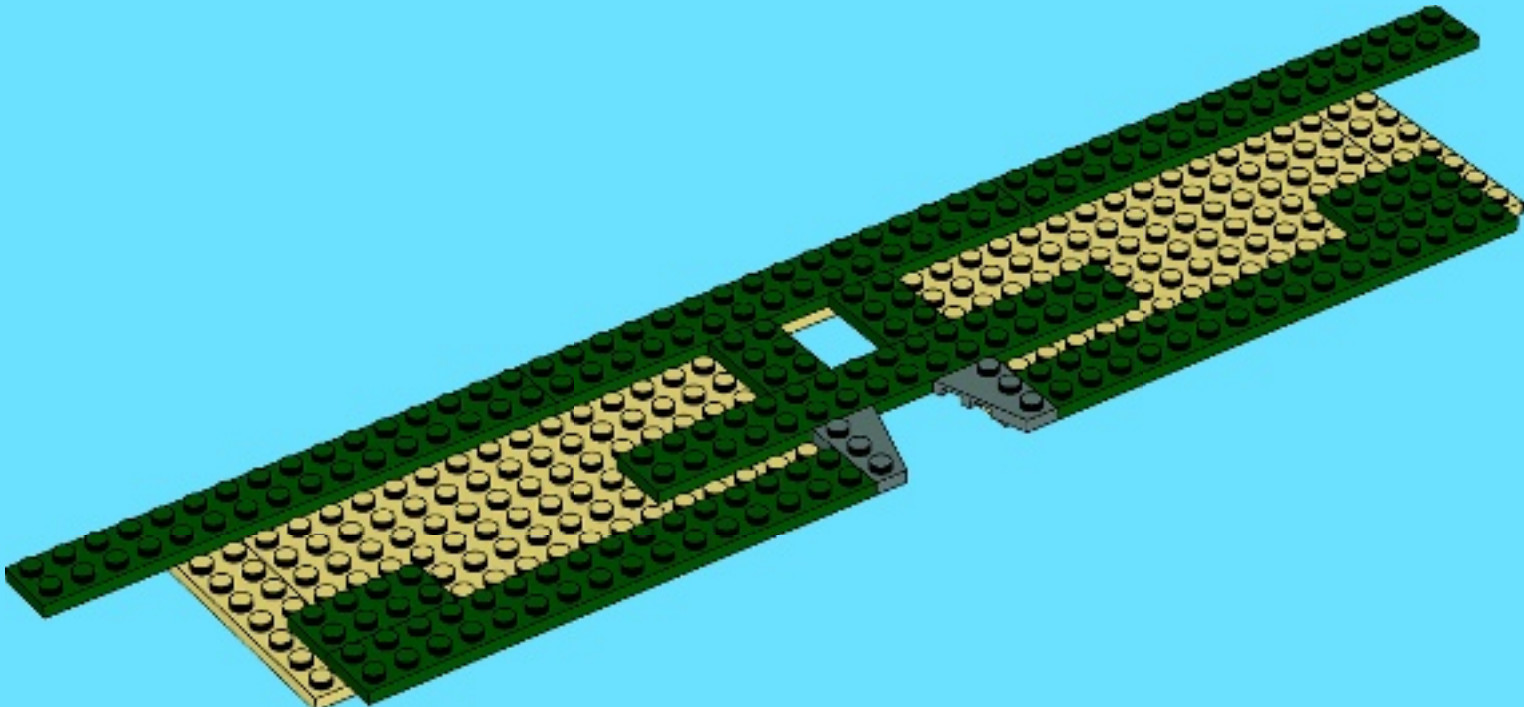



6

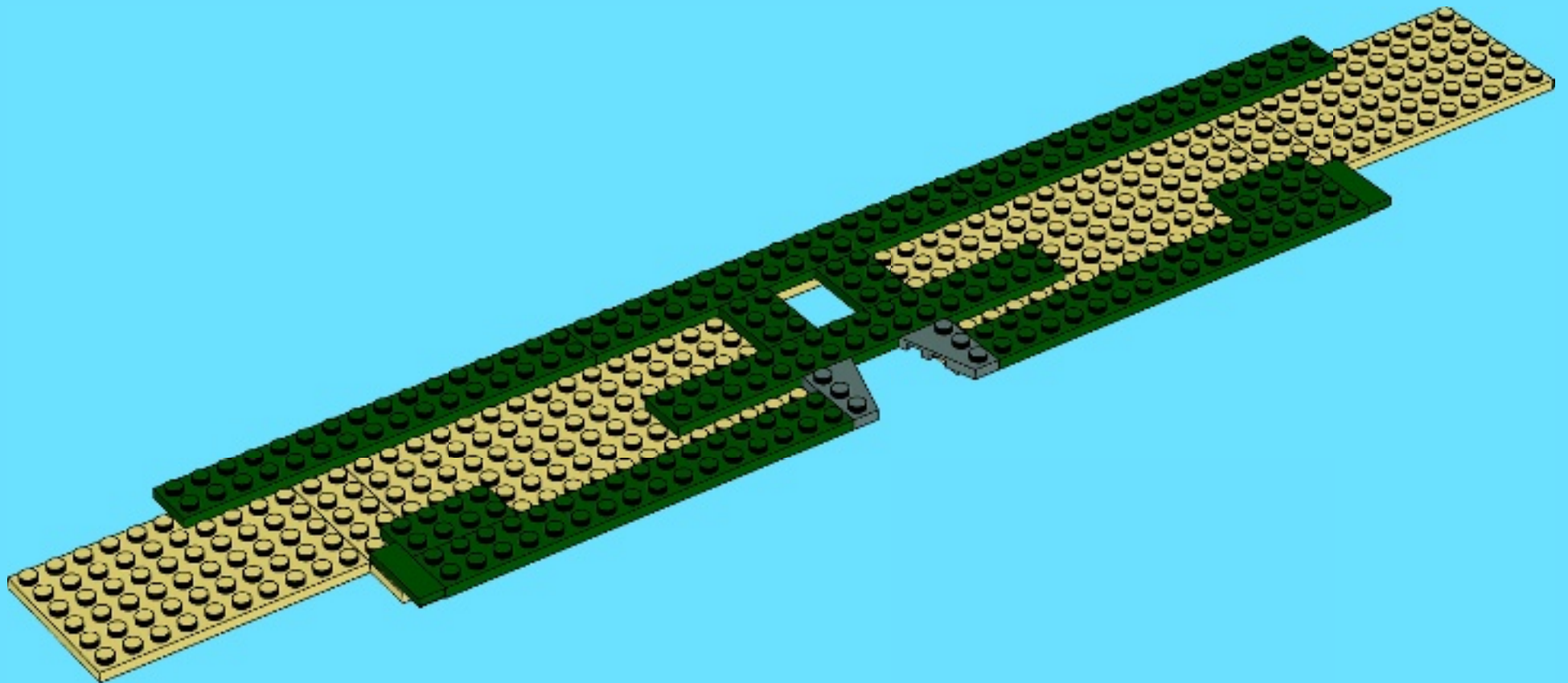

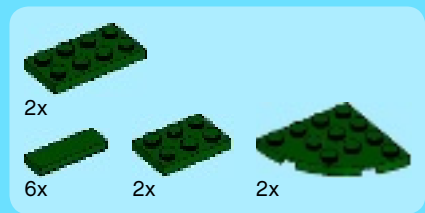

7

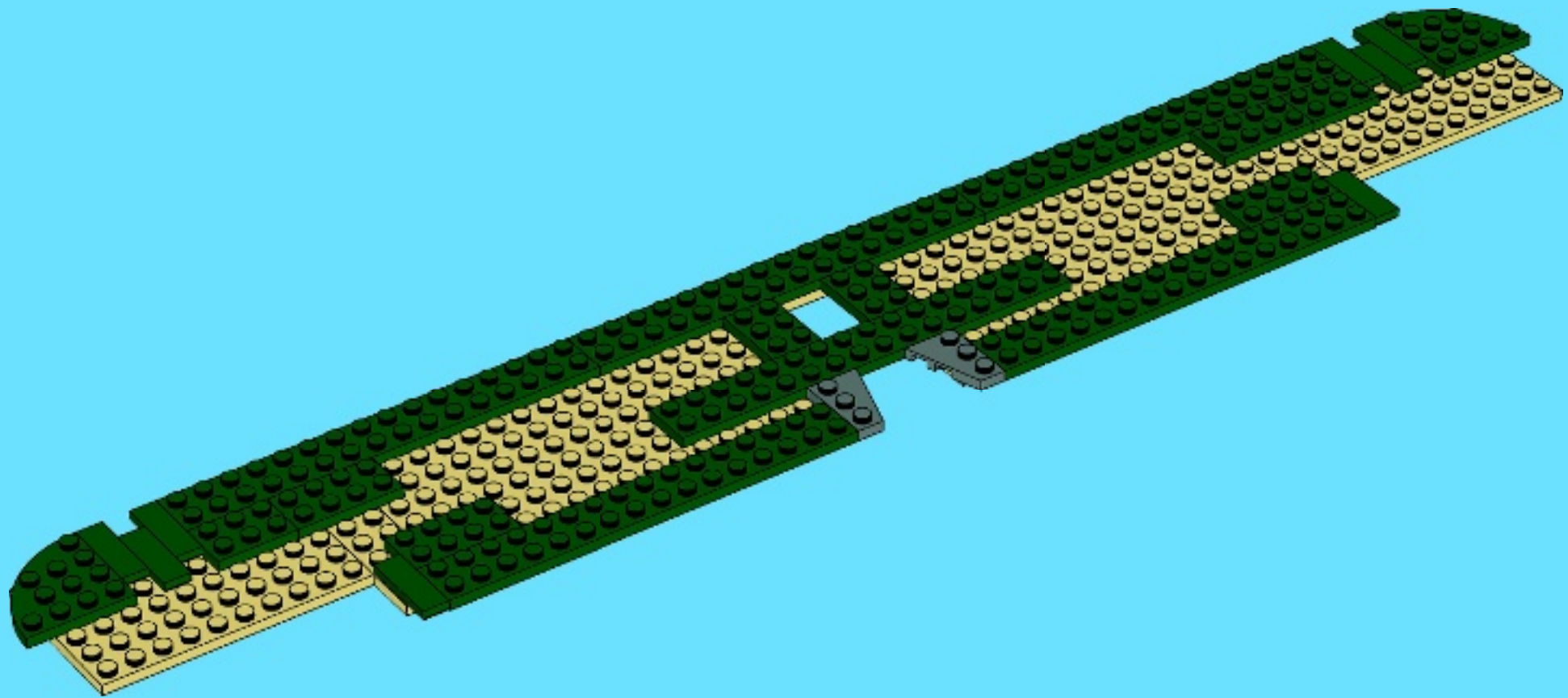

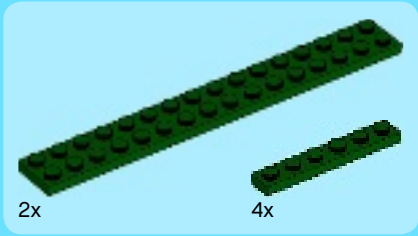

8

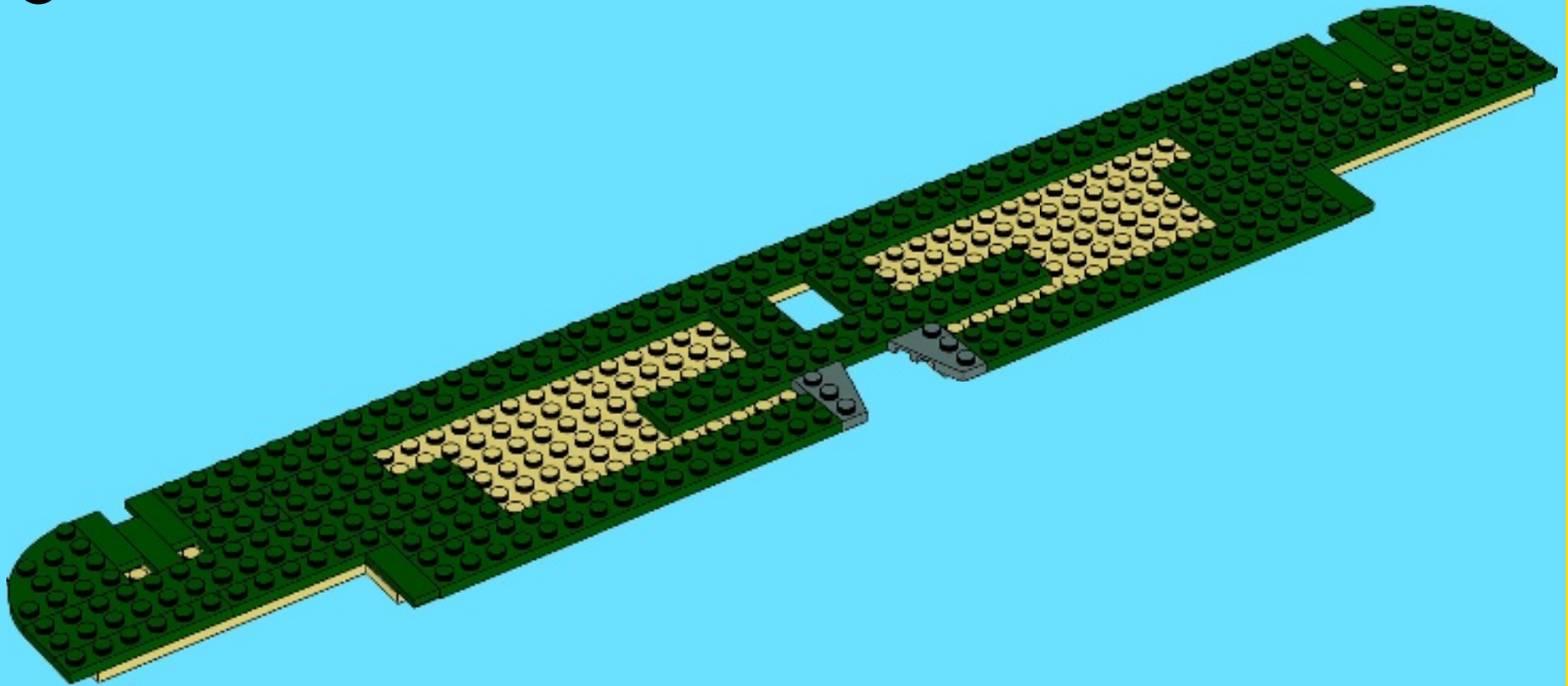

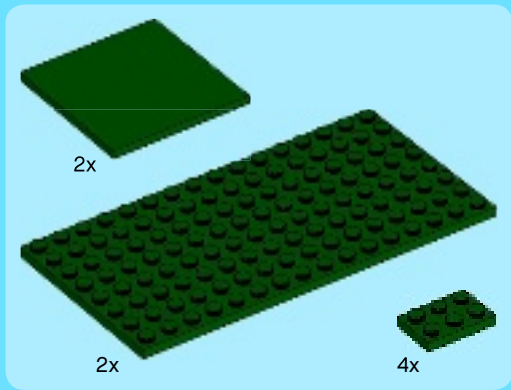

9

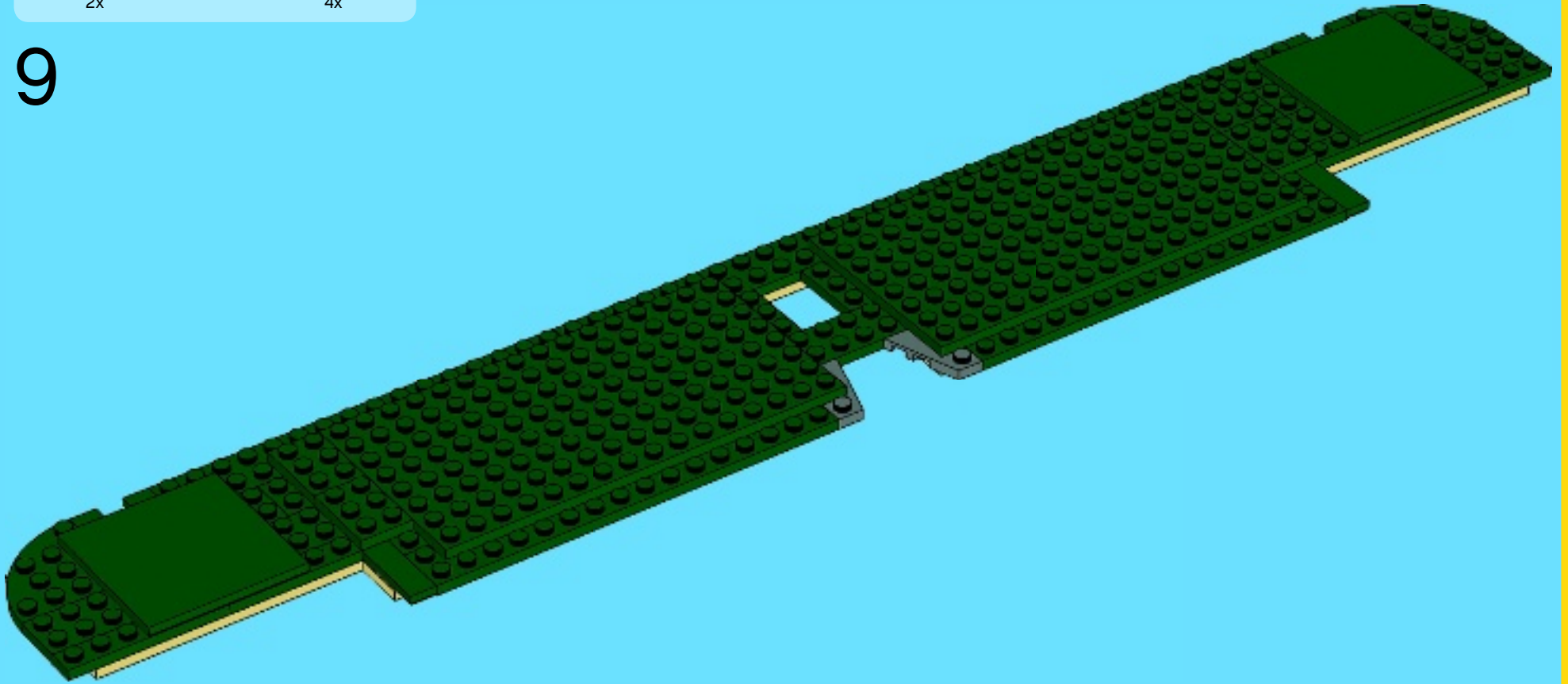



24x

10

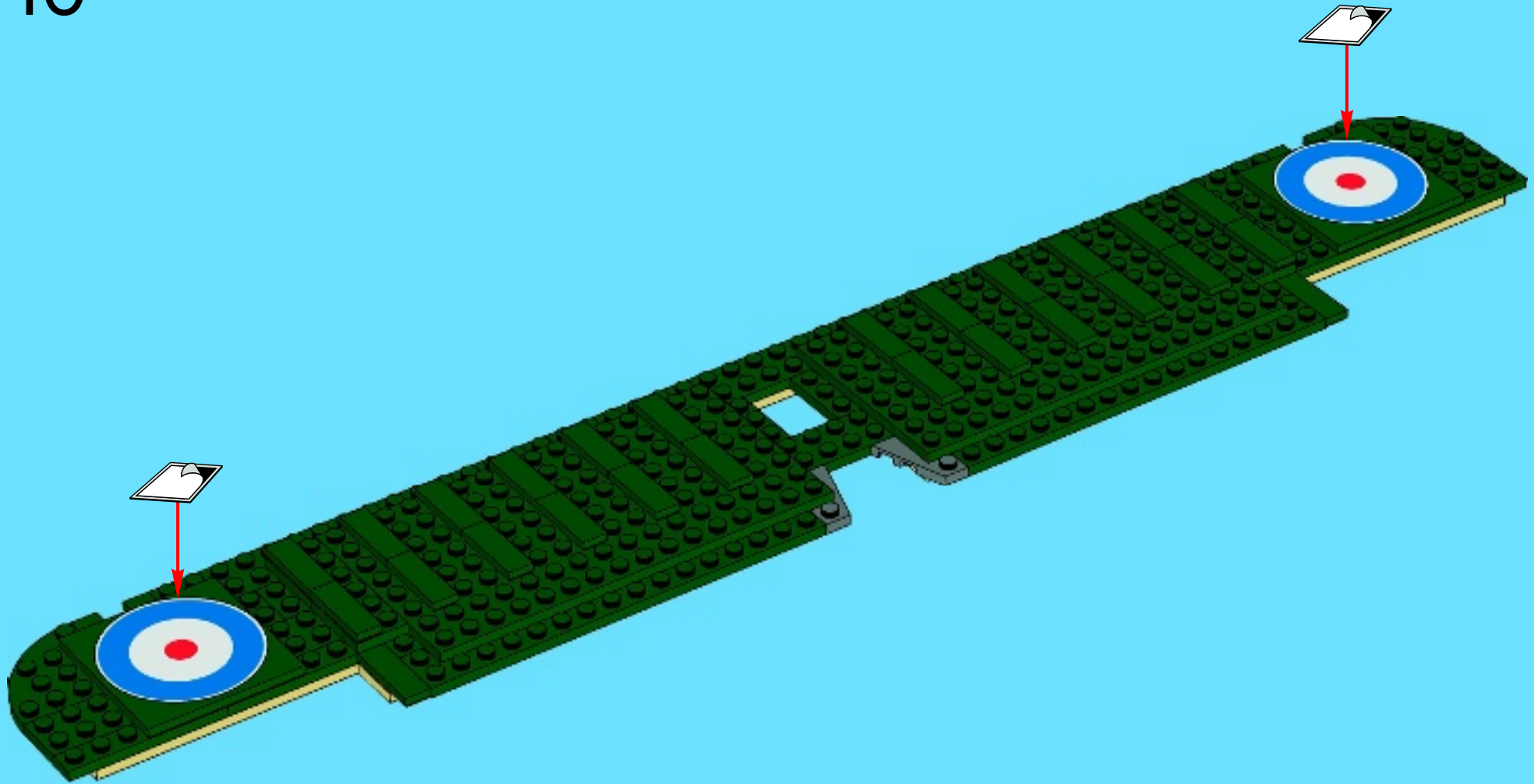

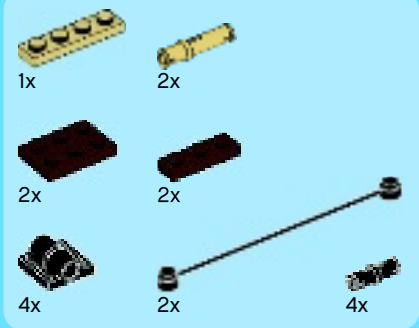

11

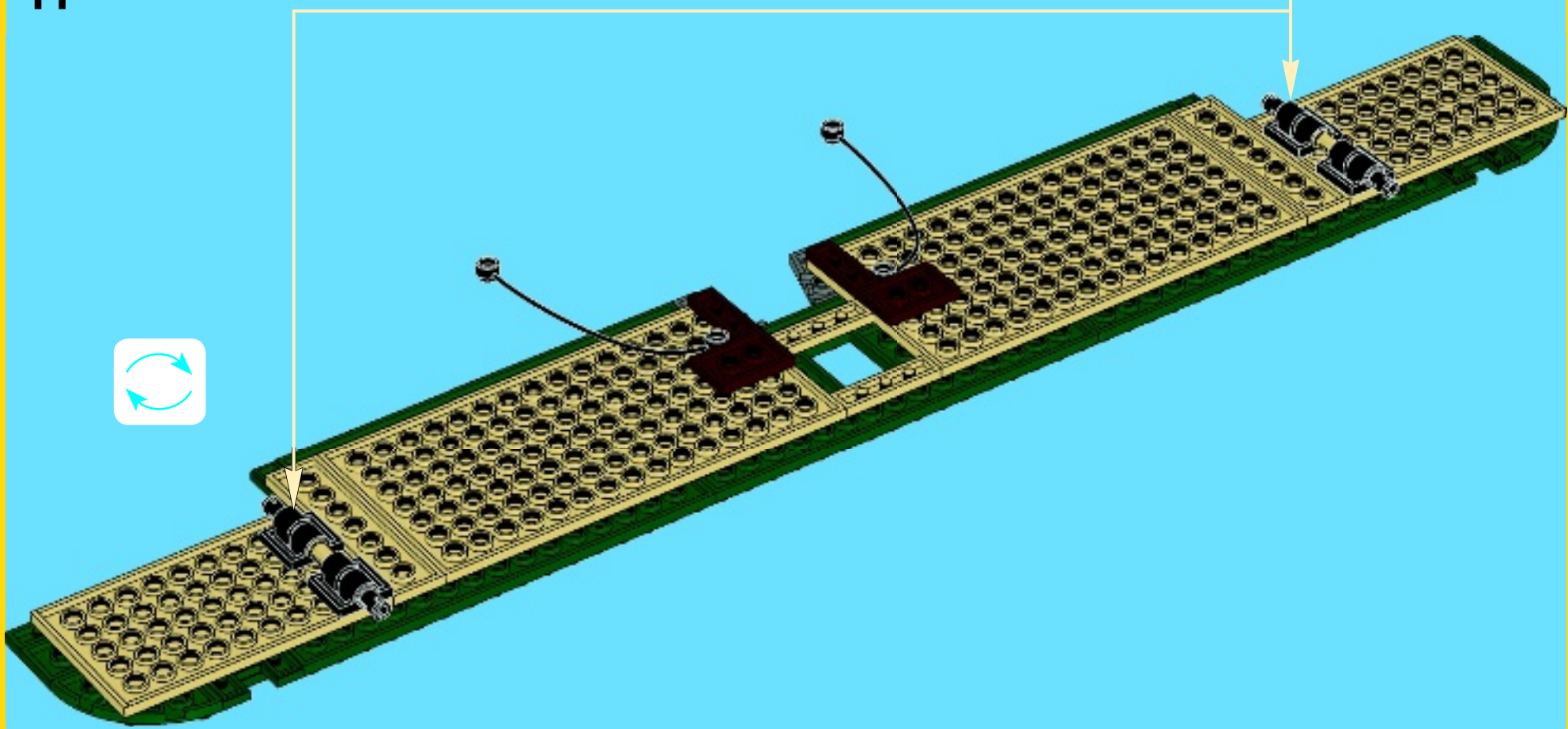

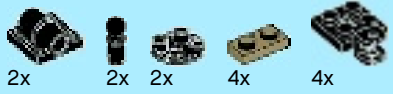

12

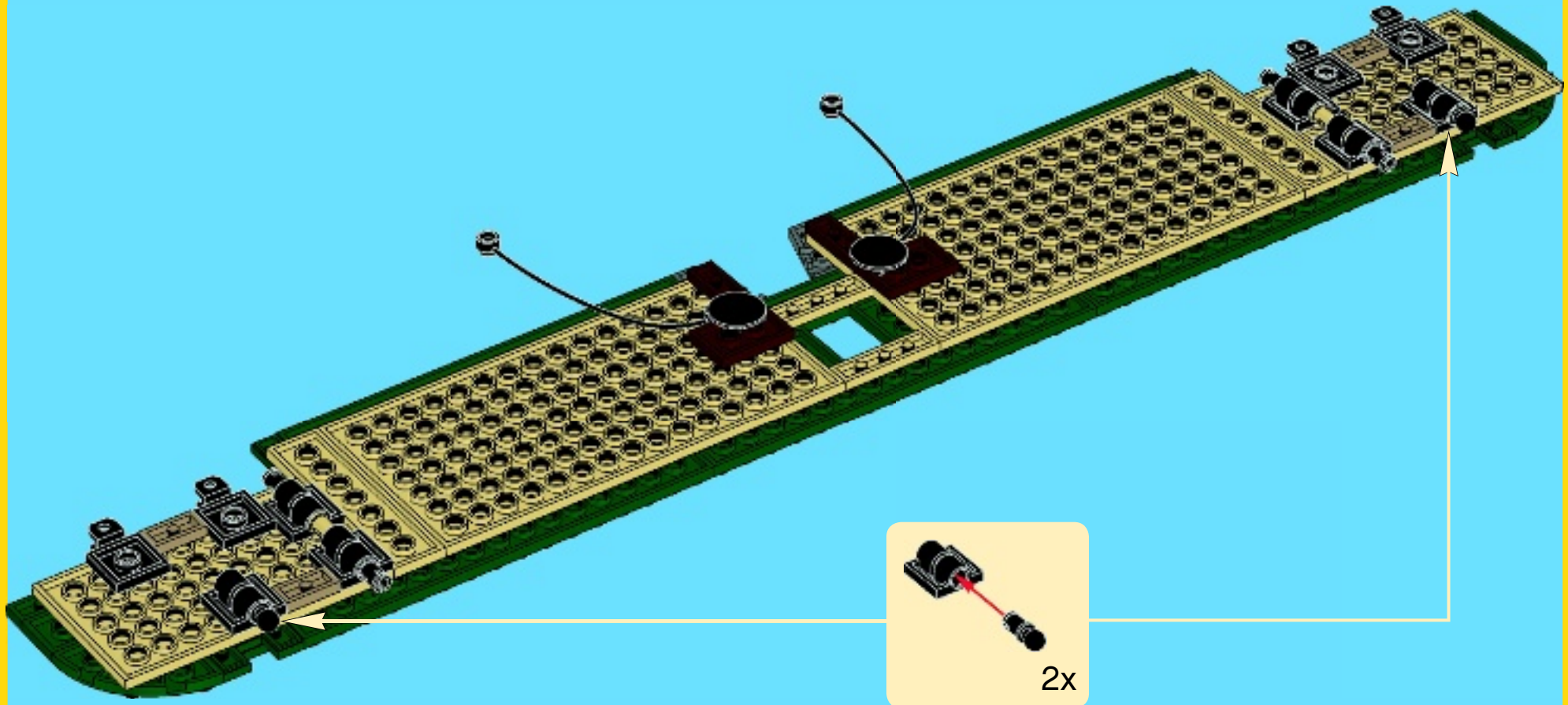

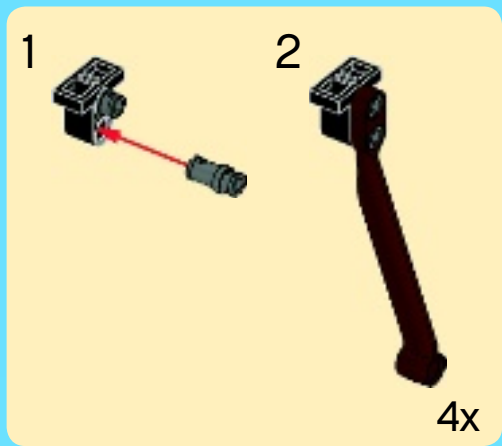
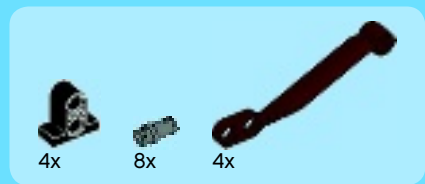

13

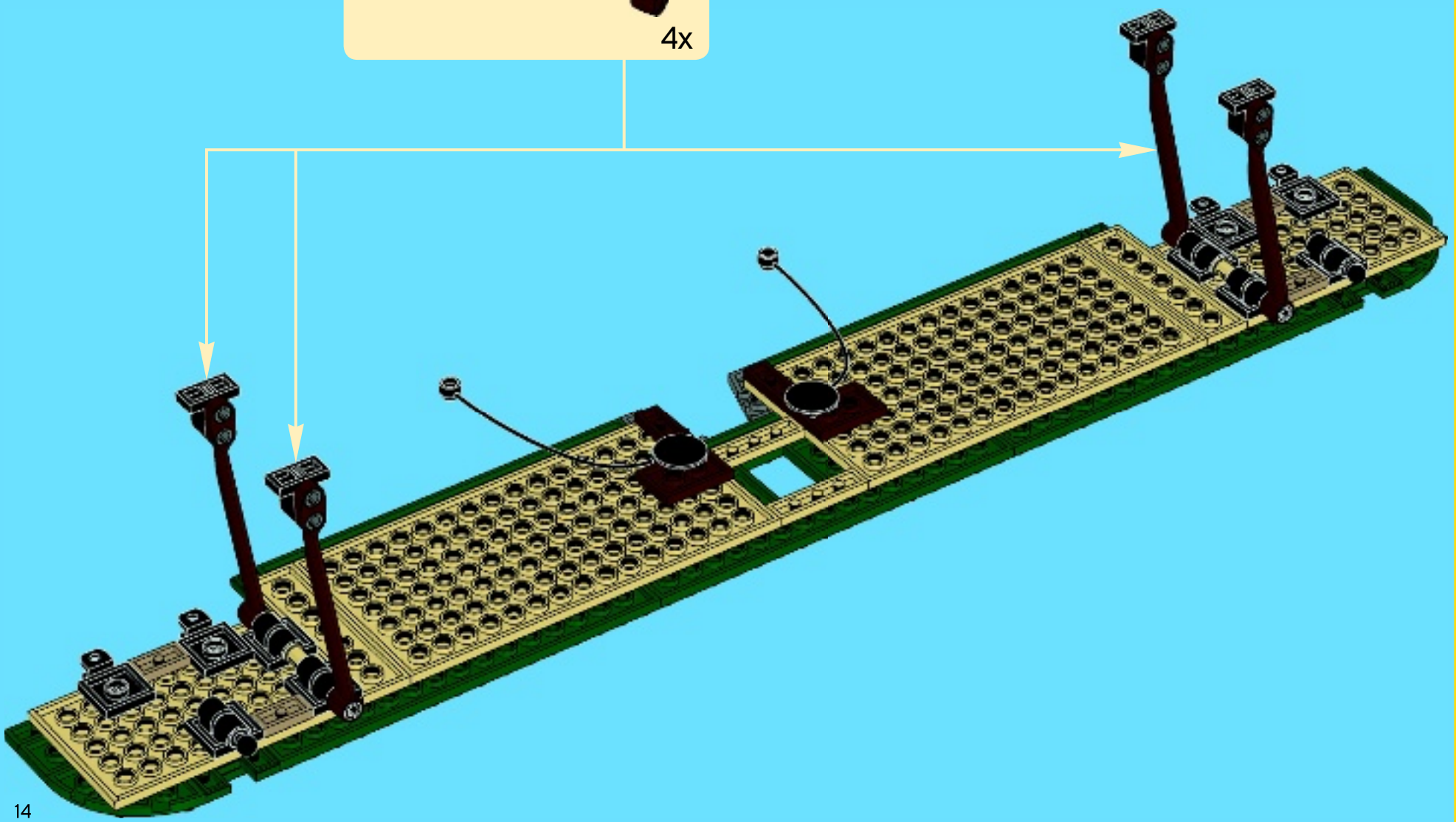

53

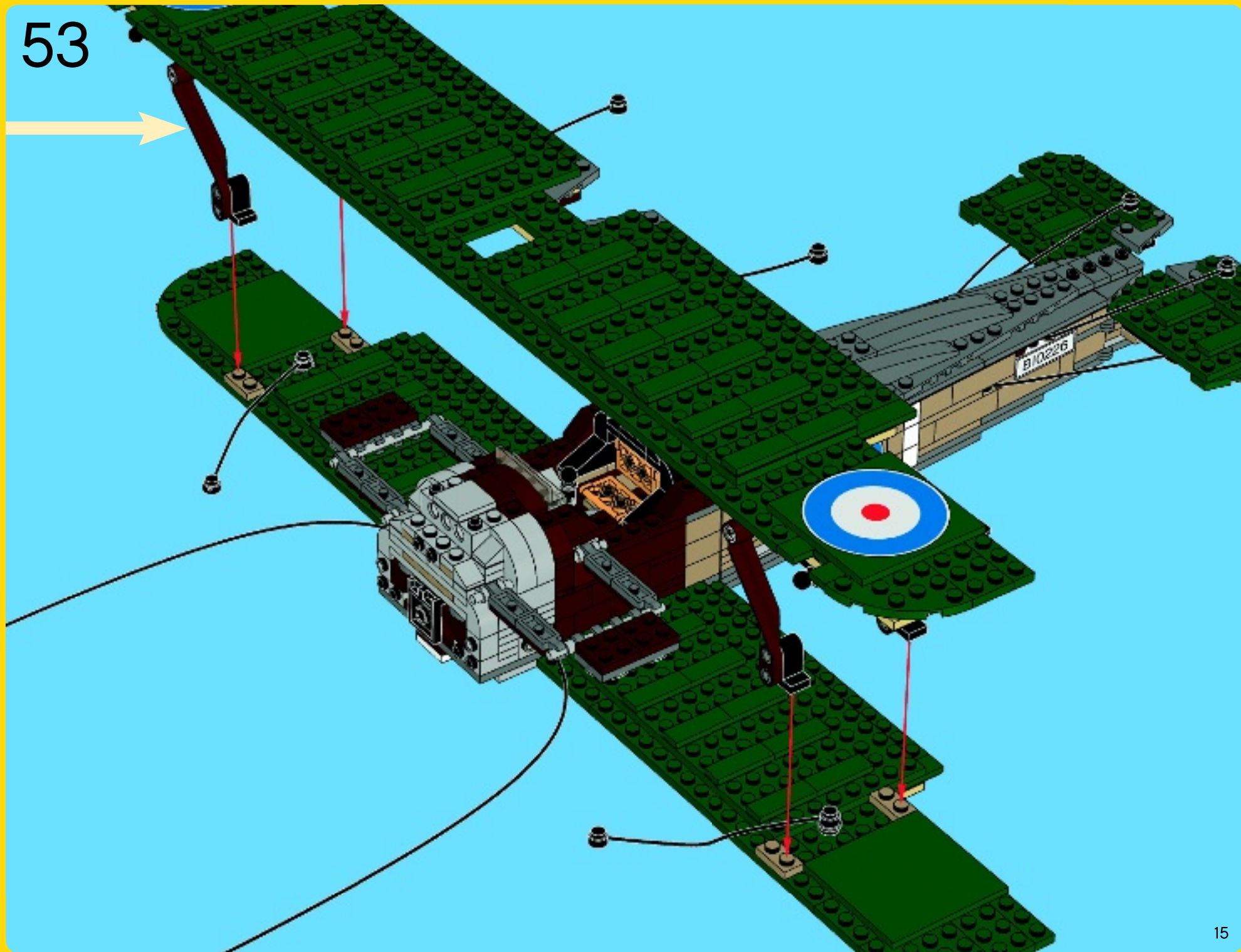

54

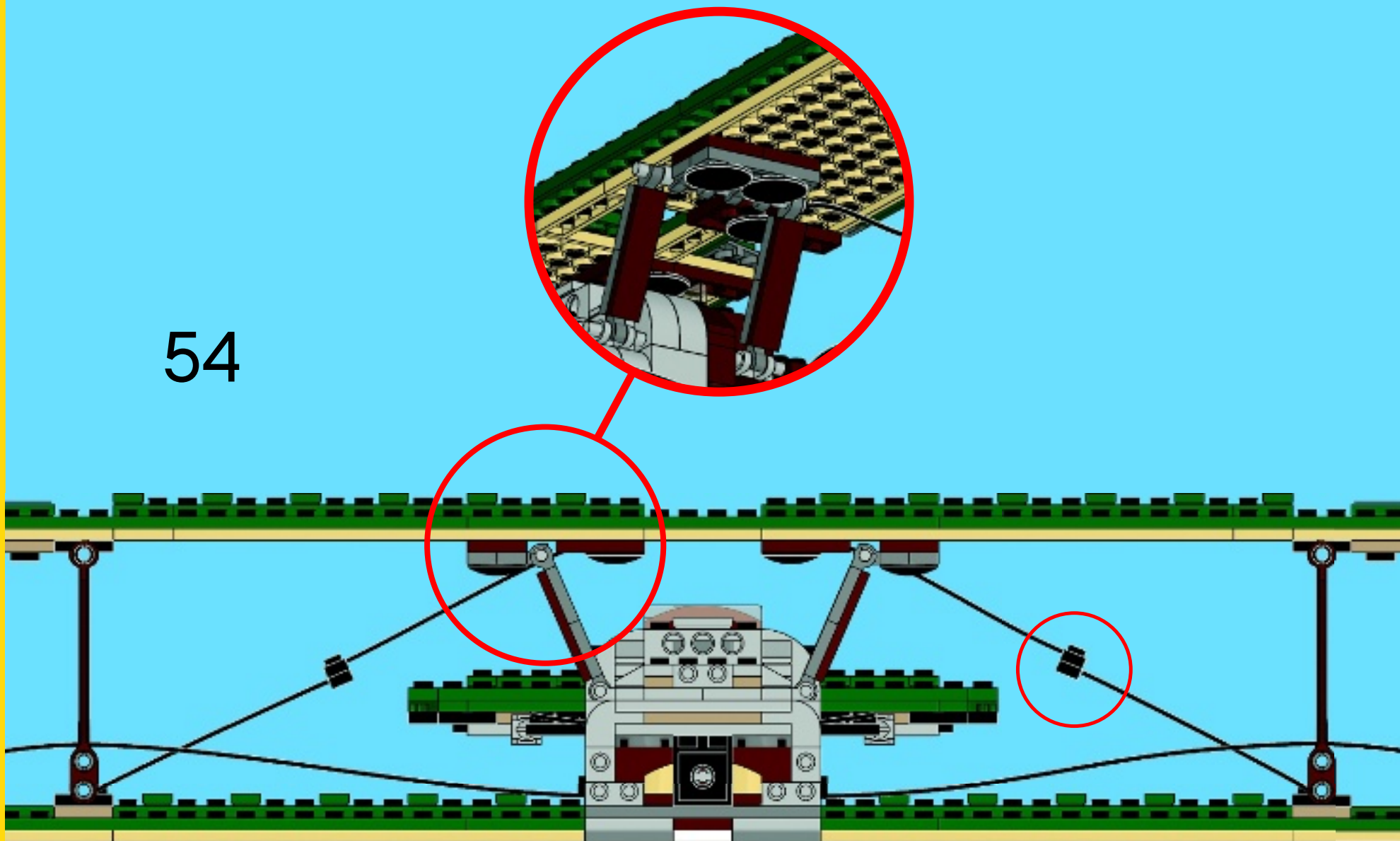

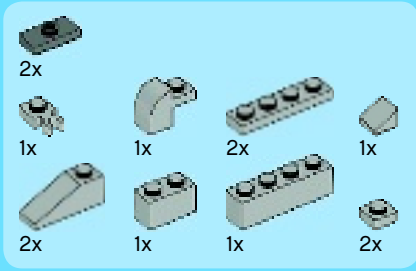

55

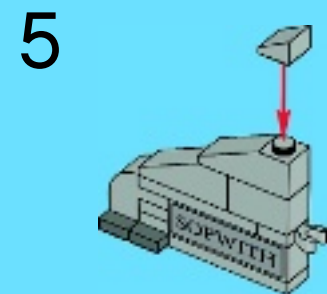
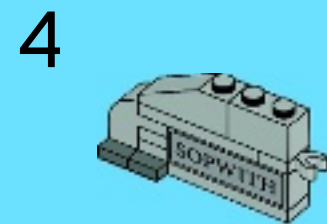
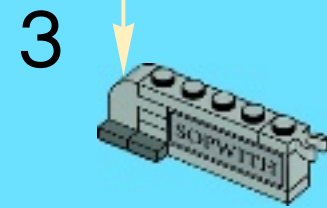
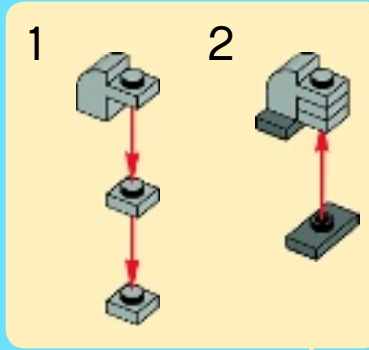
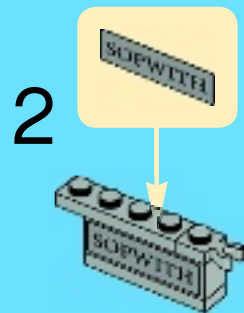
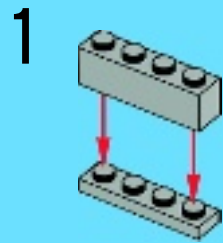

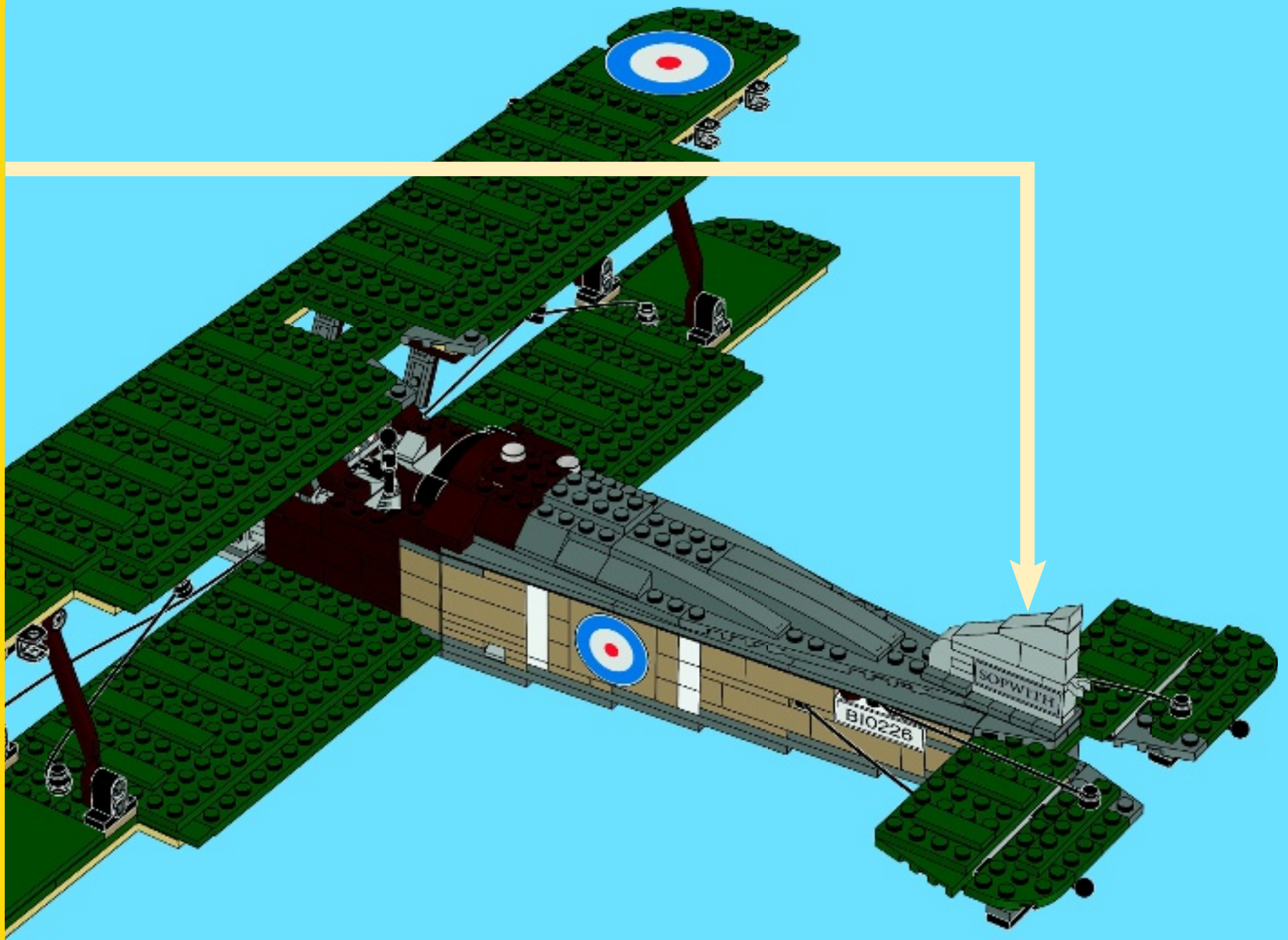

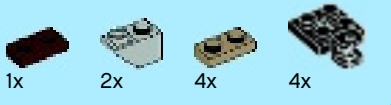

56

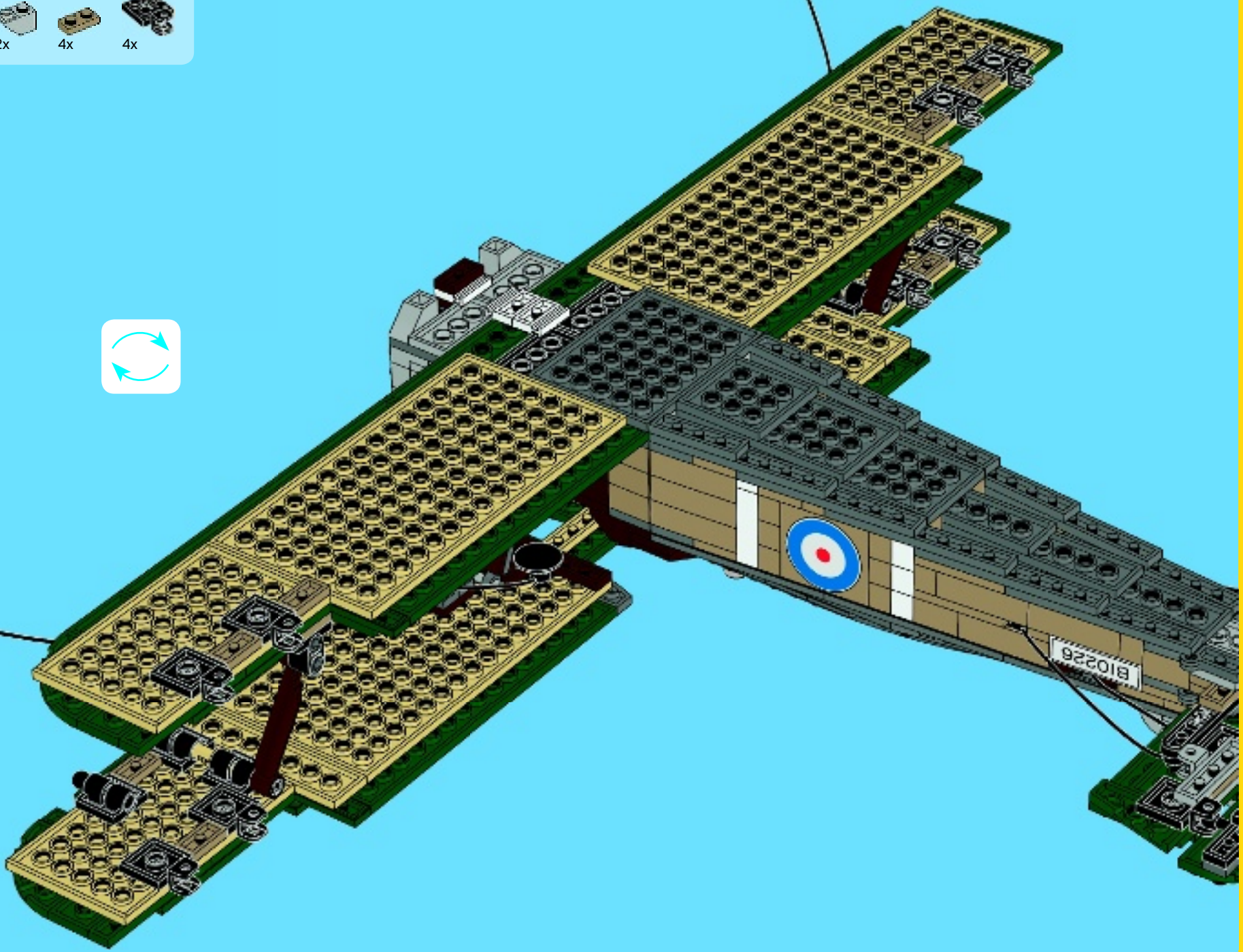

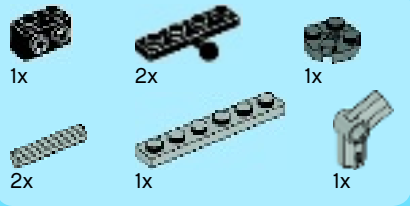

57

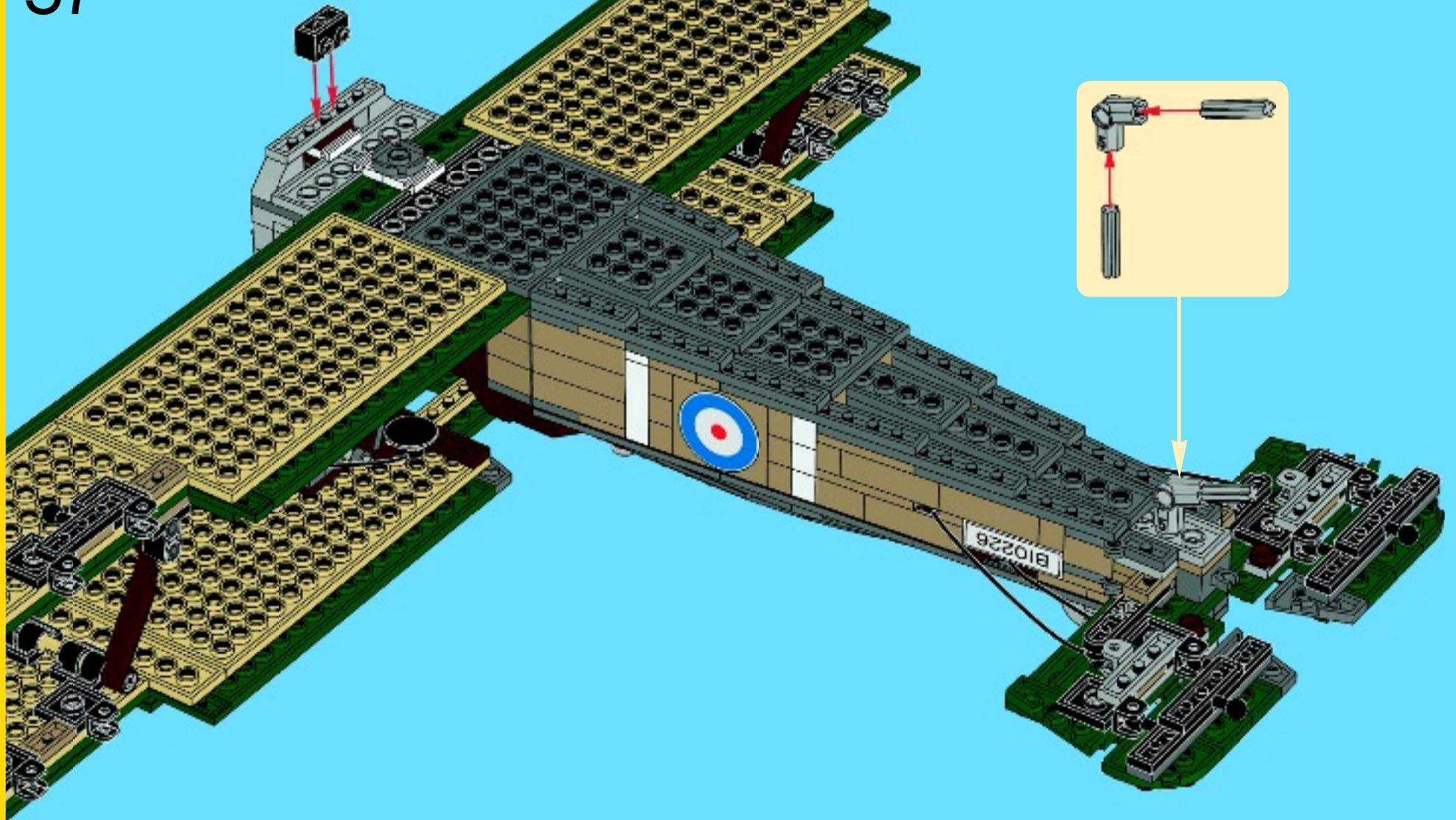

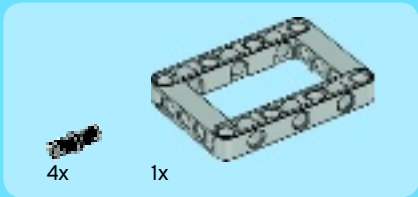
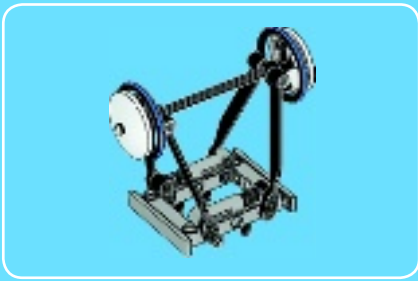

1

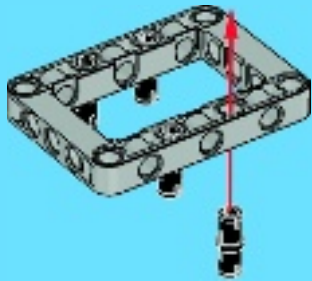

2

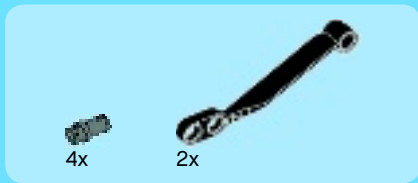
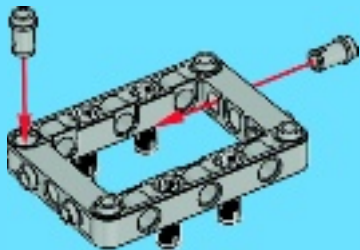

3

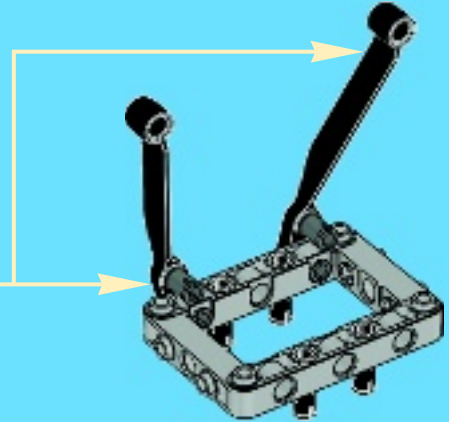

4



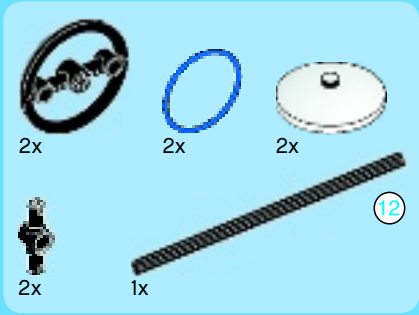

5

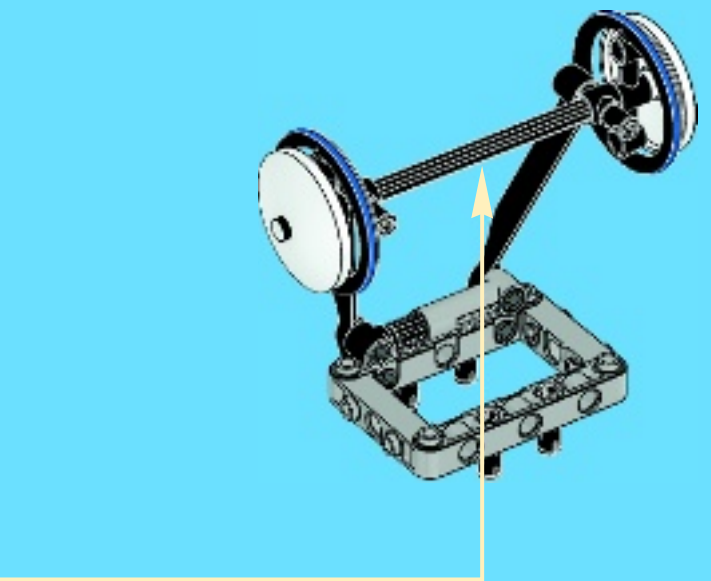
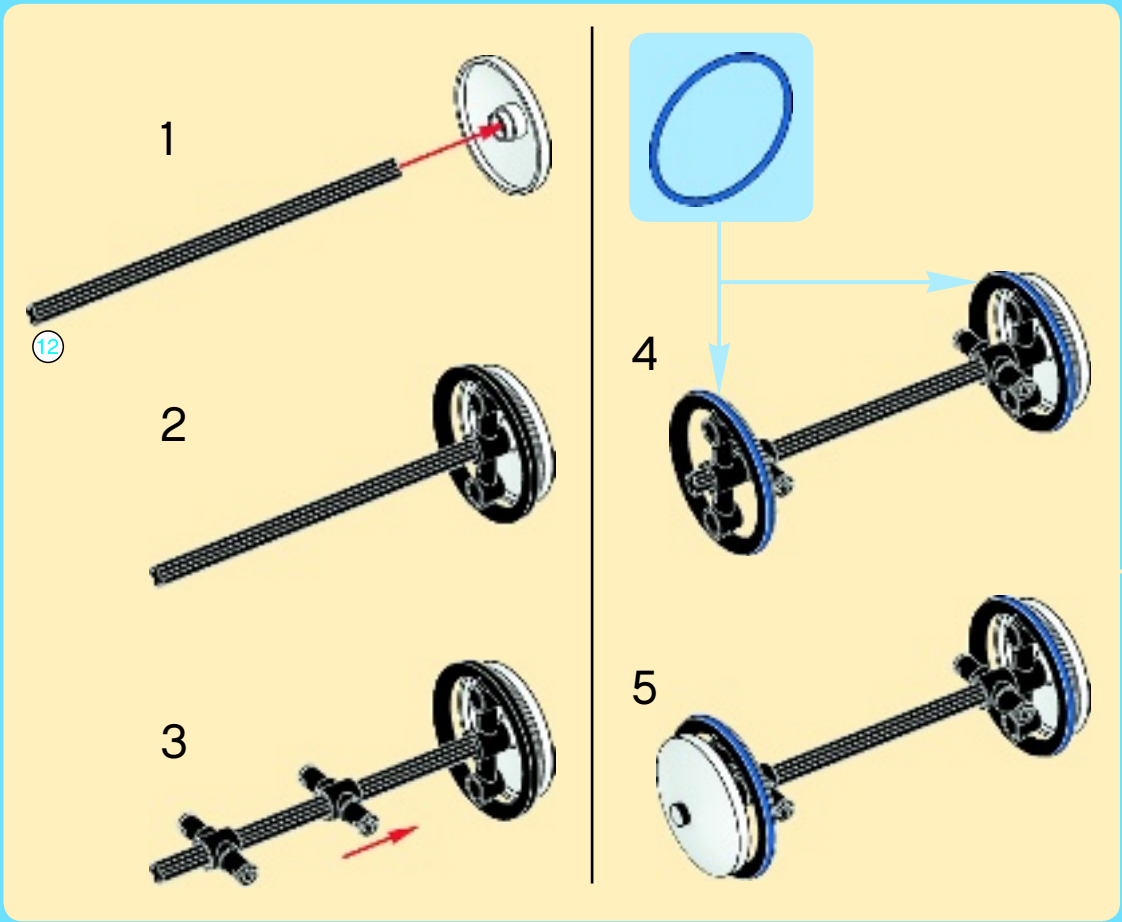

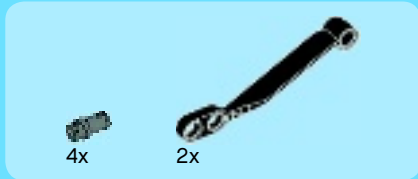

6

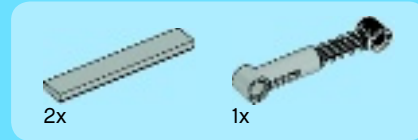
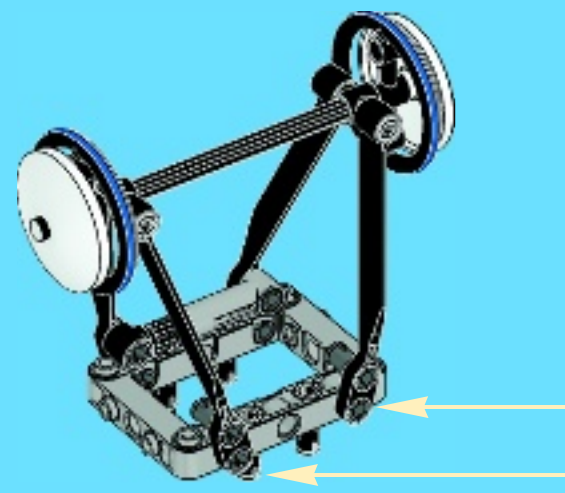
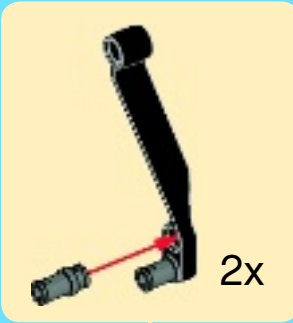

7

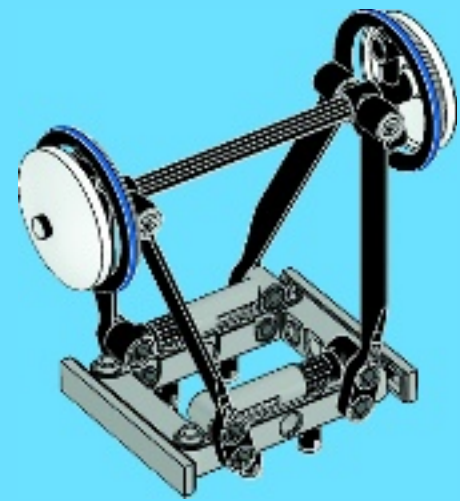

58

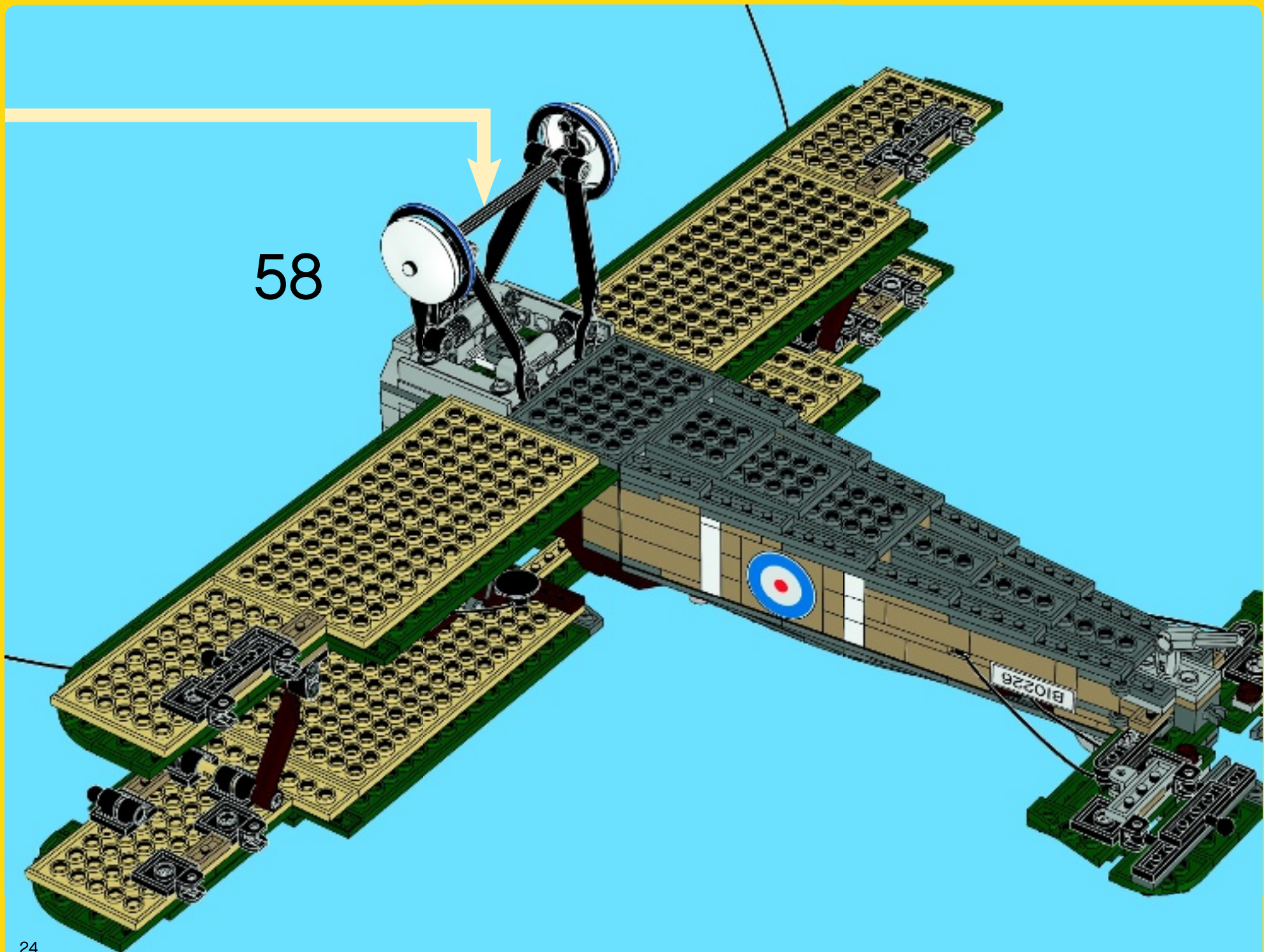

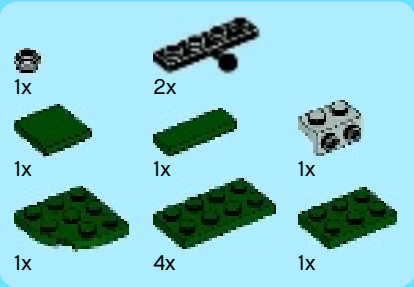

59

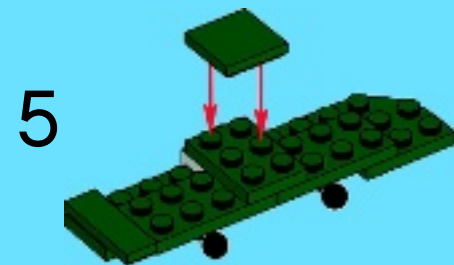
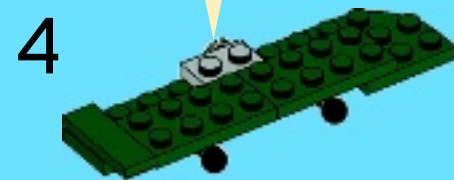
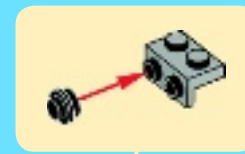
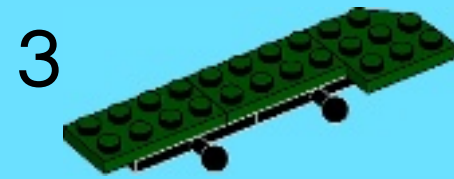

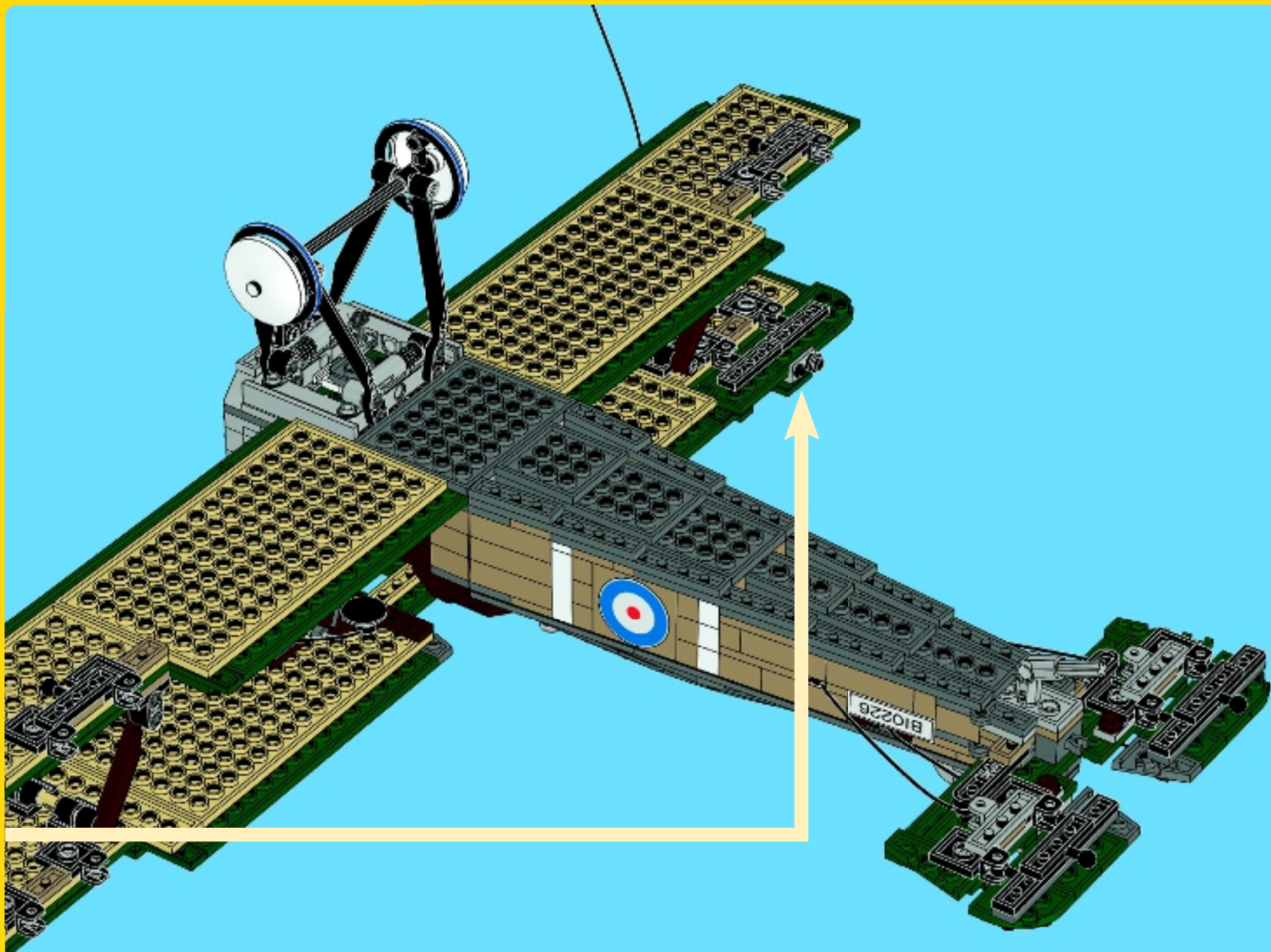

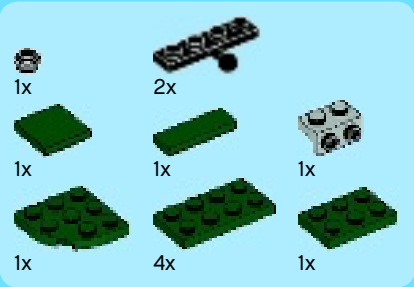

60

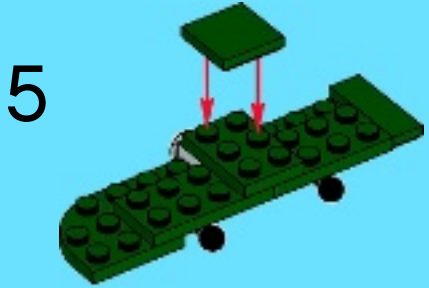
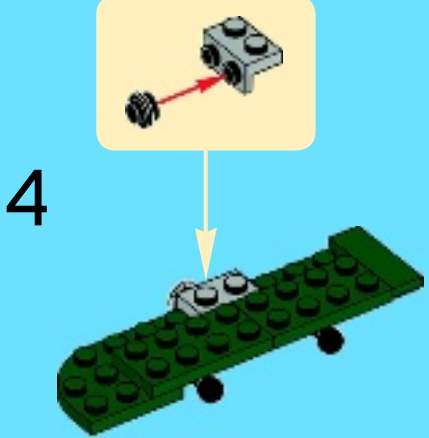

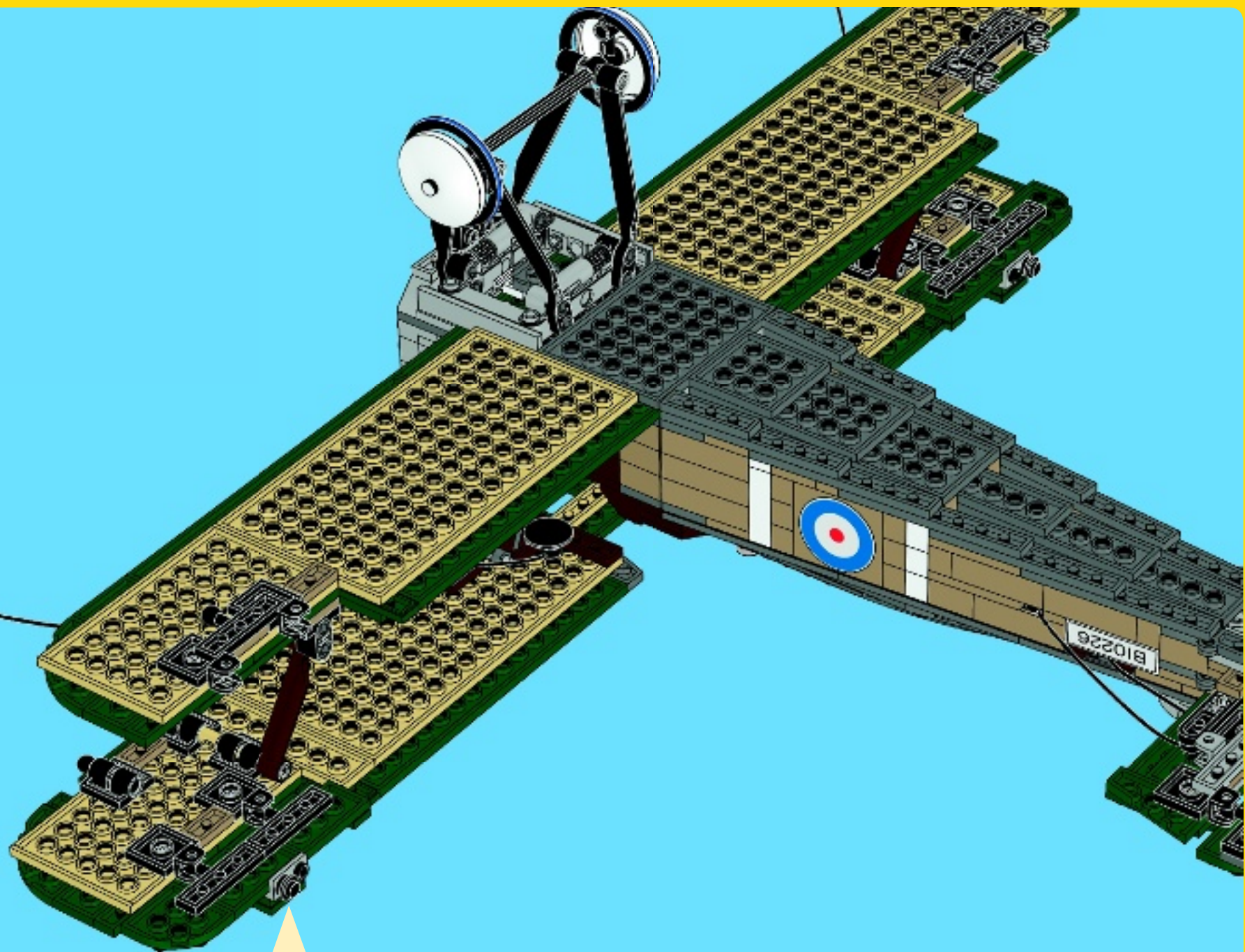

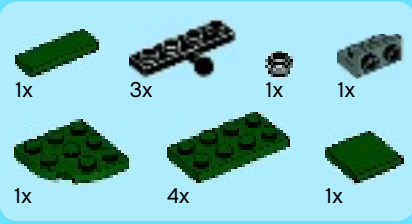

61

1



2



3

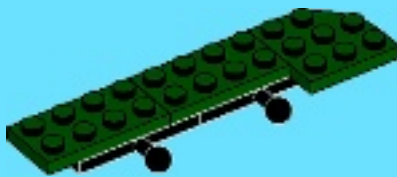

4

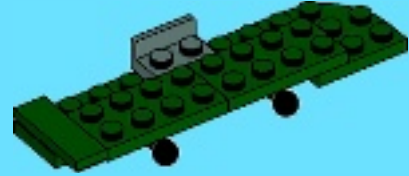

5

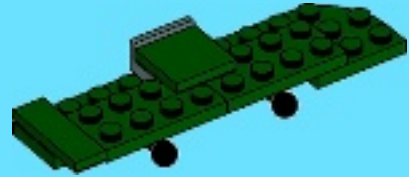

6

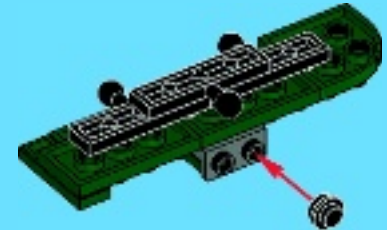

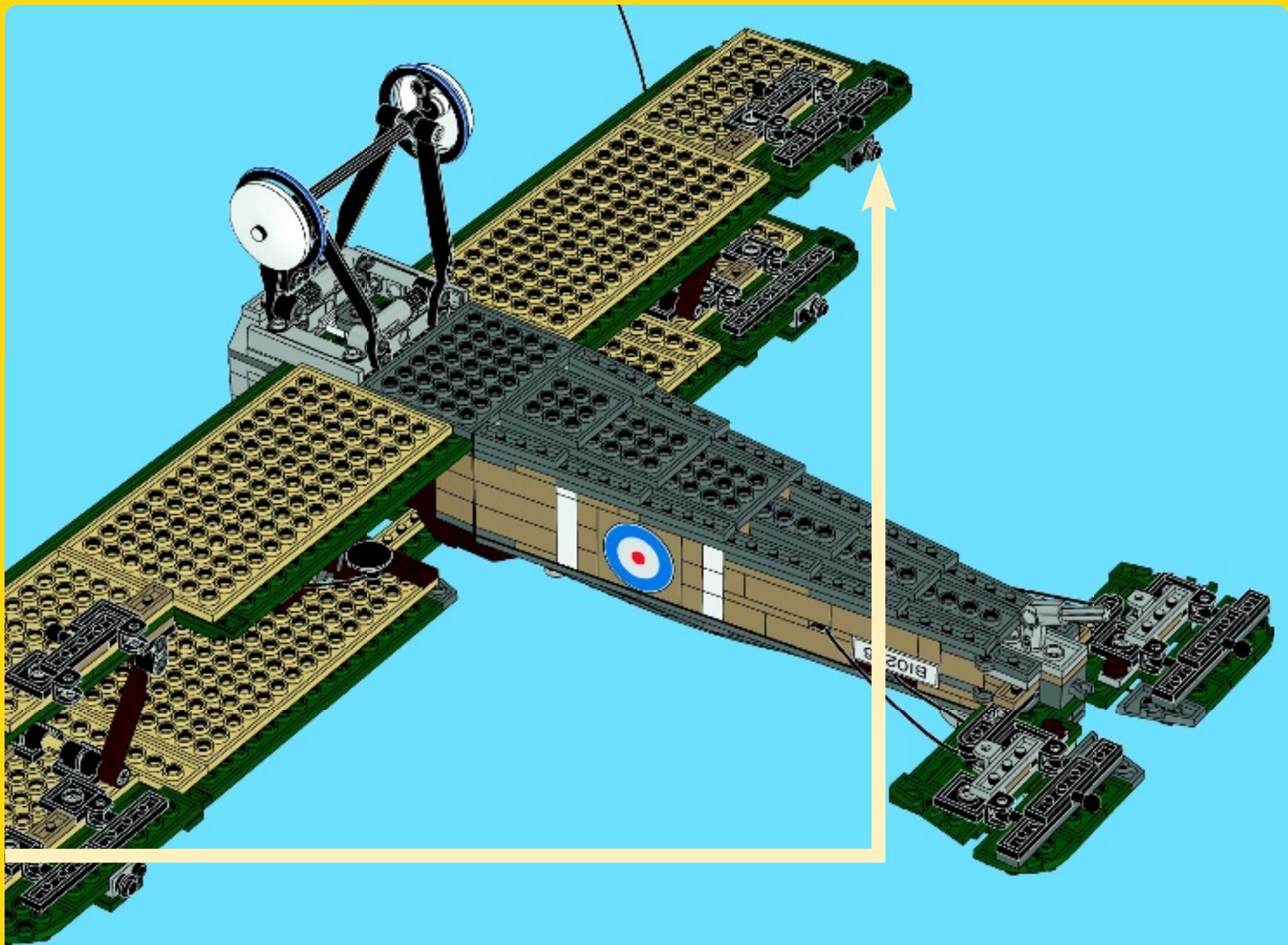

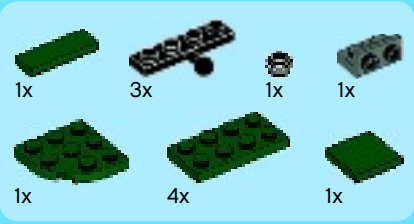

62

1



2

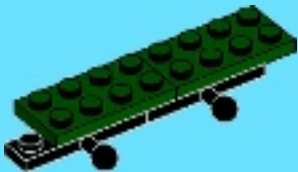

3



4

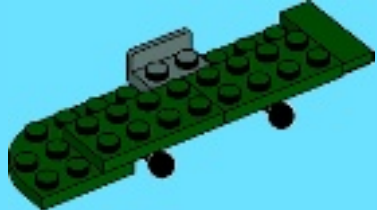

5

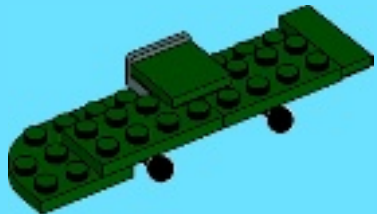

6

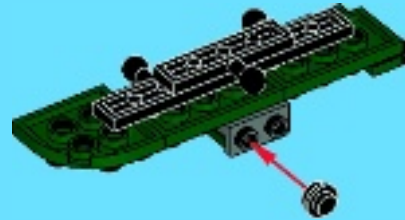

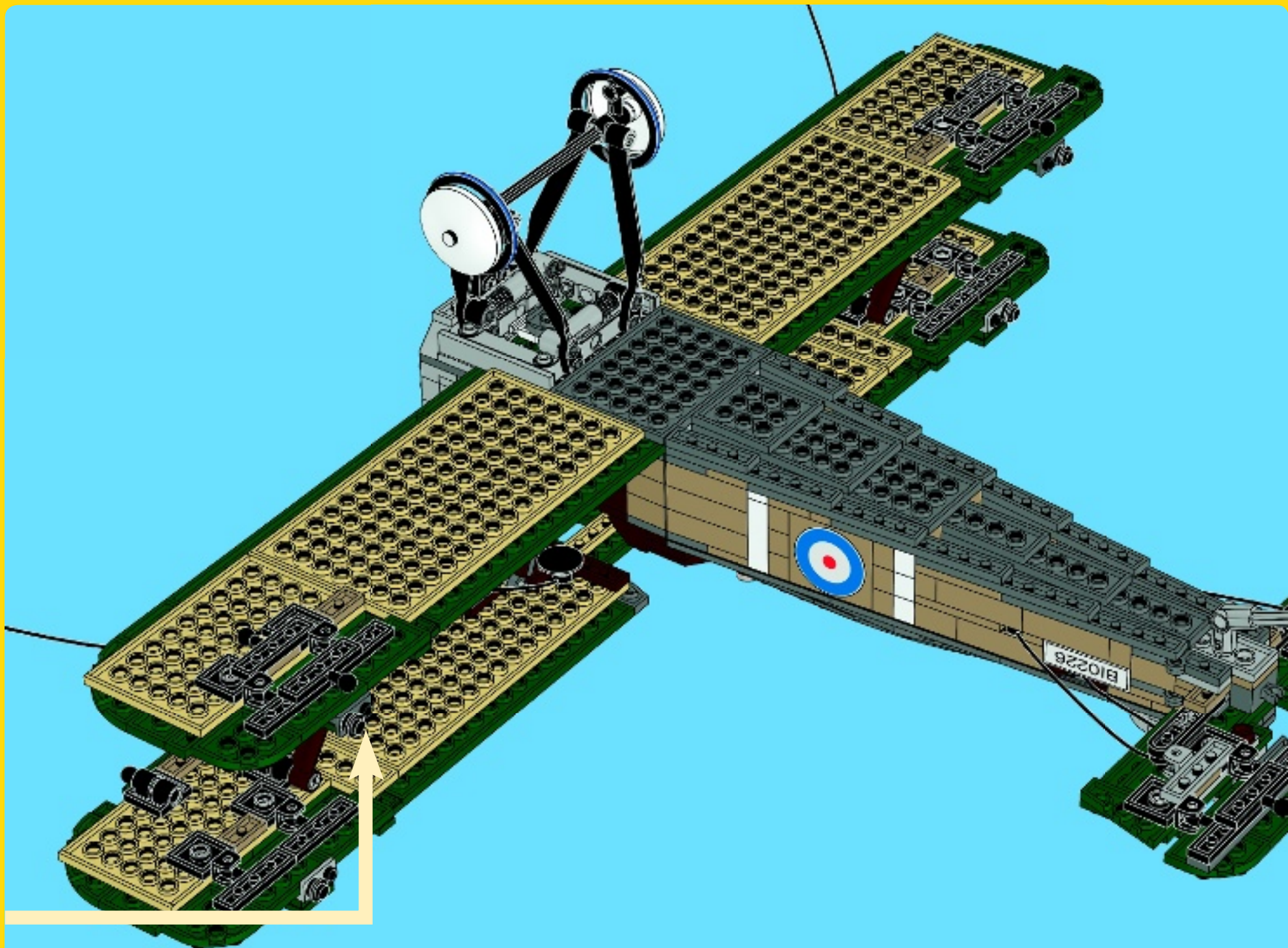



4x

63

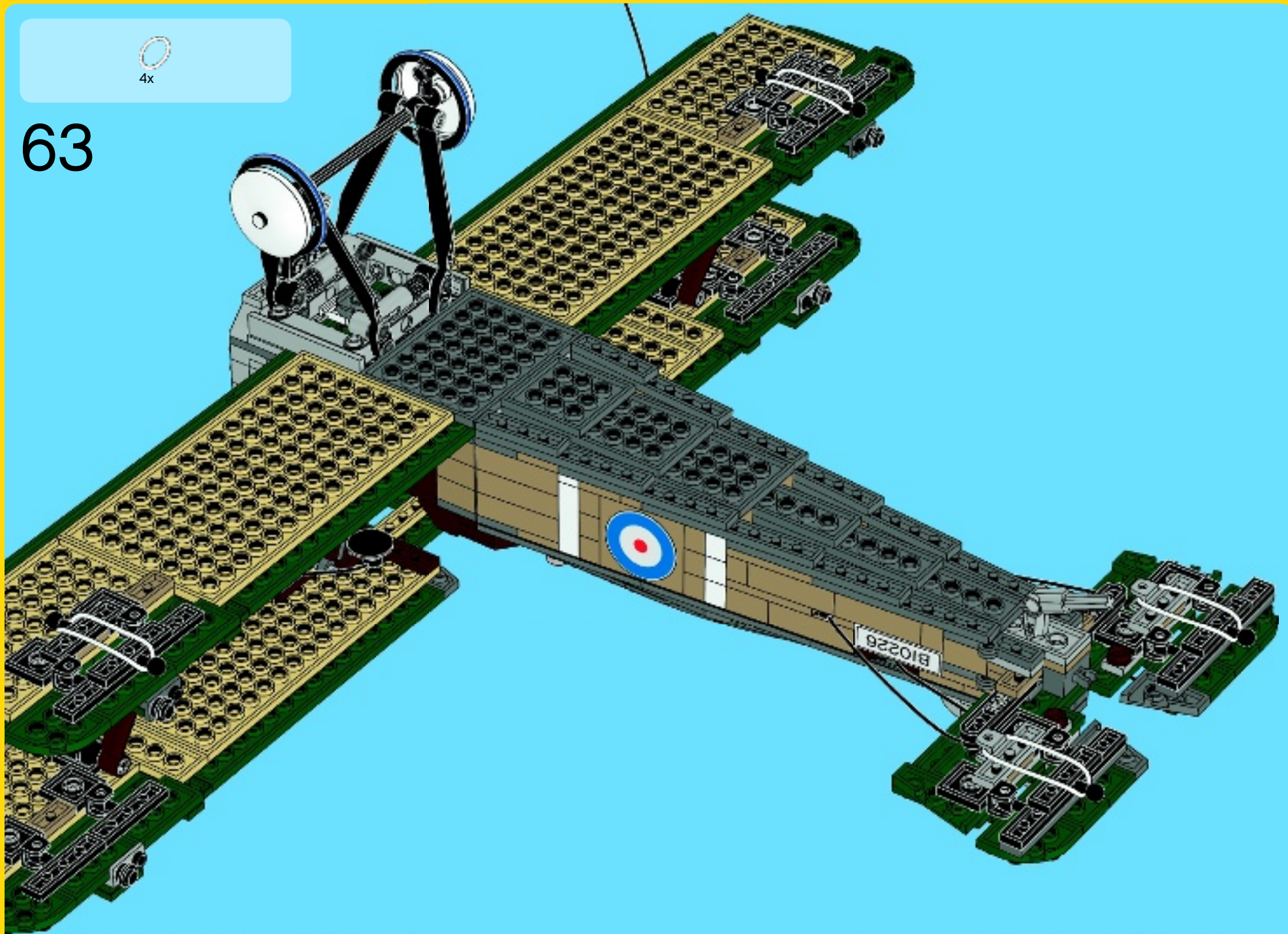

64

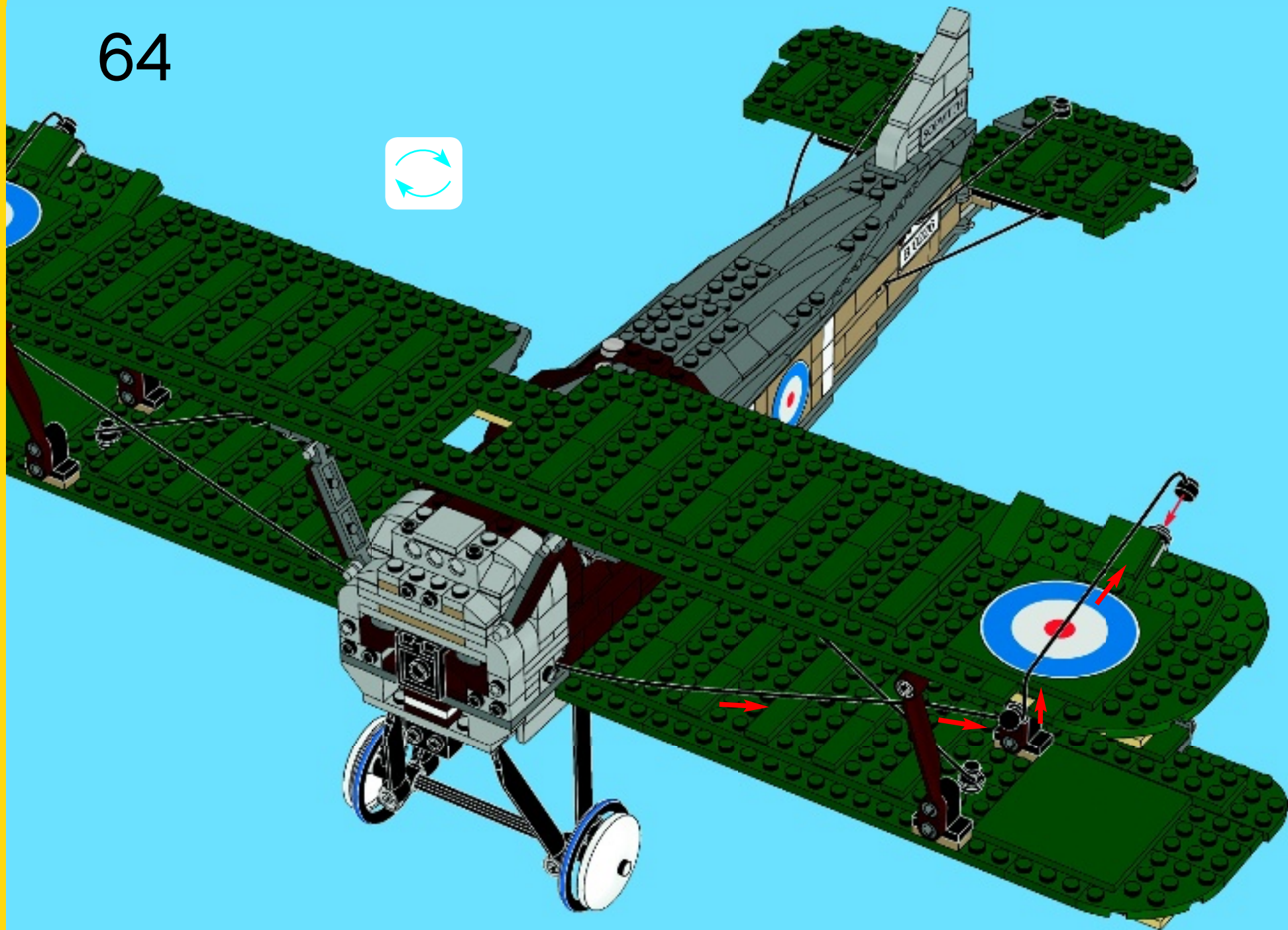



65

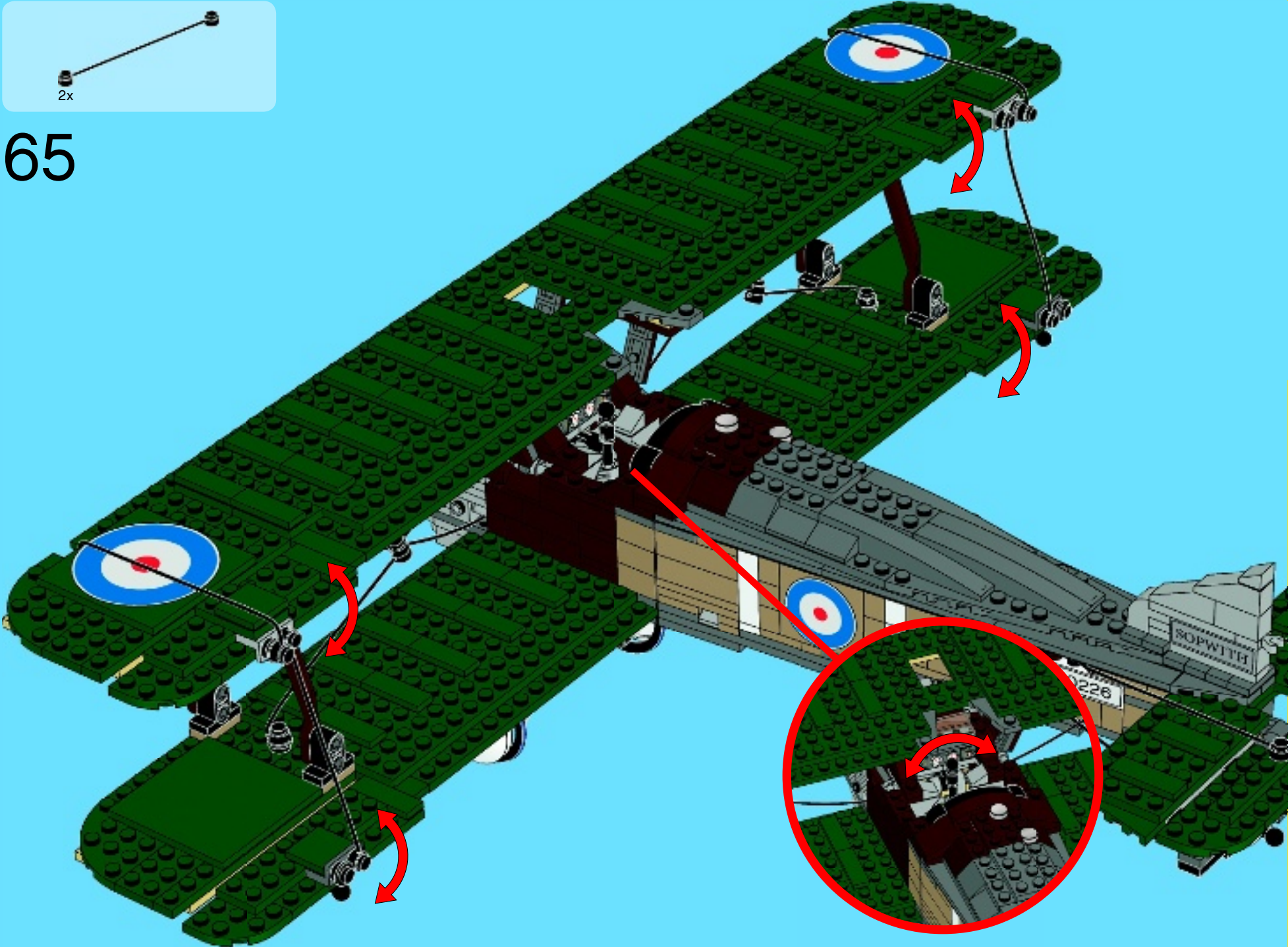

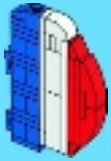

1



2x

2

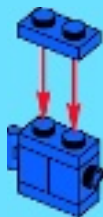

1x



1x

3

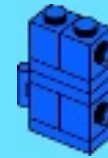

2x

4





1x



1x

5



1x



1x



1x

6

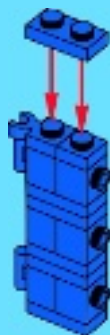

1x



1x

7



2x

8

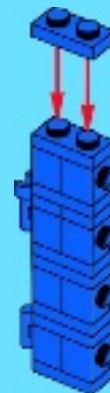



9

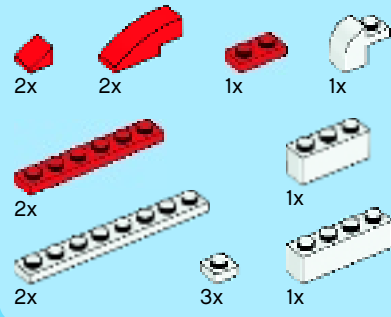
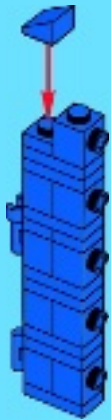

10

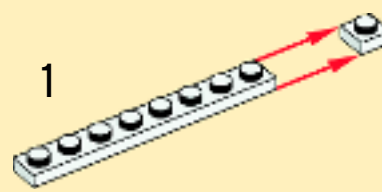

2

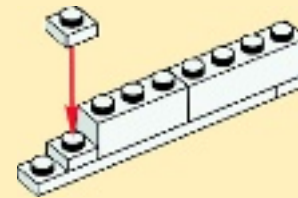

3

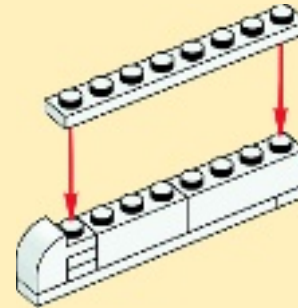

4

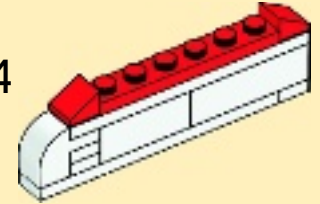

5

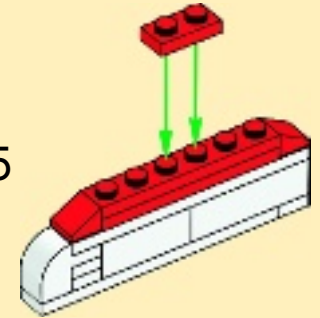

6

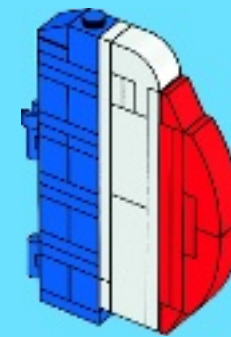
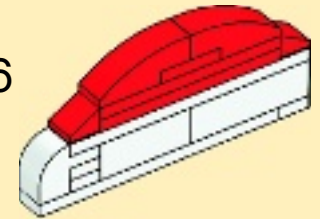

66

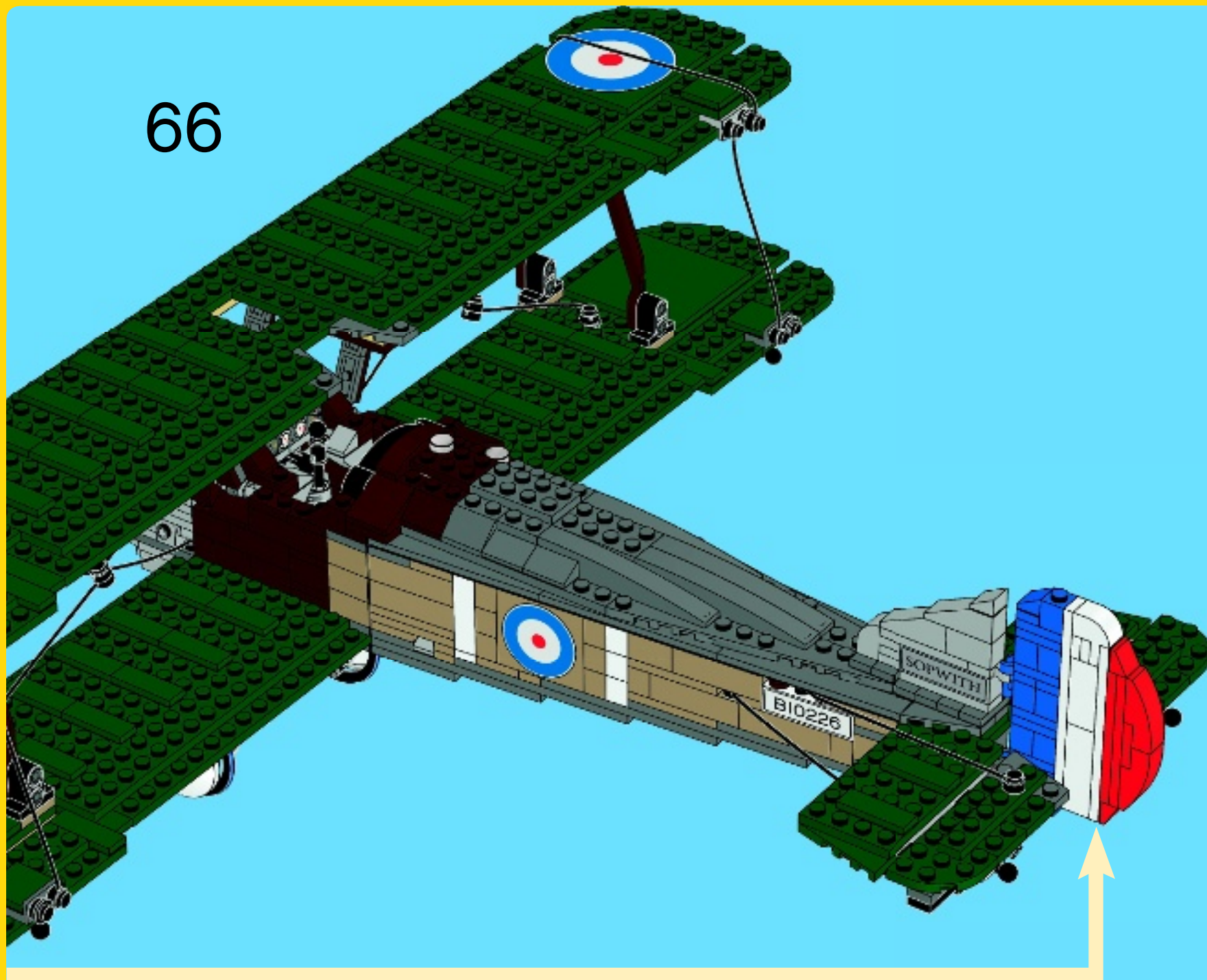



8x

67

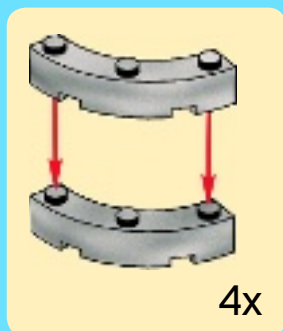

4x

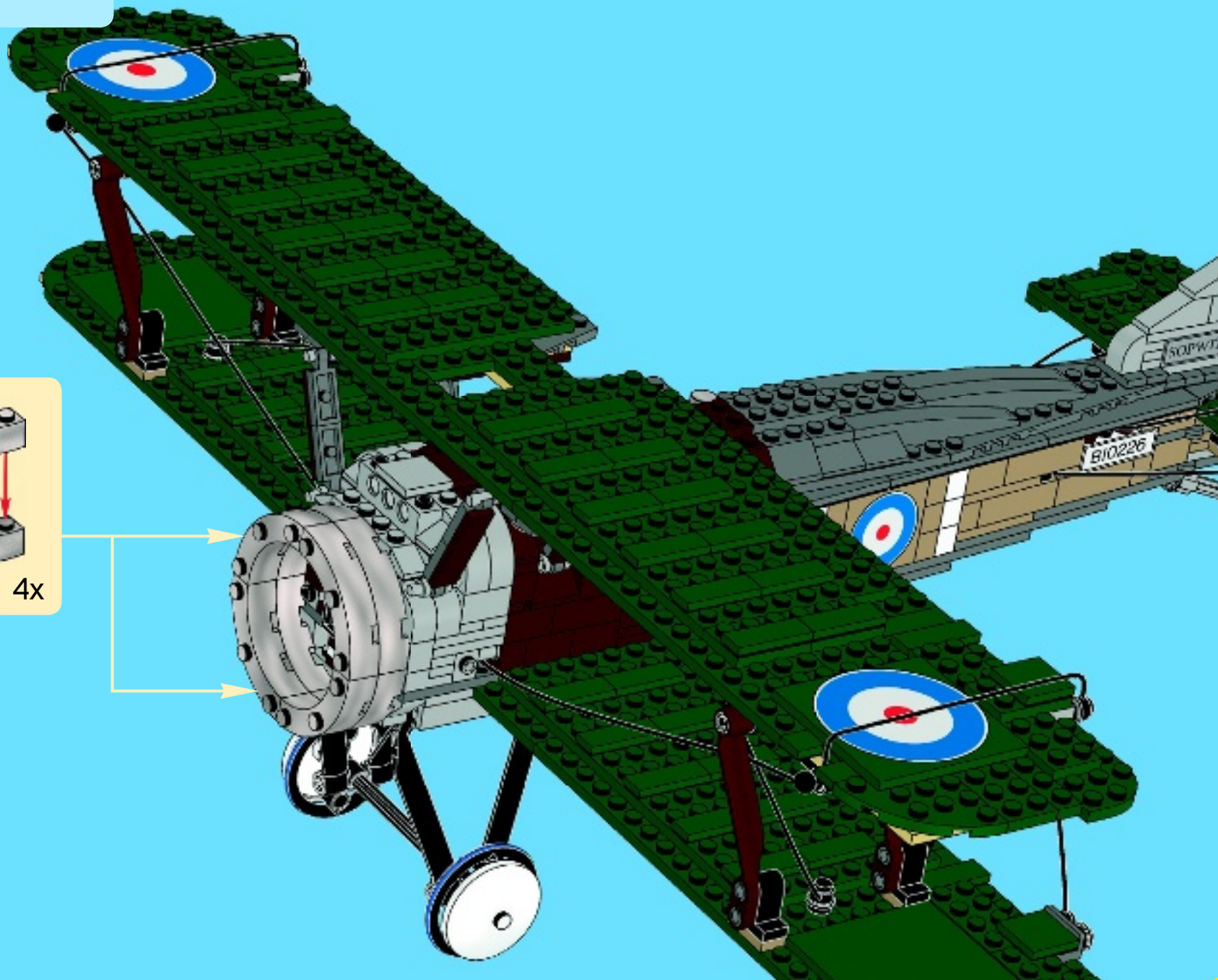



2x



2x



2x

68

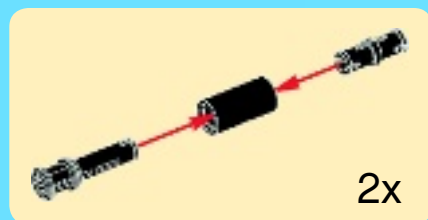

2x

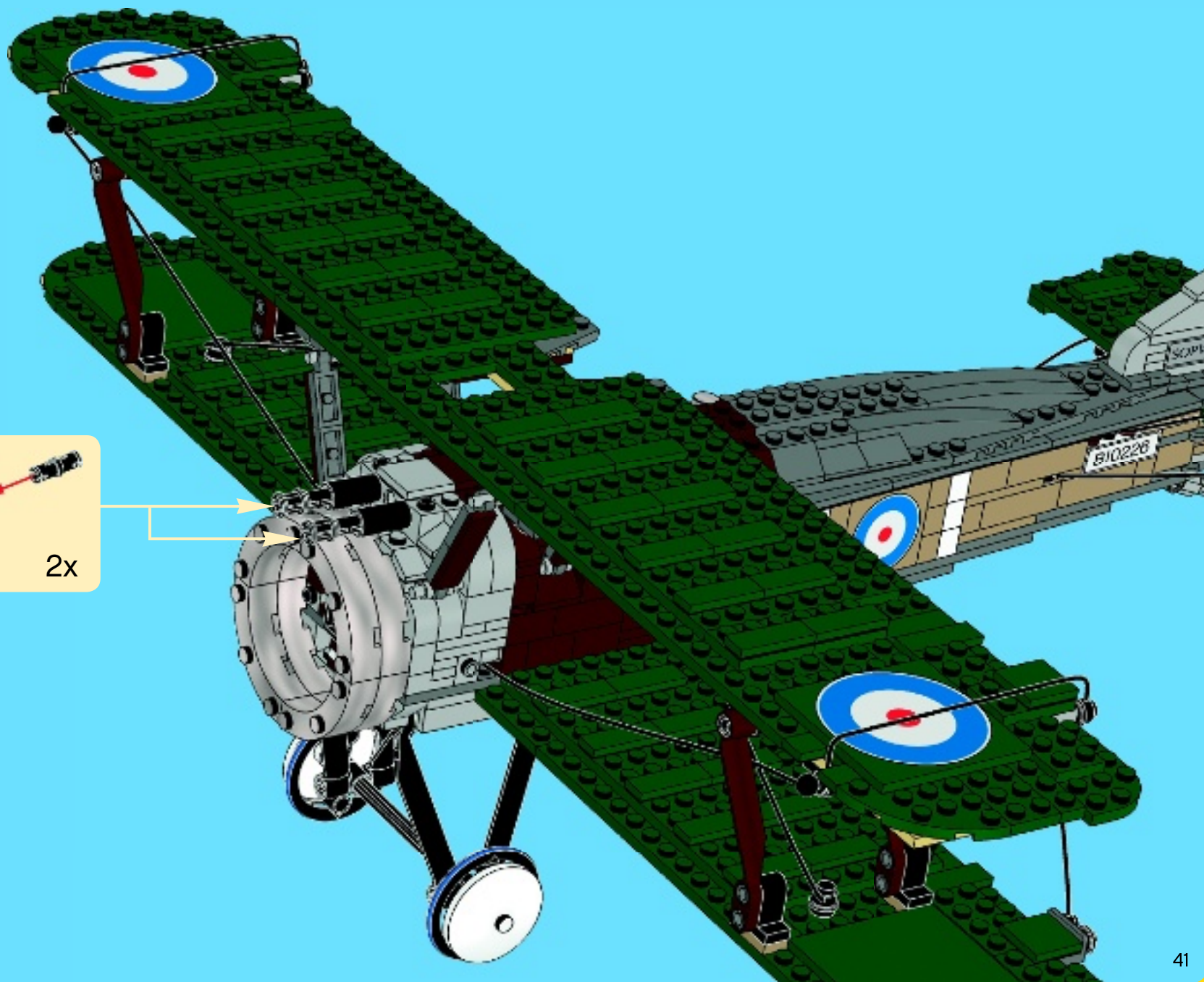

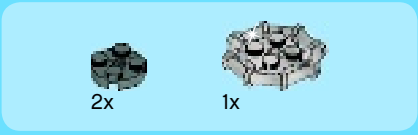
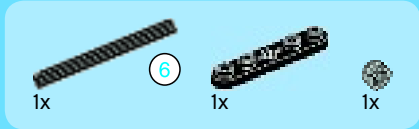

3

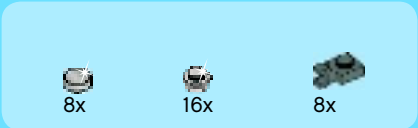
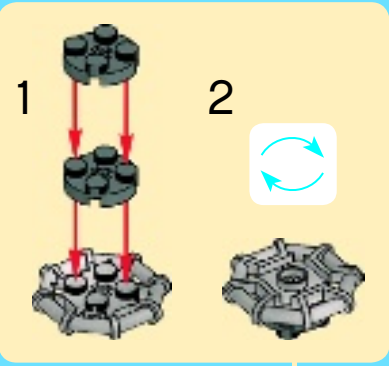

4

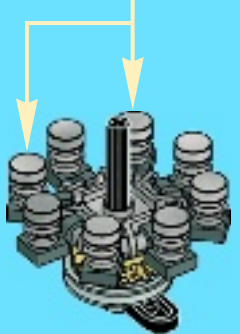
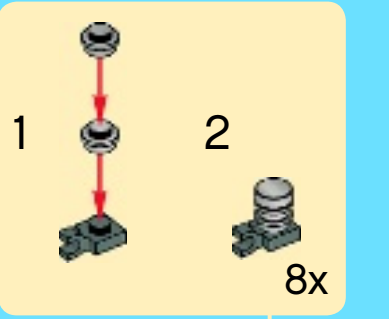



5

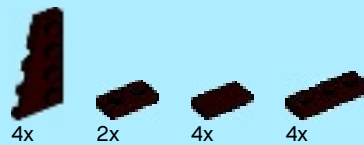

6

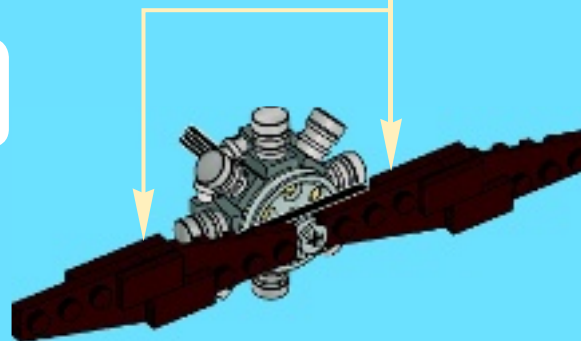
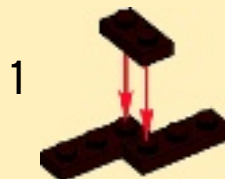

69

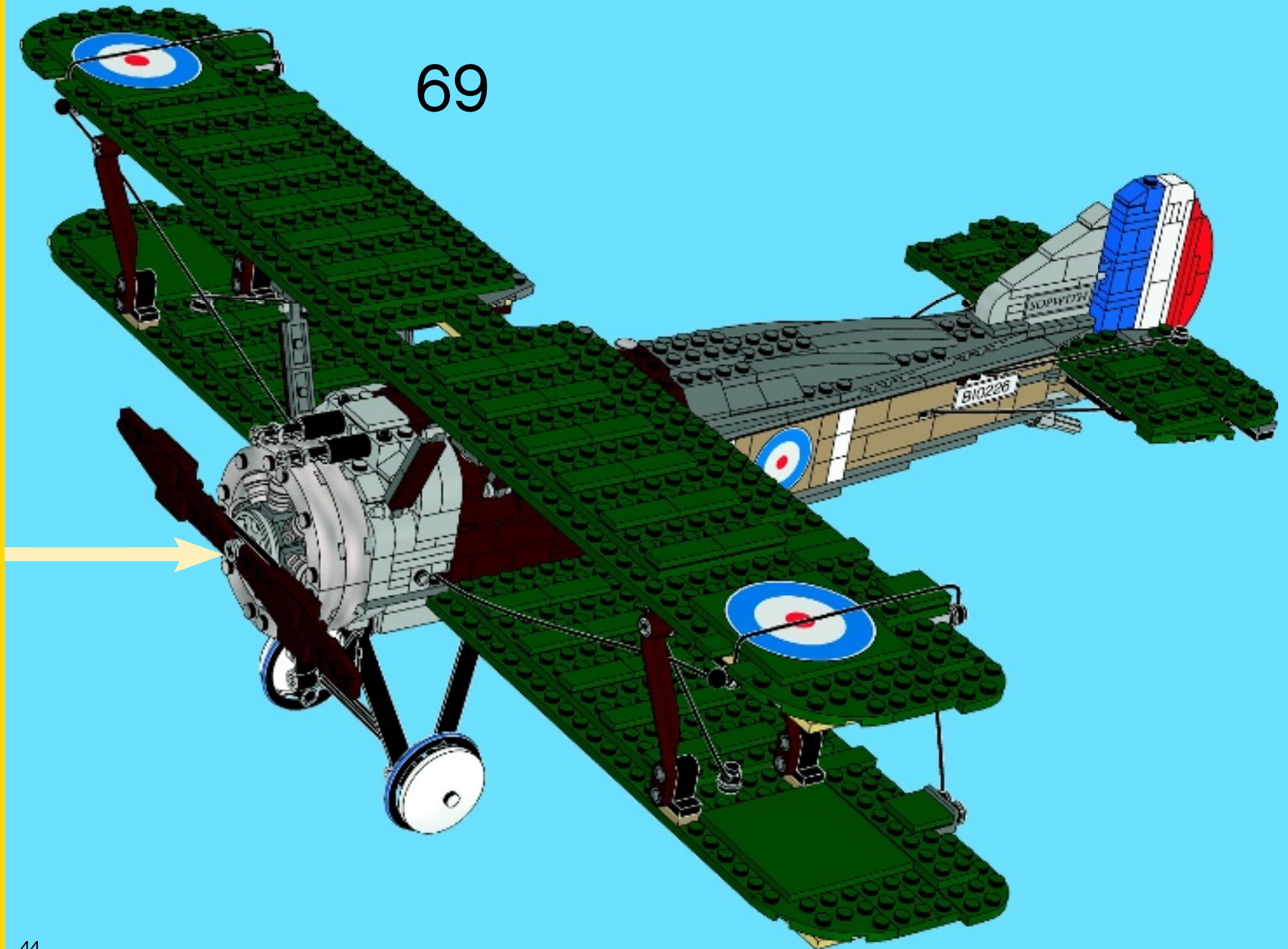

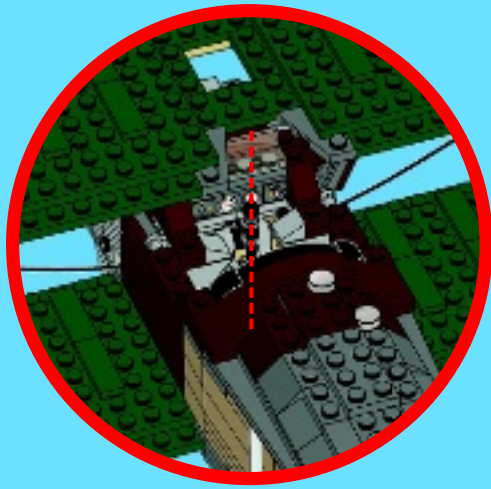

1

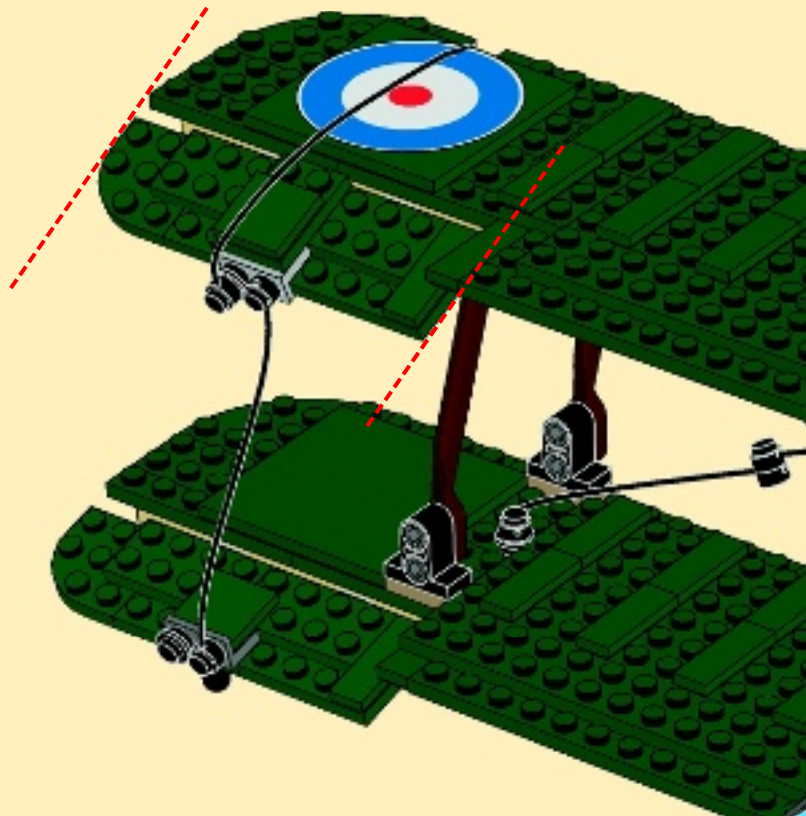

2

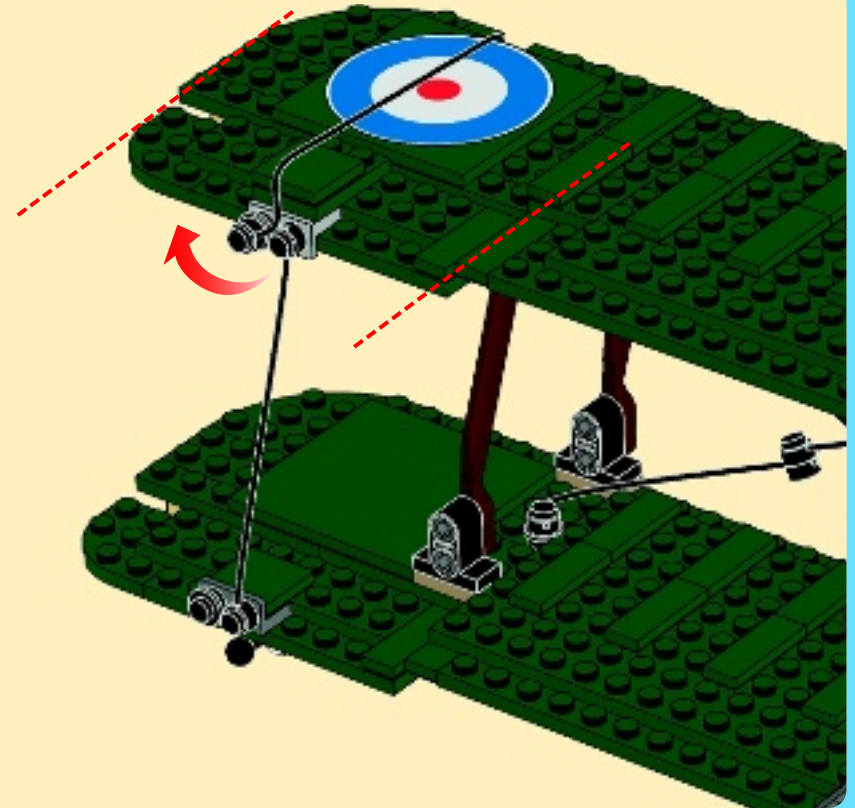

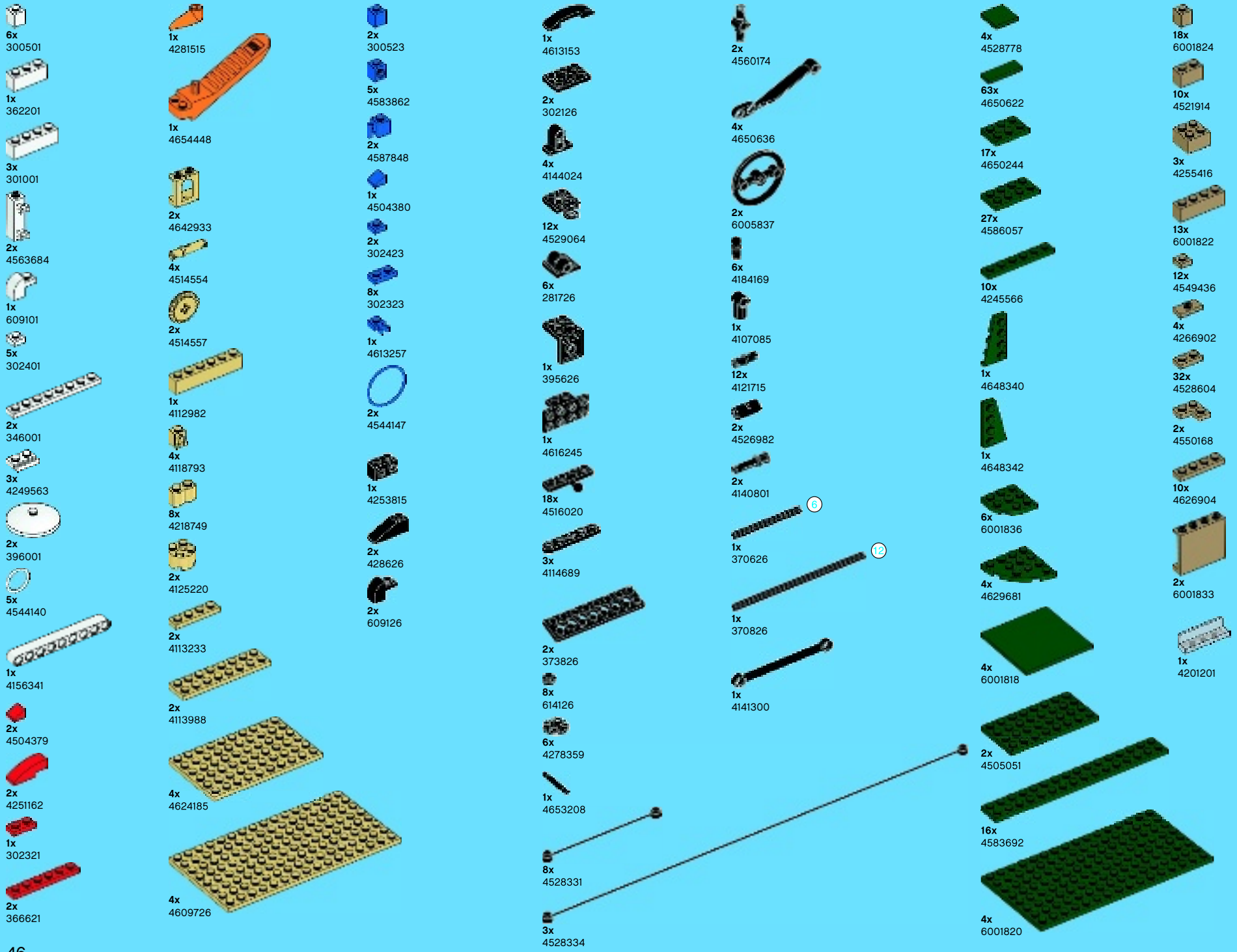

6x 300501
 1x 362201
 3x 301001
 2x 4563684
 1x 609101
 5x 302401
 2x 346001
 3x 4249563
 2x 396001
 5x 4544140
 1x 4156341
 2x 4504379
 2x 4251162
 1x 302321
 2x 366621

1x 4281515
 1x 4654448
 2x 4642933
 4x 4514554
 2x 4514557
 1x 4112982
 4x 4118793
 8x 4218749
 2x 4125220
 2x 4113233
 2x 4113988
 4x 4624185
 4x 4609726

2x 300523
 5x 4583862
 2x 4587848
 1x 4504380
 2x 302423
 8x 302323
 1x 4613257
 2x 4544147
 1x 4253815
 2x 428626
 2x 609126

1x 4613153
 2x 302126
 4x 4144024
 12x 4529064
 6x 281726
 1x 395626
 1x 4616245
 18x 4516020
 3x 4114689
 2x 373826
 8x 614126
 6x 4278359
 1x 4653208
 8x 4528331
 3x 4528334

2x 4560174
 4x 4650636
 2x 6005837
 6x 4184169
 1x 4107085
 12x 4121715
 2x 4526982
 2x 4140801
 1x 370626
 1x 370826
 1x 4141300

4x 4528778
 63x 4650622
 17x 4650244
 27x 4586057
 10x 4245566
 1x 4648340
 1x 4648342
 6x 6001836
 4x 4629681
 4x 6001818
 2x 4505051
 16x 4583692
 4x 6001820

18x 6001824
 10x 4521914
 3x 4255416
 13x 6001822
 12x 4549436
 4x 4266902
 32x 4528604
 2x 4550168
 10x 4626904
 2x 6001833
 1x 4201201

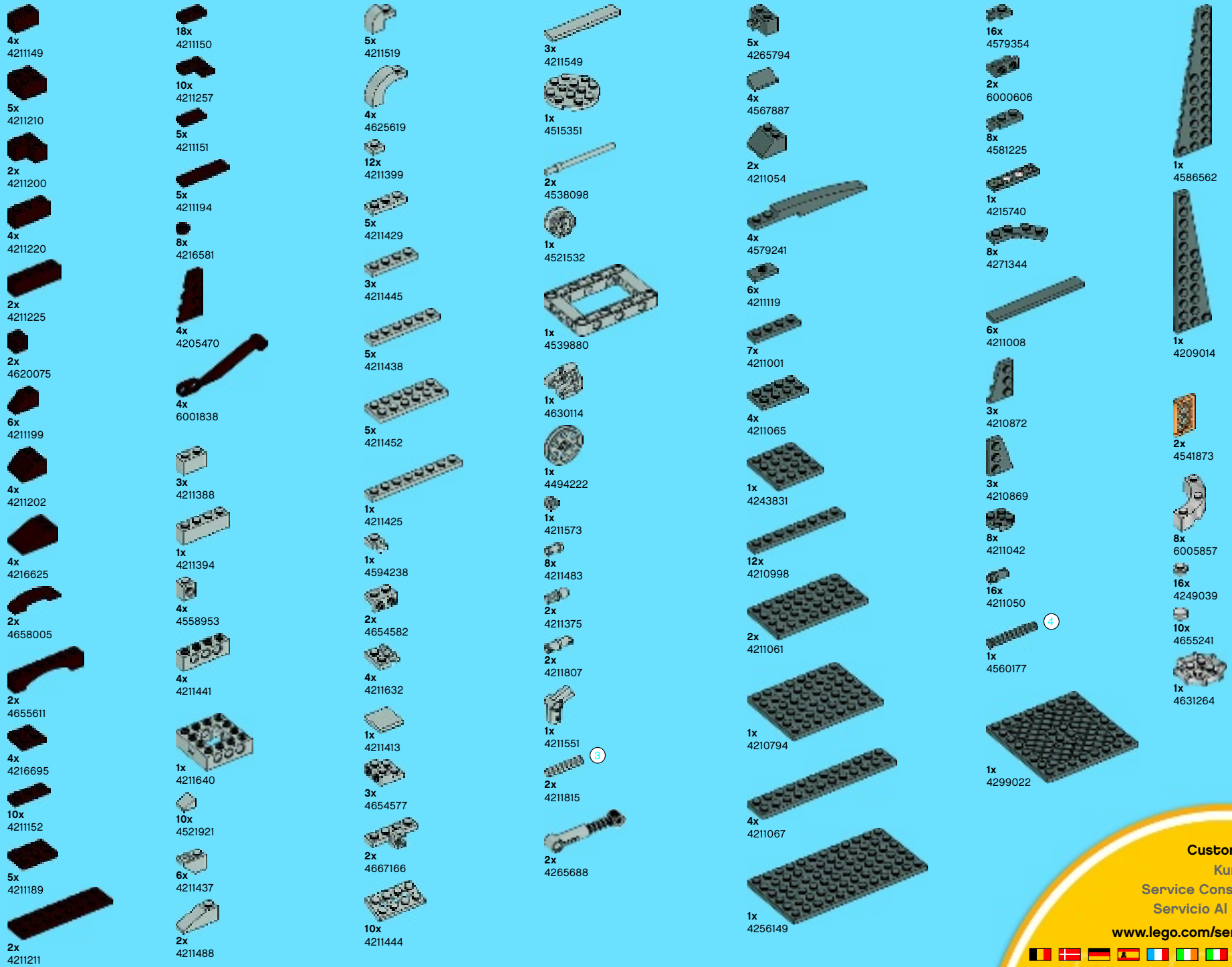

Customer Service
Kundenservice
Service Consommateurs
Servicio Al Consumidor

www.lego.com/service or dial



: 00800 5346 5555

: 1-800-422-5346





WIN!

Go to www.LEGOsurvey.com/product to fill out a survey for a chance to win a cool LEGO® Product. No purchase necessary. Open to all residents where not prohibited.



www.LEGO.com



www.LEGOsurvey.com/product

GEWINNE!

Nimm an der Umfrage auf www.LEGOsurvey.com/product teil und hab die Chance ein cooles LEGO® Produkt zu gewinnen! Die Teilnahme am Gewinnspiel führt zu keinerlei Kaufverpflichtungen. Teilnahme in allen nicht ausgeschlossenen Ländern möglich.

WIN!

Ga naar www.LEGOsurvey.com/product, vul een enquêteformulier in en maak kans op een cool LEGO® product. Geen aankoopverplichting, iedereen mag deelnemen, uitgezonderd ingezetenden van landen waar een enquêteverbod geldt.

GAGNE!

Visite www.LEGOsurvey.com/product pour répondre à un questionnaire et avoir une chance de gagner un produit LEGO® très cool ! Aucune obligation d'achat. Ouvert à tous les résidents des pays autorisés.

当てよう!

www.LEGOsurvey.com/product にアクセスして、アンケートにご記入ください。当選者にはレゴ®製品を差し上げます。お買い上げの必要はありません。禁止されていない限り、すべての皆様にご利用いただけます。