

**LEGO**



8486



1

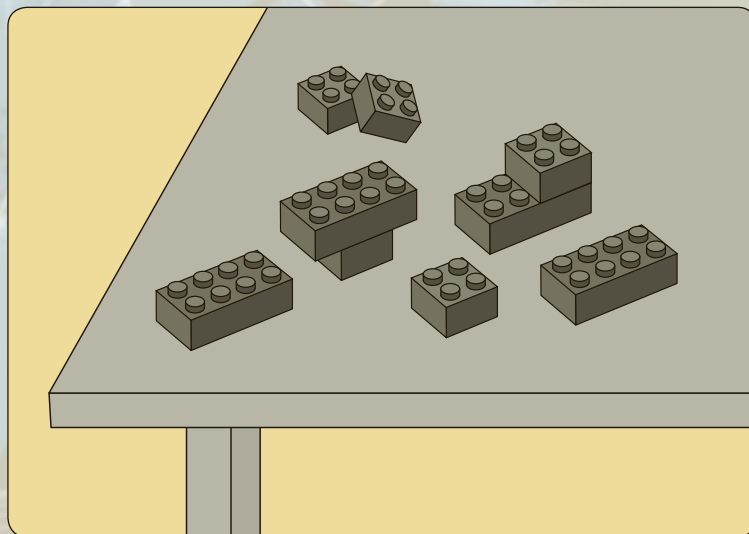
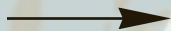
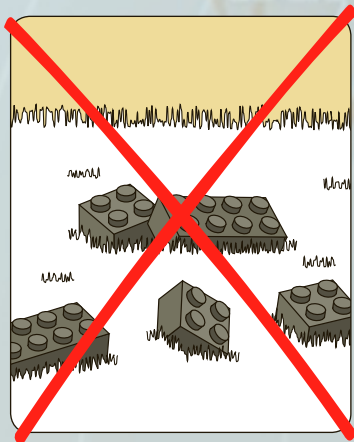

2

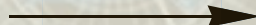

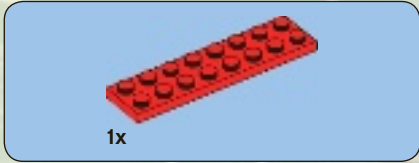

1

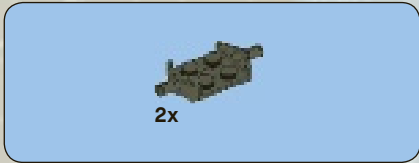

2

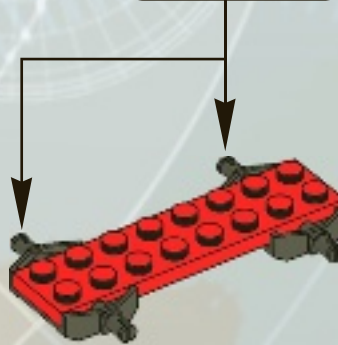



3

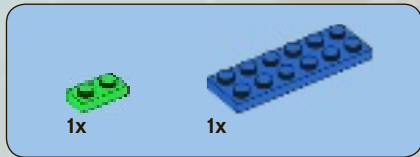
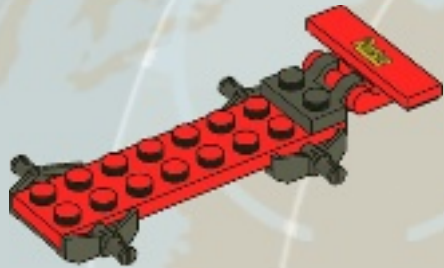
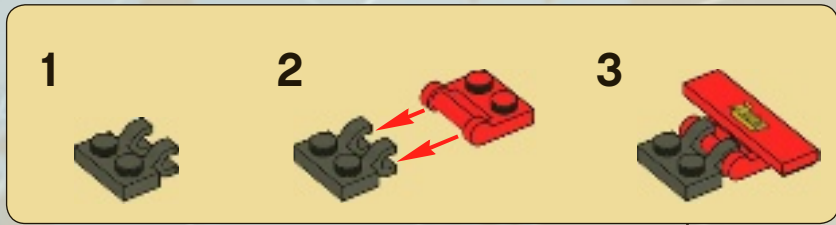

4

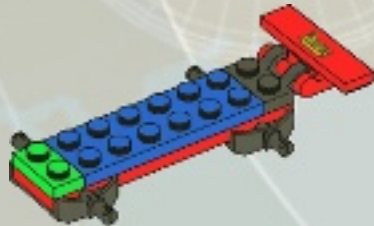



5

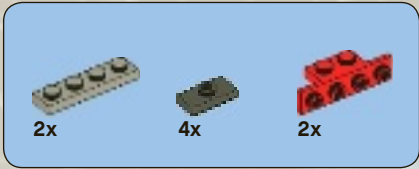
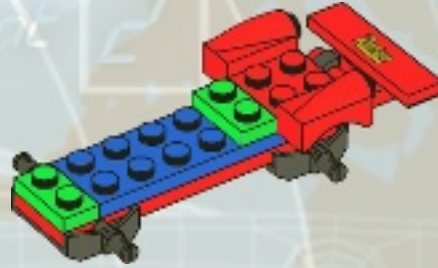

6

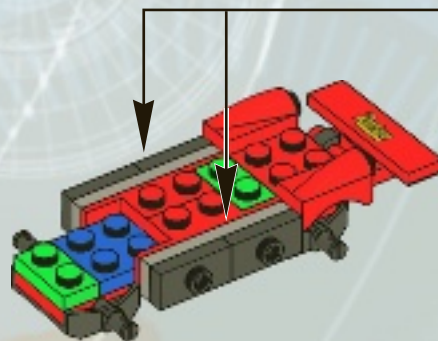
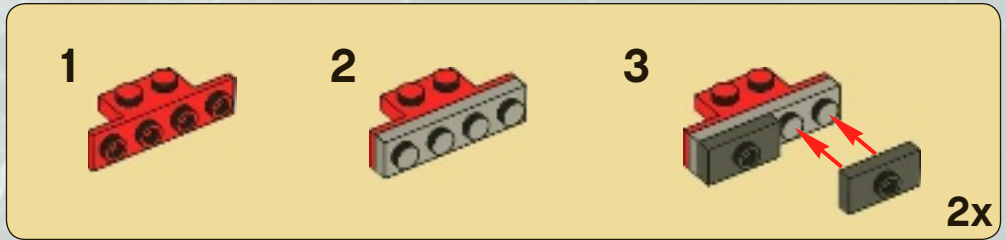



1x

aypoint 7

7

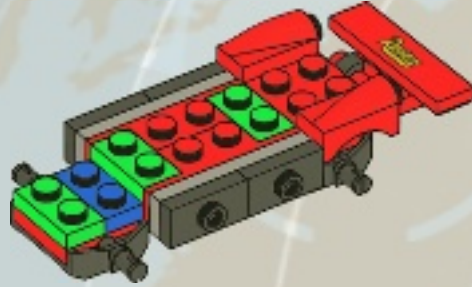

1x

8





1x



1x

9

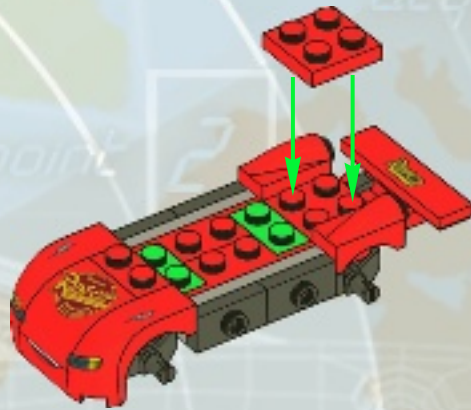

target  
acquired

waypoint 2



1x

10





4x



4x

# 11



1x



1x

# 12







13

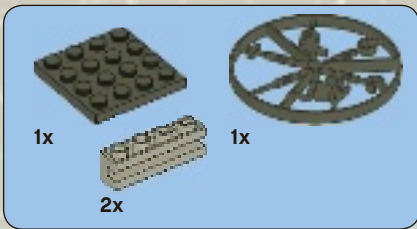
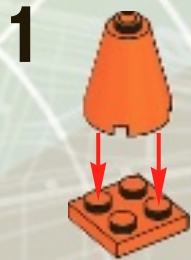
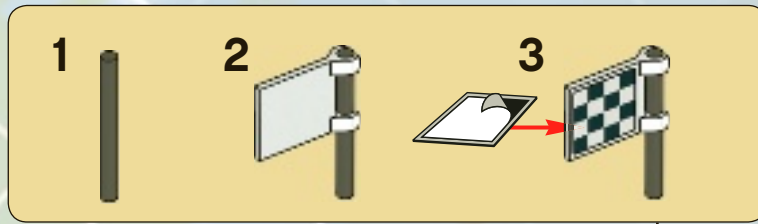

14

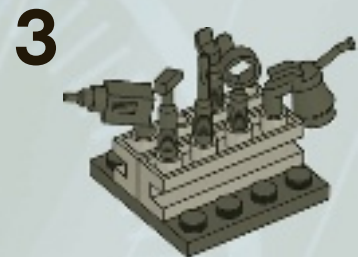
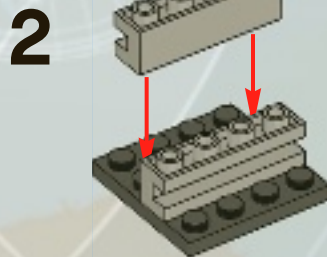

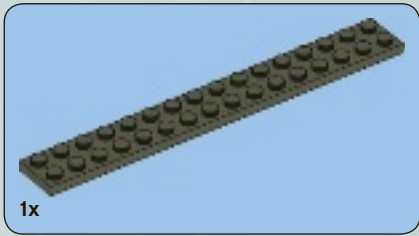
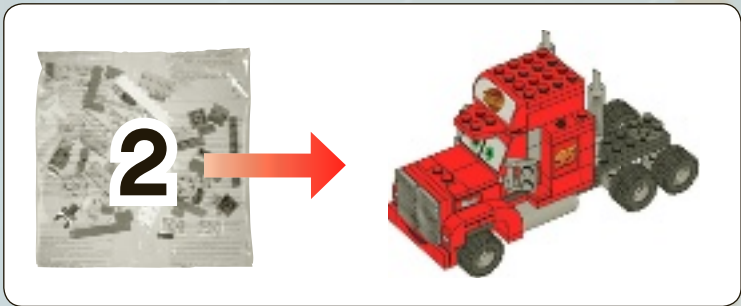

1

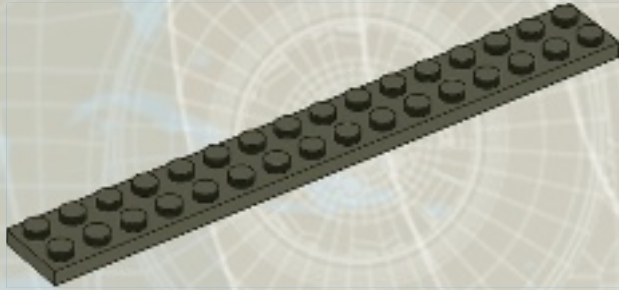



2x

2

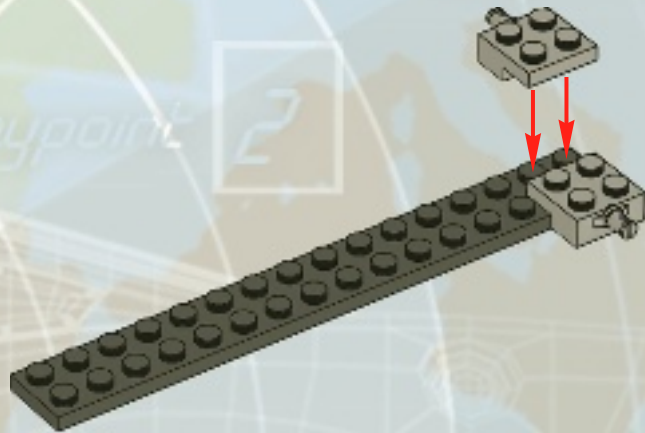

target  
acquired

waypoint 2



1x



2x

3

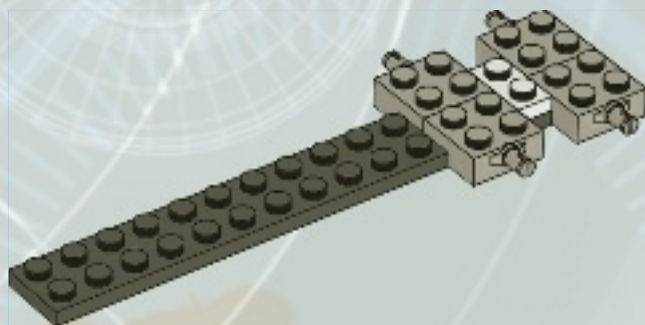



4

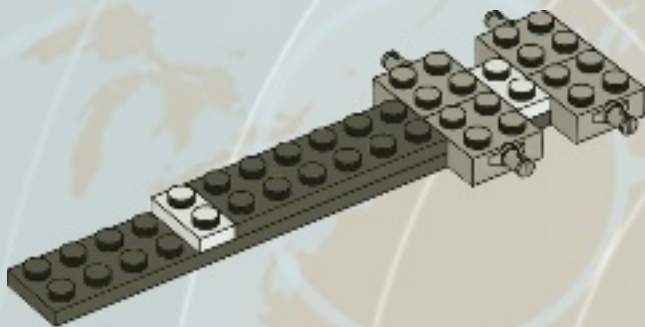

5

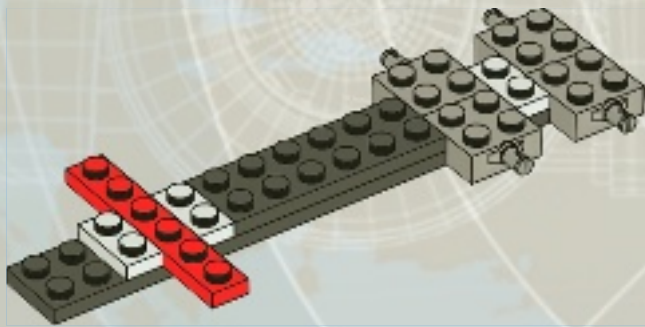



2x

6

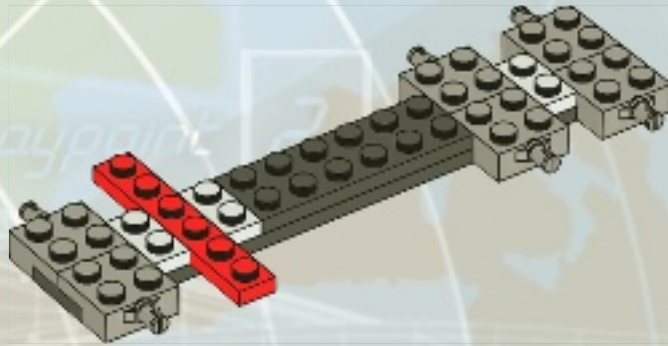

target  
acquired

waypoint 7



1x

7

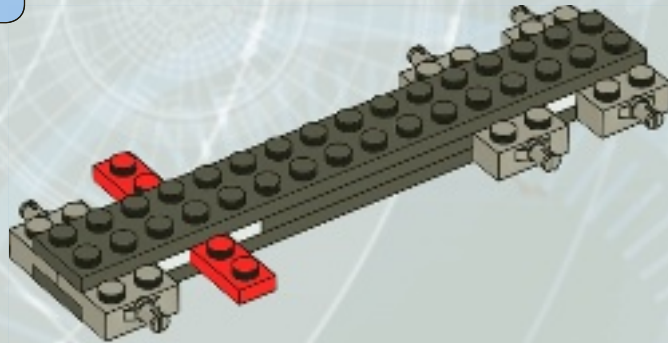



8

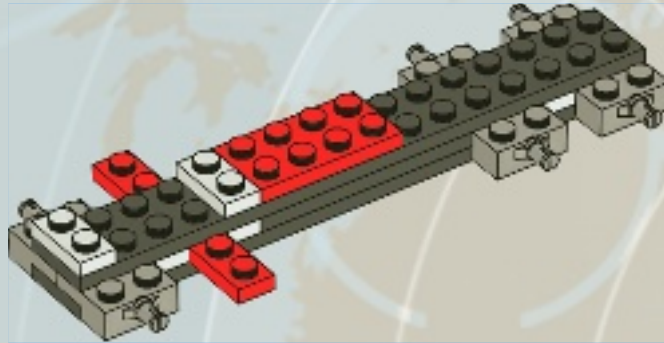

9

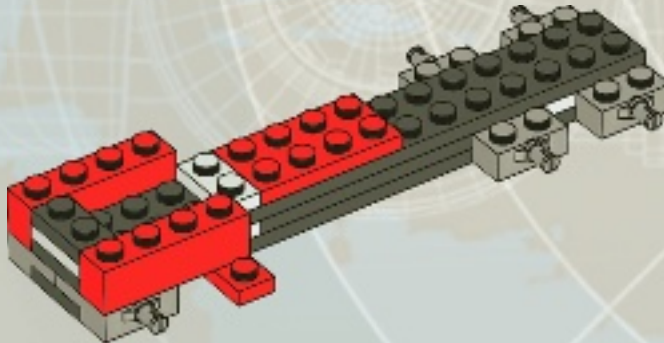



# 10

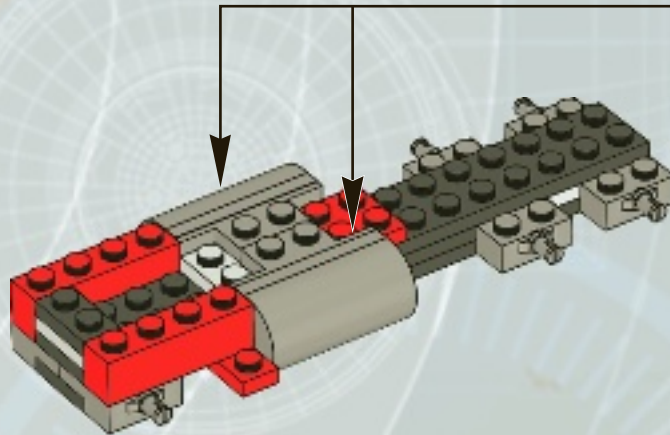
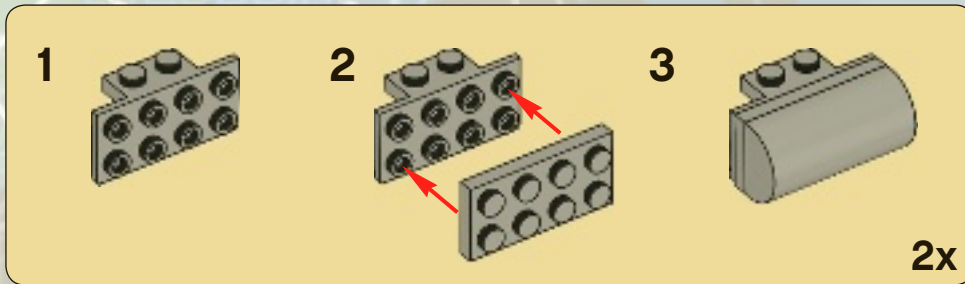



2x

# 11

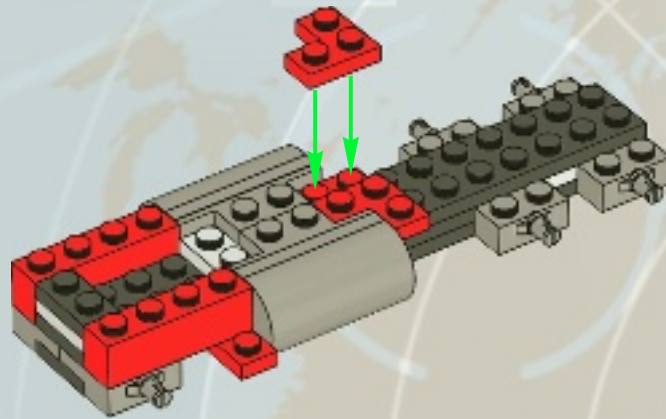

1x



2x



2x

# 12

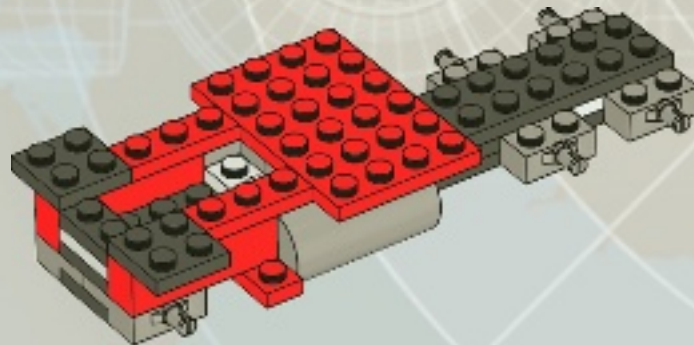



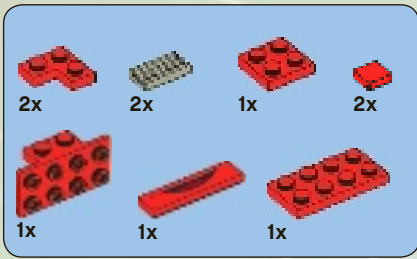

# 13

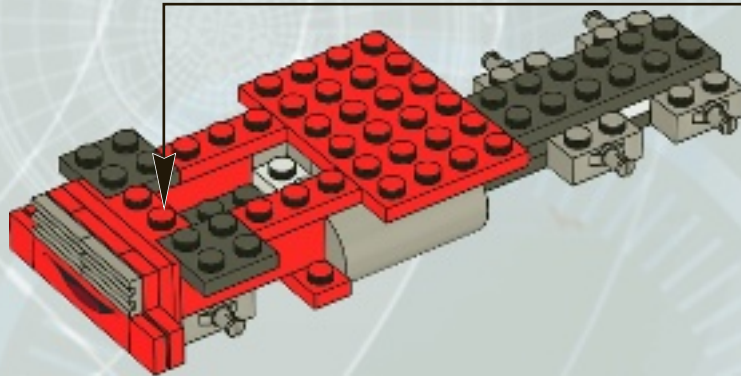
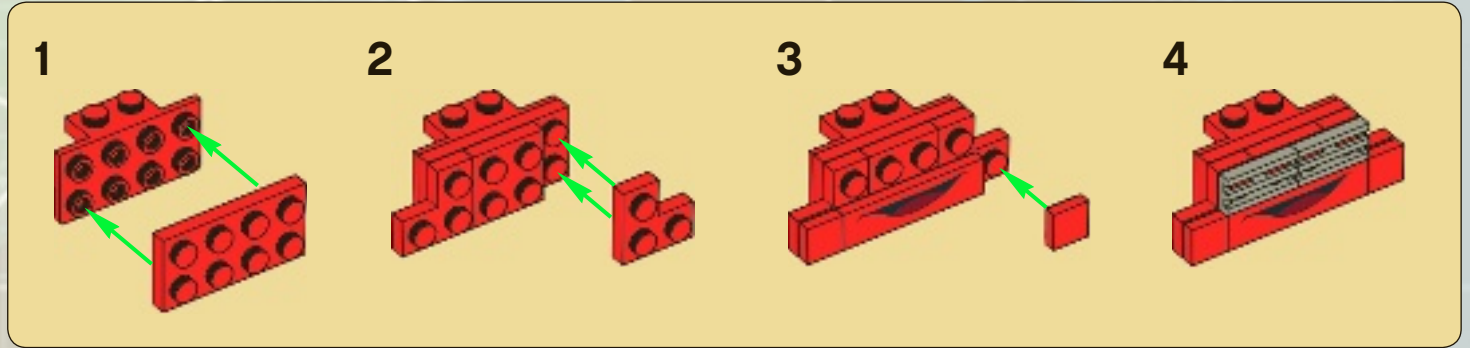

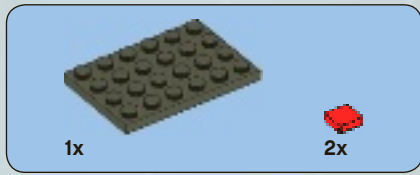

14

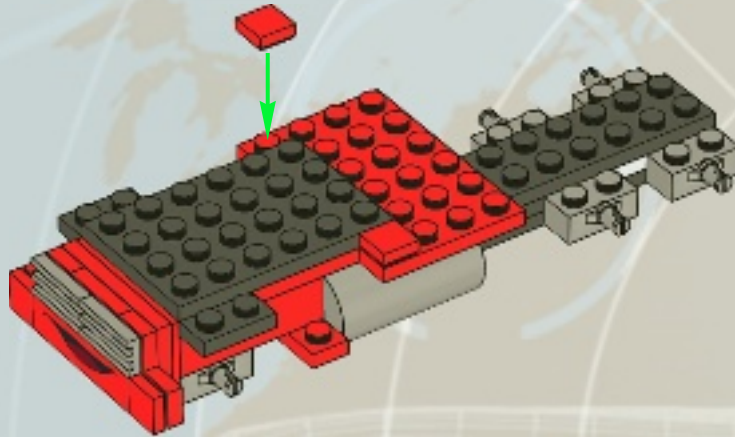

15

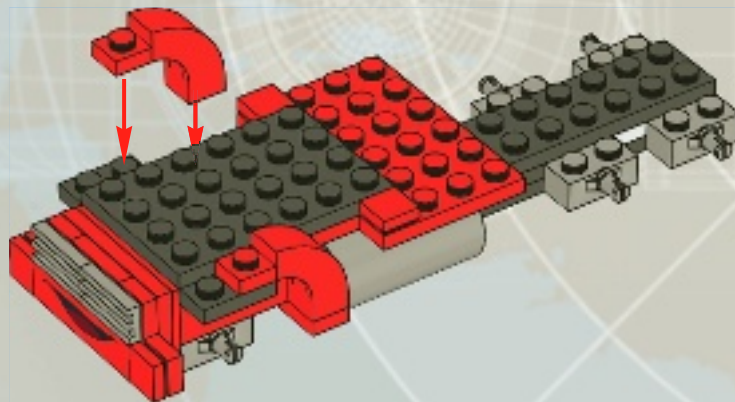



2x

# 16

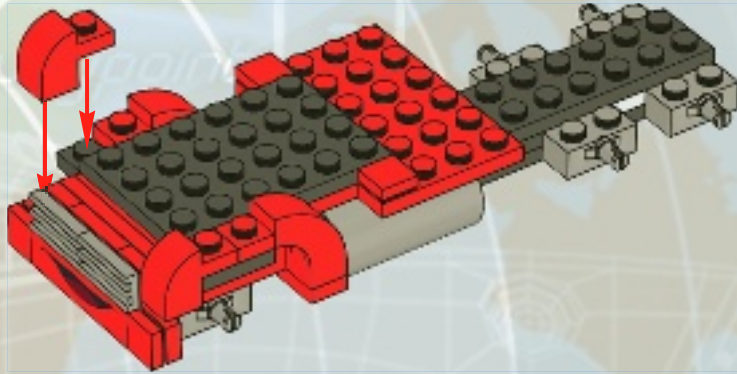

2x

# 17

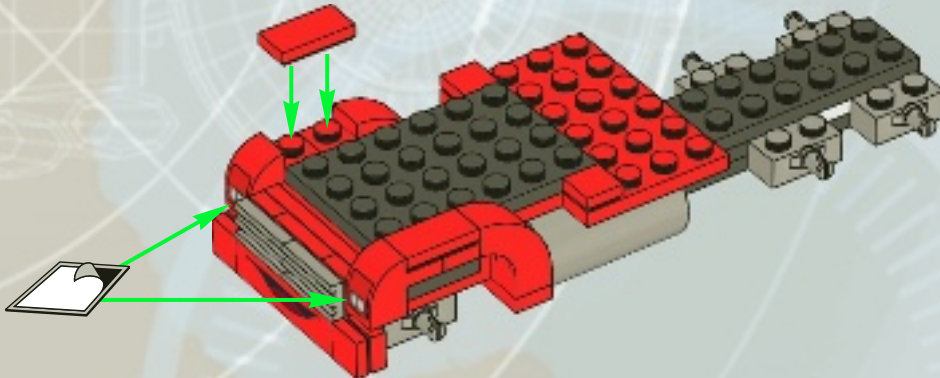

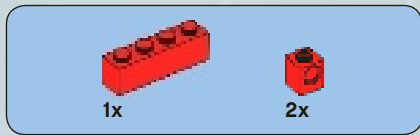

18

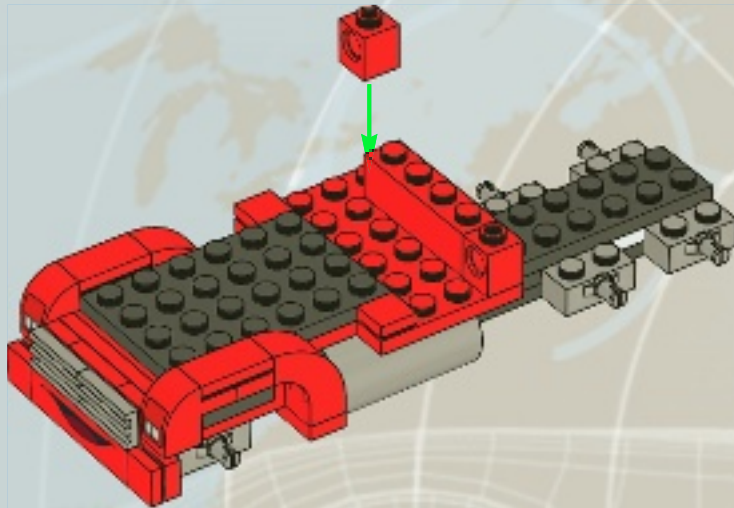

19

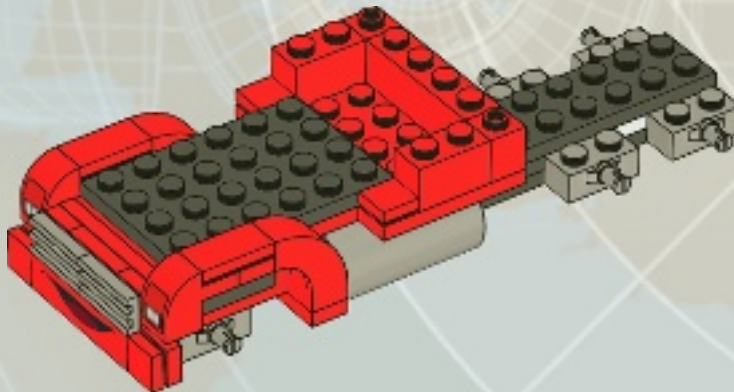

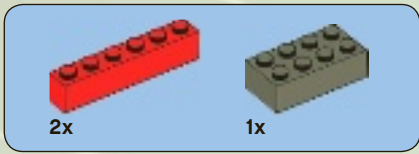

20

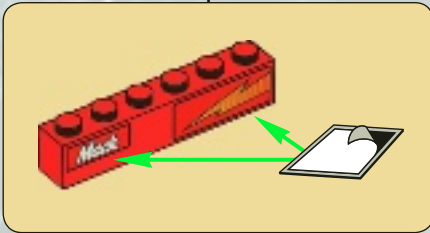
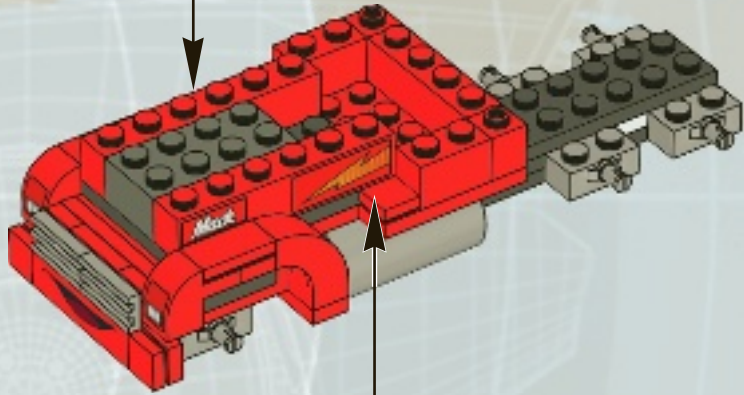
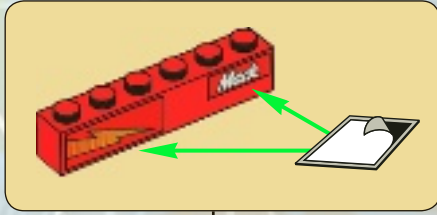



# 21

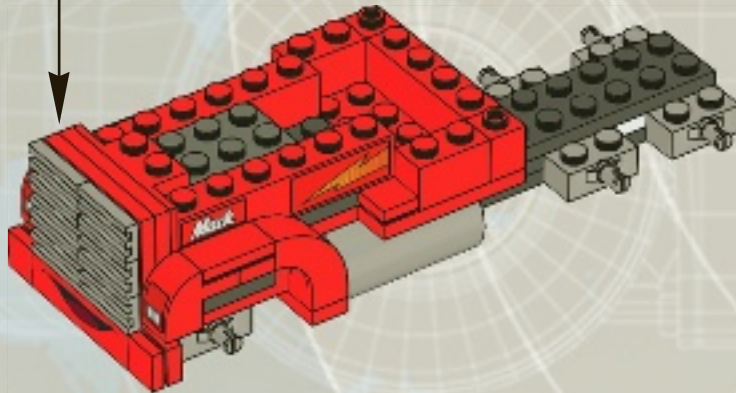
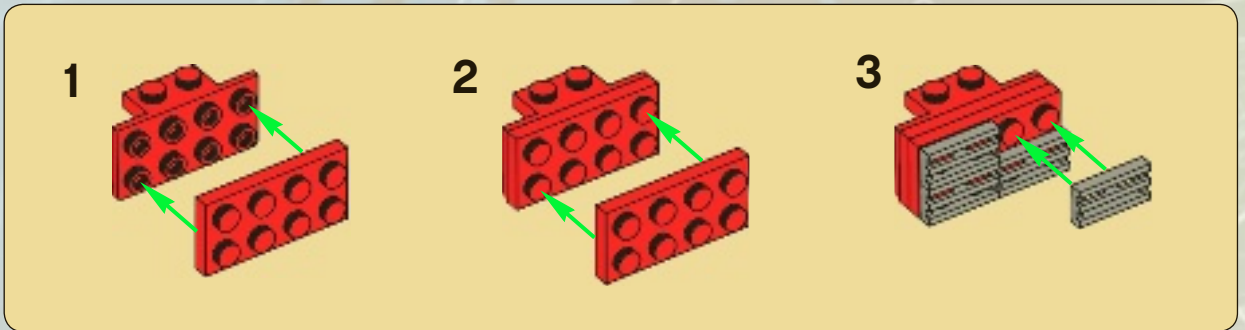



2x



2x



2x

# 22

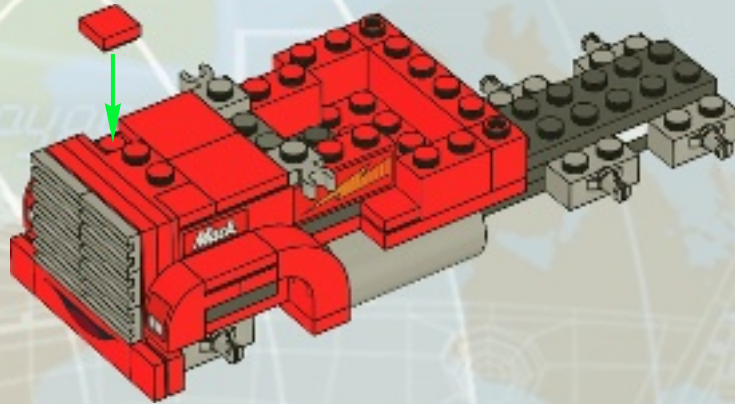

2x

# 23

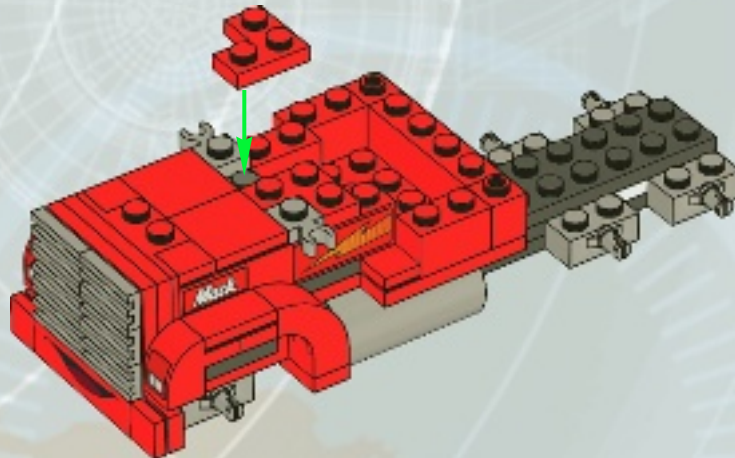



1x

# 24

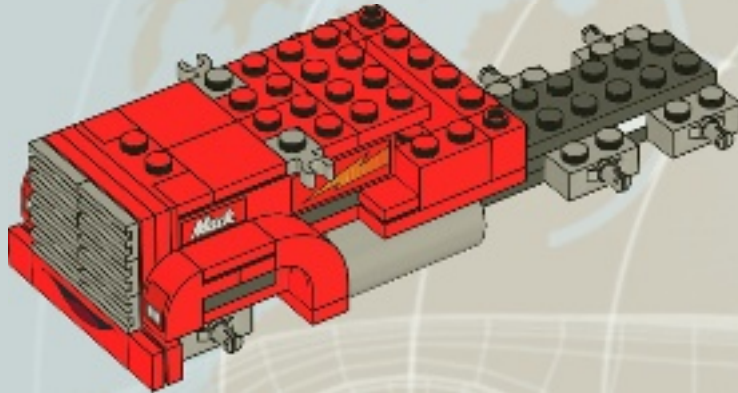

2x

# 25

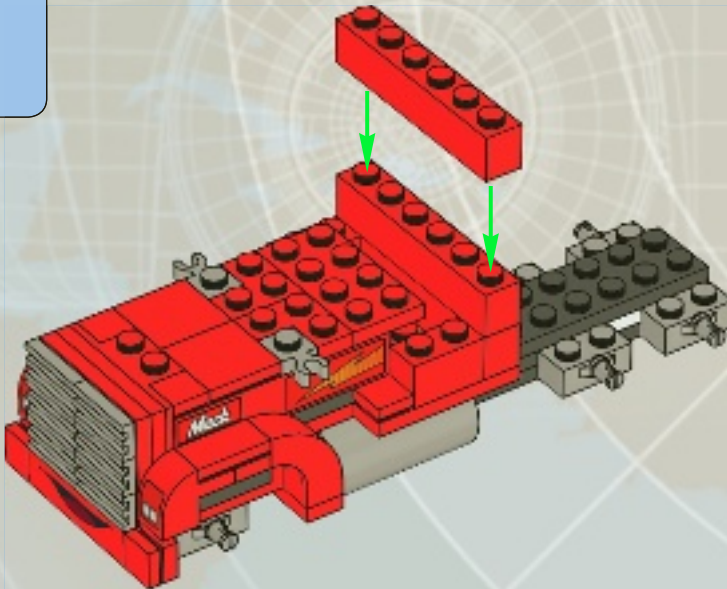





26

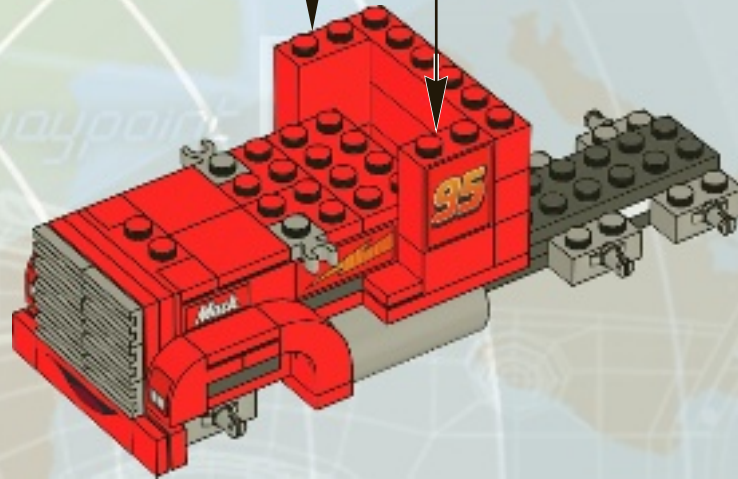

27

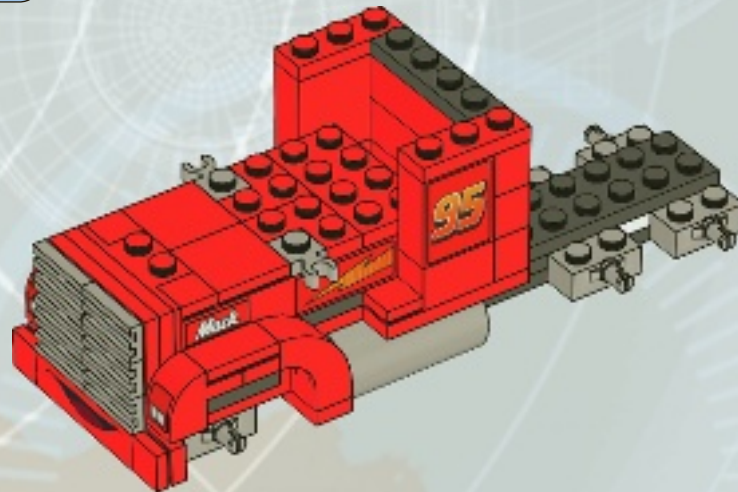

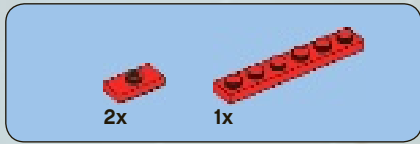

28

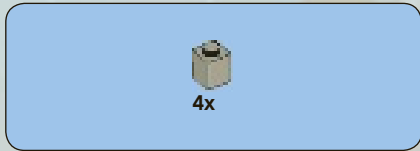
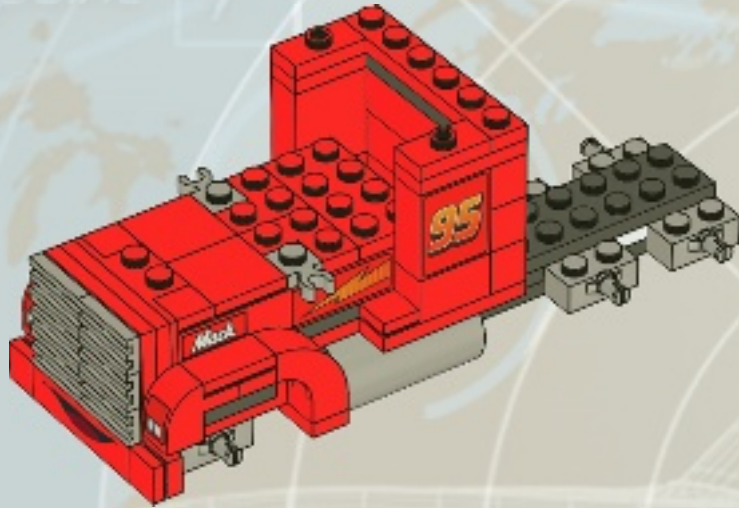

29

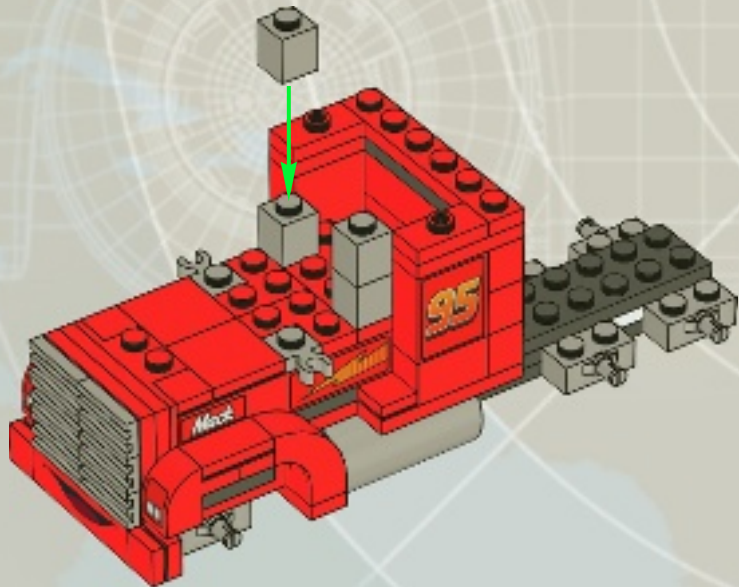

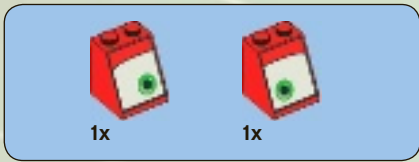

30

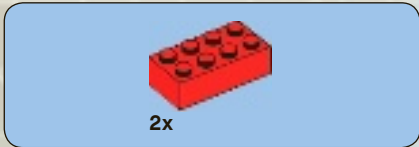
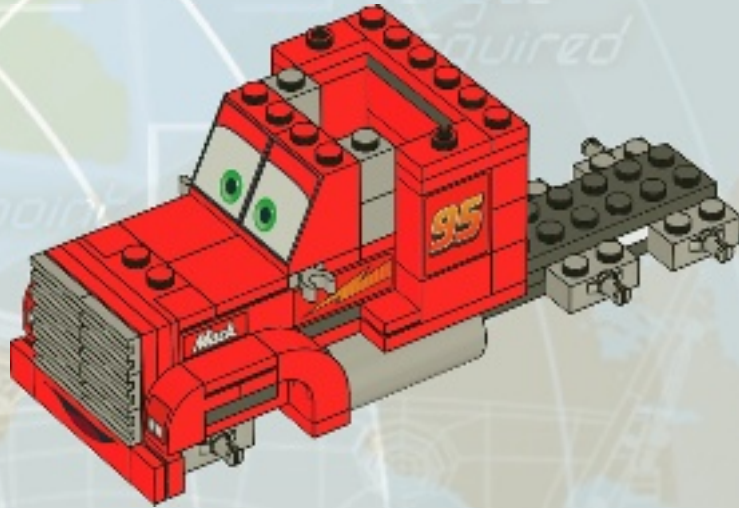

31

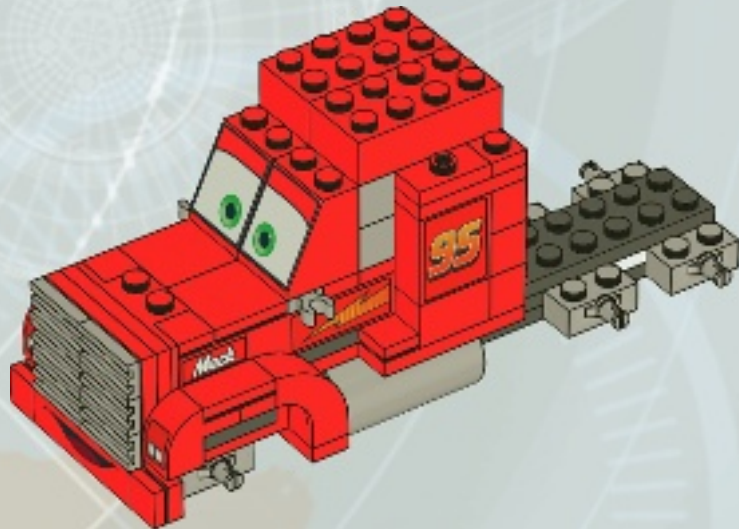

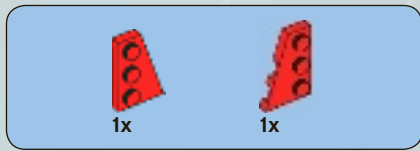

32

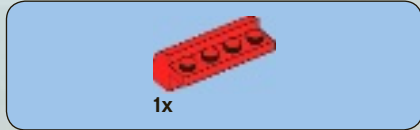
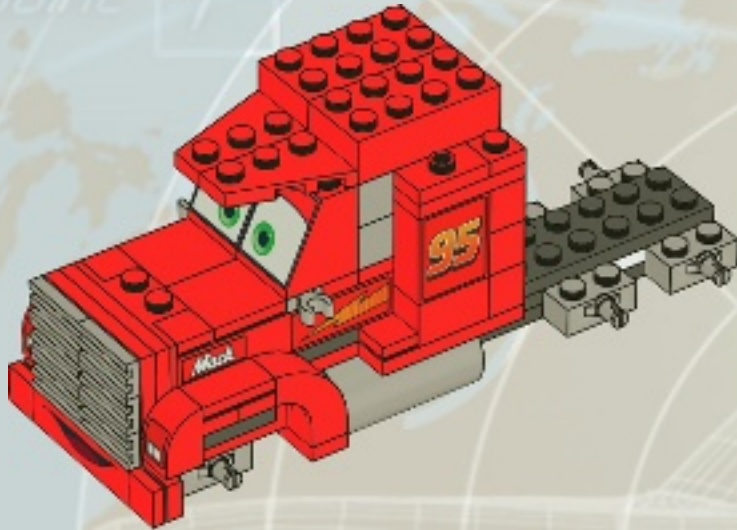

33

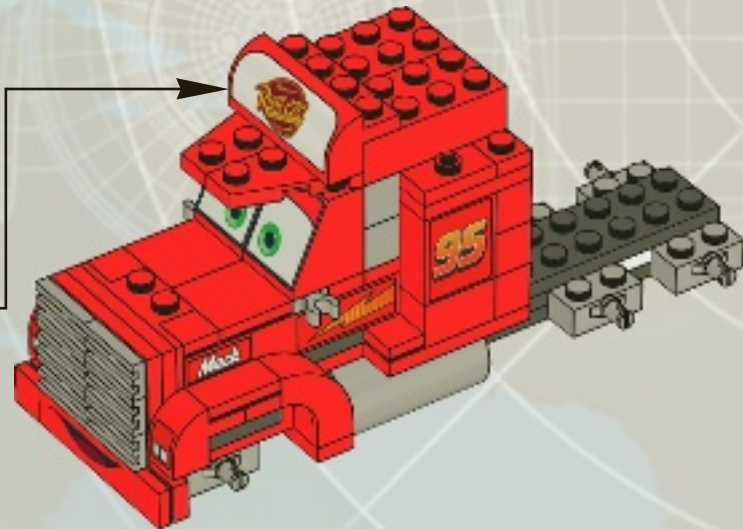



1x



2x

# 34

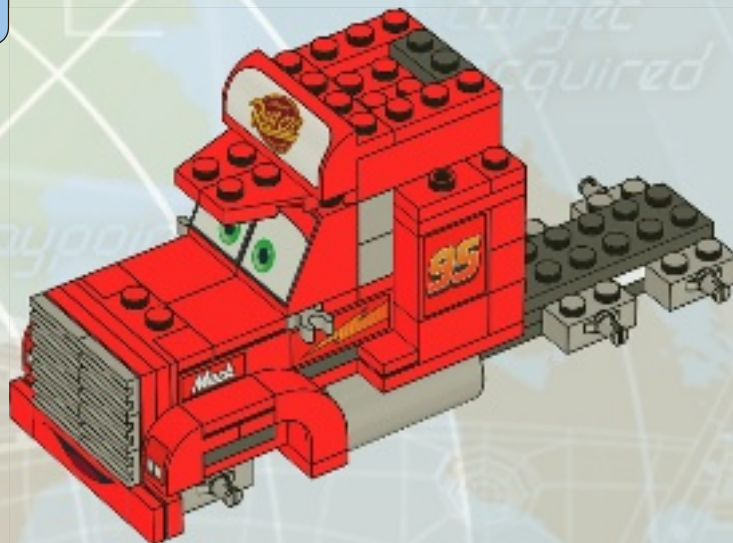

1x

# 35

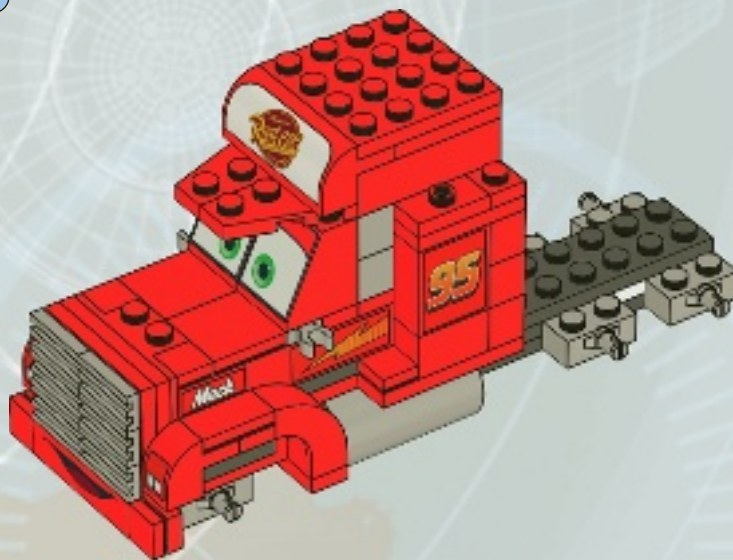

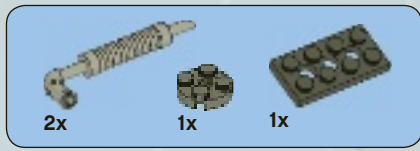

36

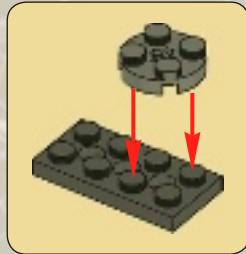
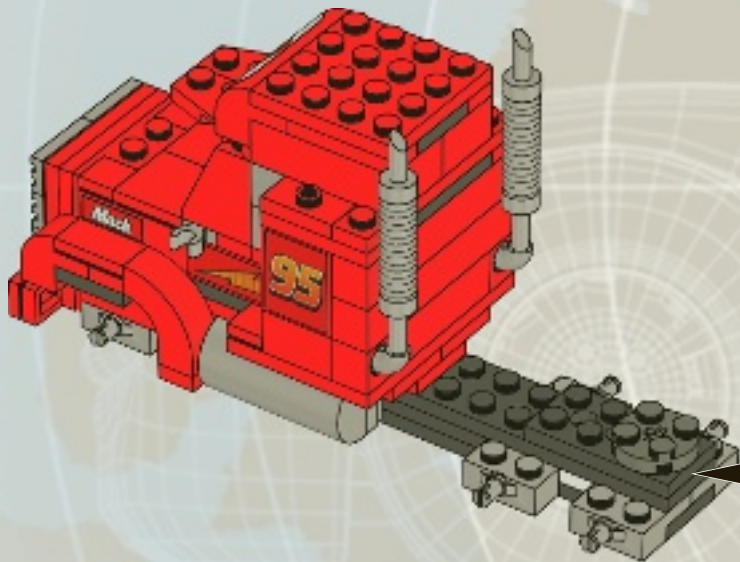



2x

37

target  
acquired

waypoint 2

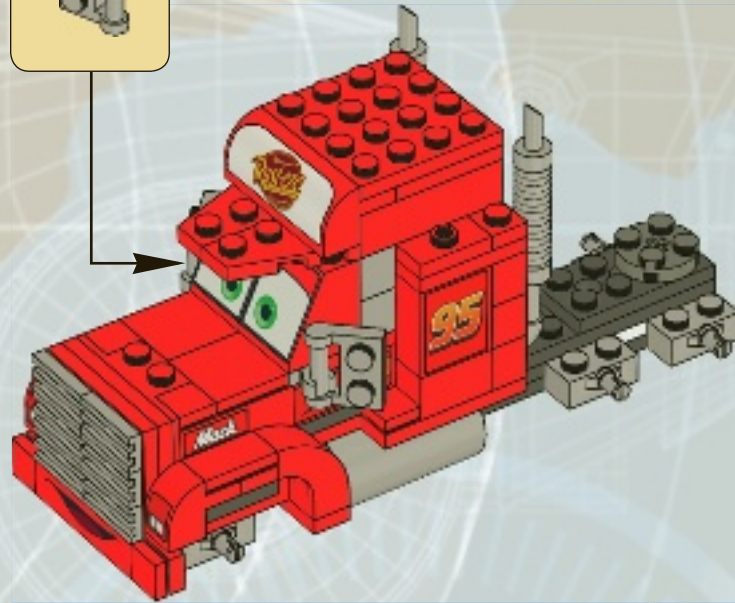



6x



6x

aypoint 1

# 38





8426



8484



8487





[www.LEGOclub.com](http://www.LEGOclub.com)



LEGO® Club Email

**LEGO club**™

**FREE! GRATIS! GRATUIT!**



LEGO® Club Magazine

 [www.LEGO.com](http://www.LEGO.com)

**SIGN UP ONLINE!**

**[www.LEGOclub.com](http://www.LEGOclub.com)**



**00800 5346 5555\***



**1-866-534-6258 • 1-877-518-5346**

US & Canada only

Canada seulement

\* Freephone. Mobile charges may apply.  
\* Numéro sans frais. Des frais peuvent s'appliquer avec les téléphones cellulaires.  
\* Gebührenfrei, Kosten für Anrufe aus Mobilfunknetzen können abweichen.  
\* Gratis telefonnummer vanaf vaste lijn.  
\* Det er et gratis nummer, når du ringer fra fasttelefon.  
\* Det är gratis, när du ringer från en fast telefon.  
\* Numéro sans frais. Des frais peuvent s'appliquer avec les téléphones portables.



**YES! I want to join the LEGO® Club FREE! OUI ! Je veux m'abonner au LEGO® Club GRATUITEMENT !**  
**Ja! Ich möchte Mitglied im kostenlosen LEGO® Club werden. Ja! Ik wil graag GRATIS lid worden van de LEGO® Club.**  
**Ja! Jeg ønsker å melde meg inn i LEGO® Club gratis! Ja! Jag vill gå med i LEGO® Club GRATIS!**

First name • Prénom  
 Vorname • Voornaam  
 Fornavn • Förnamn

Last name • Nom de famille  
 Name • Achternaam  
 Etternavn • Efternamn

Date of Birth • Date de naissance  
 Geburtstag • Geboortedatum  
 Födelsdato • Födelsedato







Boy • Garçon • Junge •   
 Jongen • Gutt • Pojke

Girl • Fille Mädchen •   
 Meisje • Jente • Flicka

Street • Adresse  
 Straße, Hausnr.  
 Straat, huisnr. •  
 Address

City • Ville  
 Ort • Woonplaats  
 Poststed • Postort

State  
 Prov.  
 County

Zip/Postcode • Code  
 Postal • PLZ • Postcode •  
 Postnummer

Country  
 Pays •  
 Land

Email • Courriel •  
 E-Mail • E-post

Mail to: / Poster à:  
 LEGO® Club  
 P.O. Box 1157  
 Enfield, CT USA  
 06083-1157

Mail to:  
 LEGO® Club  
 33 Bath Road  
 Slough SL1 3UF  
 United Kingdom

Per Post an:  
 LEGO® Club  
 Postfach 14 15  
 D-36243 Niederaula

Stuur op naar:  
 LEGO® Club  
 Postbus 40250  
 3504 AB Utrecht

Poster à:  
 LEGO® Club  
 21 rue de la banque  
 75 002 PARIS  
 FRANCE

Send til:  
 LEGO® Club Norge  
 Postboks 58  
 1314 Vøyenenga

Skickas till:  
 LEGO® Club Sverige  
 Ubox 841  
 202 29 Malmö

- Fill in your email address and we will send you a membership confirmation and monthly email newsletters. If you do not wish to receive the newsletters please tick here. Rempilis ton adresse e-mail et nous t'enversons une confirmation d'adhésion ainsi que le bulletin e-mail mensuel. Si tu ne désires pas recevoir le bulletin, coche cette case. Vul je e-mailadres in en we sturen je een bevestiging van je lidmaatschap en maandelijkse e-mail nieuwsbrieven. Als je geen e-mail wilt ontvangen, kruis dan dit vakje aan.
- Ich möchte per E-Mail den monatlichen LEGO Club Newsletter erhalten. Ønsker du at vi skal sende en liten hilsen til barnet ditt for å bekrefte medlemskapet, ber vi deg kryss av i feltet, samt oppgi e-postadressen som hilsenen skal sendes til. Om du vill att vi ska skicka en bekräftelse på ditt barns medlemskap, ber vi dig sätta ett kryss i rutan och skriva den e-post adress som bekräftelsen ska skickas till.
- If you do not wish to receive additional mailings from the LEGO Club please tick here. Si tu ne désires pas recevoir de courrier supplémentaire du Club LEGO, coche cette case. Als je geen verdere post van de LEGO Club wilt ontvangen, kruis dan dit vakje aan.
- Dersom du ønsker å motta annen informasjon fra LEGO Gruppen, setter du et kryss her.

 The English language version of the magazine can only be mailed to addresses in the US, Canada, the UK, and Republic of Ireland. Club membership is valid for two years and includes free copies of the LEGO Club Magazine and e-mail newsletters. In the US and Canada please allow up to 6 weeks for delivery of your first magazine. In the UK and Republic of Ireland please allow six to 14 weeks for delivery of your first magazine. By signing this form you consent the LEGO Club to use your child's data for LEGO mailings. The data will only be used for LEGO mailings and will not be sold, rented or otherwise disclosed to any company outside the LEGO Company except for disclosure to companies acting as our agents to help us provide services requested by the child. This coupon is valid for one free membership per person, group or organization. Photocopied coupons are accepted.  La version française du magazine peut être postée uniquement au Canada. L'abonnement est valide pour 2 ans et inclut des exemplaires gratuits du Magazine LEGO. Aux É.-U. et au Canada, allouer 6 semaines pour la livraison initiale. En remplissant ce formulaire, vous consentez à ce que LEGO utilise les informations de votre enfant pour des envois postaux de LEGO. L'information sera utilisée uniquement pour des envois postaux par LEGO et ne sera en aucun cas, vendue, louée, échangée ou divulguée à d'autres compagnies autres que la compagnie LEGO, à l'exception des compagnies affiliées qui nous procurent des services auxquels l'enfant a fait la demande. Formulaire photocopiés acceptés.  Mit der folgenden Unterschrift erkläre ich, für mein Kind den Beitritt als Mitglied zum kostenlosen LEGO Club, der von der LEGO GmbH, D-85627 Grasbrunn, betrieben wird. Die Mitgliedschaft beinhaltet die Zusendung des LEGO Club Magazines und kann beiderseits jederzeit beendet werden. Mit der Mitgliedschaft im LEGO Club sind keinerlei Verpflichtungen verbunden. Das deutschsprachige LEGO Club Magazin wird nur an Adressen in Deutschland, Österreich und der Schweiz versendet. Eine Anmeldebestätigung kann nur per E-Mail geschickt werden. Das Magazin erscheint fünfmal jährlich. Daher kann die Zustellung des ersten Heftes bis zu drei Monate dauern. Die Mitgliedschaft ist beidseitig jederzeit kündbar, ohne dass Ihnen Kosten entstehen. Sie können der werblichen Nutzung Ihrer Daten jederzeit widersprechen. Kündigung und Widerspruch können Sie telefonisch erklären (00800 / 5346 5555, Anruf gebührenfrei, Kosten für Anrufe aus dem Mobilfunknetz können abweichen) oder an die LEGO GmbH senden.  Het Nederlandse LEGO Club Magazine kan alleen worden gestuurd naar adressen in Nederland. Het lidmaatschap is 2 jaar geldig en geeft recht op toezending van het gratis LEGO Club Magazine en LEGO Club e-mails. Het eerste magazine zal binnen 12 tot 14 weken toegestuurd worden. Het lidmaatschap kan op ieder moment opgezegd worden en kan na 2 jaar gratis worden verlengd, tenzij LEGO met deze activiteit stopt. Uw gegevens worden uitsluitend gebruikt voor mailings van LEGO en zullen niet worden verkocht, verhuurd of op welke wijze dan ook verstrekt aan derden buiten de LEGO Groep, uitgezonderd de organisaties die namens ons optreden om de informatie te sturen waarvoor toestemming is verleend.  Den norske utgaven av magasinet sendes kun til adresser i Norge. Medlemskap i klubben gjelder i 2 år og inkluderer gratisutgaver av LEGO Club Magazine. Påregning minimum opp til seks uker leveringstid for første magasin. Ved å undertegne dette skjemaet, gir du ditt samtykke til at LEGO Club kan bruke opplysningene om barnet ditt i LEGO forsendelser. Dataene vil utelukkende bli brukt i LEGO forsendelser og vil ikke bli solgt, utleid eller på annen måte gjøres tilgjengelig for selskaper utenfor LEGO gruppen, unntatt selskaper som er våre agenter og som hjelper oss å tilby tjenestene barnet etterspør. Dette skjemaet gjelder for ett gratis medlemskap per person, gruppe eller organisasjon.  Den svenska versionen av tidsningen kan endast skickas till adresser i Sverige. Club-medlemskapet är giltigt i 2 år och innefattar gratis exemplar av LEGO Club Magazine. Vänligen räkna med minimum 6 veckor för leverans av din första tidning. Genom att skicka in det här formuläret godkänner du att LEGO Club använder barnets uppgifter för LEGO utskick. Uppgifterna kommer bara att användas för LEGO utskick och kommer inte att säljas, hyras ut eller vidarebefordras till något företag som inte tillhör LEGO Gruppen, med undantag av företag som agerar som våra ombud för att tillhandahålla tjänster som barnet har begärt. Den här kupongen gäller för ett gratis medlemskap per person, grupp eller organisation.  En complétant ce bulletin d'adhésion, vous acceptez que LEGO Club utilise les données relatives à votre enfant pour l'envoi de courriers concernant LEGO. Ces données seront uniquement utilisées pour l'envoi d'information concernant LEGO et ne seront ni vendues, ni louées, ni utilisées par d'autres sociétés que le groupe LEGO, à l'exception des sociétés agissant pour le compte de LEGO en tant que sous-traitant de services divers. L'abonnement au LEGO Club est valable pour une période de 2 ans. Il inclut l'envoi par courrier du magazine LEGO Club et par email des newsletters. Un délai de 6 à 14 semaines est à prévoir pour la réception de votre premier magazine. Ce bulletin d'adhésion gratuit est valable pour l'inscription d'une seule personne. Les photocopies sont acceptées. ATTENTION! Le bulletin d'adhésion doit être rempli et signé par un parent ou un tuteur.

Parent's signature • Signature d'un parent ou d'un tuteur  
 • Unterschrift Erziehungsberechtigte/r • Handtekening ouders  
 • Foreldres/foresattes underskrift • Förälders /förmyndares underskrift

Date  
 Datum  
 Dato

**LEGO**



8486



1

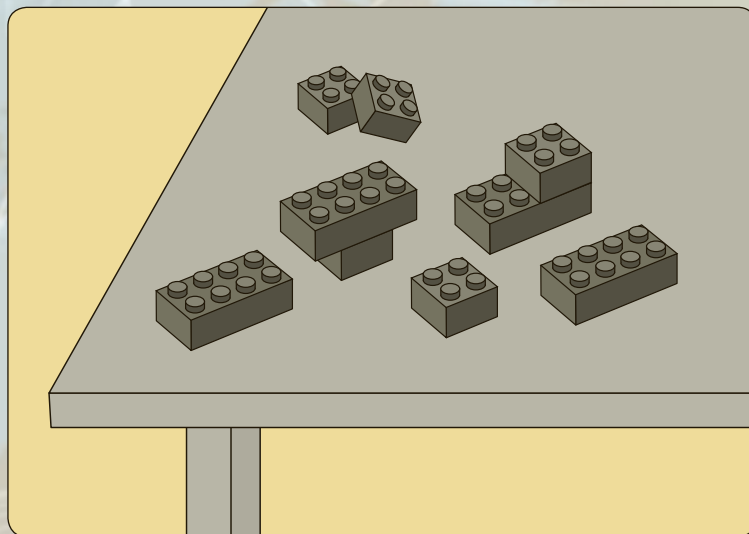
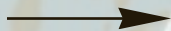
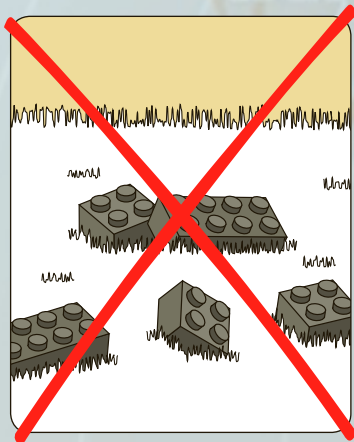

2



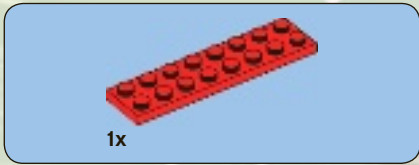

1

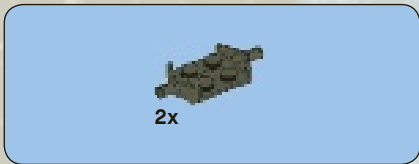

2

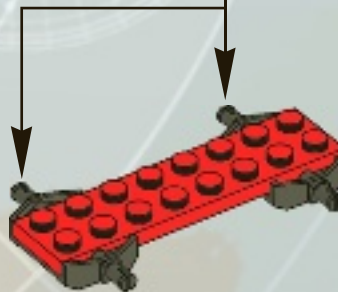



3

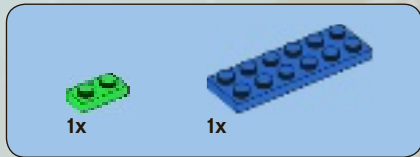
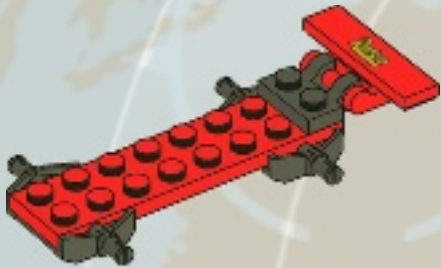
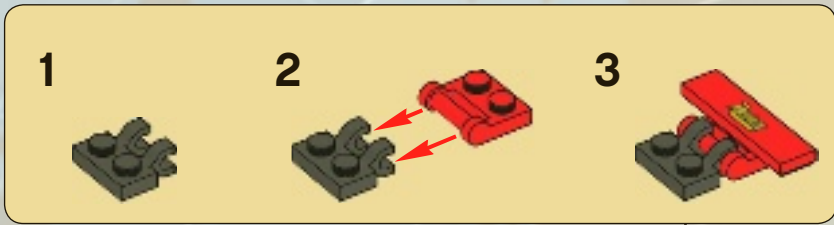

4

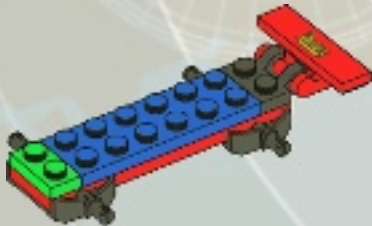





5

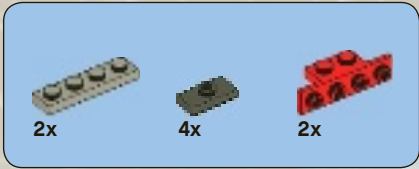
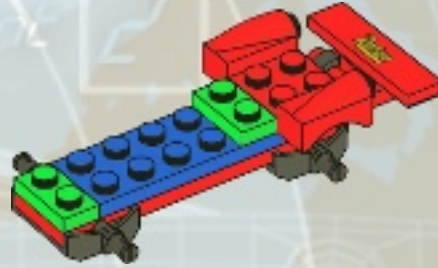

6

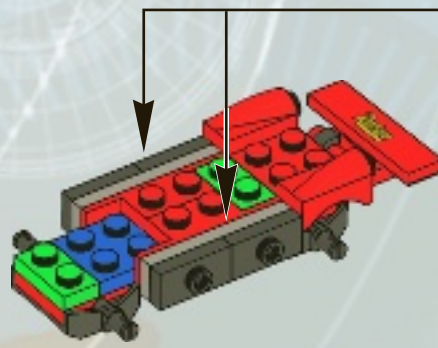
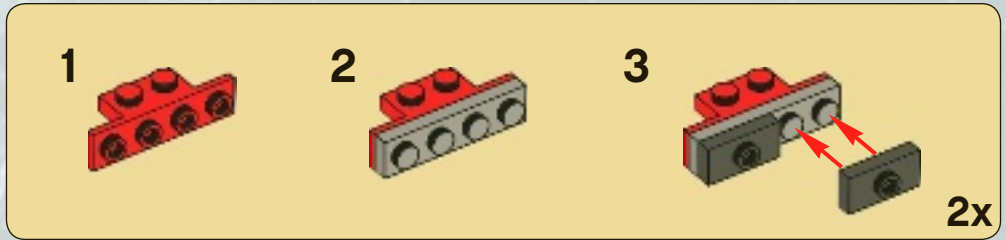



1x

aypoint 7

7

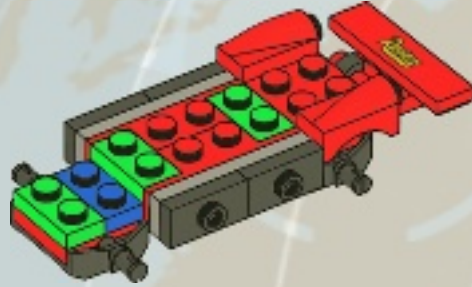

1x

8





1x



1x

9

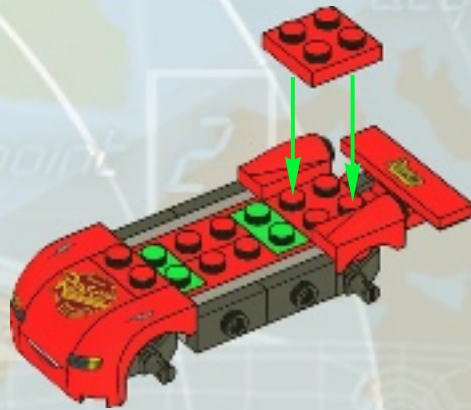

1x

10





4x



4x

# 11



1x



1x

# 12





13

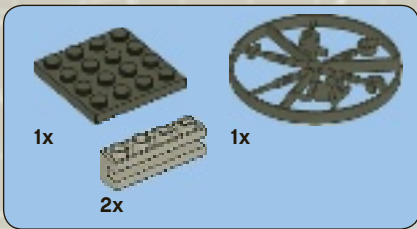
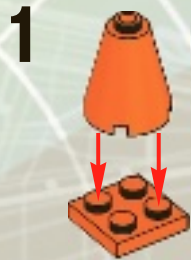
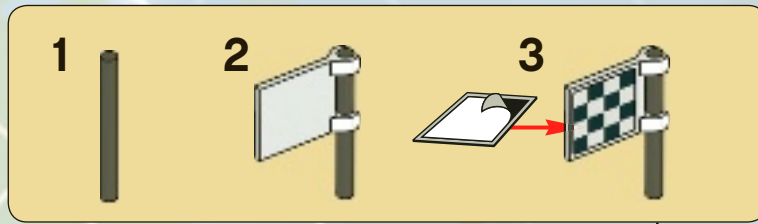

14

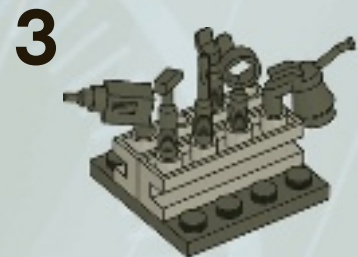
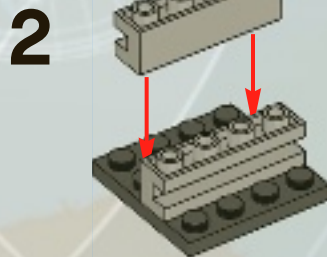

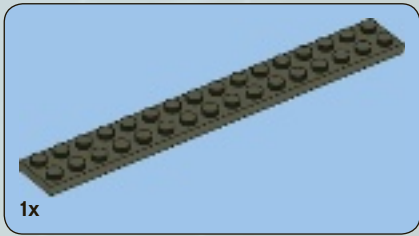
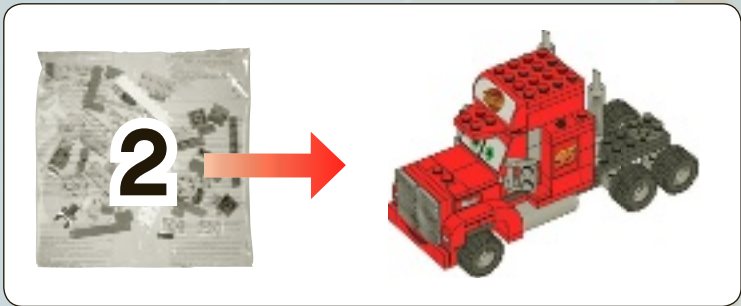

1

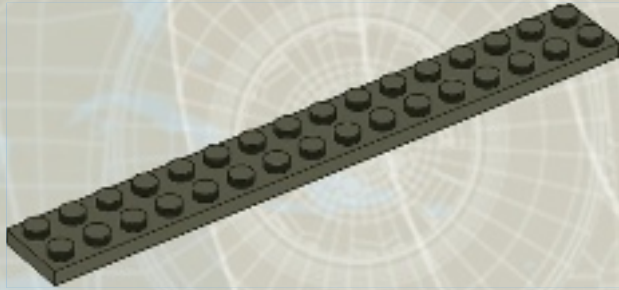



2x

2

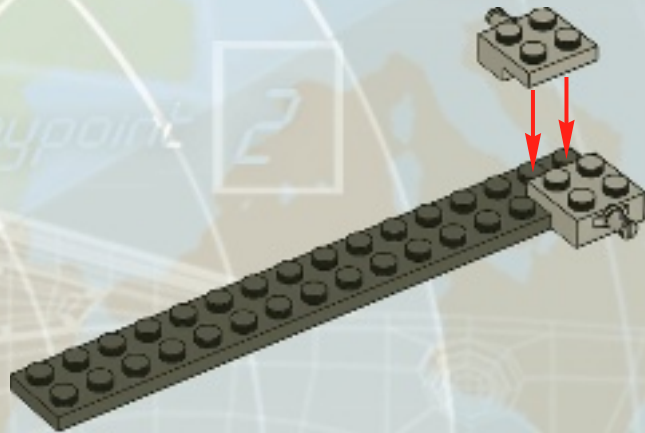

target  
acquired



1x



2x

3

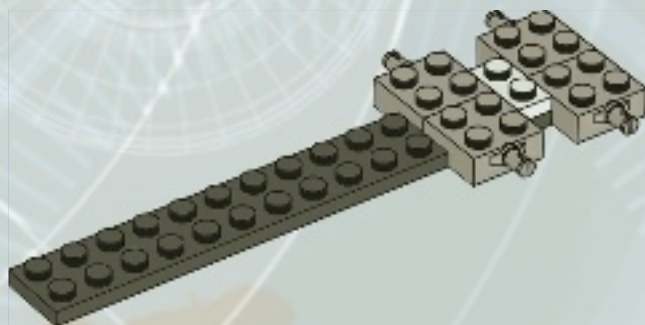



4

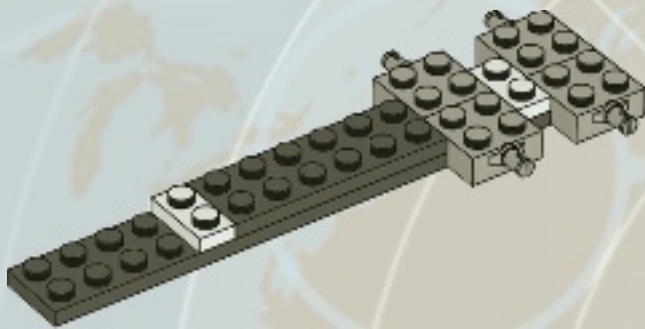

5

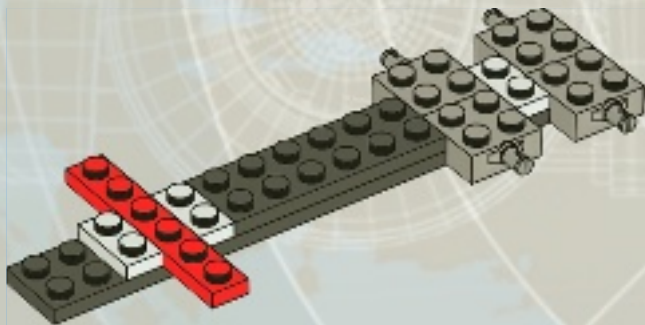





2x

6

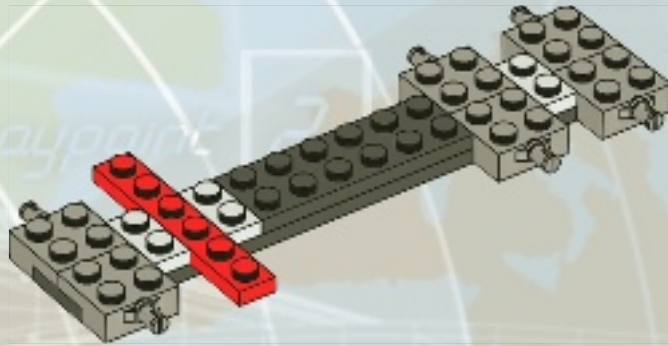

target  
acquired

waypoint 7



1x

7

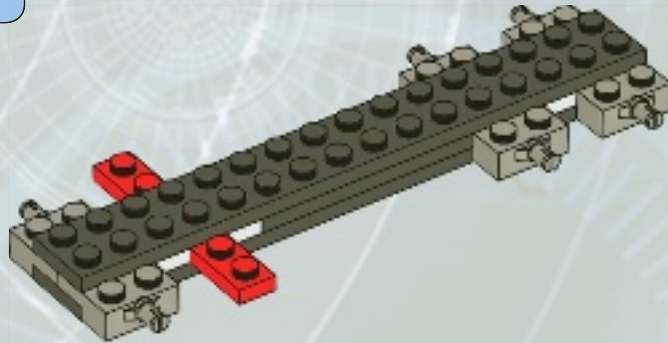



8

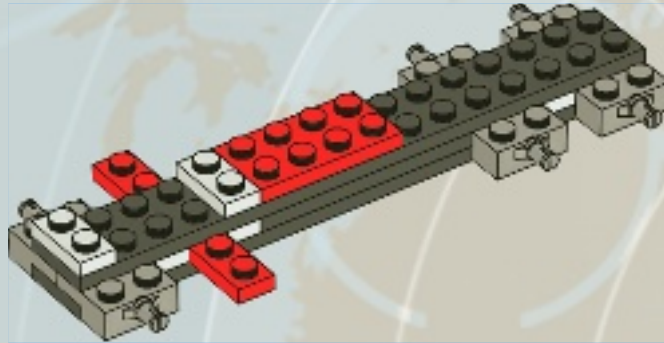

9

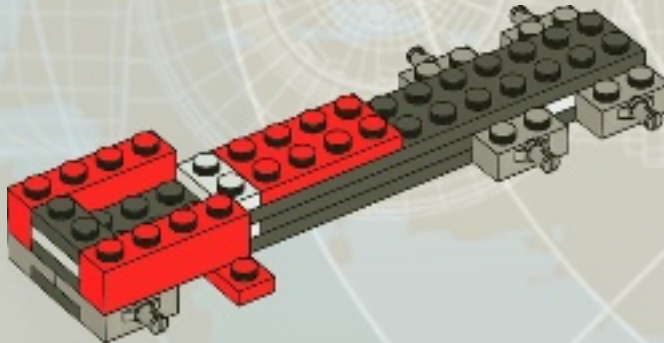



# 10

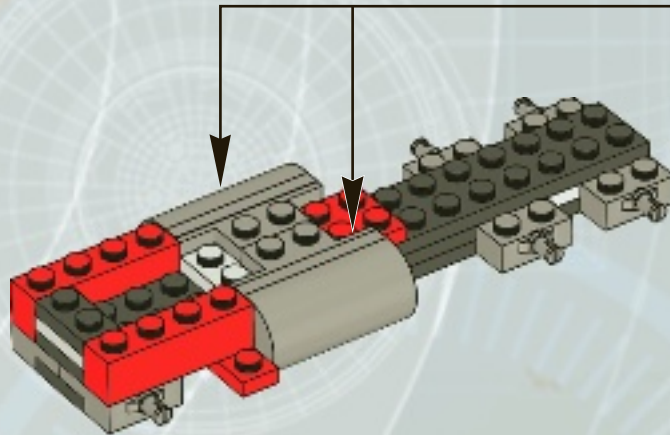
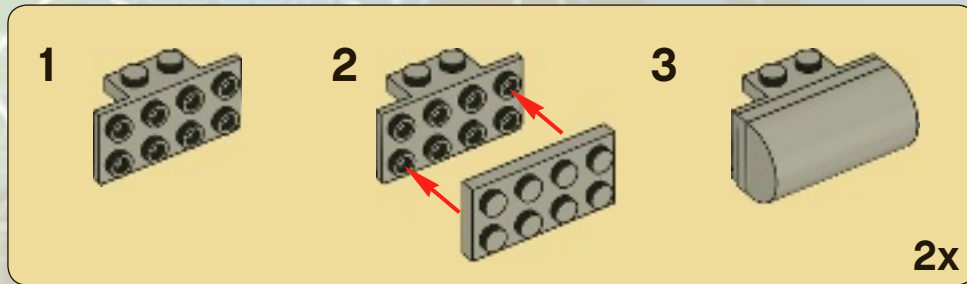



2x

# 11

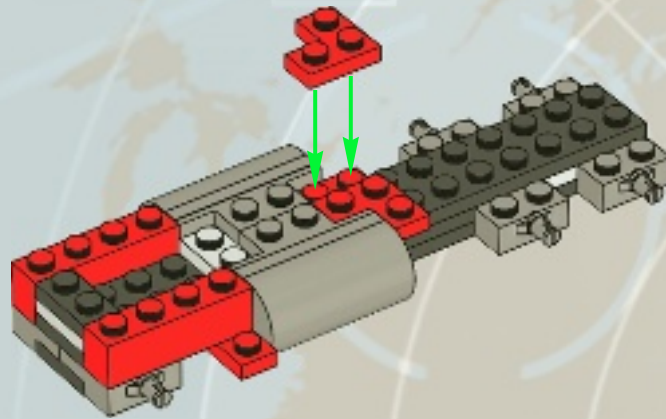

1x



2x



2x

# 12

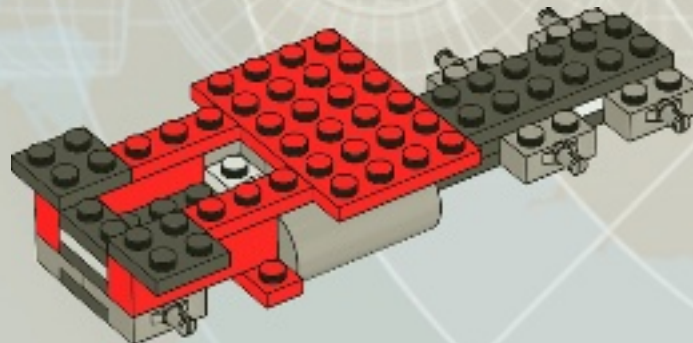

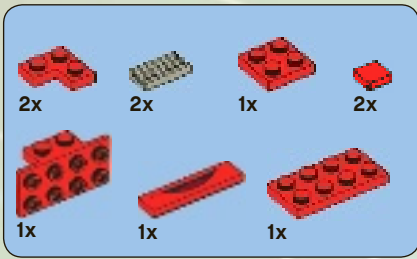

# 13

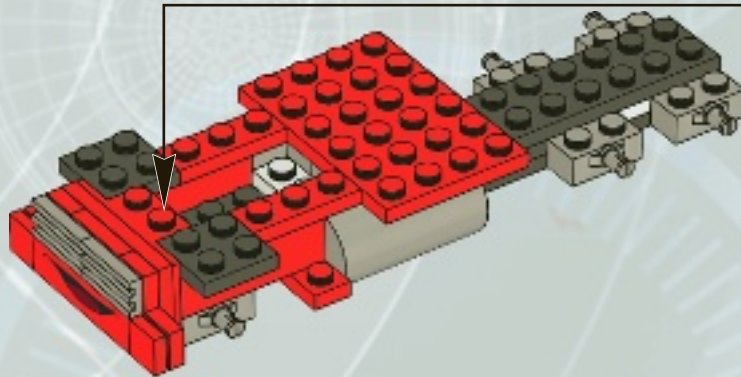
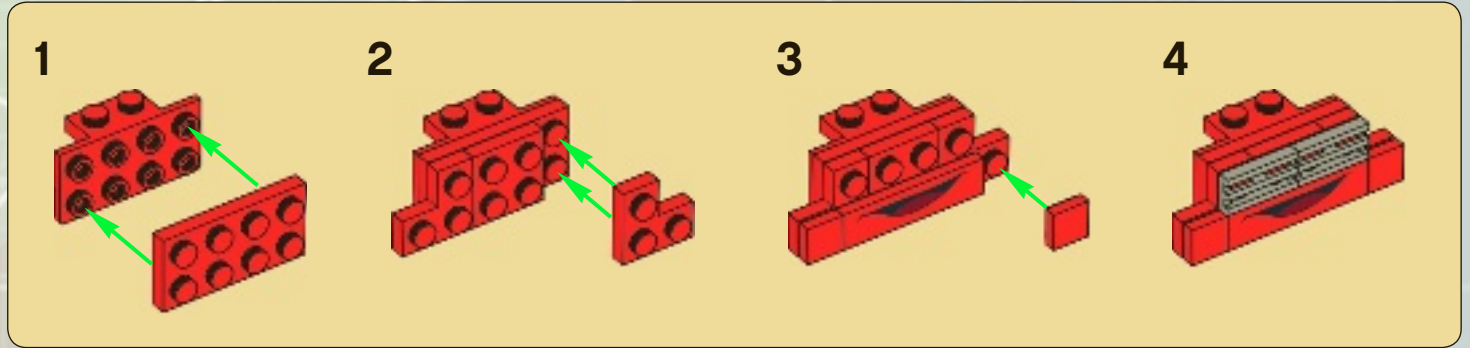



14

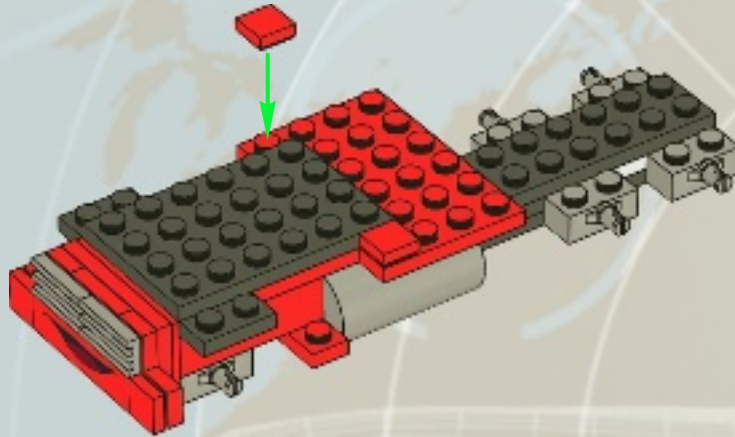

15

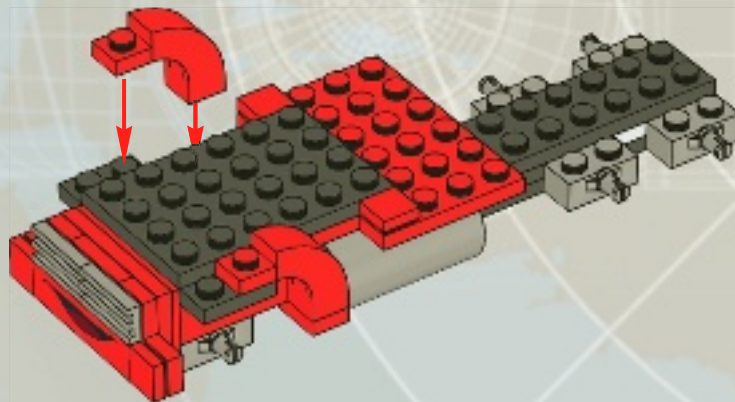



2x

# 16

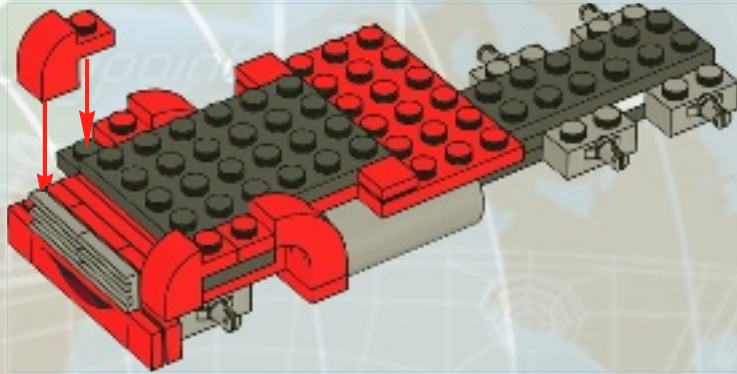

2x

# 17

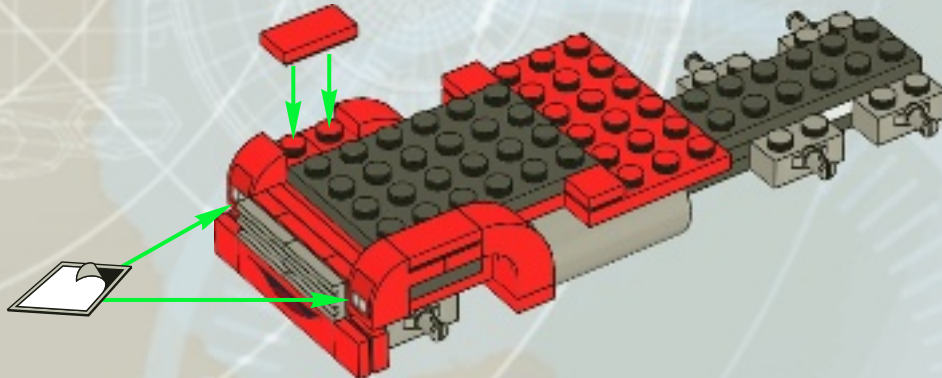

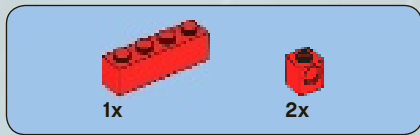

18

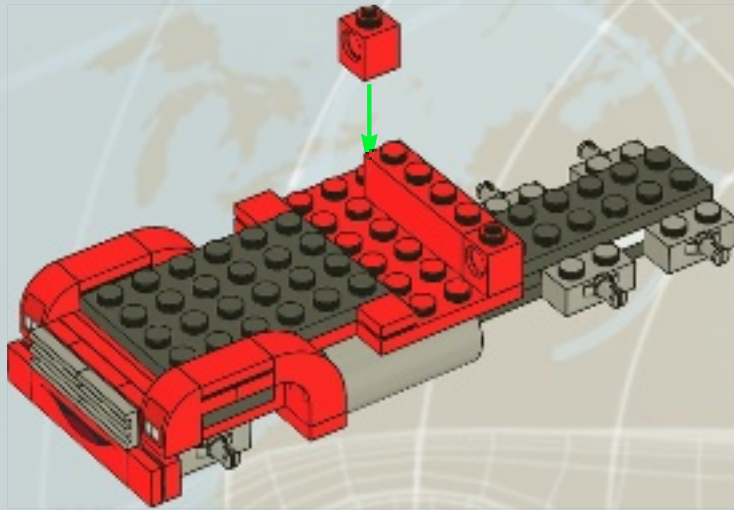

19

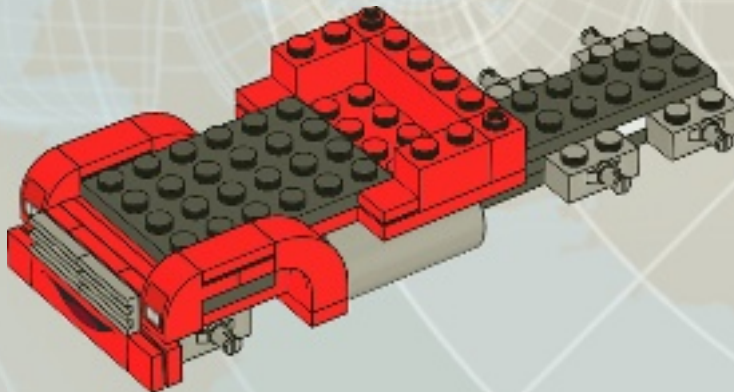



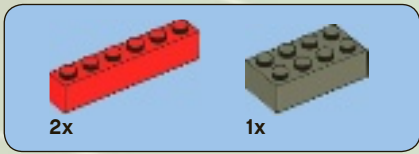

20

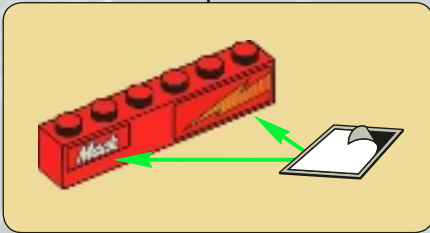
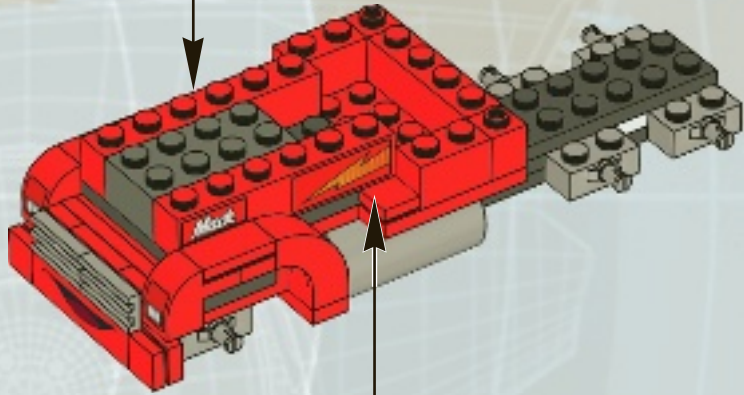
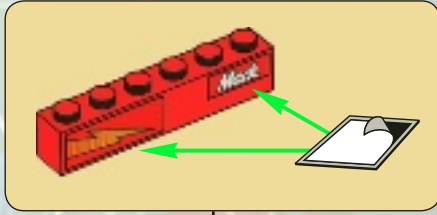



# 21

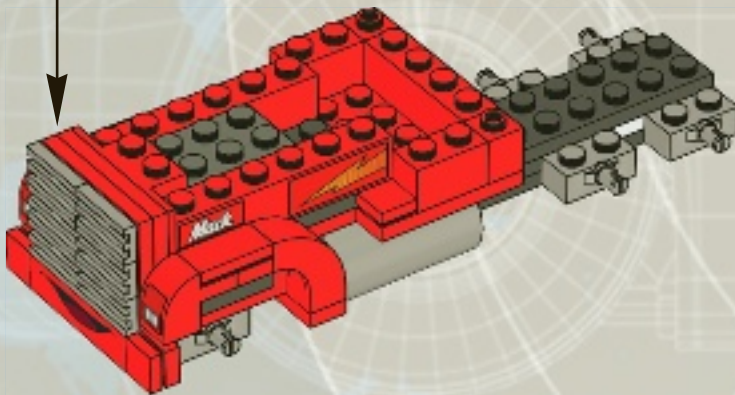
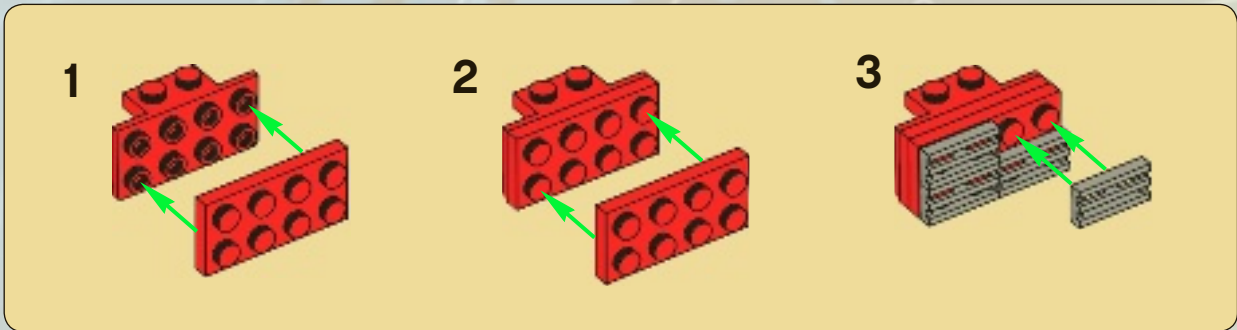



2x



2x



2x

# 22

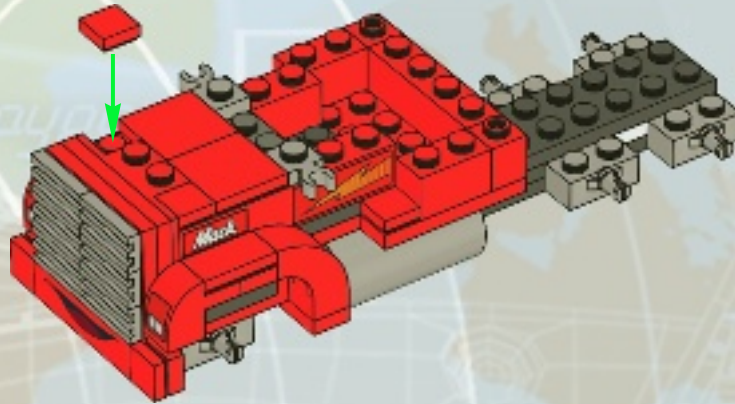

2x

# 23

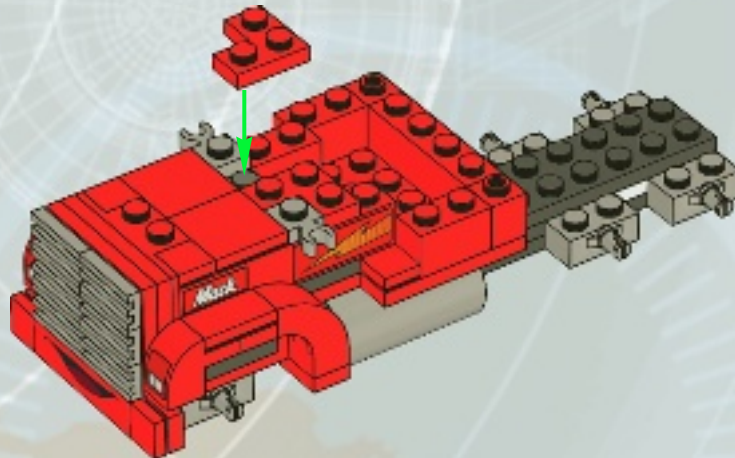



1x

# 24

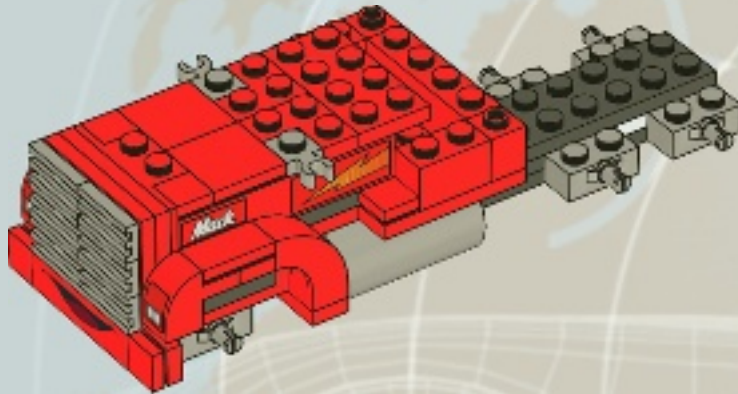

2x

# 25

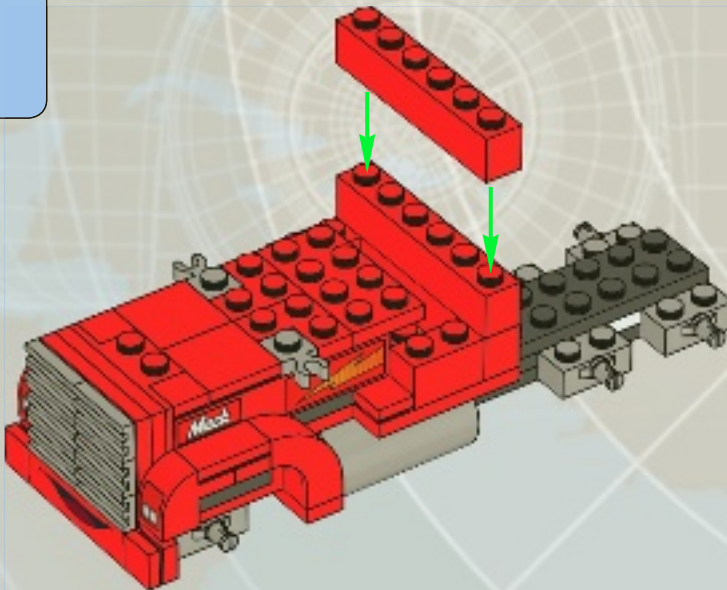



26

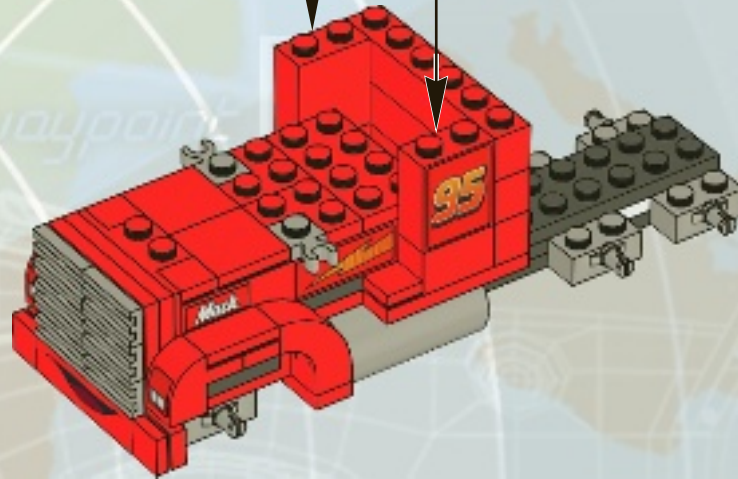

27

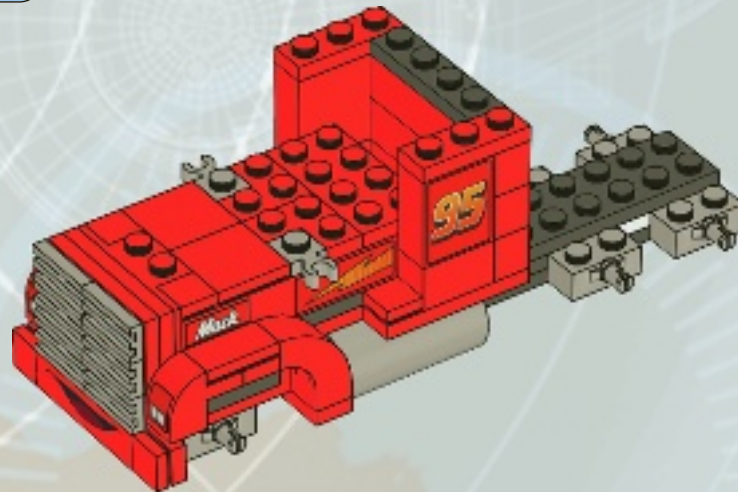

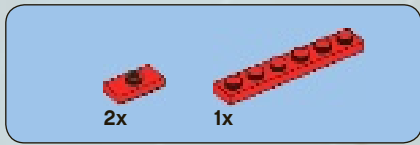

28

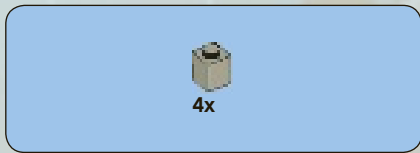
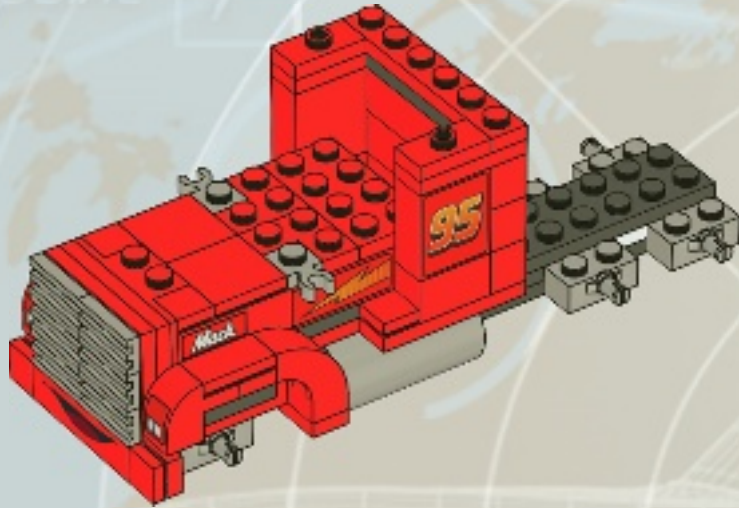

29

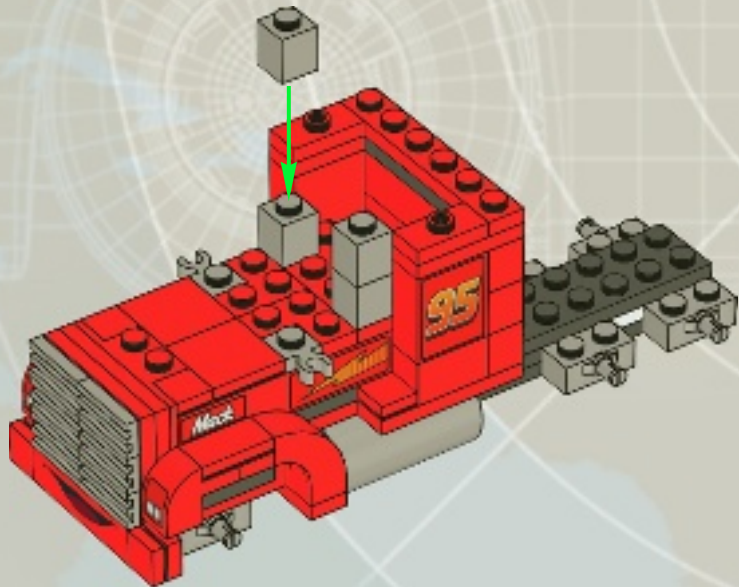

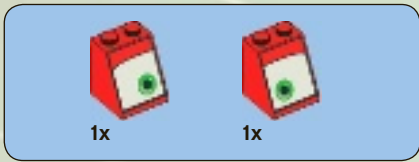

30

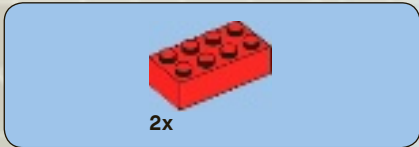
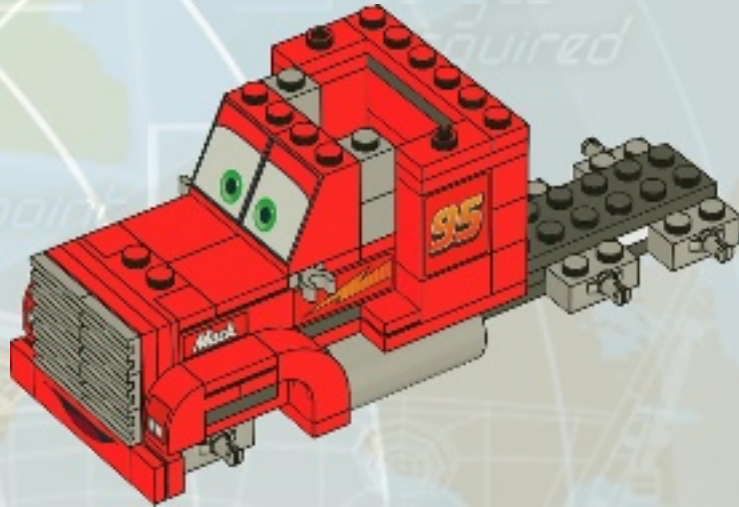

31

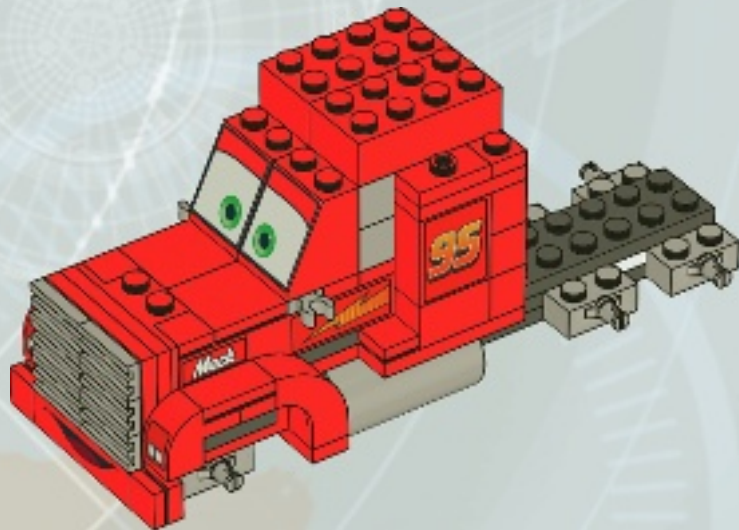

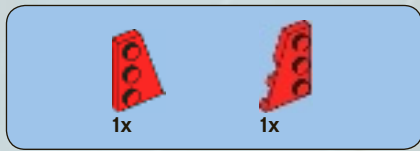

32

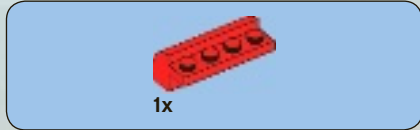
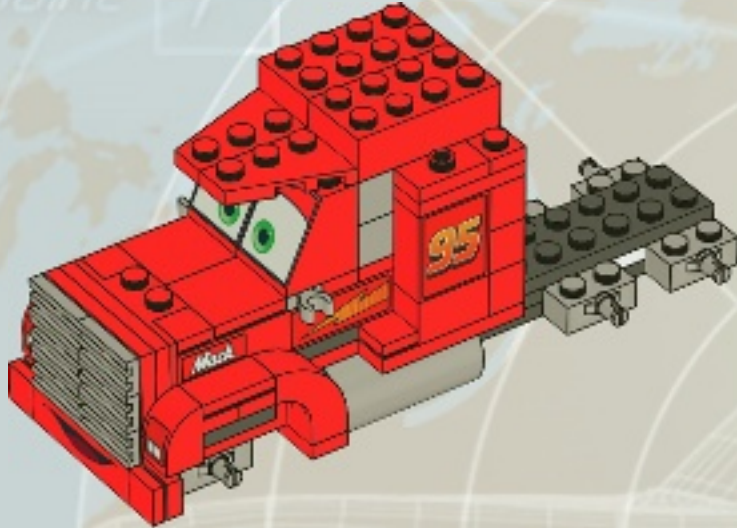

33

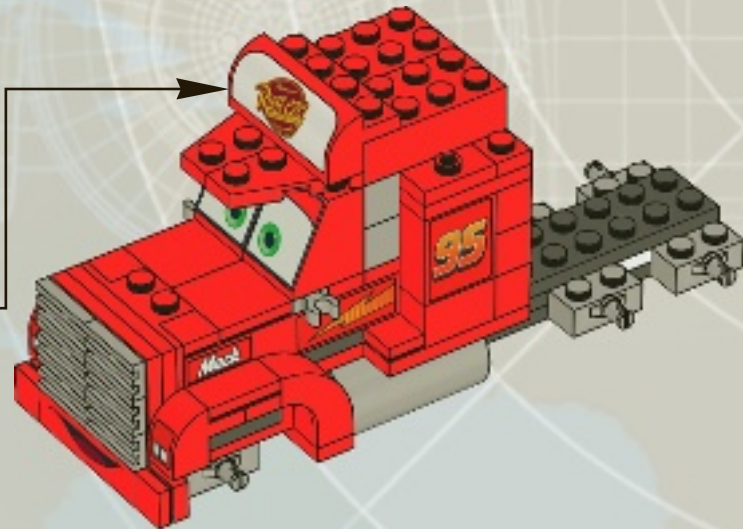





1x



2x

# 34

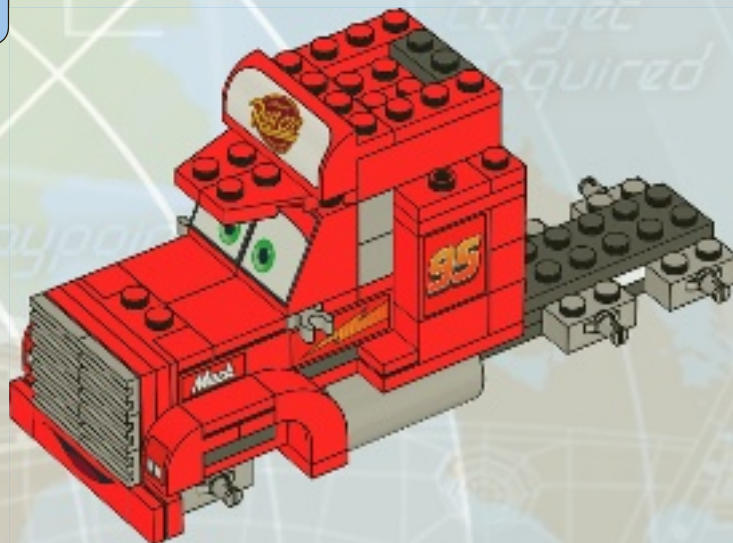

1x

# 35

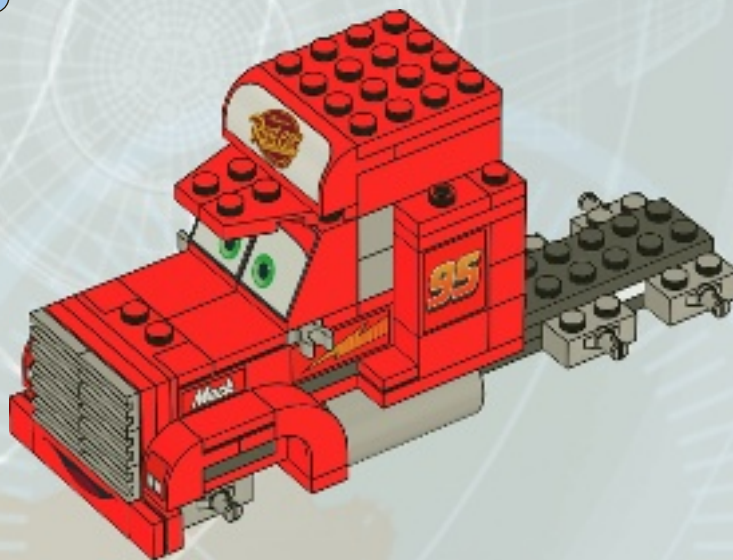

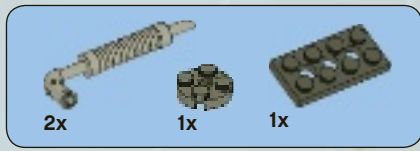

36

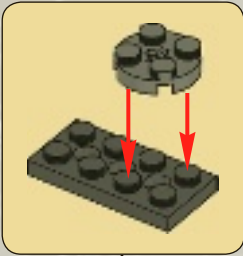
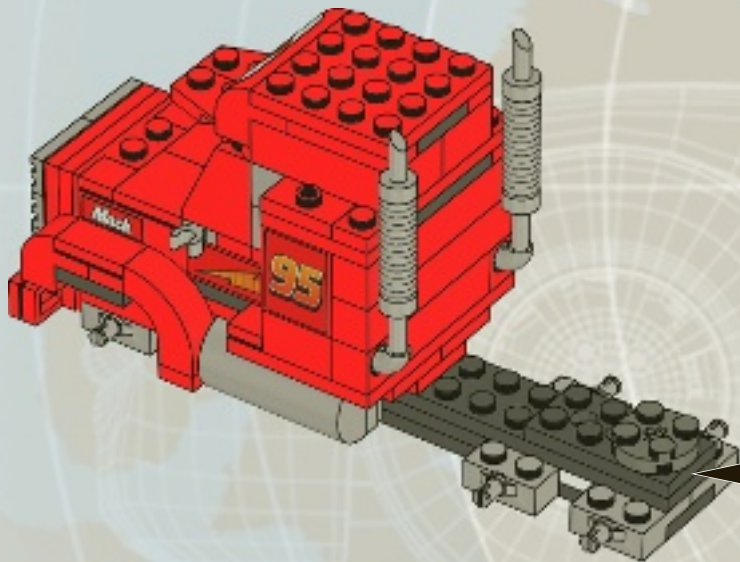



2x

37

target  
acquired

waypoint 2

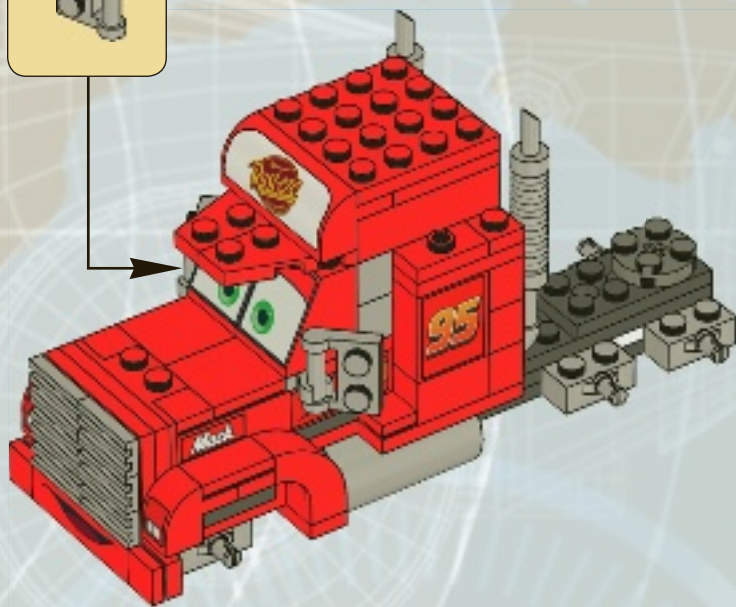



6x



6x

raypoint

# 38



8426



8484



8487





[www.LEGOclub.com](http://www.LEGOclub.com)



LEGO® Club Email

**LEGO club**™

**FREE! GRATIS! GRATUIT!**



LEGO® Club Magazine

 [www.LEGO.com](http://www.LEGO.com)

**SIGN UP ONLINE!**

**[www.LEGOclub.com](http://www.LEGOclub.com)**



**00800 5346 5555\***



**1-866-534-6258 • 1-877-518-5346**

US & Canada only

Canada seulement

\* Freephone. Mobile charges may apply.  
\* Numéro sans frais. Des frais peuvent s'appliquer avec les téléphones cellulaires.  
\* Gebührenfrei. Kosten für Anrufe aus Mobilfunknetzen können abweichen.  
\* Gratis telefonnummer vanaf vaste lijn.  
\* Det er et gratis nummer, når du ringer fra fasttelefon.  
\* Det är gratis, när du ringer från en fast telefon.  
\* Numéro sans frais. Des frais peuvent s'appliquer avec les téléphones portables.



**YES! I want to join the LEGO® Club FREE! OUI ! Je veux m'abonner au LEGO® Club GRATUITEMENT !**  
**Ja! Ich möchte Mitglied im kostenlosen LEGO® Club werden. Ja! Ik wil graag GRATIS lid worden van de LEGO® Club.**  
**Ja! Jeg ønsker å melde meg inn i LEGO® Club gratis! Ja! Jag vill gå med i LEGO® Club GRATIS!**

First name • Prénom  
Vorname • Voornaam  
Fornavn • Förnamn

Last name • Nom de famille  
Name • Achternaam  
Etternavn • Efternamn

Date of Birth • Date de naissance  
Geburtsdag • Geboortedatum  
Födelsdato • Födelsedato

Street • Adresse  
Straße, Hausnr.  
Straat, huisnr. •  
Adress

City • Ville  
Ort • Woonplaats  
Poststed • Postort

Zip/Postcode • Code  
Postal • PLZ • Postcode •  
Postnummer

Email • Courriel •  
E-Mail • E-post

Boy • Garçon • Junge •  
Jongen • Gutt • Pojke

Girl • Fille Mädchen •  
Meisje • Jente • Flicka

Country  
Pays • Land

Mail to: / Poster à:  
 LEGO® Club  
 P.O. Box 1157  
 Enfield, CT USA  
 06083-1157

Mail to:  
 LEGO® Club  
 33 Bath Road  
 Slough SL1 3UF  
 United Kingdom

Per Post an:  
 LEGO® Club  
 Postfach 14 15  
 D-36243 Niederaula

Stuur op naar:  
 LEGO® Club  
 Postbus 40250  
 3504 AB Utrecht

Poster à:  
 LEGO® Club  
 21 rue de la banque  
 75 002 PARIS  
 FRANCE

Send til:  
 LEGO® Club Norge  
 Postboks 58  
 1314 Vøyenenga

Skickas till:  
 LEGO® Club Sverige  
 Ubox 841  
 202 29 Malmö

- Fill in your email address and we will send you a membership confirmation and monthly email newsletters. If you do not wish to receive the newsletters please tick here. Rempis ton adresse e-mail et nous t'enversons une confirmation d'adhésion ainsi que le bulletin e-mail mensuel. Si tu ne désires pas recevoir le bulletin, coche cette case. Vul je e-mailadres in en we sturen je een bevestiging van je lidmaatschap en maandelijkse e-mail nieuwsbrieven. Als je geen e-mail wilt ontvangen, kruis dan dit vakje aan.
- Ich möchte per E-Mail den monatlichen LEGO Club Newsletter erhalten. Ønsker du at vi skal sende en liten hilsen til barnet ditt for å bekrefte medlemskapet, ber vi deg kryss av i feltet, samt oppgi e-postadressen som hilsenen skal sendes til. Om du vill att vi ska skicka en bekräftelse på ditt barns medlemskap, ber vi dig sätta ett kryss i rutan och skriva den e-post adress som bekräftelsen ska skickas till.
- If you do not wish to receive additional mailings from the LEGO Club please tick here. Si tu ne désires pas recevoir de courrier supplémentaire du Club LEGO, coche cette case. Als je geen verdere post van de LEGO Club wilt ontvangen, kruis dan dit vakje aan.
- Dersom du ønsker å motta annen informasjon fra LEGO Gruppen, setter du et kryss her.

 The English language version of the magazine can only be mailed to addresses in the US, Canada, the UK, and Republic of Ireland. Club membership is valid for two years and includes free copies of the LEGO Club Magazine and e-mail newsletters. In the US and Canada please allow up to 6 weeks for delivery of your first magazine. In the UK and Republic of Ireland please allow six to 14 weeks for delivery of your first magazine. By signing this form you consent the LEGO Club to use your child's data for LEGO mailings. The data will only be used for LEGO mailings and will not be sold, rented or otherwise disclosed to any company outside the LEGO Company except for disclosure to companies acting as our agents to help us provide services requested by the child. This coupon is valid for one free membership per person, group or organization. Photocopied coupons are accepted.  La version française du magazine peut être postée uniquement au Canada. L'abonnement est valide pour 2 ans et inclut des exemplaires gratuits du Magazine LEGO. Aux É.-U. et au Canada, allouer 6 semaines pour la livraison initiale. En remplissant ce formulaire, vous consentez à ce que LEGO utilise les informations de votre enfant pour des envois postaux de LEGO. L'information sera utilisée uniquement pour des envois postaux par LEGO et ne sera en aucun cas, vendue, louée, échangée ou divulguée à d'autres compagnies autres que la compagnie LEGO, à l'exception des compagnies affiliées qui nous procurent des services auxquels l'enfant a fait la demande. Formulaire photocopié accepté.  Mit der folgenden Unterschrift erkläre ich, für mein Kind den Beitritt als Mitglied zum kostenlosen LEGO Club, der von der LEGO GmbH, D-85627 Grasbrunn, betrieben wird. Die Mitgliedschaft beinhaltet die Zusendung des LEGO Club Magazines und kann beiderseits jederzeit beendet werden. Mit der Mitgliedschaft im LEGO Club sind keinerlei Verpflichtungen verbunden. Das deutschsprachige LEGO Club Magazin wird nur an Adressen in Deutschland, Österreich und der Schweiz versendet. Eine Anmeldebestätigung kann nur per E-Mail geschickt werden. Das Magazin erscheint fünfmal jährlich. Daher kann die Zustellung des ersten Heftes bis zu drei Monate dauern. Die Mitgliedschaft ist beidseitig jederzeit kündbar, ohne dass Ihnen Kosten entstehen. Sie können der werblichen Nutzung Ihrer Daten jederzeit widersprechen. Kündigung und Widerspruch können Sie telefonisch erklären (00800 / 5346 5555, Anruf gebührenfrei, Kosten für Anrufe aus dem Mobilfunknetz können abweichen) oder an die LEGO GmbH senden.  Het Nederlandse LEGO Club Magazine kan alleen worden gestuurd naar adressen in Nederland. Het lidmaatschap is 2 jaar geldig en geeft recht op toezending van het gratis LEGO Club Magazine en LEGO Club e-mails. Het eerste magazine zal binnen 12 tot 14 weken toegestuurd worden. Het lidmaatschap kan op ieder moment opgezegd worden en kan na 2 jaar gratis worden verlengd, tenzij LEGO met deze activiteit stopt. Uw gegevens worden uitsluitend gebruikt voor mailings van LEGO en zullen niet worden verkocht, verhuurd of op welke wijze dan ook verstrekt aan derden buiten de LEGO Groep, uitgezonderd de organisaties die namens ons optreden om de informatie te sturen waarvoor toestemming is verleend.  Den norske utgaven av magasinet sendes kun til adresser i Norge. Medlemskap i klubben gjelder i 2 år og inkluderer gratisutgaver av LEGO Club Magazine. Påregning minimum opp til seks uker leveringstid for første magasin. Ved å undertegne dette skjemaet, gir du ditt samtykke til at LEGO Club kan bruke opplysningene om barnet ditt i LEGO forsendelser. Dataene vil utelukkende bli brukt i LEGO forsendelser og vil ikke bli solgt, utleid eller på annen måte gjøres tilgjengelig for selskaper utenfor LEGO gruppen, unntatt selskaper som er våre agenter og som hjelper oss å tilby tjenestene barnet etterspør. Dette skjemaet gjelder for ett gratis medlemskap per person, gruppe eller organisasjon.  Den svenska versionen av tidsningen kan endast skickas till adresser i Sverige. Club-medlemskapet är giltigt i 2 år och innefattar gratis exemplar av LEGO Club Magazine. Vänligen räkna med minimum 6 veckor för leverans av din första tidning. Genom att skicka in det här formuläret godkänner du att LEGO Club använder barnets uppgifter för LEGO utskick. Uppgifterna kommer bara att användas för LEGO utskick och kommer inte att säljas, hyras ut eller vidarebefordras till något företag som inte tillhör LEGO Gruppen, med undantag av företag som agerar som våra ombud för att tillhandahålla tjänster som barnet har begärt. Den här kupongen gäller för ett gratis medlemskap per person, grupp eller organisation.  En complétant ce bulletin d'adhésion, vous acceptez que LEGO Club utilise les données relatives à votre enfant pour l'envoi de courriers concernant LEGO. Ces données seront uniquement utilisées pour l'envoi d'information concernant LEGO et ne seront ni vendues, ni louées, ni utilisées par d'autres sociétés que le groupe LEGO, à l'exception des sociétés agissant pour le compte de LEGO en tant que sous-traitant de services divers. L'abonnement au LEGO Club est valable pour une période de 2 ans. Il inclut l'envoi par courrier du magazine LEGO Club et par email des newsletters. Un délai de 6 à 14 semaines est à prévoir pour la réception de votre premier magazine. Ce bulletin d'adhésion gratuit est valable pour l'inscription d'une seule personne. Les photocopies sont acceptées. ATTENTION! Le bulletin d'adhésion doit être rempli et signé par un parent ou un tuteur.

Parent's signature • Signature d'un parent ou d'un tuteur  
 • Unterschrift Erziehungsberechtigte/r • Handtekening ouders  
 • Foreldres/foresattes underskrift • Förälders /förmyndares underskrift

Date  
 Datum  
 Dato





8486



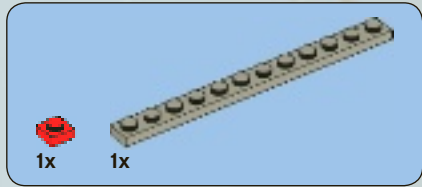
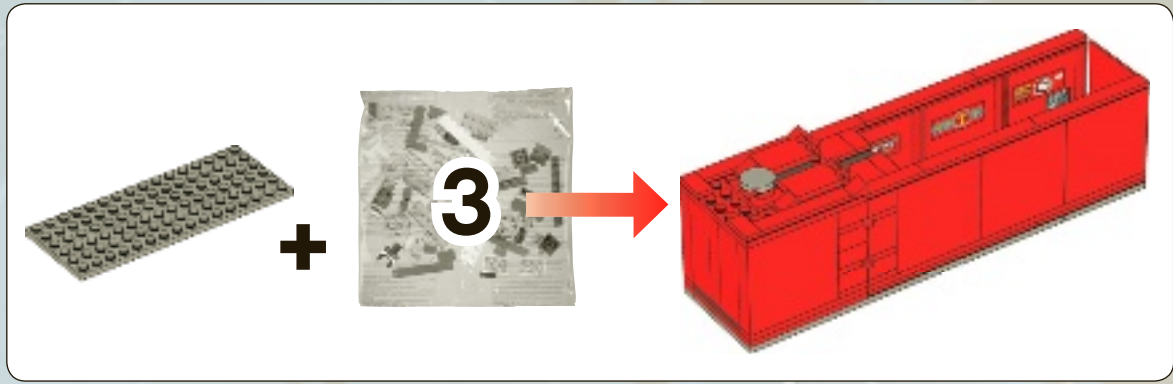

1

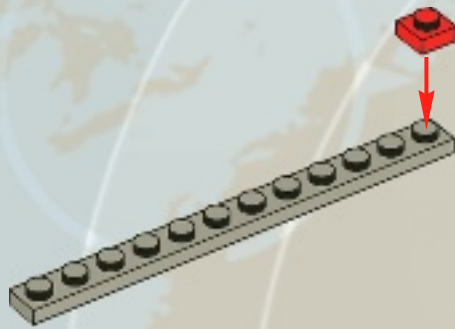

2

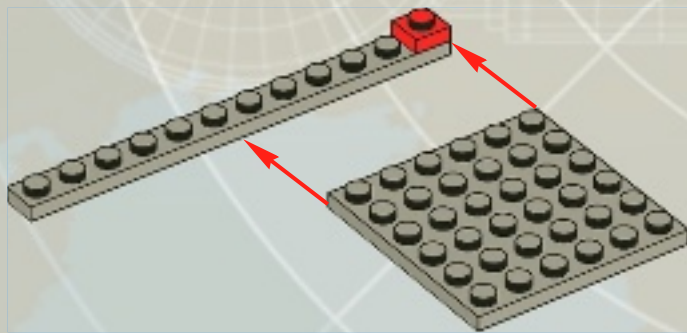

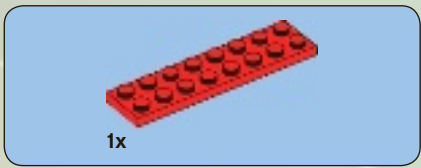

3

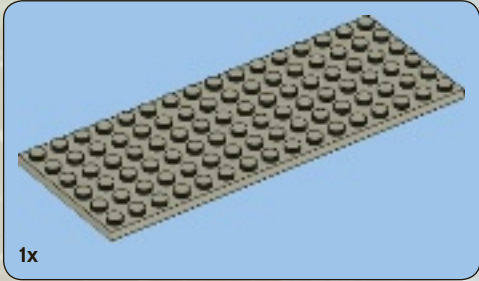

4

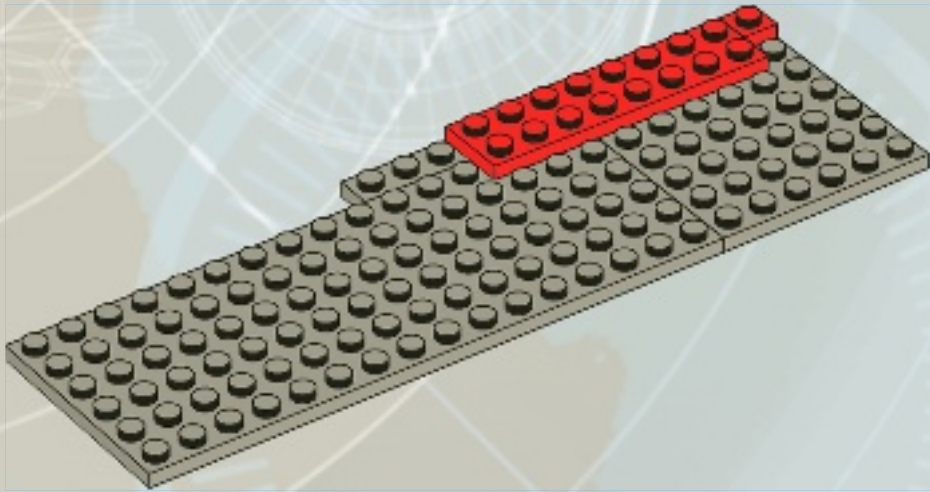

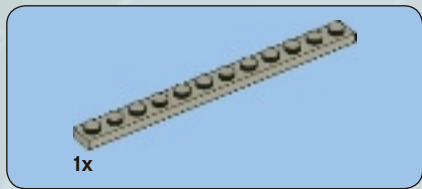

5

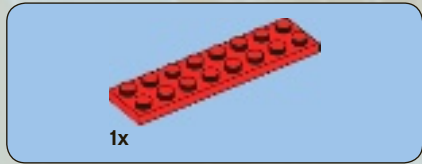
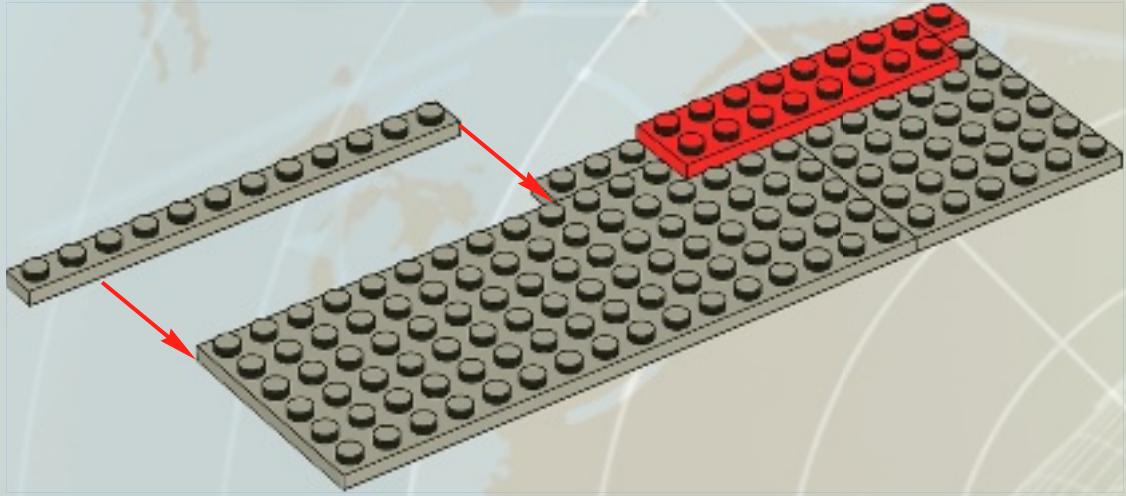

6

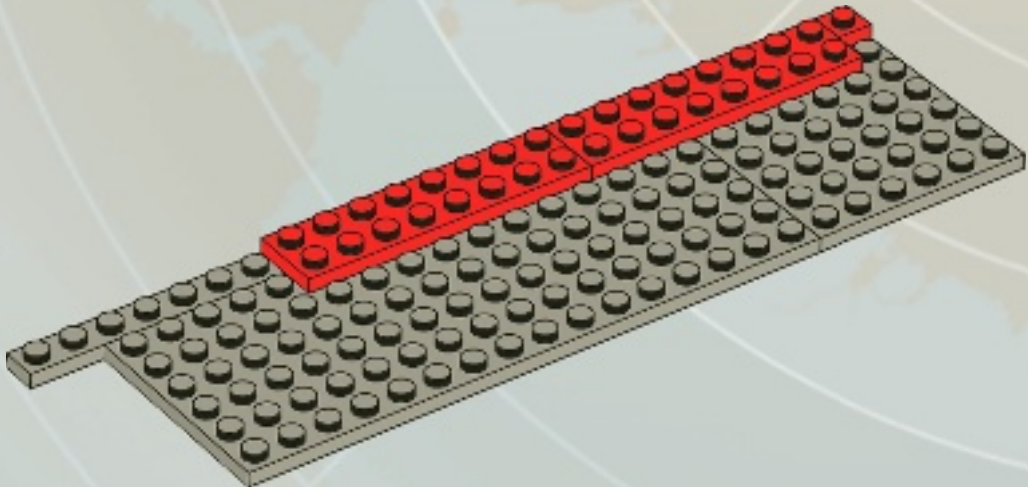

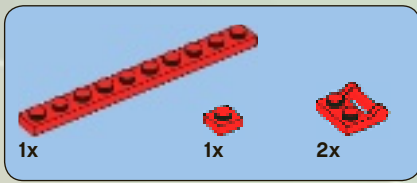

7

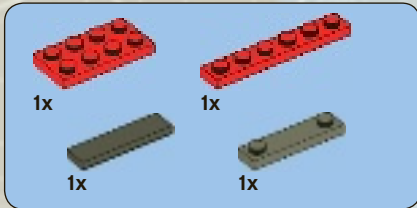
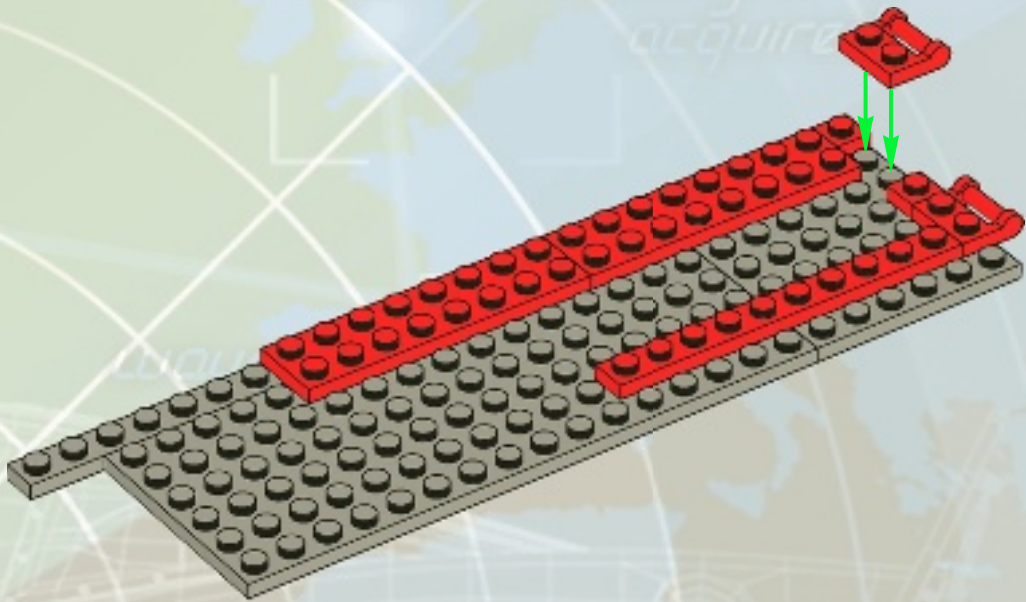

8

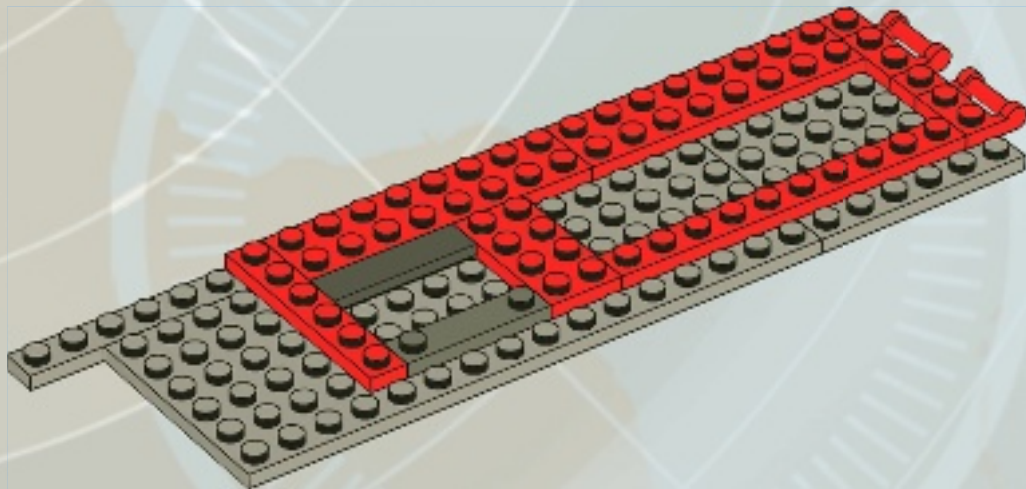

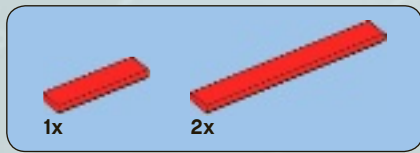

9

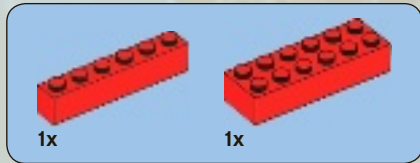
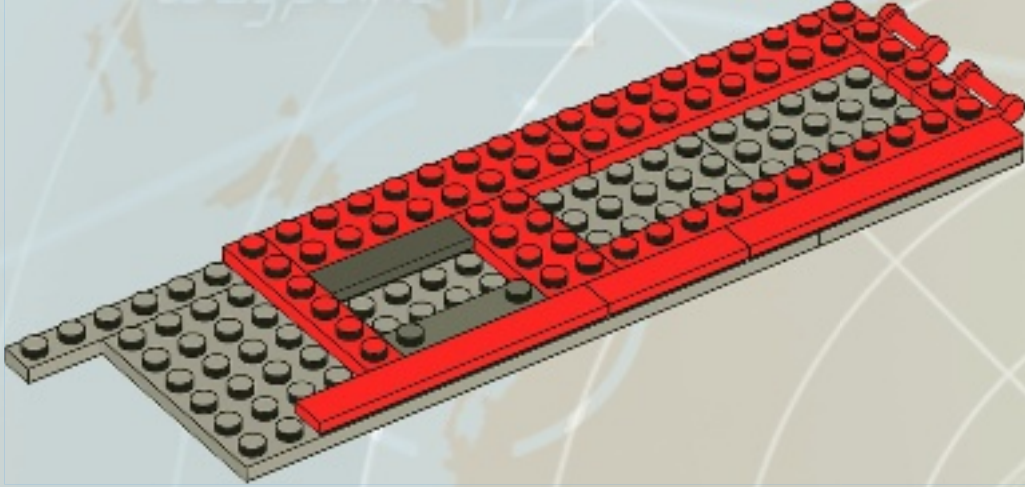

10

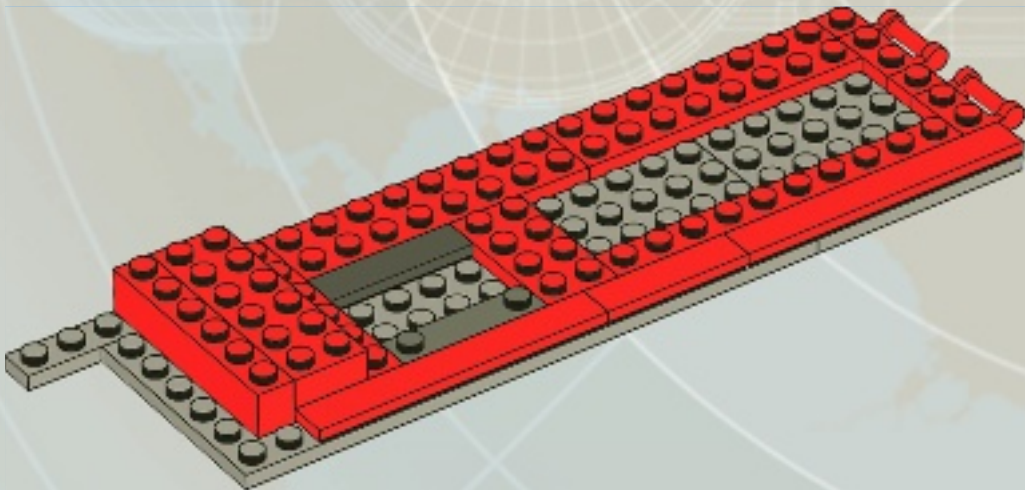

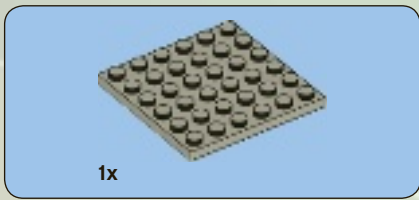

11

target  
acquired

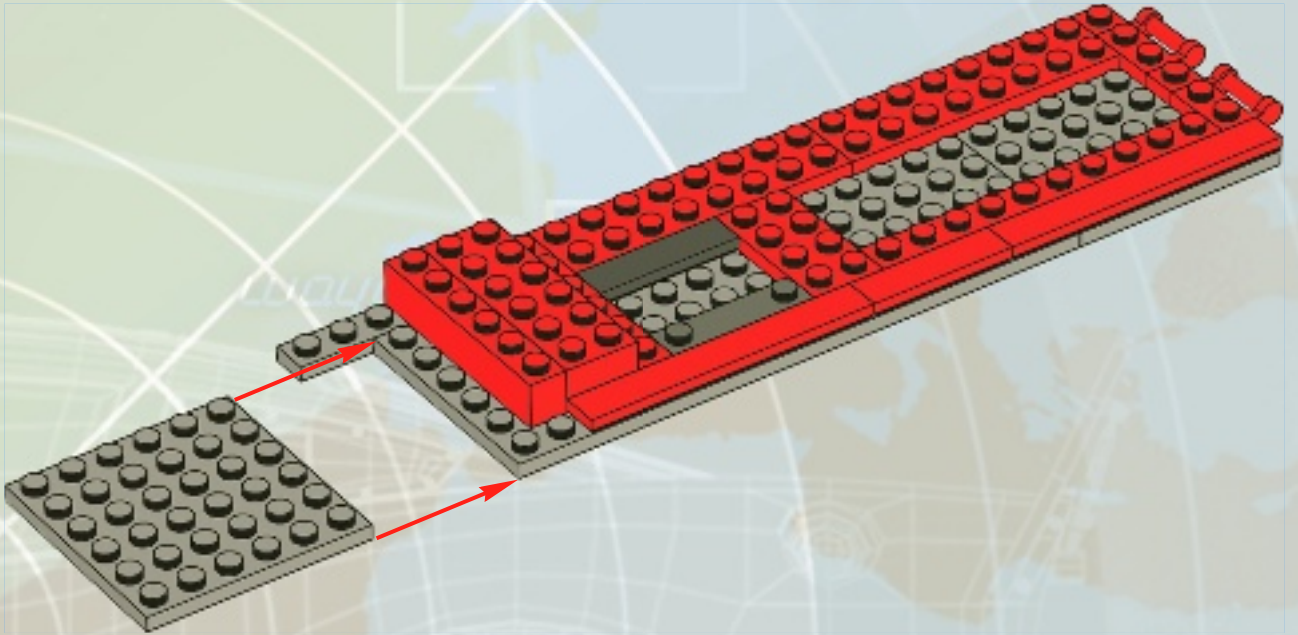

12

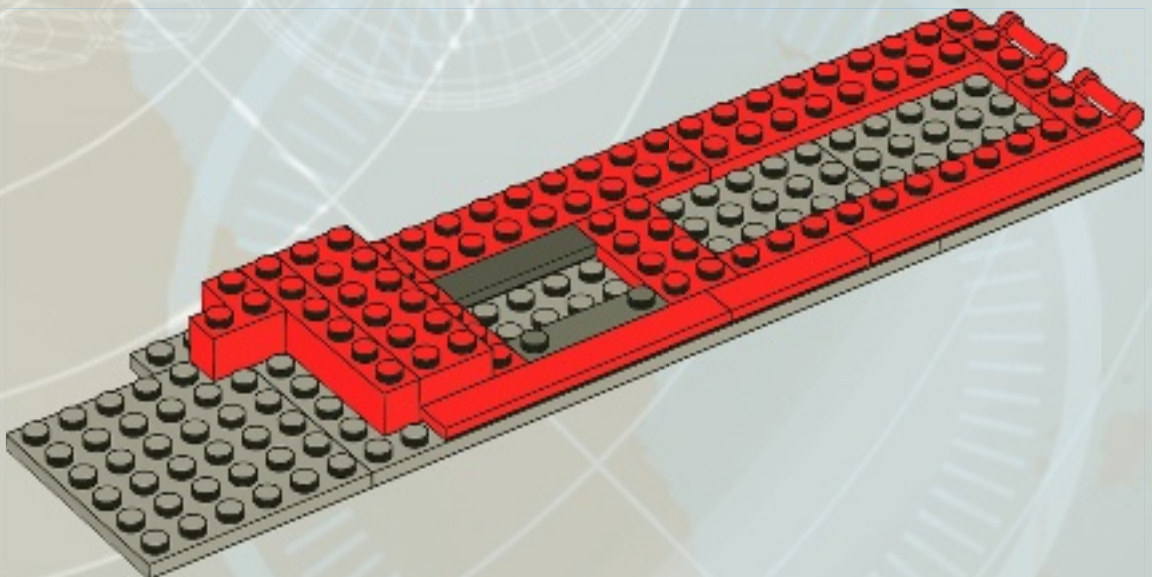

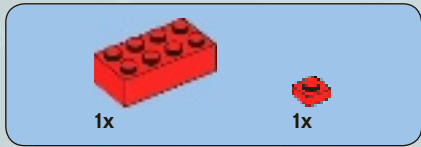

# 13

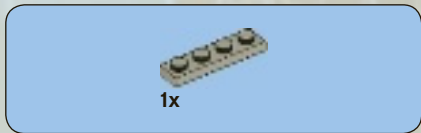
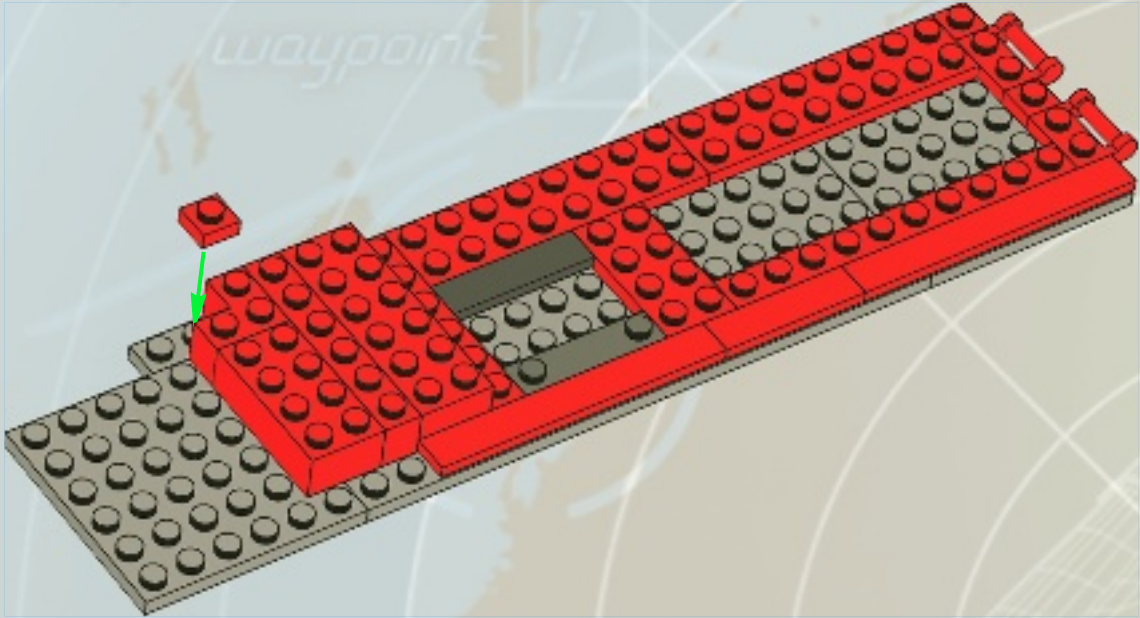

# 14

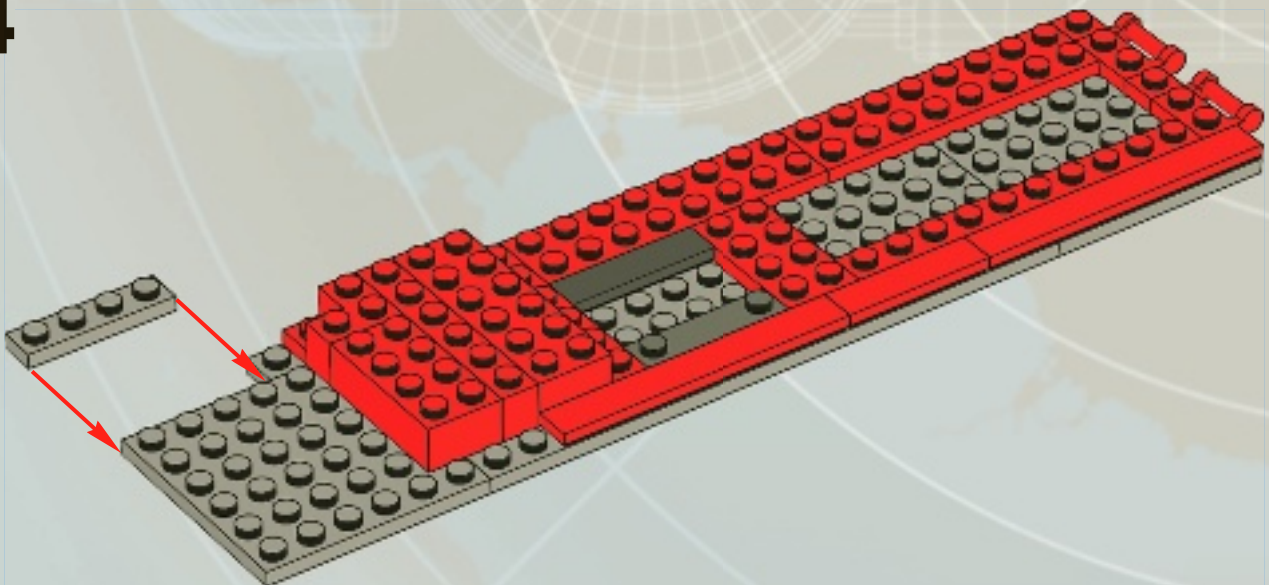



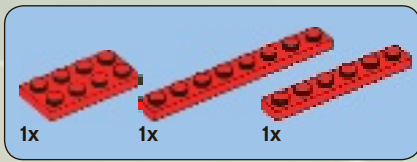

15

target  
acquired

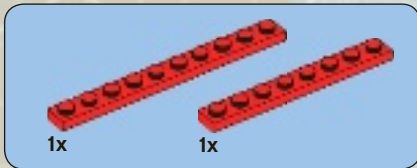
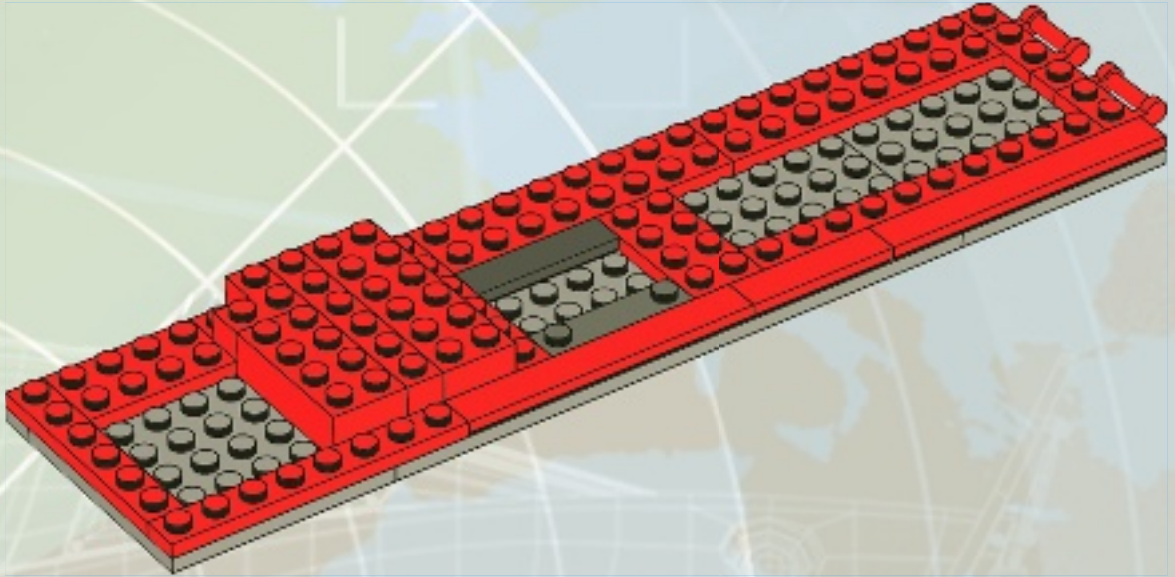

16

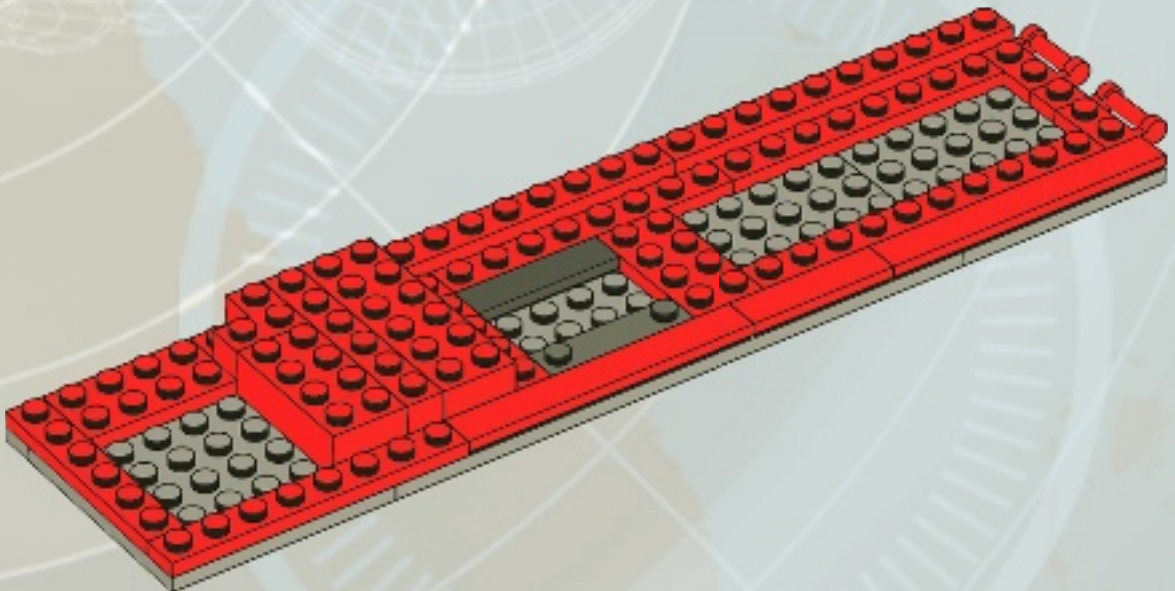

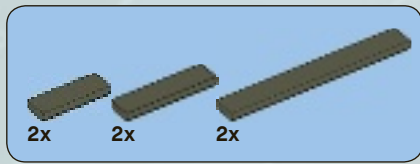

# 17

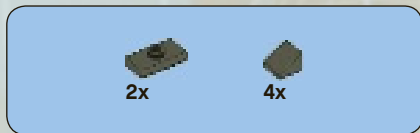
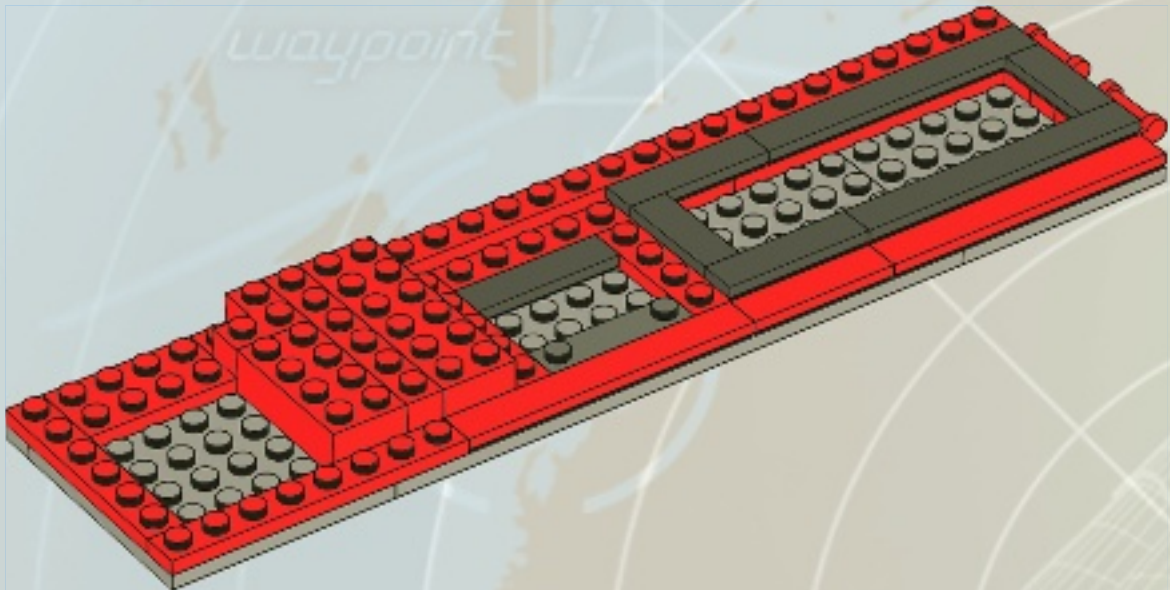

# 18

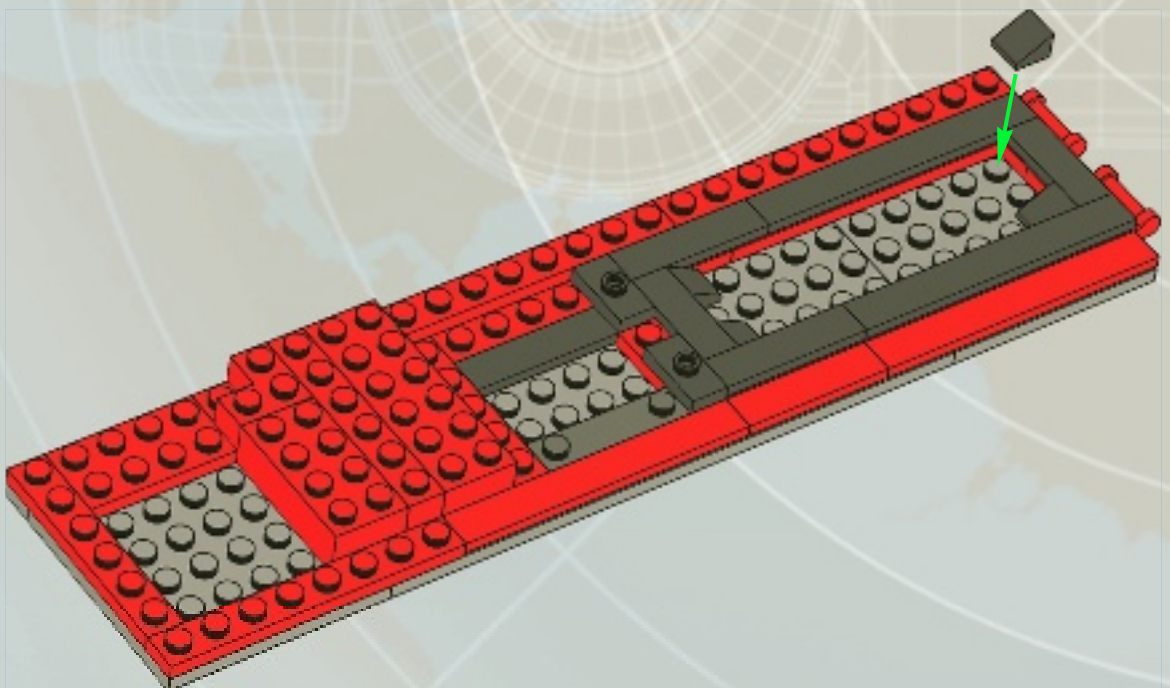

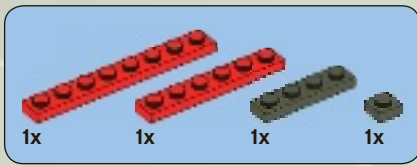

19

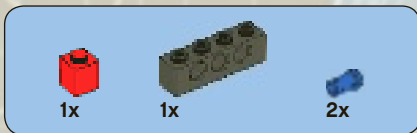
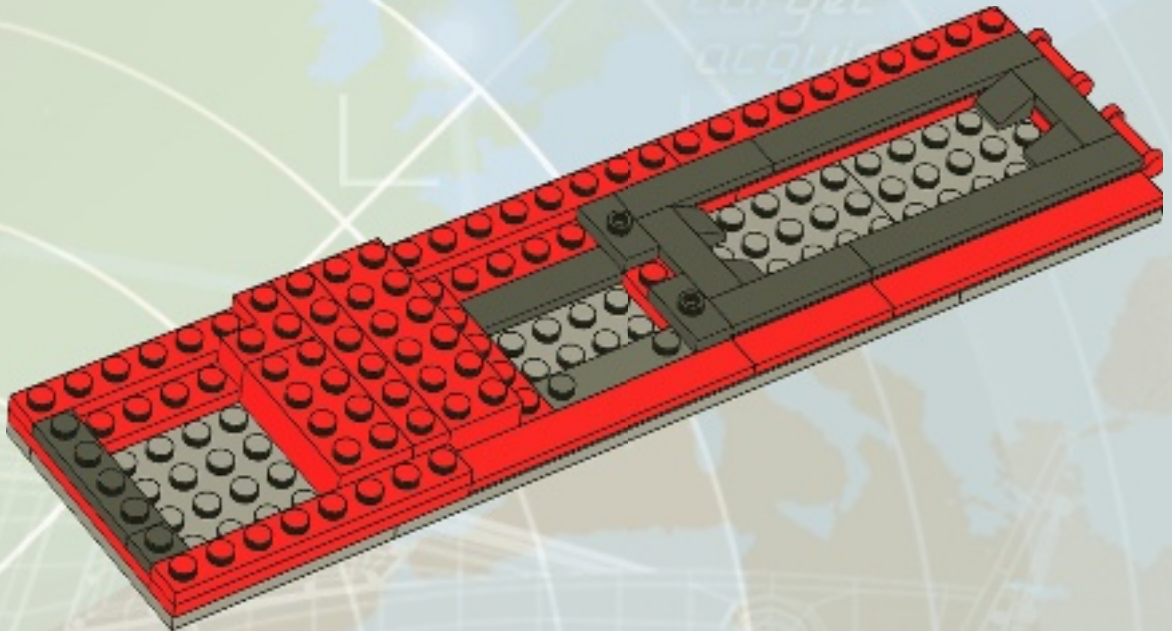

20

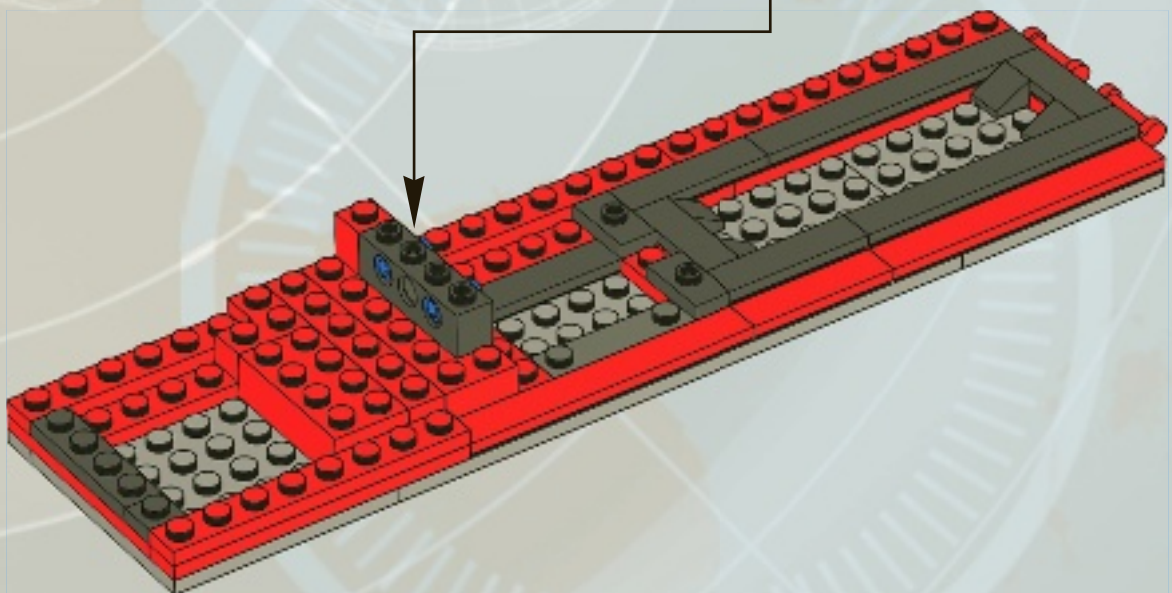
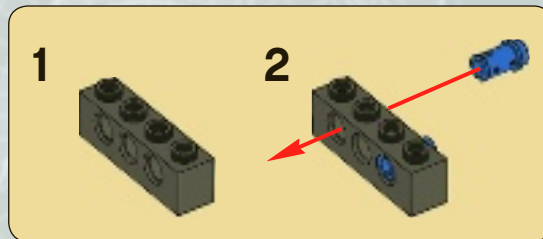

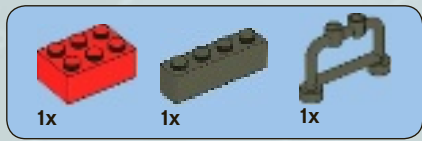

# 21

waypoint 1

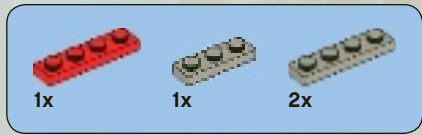
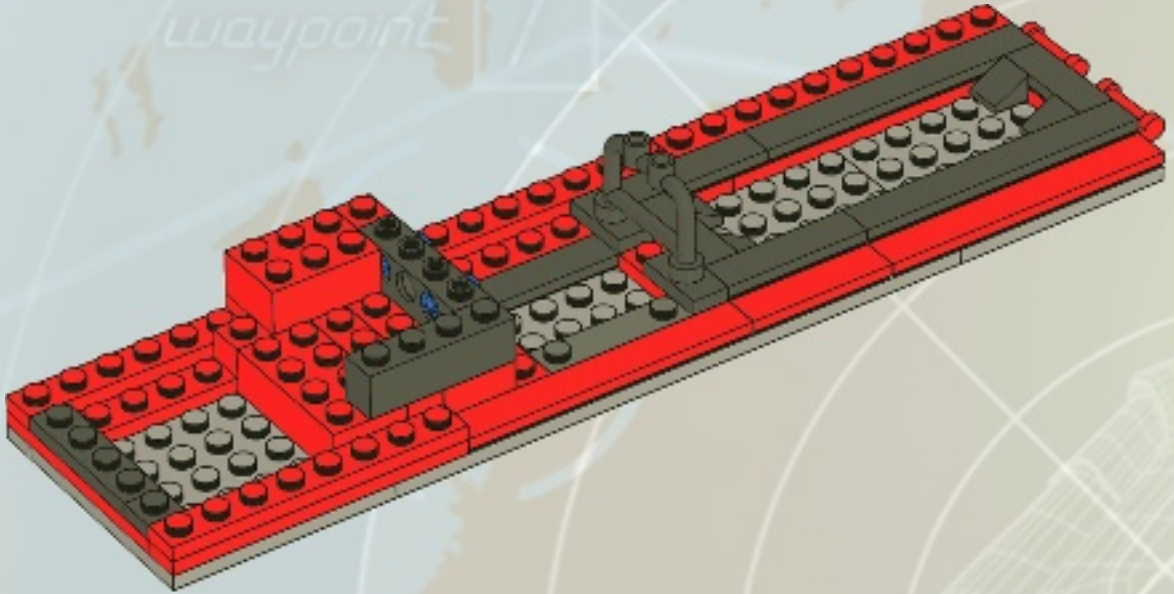

# 22

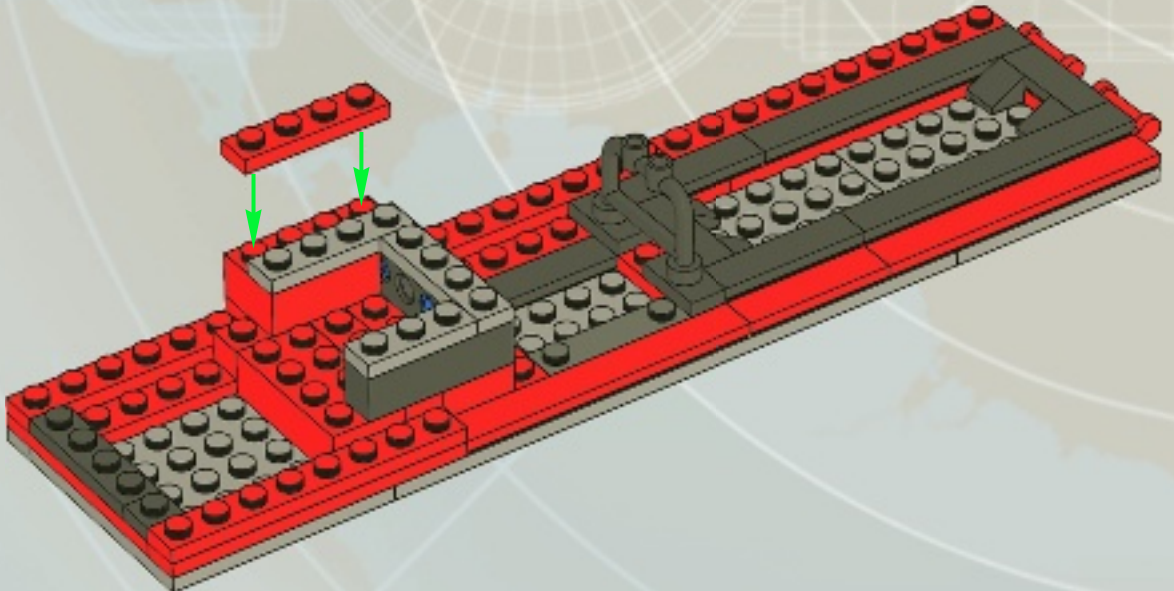



1x



1x

# 23

target  
acquired

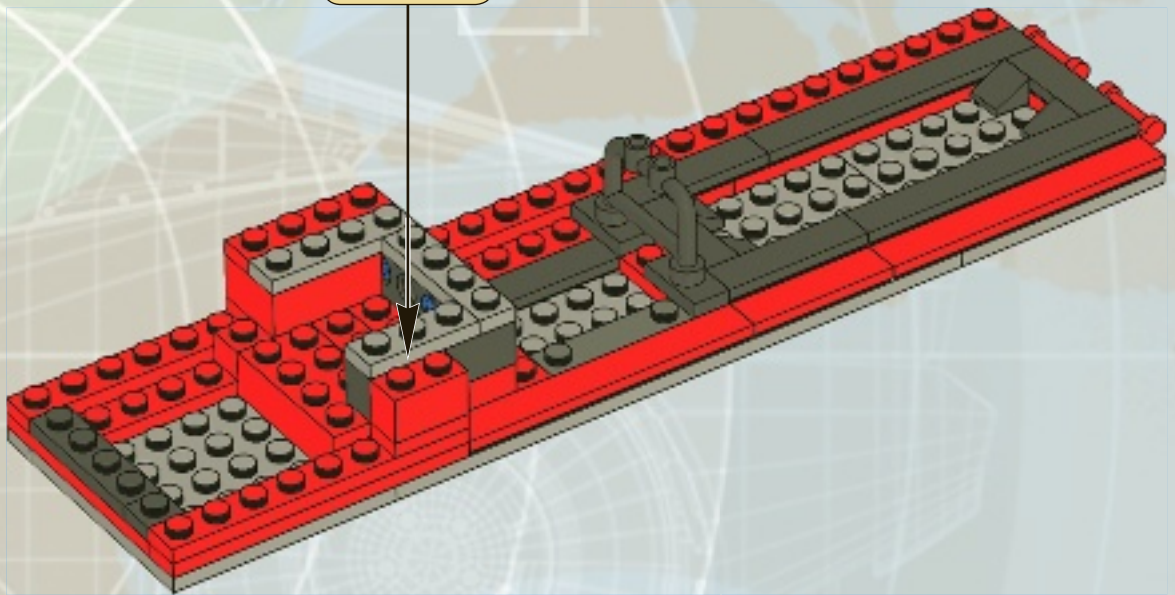
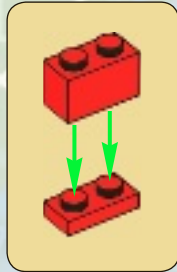

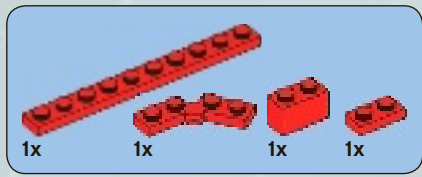

# 24

waypoint 1

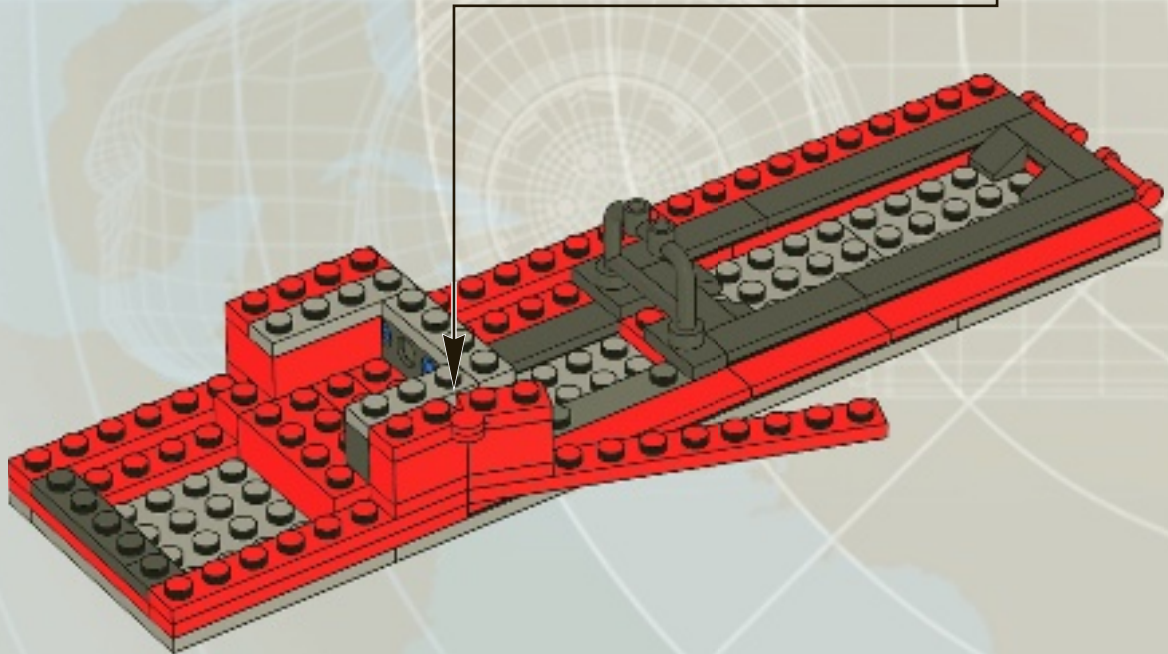
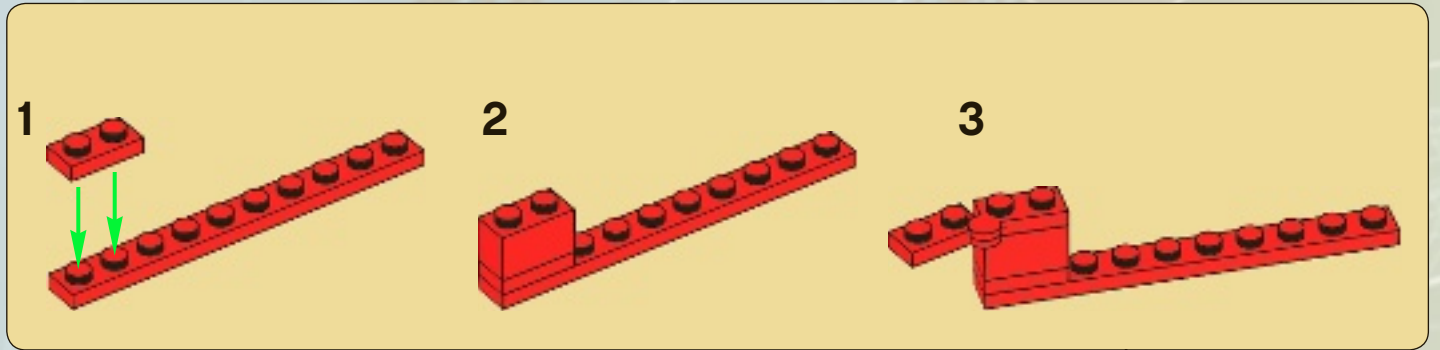

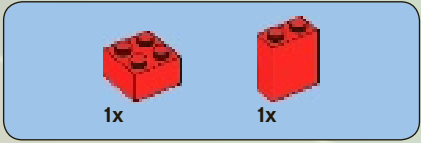

# 25

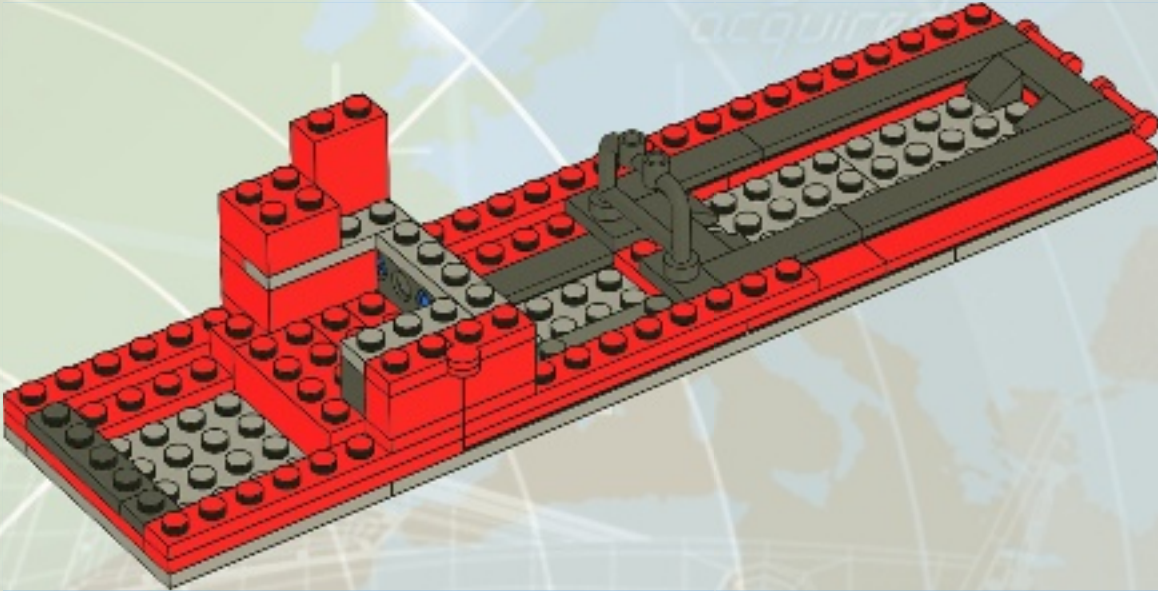

# 26

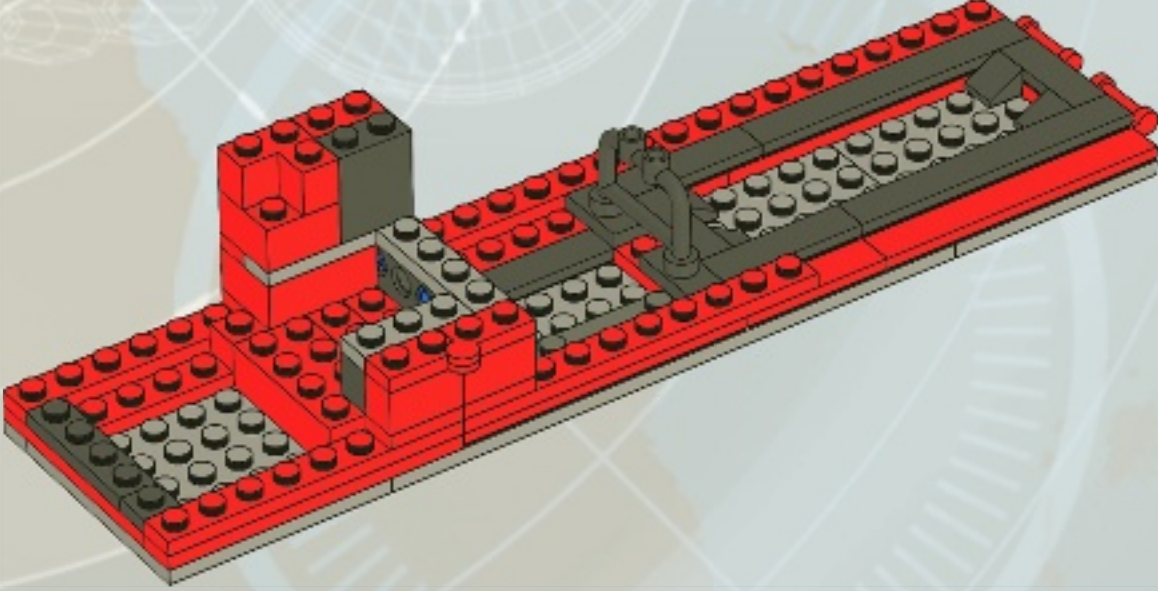



# 27

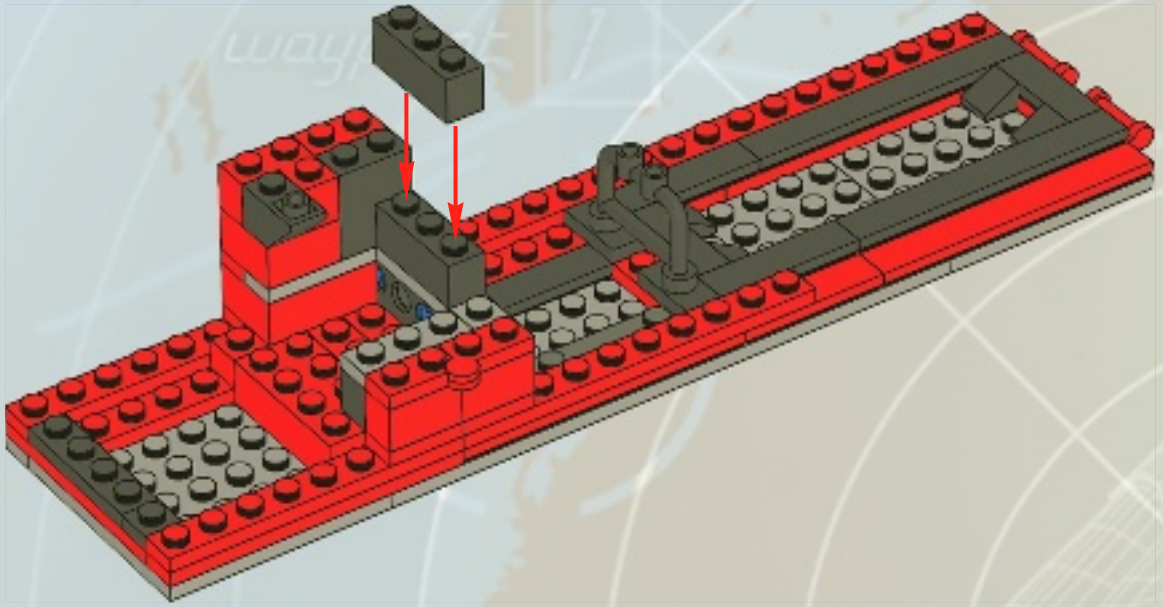

# 28

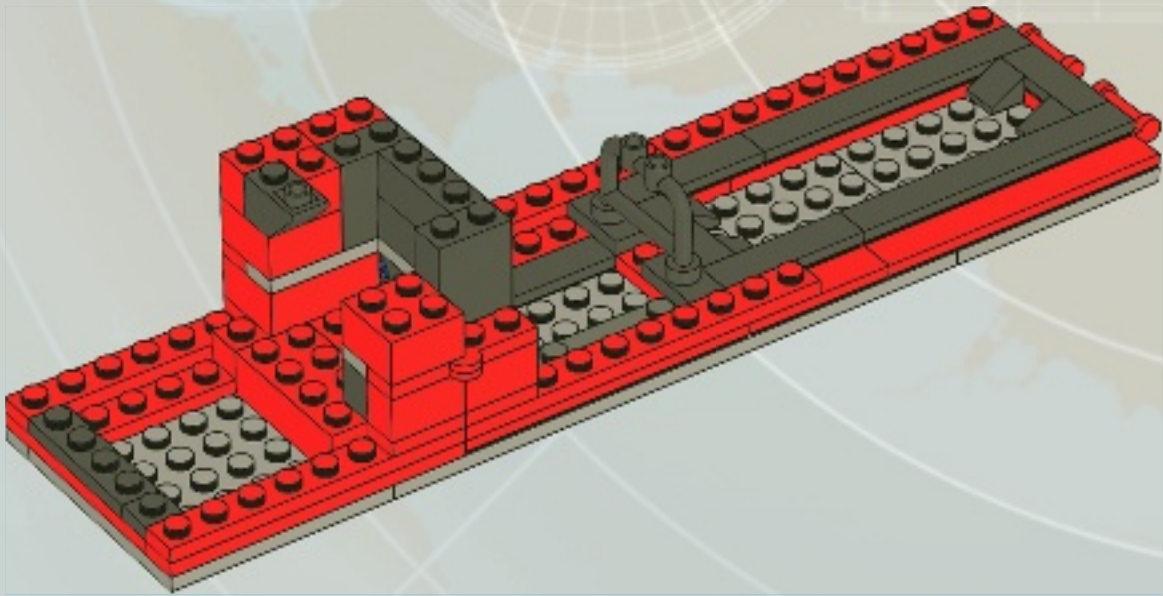



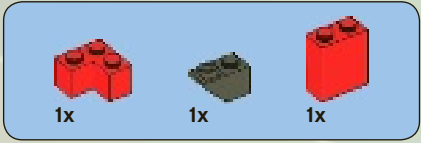

# 29

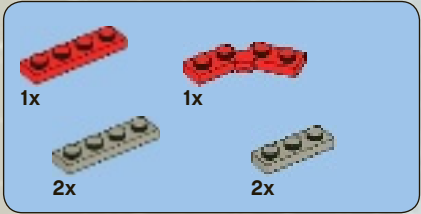
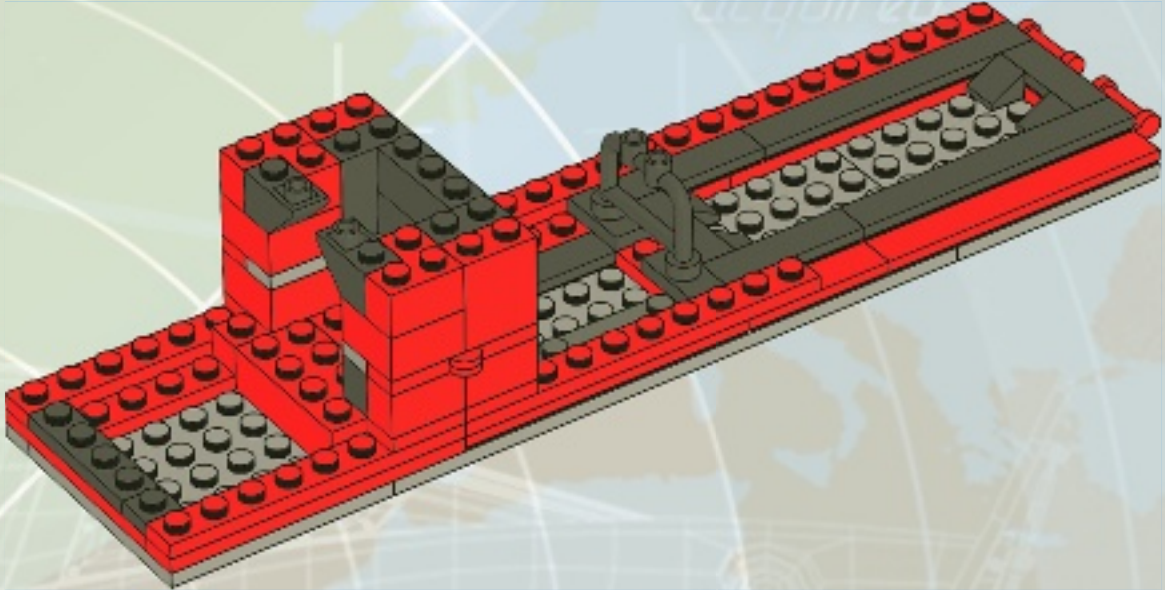

# 30

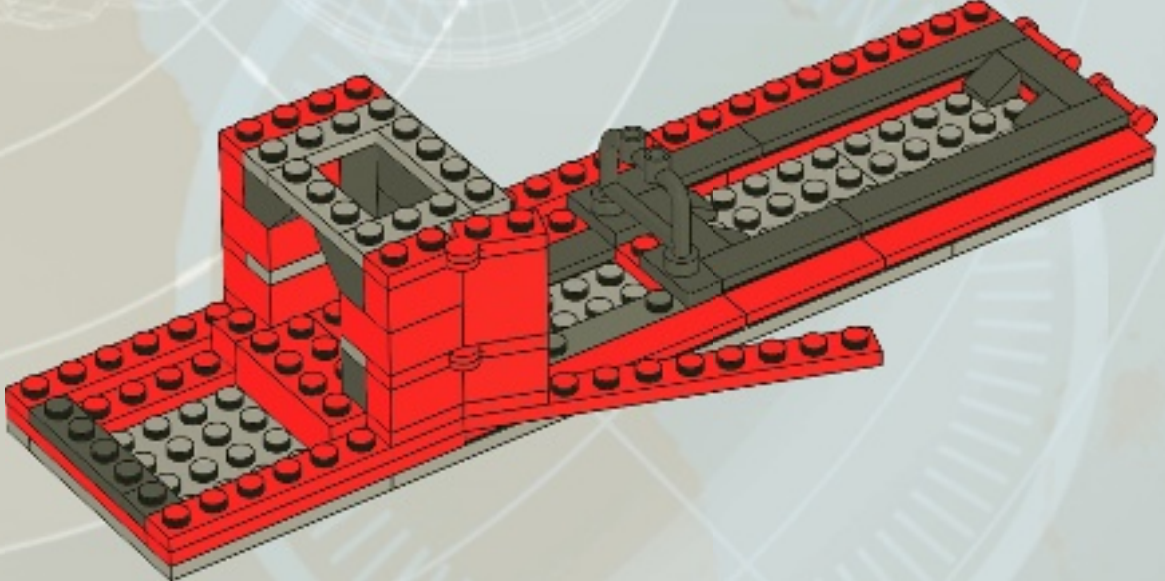

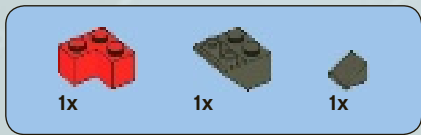

# 31

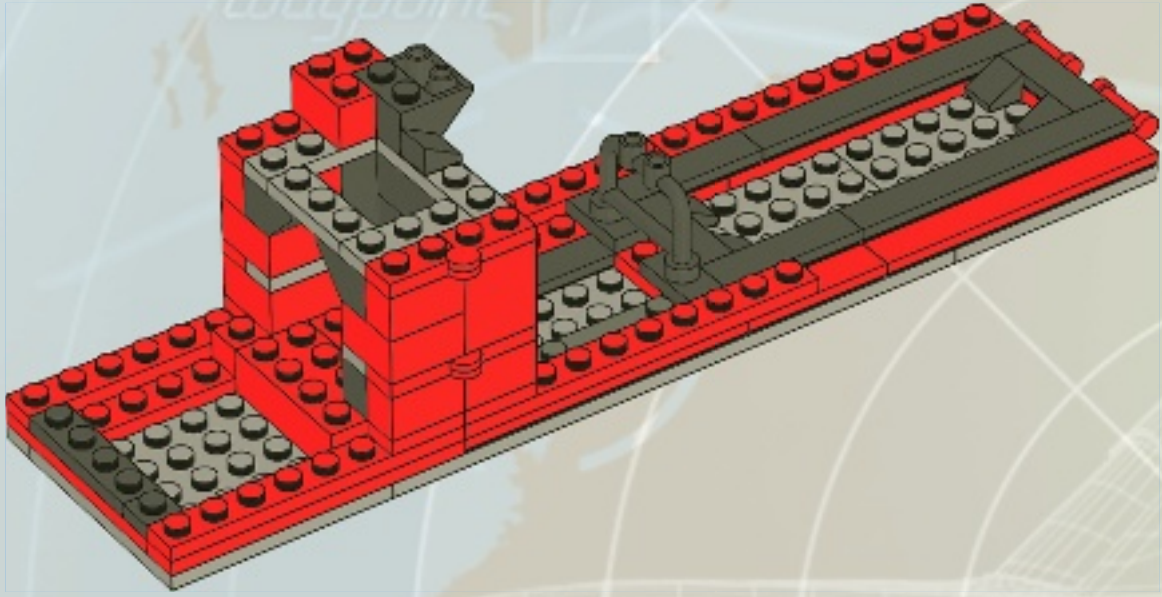

# 32

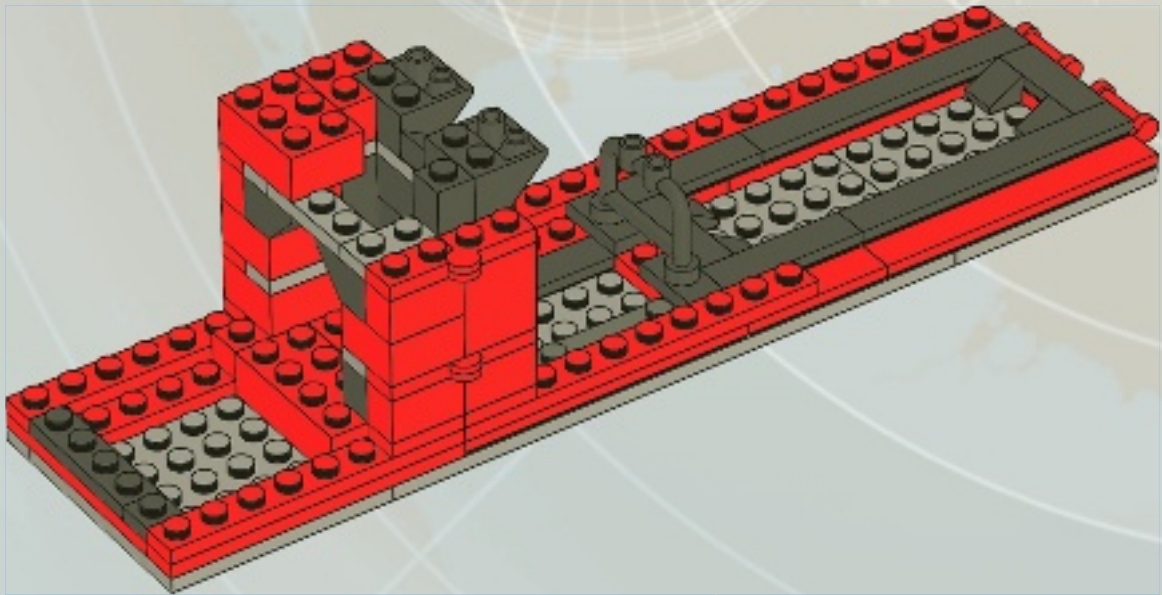

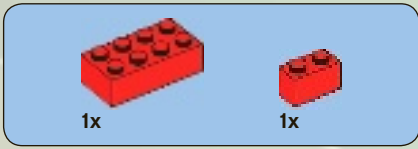

# 33

target  
acquired

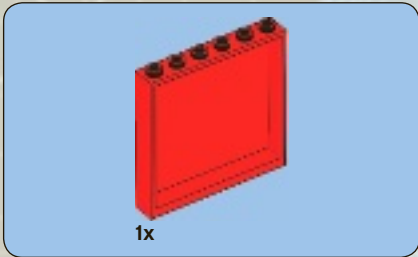
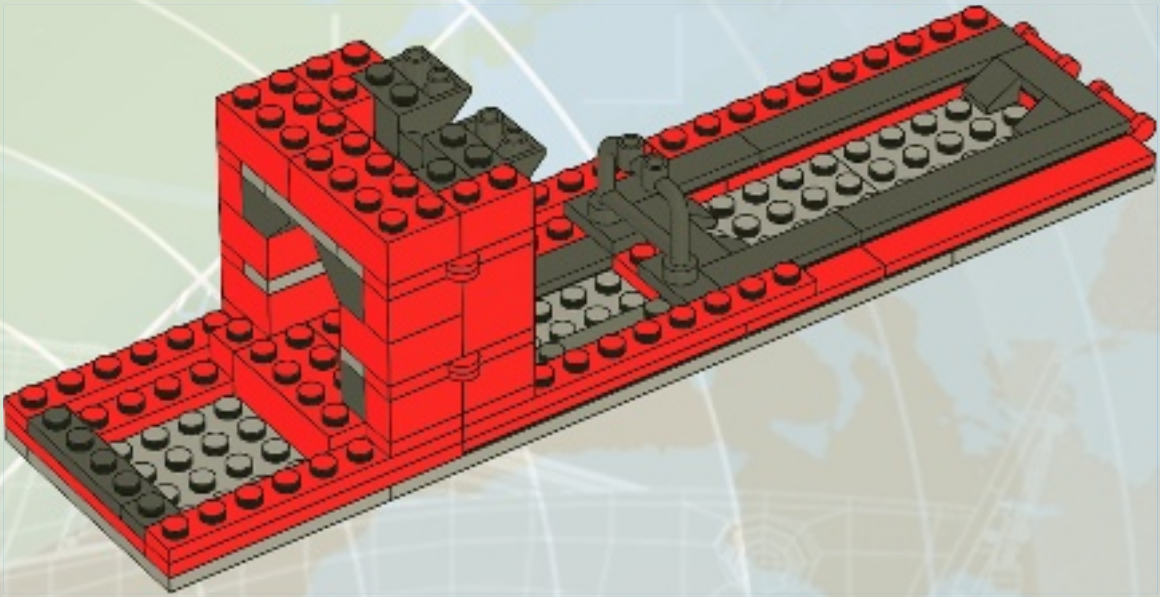

# 34

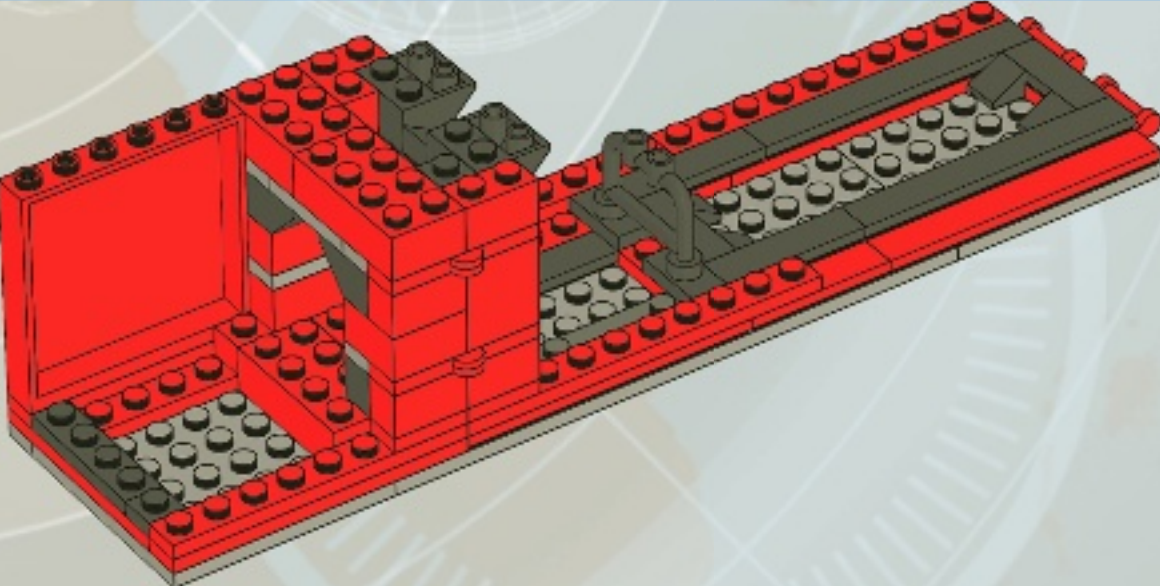

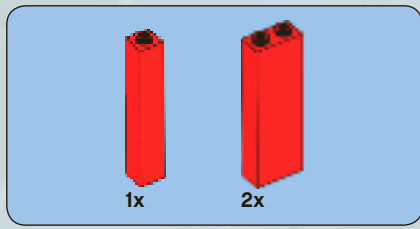

35

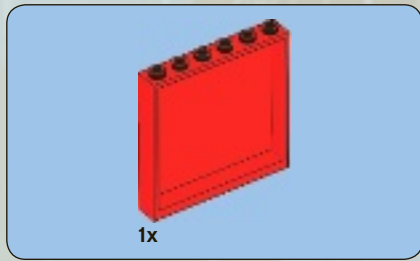
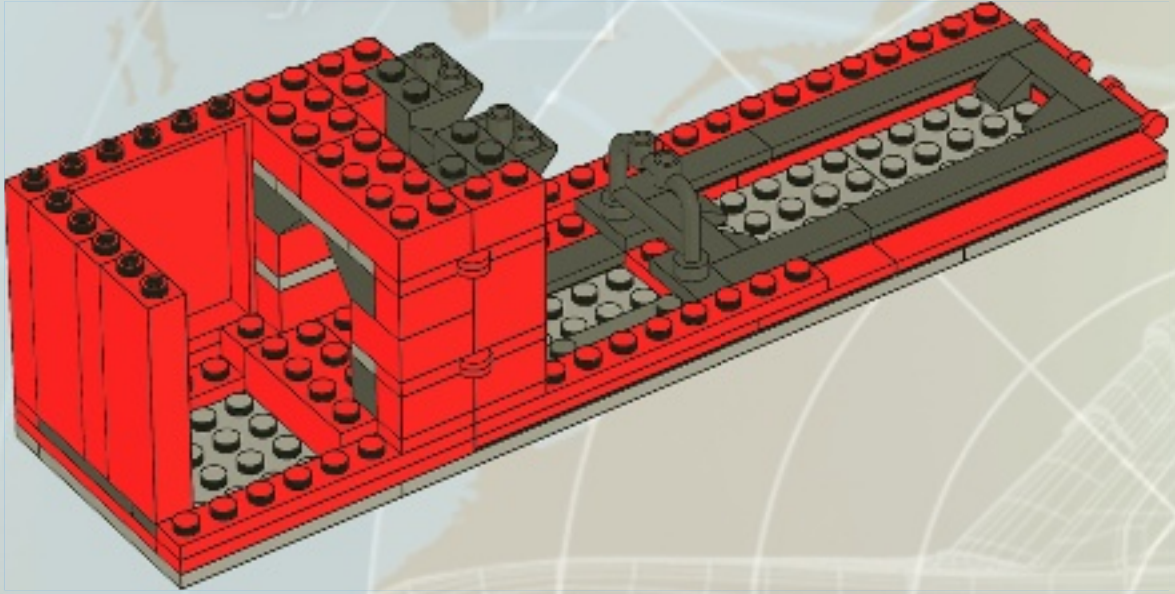

36

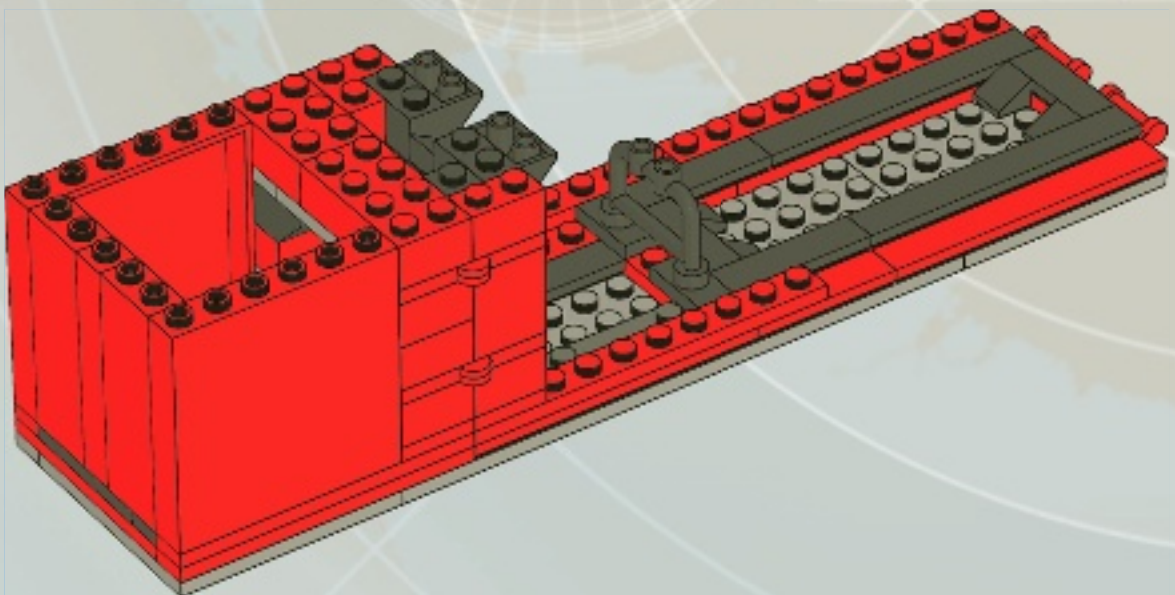

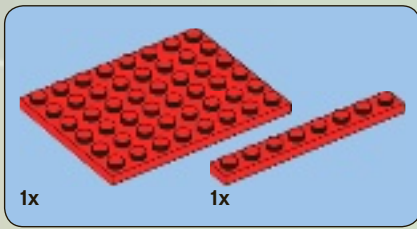

37

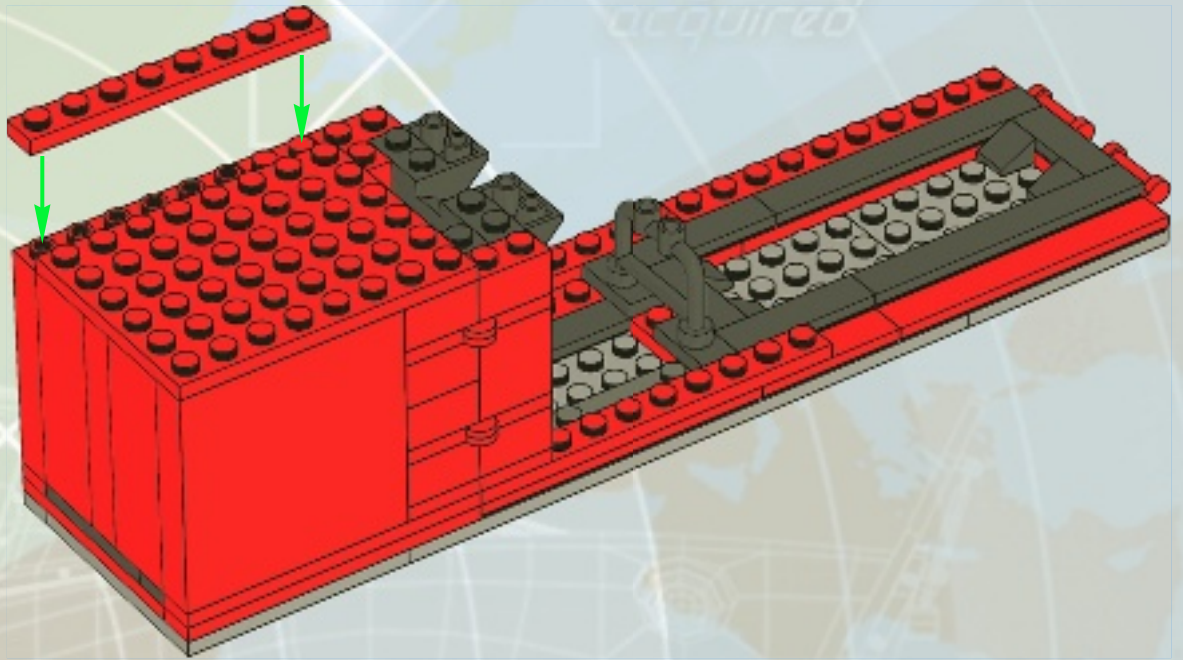

38

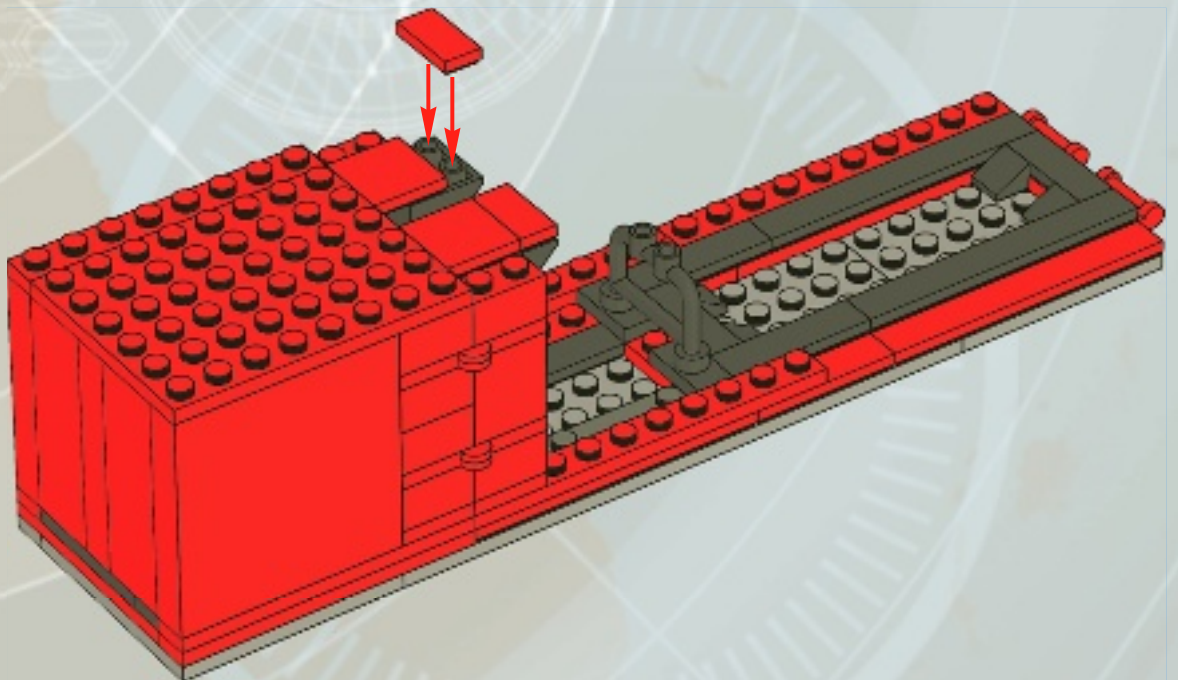

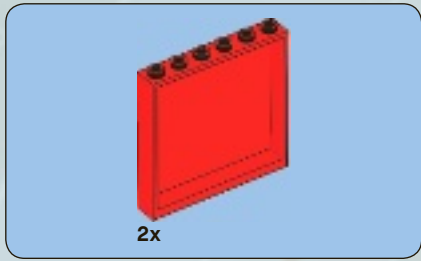

39

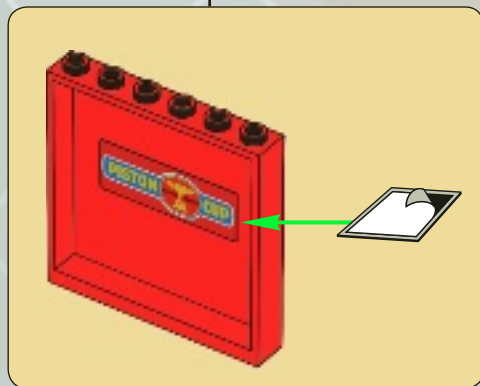
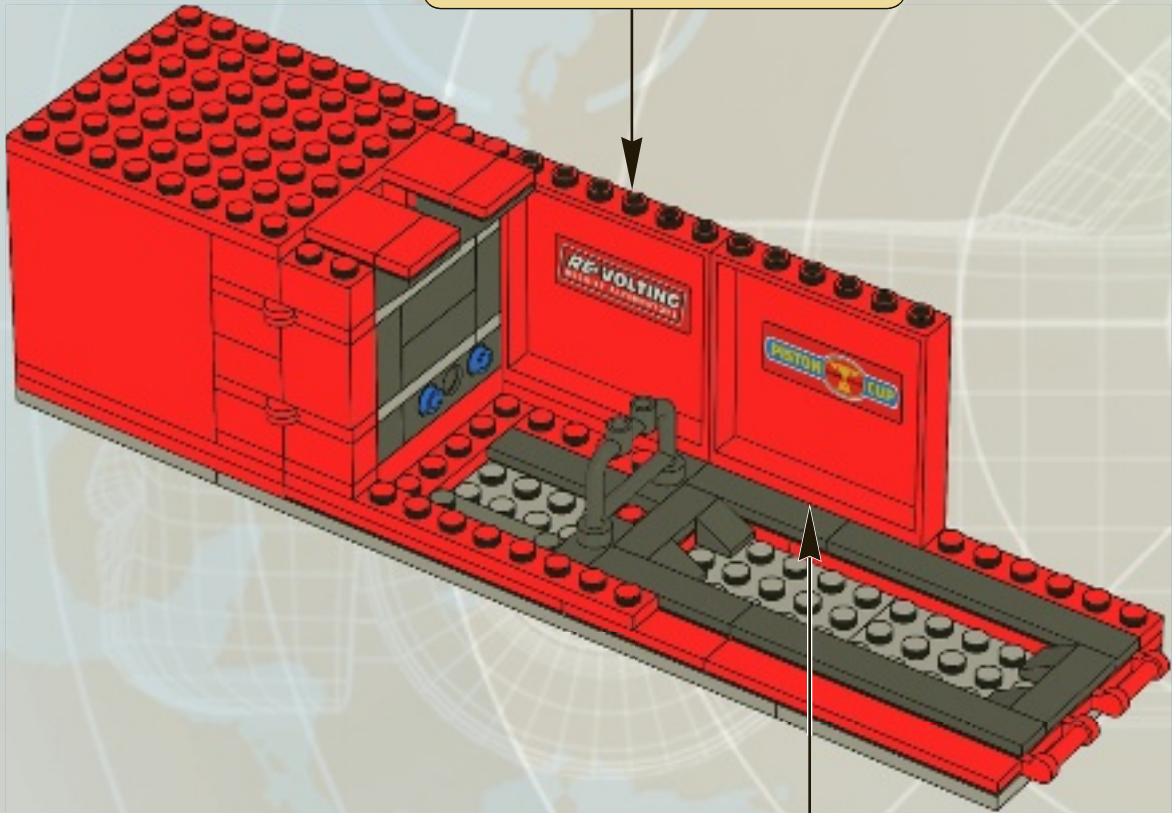
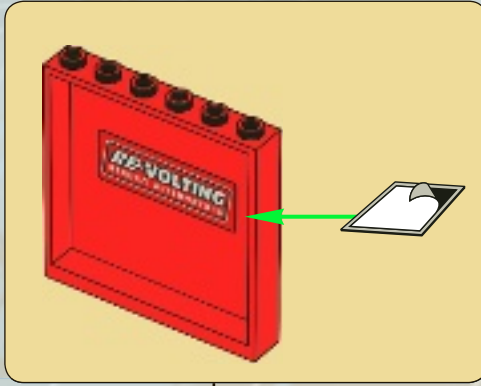

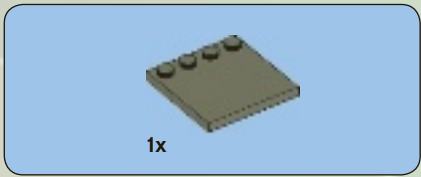

40

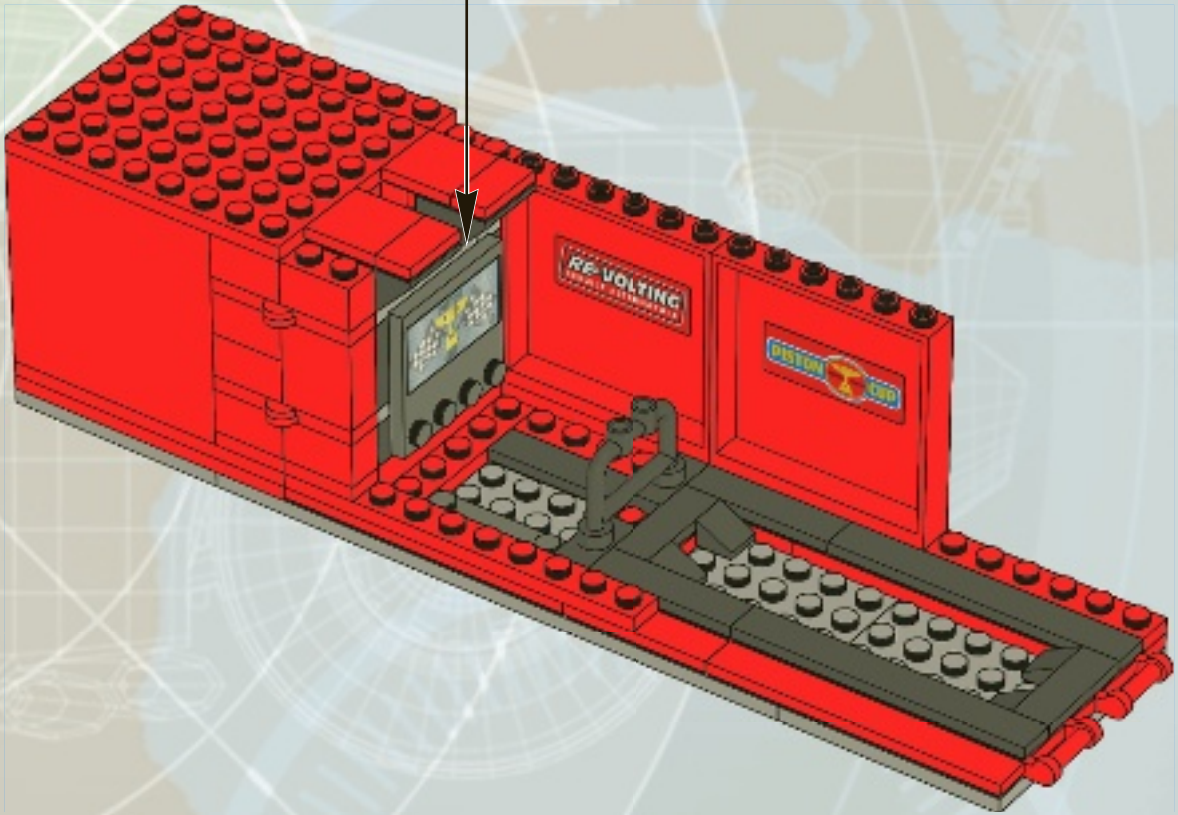
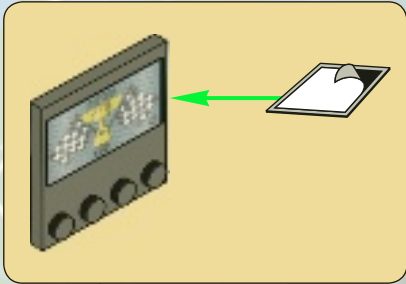

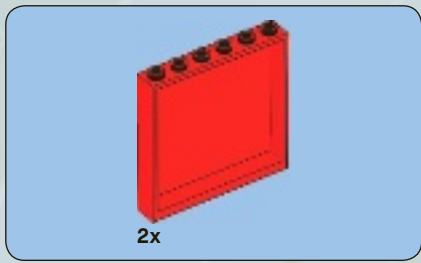

41

waypoint 1

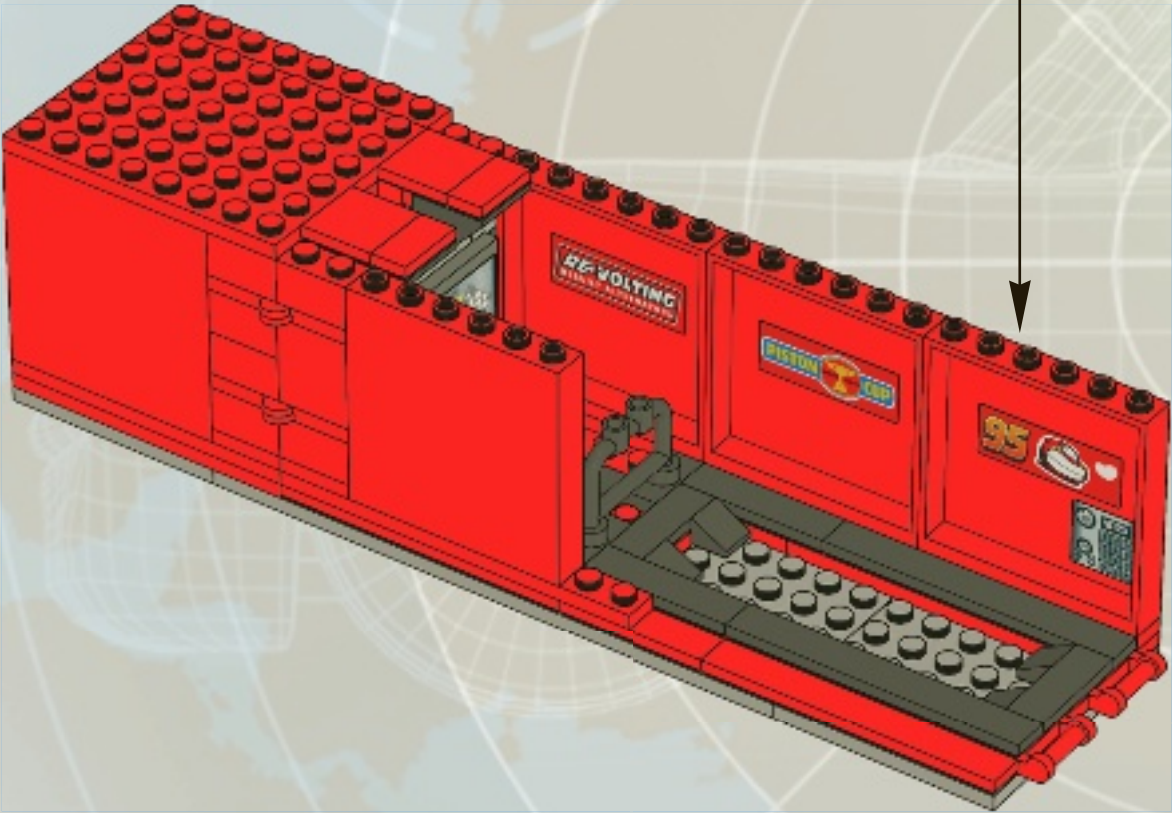
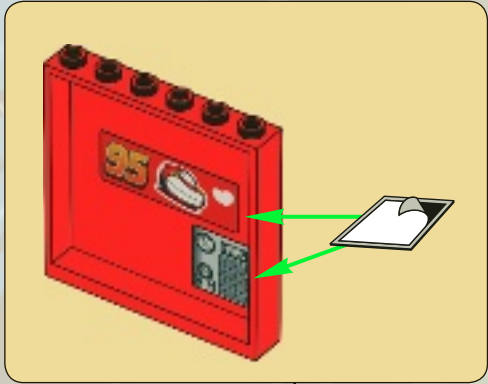



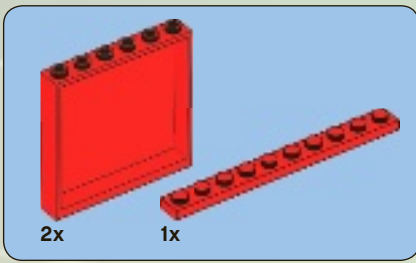

# 42

target  
acquired

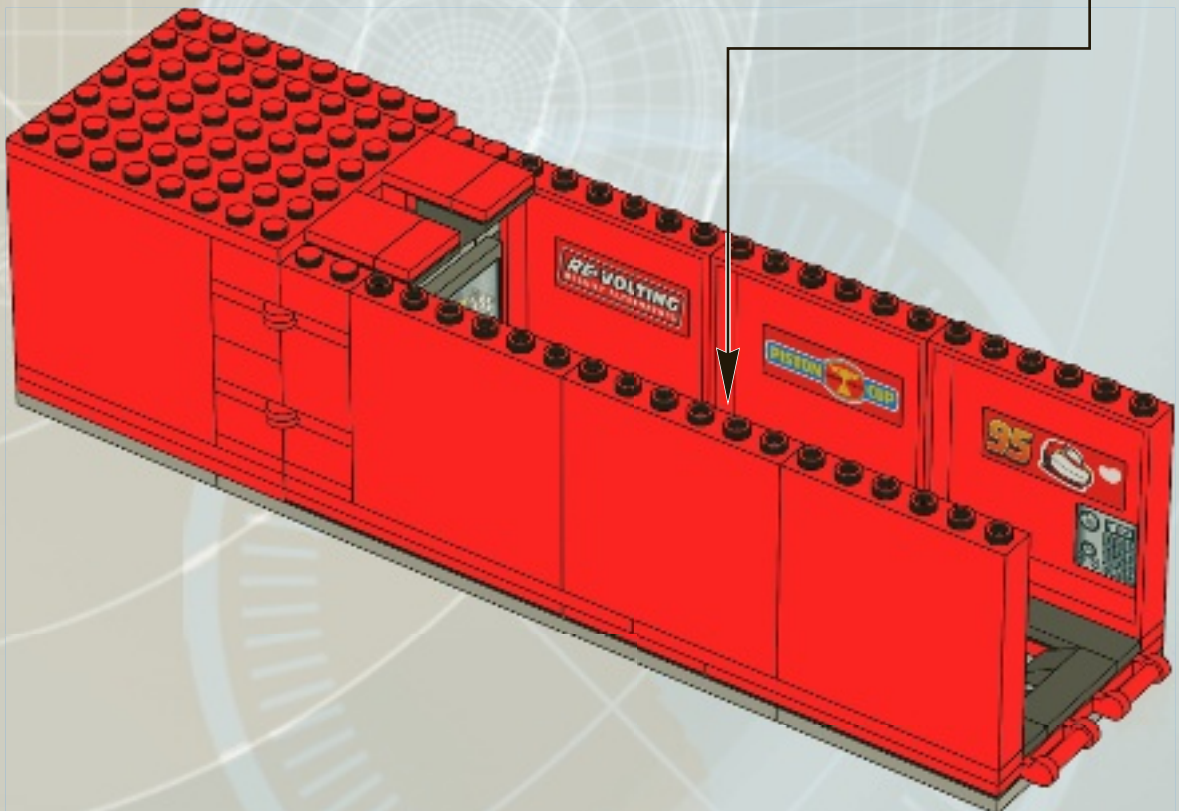
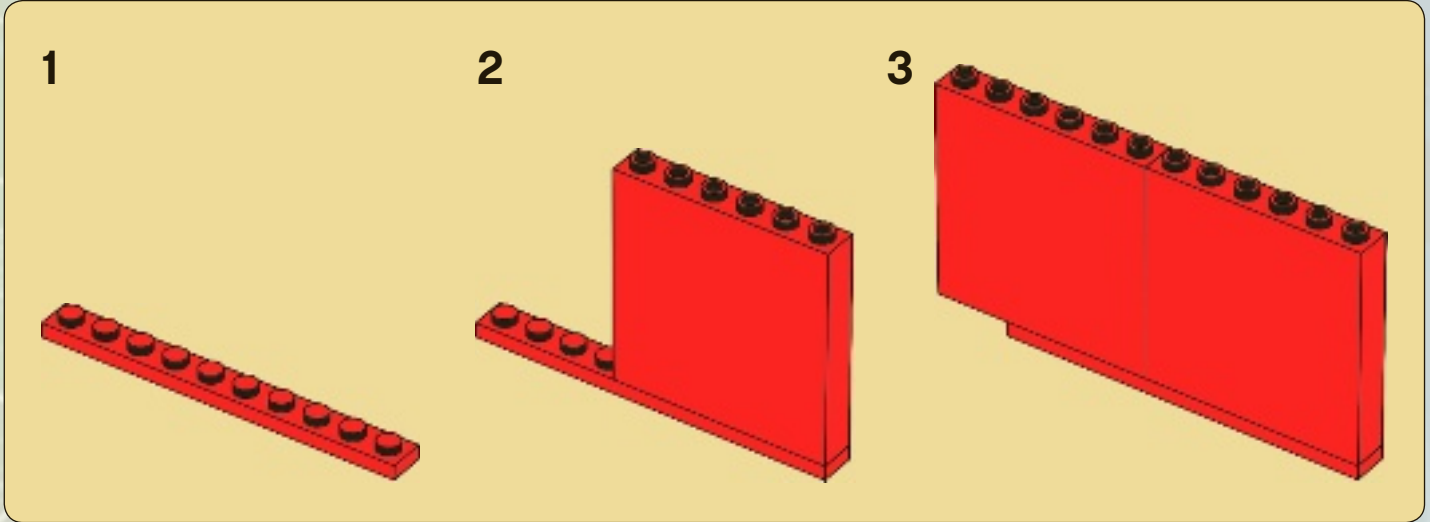

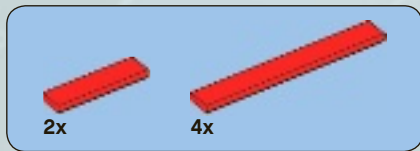

43

waypoint 1

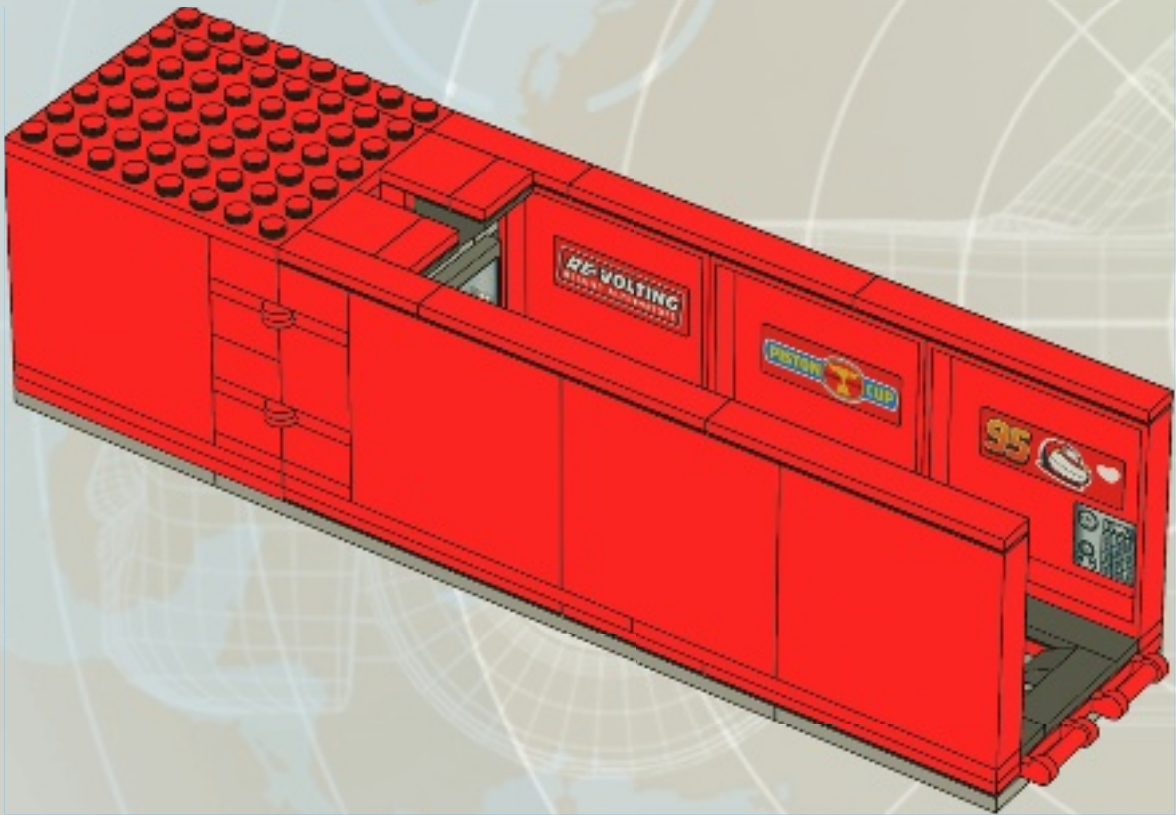

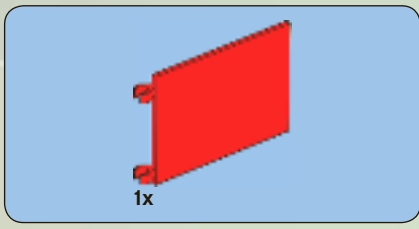

44

target  
acquired

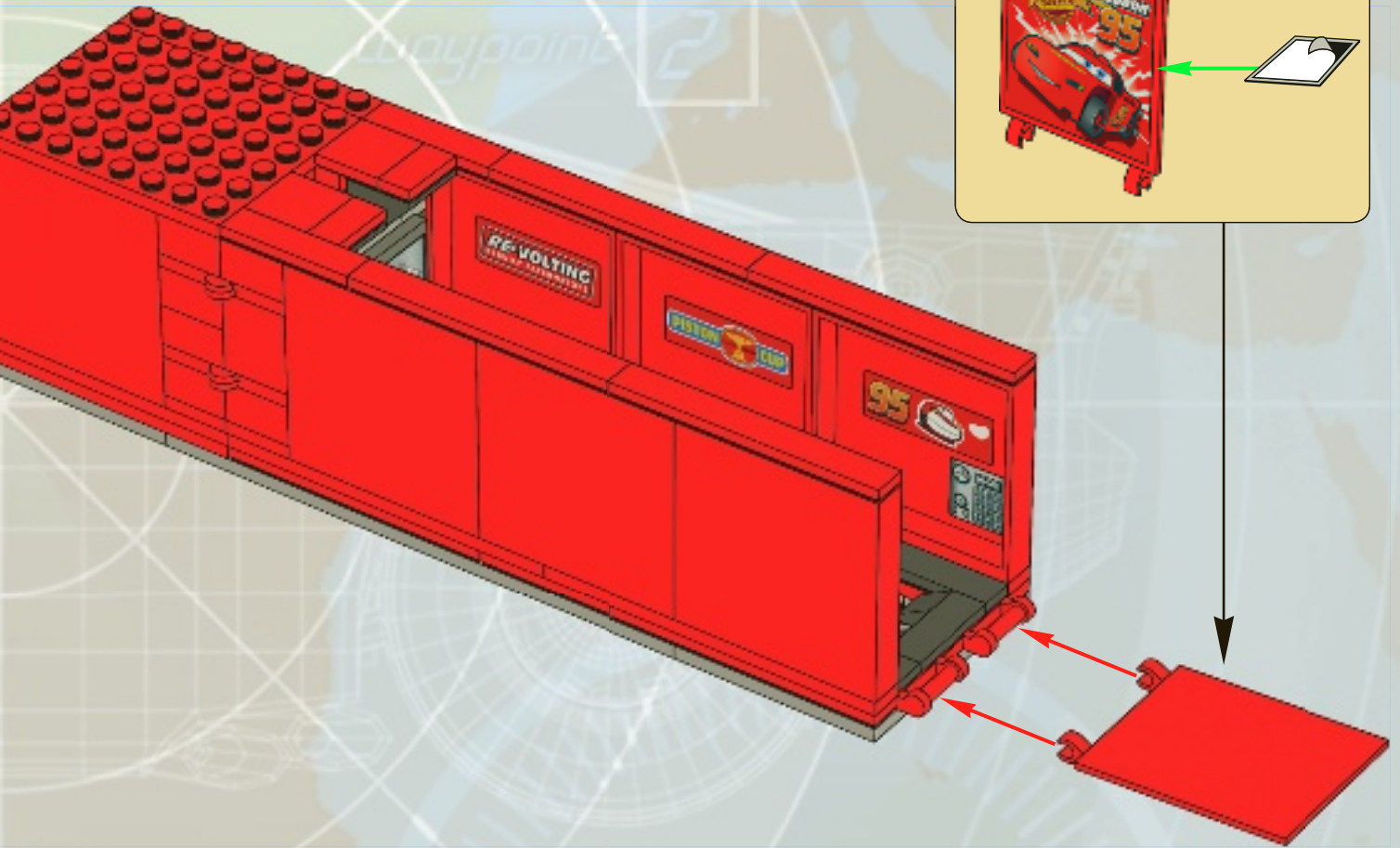

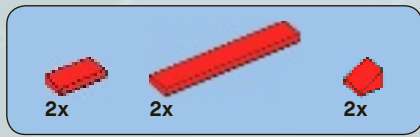

45

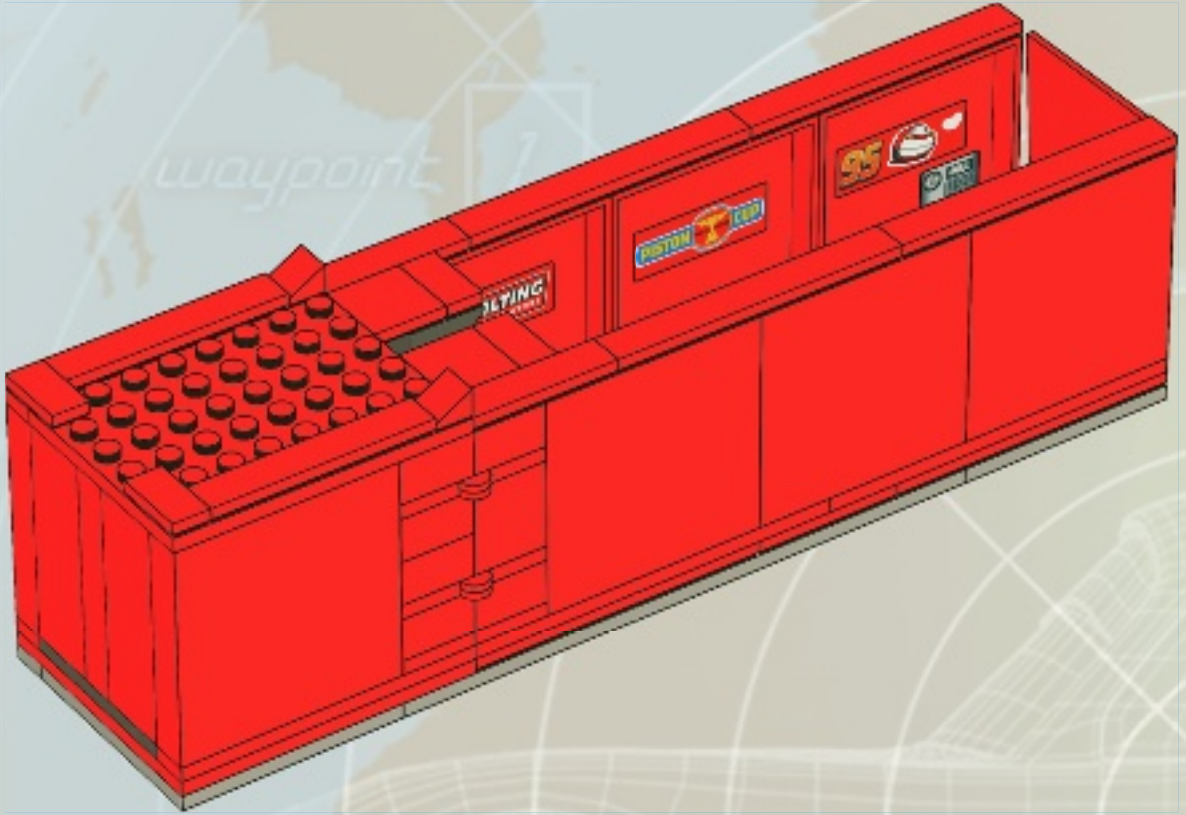

46

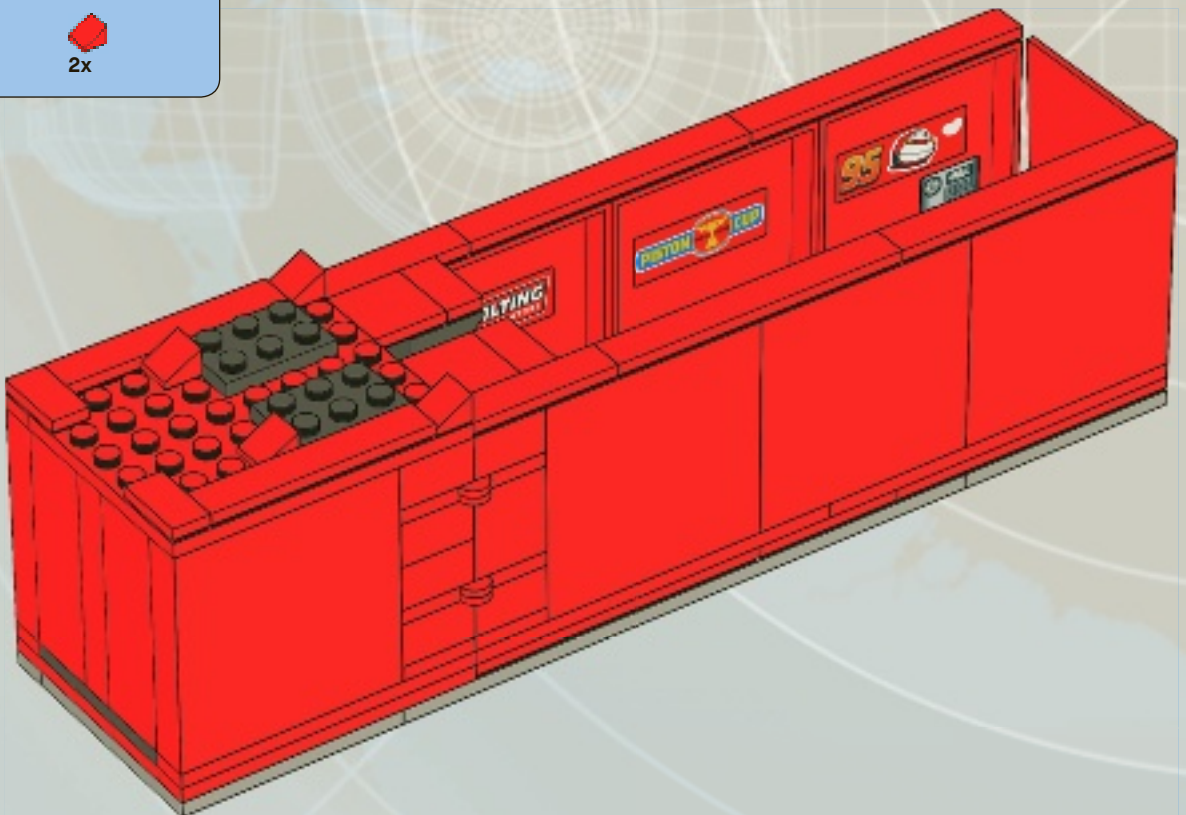



47

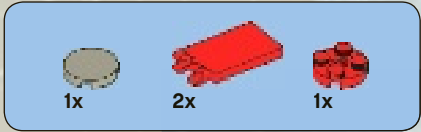
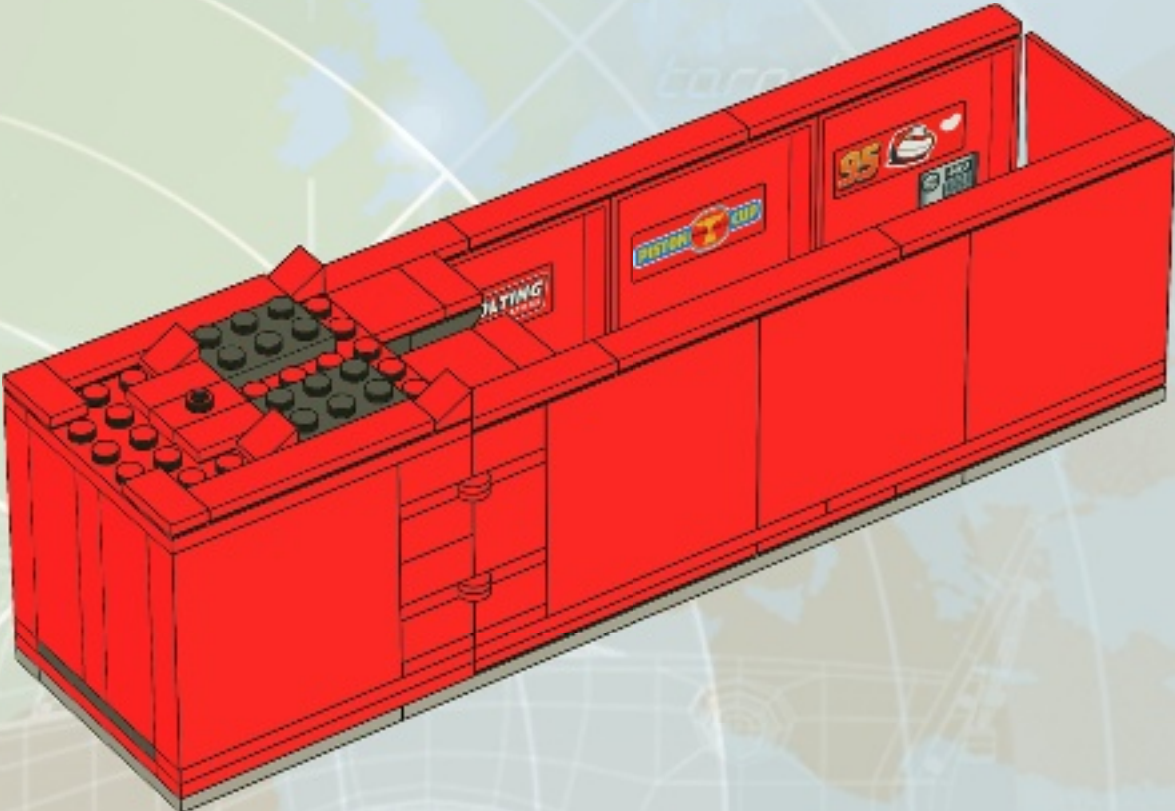

48

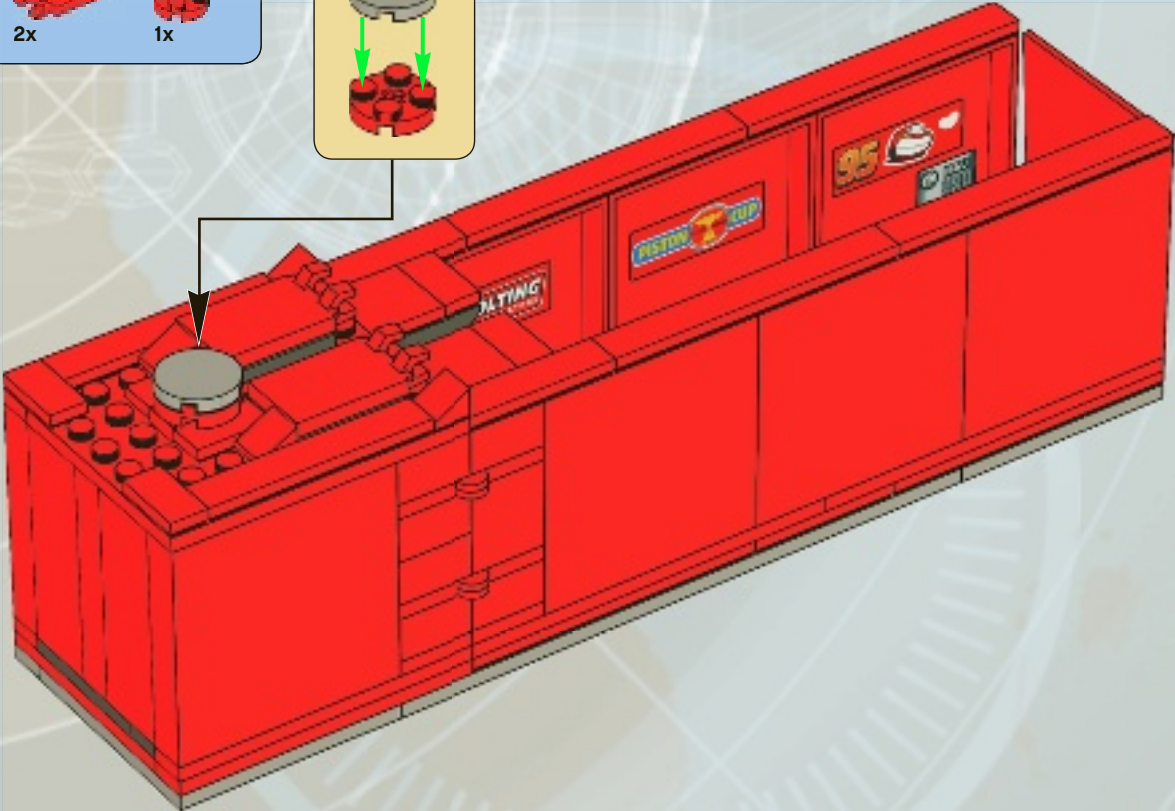
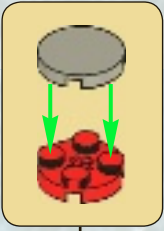

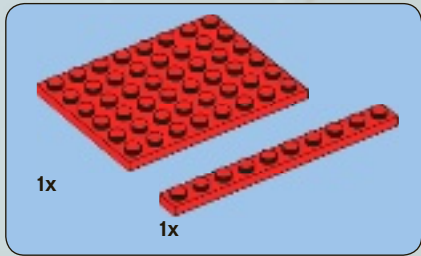
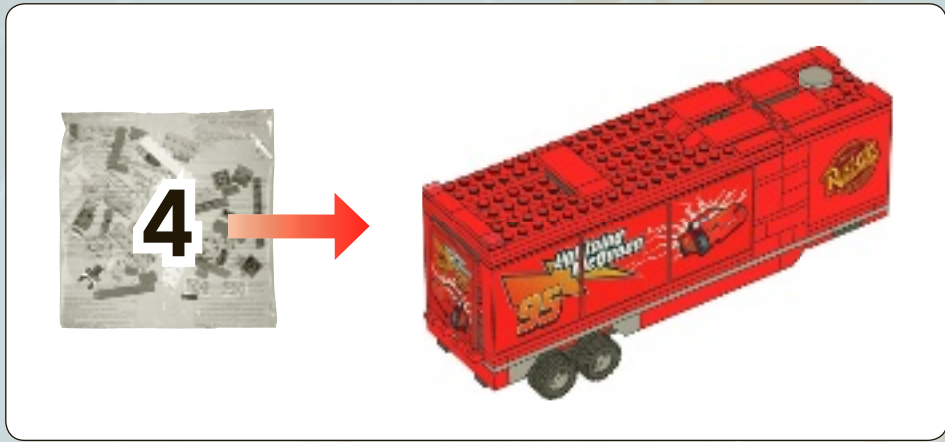

1

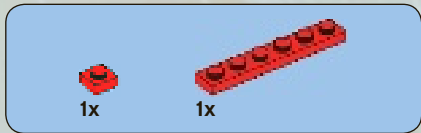
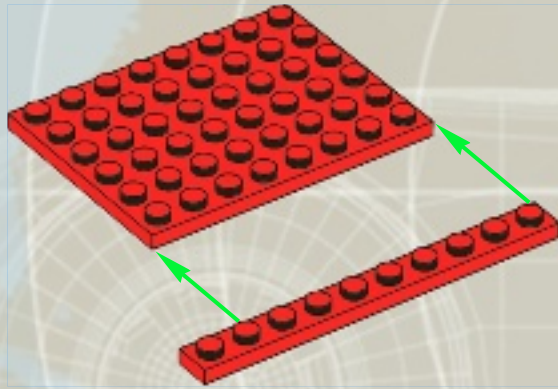

2

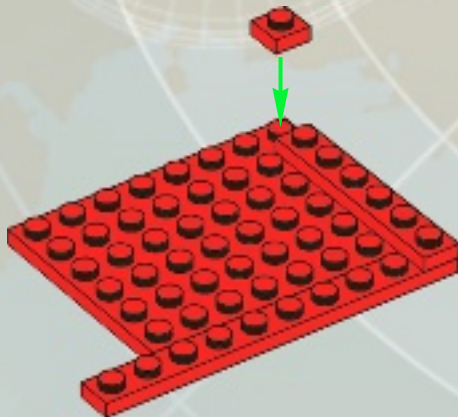

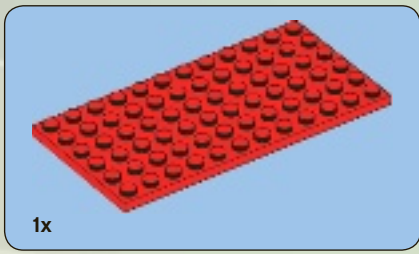

3

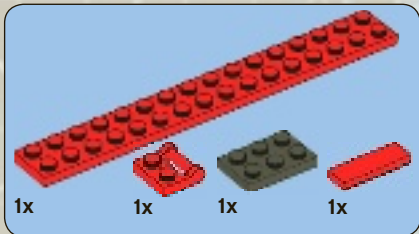
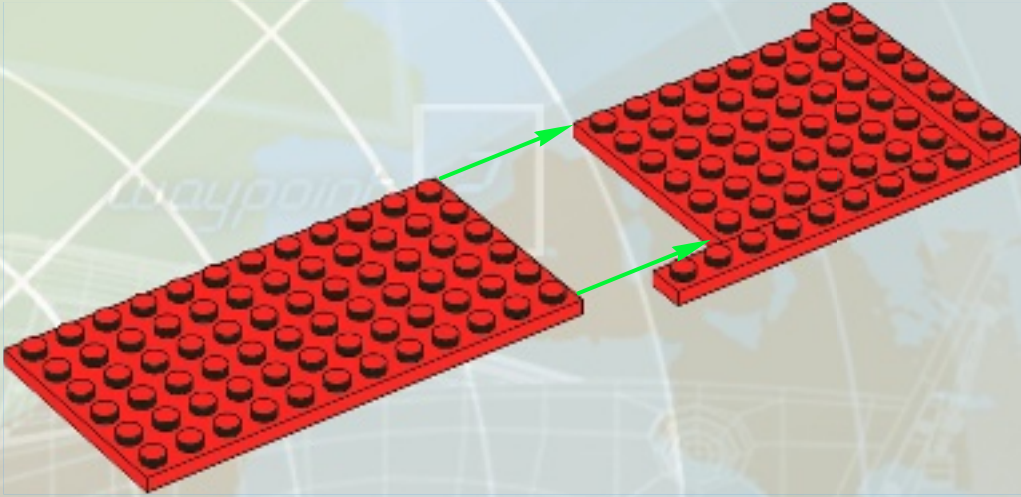

4

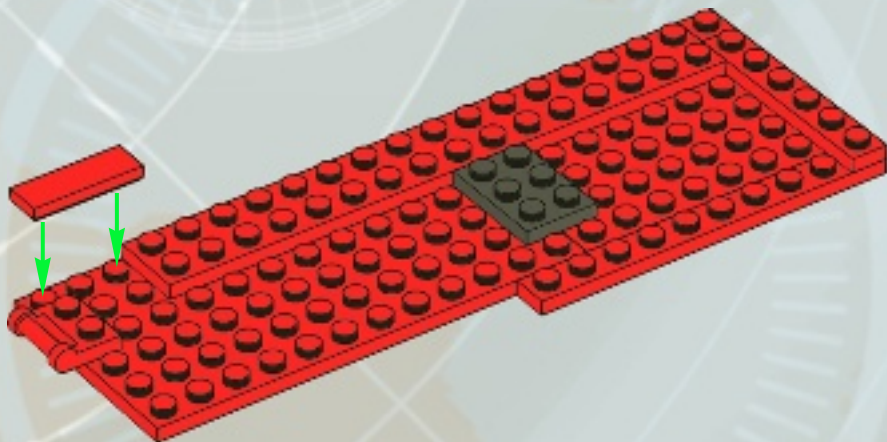

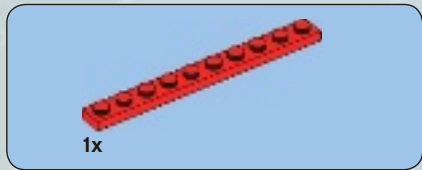

5

waypoint 1

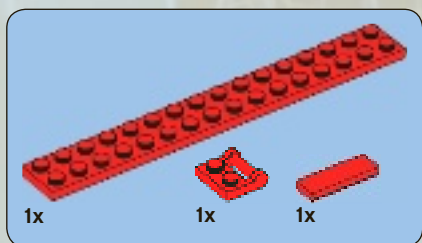
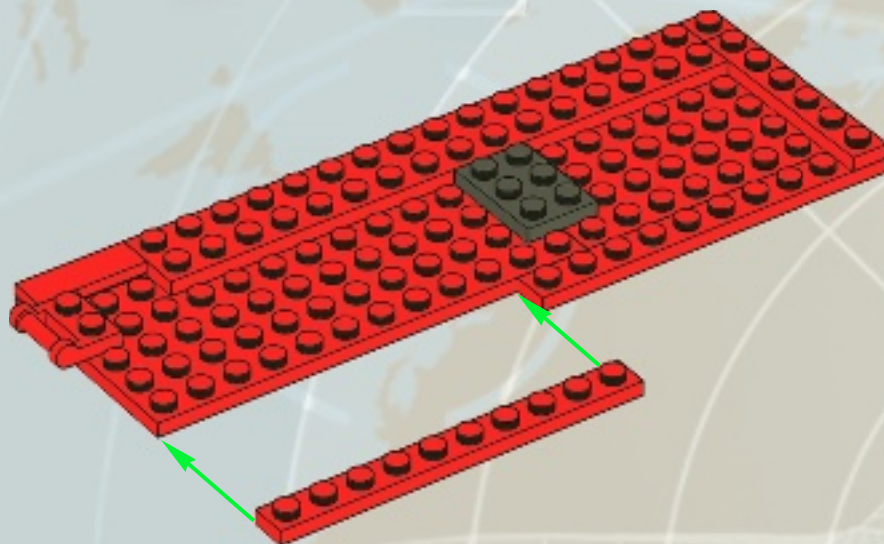

6

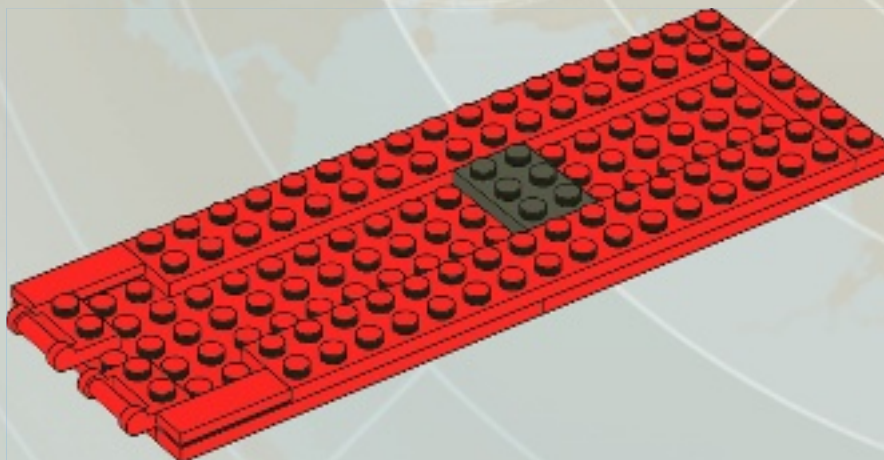



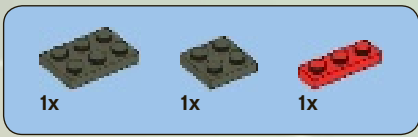

7

target  
acquired

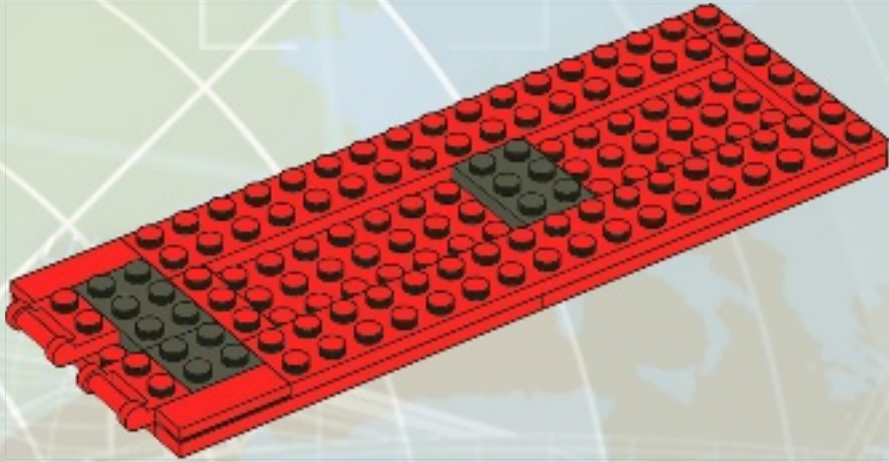

8

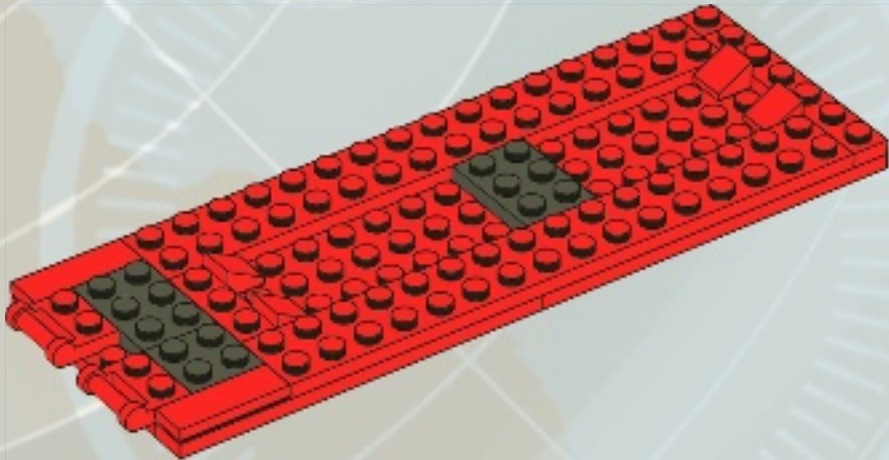

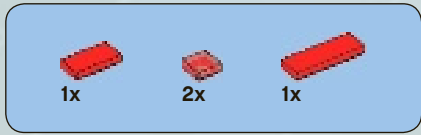

9

waypoint 1

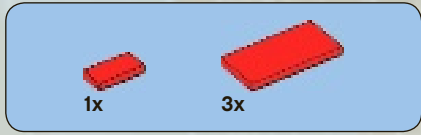
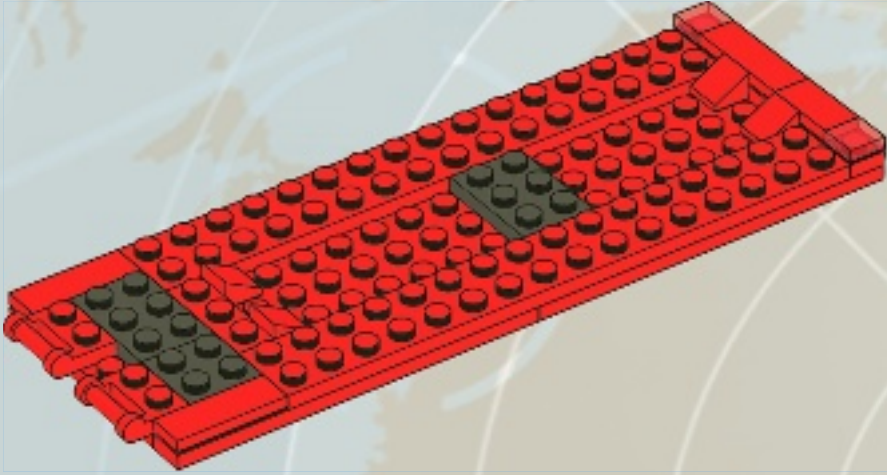

10

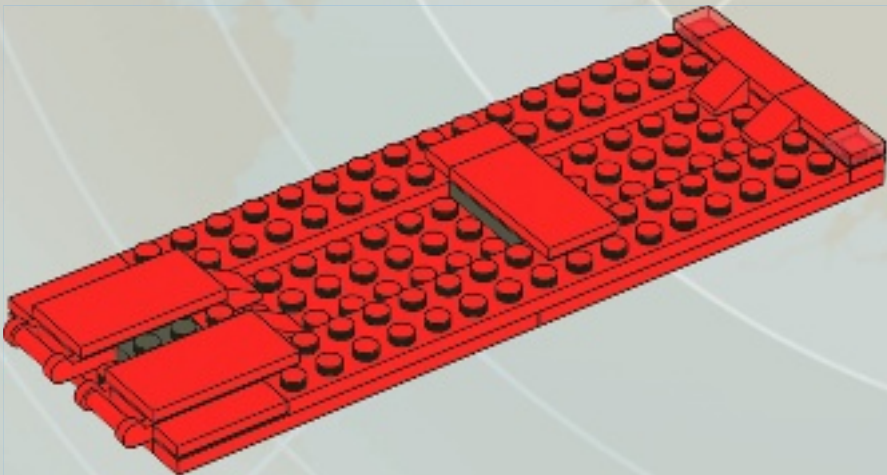

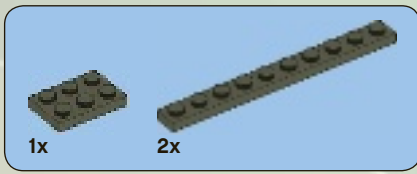

11

target  
acquired

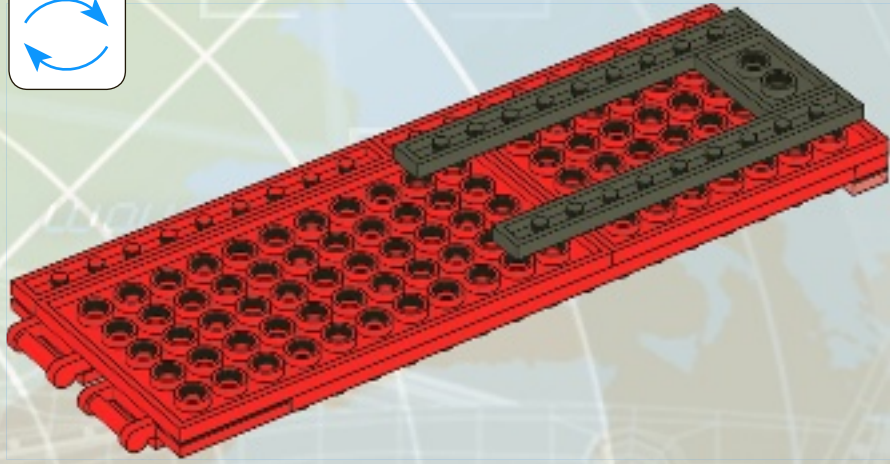
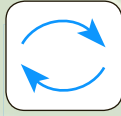

12

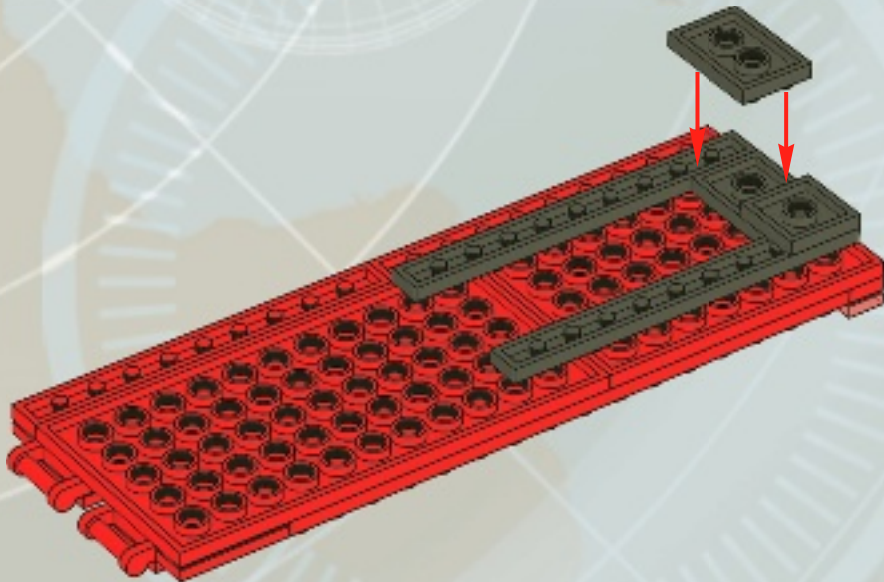

13

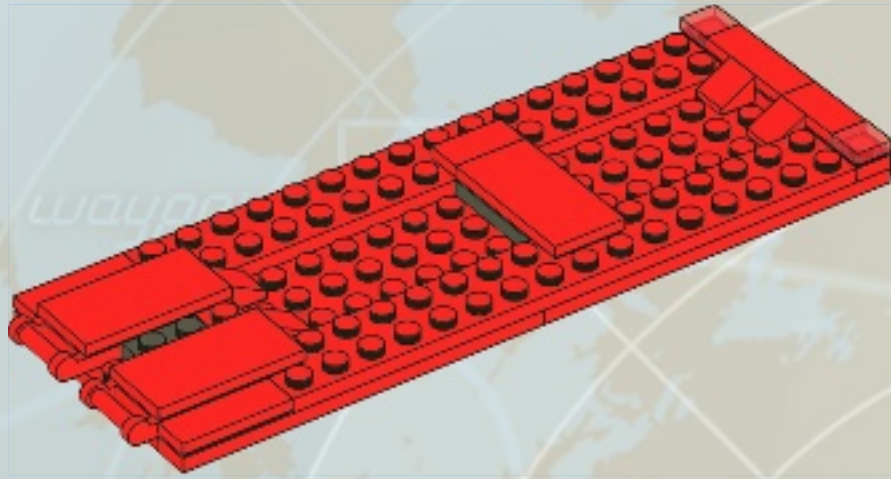

14

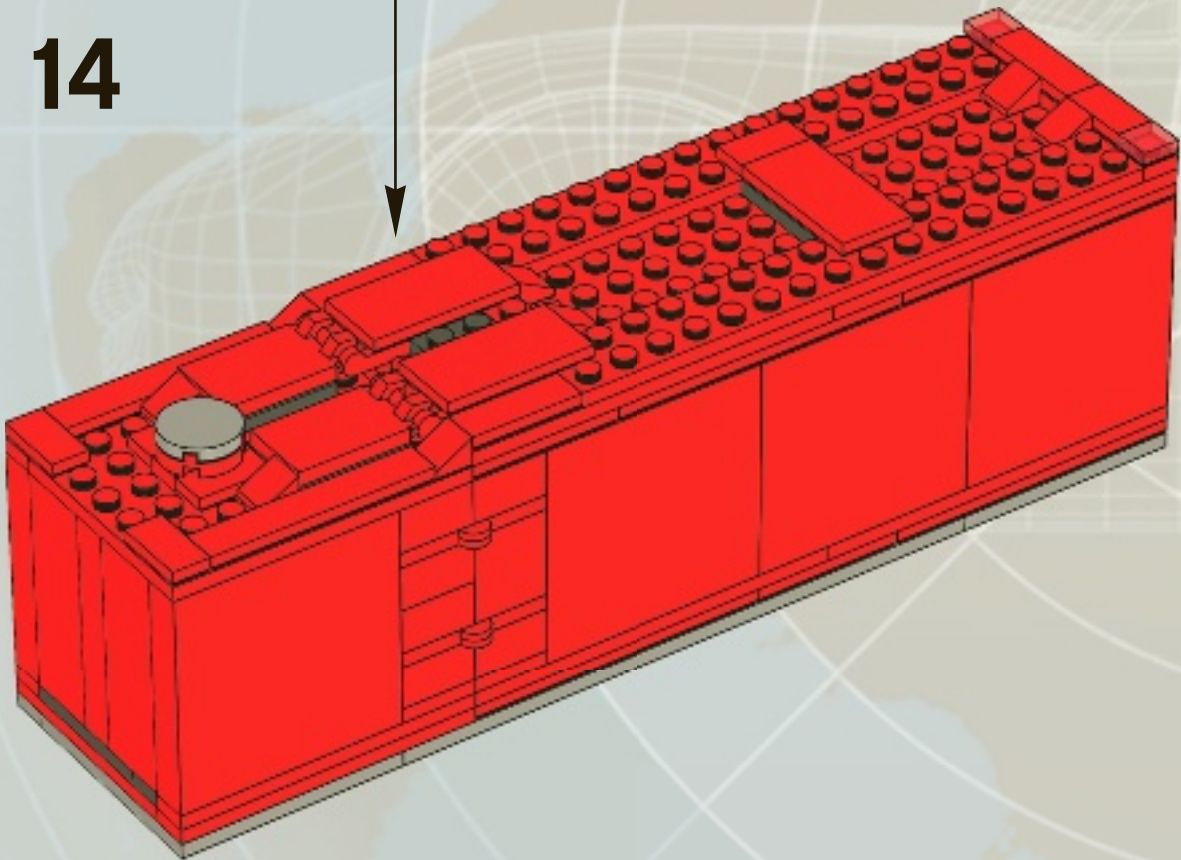

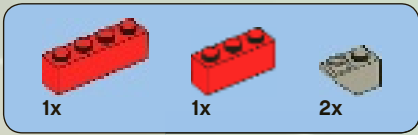

15

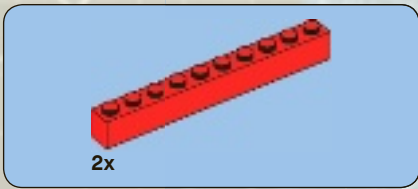
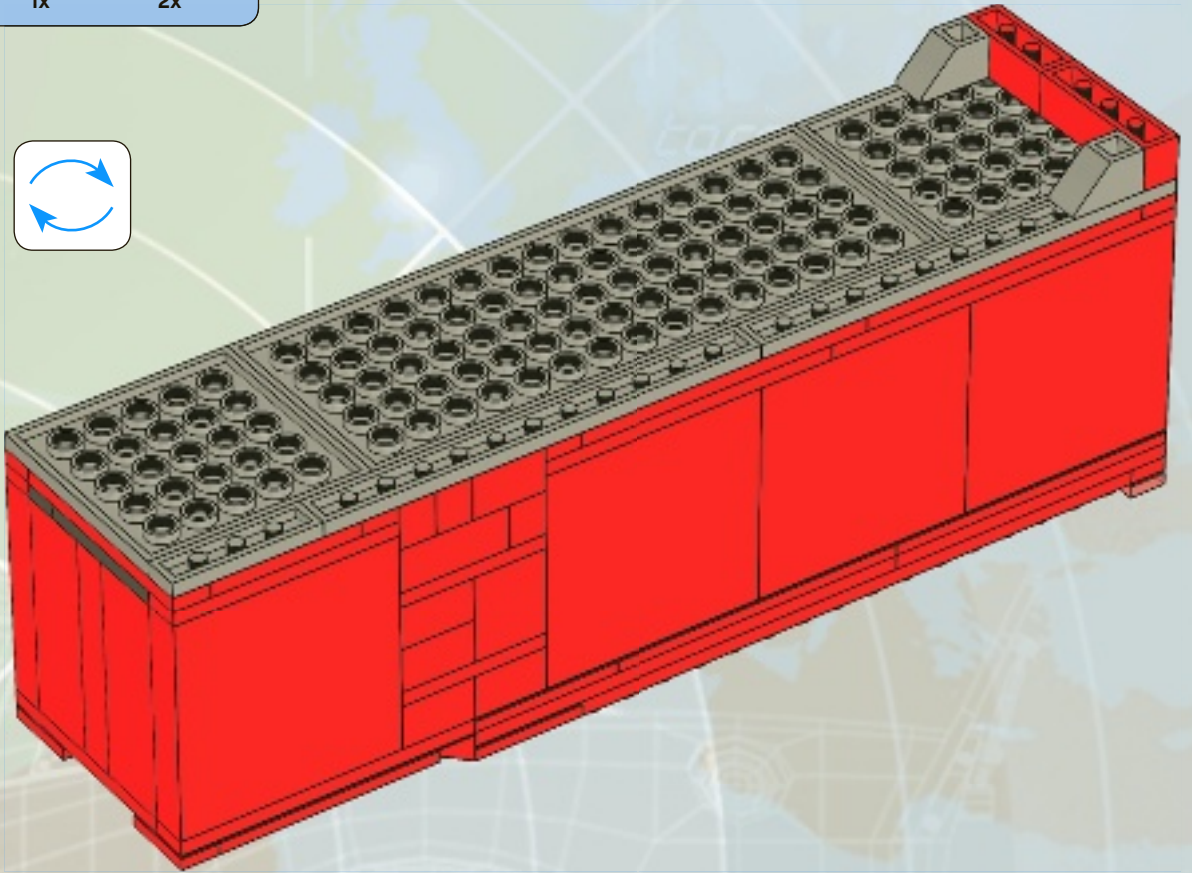

16

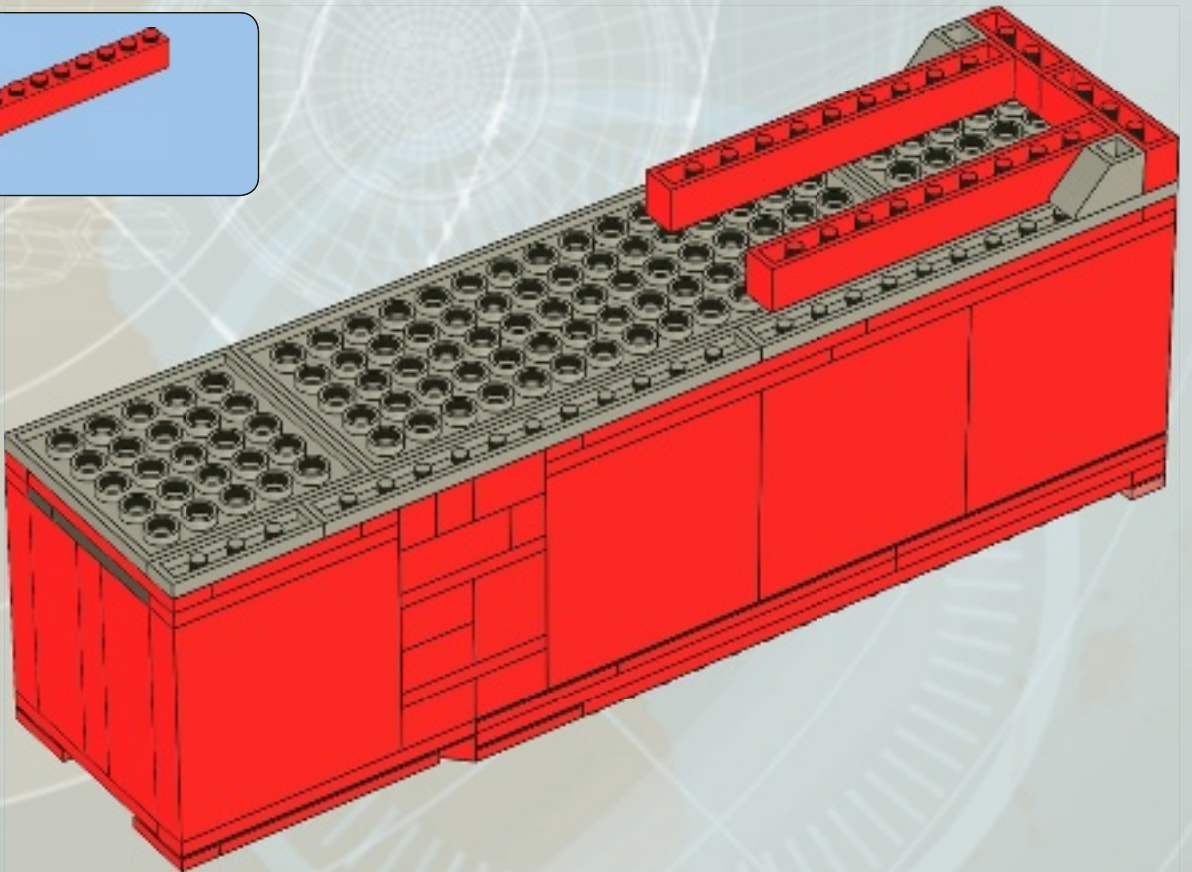



# 17

waypoint 1

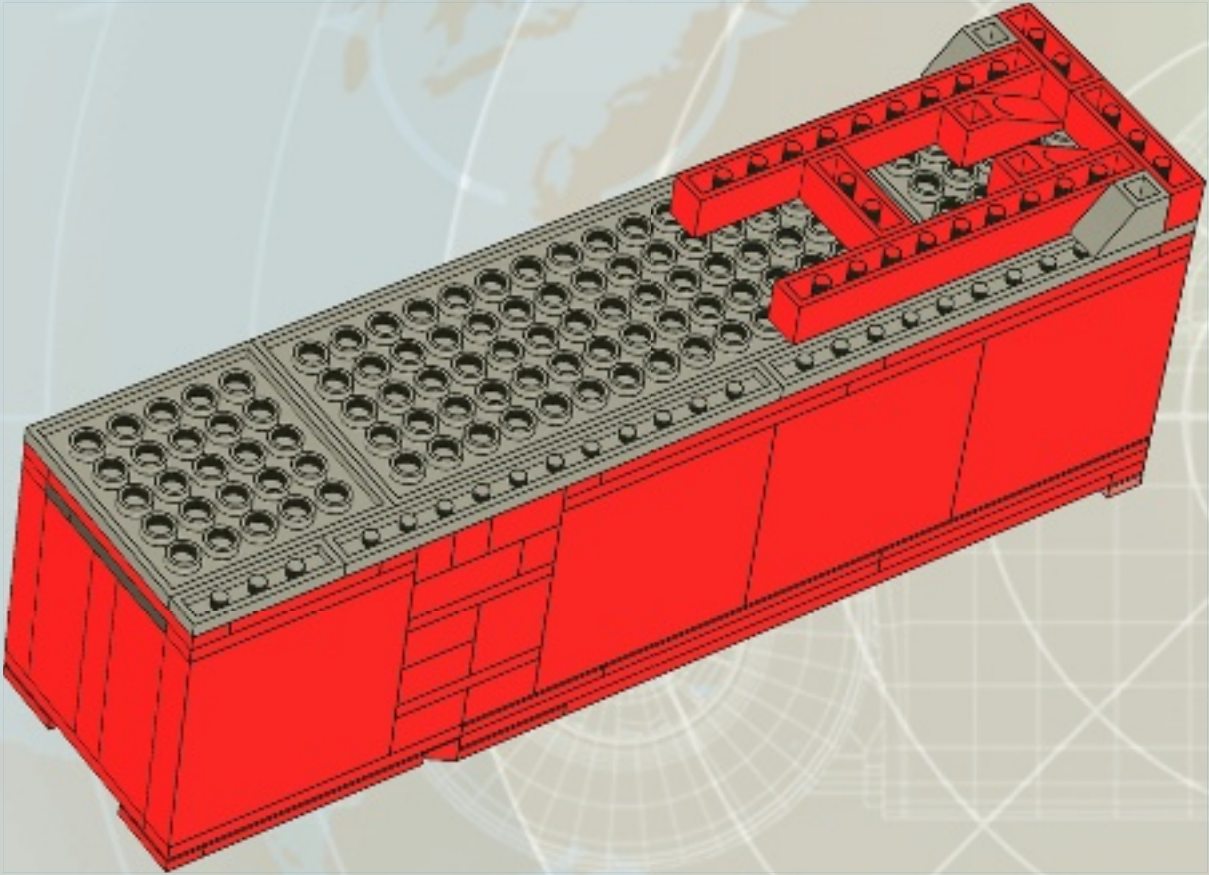

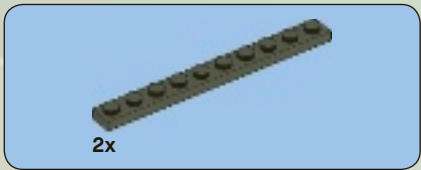

18

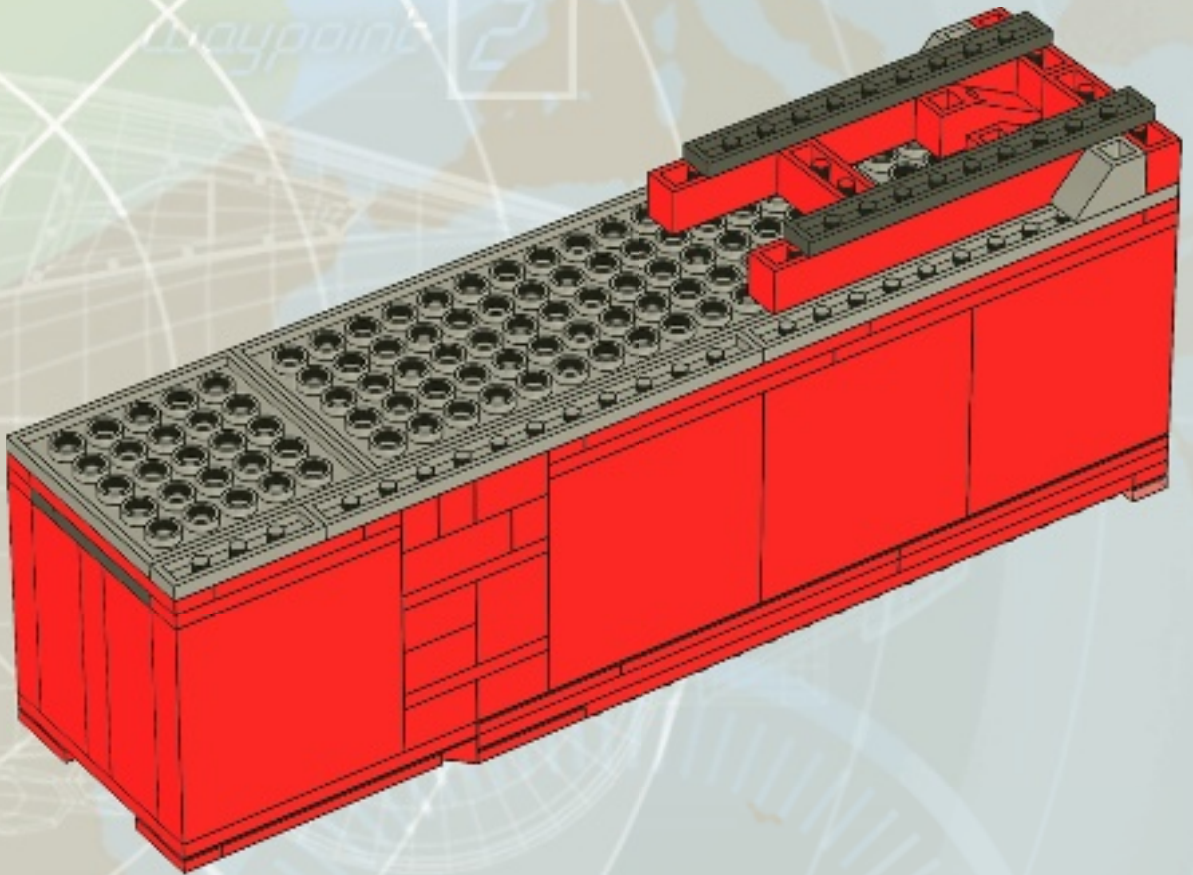

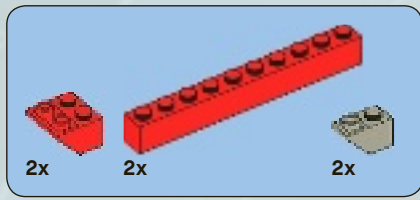

19

waypoint 1

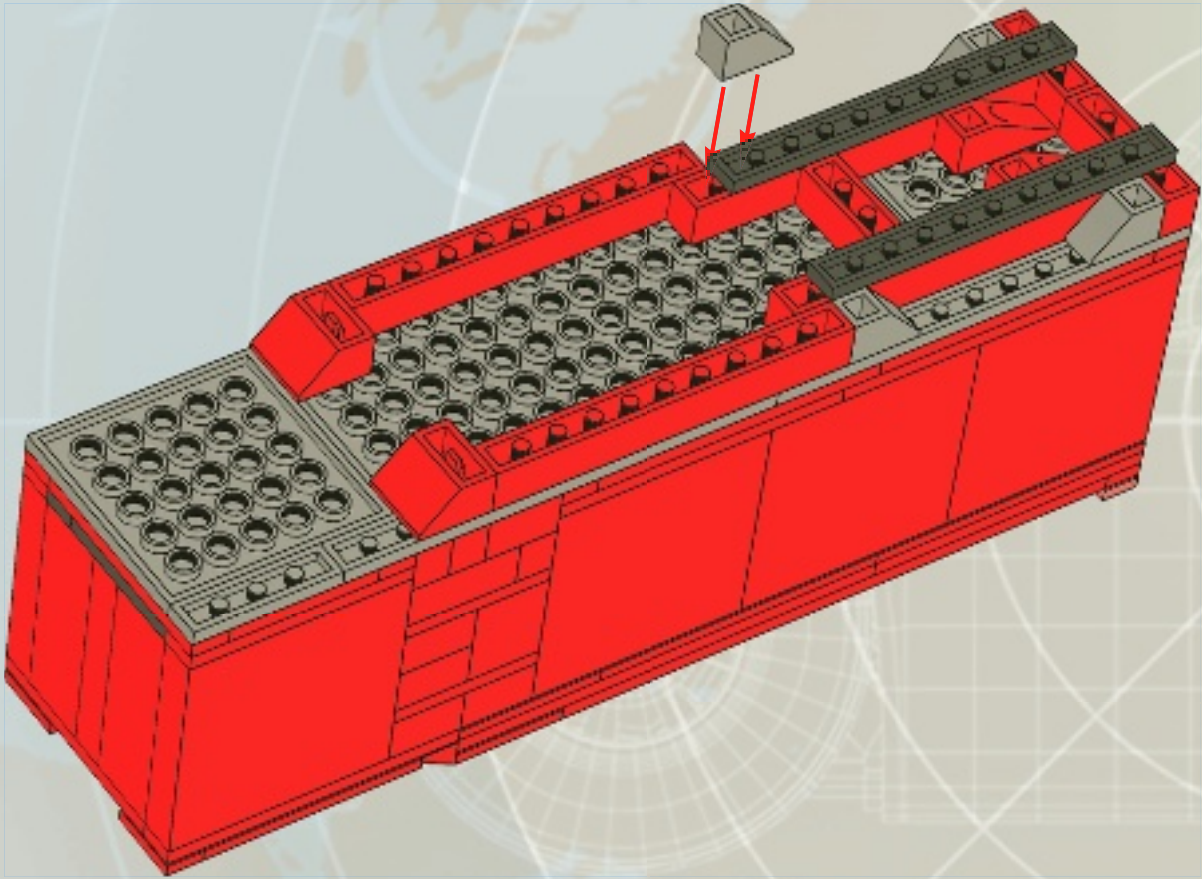





# 20

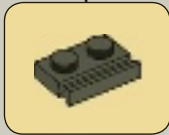
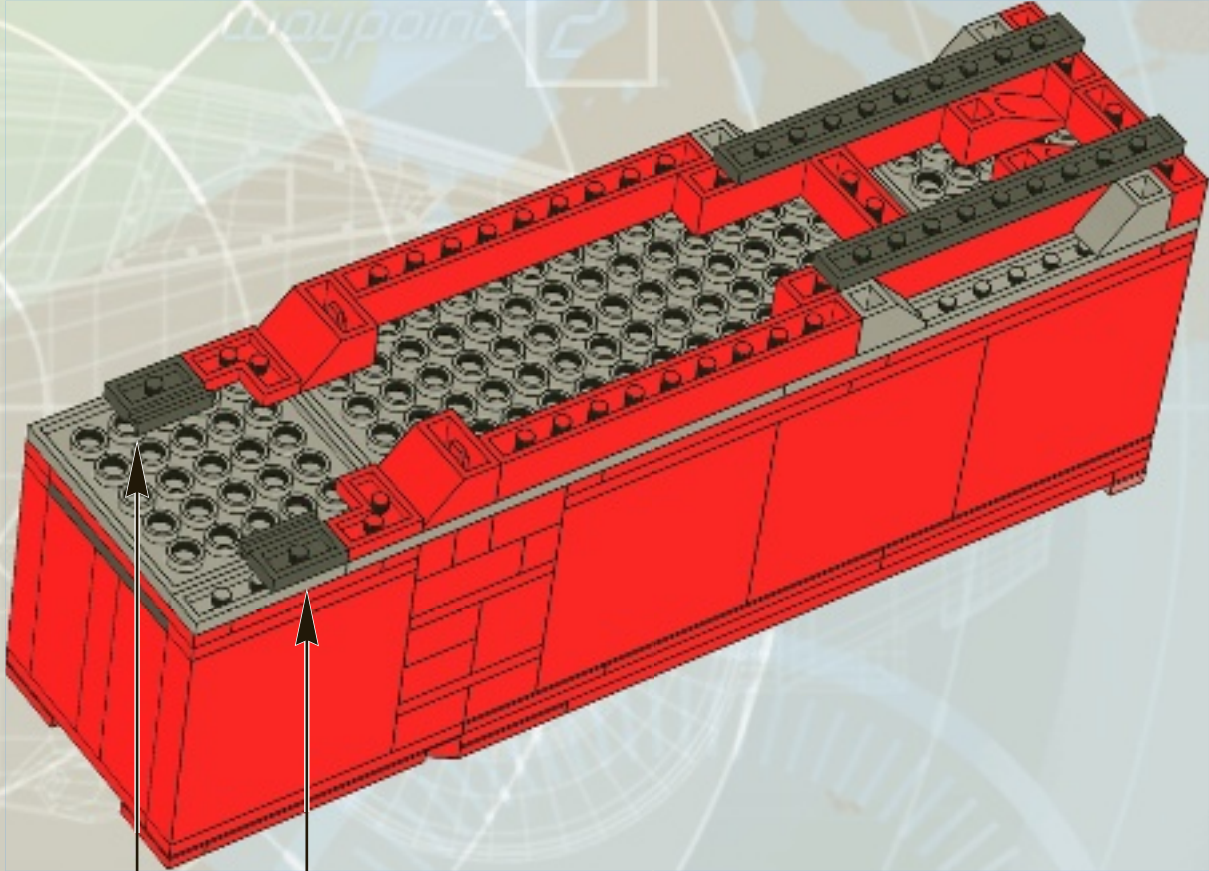

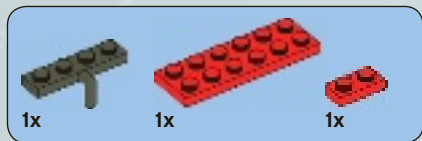

21

waypoint 1

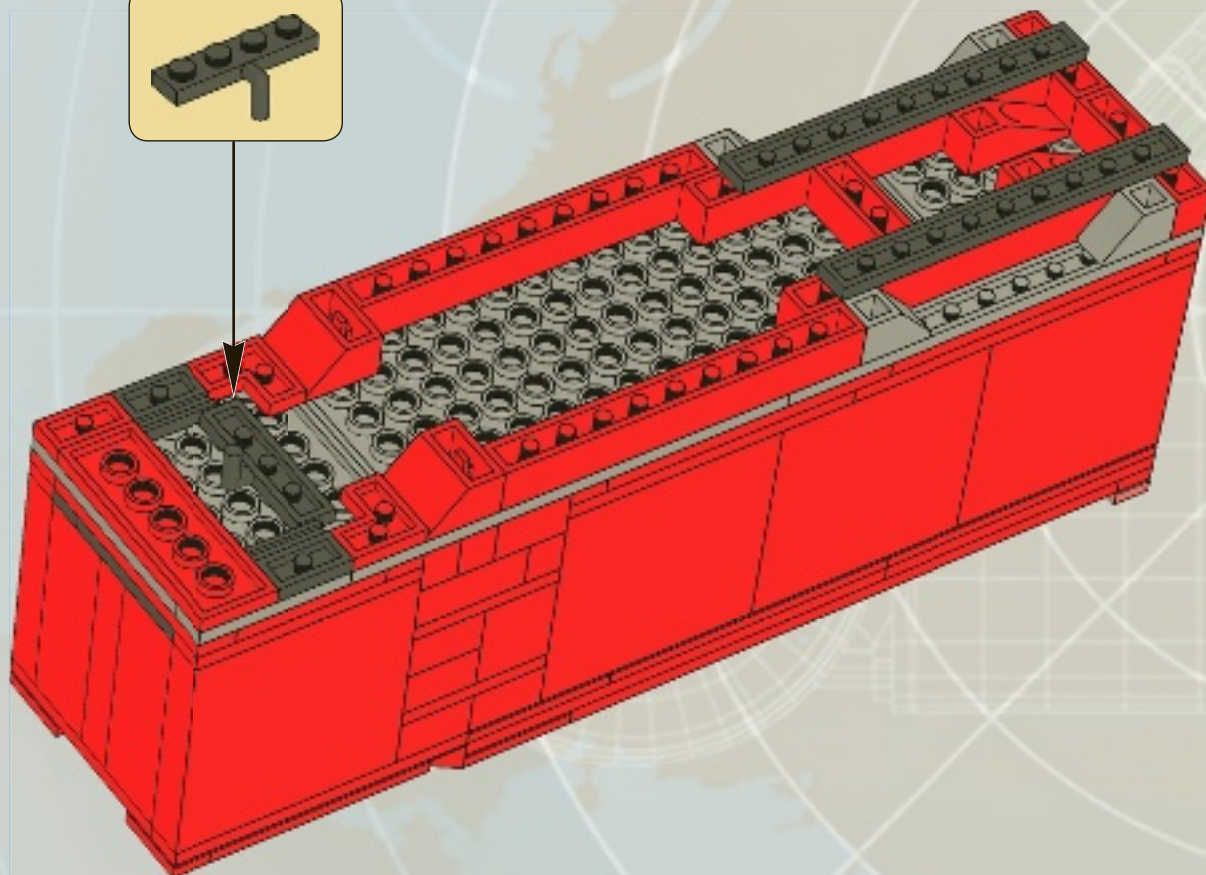
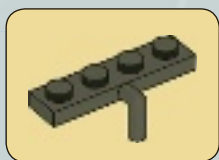

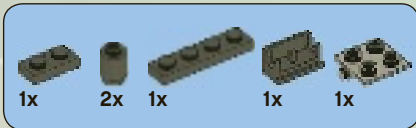

# 22

*target  
acquired*

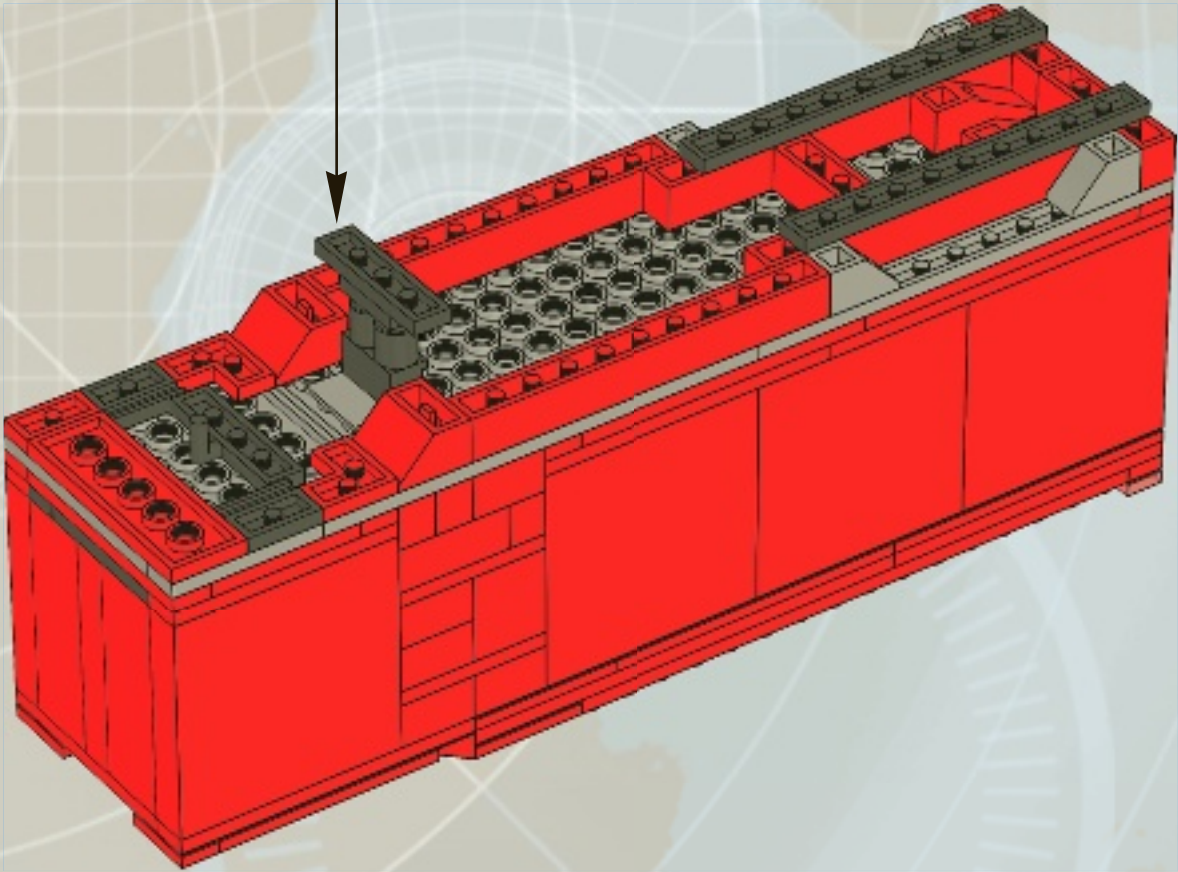
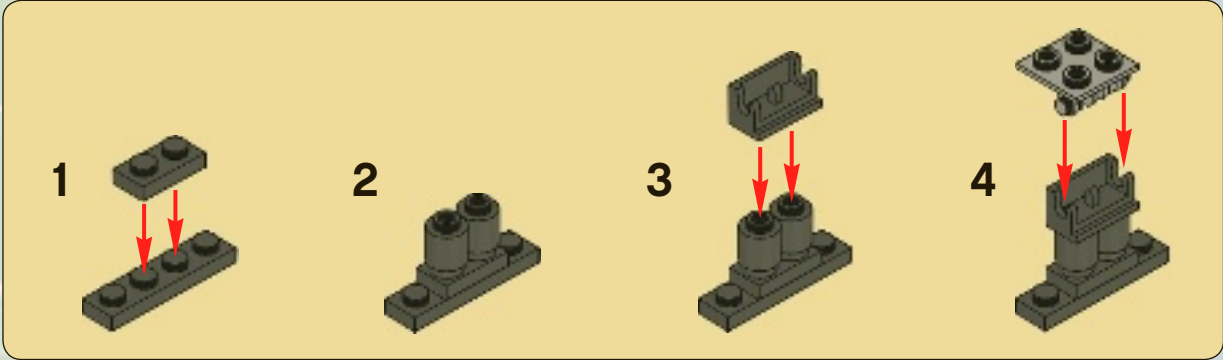



1x

1



1x

2



1x

3

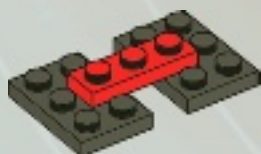

4x

4

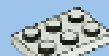
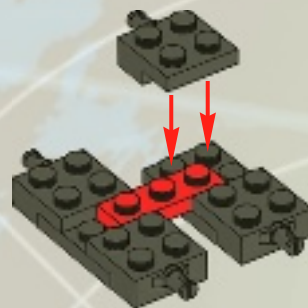

2x

5

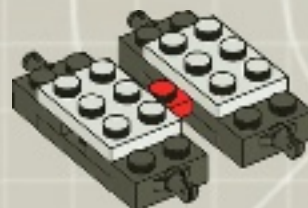

2x

6

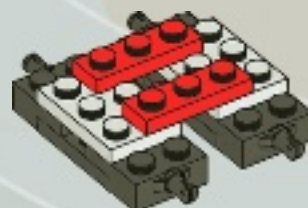

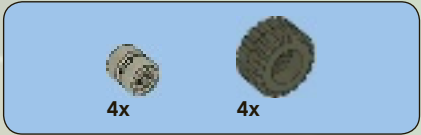

7



23

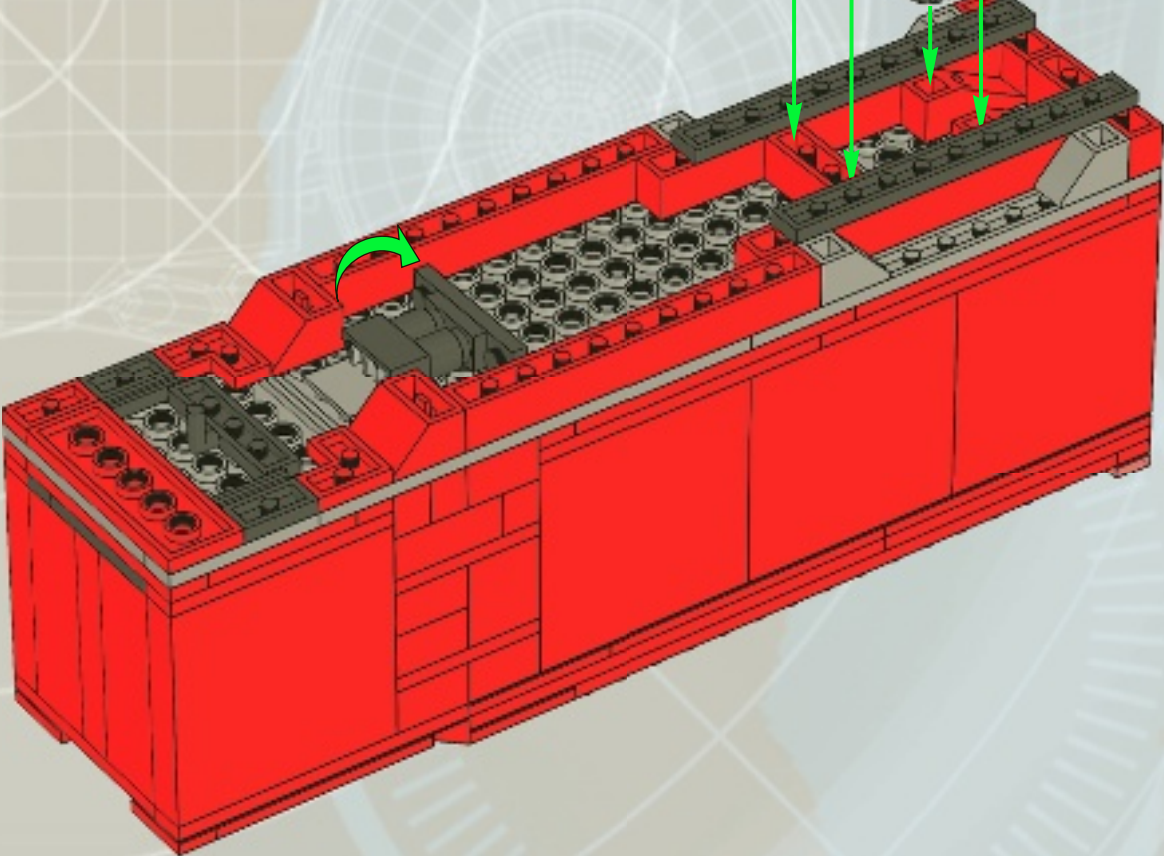
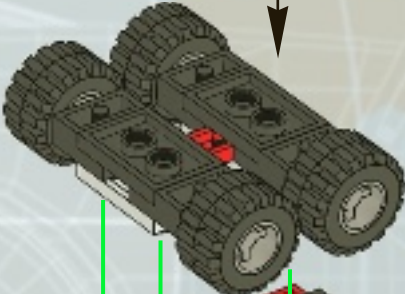

waypoint 1

24

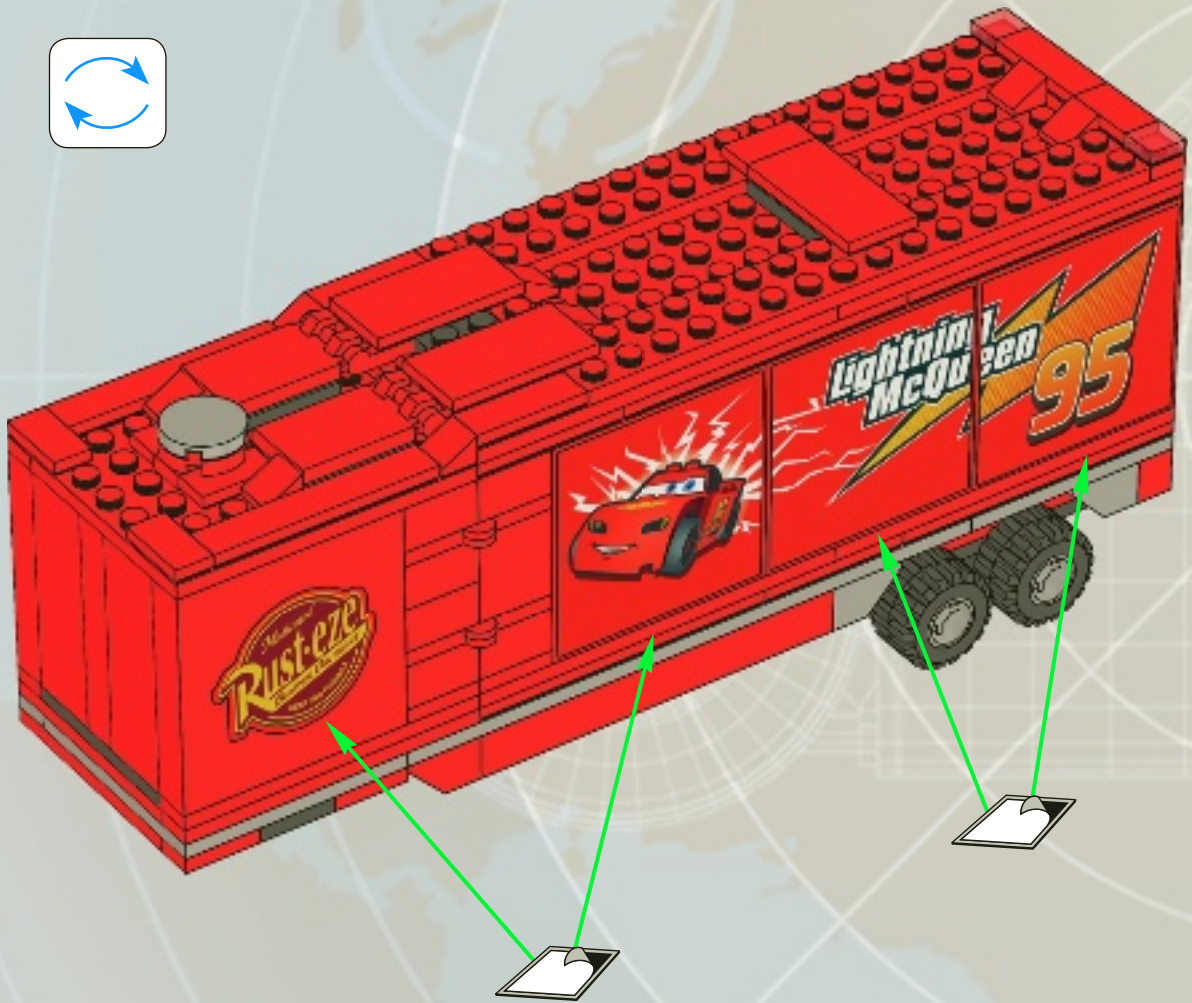

target  
acquired

25

waypoint 2

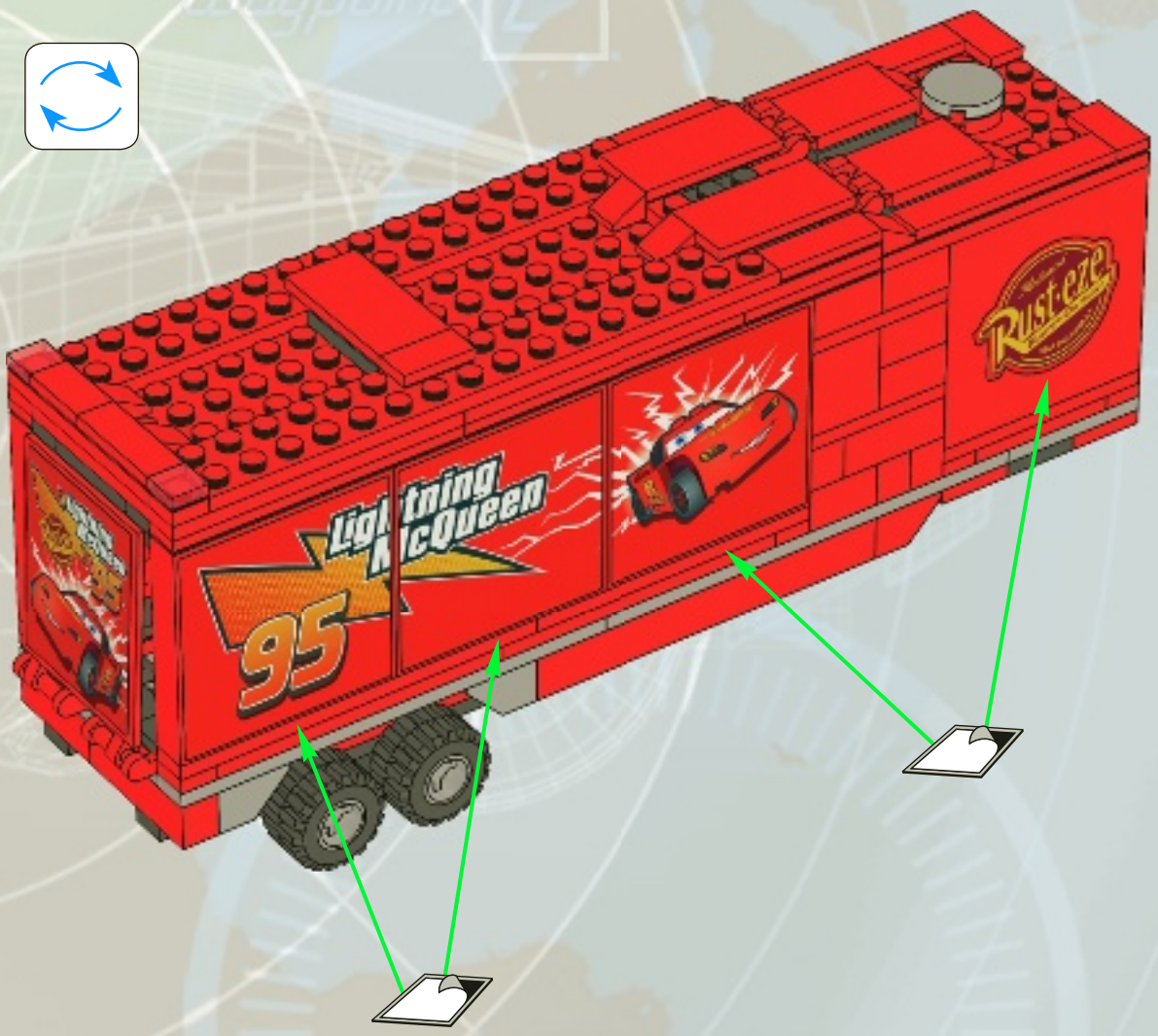
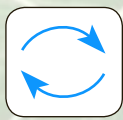

waypoint 1

26





27





*Rust-eze*  
Rust-eze  
Rust-eze

**Lightning  
McQueen**  
**95**

*Mack*

**95**

*Rust-eze*

**95**





5x  
302301

4x  
235721

1x  
4116617

1x  
303221

2x  
4282742

2x  
302101

2x  
362221

2x  
371021

3x  
303421

2x  
4616800

1x  
4523403

4x  
300121

3x  
4560179

6x  
447721

2x  
4530734

8x  
4504379

5x  
300921

1x  
4616125

2x  
303621

2x  
74230

1x  
300521

1x  
4181138

1x  
4616123

1x  
4617409

1x  
4180504

1x  
4212410

4x  
611121

7x  
302021

1x  
4617409

1x  
4180533

5x  
300421

2x  
654121

3x  
379421

2x  
428221

1x  
403221

4x  
4143832

1x  
4622728

6x  
366621

2x  
4505067

4x  
4613159

2x  
4212414

1x  
4617273

2x  
4113858

8x  
4505067

1x  
4613132

2x  
300321

2x  
366021

1x  
4243814

1x  
4617399

6x  
307021

5x  
4226876

2x  
428721

1x  
379521

1x  
4616120

4x  
302421

2x  
300221

2x  
609121

4x  
346021

1x  
4616119

4x  
302321

4x  
301021

2x  
4631357

6x  
416221

4x  
306921

10x  
306921

2x  
302221

8x  
242021

10x  
362321

3x  
4533742

3x  
243121

1x  
4616127

1x  
4617271

1x  
379523

2x  
4143005

1x  
370126

5x  
4504382

2x  
366526

2x  
366026

3x  
371026

1x  
4243819

1x  
379526

2x  
416226

1x  
303226

4x  
447726

2x  
362226

1x  
301026

2x  
306226

1x  
300526

2x  
4618852

1x  
302426

3x  
302326

4x  
302226

2x  
4558170

8x  
302126

3x  
243126

4x  
4246901

10x  
4514560

1x  
393726

6x  
379426

1x  
4556158

2x  
4107761

4x  
448826

1x  
3004326

2x  
615726

1x  
408326

1x  
4140303

1x  
370926



1x  
4143199



2x  
428226



2x  
4211474



1x  
4211733



2x  
4514846

2x  
4594238

6x  
4211350

2x  
4244627

6x  
4211496

2x  
4613165

1x  
4211480

2x  
4263192

10x  
4211764

4x  
4211437



2x  
4518653

3x  
4211429

7x  
4211445

2x  
4211395

1x  
4211881

4x  
4211389

2x  
4211613

3x  
302328

1x  
4211085

1x  
4598769

1x  
4509911

1x  
4211042

2x  
3003941

1x  
4213119

1x  
4159007



Customer Service

Kundenservice

Service Consommateurs

Servicio Al Consumidor

[www.lego.com/service](http://www.lego.com/service) or dial



00800 5346 5555 :



1-800-422-5346 :





**[LEGO.com/CARS](http://LEGO.com/CARS)**





8486



8200, 8487



8423, 8639



8638



8639



8424



8639



8638



8426



8201, 8487



8424



8638



8639



8426, 8639



8638



8487



8487



8638



8206



8639



8639



8487



8426



8638



8423



8486



8487



8206, 8484

# WIN!

Go to [www.LEGOsurvey.com/product](http://www.LEGOsurvey.com/product) to fill out a survey for a chance to win a cool LEGO® Product. No purchase necessary. Open to all residents where not prohibited.

## [www.LEGOsurvey.com/product](http://www.LEGOsurvey.com/product)

### GEWINNE!

Nimm an der Umfrage auf [www.LEGOsurvey.com/product](http://www.LEGOsurvey.com/product) teil und hab die Chance ein cooles LEGO® Produkt zu gewinnen!

Die Teilnahme am Gewinnspiel führt zu keinerlei Kaufverpflichtungen. Teilnahme in allen nicht ausgeschlossenen Ländern möglich.

### WIN!

Ga naar [www.LEGOsurvey.com/product](http://www.LEGOsurvey.com/product), vul een enquêteformulier in en maak kans op een cool LEGO® product.

Geen aankoopverplichting. Iedereen mag deelnemen, uitgezonderd ingezetenden van landen waar een enquêteverbod geldt.

### GAGNE!

Visite [www.LEGOsurvey.com/product](http://www.LEGOsurvey.com/product) pour répondre à un questionnaire et avoir une chance de gagner un produit LEGO® très cool!

Aucune obligation d'achat. Ouvert à tous les résidents des pays autorisés.

### 当てよう!

[www.LEGOsurvey.com/product](http://www.LEGOsurvey.com/product) アンケートにご記入ください。当選者は必ずして、製品を差し上げます。

お買い上げの必要はありません。禁止されていない限り、すべての皆様にご利用いただけます。