



# AGENTS

Three LEGO Agents characters are shown in the top right of the title banner. One is a woman with brown hair, another is a man with black hair, and the third is a character in a yellow and black tactical suit with a helmet.

8633



1

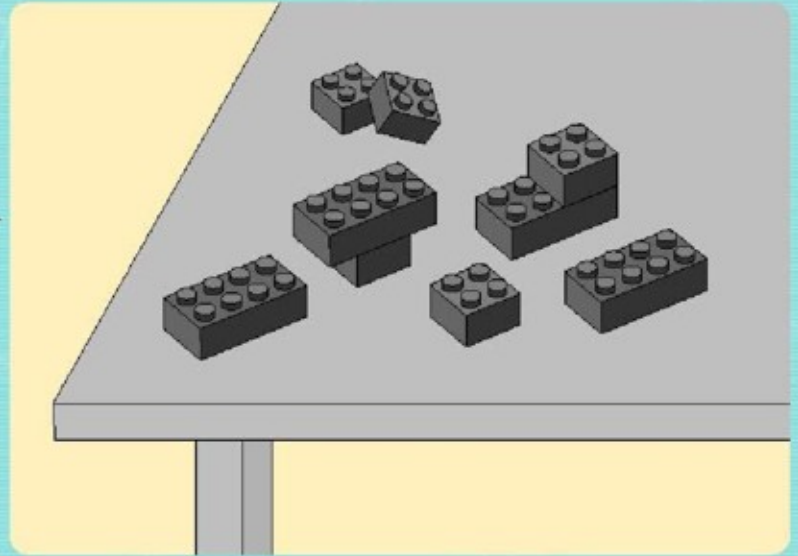

2





3

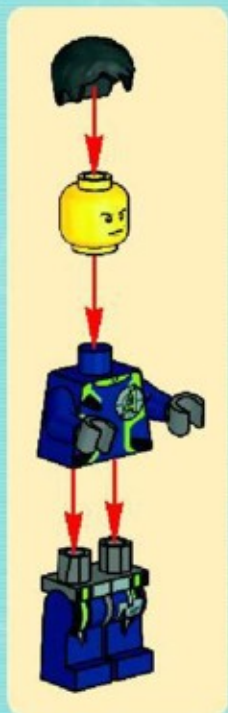

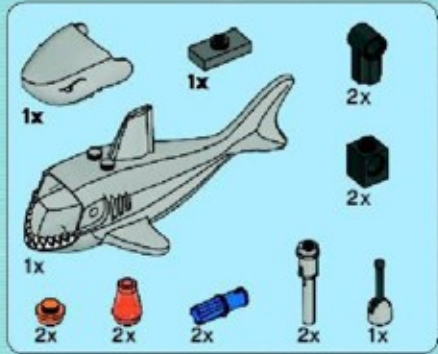

4

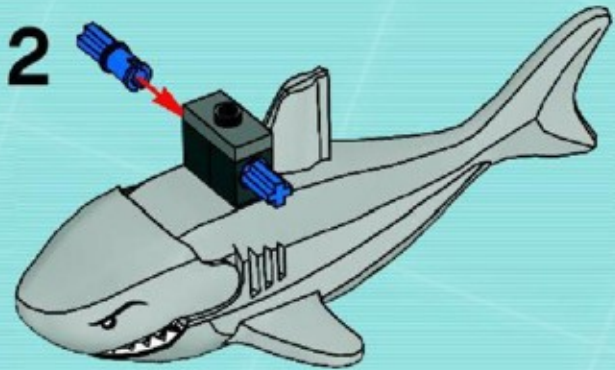
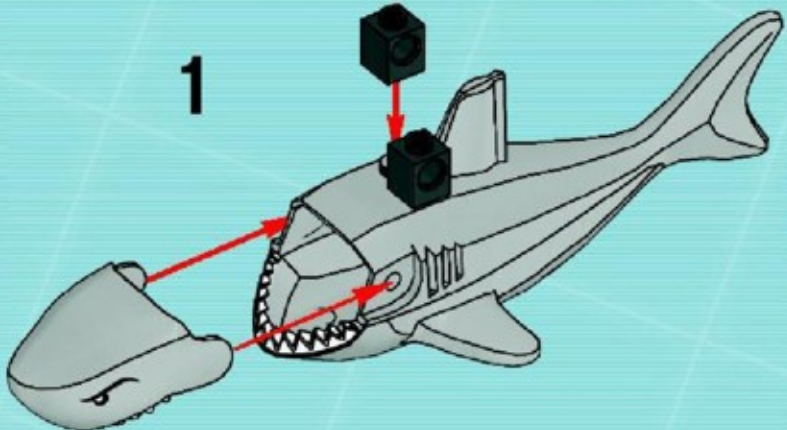

3

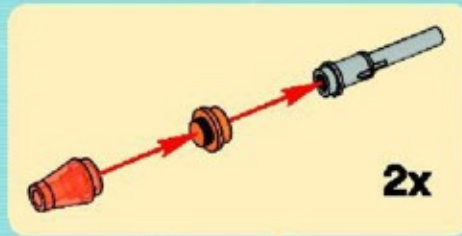
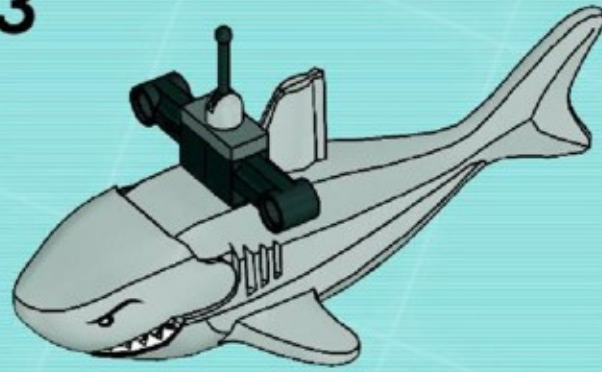

4



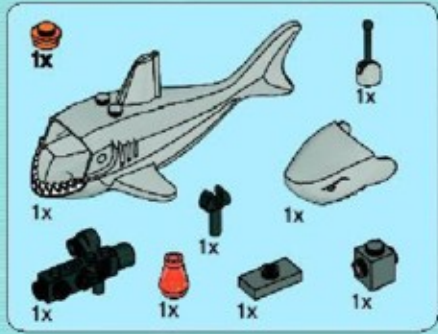
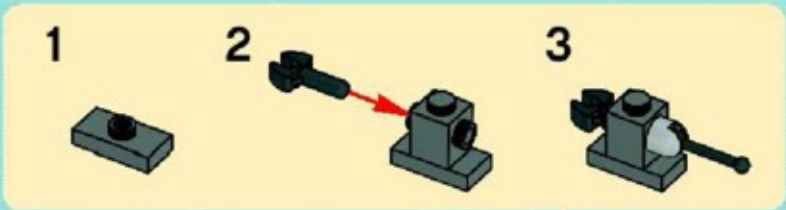
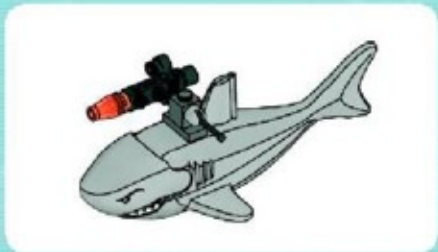

5

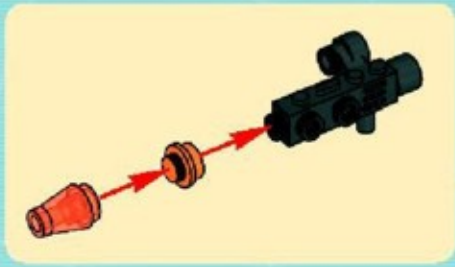
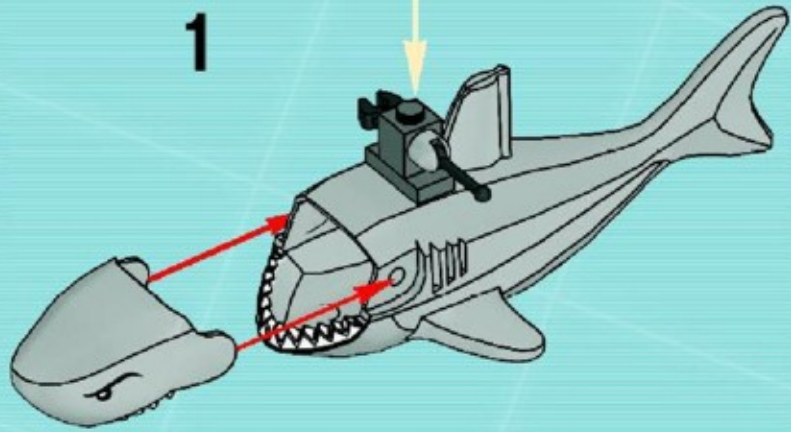

2

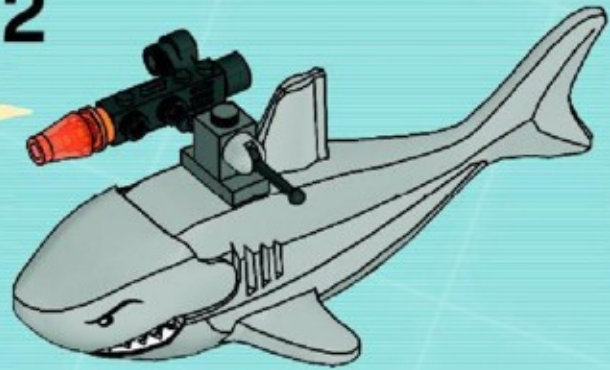



1

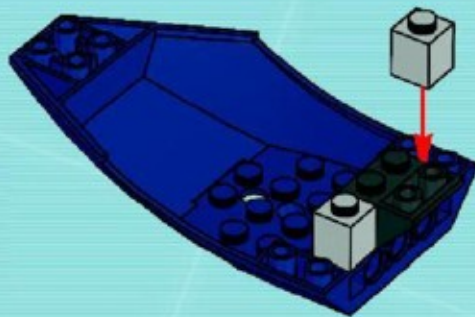

2

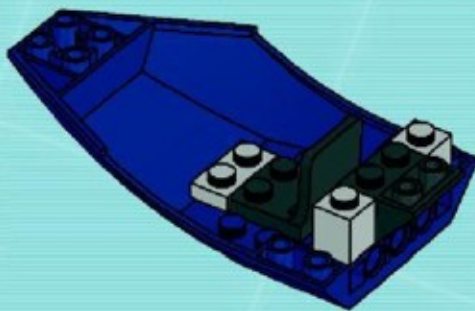



3

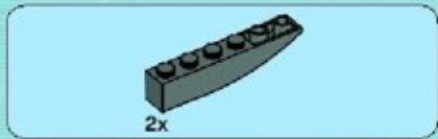
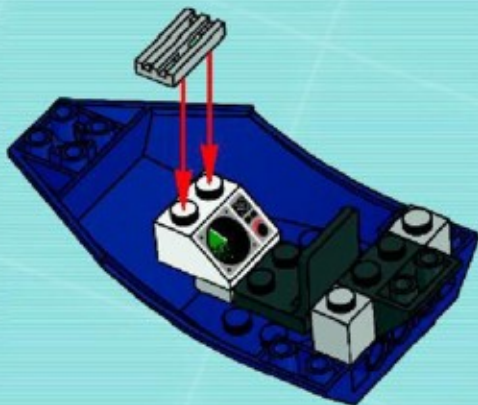

4

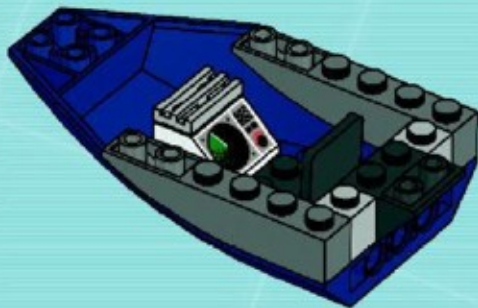



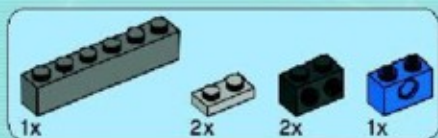

5

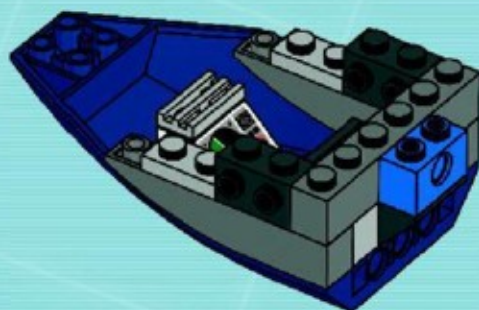

6

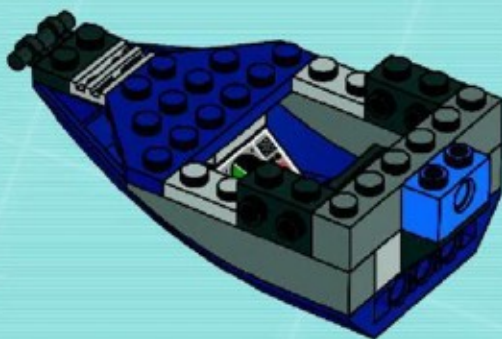



7

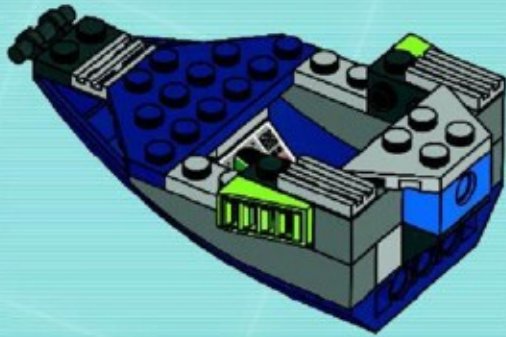

8

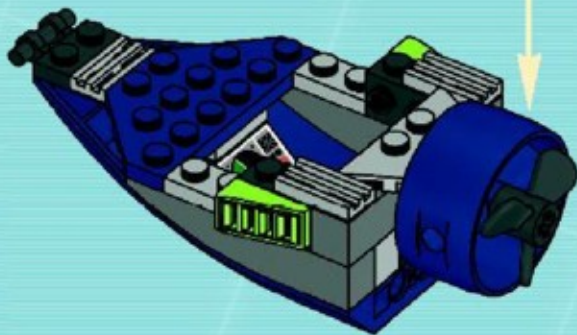
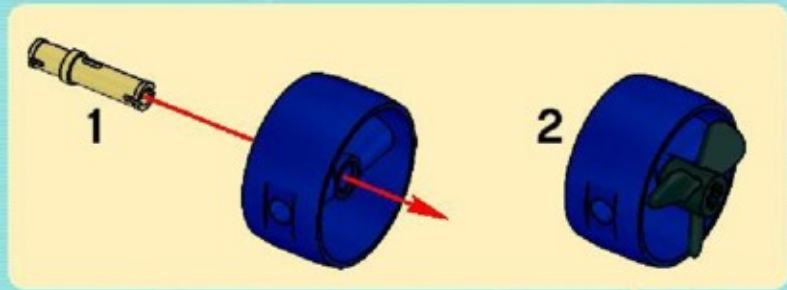



9

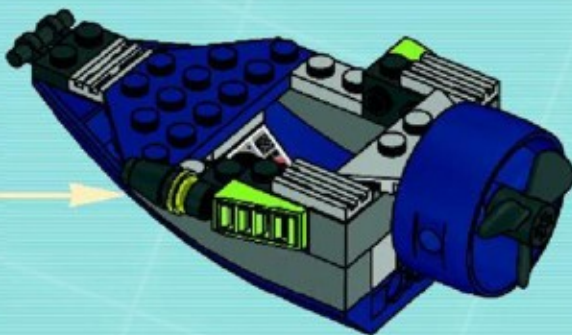
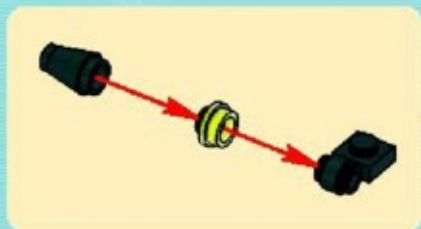

10

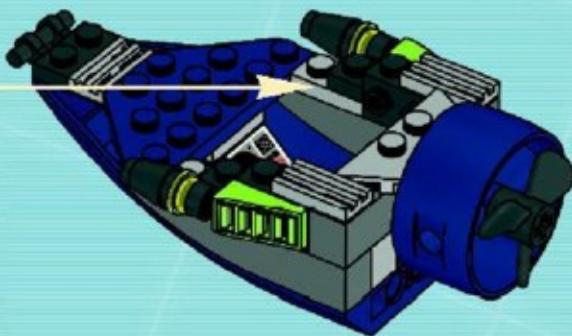
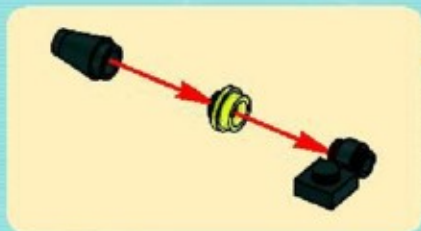



2x

# 11

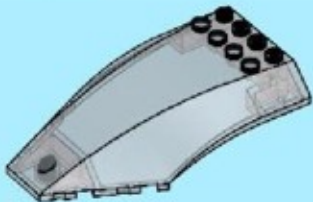
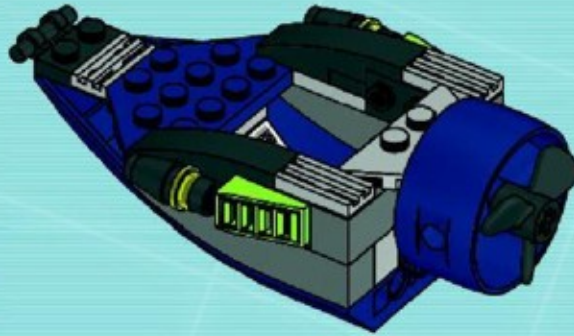

1x

# 12

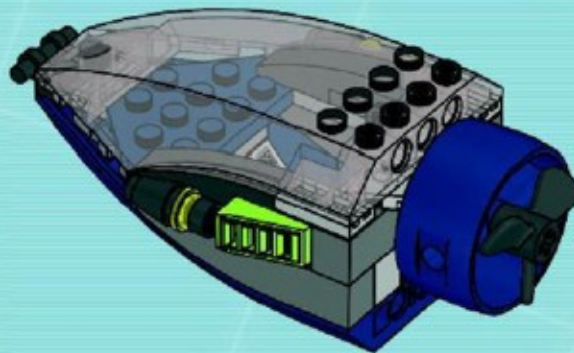

13

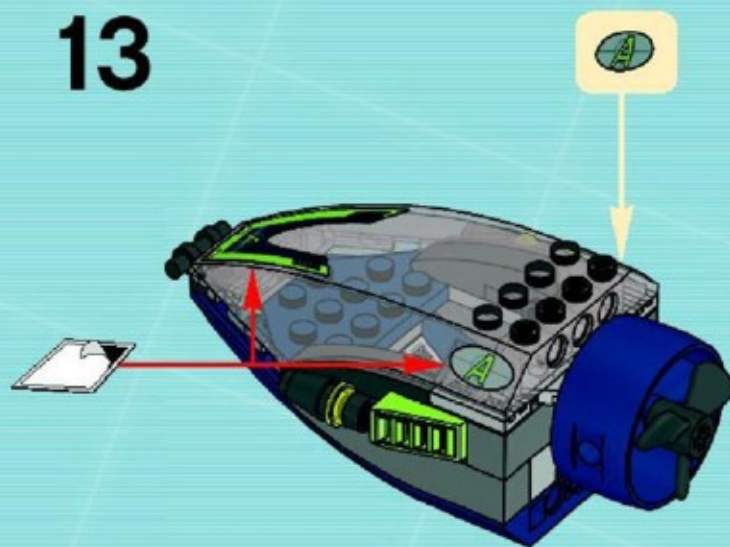



2

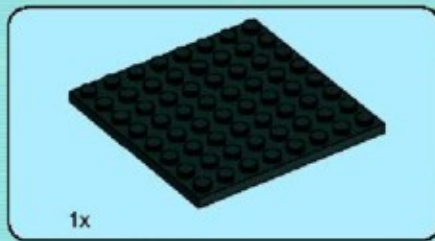

1x

1

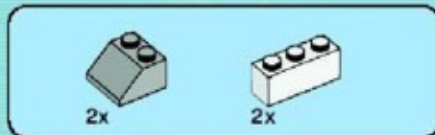
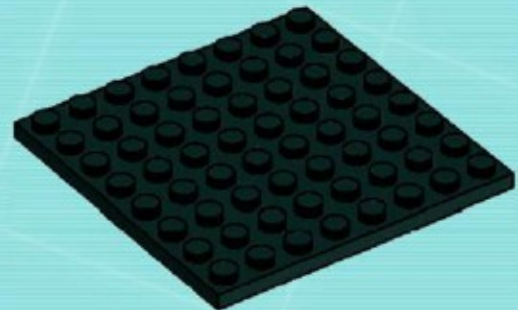

2x

2x

2

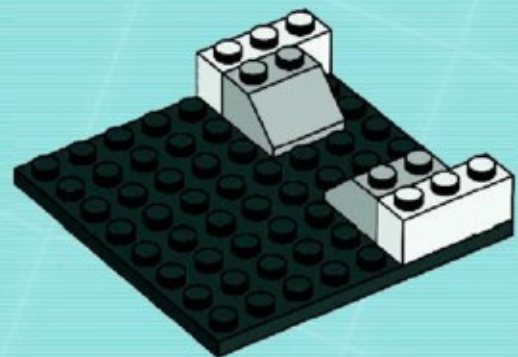



3

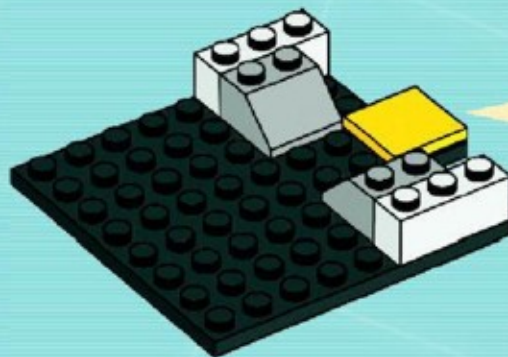

4

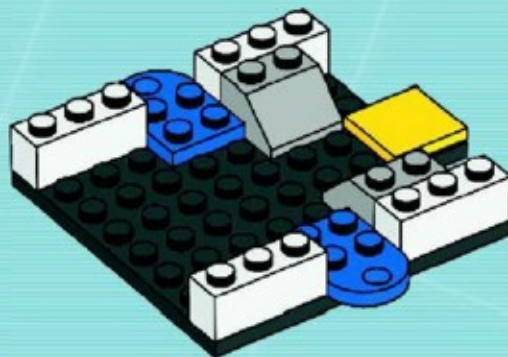



5

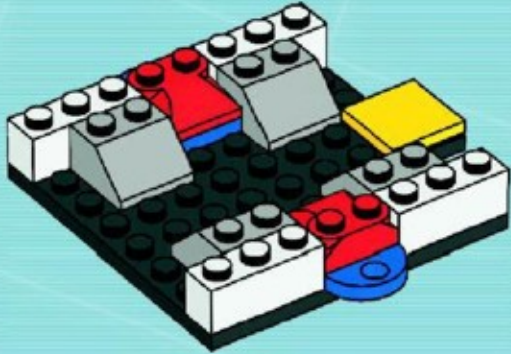

6

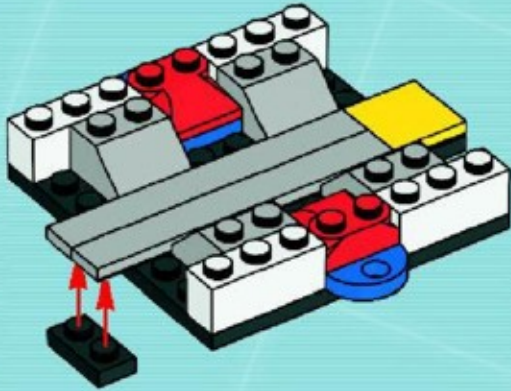





2x

7

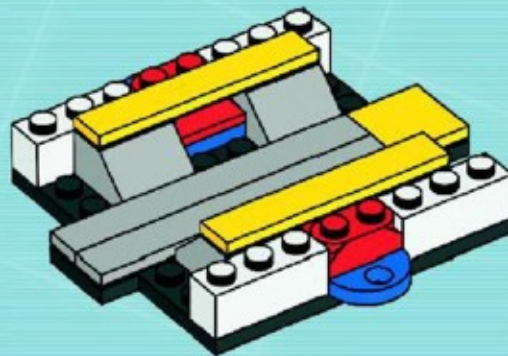

2x



4x

8

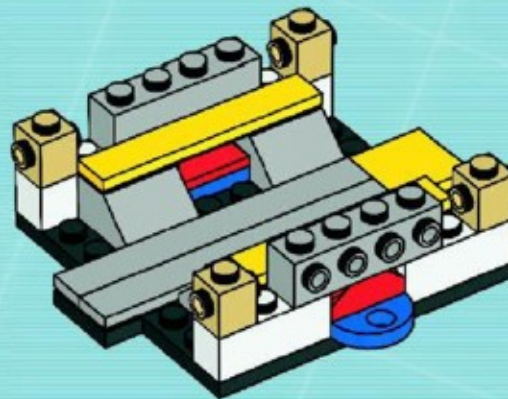



4x

9

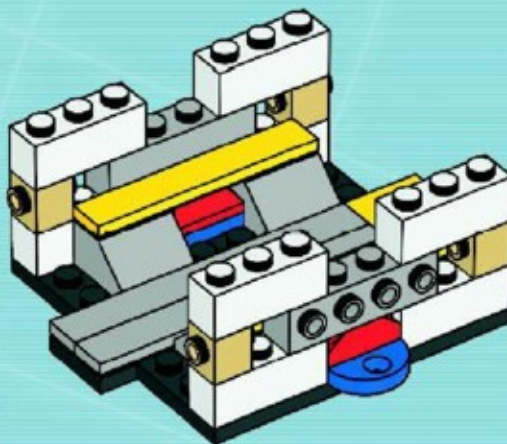

2x

10

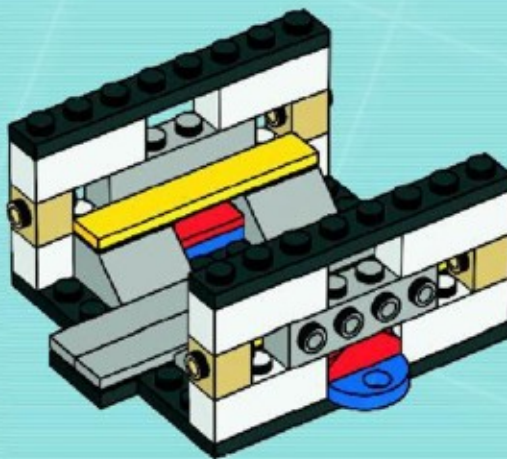

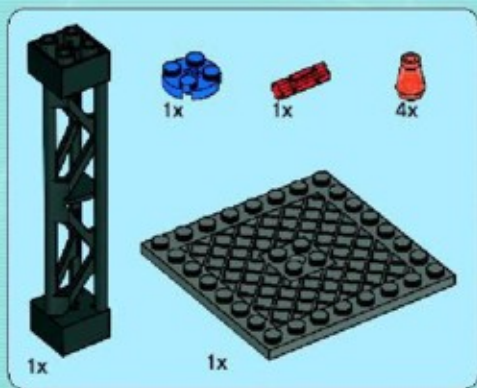

11

1

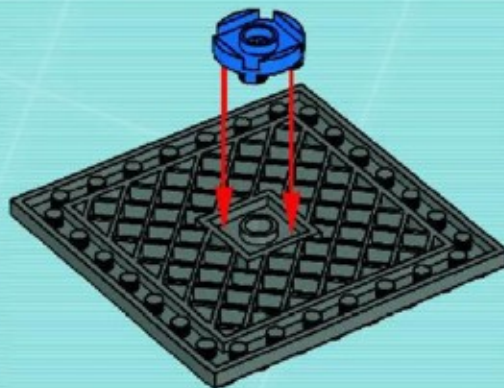

2



3



4





12

1

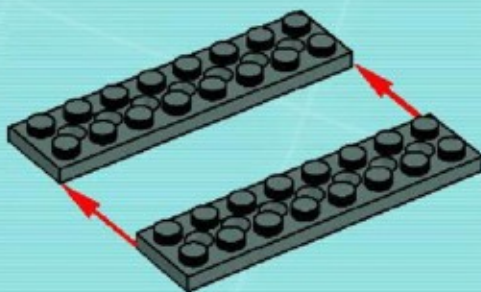

2



3



4

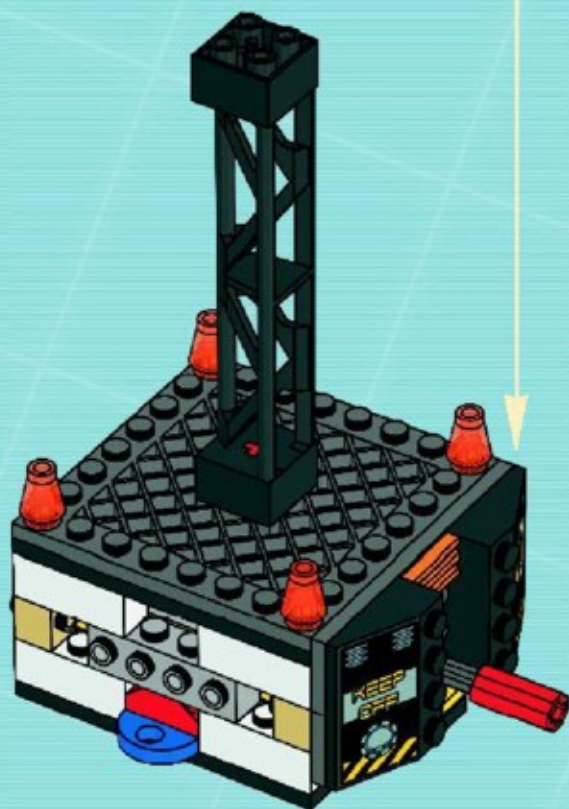
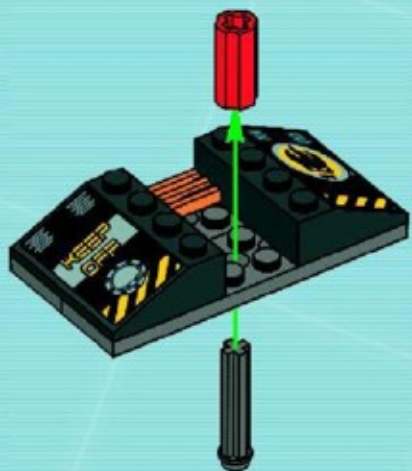



# 13

1



2

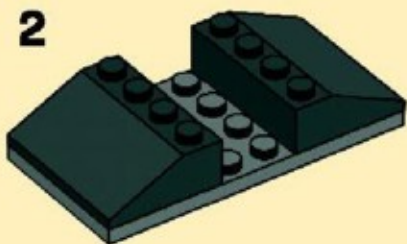

3





1

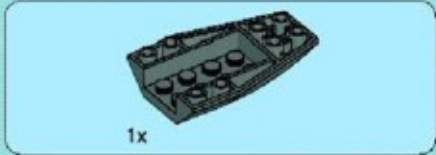
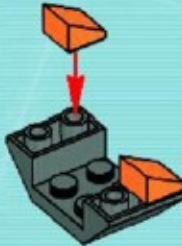

2

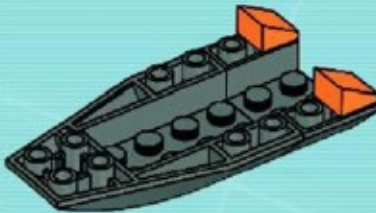





3

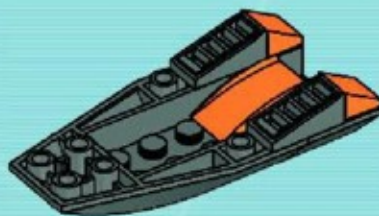

4



5



14



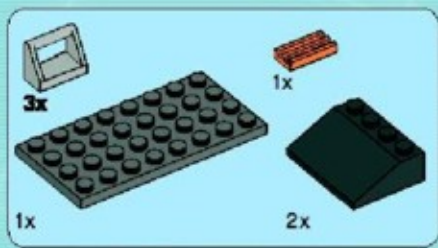

15

1

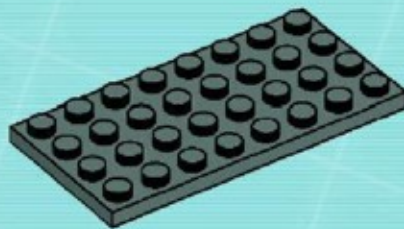

2

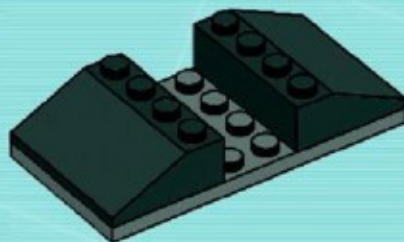

3



4



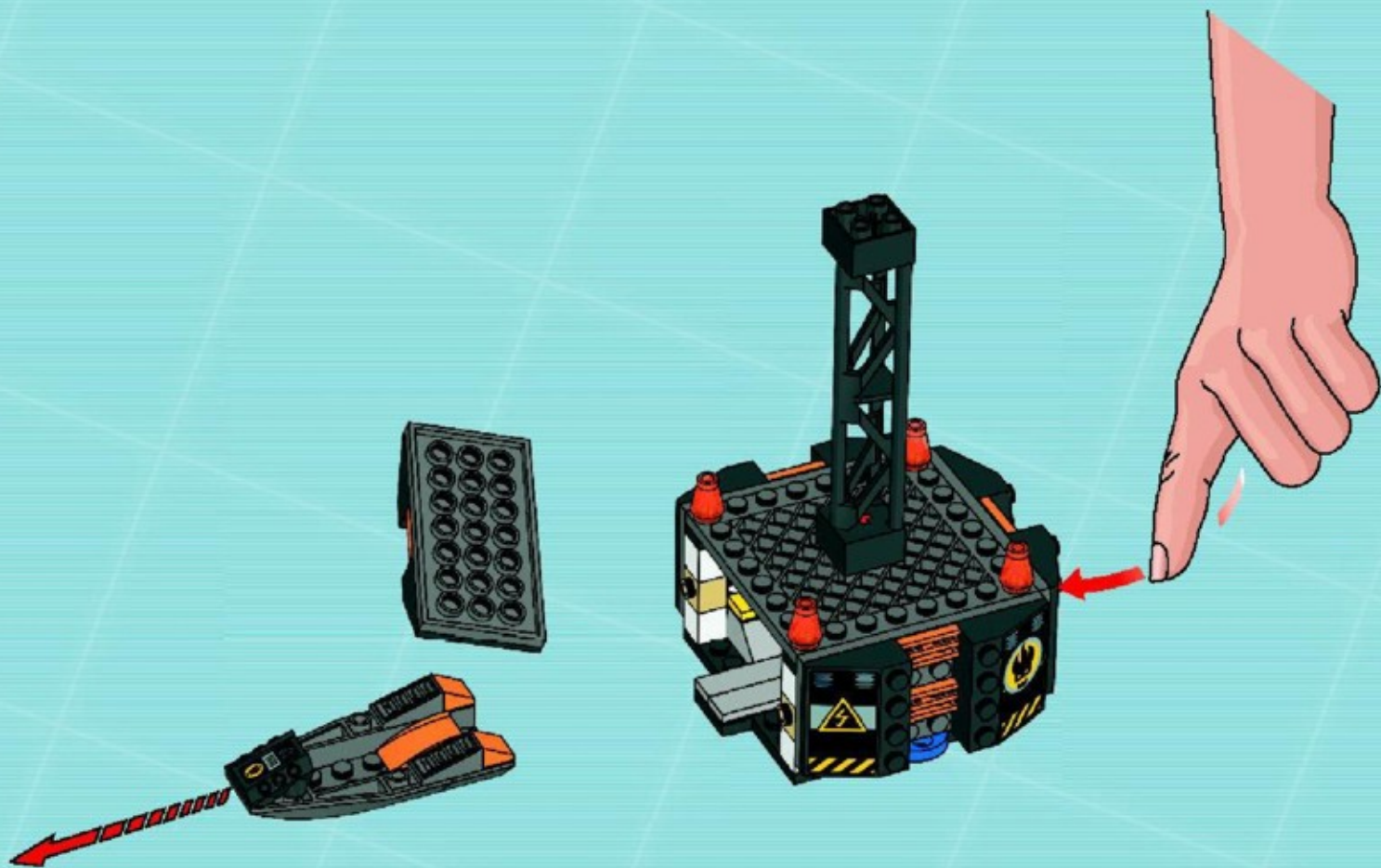



2x

# 16





17





18

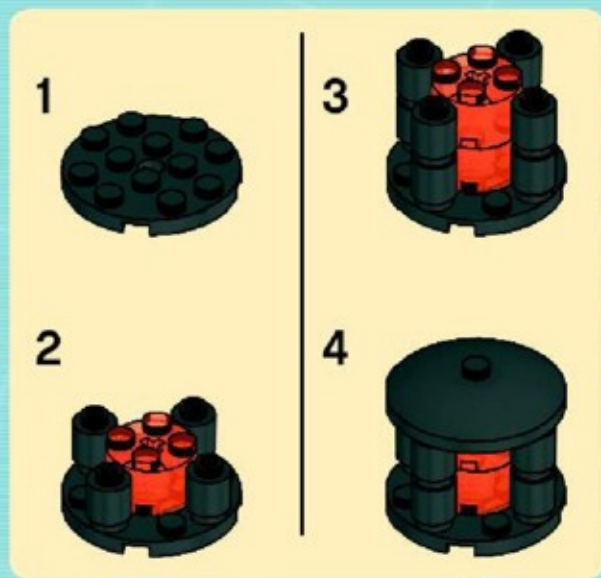



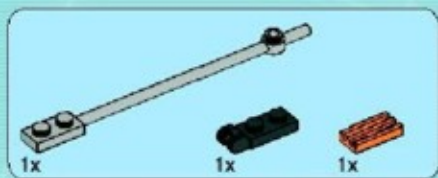

19

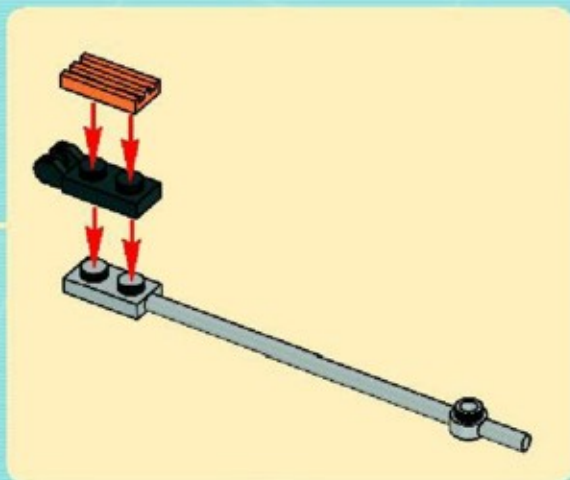



20

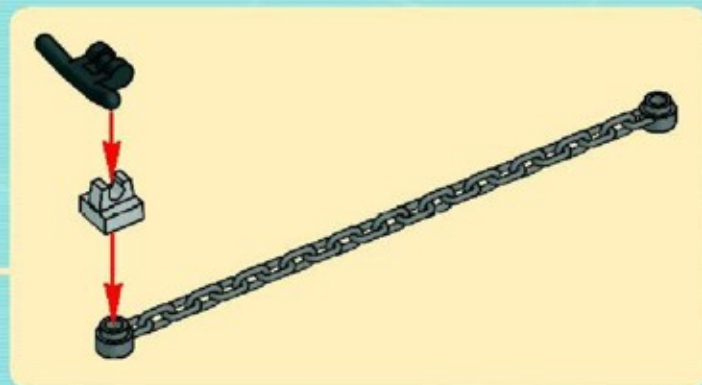







# AGENTS

Three LEGO Agents characters are shown in the top right corner of the title banner. They are dressed in blue and black tactical gear, with one holding a rifle.

8633



2

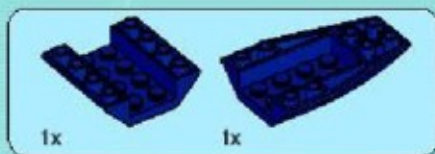

1

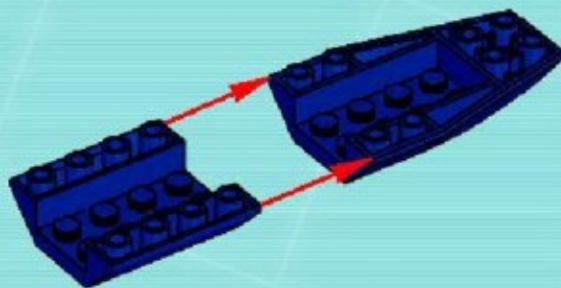



2

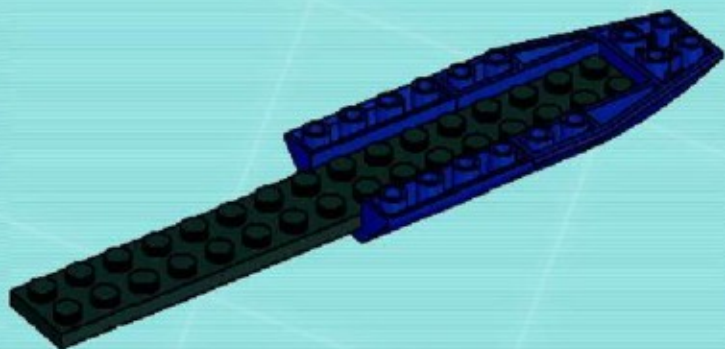

3

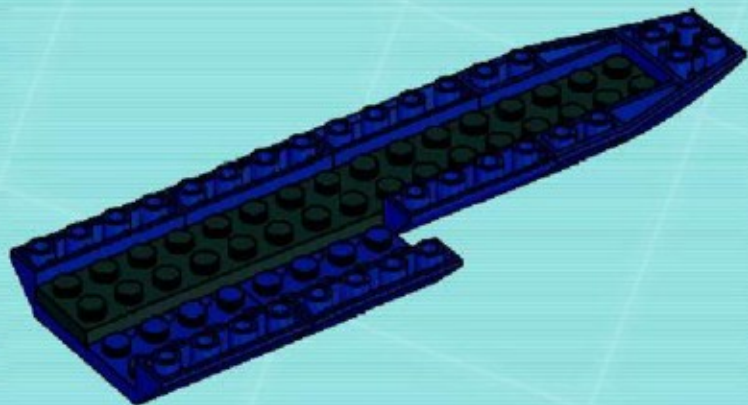



4

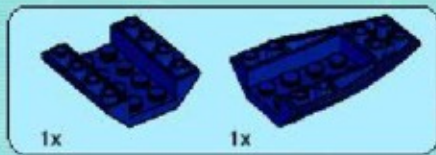
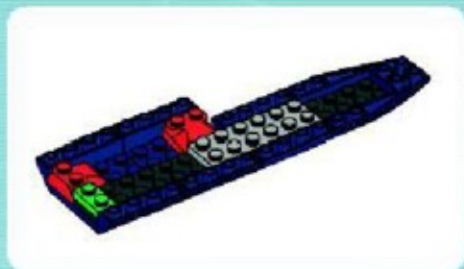
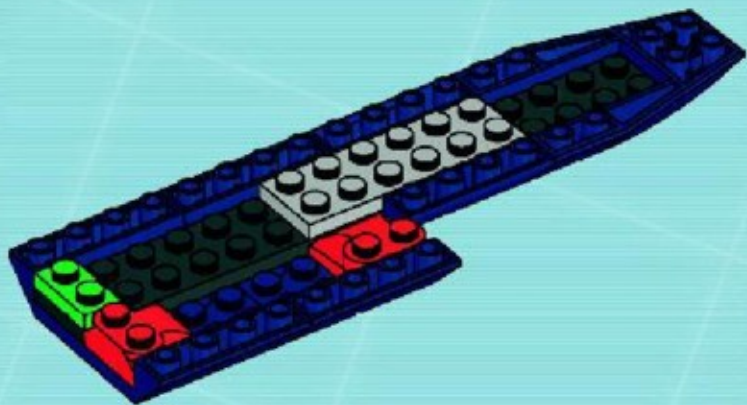

1

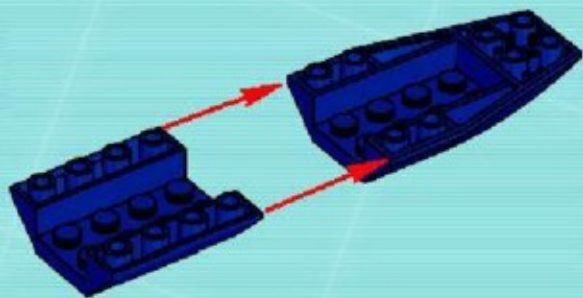





2

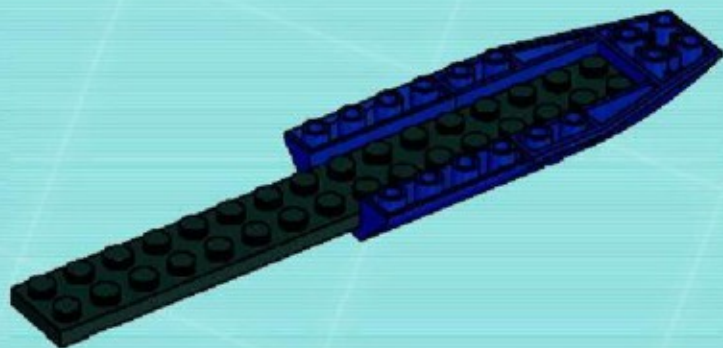

3

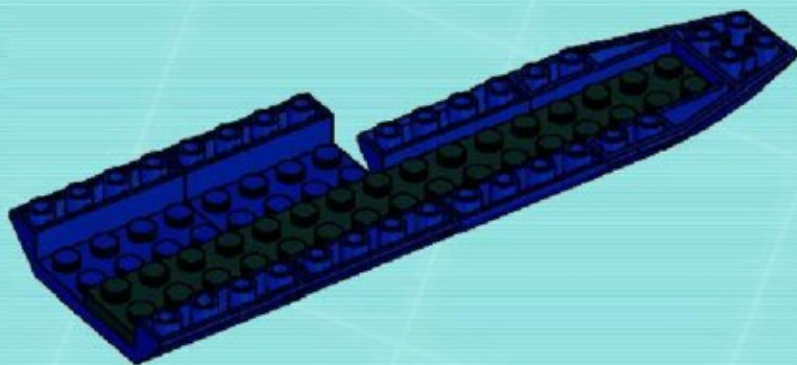

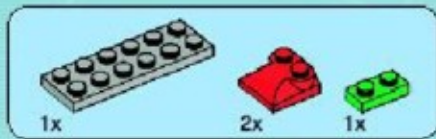

4

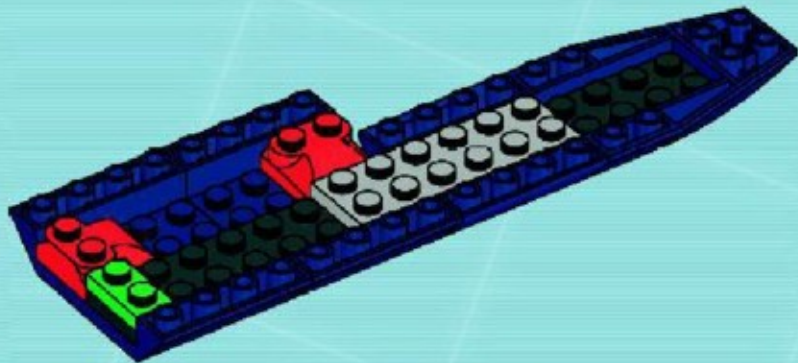

5

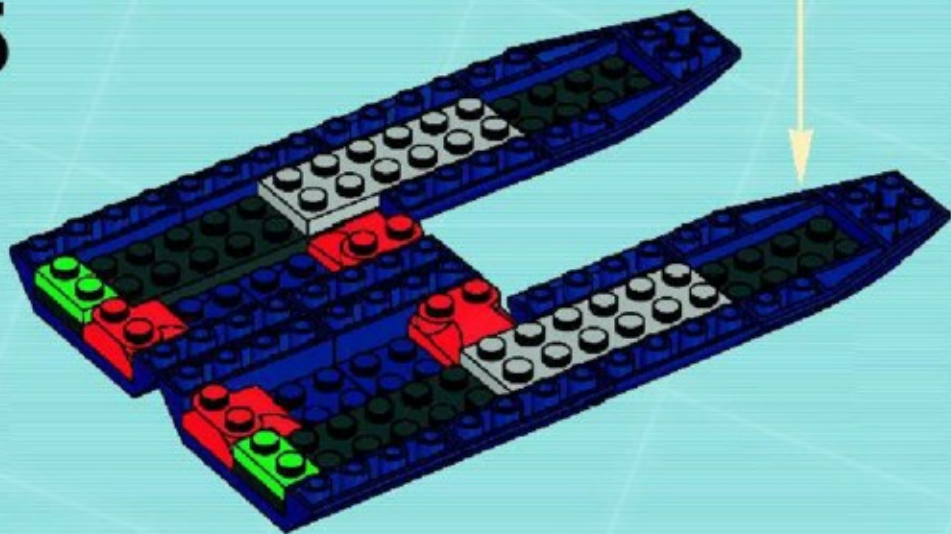

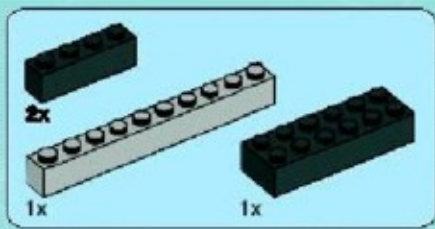

6

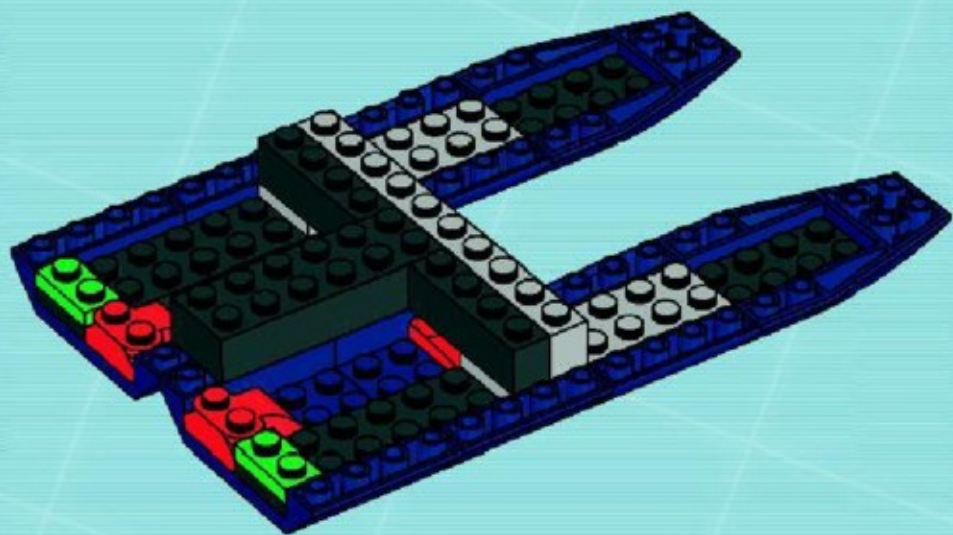

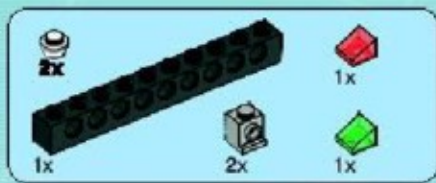

7

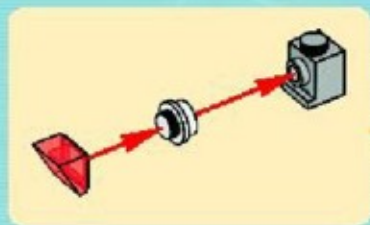
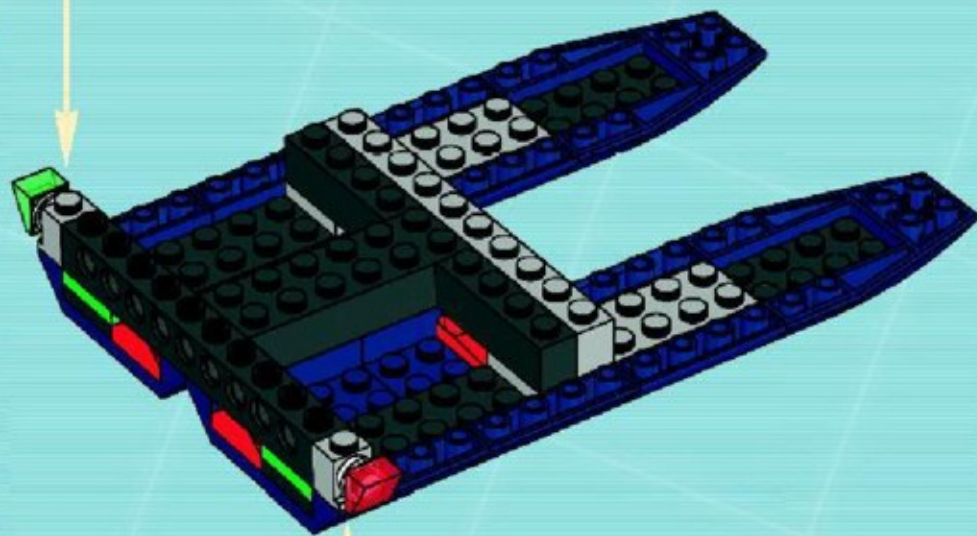
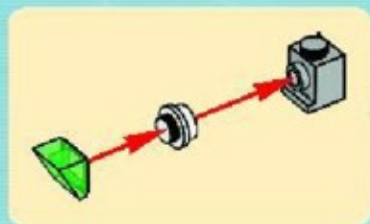

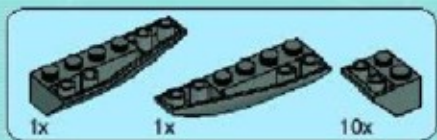

8

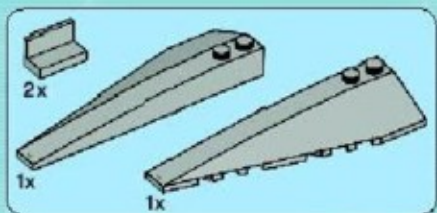
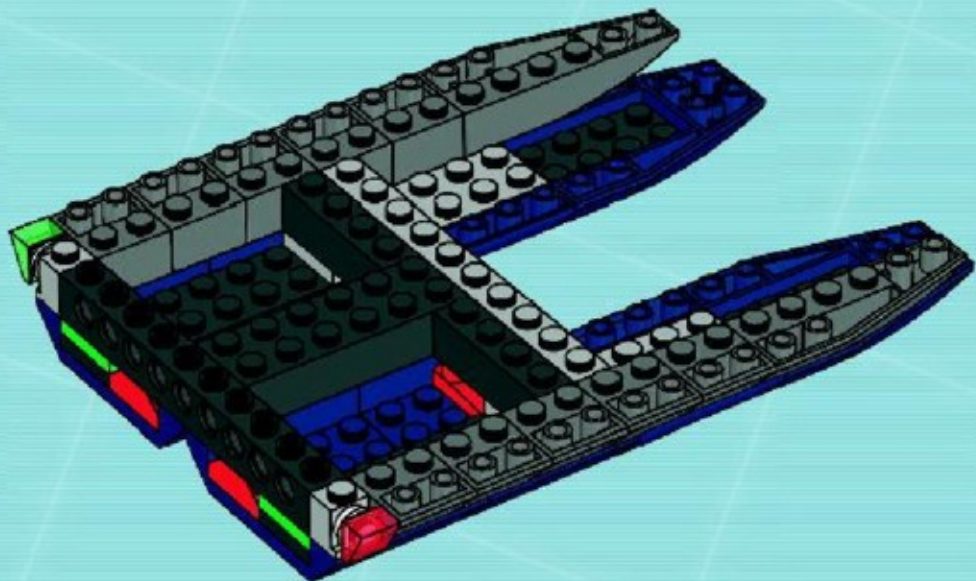

9

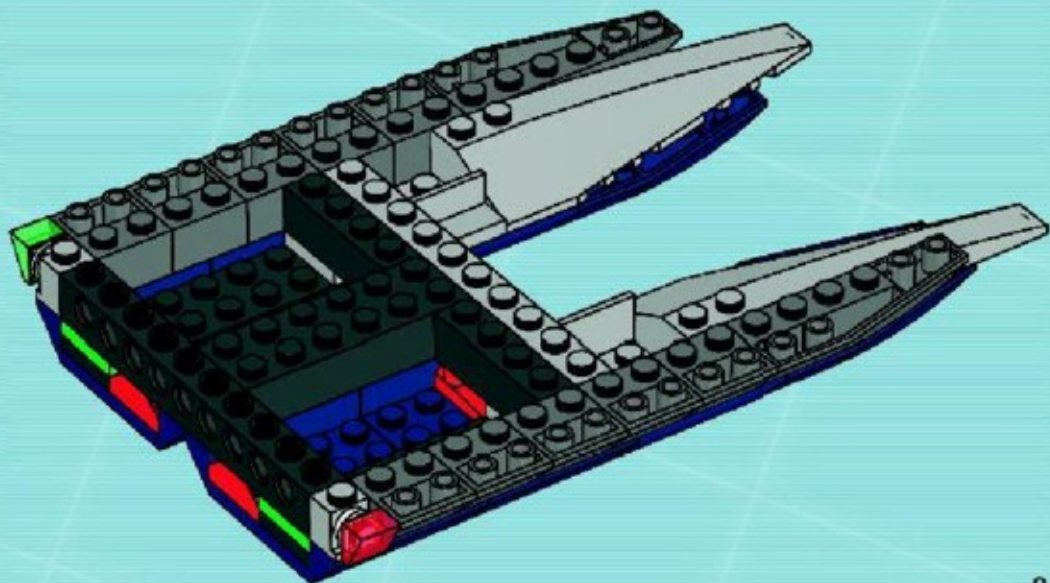



10

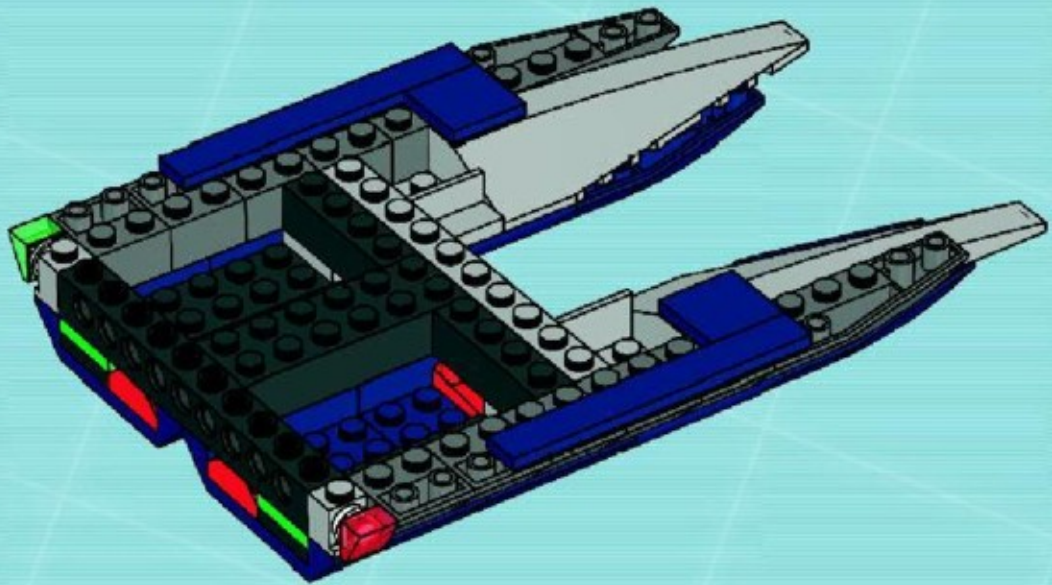



11

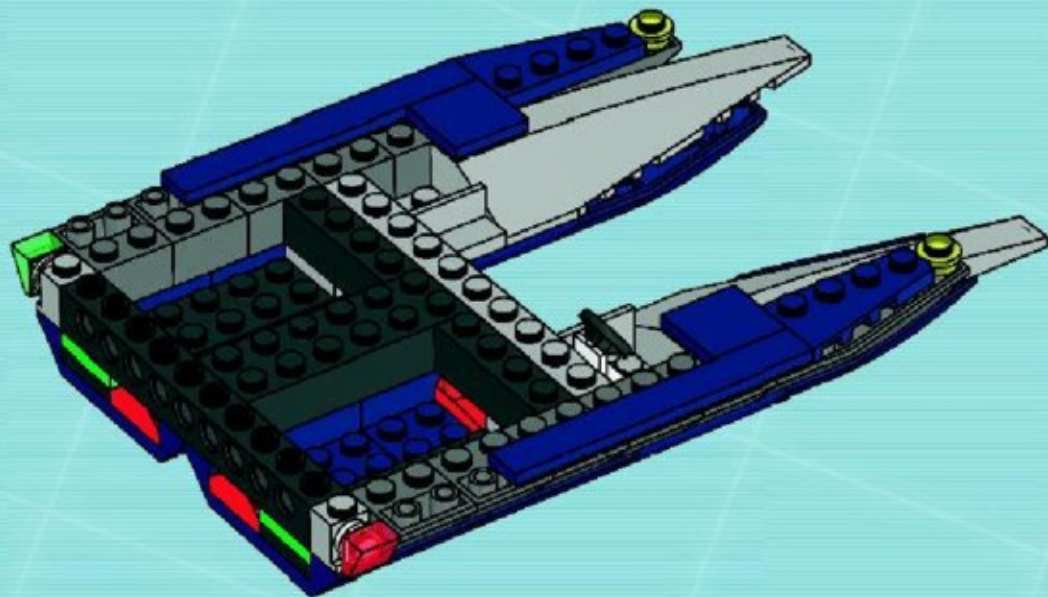



2x



2x

# 12

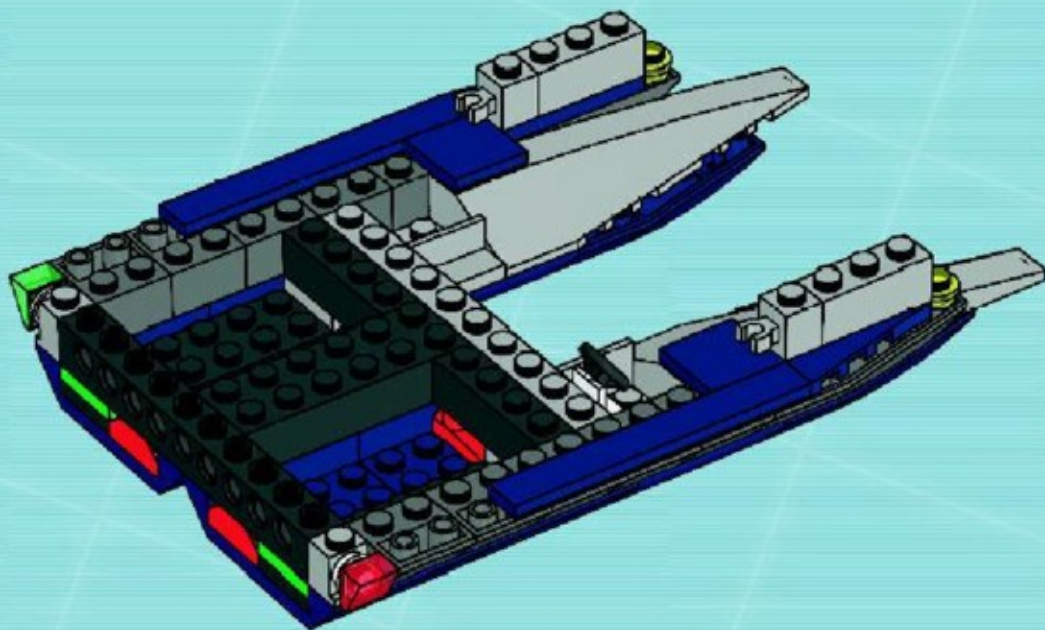



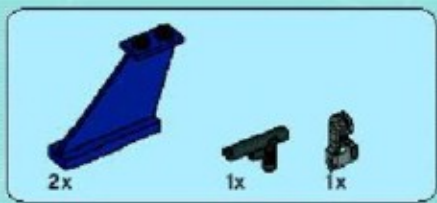

13

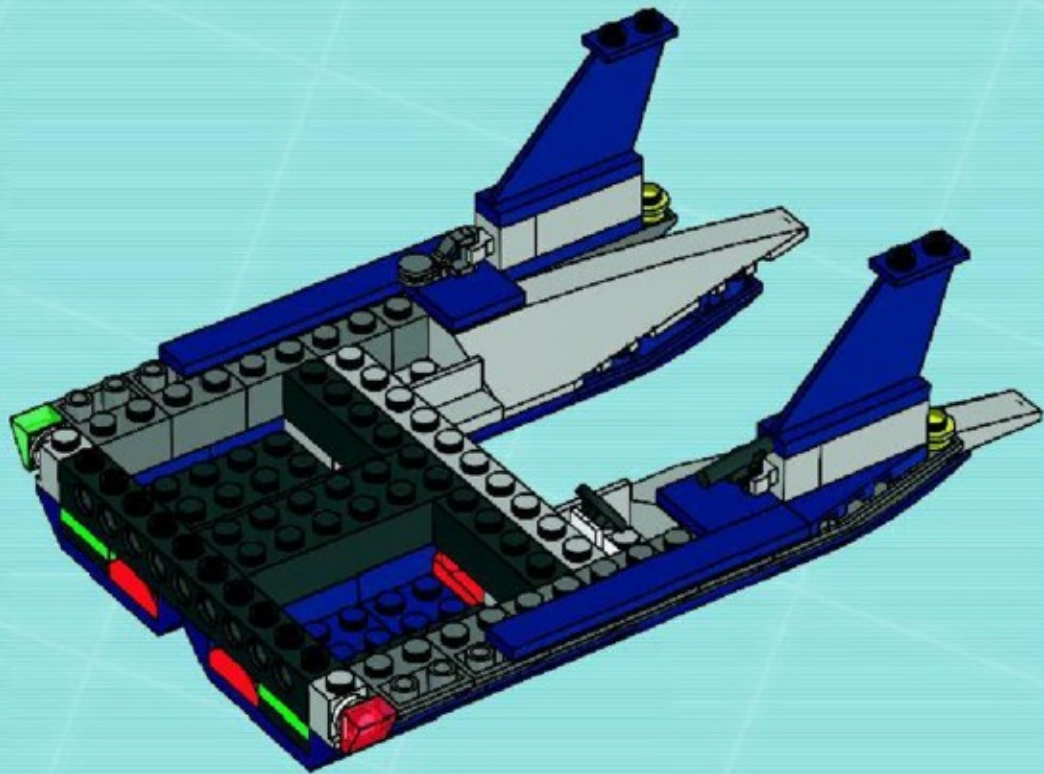

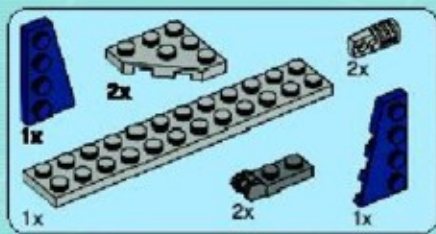

14

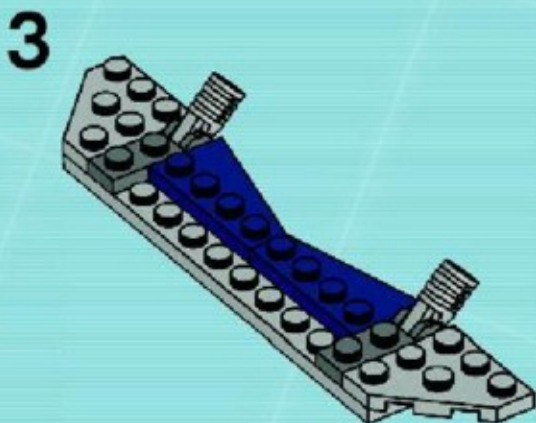
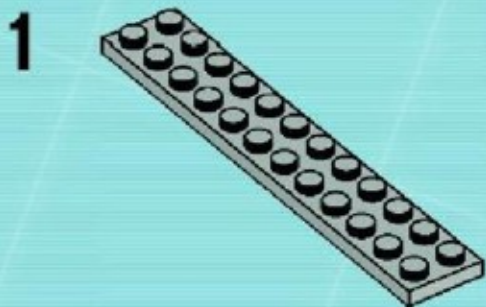

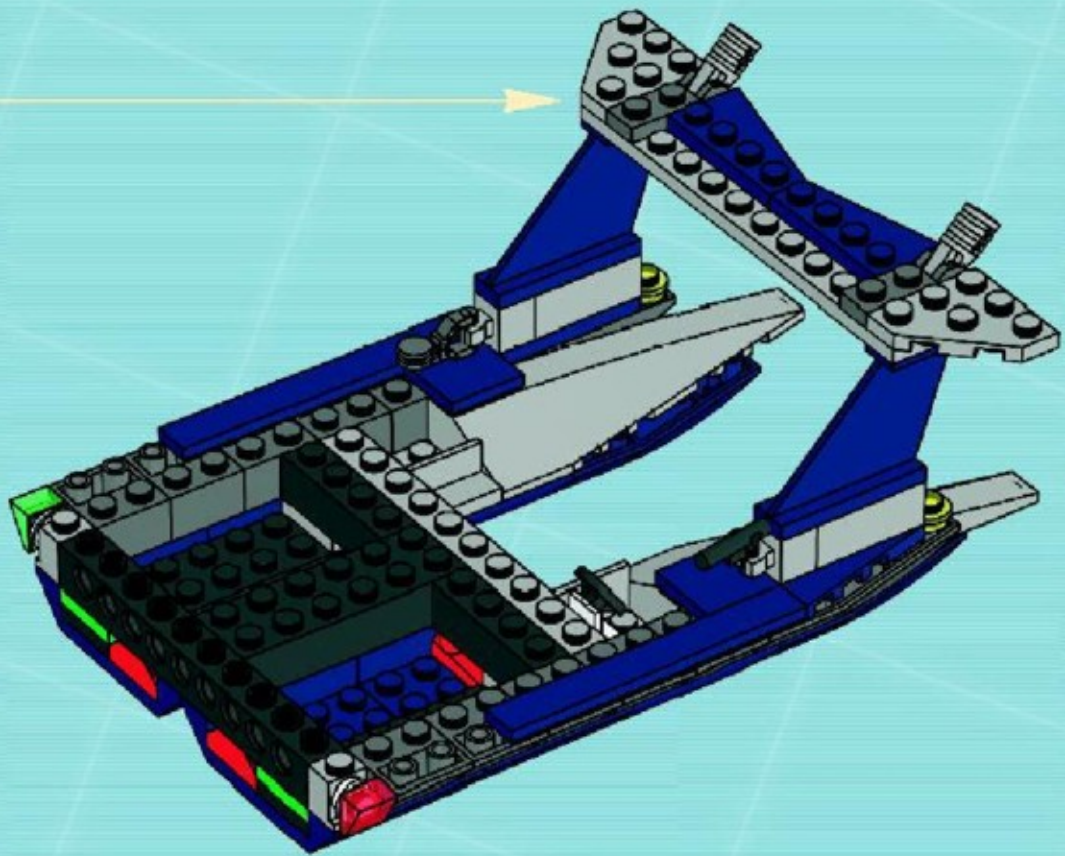

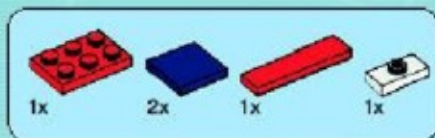

15

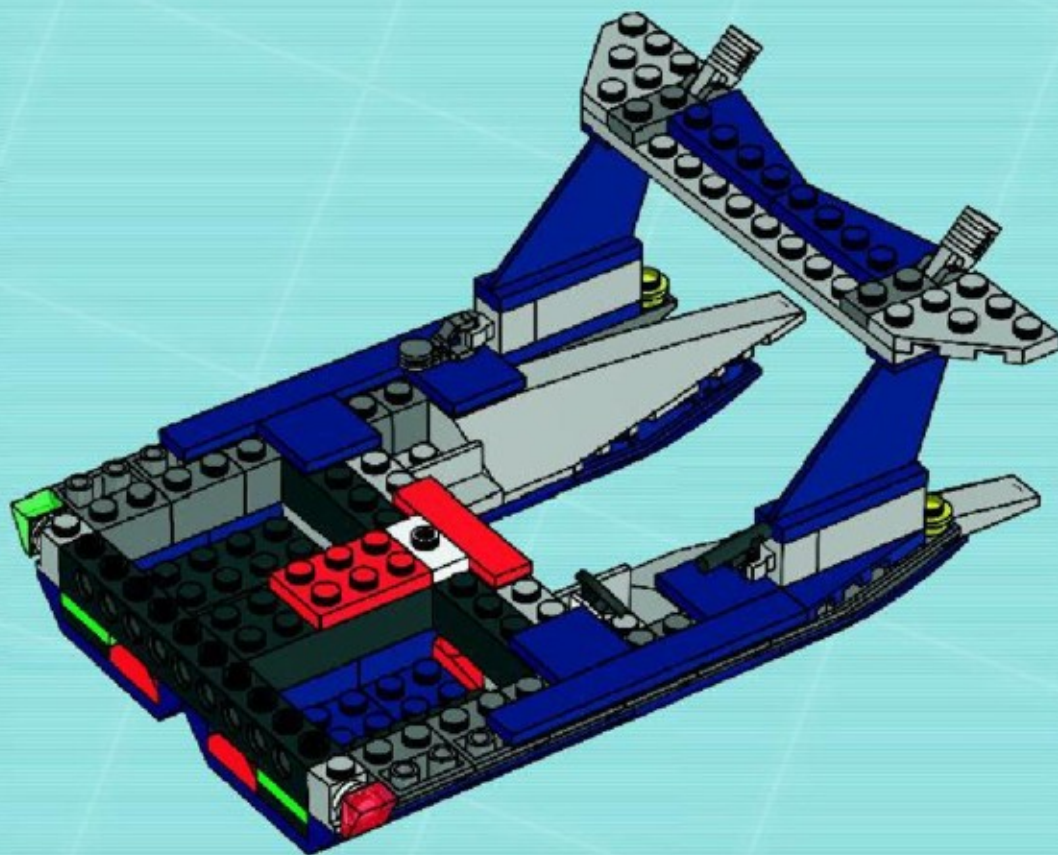

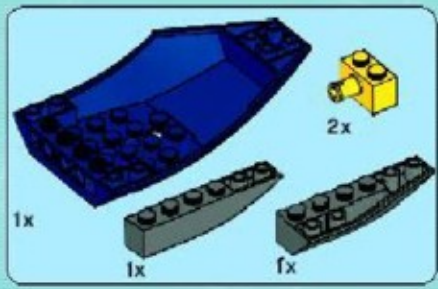

16

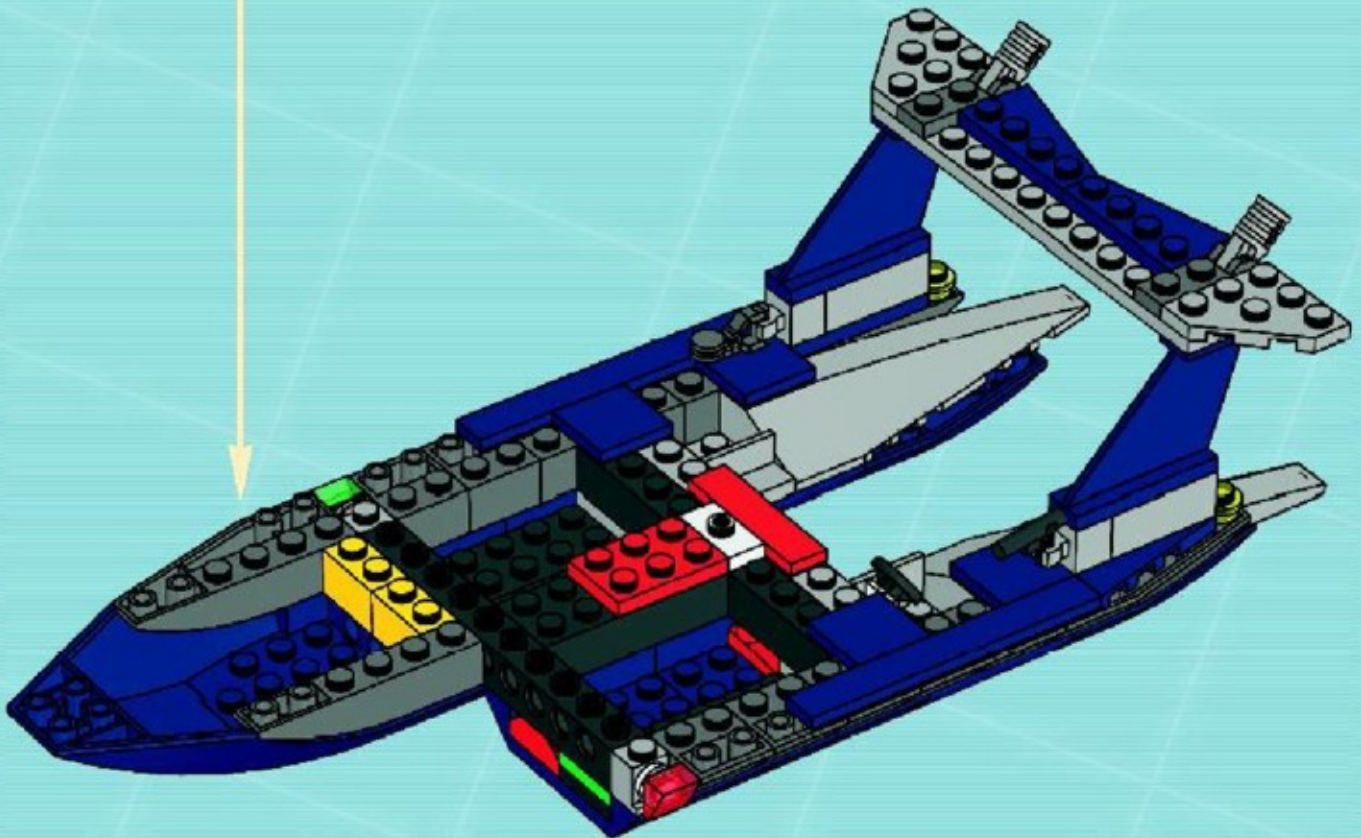
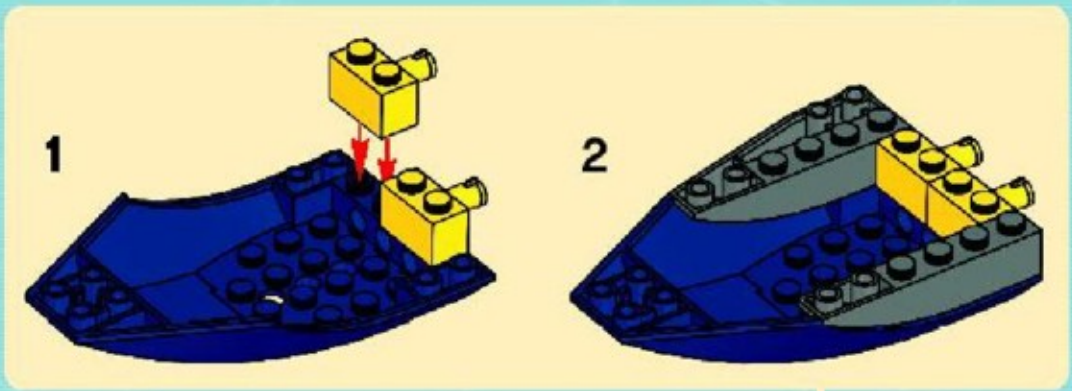

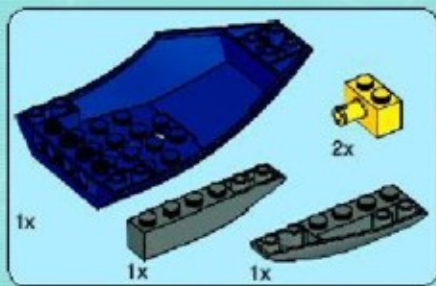

17

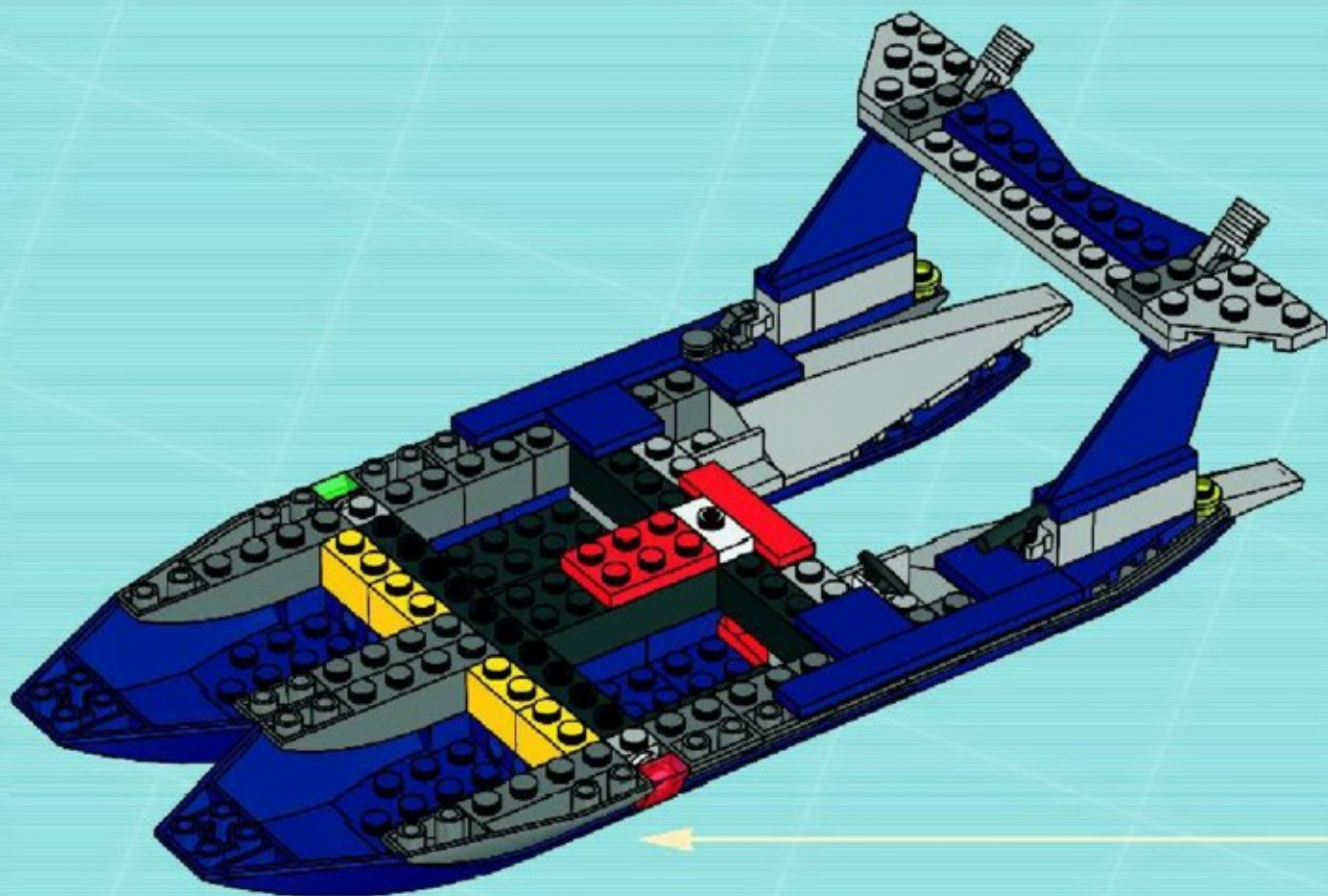
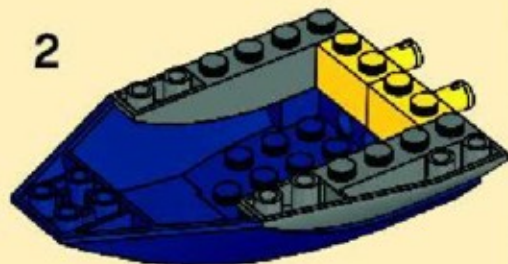
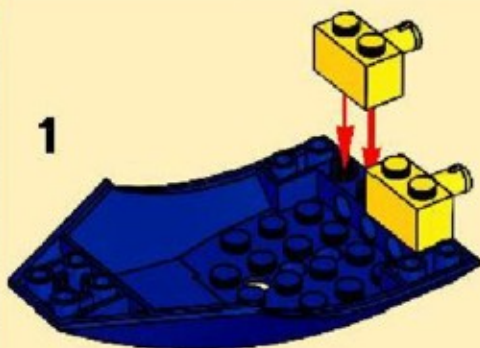



2x

# 18

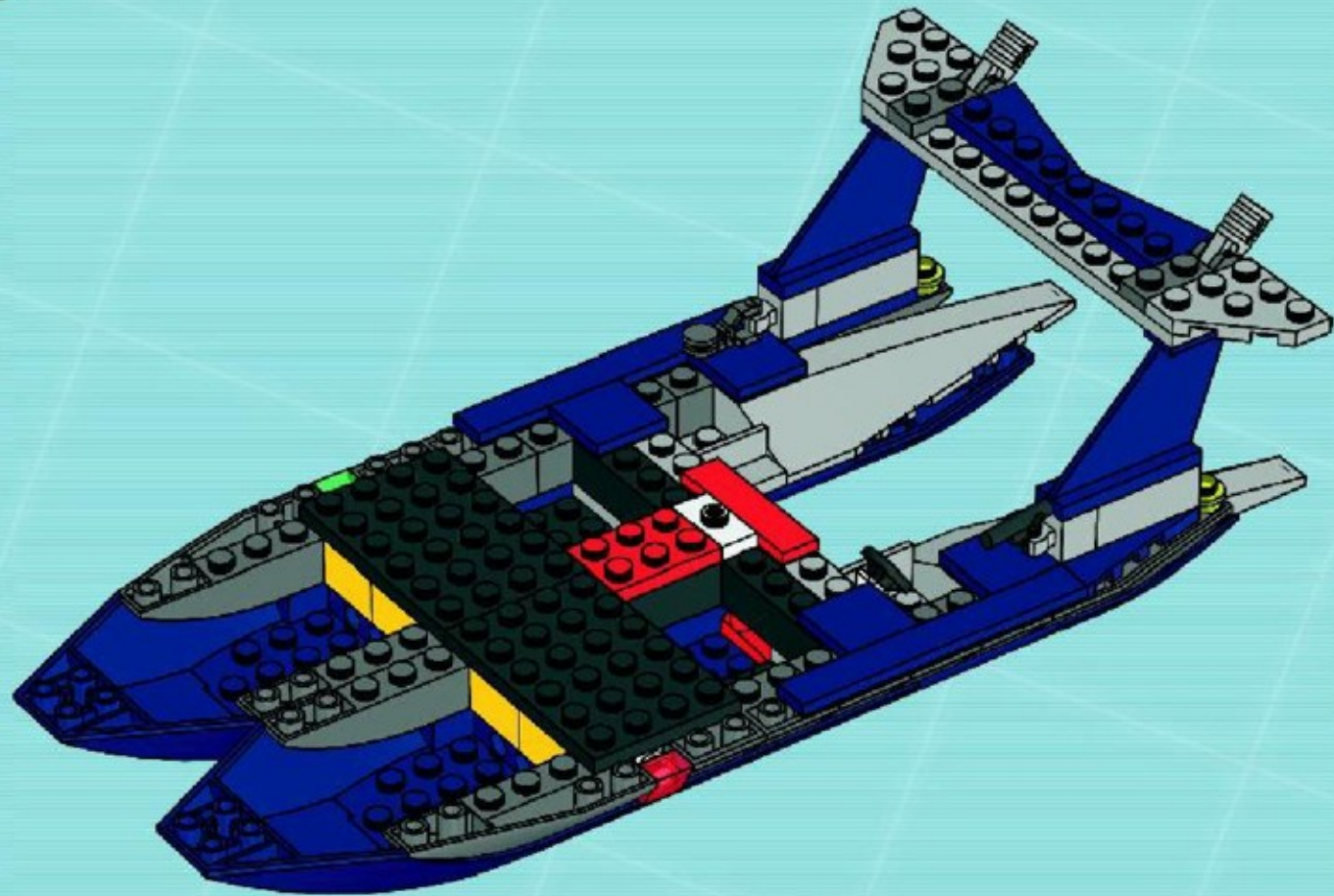



2x



1x

# 19







20

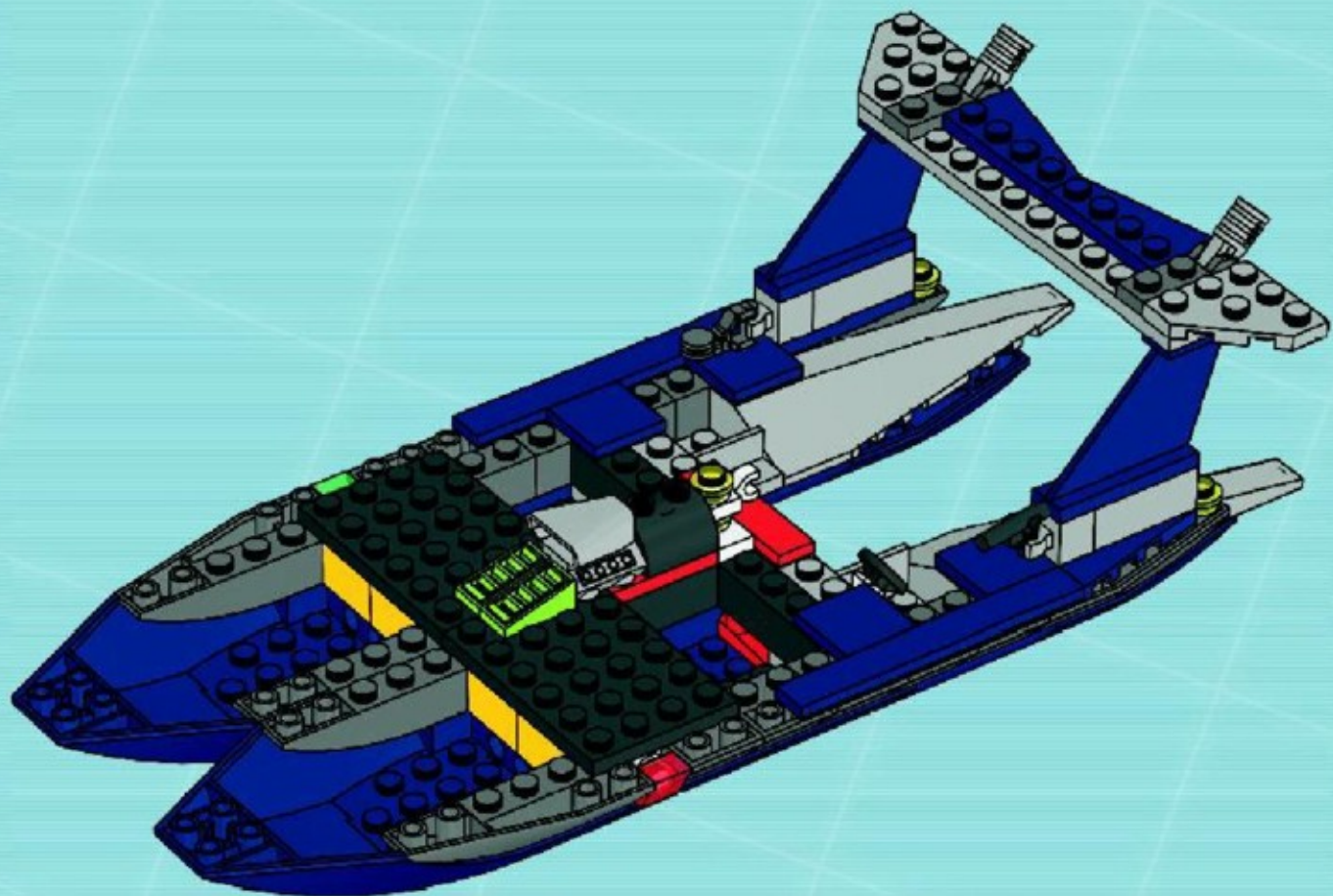



# 21

1



2



3

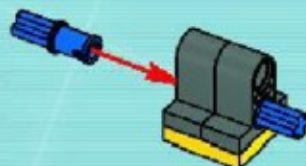

4



5

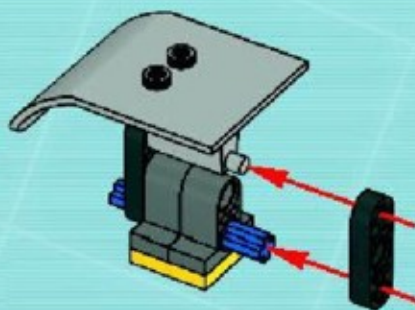

6

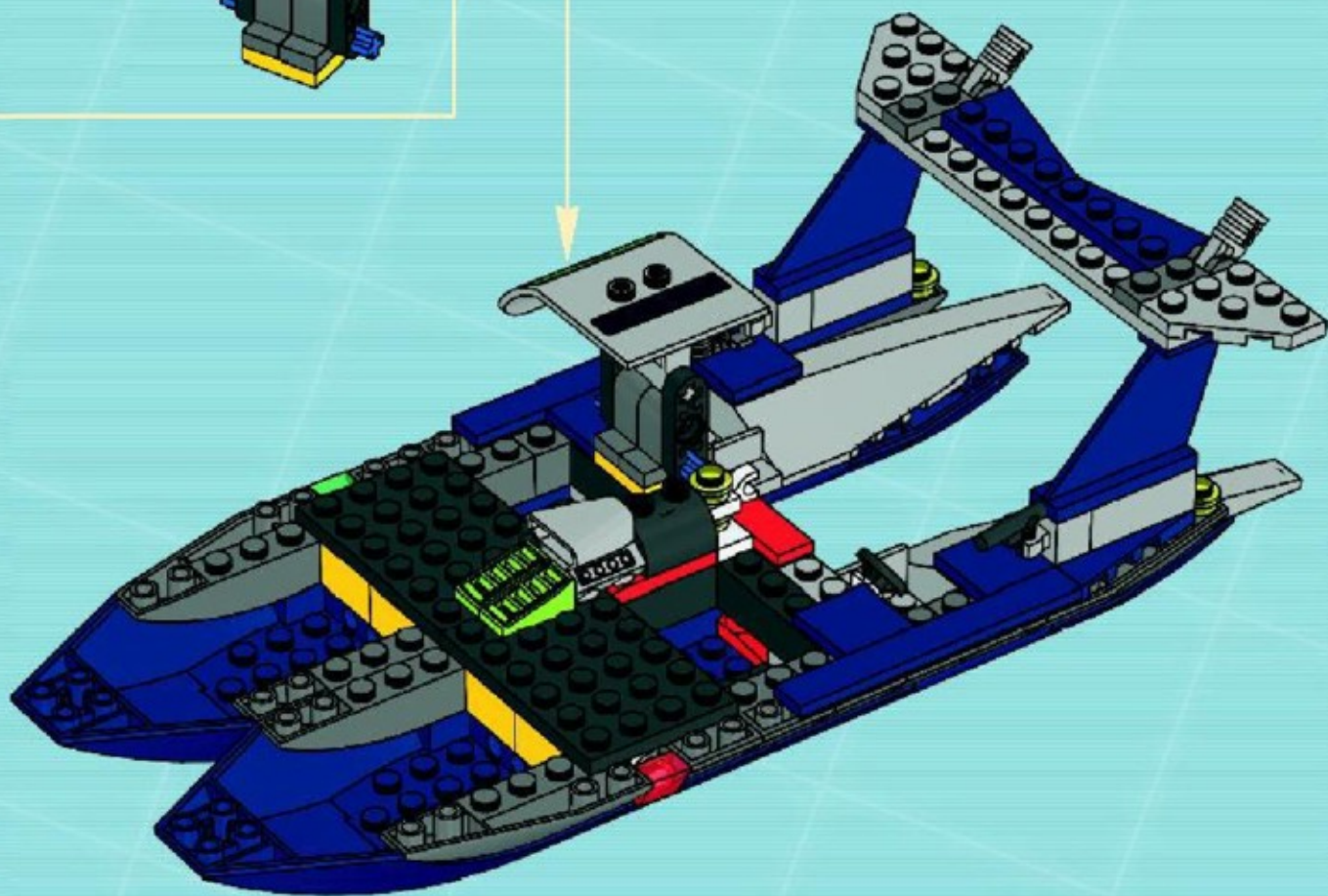
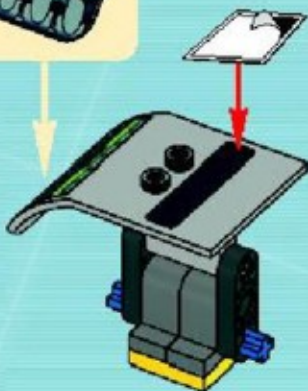

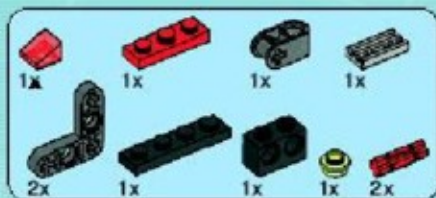

22

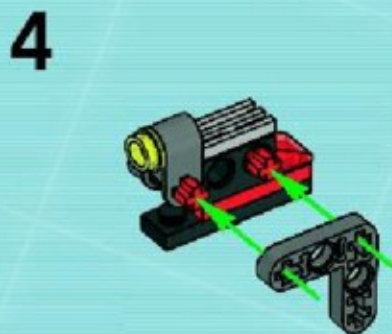
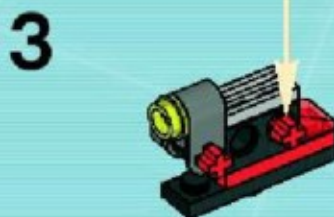
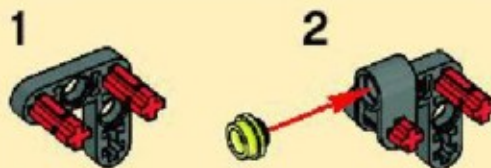
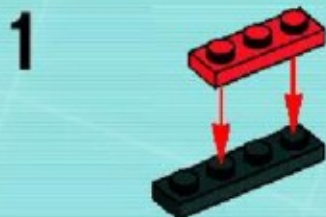

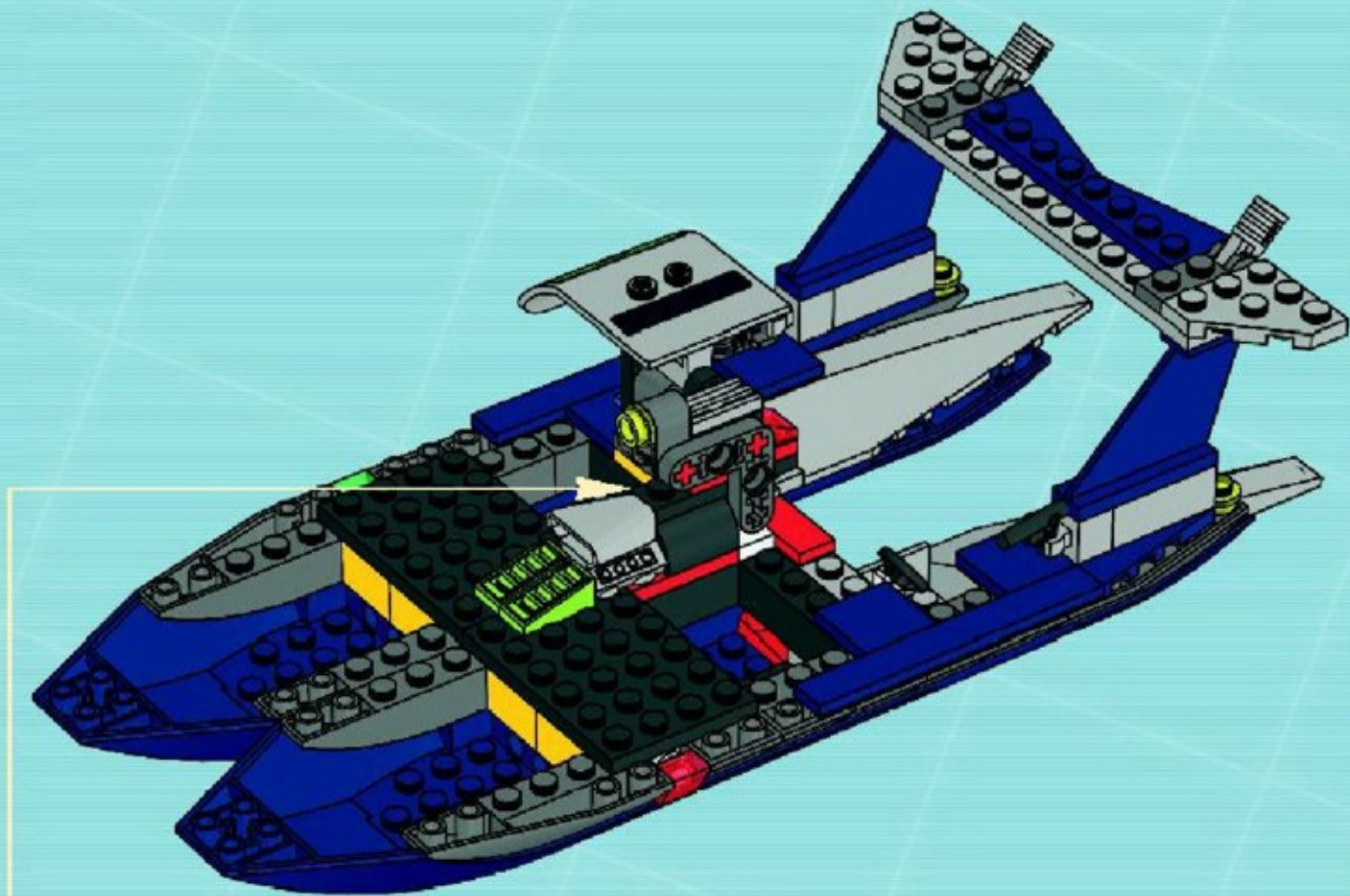



# 23

1



2



3

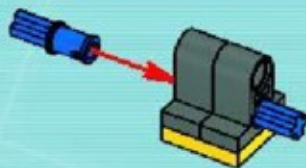

4



5

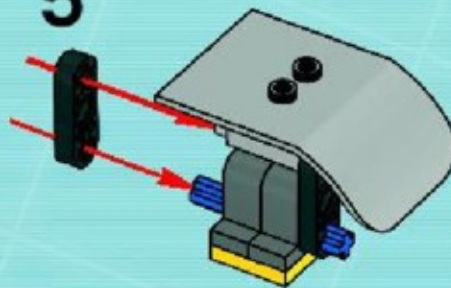

6

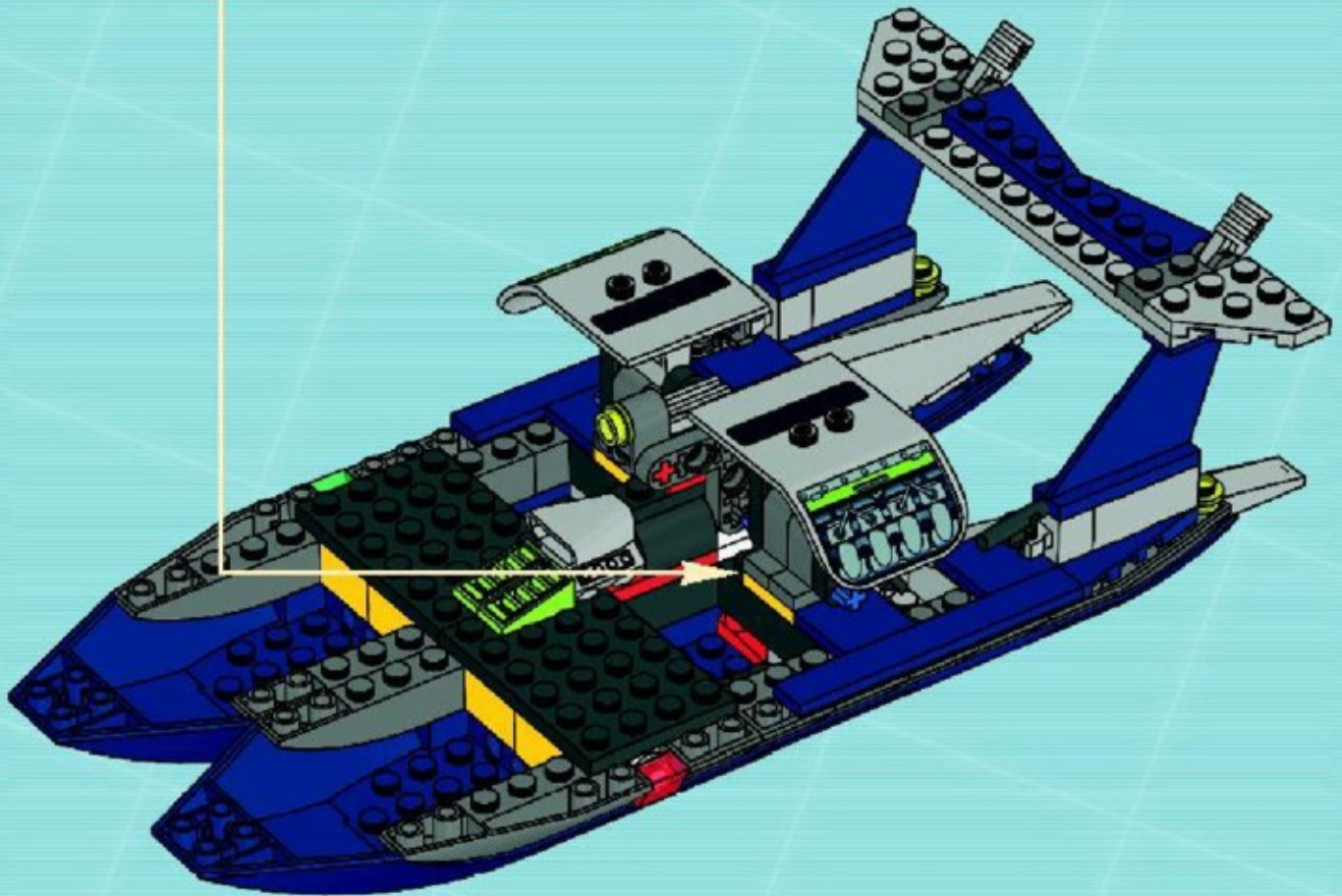

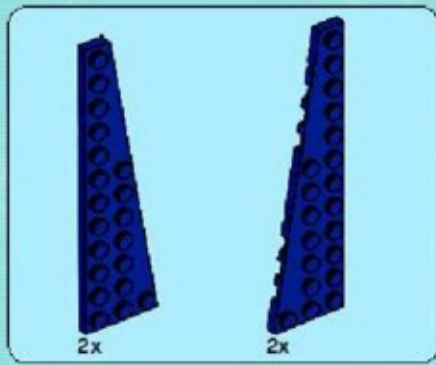

24





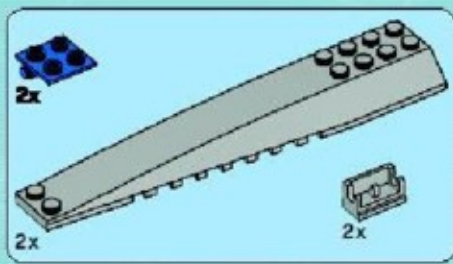

25





2x



2x

# 26





27





28

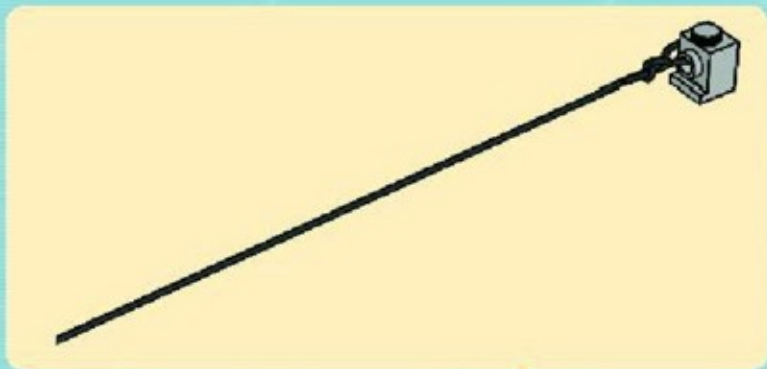



29

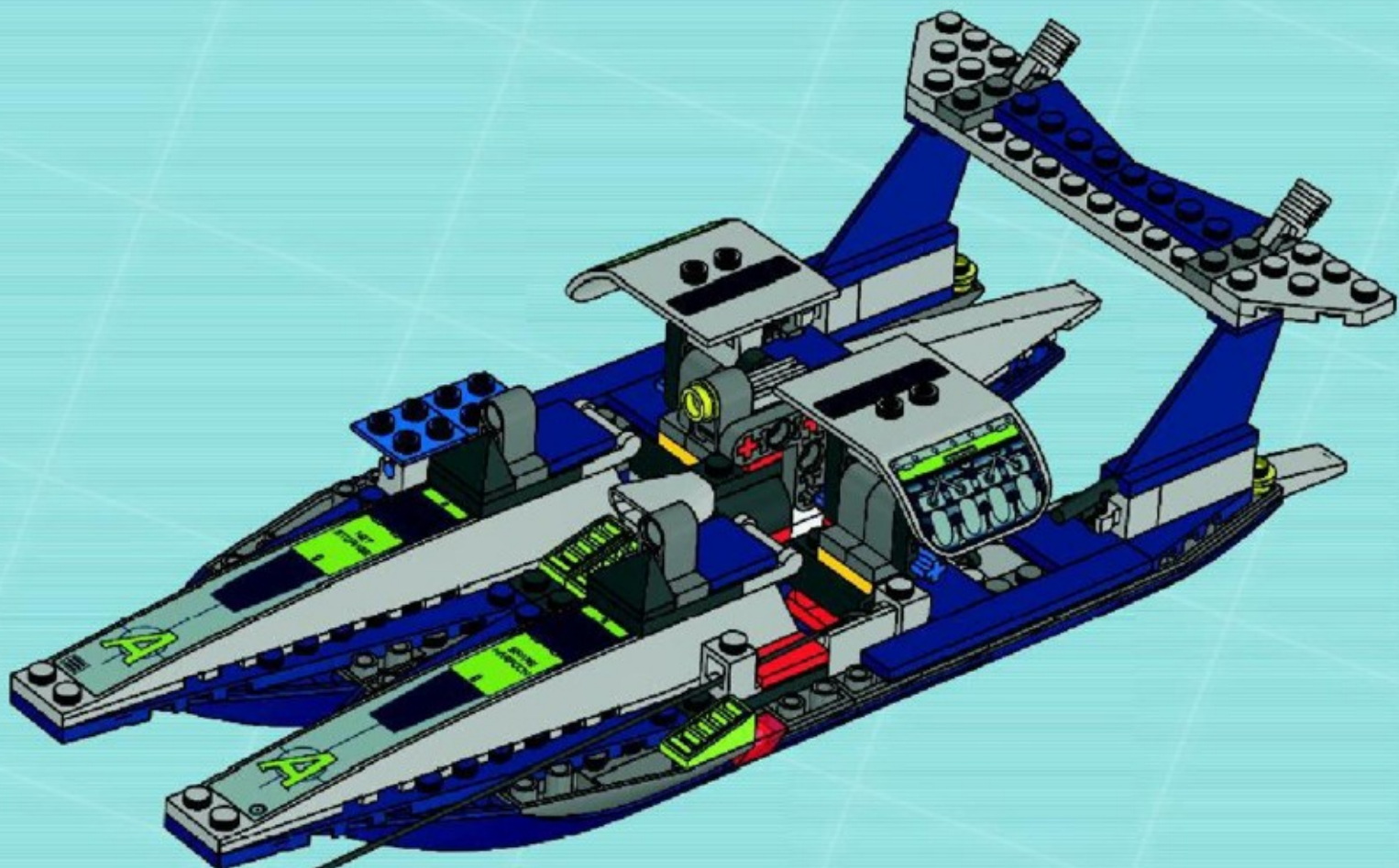

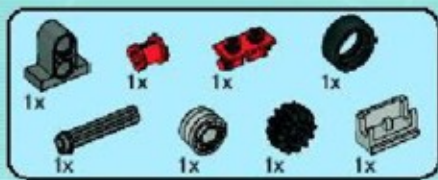

30

1



2



3

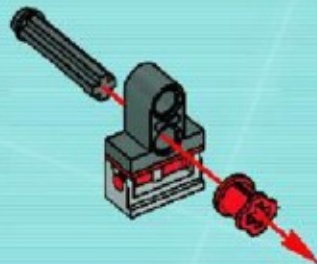

4



5

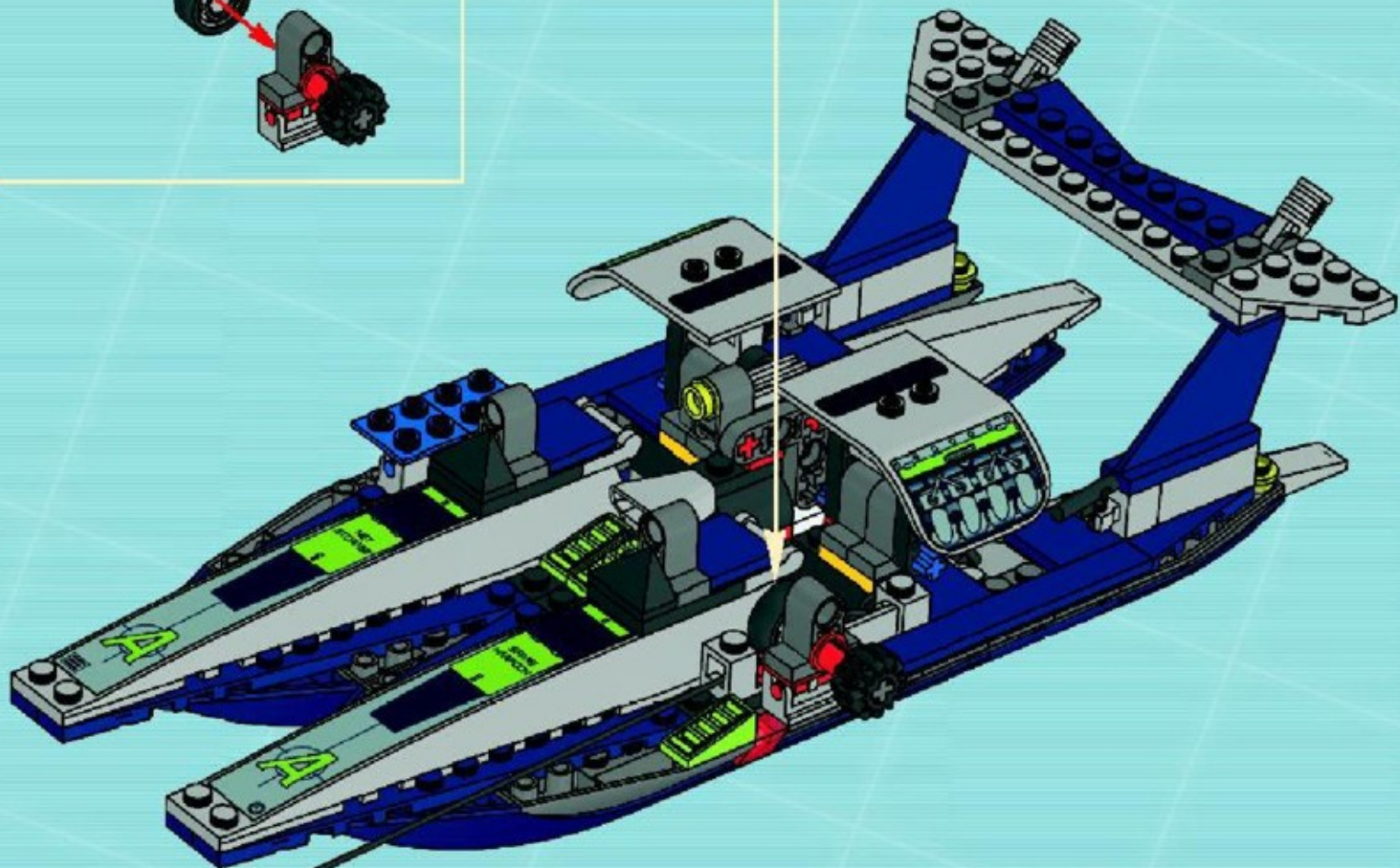



1x

# 31

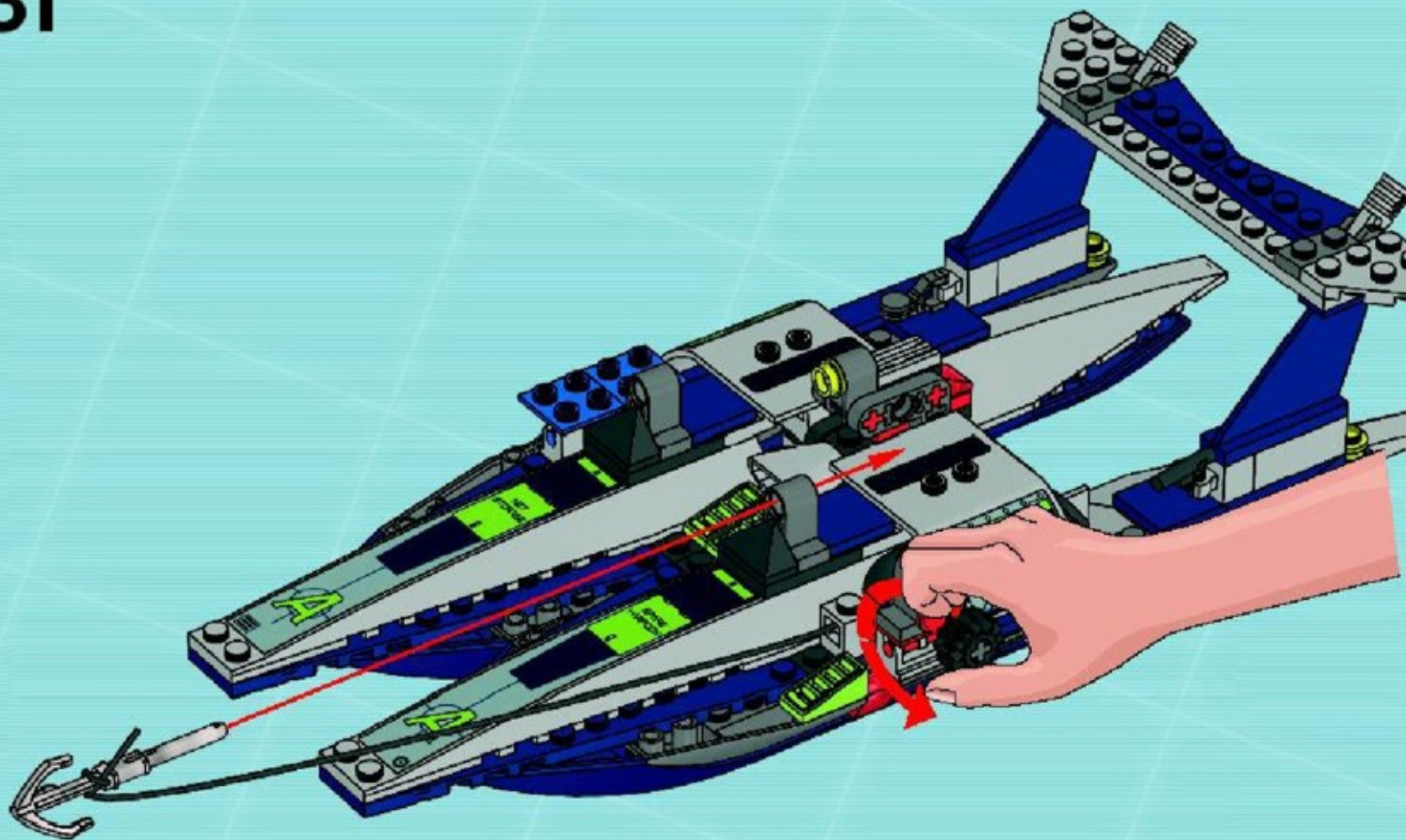





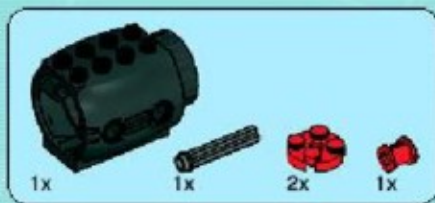

32

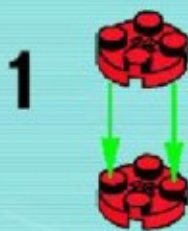



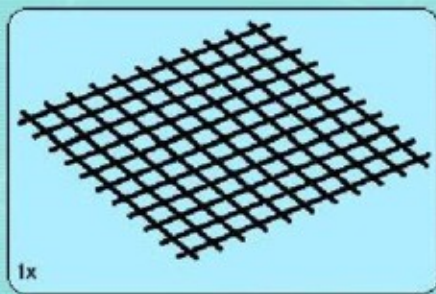

33

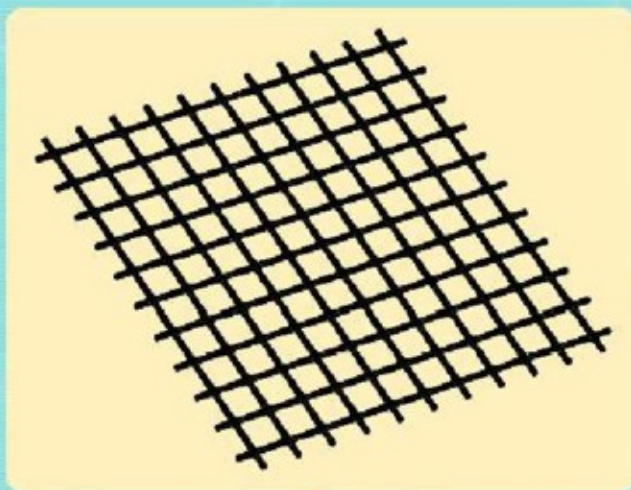

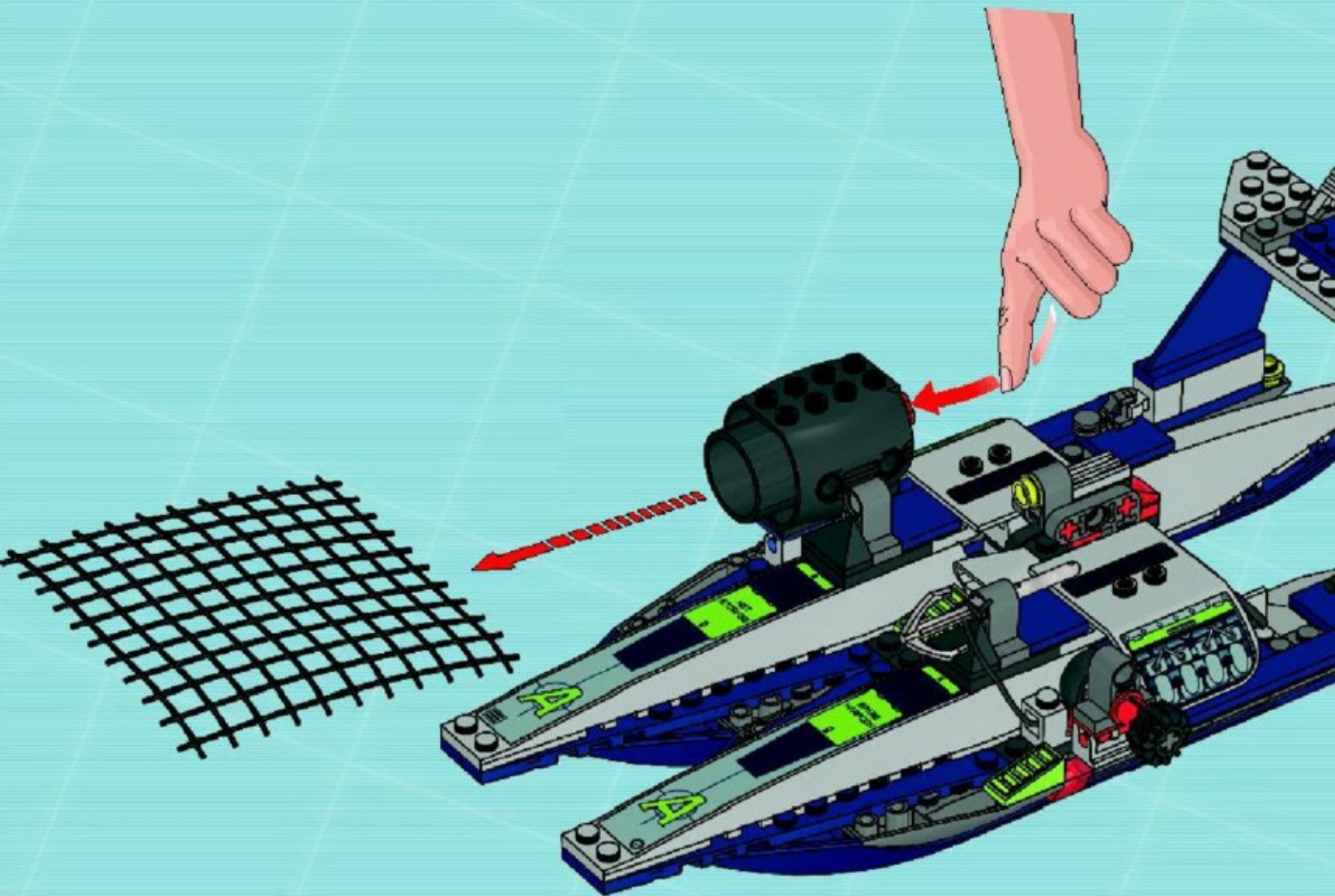



34

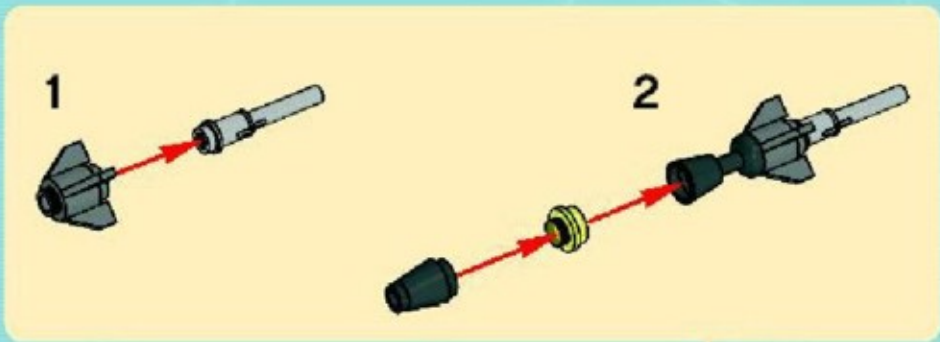

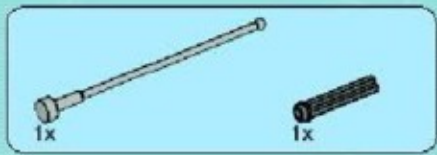

35

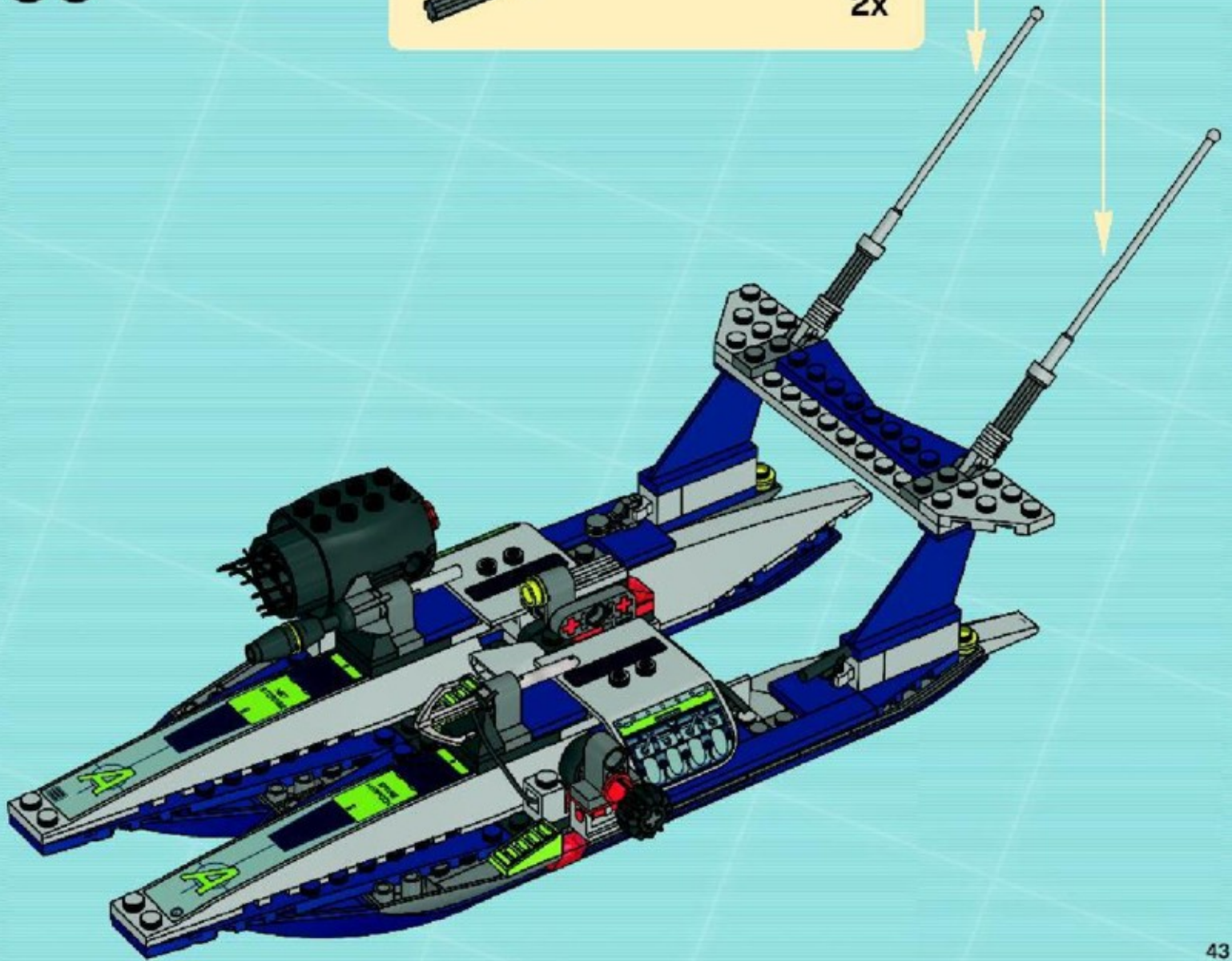
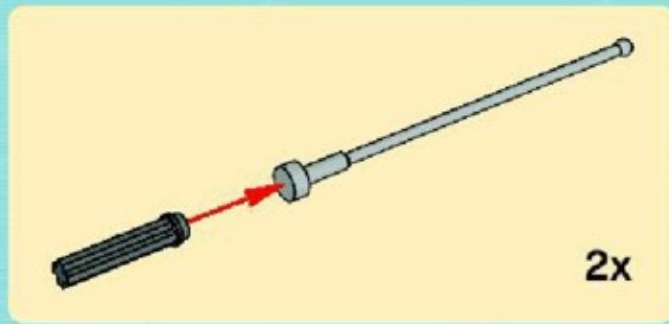

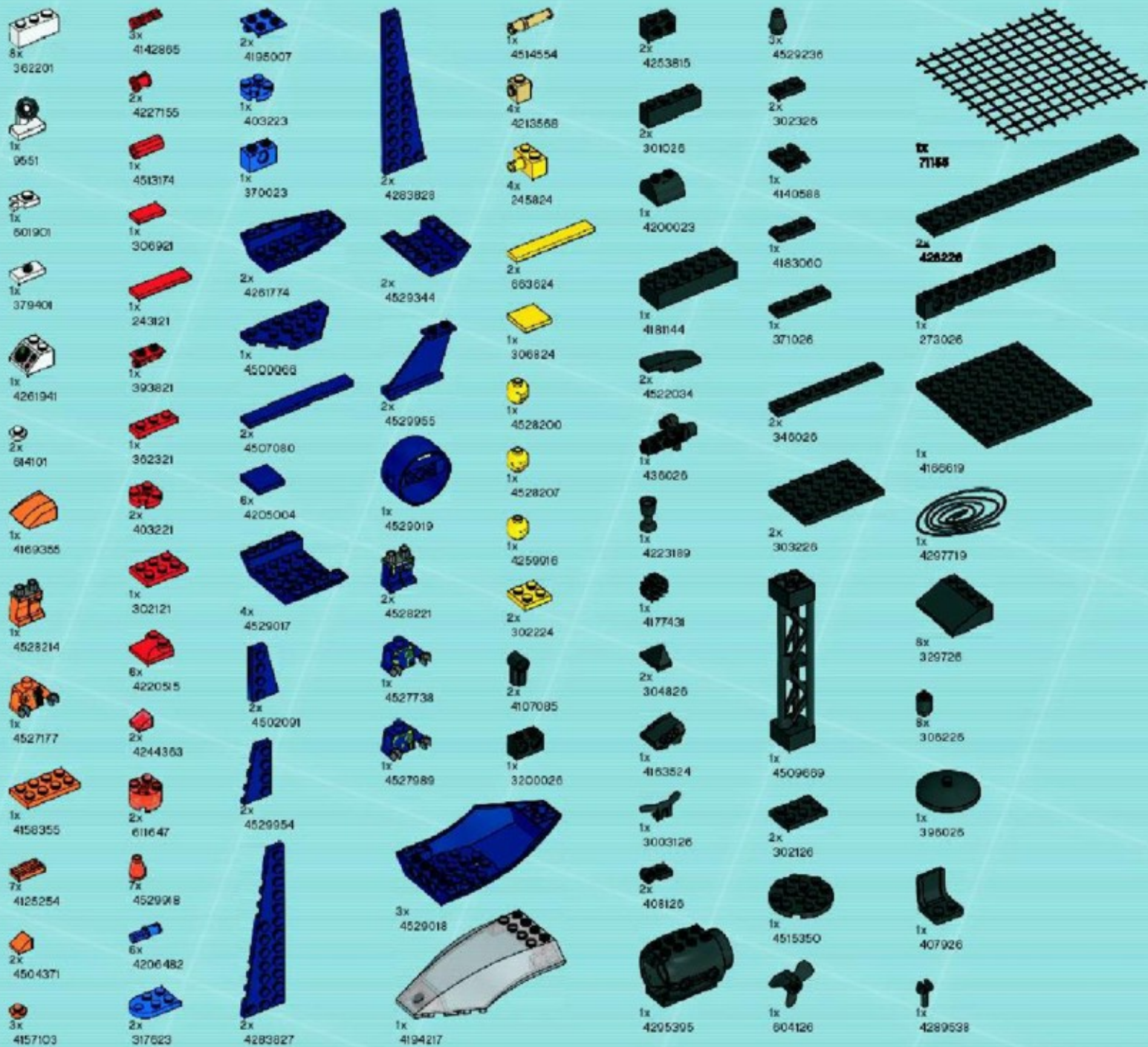



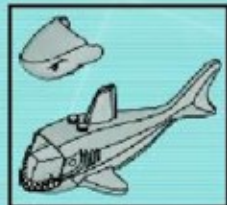

Customer Service  
Kundenservice  
Service Consommateurs  
Servicio Al Consumidor

[www.lego.com/service](http://www.lego.com/service) or dial



: 00800 5346 5555

: 1-800-422-5346



# AGENTS

NAME:

## AGENT CHASE

STATUS:



8634 \*



8635 \*



8632 \*



8630 \*



8633 \*



8631 \*





**YES!** I want to join the LEGO Club FREE! **OH!** I've max'd out my Club LEGO membership!  
 Ja! Ich möchte Mitglied im kostenlosen LEGO Club werden.  
 Ja! Ik wil graag GRATIS lid worden van de LEGO Club.

First Name   
 Surname   
 Title   
 Mailing Address   
 Street   
 Postcode   
 City/Town/Village   
 Country

<input type="checkbox"/>	<input type="checkbox"/>	<input type="checkbox"/>	<input type="checkbox"/>	<input type="checkbox"/>	<input type="checkbox"/>	<input type="checkbox"/>	<input type="checkbox"/>	<input type="checkbox"/>	<input type="checkbox"/>	<input type="checkbox"/>	<input type="checkbox"/>	<input type="checkbox"/>	<input type="checkbox"/>	<input type="checkbox"/>	<input type="checkbox"/>	<input type="checkbox"/>	<input type="checkbox"/>	<input type="checkbox"/>	<input type="checkbox"/>	<input type="checkbox"/>	<input type="checkbox"/>
<input type="checkbox"/>	<input type="checkbox"/>	<input type="checkbox"/>	<input type="checkbox"/>	<input type="checkbox"/>	<input type="checkbox"/>	<input type="checkbox"/>	<input type="checkbox"/>	<input type="checkbox"/>	<input type="checkbox"/>	<input type="checkbox"/>	<input type="checkbox"/>	<input type="checkbox"/>	<input type="checkbox"/>	<input type="checkbox"/>	<input type="checkbox"/>	<input type="checkbox"/>	<input type="checkbox"/>	<input type="checkbox"/>	<input type="checkbox"/>	<input type="checkbox"/>	<input type="checkbox"/>
<input type="checkbox"/>	<input type="checkbox"/>	<input type="checkbox"/>	<input type="checkbox"/>	<input type="checkbox"/>	<input type="checkbox"/>	<input type="checkbox"/>	<input type="checkbox"/>	<input type="checkbox"/>	<input type="checkbox"/>	<input type="checkbox"/>	<input type="checkbox"/>	<input type="checkbox"/>	<input type="checkbox"/>	<input type="checkbox"/>	<input type="checkbox"/>	<input type="checkbox"/>	<input type="checkbox"/>	<input type="checkbox"/>	<input type="checkbox"/>	<input type="checkbox"/>	<input type="checkbox"/>
<input type="checkbox"/>	<input type="checkbox"/>	<input type="checkbox"/>	<input type="checkbox"/>	<input type="checkbox"/>	<input type="checkbox"/>	<input type="checkbox"/>	<input type="checkbox"/>	<input type="checkbox"/>	<input type="checkbox"/>	<input type="checkbox"/>	<input type="checkbox"/>	<input type="checkbox"/>	<input type="checkbox"/>	<input type="checkbox"/>	<input type="checkbox"/>	<input type="checkbox"/>	<input type="checkbox"/>	<input type="checkbox"/>	<input type="checkbox"/>	<input type="checkbox"/>	<input type="checkbox"/>

Age   
 Date of Birth   
 E-mail   
 Telephone   
 Fax

Age   
 Date of Birth   
 E-mail   
 Telephone   
 Fax

The LEGO Group is pleased to inform you that it is now possible to join the LEGO Club FREE! This is a new and exciting way to receive the LEGO Club Magazine (free of charge) and other special offers from LEGO. The LEGO Club Magazine is published quarterly and contains a wealth of information and inspiration for LEGO enthusiasts. It features articles, photographs, and illustrations that will inspire you to build new and exciting LEGO creations. The LEGO Club Magazine is also a great way to keep up to date with the latest LEGO news and events. To receive your free LEGO Club Magazine, please complete the form and return it to the LEGO Club, P.O. Box 1157, Enfield, CT USA 06083-1157. The LEGO Club Magazine is published by LEGO Group, PO Box 1157, Enfield, CT 06083-1157. The LEGO Club Magazine is published by LEGO Group, PO Box 1157, Enfield, CT 06083-1157. The LEGO Club Magazine is published by LEGO Group, PO Box 1157, Enfield, CT 06083-1157.

USA & Canada  
 LEGO Club, P.O. Box 1157  
 Enfield, CT USA 06083-1157

UK  
 LEGO Club, 33 Beach Road  
 Slough, SL1 3RF U.K.

France  
 LEGO Club, PoF 0214 15  
 D-36243 Niederveruhl



# club

FREE LEGO Magazine • GRATUIT • GRATIS LEGO Magazin



Join Today!

Abonne-toi dès aujourd'hui!

Meld je nu aan!

Jetzt anmelden!



US & Canada only

1-866-534-6258

1-877-518-5346

(US Only)



00800 5346 5555

VISIT THE  
 WORLD'S BIGGEST  
 LEGO SHOP!

[www.LEGOshop.com](http://www.LEGOshop.com)

[www.LEGOclub.com](http://www.LEGOclub.com)



[www.acnielsen.aim.dk/LEGO](http://www.acnielsen.aim.dk/LEGO)



## WIN LEGO® PRODUCTS

No purchase necessary.  
Open to residents of all countries where  
not prohibited.  
Go to [www.lego.com](http://www.lego.com) for official rules and details.

## WIN LEGO® PRODUCTEN

Kopen niet nodig.  
Open voor alle leeftijden, en in alle landen  
waar geen verbod geldt.  
Ga naar [www.lego.com](http://www.lego.com) voor officiële regels en details.

## GEWINNE LEGO® PRODUKTE

Die Teilnahme am Gewinnspiel führt zu  
keinerlei Kaufverpflichtungen.  
Sie können in allen nicht ausgeschlossenen  
Ländern teilnehmen.  
Die offiziellen Regeln und nähere Informationen  
finden Sie unter [www.lego.com](http://www.lego.com).

## GAGNE DES PRODUITS LEGO®

Aucun achat n'est nécessaire.  
Ouvert à tous les âges et aux résidents de  
tous les pays, sauf en cas d'interdiction.  
Rendez-vous sur [www.lego.com](http://www.lego.com) pour obtenir plus  
de détails et le règlement officiel.

## レゴ®製品を「当てよう」

購入は不要です  
禁止されていない限り、あらゆる  
年代およびあらゆる国の居住者の  
方々にご利用いただけます。  
公認規則および詳細につきましては、  
[www.lego.com](http://www.lego.com)をご覧ください

