

LEGO

10029



United States

4233750

Discovery
CHANNEL

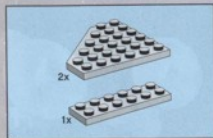
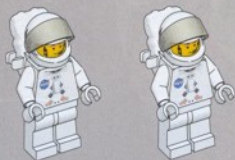
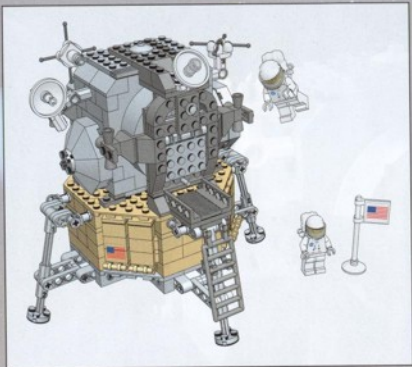
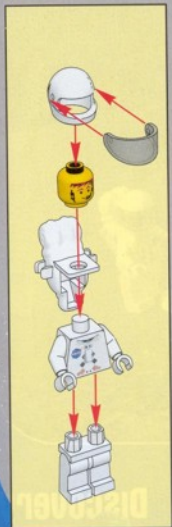

1

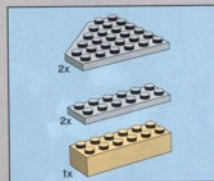
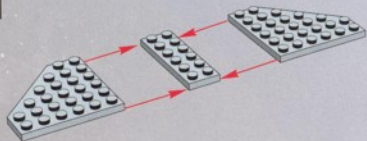

2

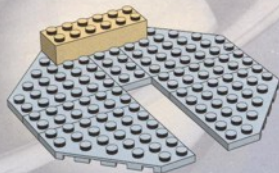

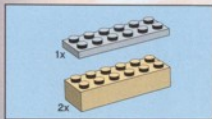

3

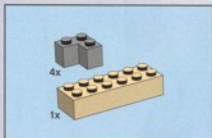
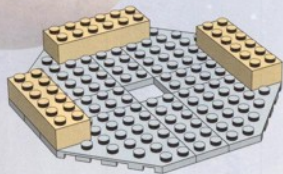

4

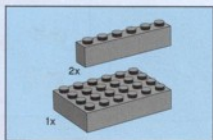
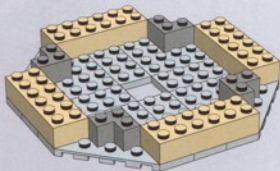

5

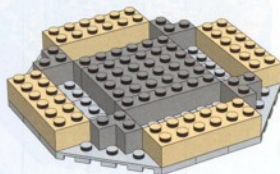

6

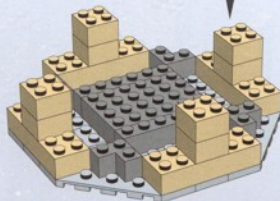
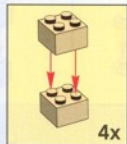

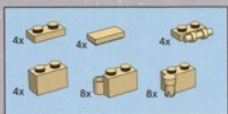

7

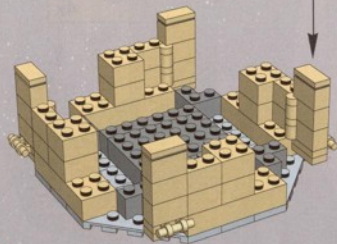
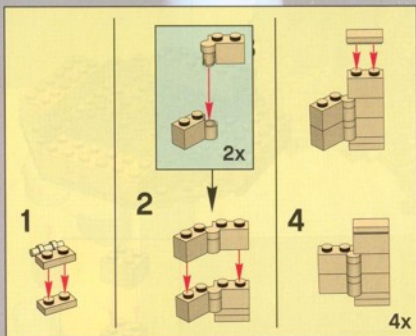

8

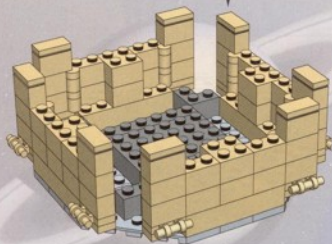
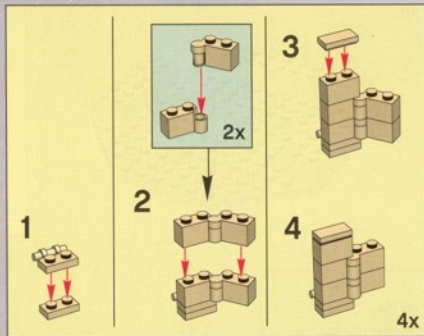
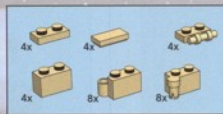

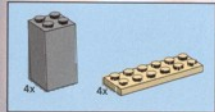

9

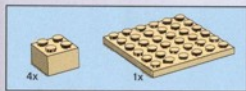
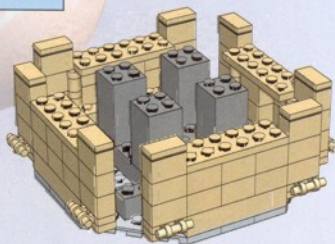

10

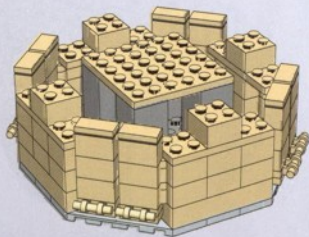

11

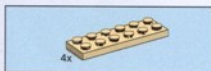
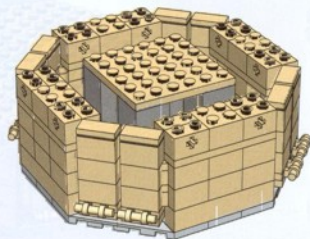

12

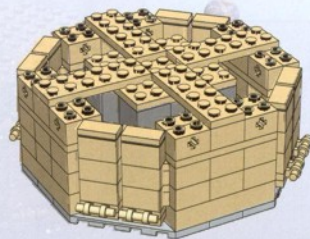



13

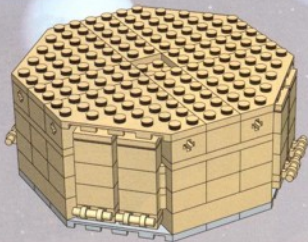

15

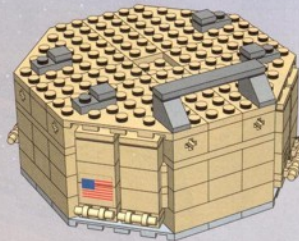

14

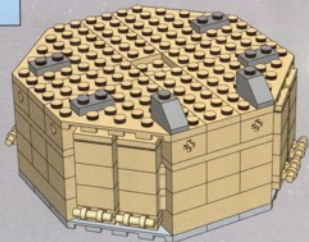

16

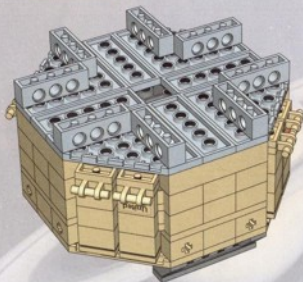



17

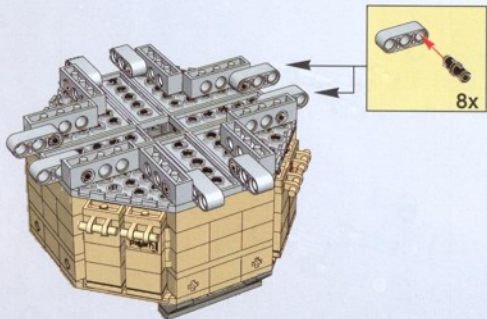

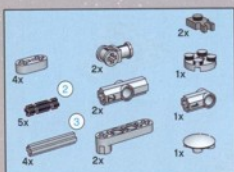

18

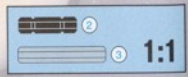
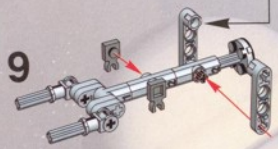
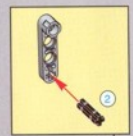
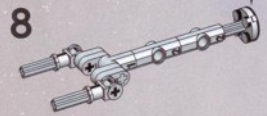
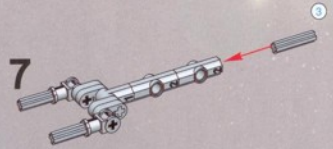
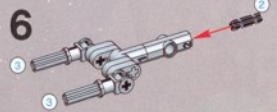
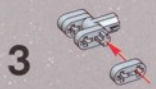

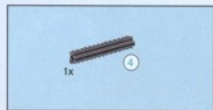
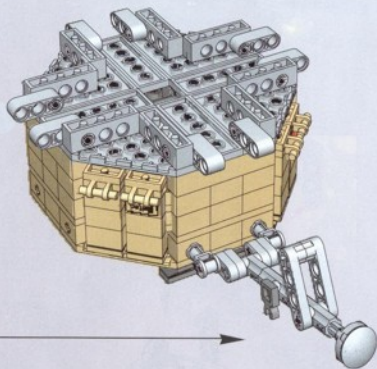

19

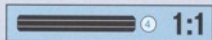
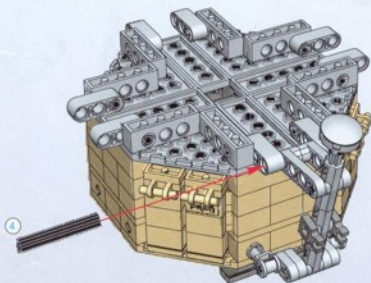

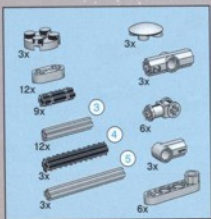

20

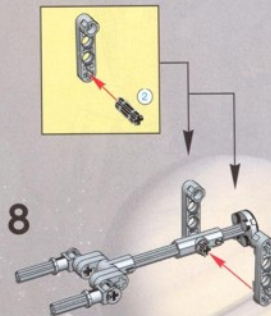
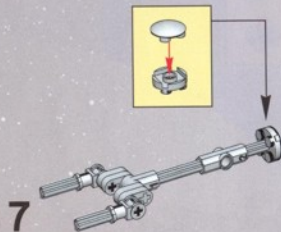
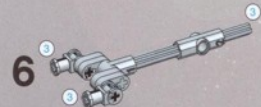

3x

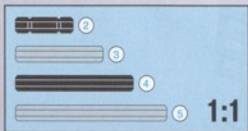
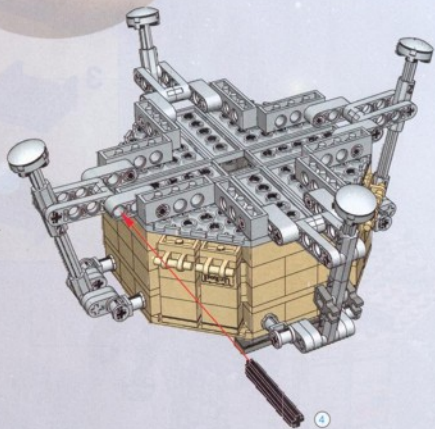

21

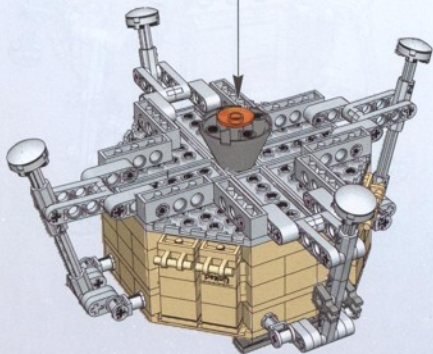
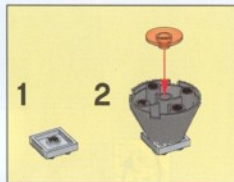



22

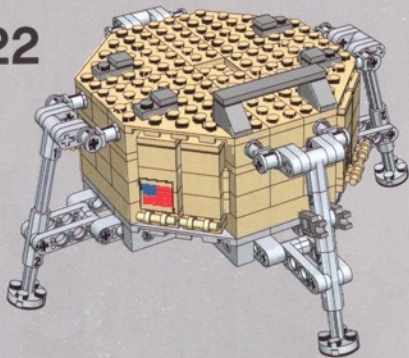

23

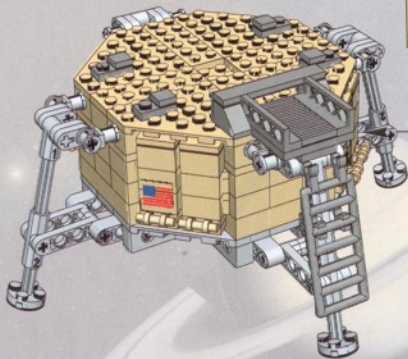
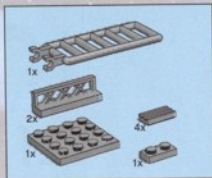

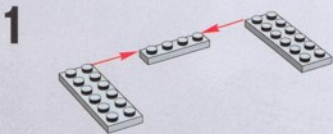
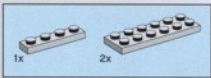
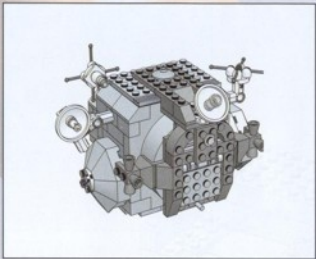

2

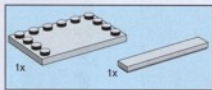
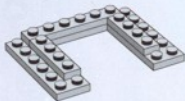

3

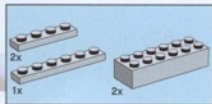
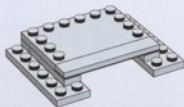

4

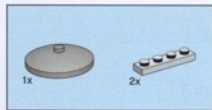
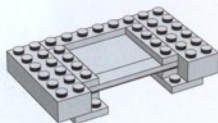

5



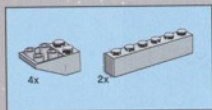

6

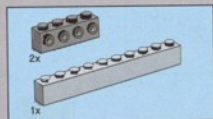
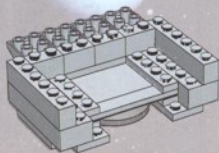

7

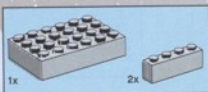
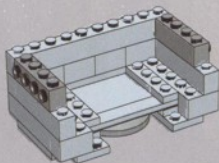

8

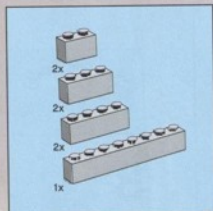
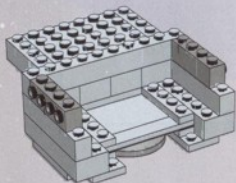

9

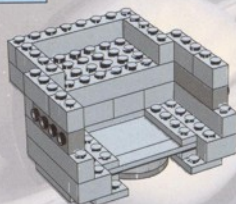

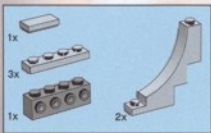

10

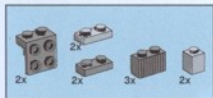
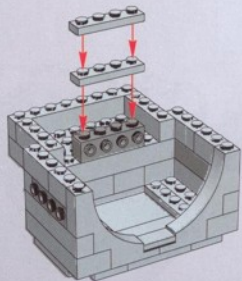
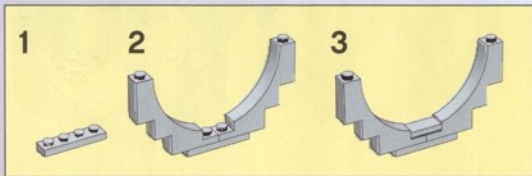

11

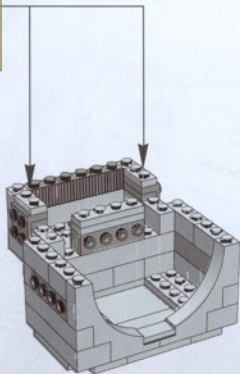
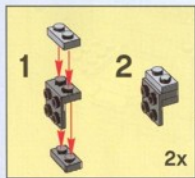

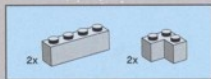

12

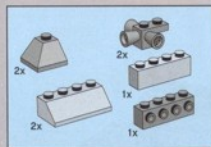
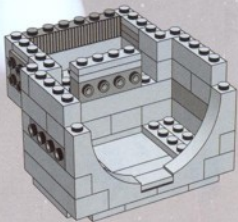

13

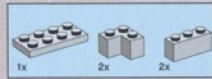
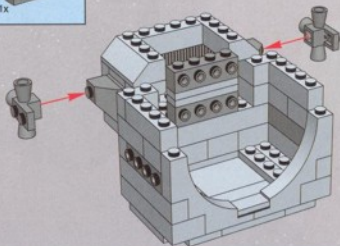

14

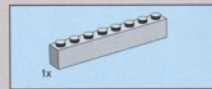
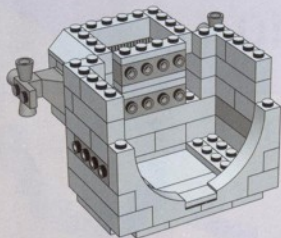

15

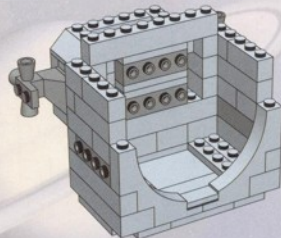

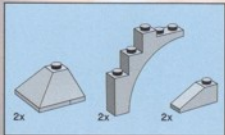

16

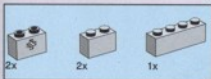
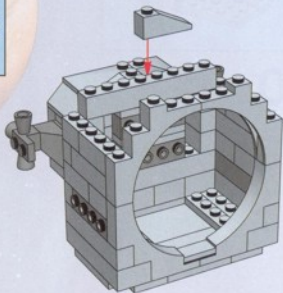

17

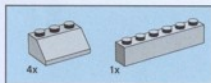
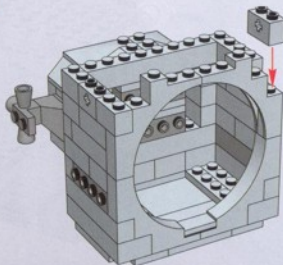

18

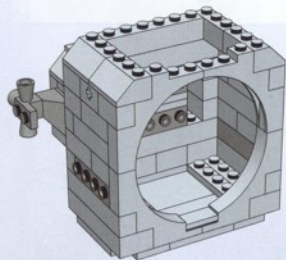

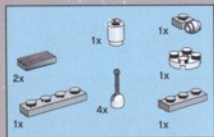

19

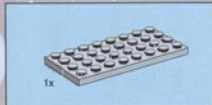
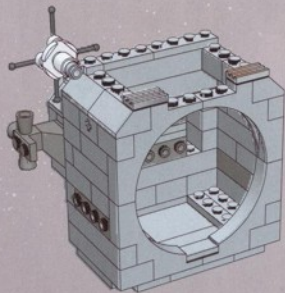
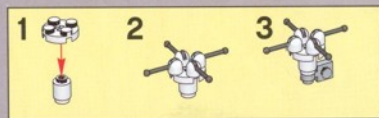

20

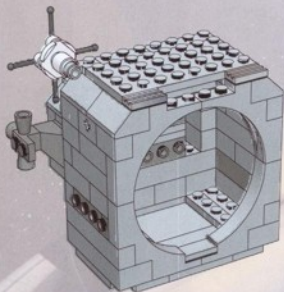

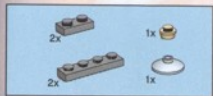

21

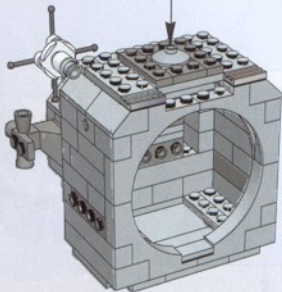

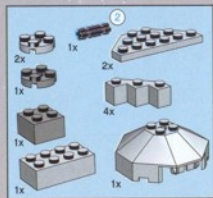

22

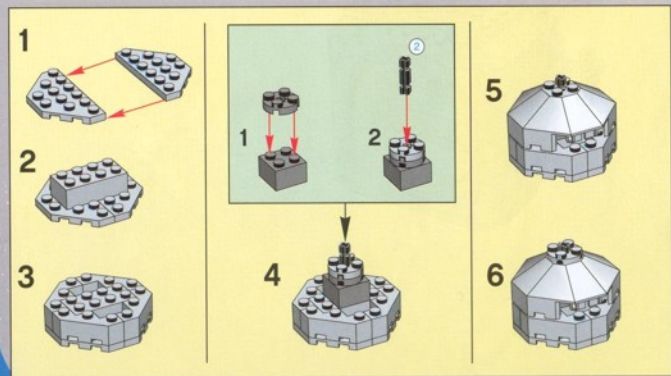
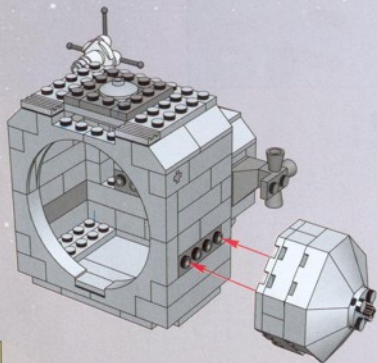



23

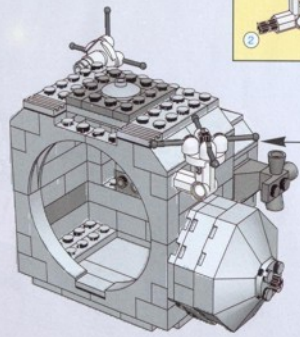
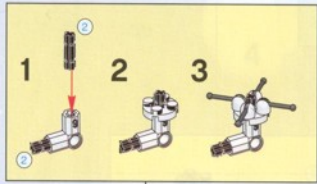



24

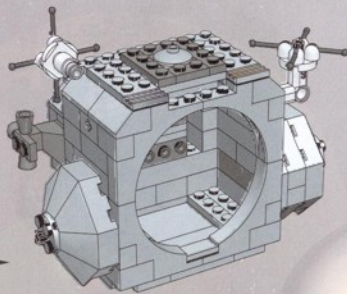
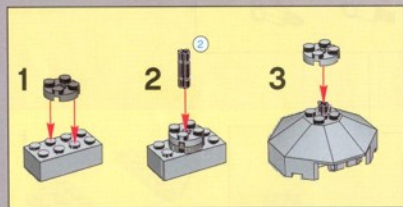



26

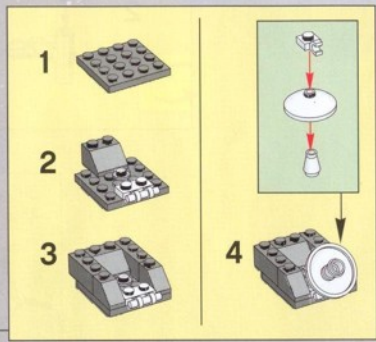
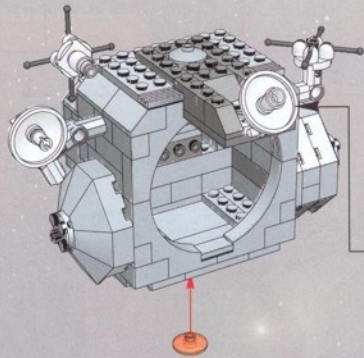



1

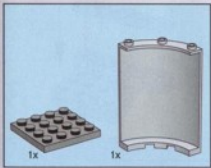
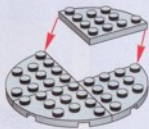

2



3

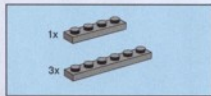

4





5

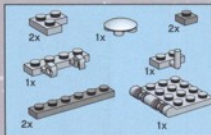
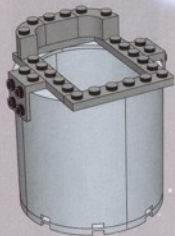

6

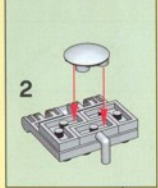
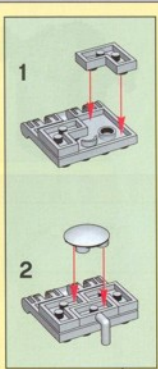
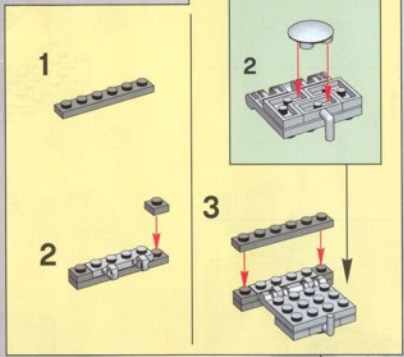

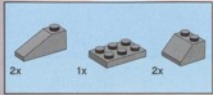

7



8

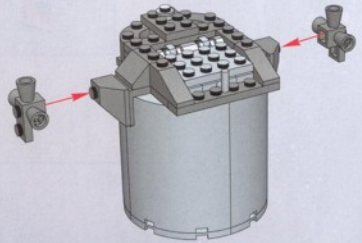

27

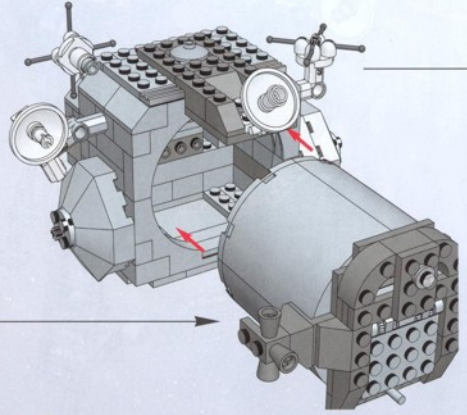



24

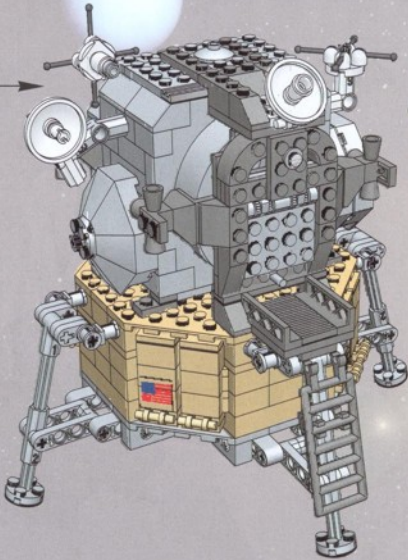

1

2

Diagram 1 shows a long white axle being inserted into a hole in a white circular base. Diagram 2 shows a grey flag bracket being attached to the end of the white axle. An inset shows the bracket with a red flag attached. An arrow points from the inset to the final assembly of the flag on the axle.



7471 MARS EXPLORATION ROVER

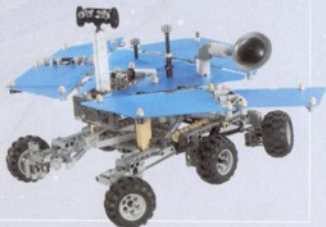

7468 SATURN V MOON MISSION



7469 MISSION TO MARS



7470 SPACE SHUTTLE DISCOVERY

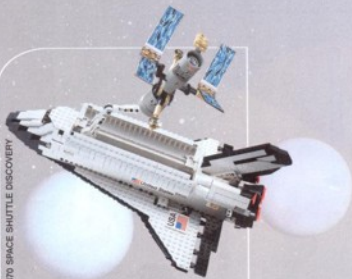

7487 INTERNATIONAL SPACE STATION

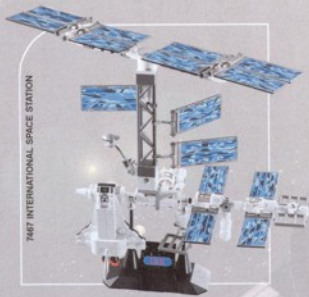

Win! Gagne! Gewinne! 当たります



Win LEGO® products

We would really like to know what you think about your new LEGO® product.

If you could help us by answering a few questions at www.acnielsen.aim.dk/lego then you are in with a chance of winning an exciting LEGO prize.

It will only take you about 3 minutes!



Estimado usuario LEGO®

Al contestar algunas preguntas en inglés, francés, alemán o japonés, en el sitio www.acnielsen.aim.dk/lego, podrás participar en el sorteo de algunos valiosos premios LEGO®.



Gagne des produits LEGO®

Nous aimerions beaucoup savoir ce que tu penses de ton nouveau produit LEGO®.

Si tu veux bien nous aider en répondant à quelques questions sur www.acnielsen.aim.dk/lego, tu recevras peut-être bientôt l'un des nombreux super-prix offerts par LEGO aux participants.

Et cela ne te prendra que 3 minutes environ !



Kedves Ifjú LEGO® Vásárló

Ha ellátogatsz a www.acnielsen.aim.dk/lego honlapra és ott angol, francia, német vagy japán nyelven megválaszolsz néhány kérdést, akkor részt veszel egy versenyben, amelyben értékes LEGO® díjak nyerhetsz.



Gewinne LEGO® Produkte

Wir sind sehr an deiner Meinung über dein neues LEGO® Produkt interessiert.

Wenn du uns den Gefallen tust und unter www.acnielsen.aim.dk/lego Fragen beantwortest, kannst du einen tollen LEGO Preis gewinnen.

Das Ganze dauert nur etwa 3 Minuten!



Caro Consumidor da LEGO®

Ao responder a algumas perguntas em Inglês, Francês, Alemão ou Japonês no endereço www.acnielsen.aim.dk/lego irá participar num concurso para ganhar valiosos prémios da LEGO®.



抽選でレゴ製品が当たります

私たちは、皆さんがレゴ製品についてどんな感想をお持ちか、是非知りたいと思っています。

www.acnielsen.aim.dk/legoにアクセスいただき、質問にご回答いただきますと、抽選で楽しいレゴ製品が当たります。

アンケートのご回答には、ほんの3分ほどしかかかりません!



