

LEGO SYSTEM™

5895

Belville

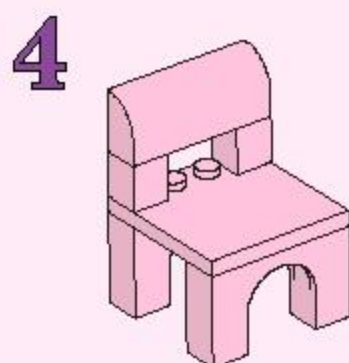

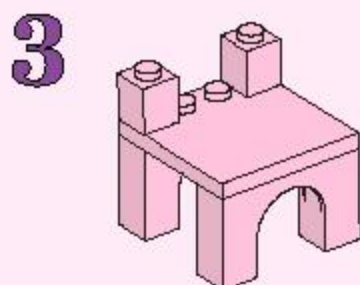
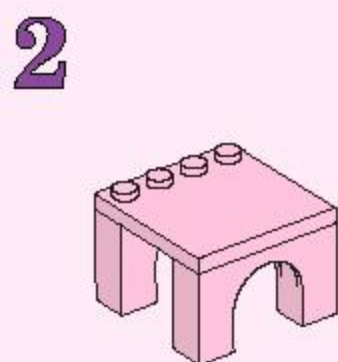
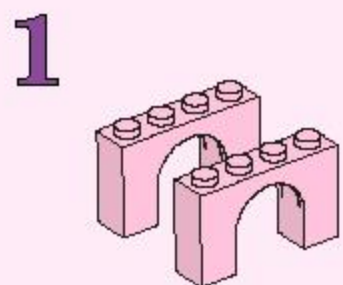
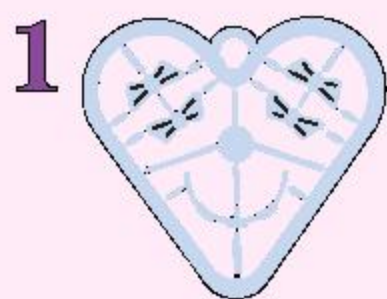

1

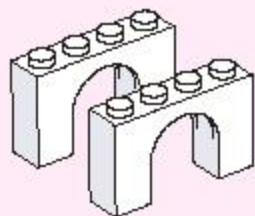

2

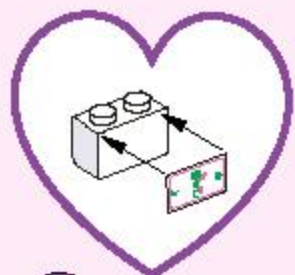
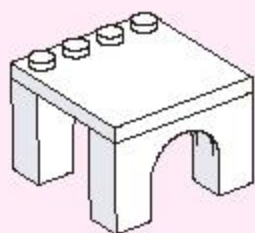

3

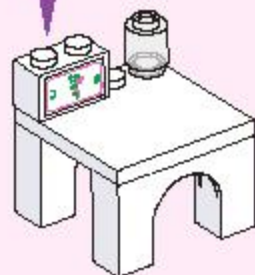

4



1

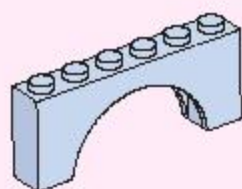

2

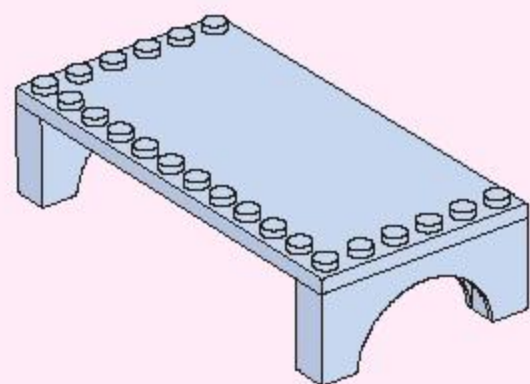
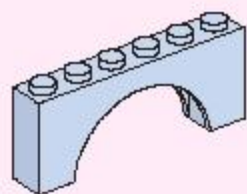

3

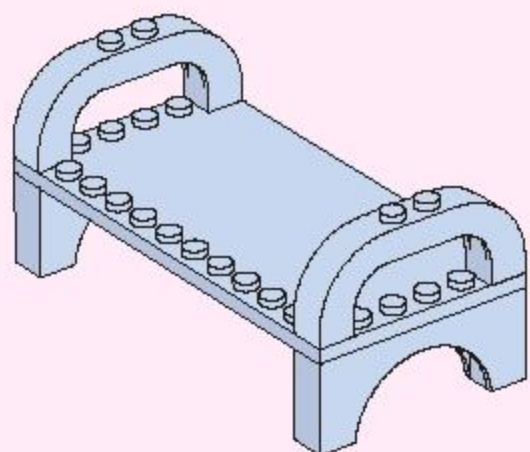

1

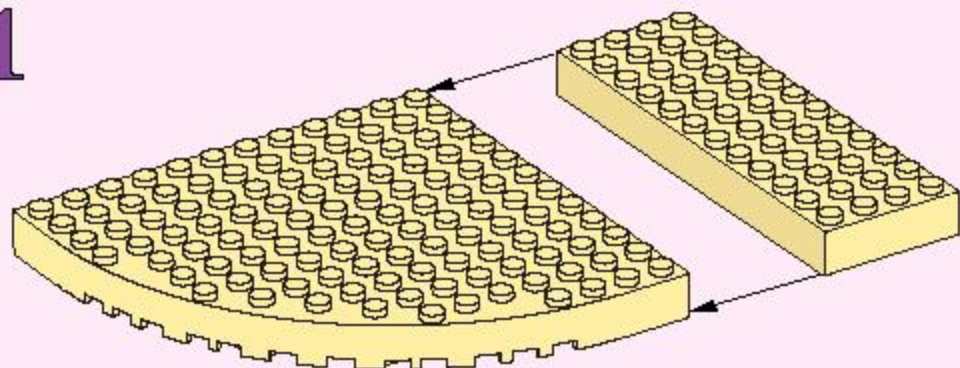

2

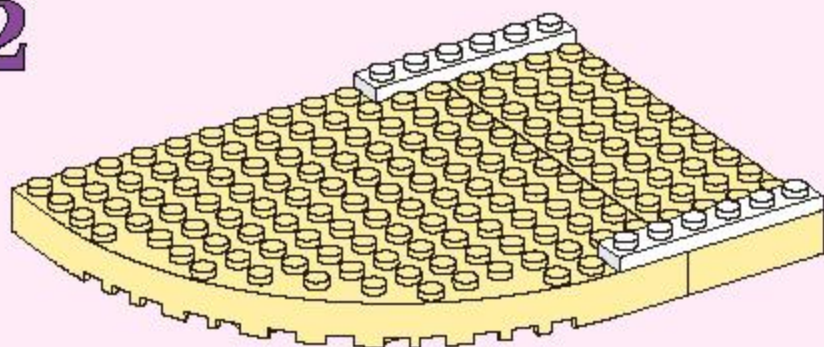

3

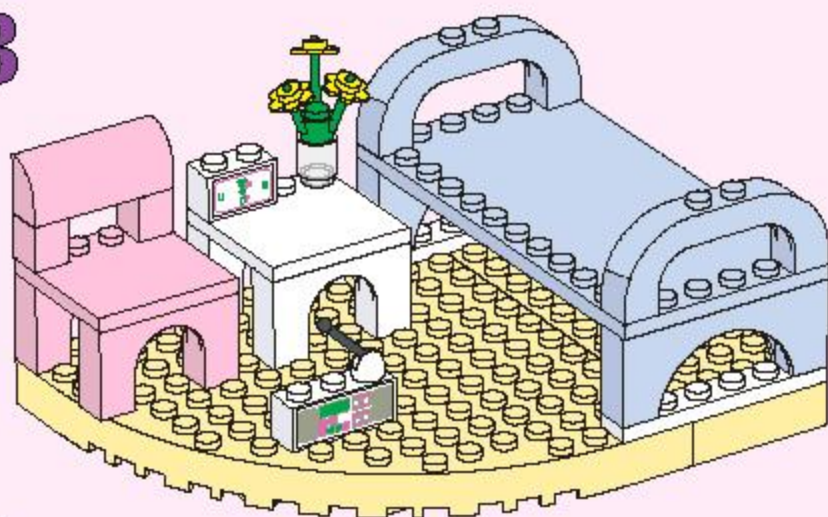

1

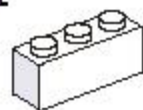

2



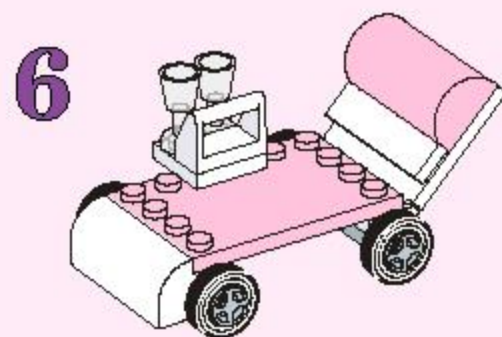
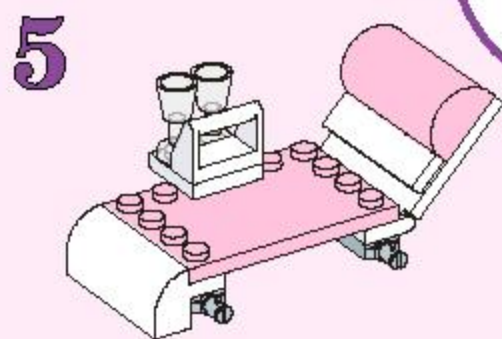
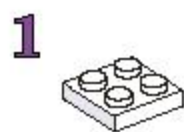
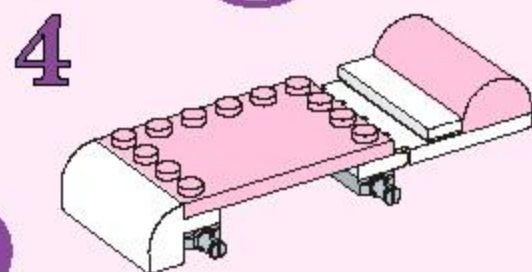
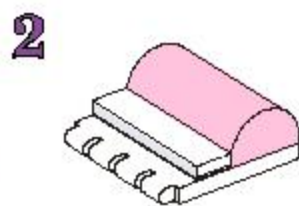
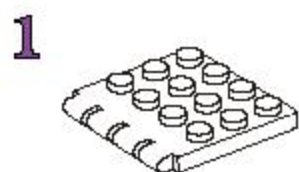
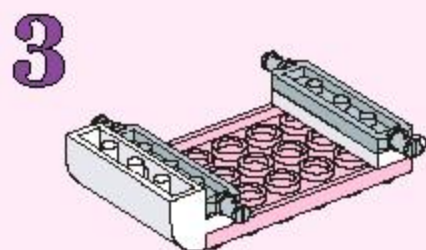
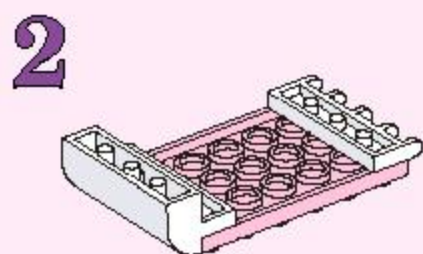
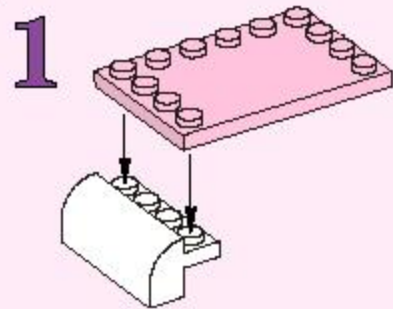

1

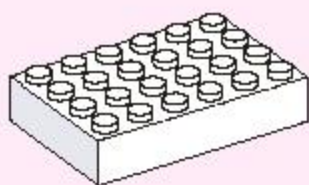

2

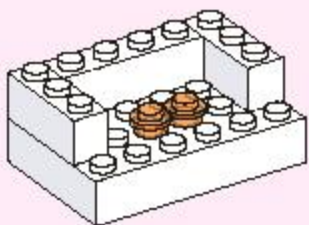

3

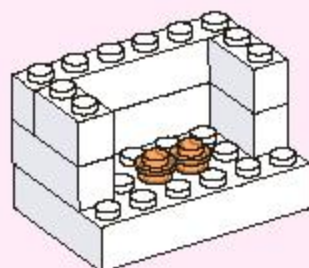

4

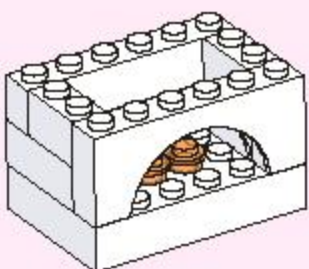

5

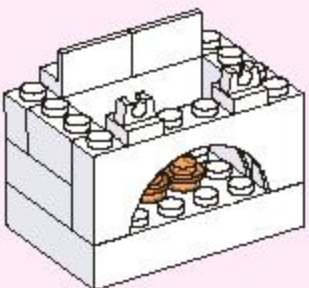

6

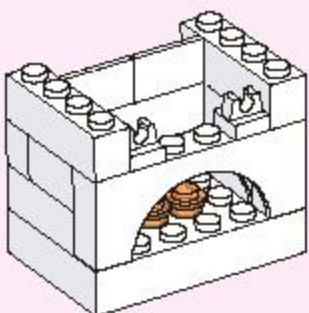

7

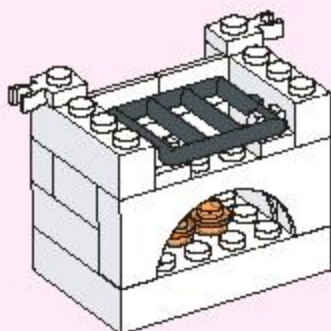

8

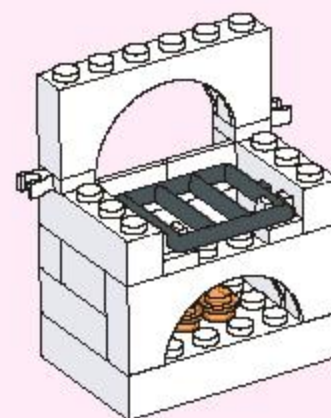

9

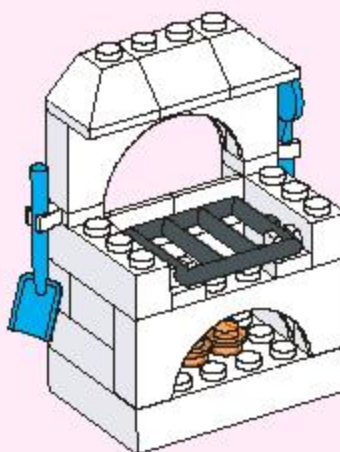

10

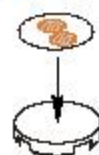
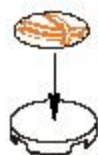
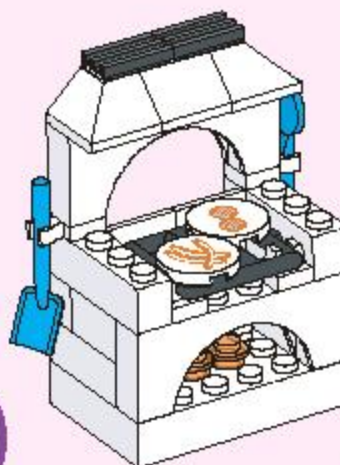

1

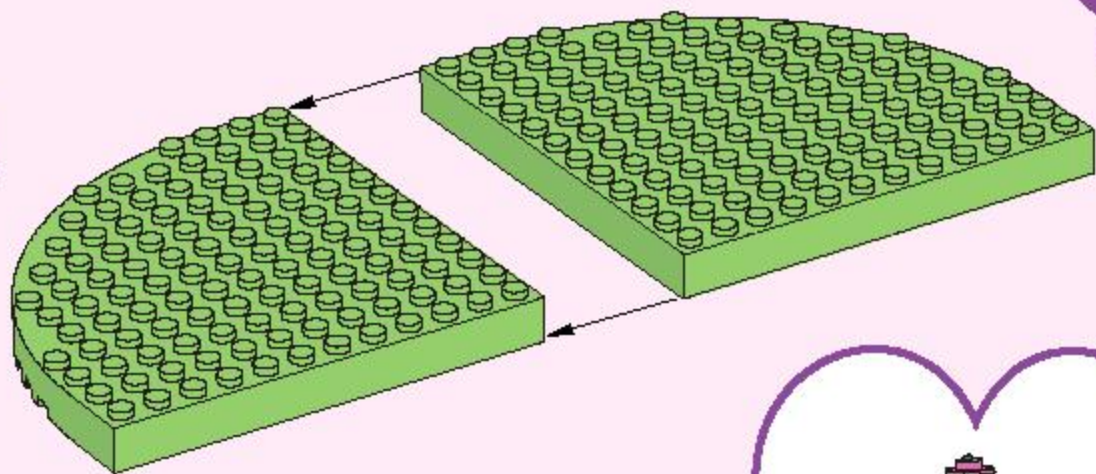

2

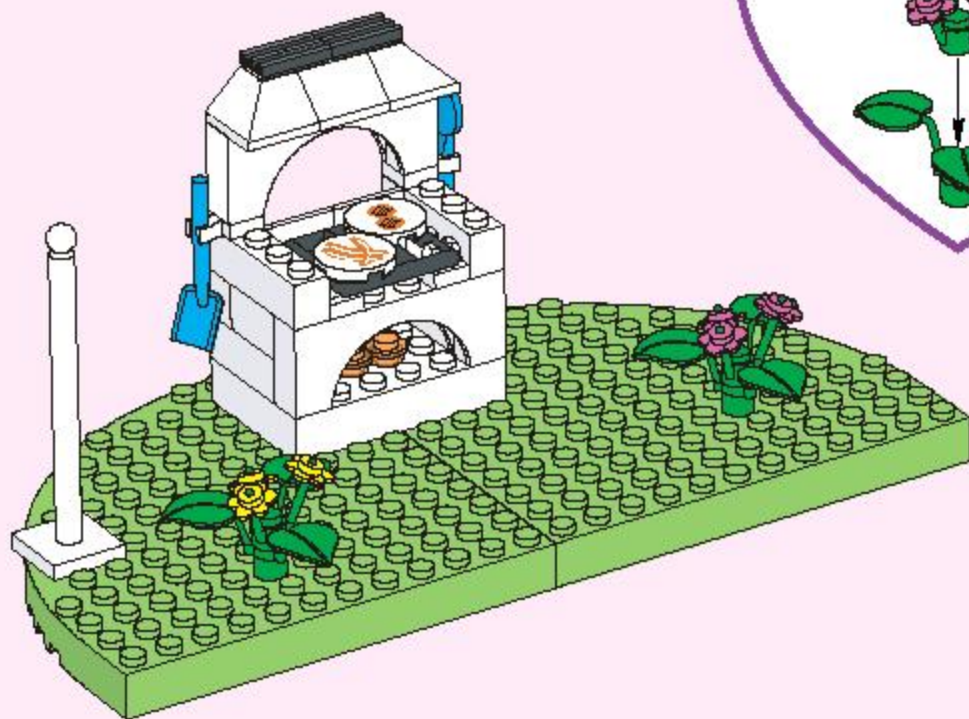

3

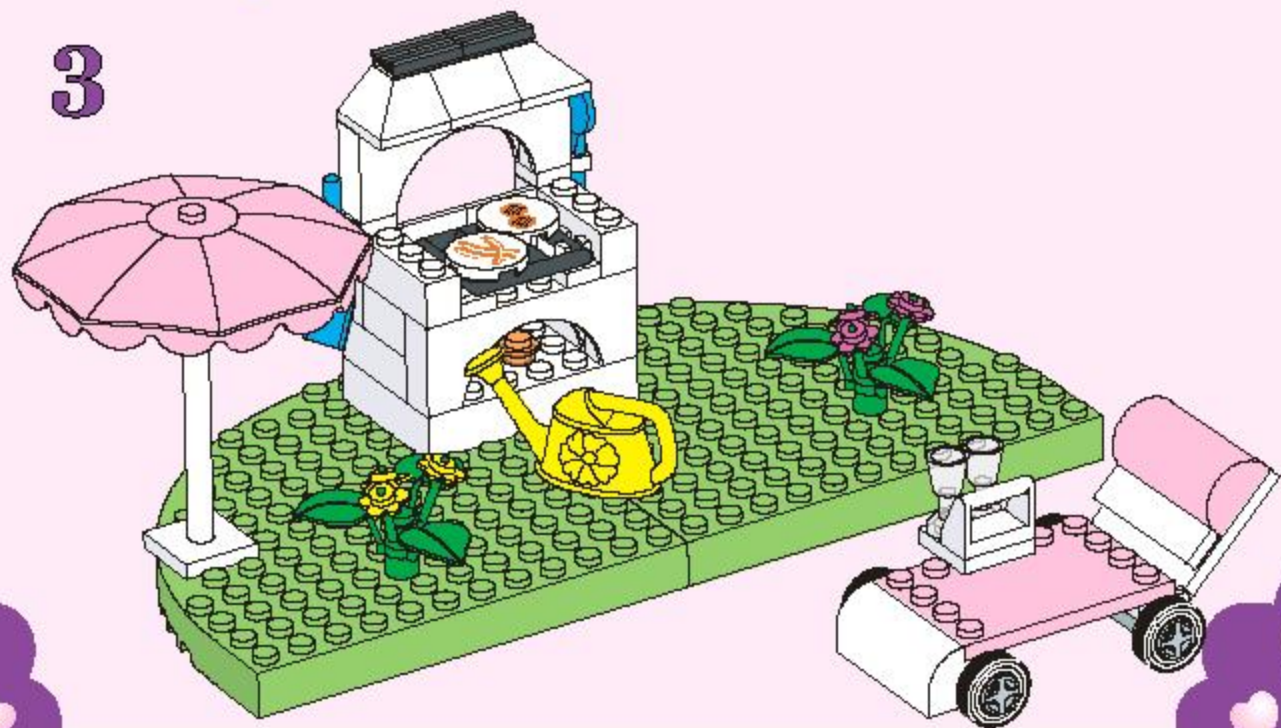

1

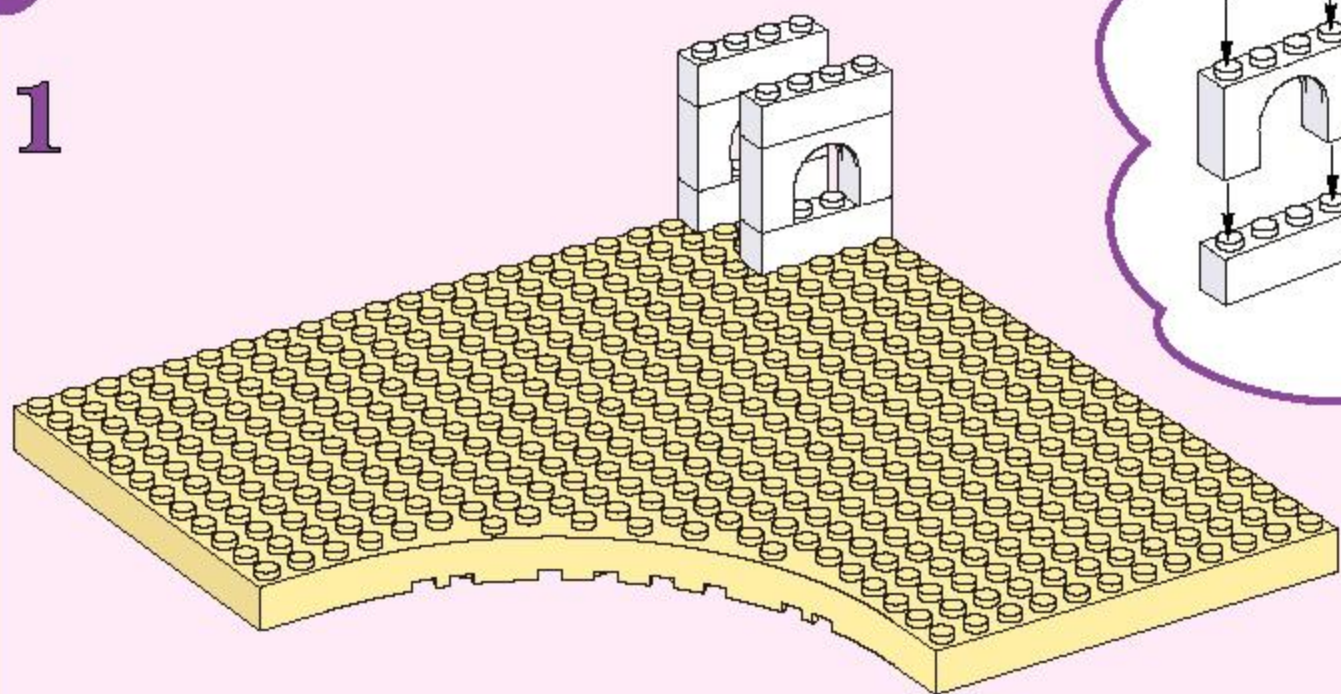

2

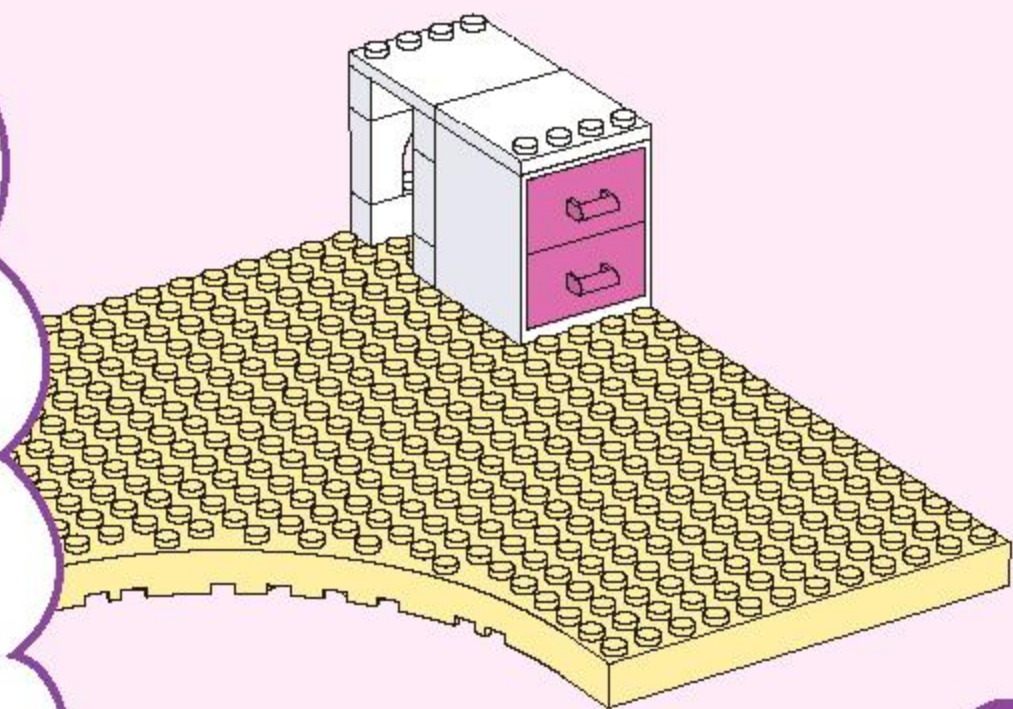
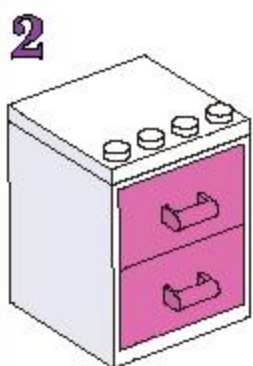
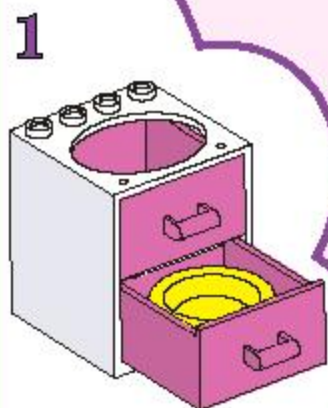

1

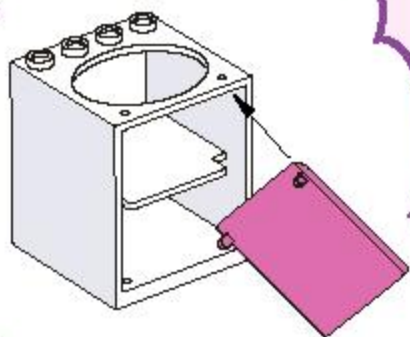

2

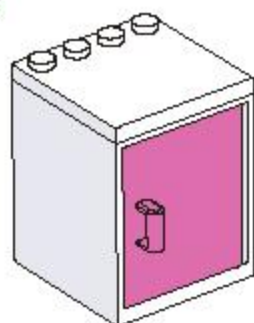

1

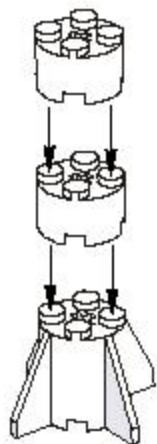

2

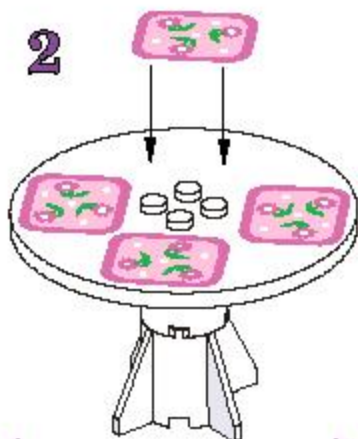

3

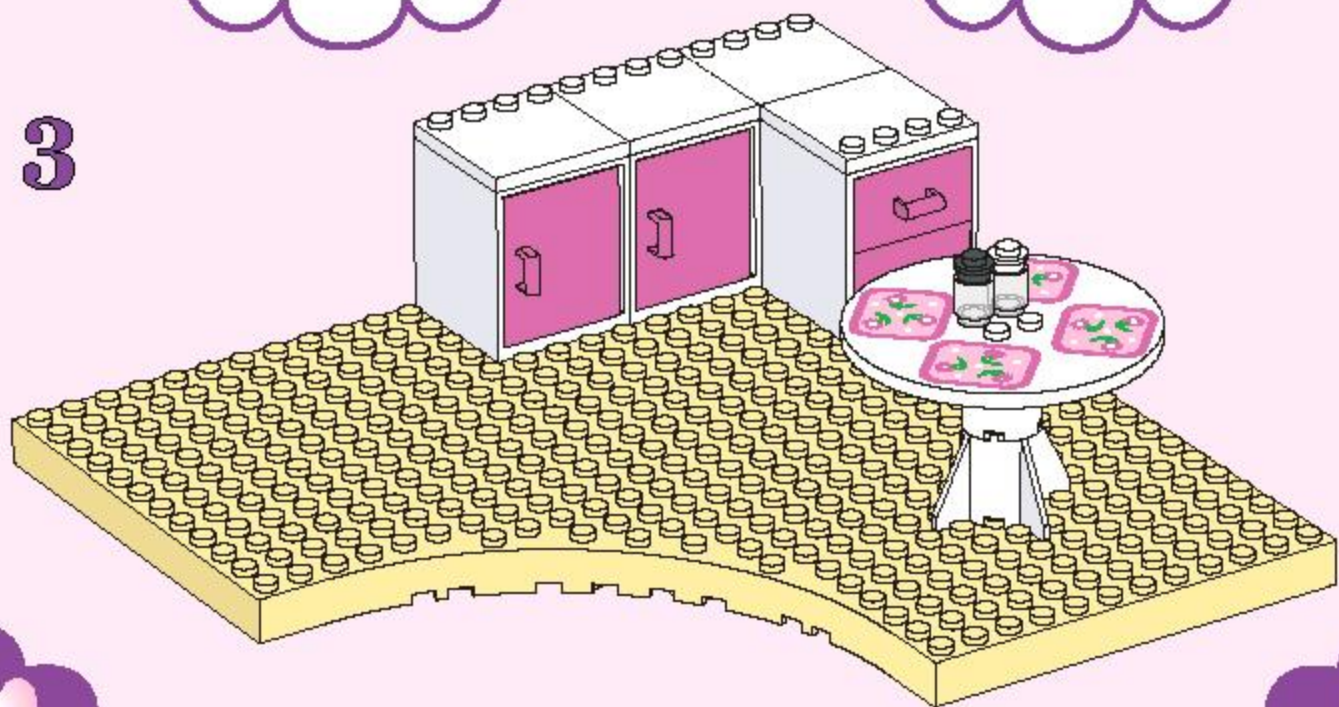

1

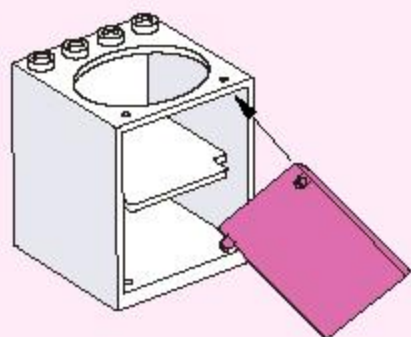

2



1



2

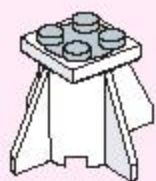

3

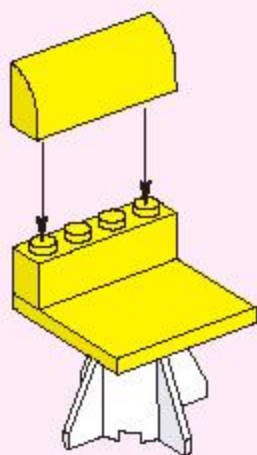

4

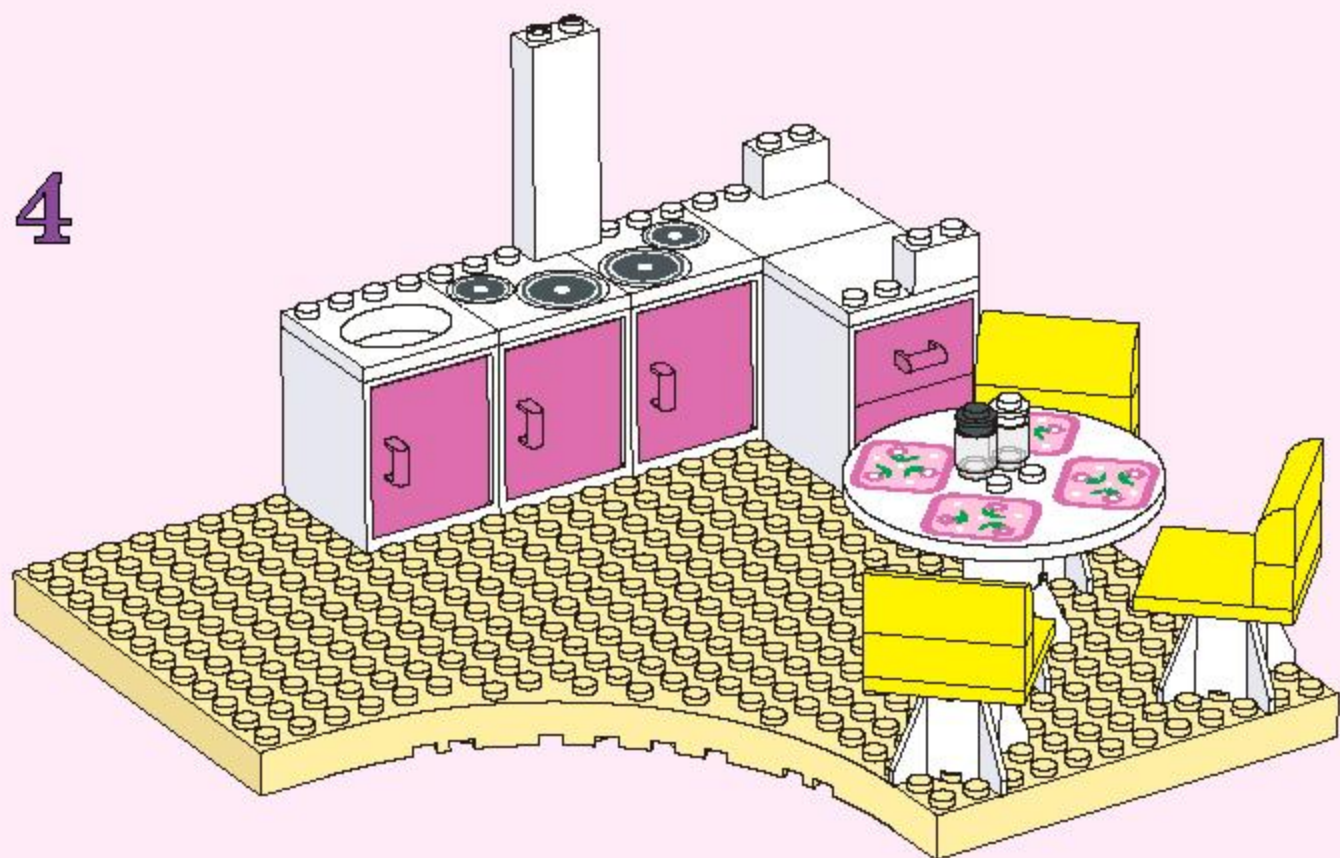

1

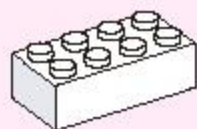

2

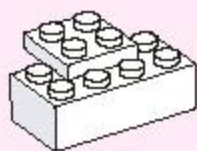

3

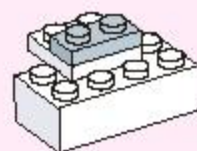

4

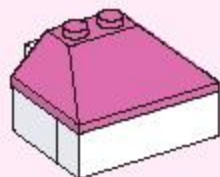
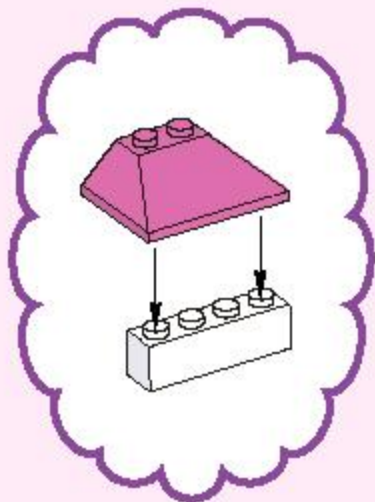

5

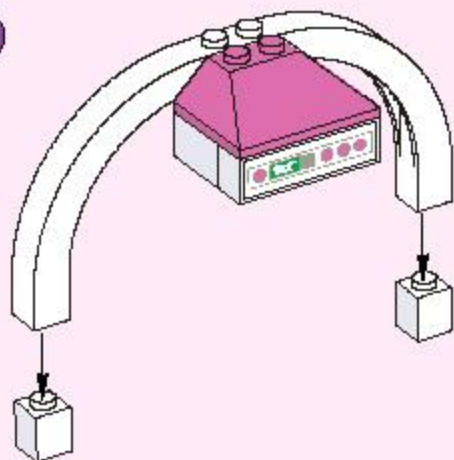

6

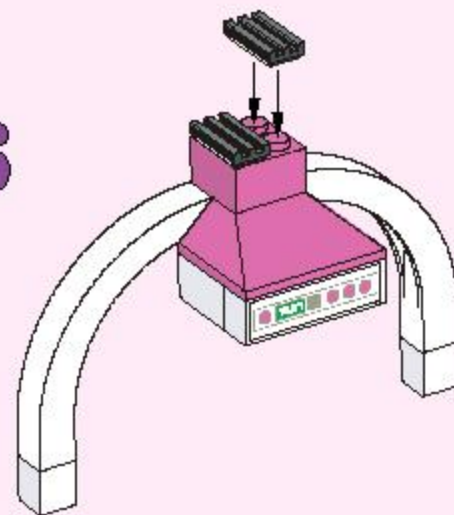

5

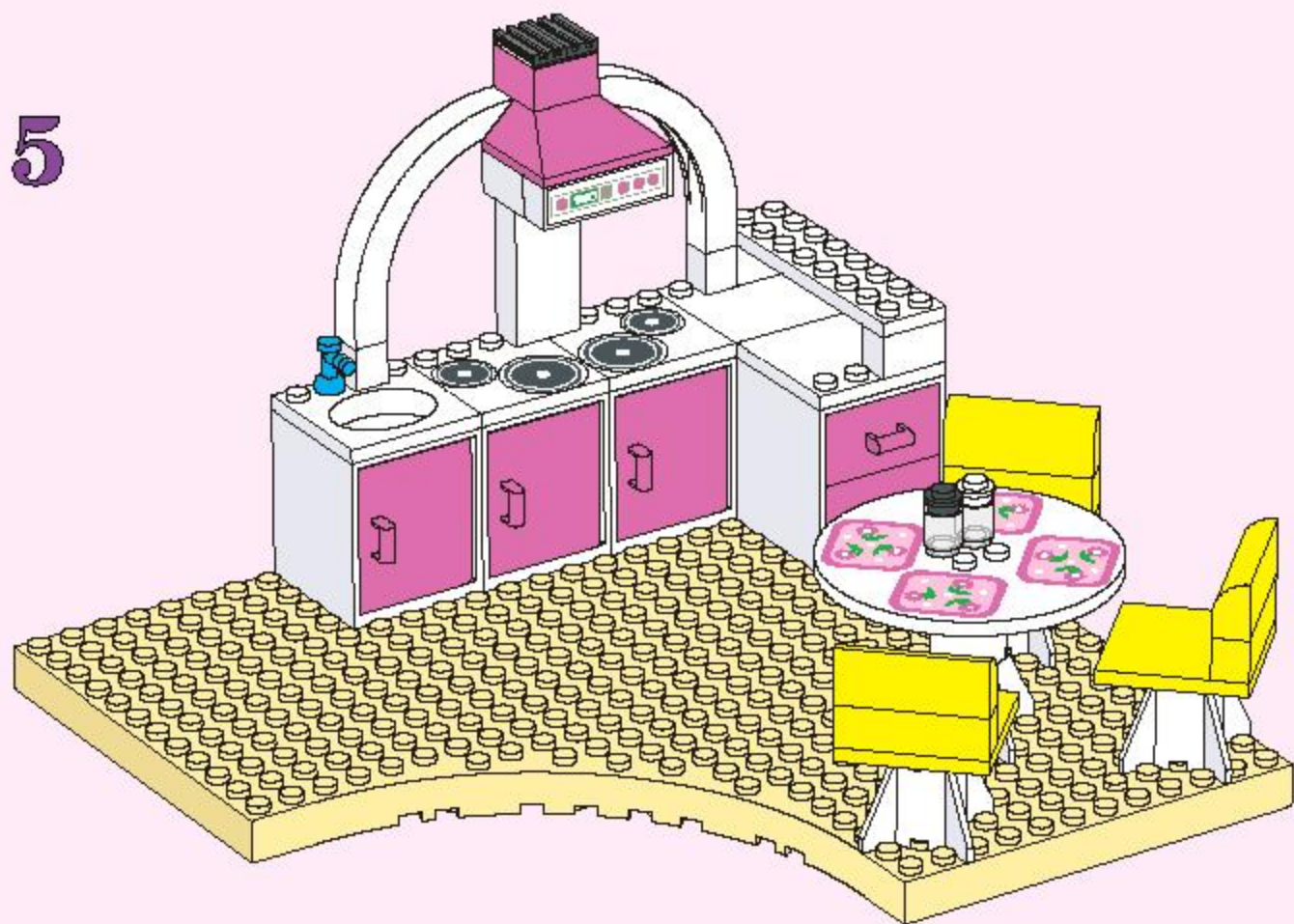

1

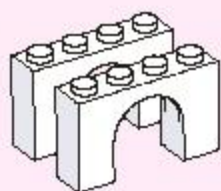

2

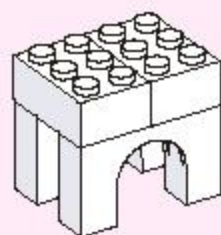

3

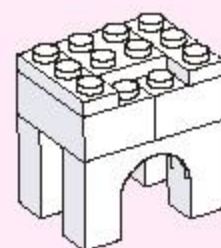

4

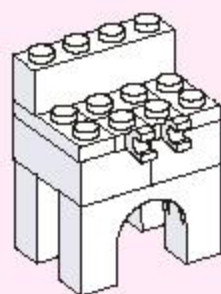

5

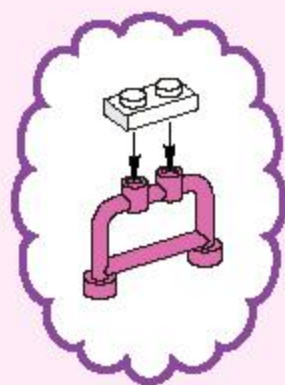
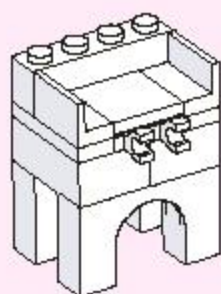

6

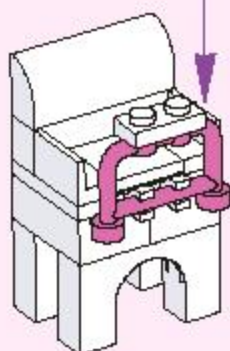

6

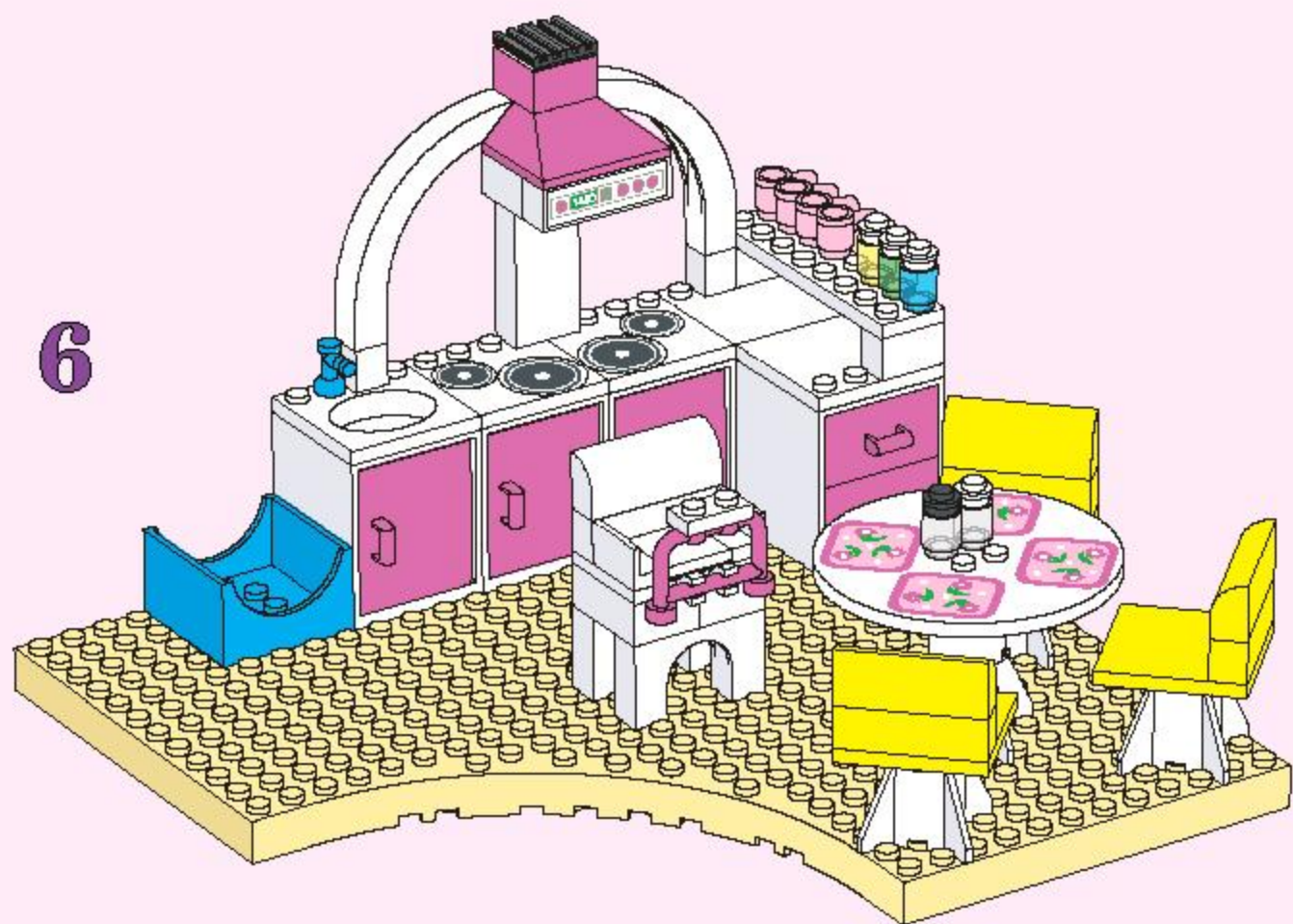

1



3

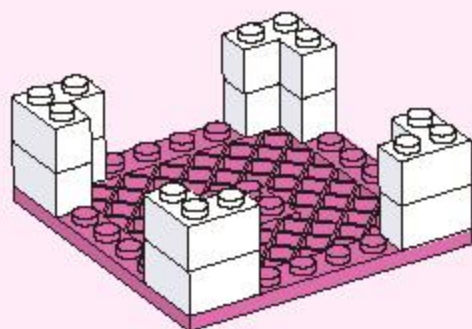

2

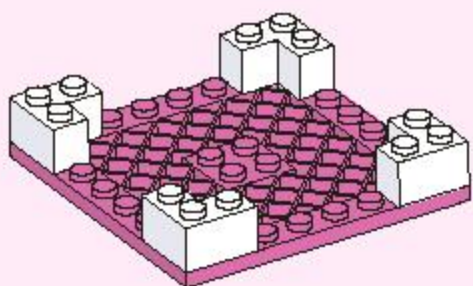

4

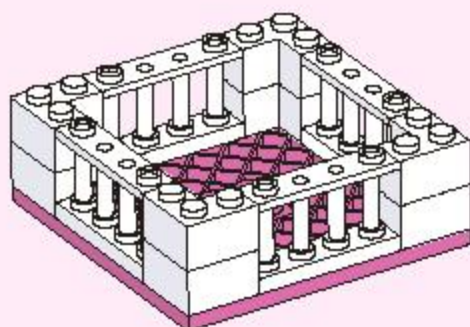

7

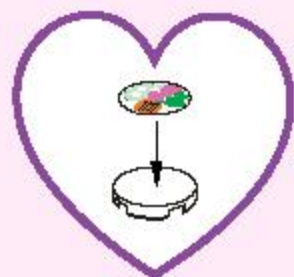

1

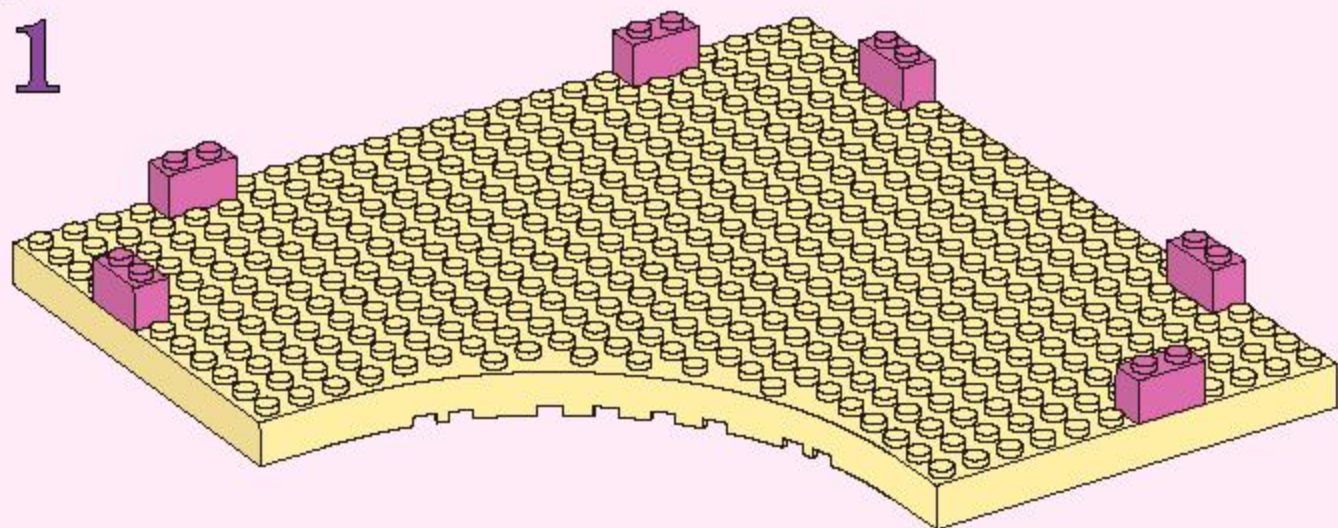

2

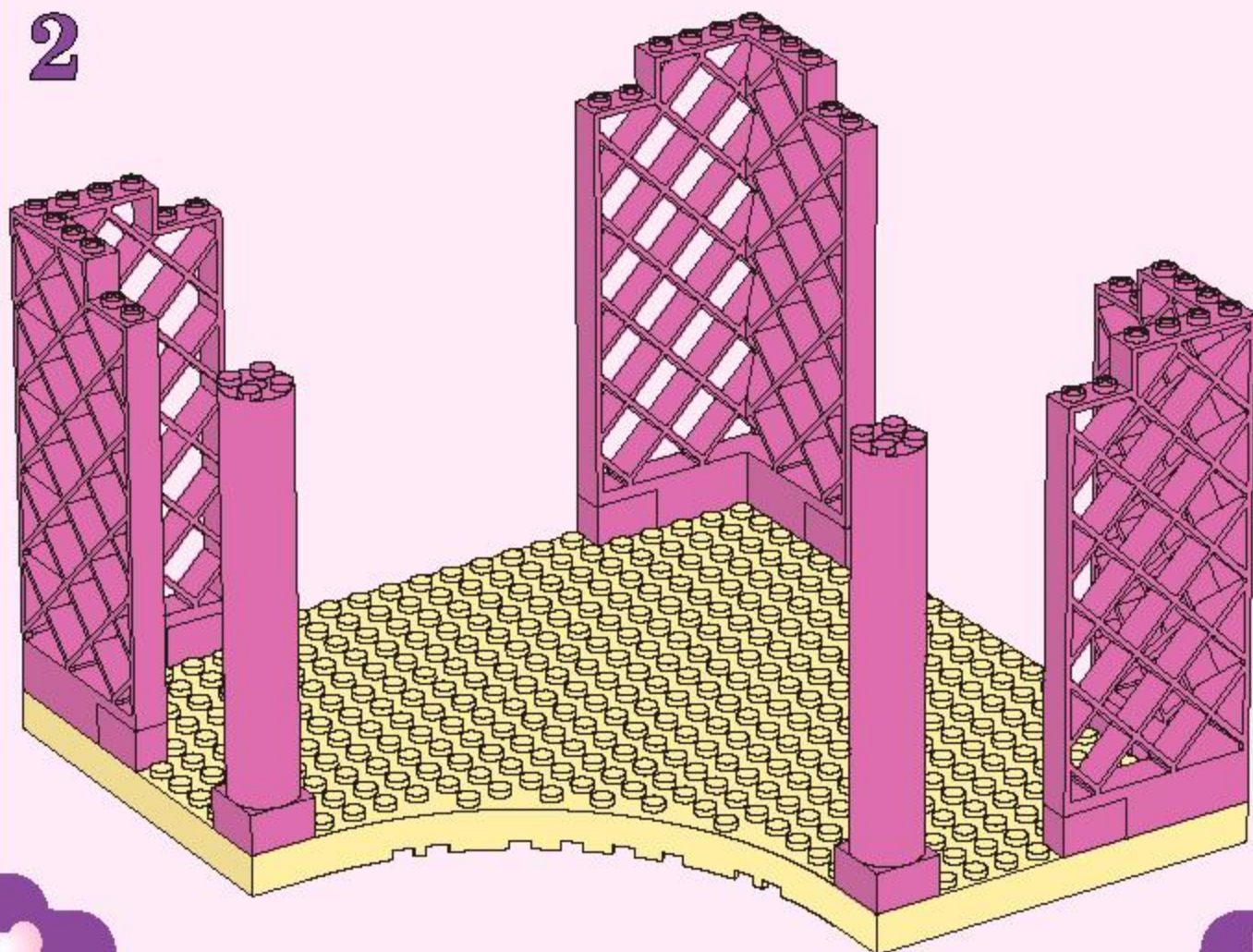

3

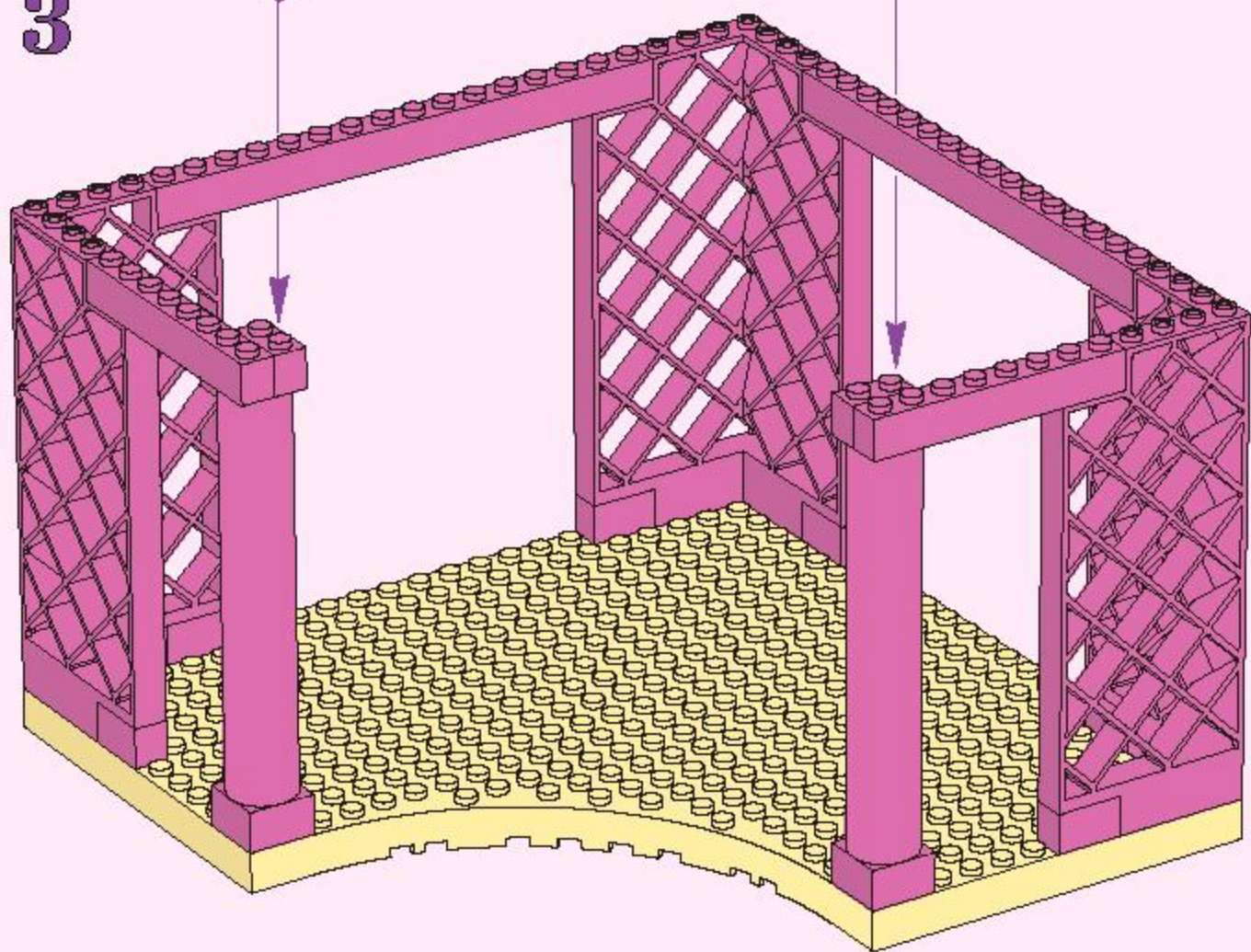

1

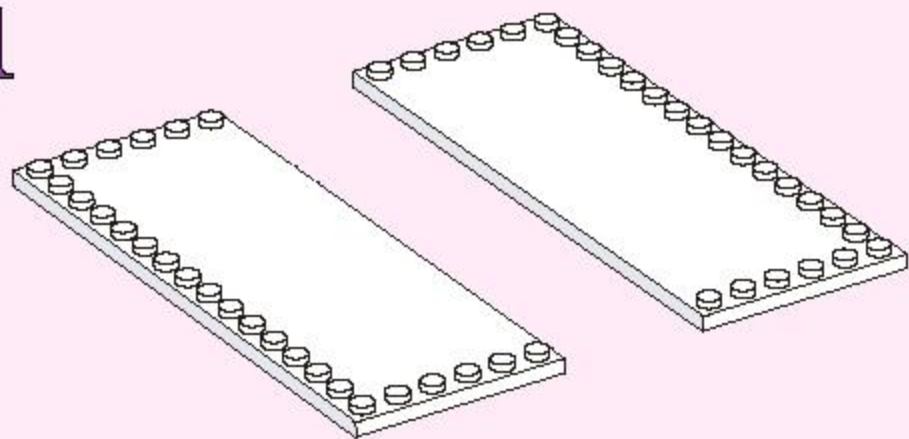

2

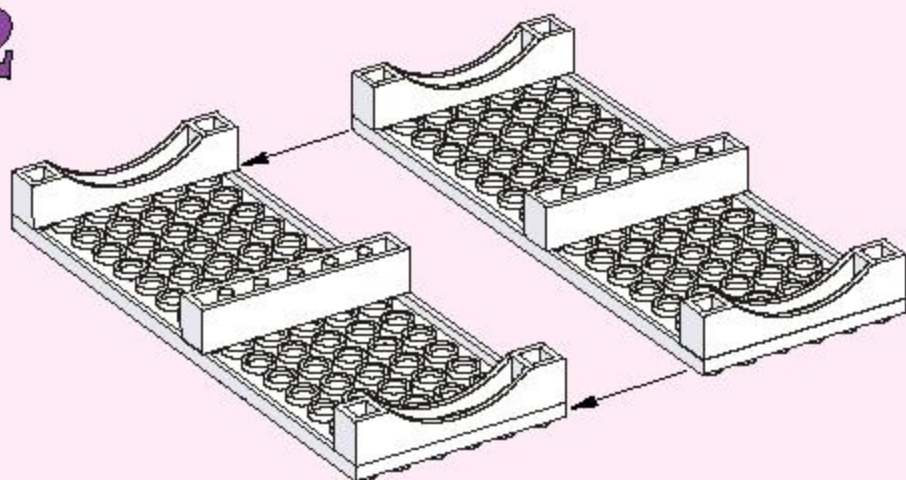

3

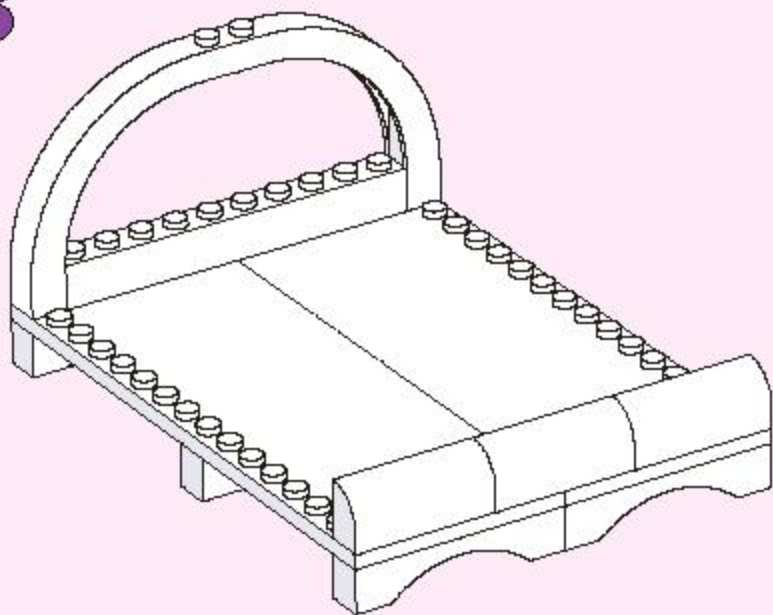

4

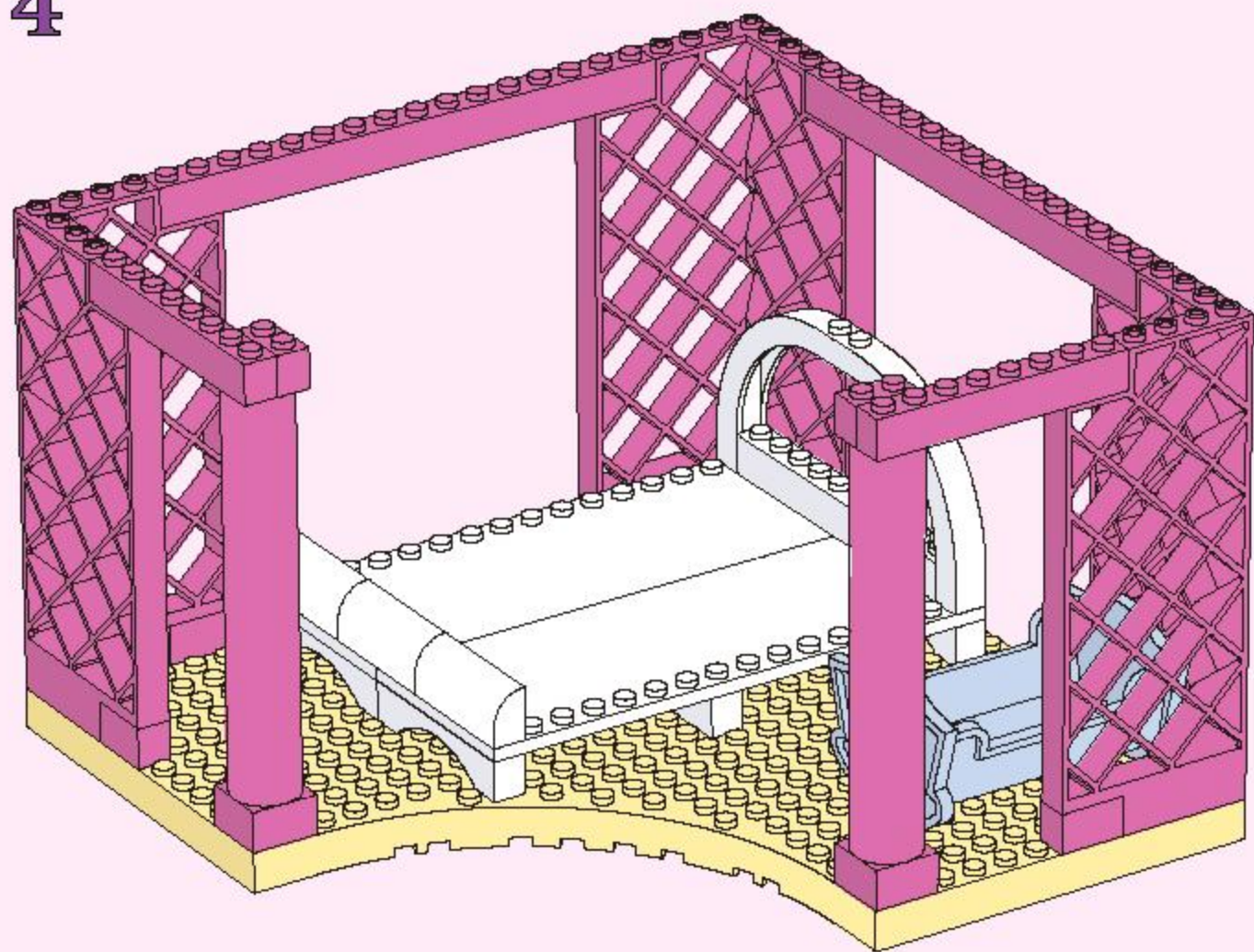

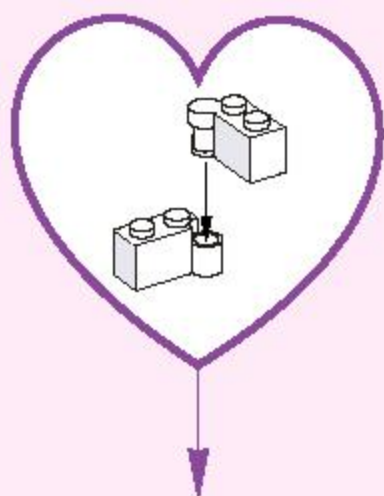

5

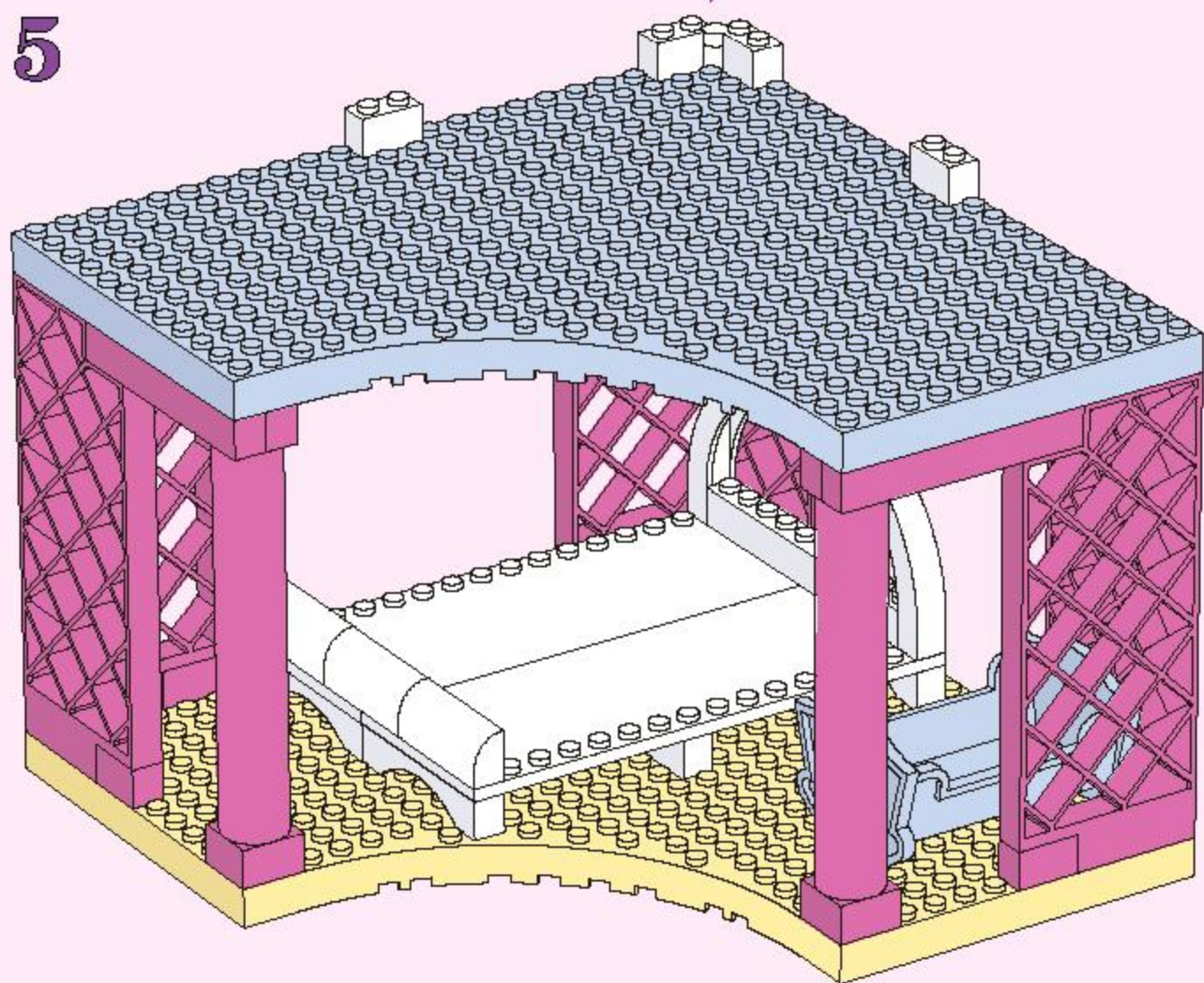

1

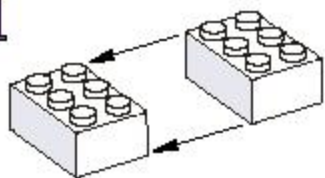

2

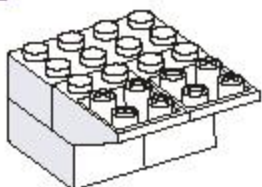

3

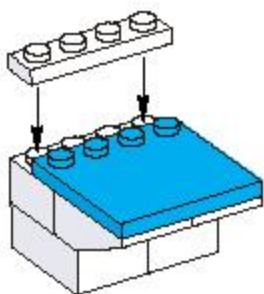

4

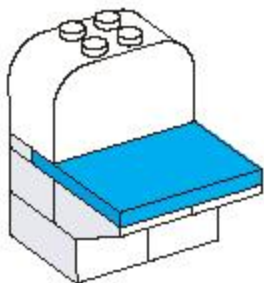

5

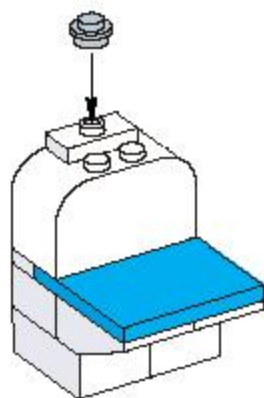

6

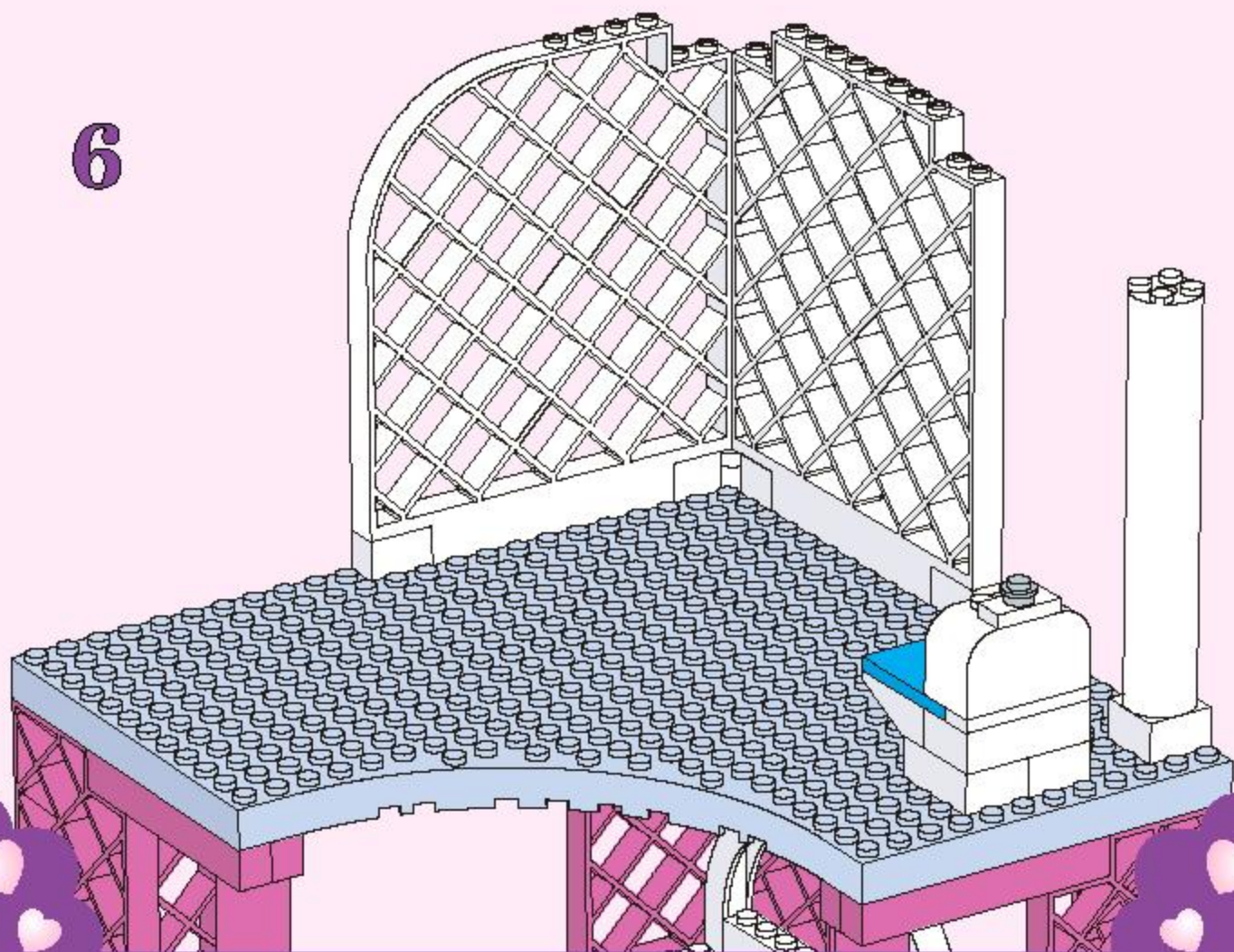

1

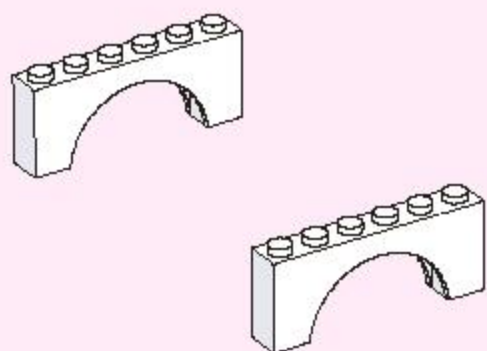

2

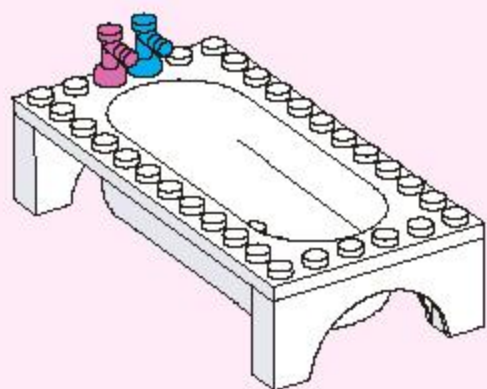

3

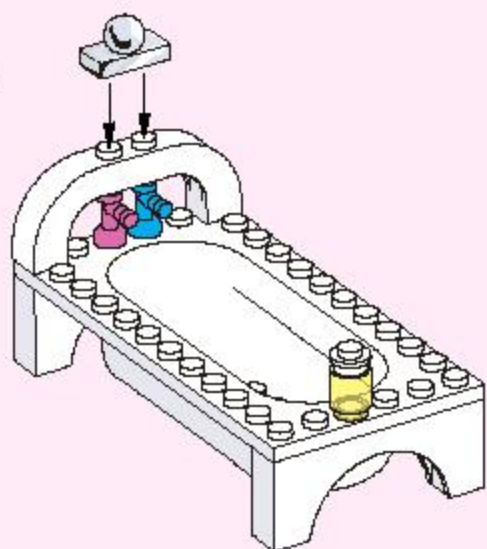

1

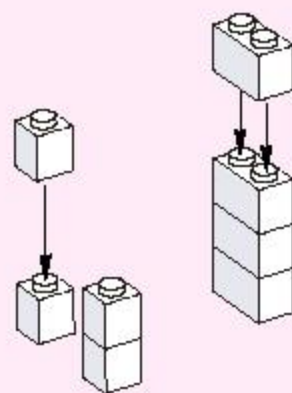

2

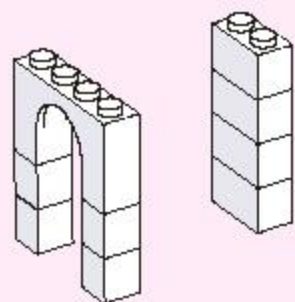

3

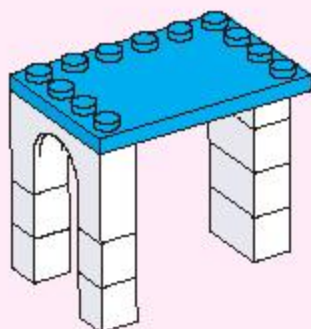

4

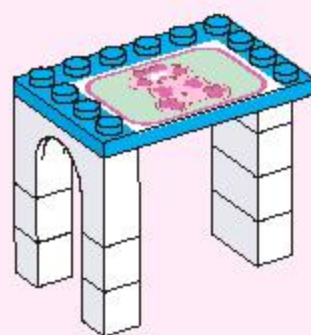

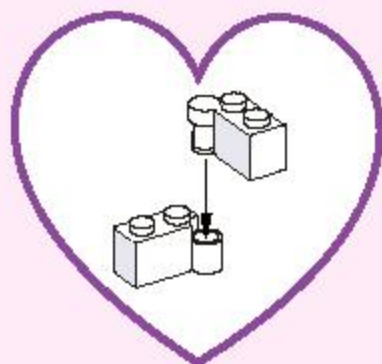

7

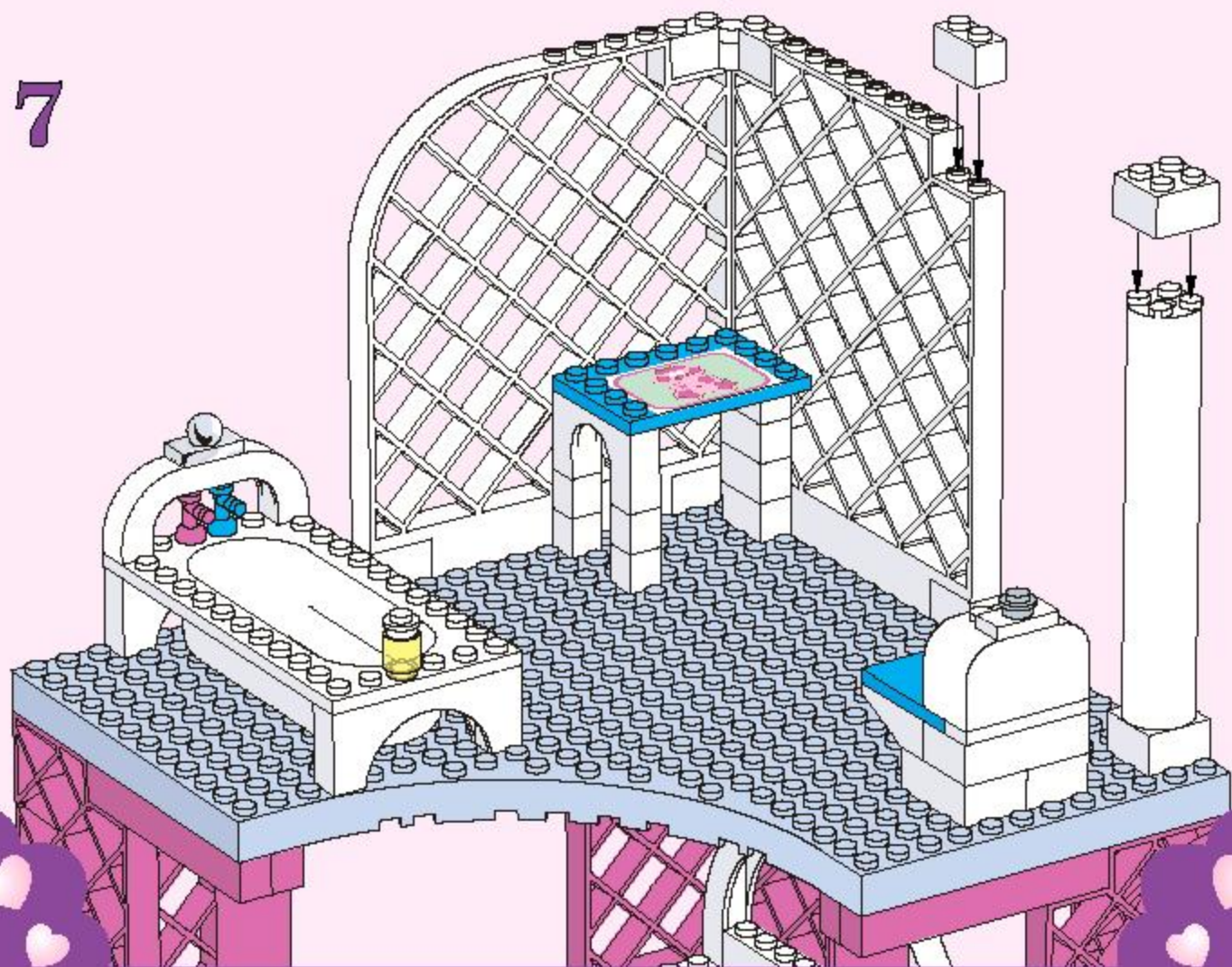

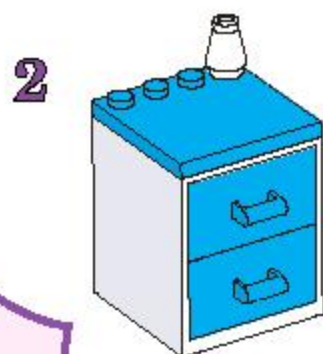
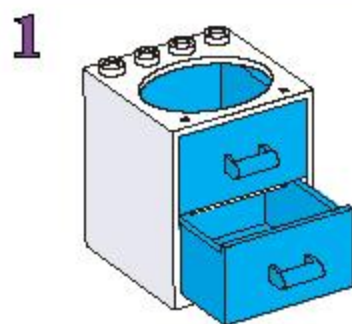
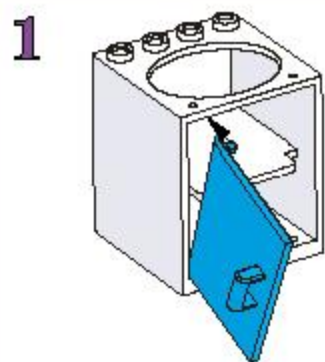

8



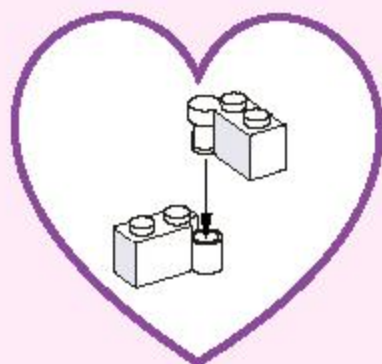

7

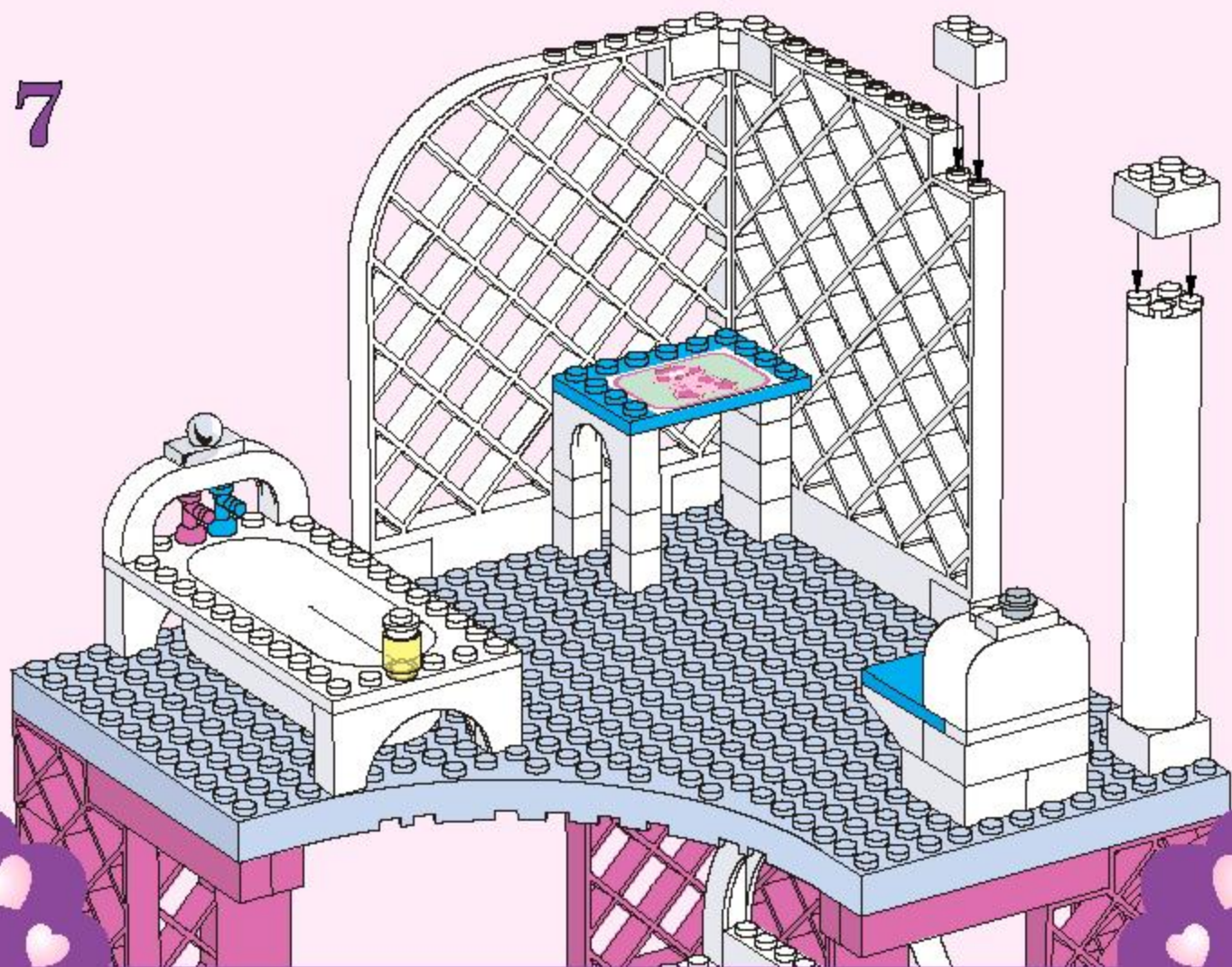

1

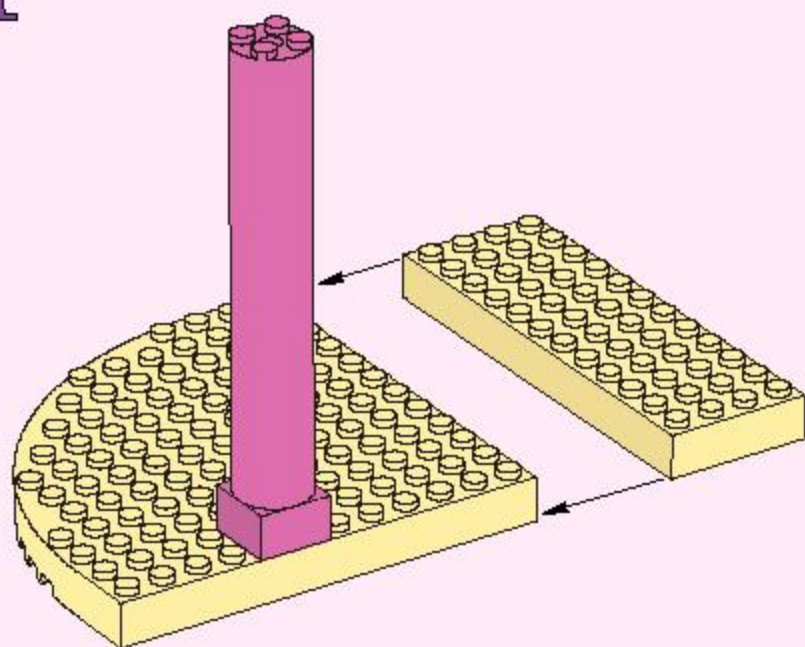

2

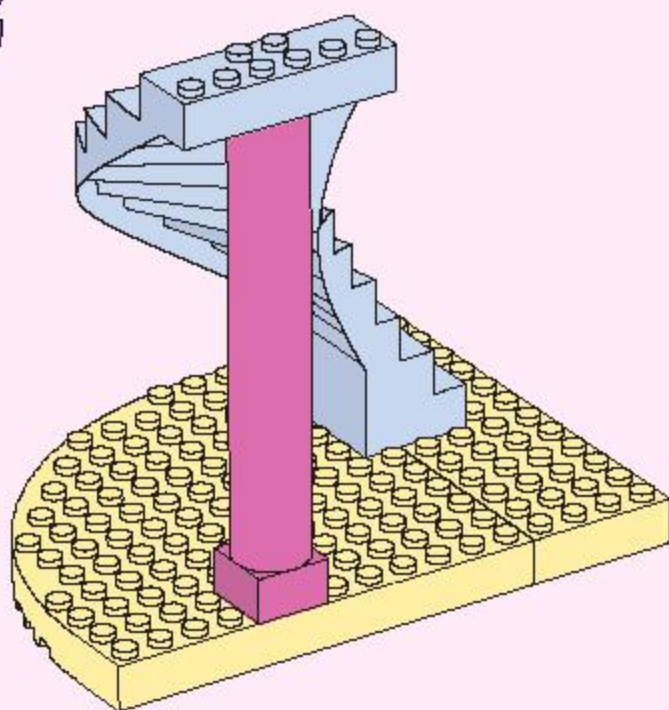

1

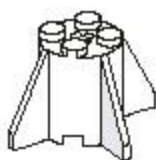

2

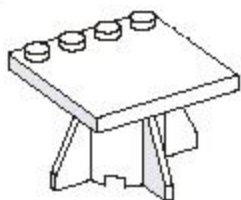

3

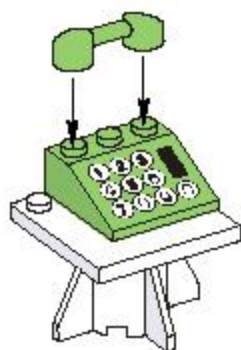

3

