



MARVEL

76244





 **FR**
DONNEZ
OU
RECYCLEZ

 OU  OU 

ASSOCIATION MAGASIN DÉCHÈTERIE

Adresses sur quefairedemesdechets.fr



LEGO.com/sustainable-packaging



BUILDER



Apple and the Apple logo are trademarks of Apple Inc., registered in the U.S. and other countries and regions. App Store is a service mark of Apple Inc. Google Play and the Google Play logo are trademarks of Google LLC. Tencent and the Tencent logo are trademarks of Tencent Inc.

Q [LEGO.com/devicecheck](https://www.lego.com/devicecheck)

EN Ask parents' permission before going online | **DE** Eltern um Erlaubnis bitten, bevor du online gehst | **FR** Demande l'autorisation d'un parent avant d'aller en ligne | **IT** Chiedi il permesso ai tuoi genitori prima di andare online | **ES** Pídeles permiso a tus papás antes de conectarte a Internet | **PT** Pede autorização aos pais antes de acederes online | **JA** オンラインになる前にほご者の方のきよかをもらおう | **ZH** 上网前应先征得父母的同意 | **KO** 온라인 접속 전에 보호자 동의가 필요합니다 | **RU** Спроси разрешения у родителей, прежде чем заходить в интернет | **PL** Poproś rodziców o zgodę, zanim wejdziesz do Internetu | **CS** Než půjdeš na internet, požádej rodiče o svolení | **SK** Skôr než pôjdeš na internet, vypýtaj si povolenie od rodičov | **HU** Kérj szülői engedélyt, mielőtt online csatlakoznál! | **RO** Cere permisiunea părinților înainte de a te conecta online | **BG** Поискайте разрешение от родител, преди да влезете онлайн | **LV** Pirms došanās tiešsaistē palūdz atļauju vecākiem | **ET** Enne Interneti kasutamist küsi vanematelt luba | **LT** Prieš prisijungdami prie interneto, atsklauskite tėvų

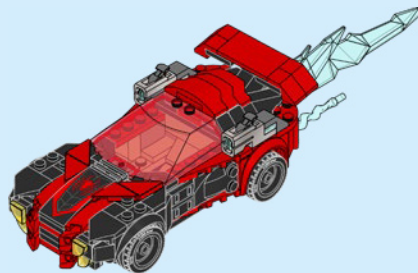
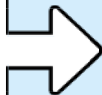
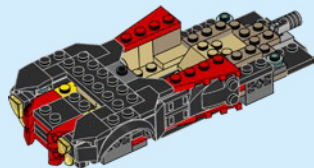
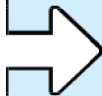

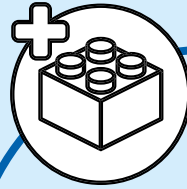

1x



1x

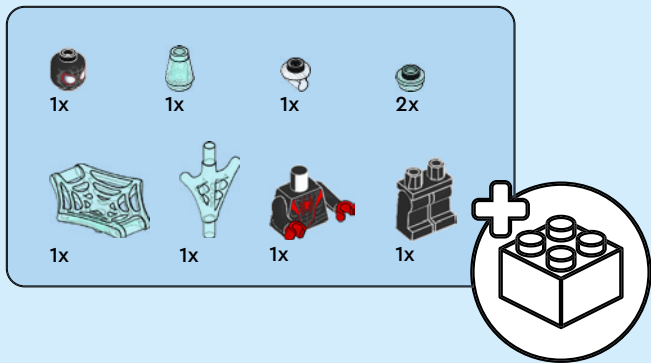

1

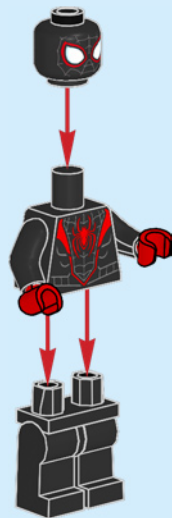

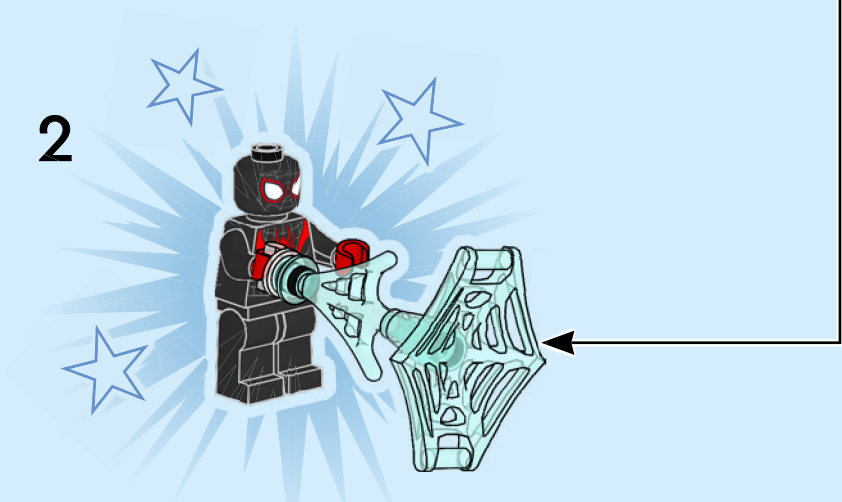
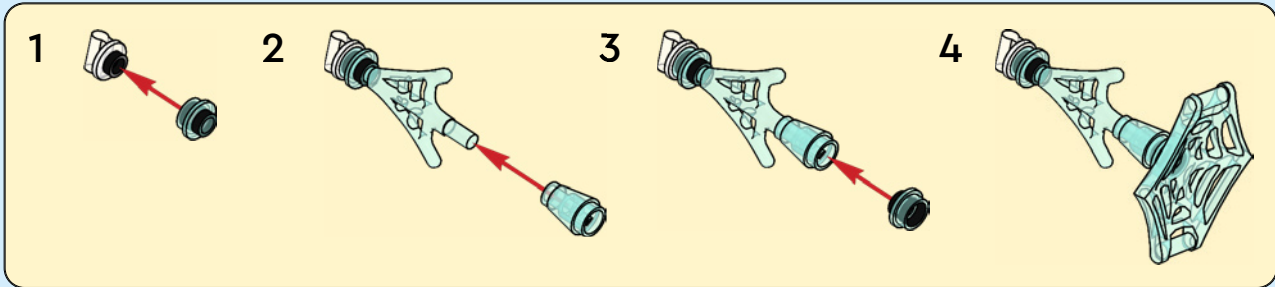

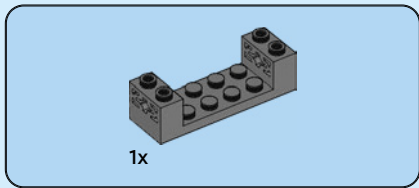
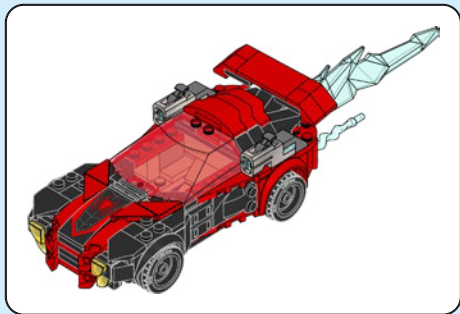

1x

1

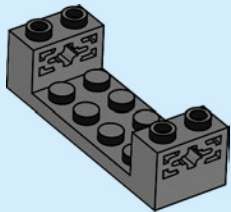

8

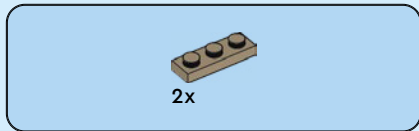

2x

2

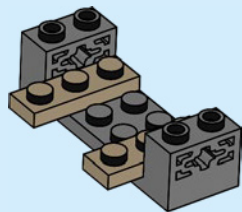

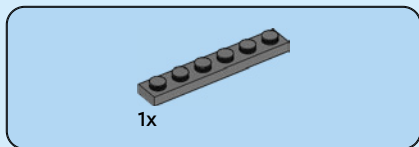

3

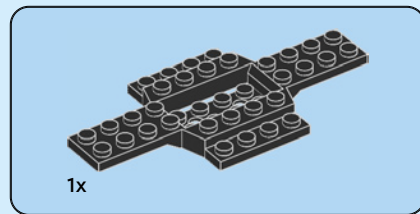
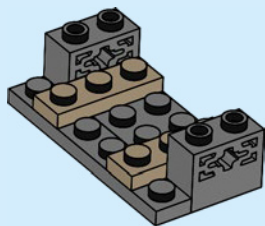

4

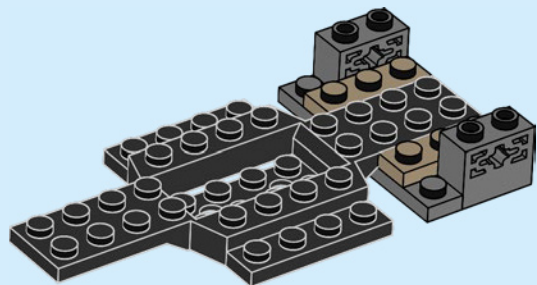



2x

5

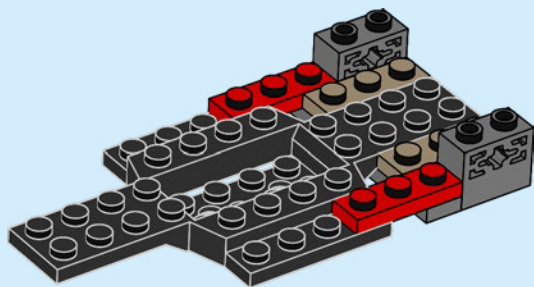



1x

6

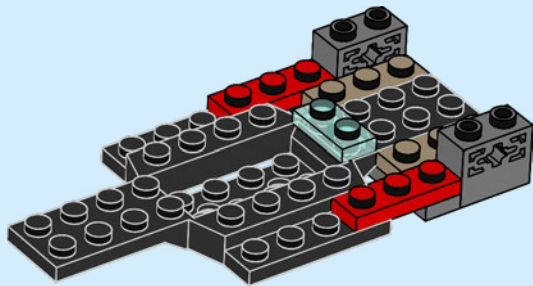

1x



1x

7

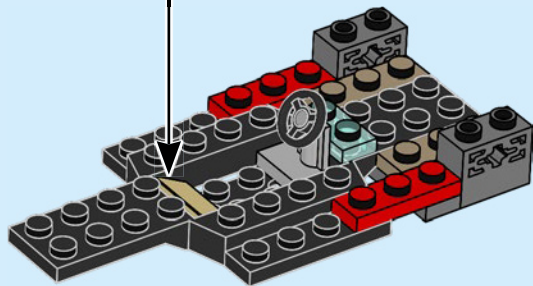

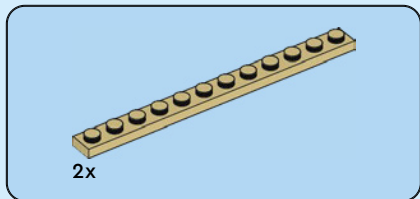

8

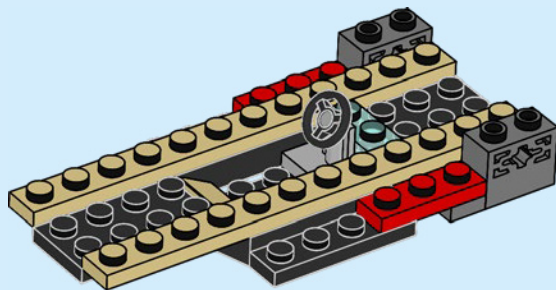



2x

9

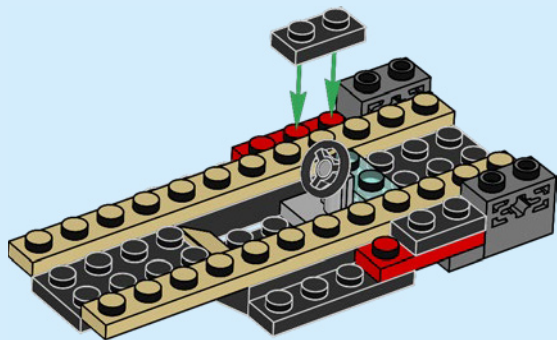

2x



1x

10

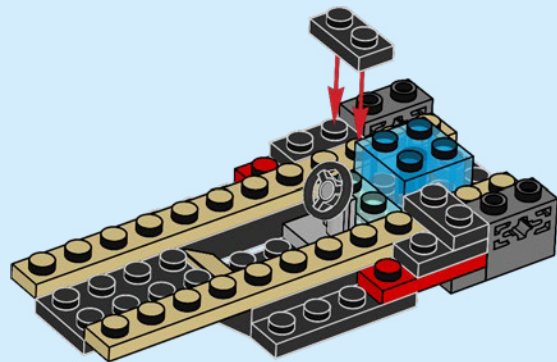



2x

11

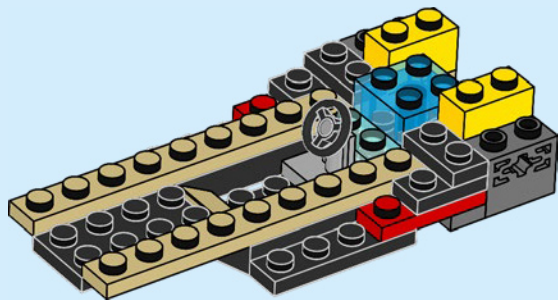



2x

12

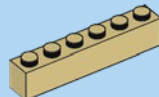
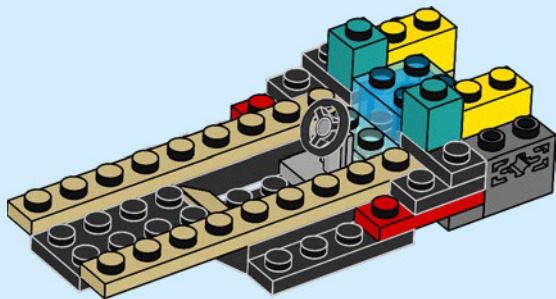

1x

13

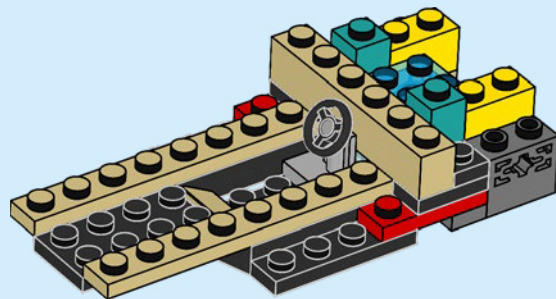

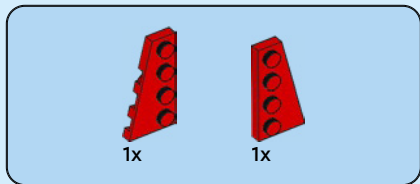

14

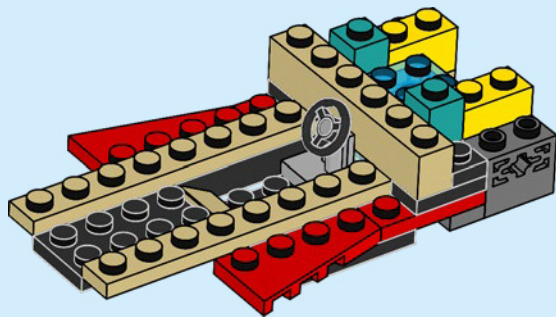

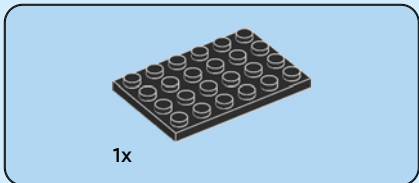

15

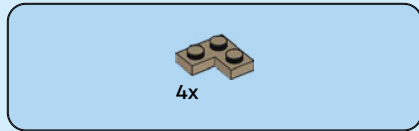
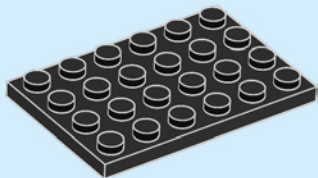

16

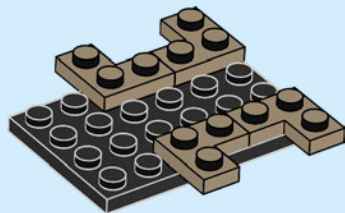



1x



2x

17

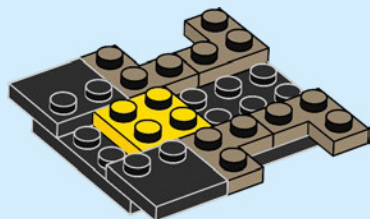

1x

18

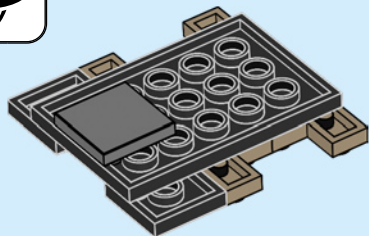
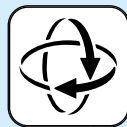

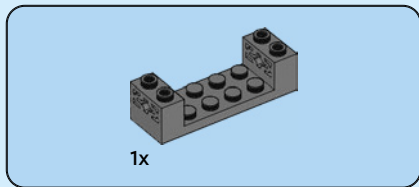

19

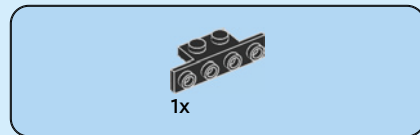
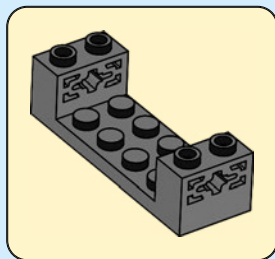
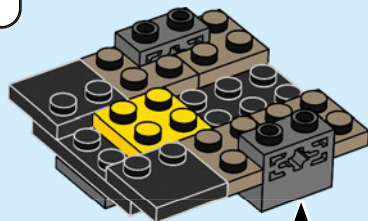
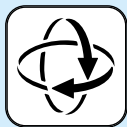

20

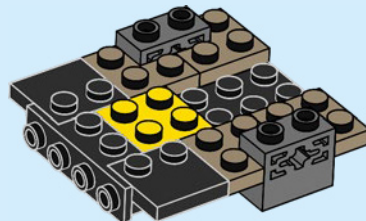

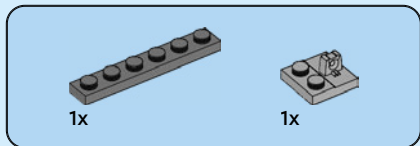

21

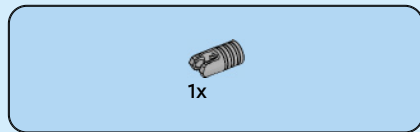
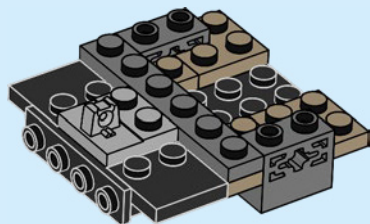

22

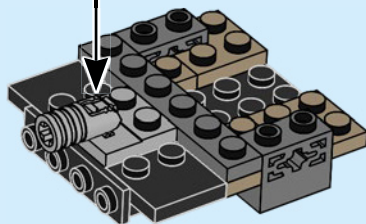

23

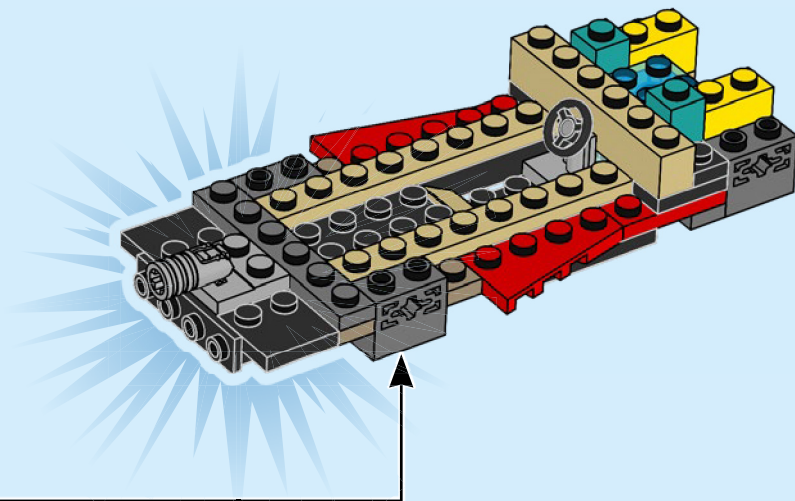



1x



1x

25

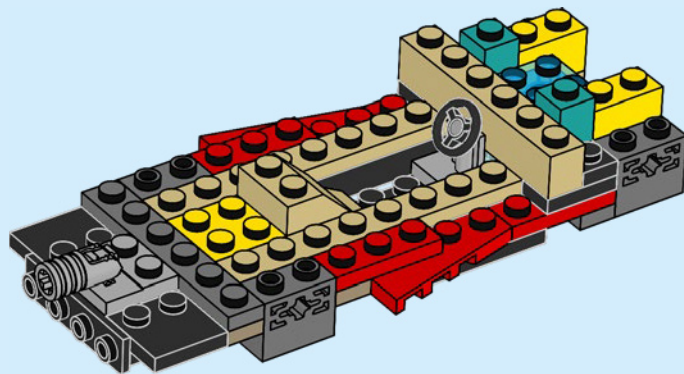



2x



1x



2x

26

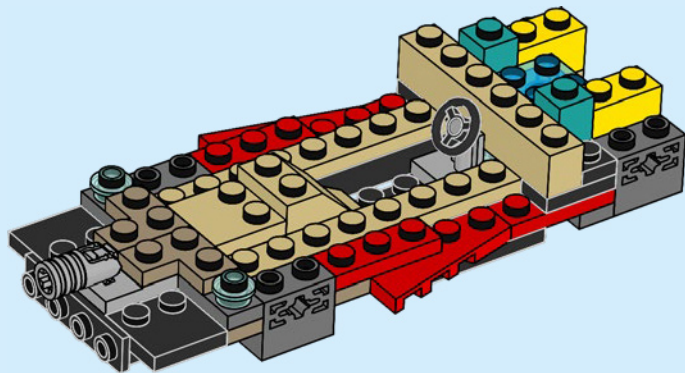

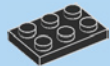

2x



2x

27

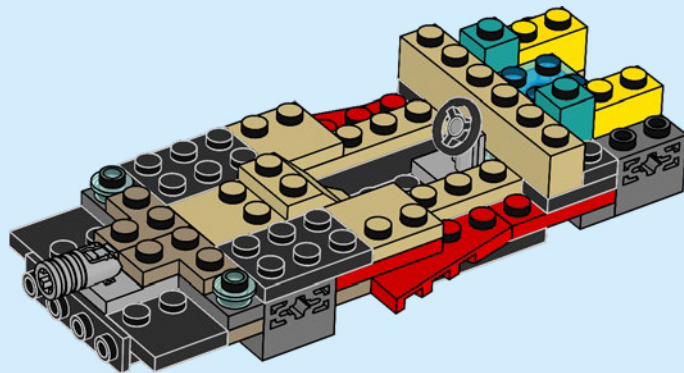



2x

28

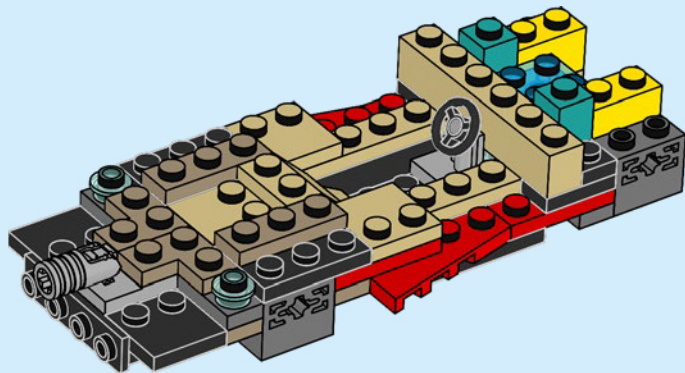



2x

29

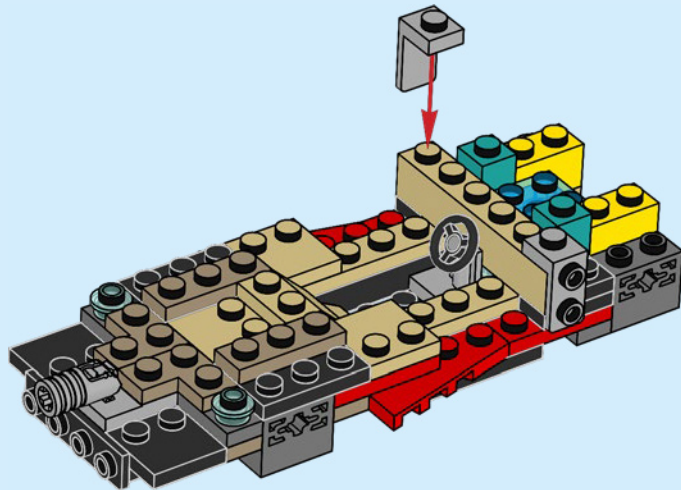



2x

30

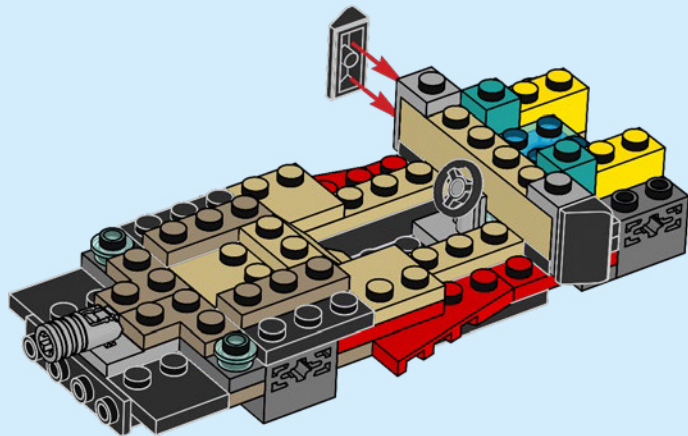



2x



2x

31



2x

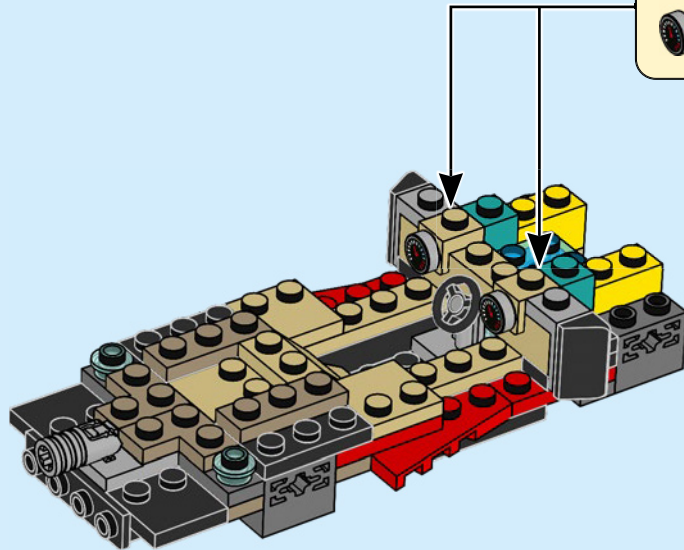

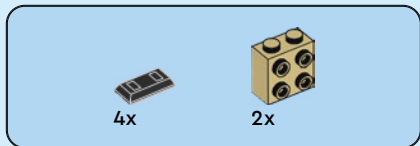

32

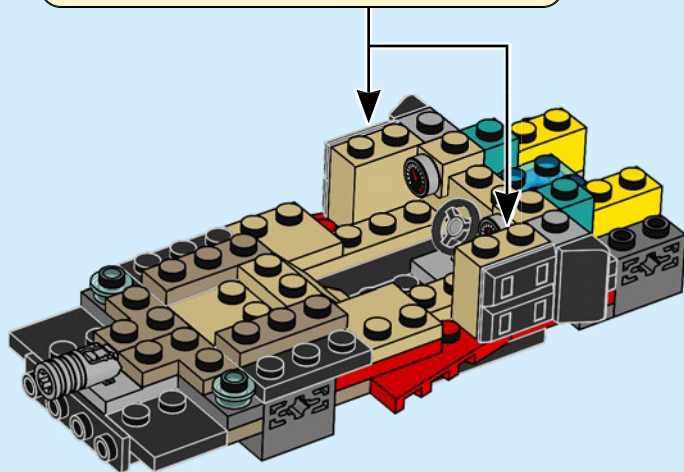
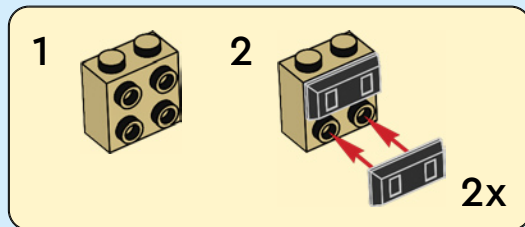



2x

33

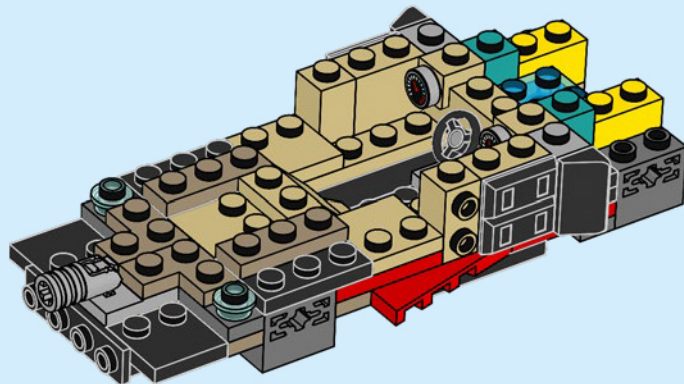



2x

34

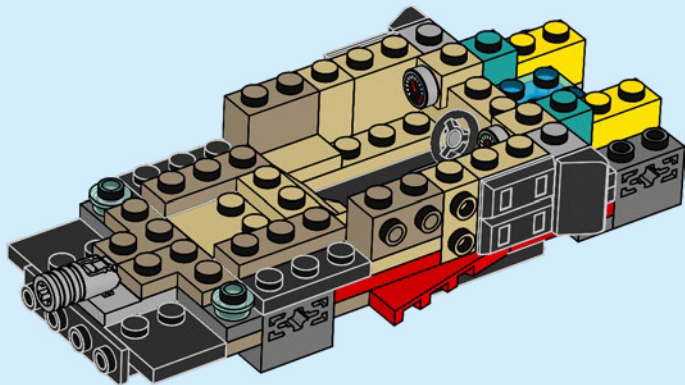



2x

35

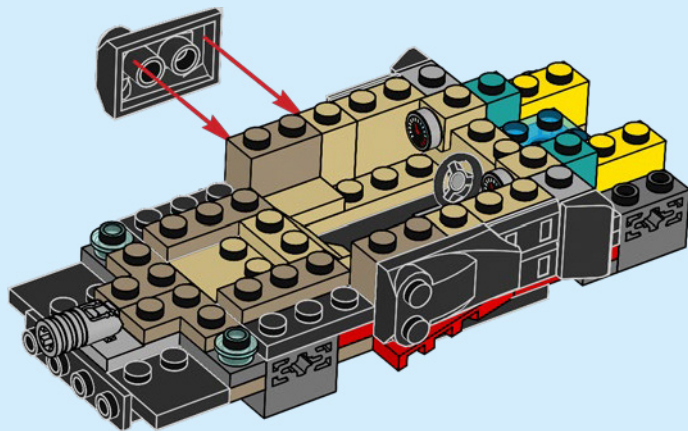

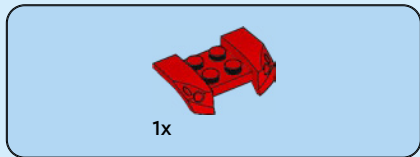

36

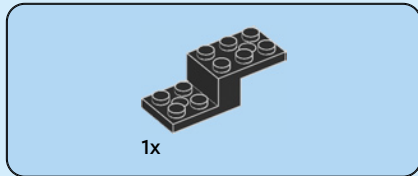
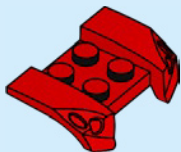

37

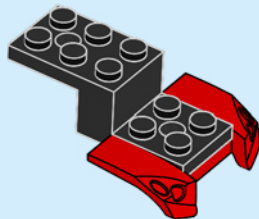

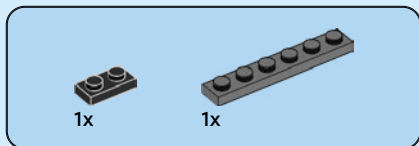

38

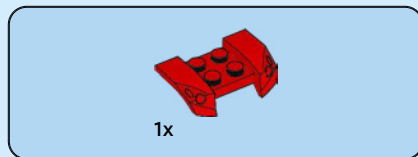
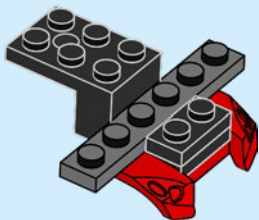

39

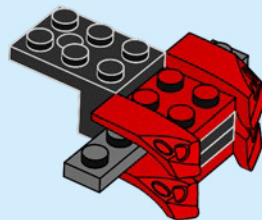



1x

40

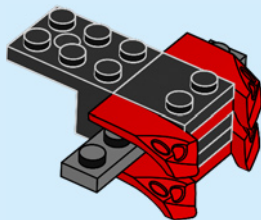

41

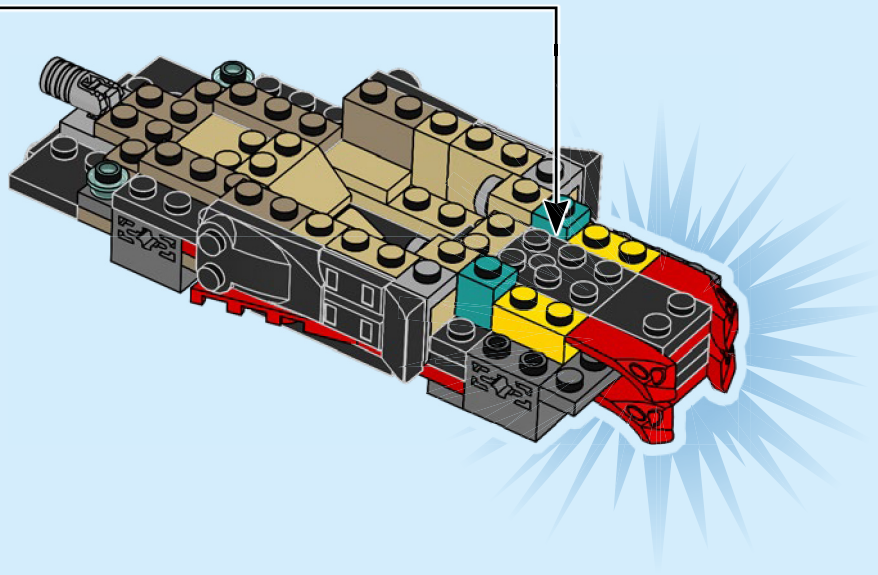



1x

42

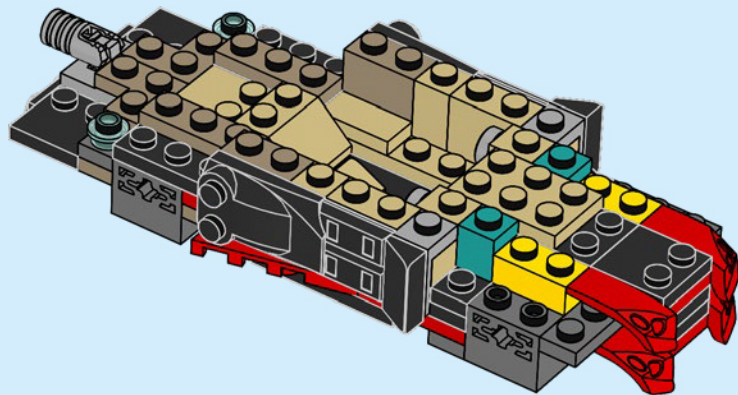



2x

43

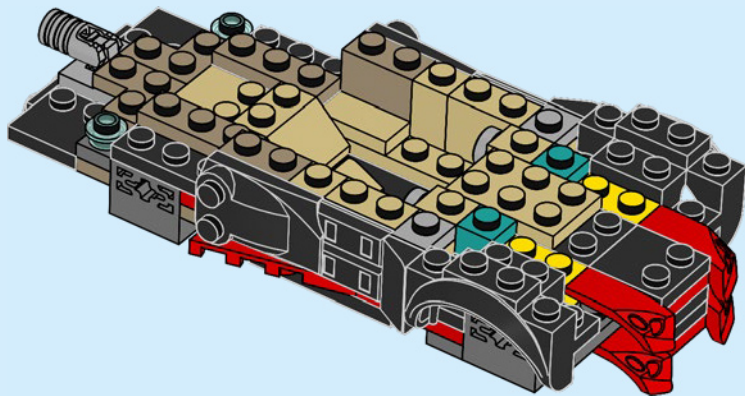

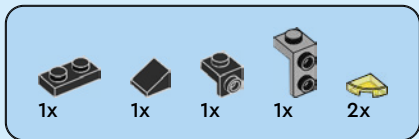

44

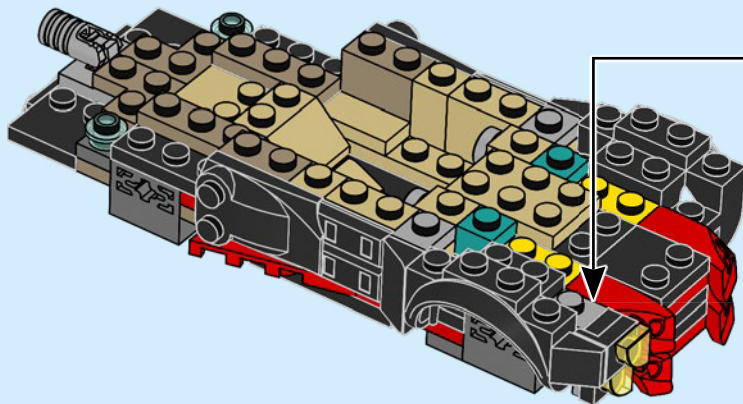
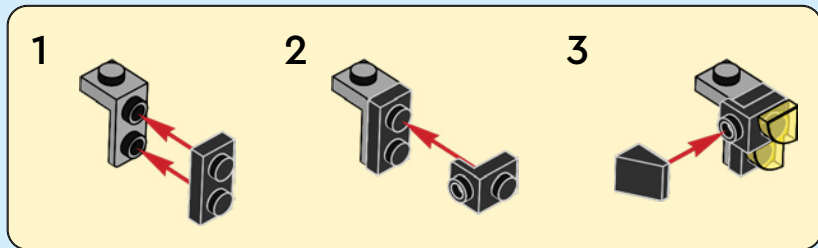

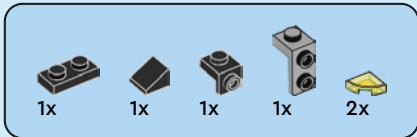

45

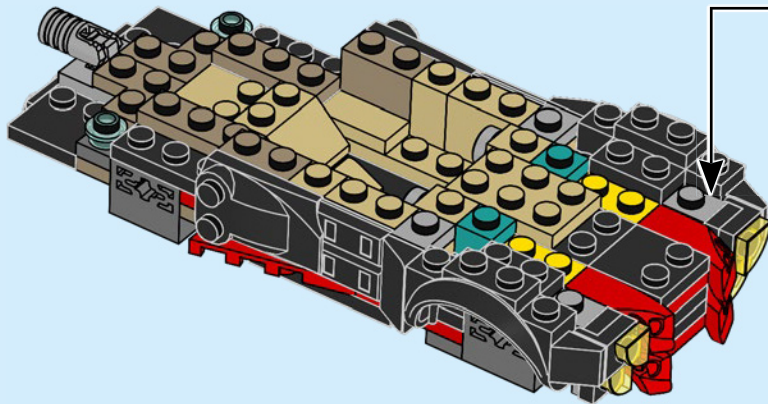
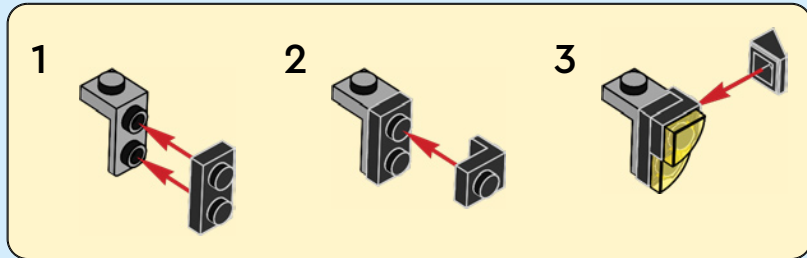



2x

46

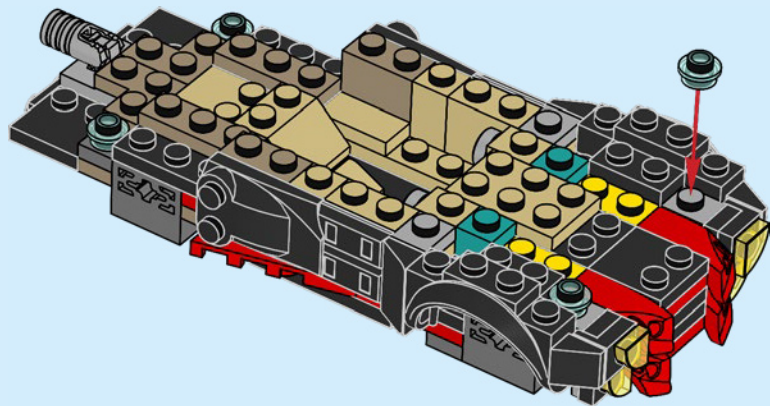

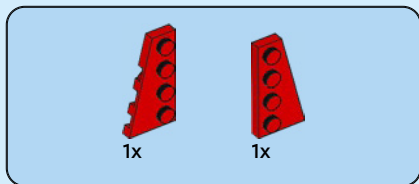

47

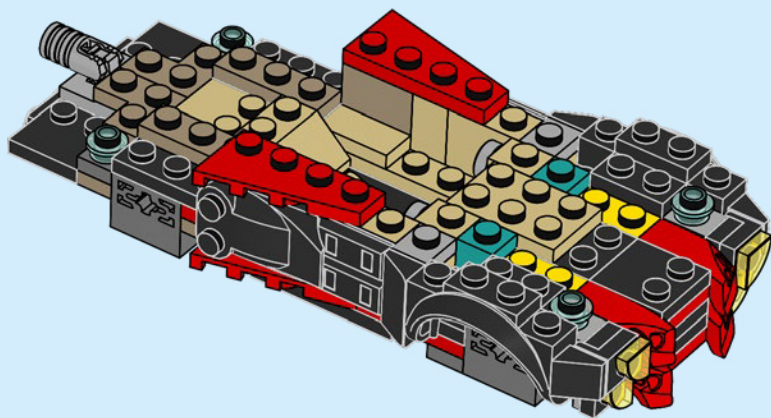



1x



2x

48

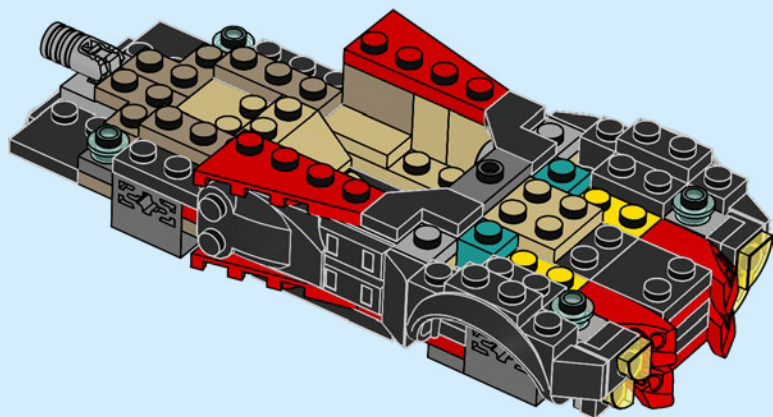

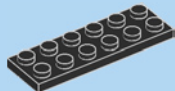

1x

49

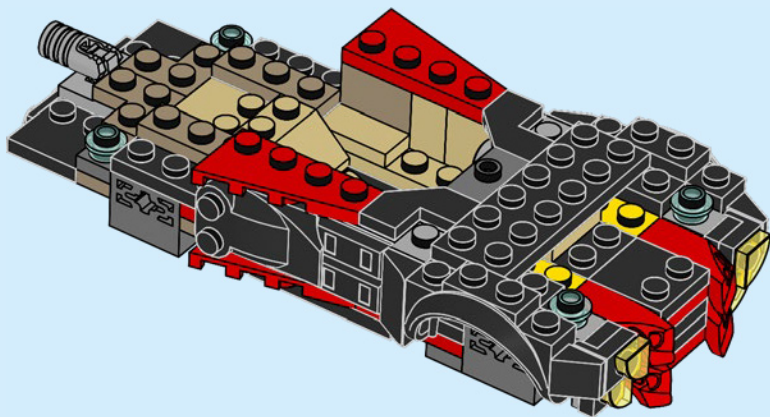



2x

50

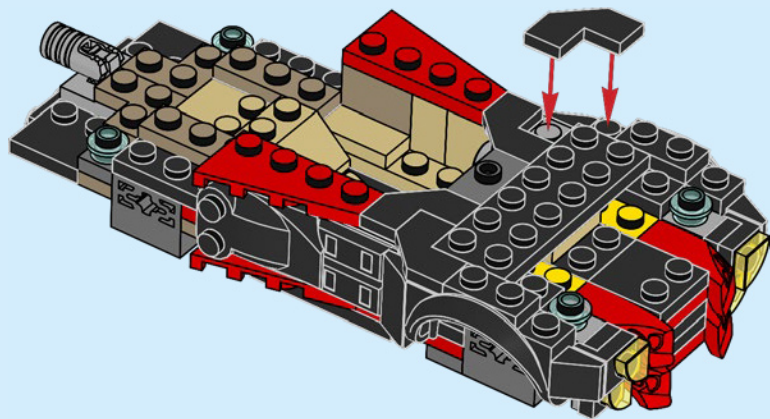



2x



2x

51

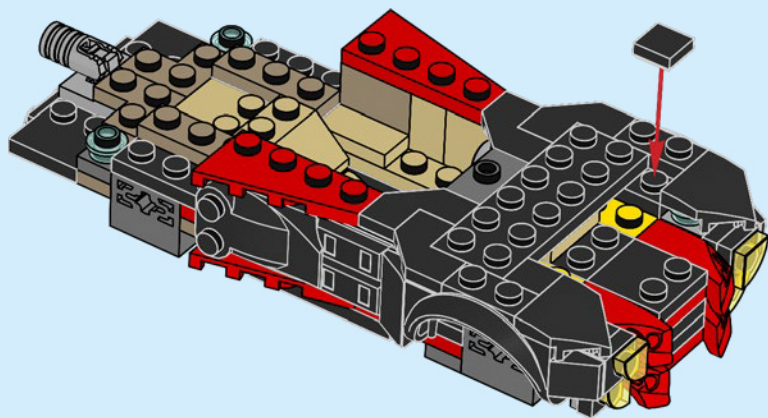

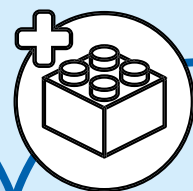
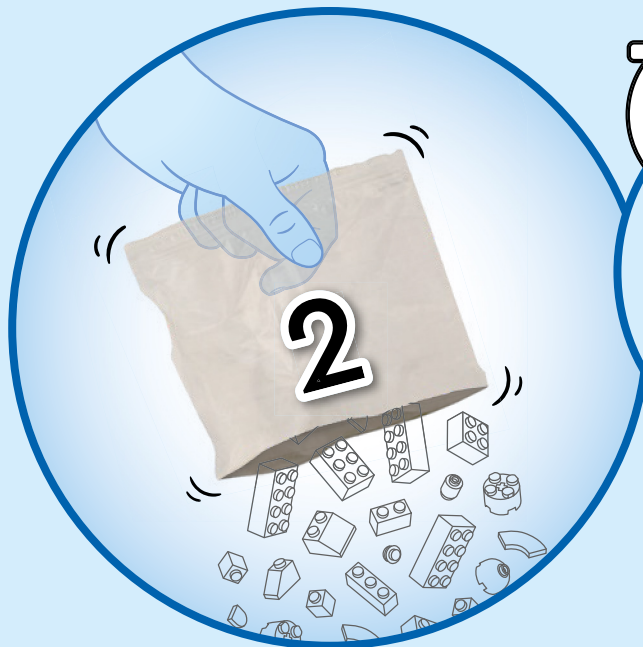

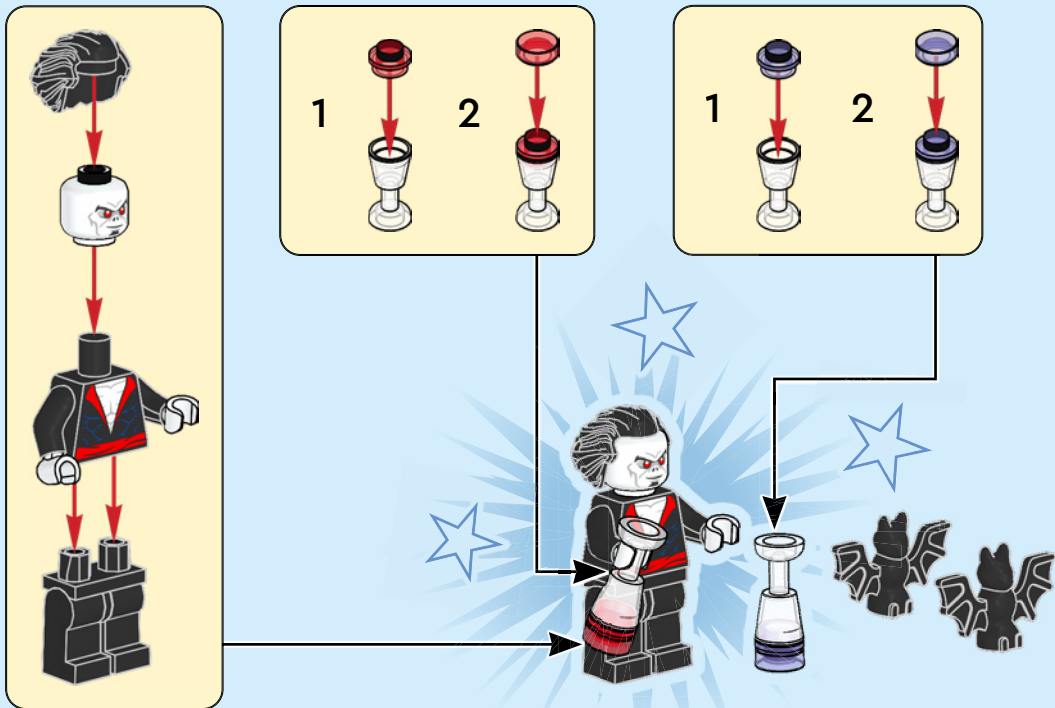

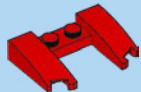

1x

52

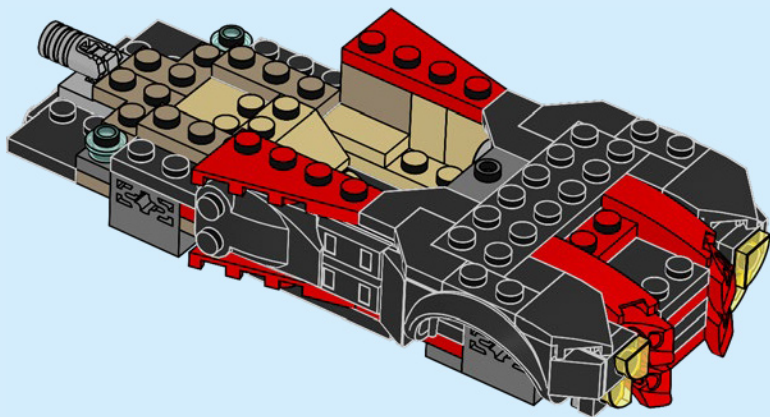



2x



1x

53

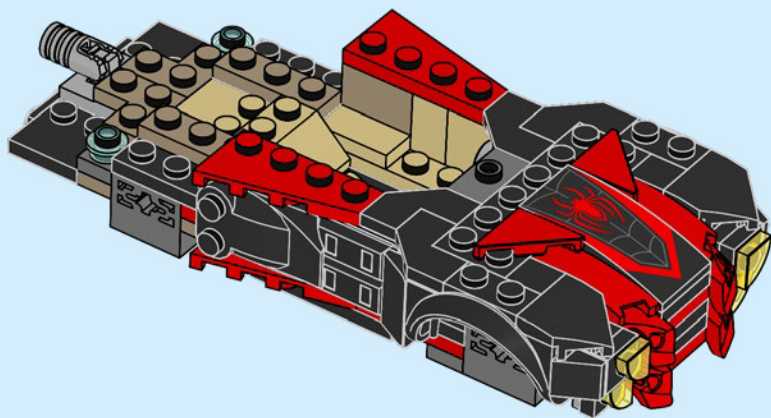



1x



2x

54

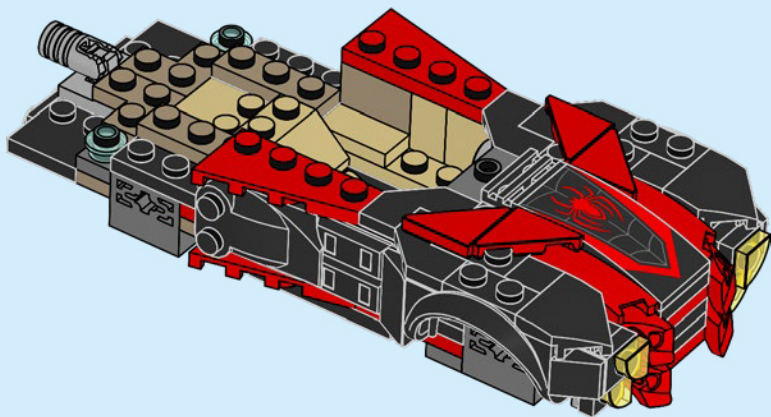



2x

55

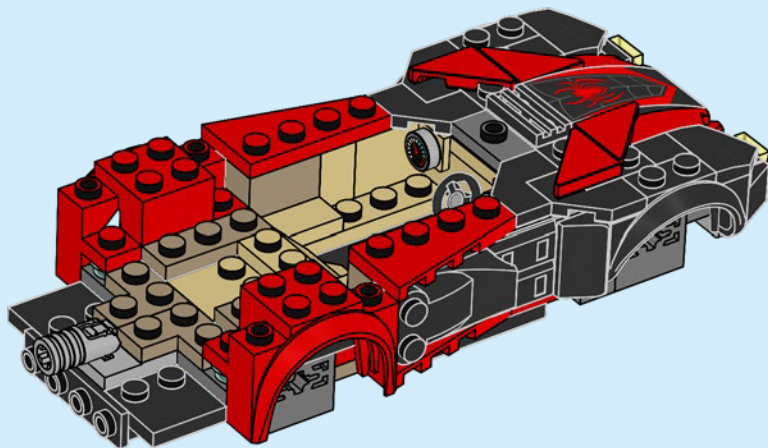

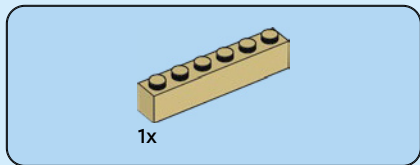

56

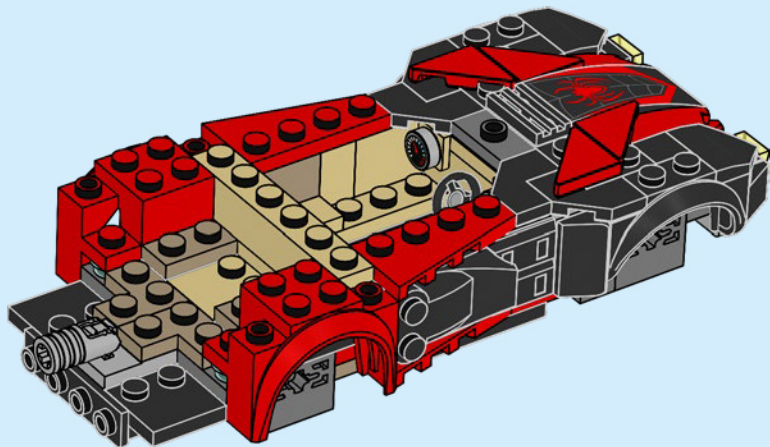



2x

57

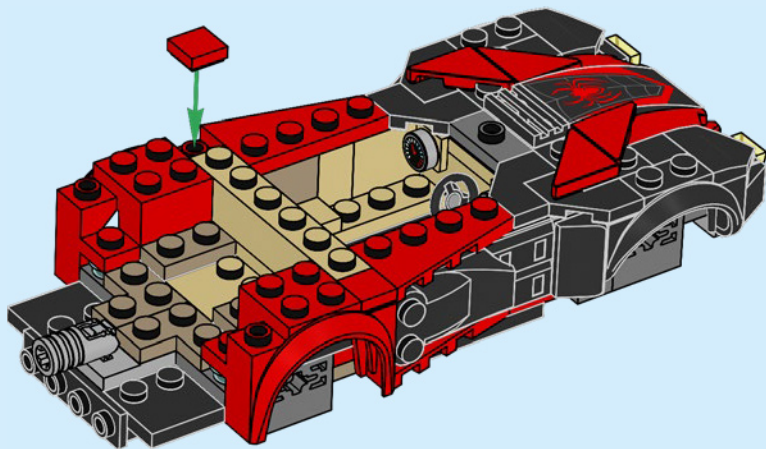



2x

58

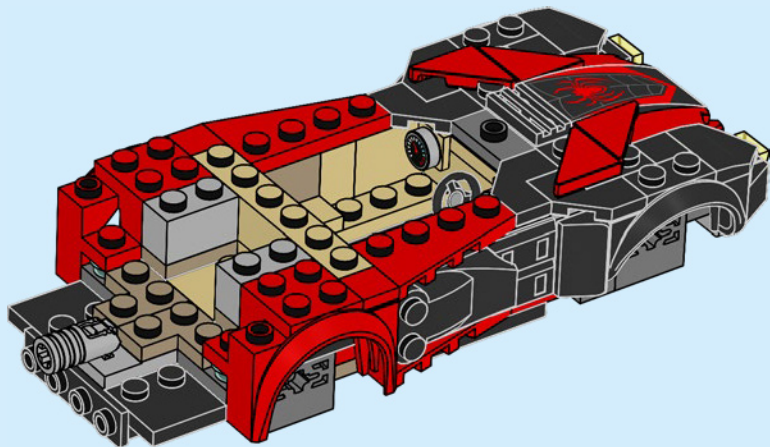

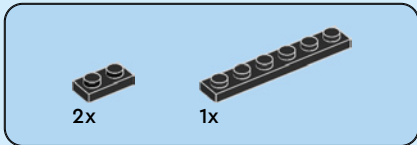

59

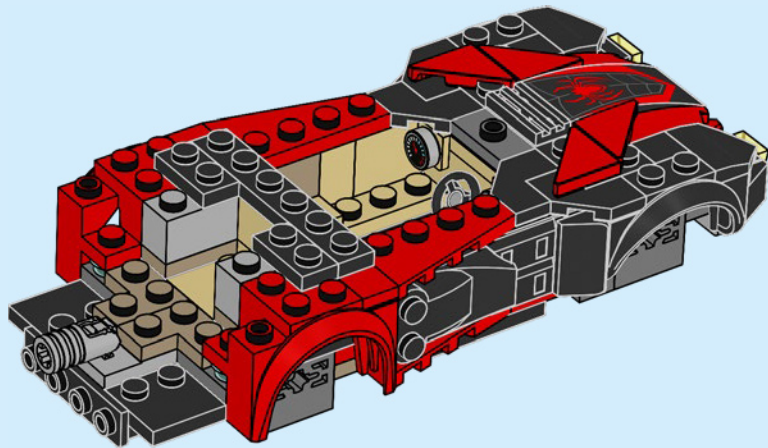



4x

60

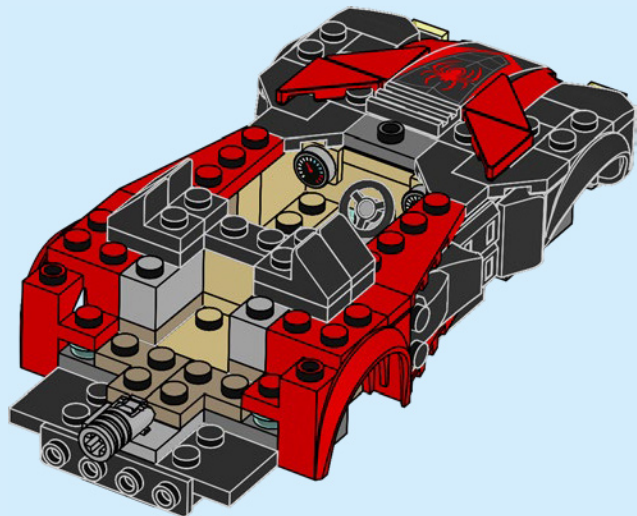

2x



1x

61

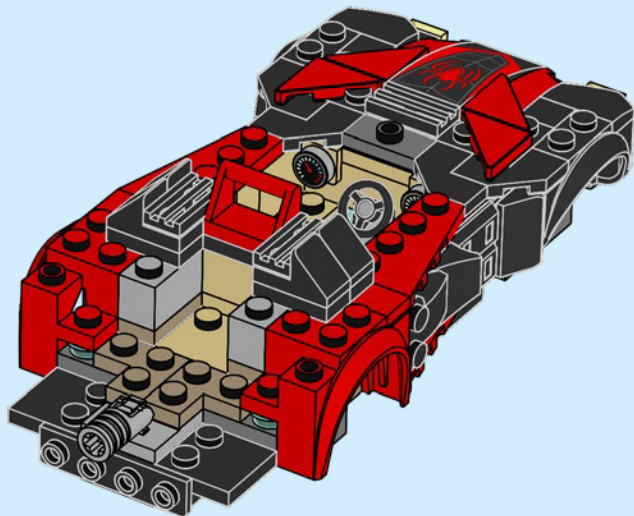



1x



2x



1x

62

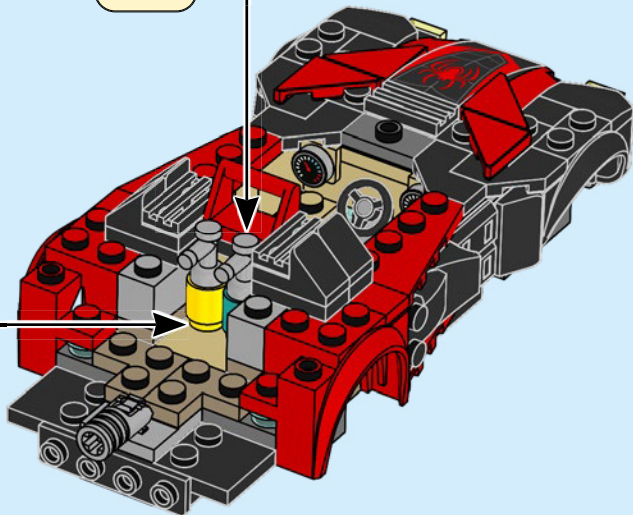
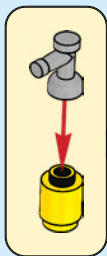
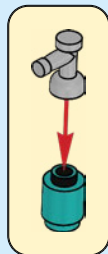

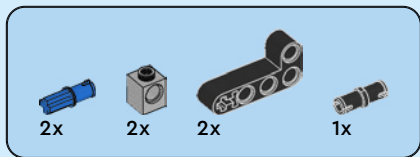

63

1

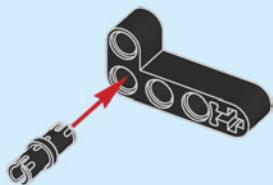

2

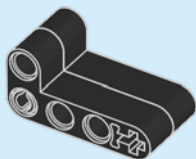

3

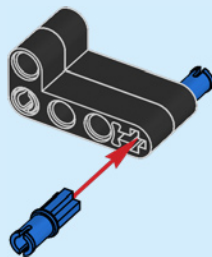

4

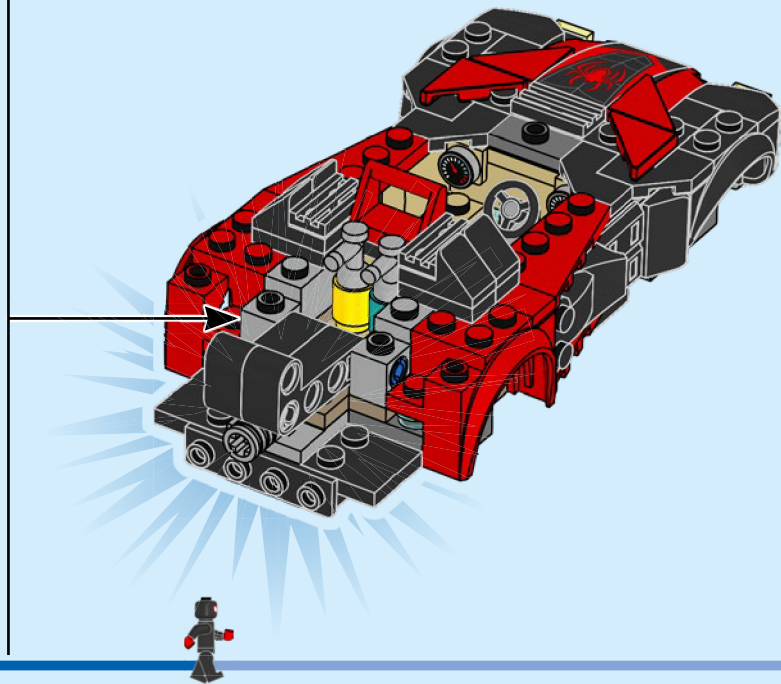
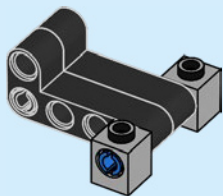



2x

64

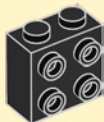

2x

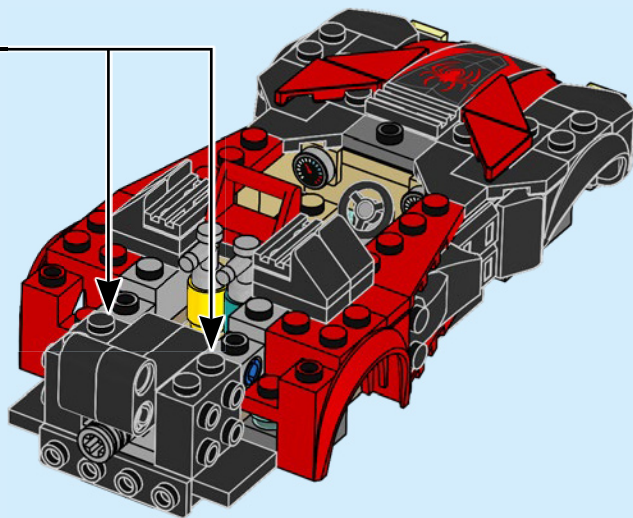

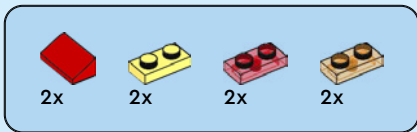

65

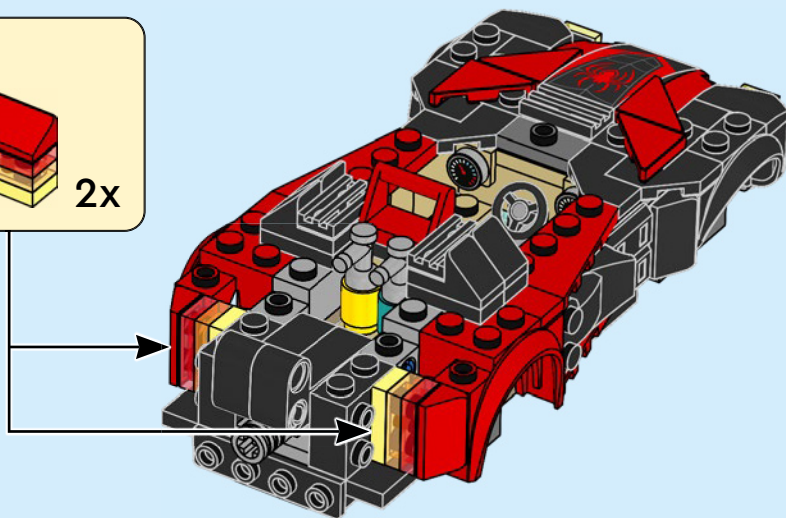
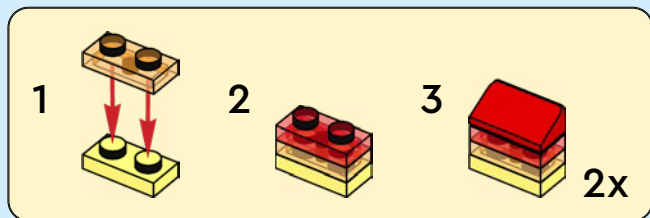



2x

66

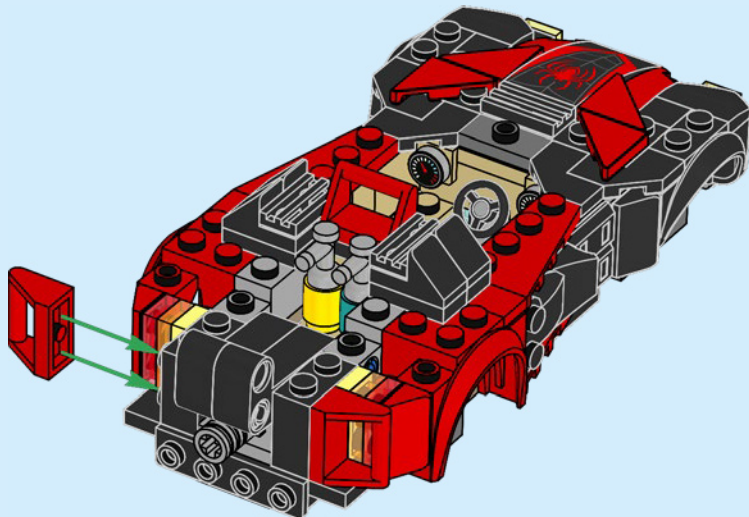



2x

67

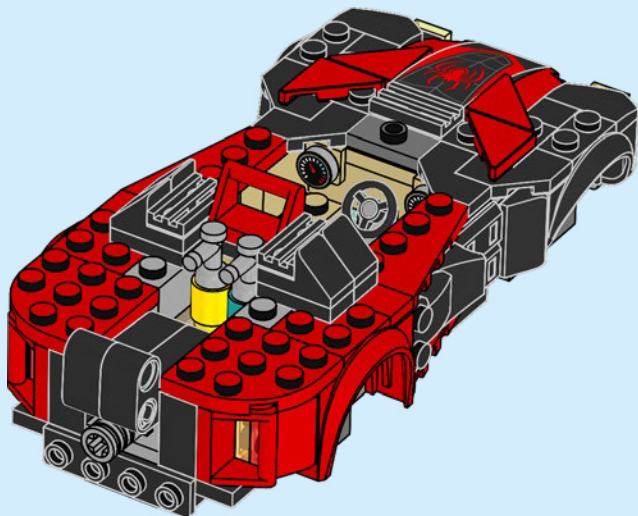

1x

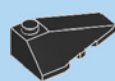

1x

68

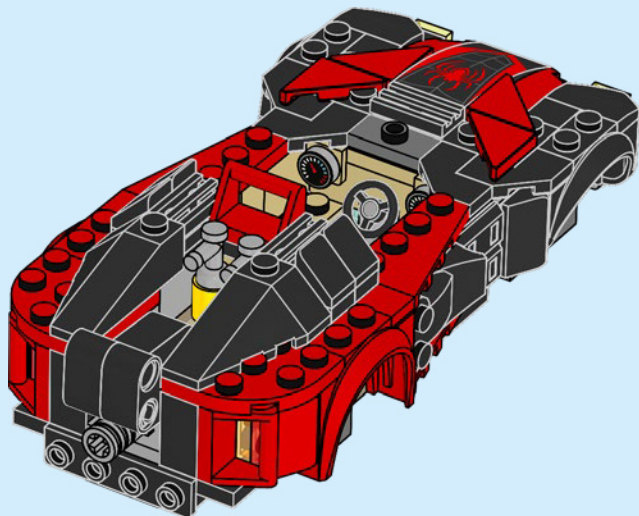

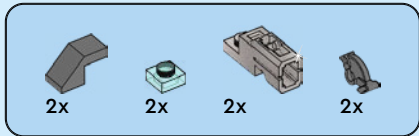

69

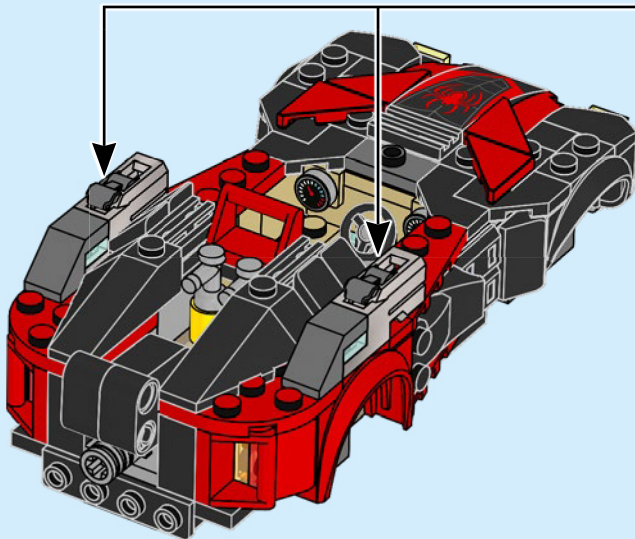
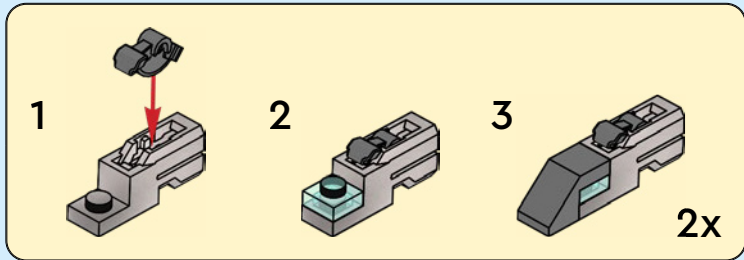



1x



4x

70

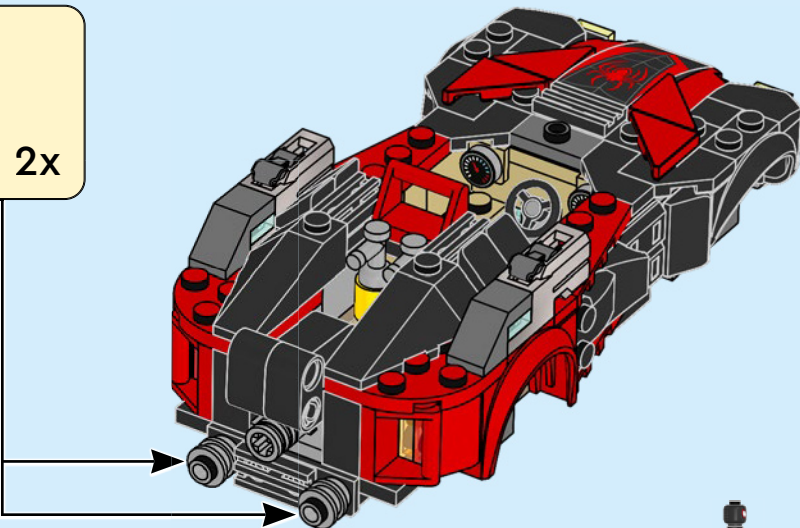
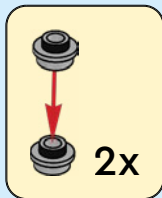



2x

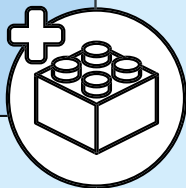

71

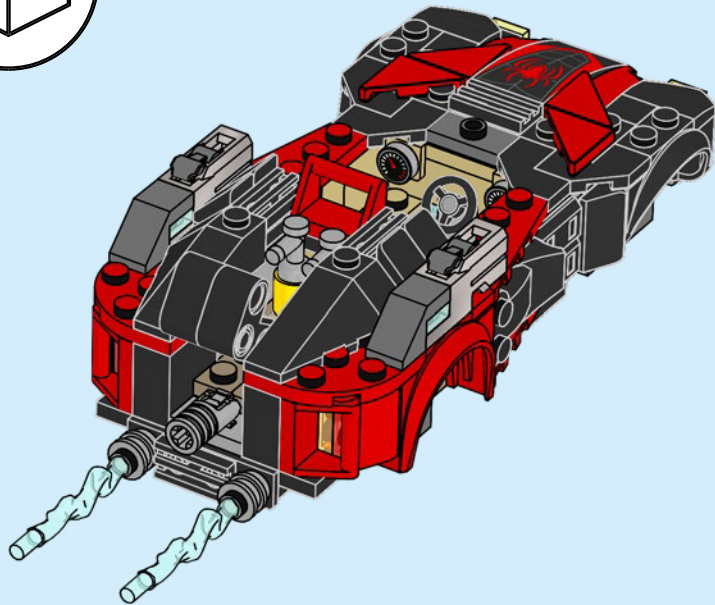

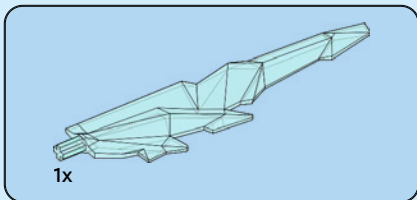

72

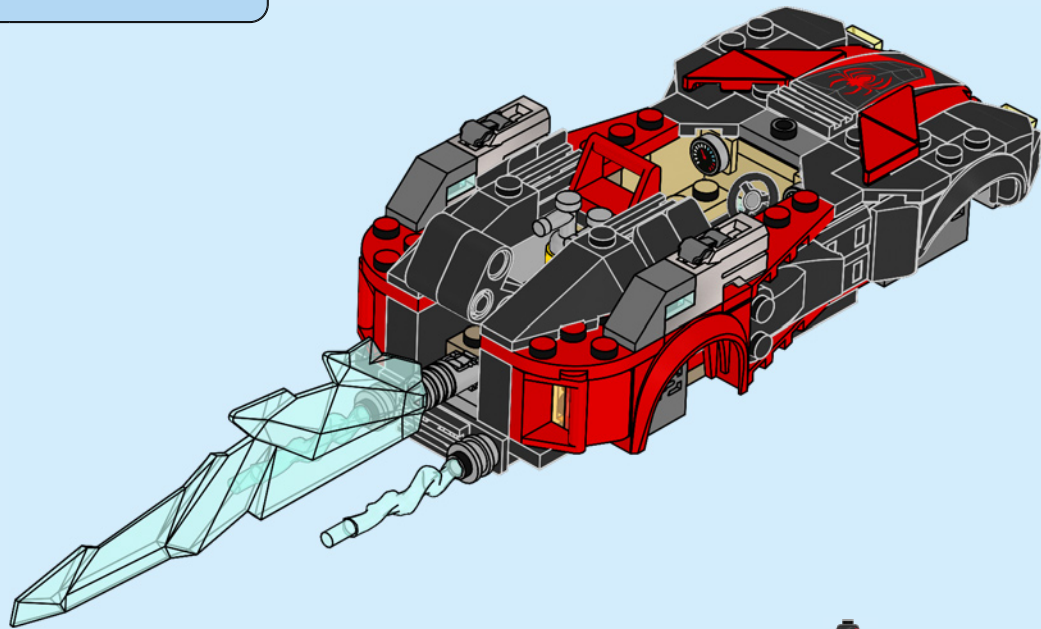

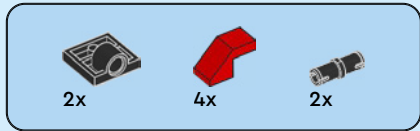

73

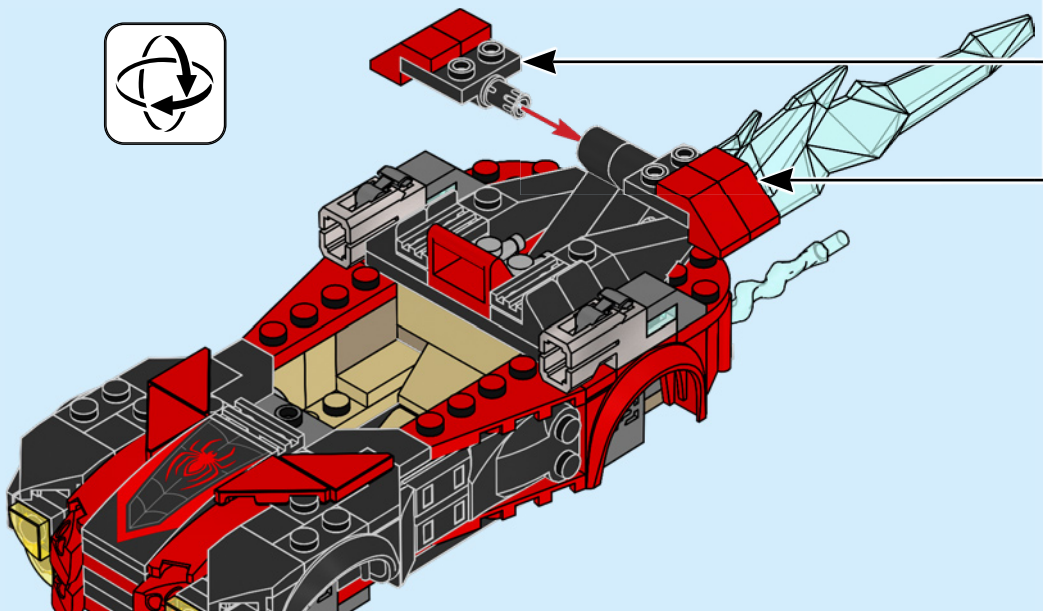
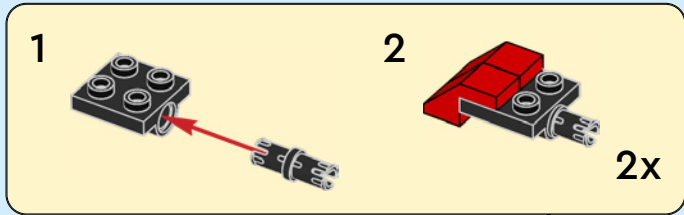
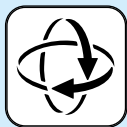

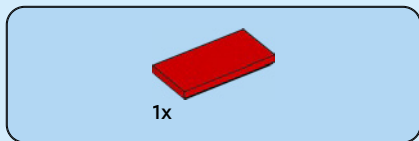

74

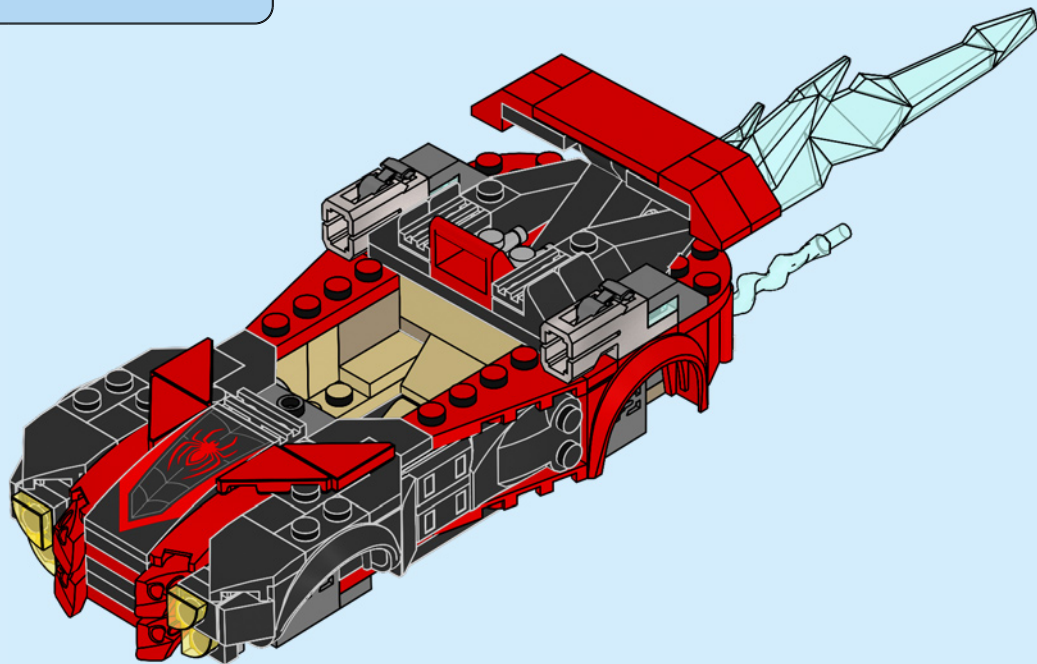

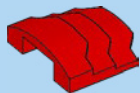

1x

75

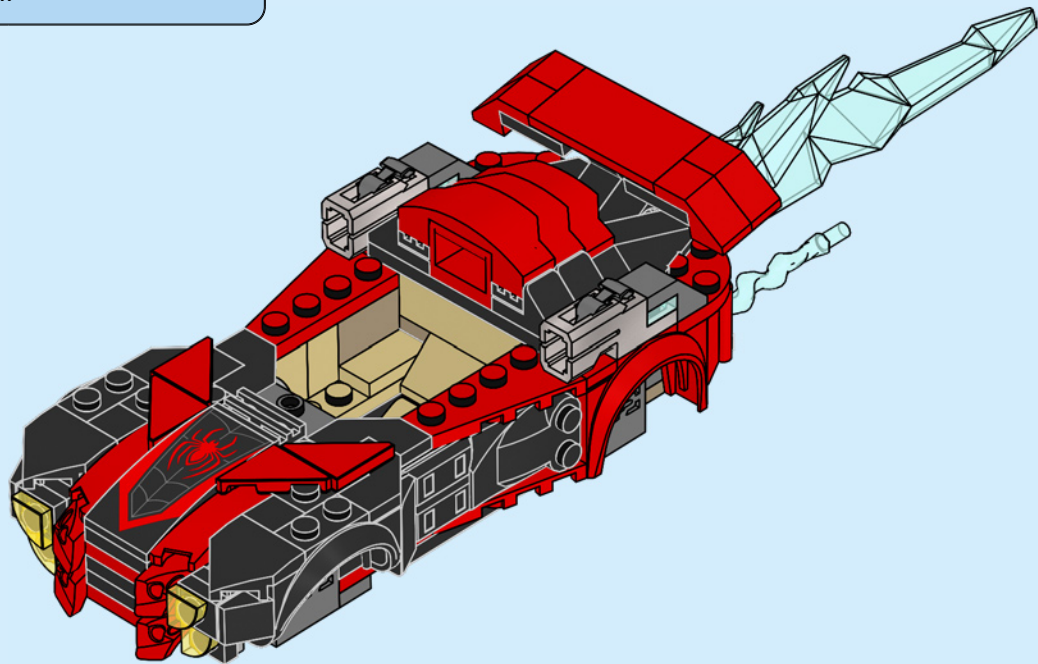

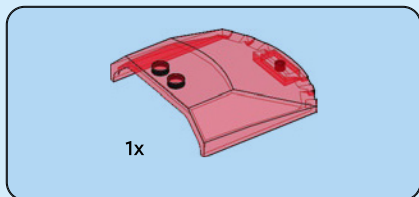

76

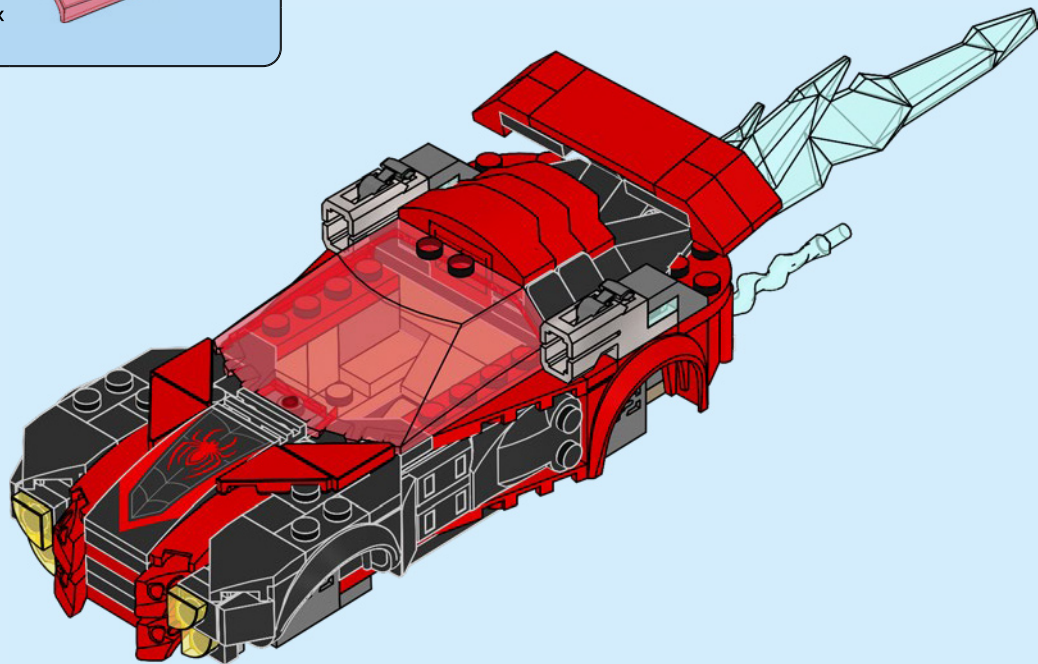



77

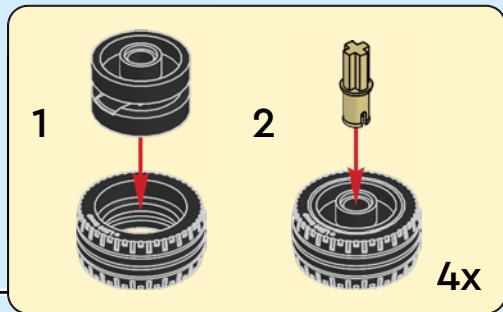
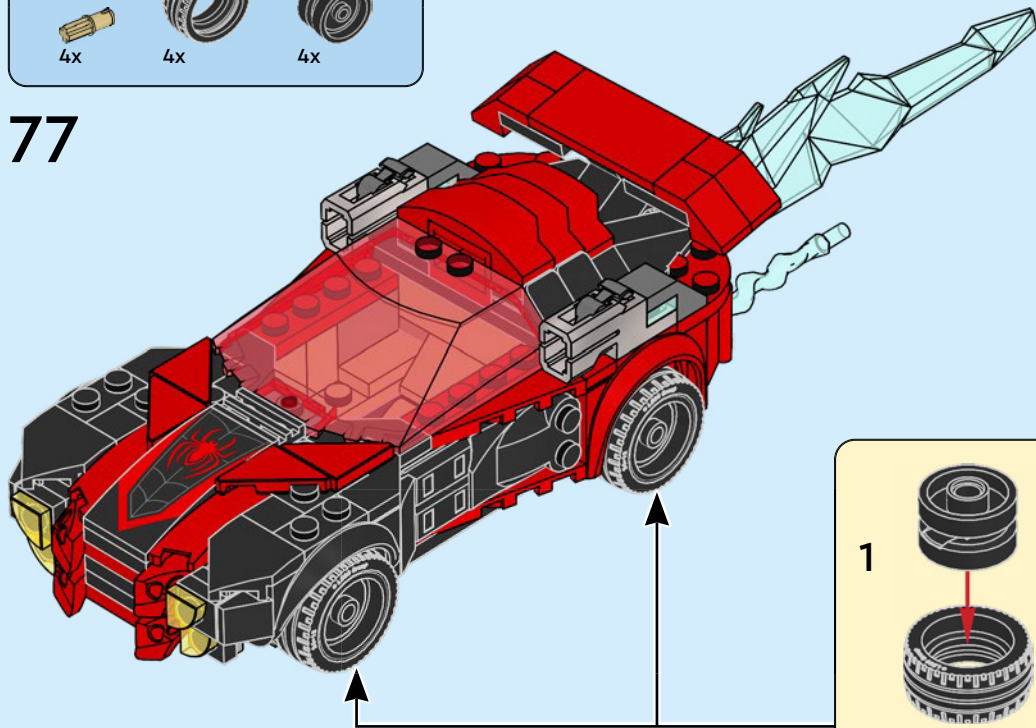



4x

78

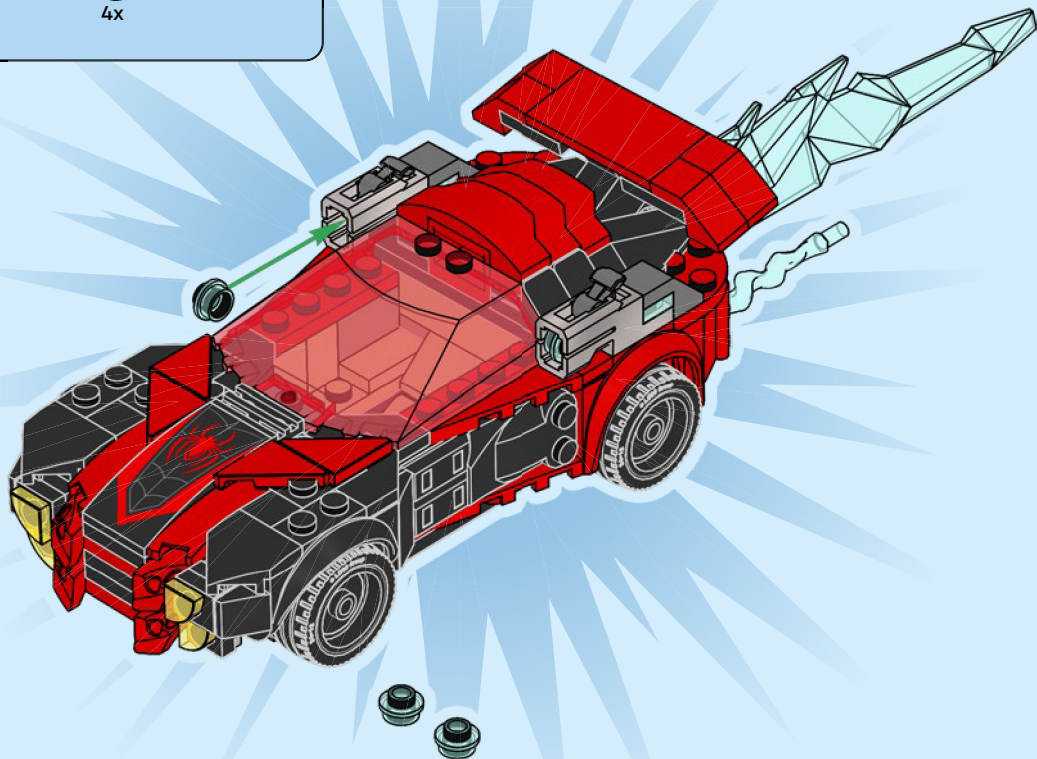

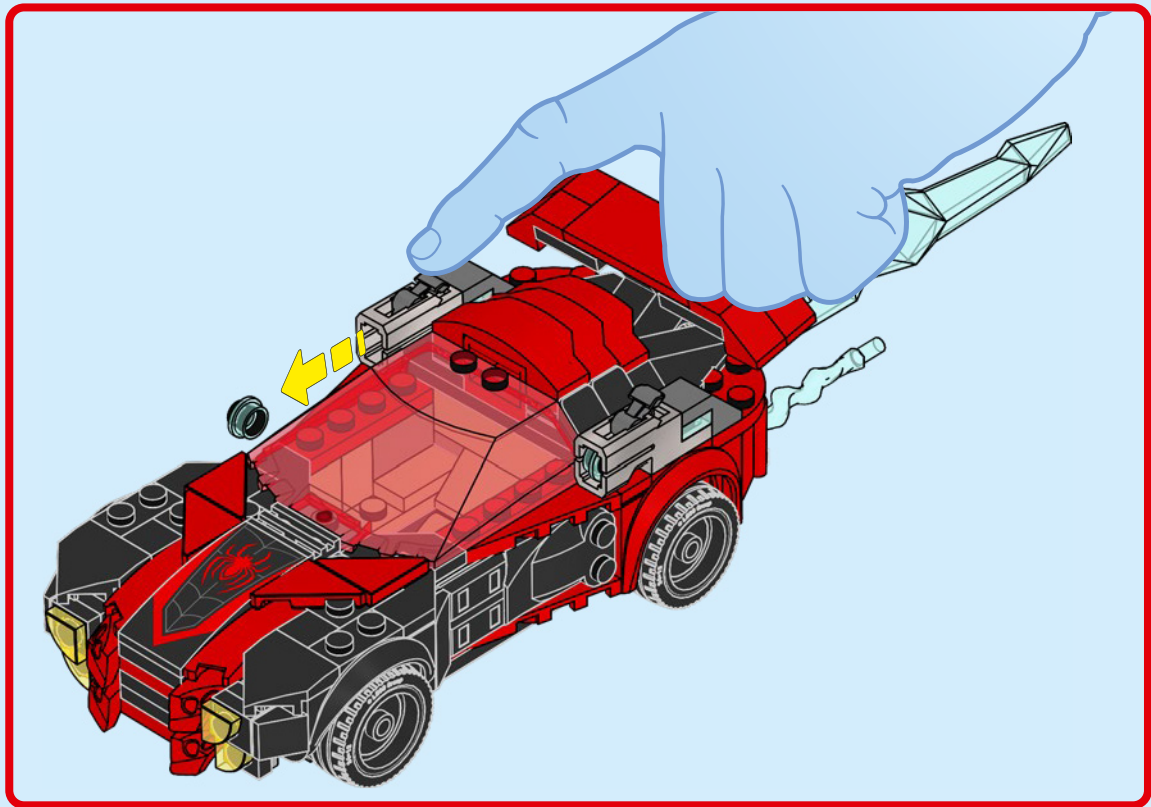

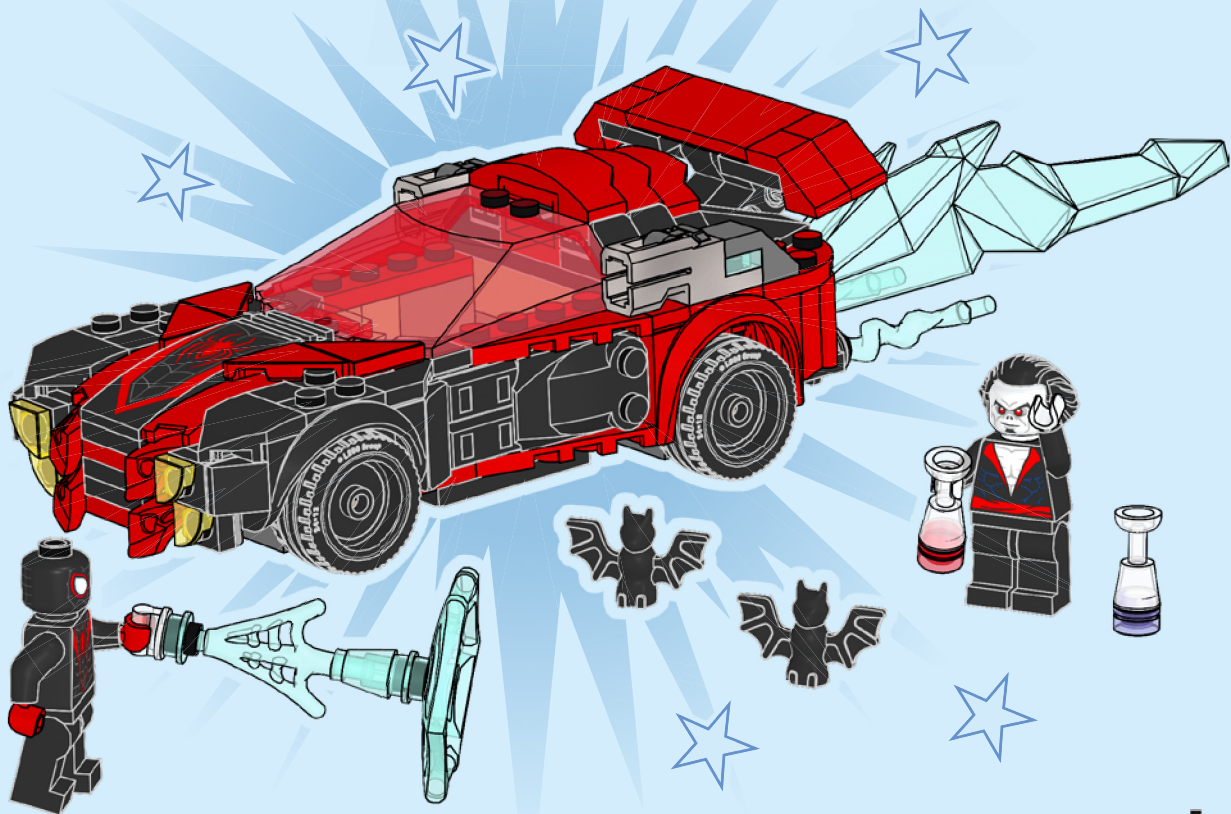

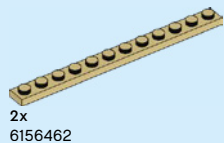

2x
6156462

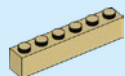

2x
4112982



2x
6374192



1x
4624086



4x
4666579



2x
6214334



3x
6221467



1x
4114322

78



2x
6232135



1x
4118790



2x
307021



2x
4160866



2x
4161329



2x
4651524



4x
6275178



3x
243221



4x
6351892



4x
362321



2x
4178428



1x
4560179



2x
4653024



2x
6102586



1x
6179656



1x
6301367



1x
306224



2x
300424



2x
302224



2x
6201647



4x
6404156



1x
6325432



1x
6240210



2x
4206482



2x
6329581



4x
6168647



2x
4211503



2x
4211535



4x
6362975



1x
6271539



2x
4211388



1x
6265742



1x
6421728



1x
6238043



1x
6325955



2x
6213776



6x
4550168



4x
6132768



2x
6310835



2x
6240217



1x
6208450



1x
6258607



2x
6240212

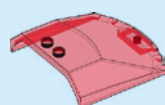

1x
6400560



10x
6283590



1x
6337639



2x
6252043



1x
6240222

2x
6360675

1x
6329746

1x
6348023

2x
4106513

1x
6404136

1x
366626

2x
6168776

2x
4504382

2x
9339

4x
6290263

2x
302126

2x
4285883

1x
6092572

2x
307026

4x
6069000

2x
6061032

4x
6166859

4x
241226

1x
6013082

2x
6299338

4x
6069000

2x
6061032

4x
6166859

4x
241226

3x
4211056

3x
6279875

2x
6308912

4x
6102596

2x
6271825

2x
6252537

2x
6287680

2x
4548180

1x
4226995

1x
6168620

1x
6040298

1x
6170384

2x
6166107

9x
302326

4x
6156991

1x
6432403

1x
6040297

1x
379526

1x
6359231

2x
6275806

1x
6039194

1x
6432406

1x
303226

2x
6345950



1x
6326582

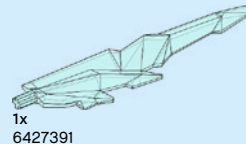

1x
6427391



 [LEGO.com/service](https://www.LEGO.com/service)

YOU COULD **WIN**



Scan this QR code or go to **LEGO.COM/PRODUCTFEEDBACK** and give us your short feedback about this LEGO® set for a chance to win a cool LEGO prize.

Terms and Conditions apply*



DE: Du könntest GEWINNEN. Es gelten die Teilnahmebedingungen* **FR: Tu pourrais GAGNER.** Des conditions s'appliquent* **IT: Potresti VINCERE tu.** Termini e condizioni sono applicabili* **ES: Puedes GANAR.** Aplican términos y condiciones* **PT: Poderá GANHAR.** Aplicam-se termos e condições* **JA: プレゼント付き! 利用規約が適用されます*** **ZH: 轻松获奖. 条款和条件适用*** **KO: 상품의 주인이 되어보세요. 소정의 약관이 적용됩니다*** **RU: Вы можете ВЫИГРАТЬ.** Действуют положения и условия* **PL: Szansa na WYGRANĄ.** Obowiązują warunki korzystania* **CS: Máte šanci VYHRÁT.** Platí všeobecné smluvní podmínky* **SK: Máte šancu VYHRAŤ.** Platia všeobecné zmluvné podmienky* **HU: TE IS NYERHETSZ.** Felhasználási feltételek érvényesek* **RO: Ai putea CÂȘTIGA.** Se aplică termenii și condițiile* **BG: Можете да СПЕЧЕЛИТЕ.** Има определени правила и условия* **LV: Tu vari LAIMĒT.** Ir spēkā noteikumi un nosacījumi.* **ET: Sul on võimalus VÕITA.** Kehtivad tingimused* **LT: Jūs galite LAIMĖTI.** Taikomos sąlygos*
*LEGO.com/productfeedback-terms