



 **FR**
DONNEZ
OU
RECYCLEZ

 OU  OU 
ASSOCIATION MAGASIN DÉCHÈTERIE

Adresses sur quefairedemesdechets.fr



LEGO.com/sustainable-packaging



BUILDER



Apple and the Apple logo are trademarks of Apple Inc., registered in the U.S. and other countries and regions. App Store is a service mark of Apple Inc. Google Play and the Google Play logo are trademarks of Google LLC. Tencent and the Tencent logo are trademarks of Tencent Inc.

Q [LEGO.com/devicecheck](https://www.lego.com/devicecheck)

EN Ask parents' permission before going online | **DE** Eltern um Erlaubnis bitten, bevor du online gehst | **FR** Demande l'autorisation d'un parent avant d'aller en ligne | **IT** Chiedi il permesso ai tuoi genitori prima di andare online | **ES** Pídeles permiso a tus papás antes de conectarte a Internet | **PT** Peça autorização aos pais antes de acederes online | **JA** オンラインになる前に ほご者の方のきょかをもらおう | **ZH** 上网前应先征得父母的同意 | **KO** 온라인 접속 전에 보호자 동의가 필요합니다 | **RU** Спроси разрешения у родителей, прежде чем заходить в интернет | **PL** Poproś rodziców o zgodę, zanim wejdiesz do Internetu | **CS** Než půjdeš na internet, požádej rodiče o svolení | **SK** Skôr než pôjdeš na internet, vypýtaj si povolenie od rodičov | **HU** Kérj szülői engedélyt, mielőtt online csatlakoznál! | **RO** Cere permisiunea părinților înainte de a te conecta online | **BG** Поискайте разрешението от родител, преди да влезете онлайн | **LV** Pirms došanās tiešsaistē palūdz atļauju vecākiem | **ET** Enne Interneti kasutamist küsi vanematelt luba | **LT** Prieš prisijungdami prie interneto, atsklaskite tėvų

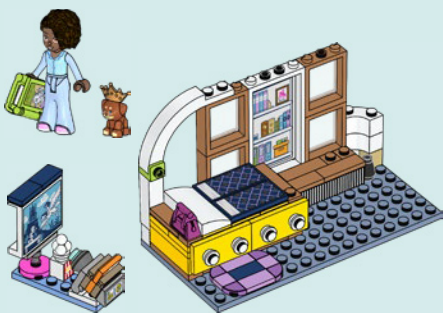

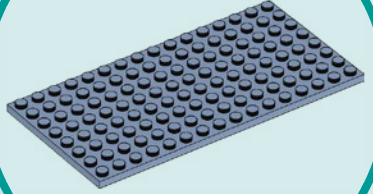
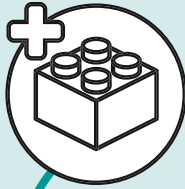

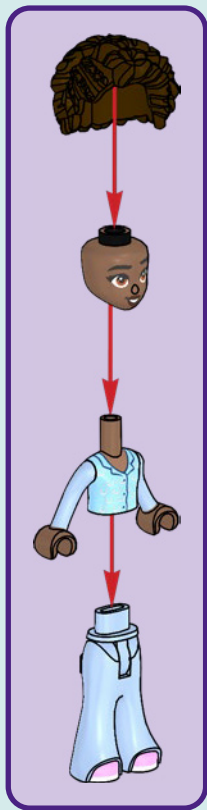

ALIYA

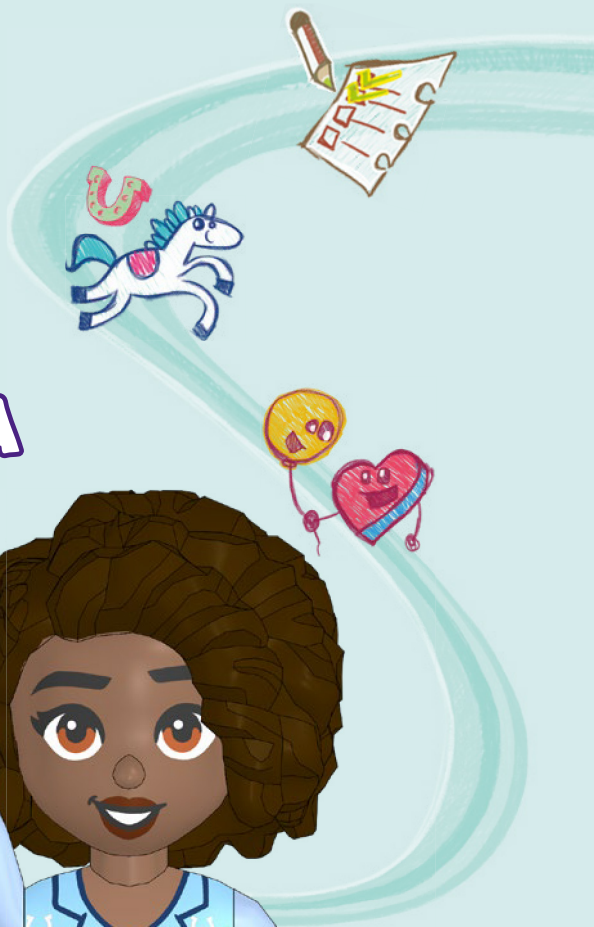

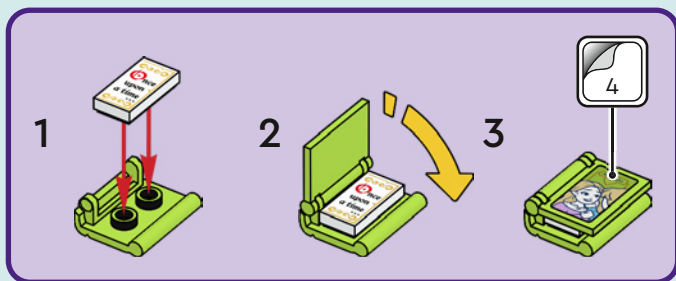

AIRA

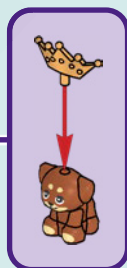



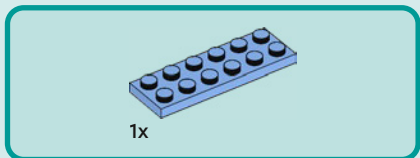

1

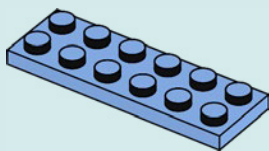

2

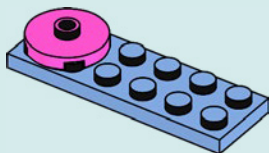



2x

3

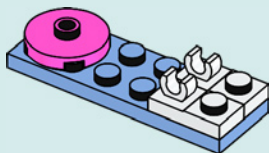

1x

4

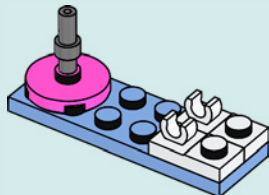



5

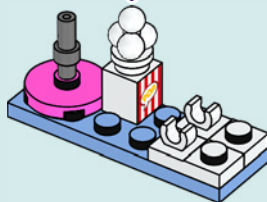
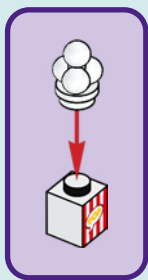

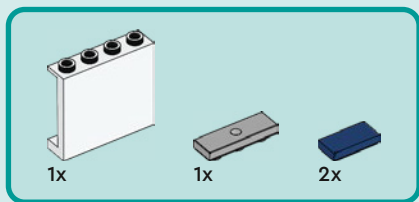

6

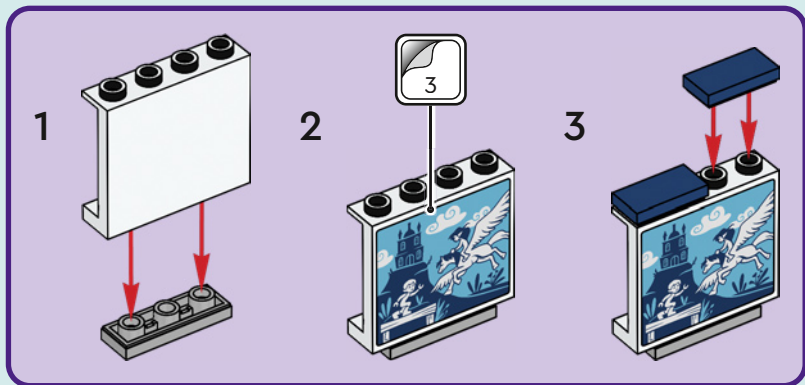

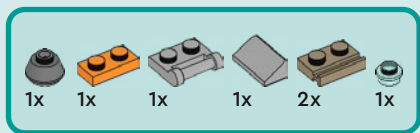

7

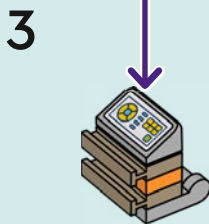
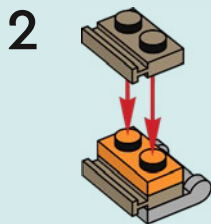
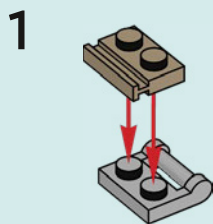



4

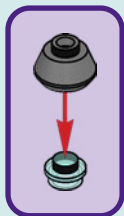



1x

8

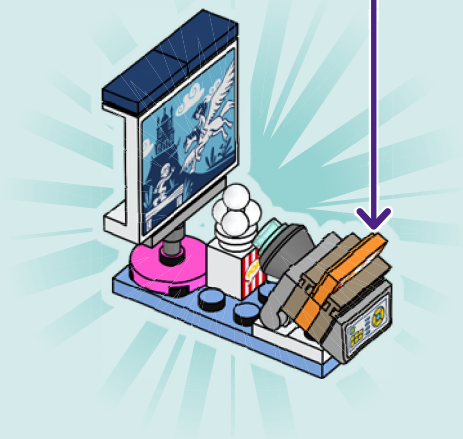

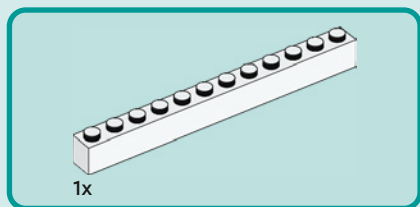

1

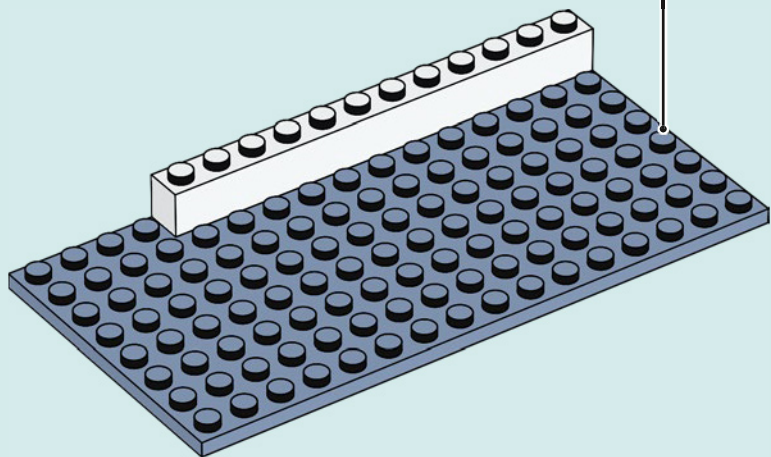
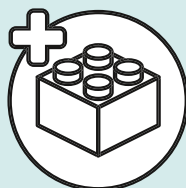



1x



1x

2

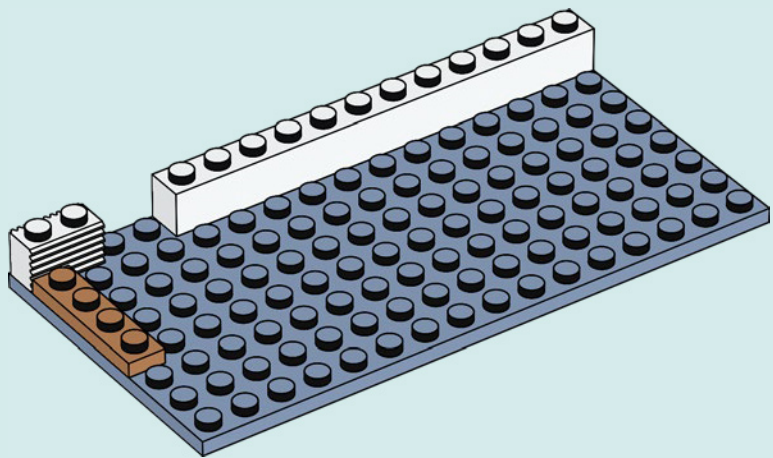

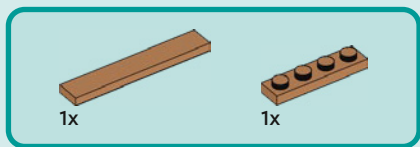

3

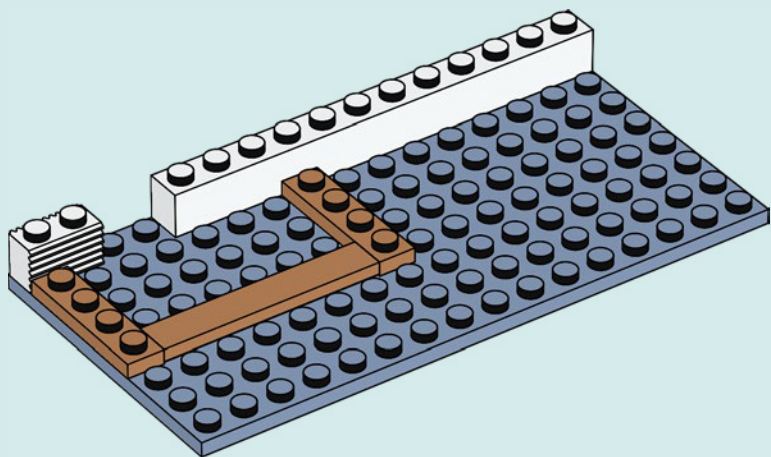

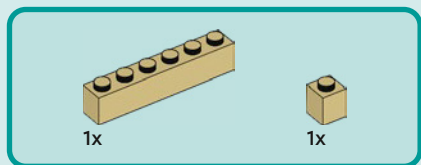

4

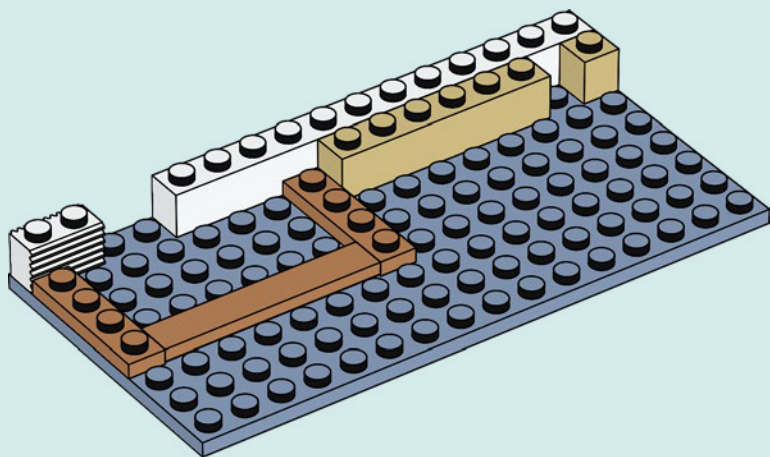



3x



1x

5

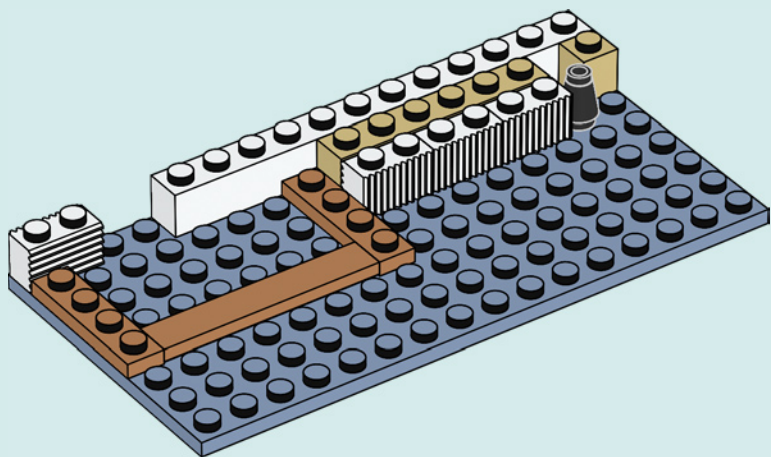



4x



2x

7

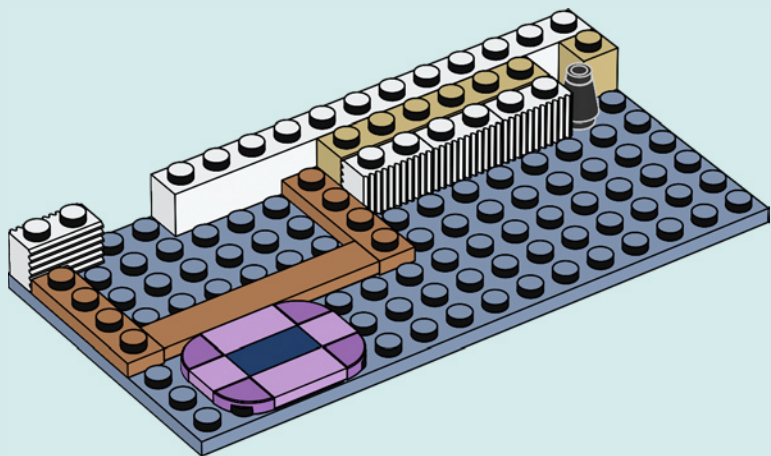



2x

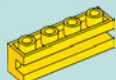

2x

8

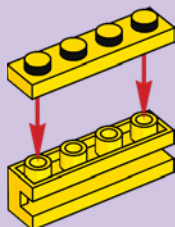

2x

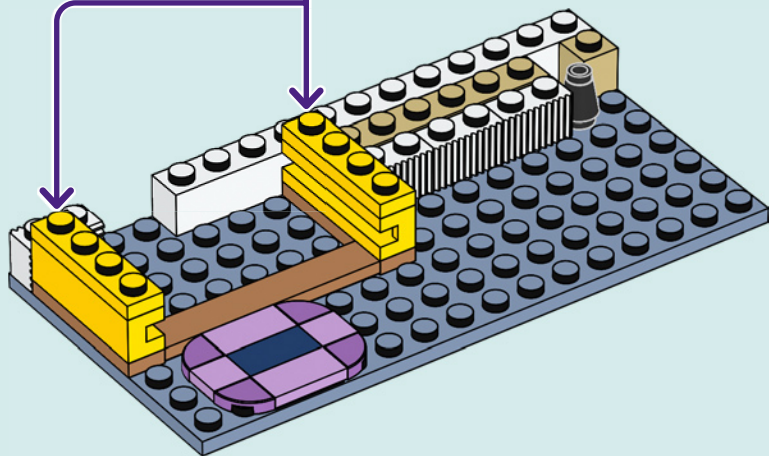

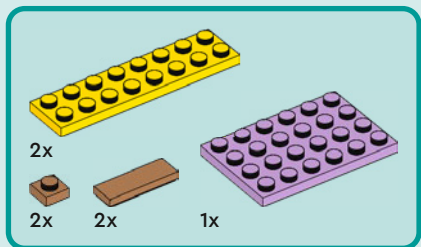
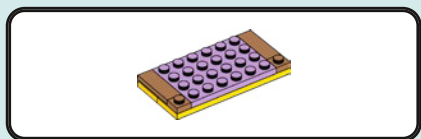

9

1

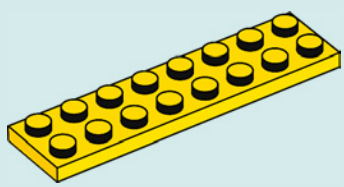

2

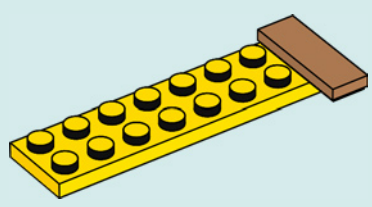

3

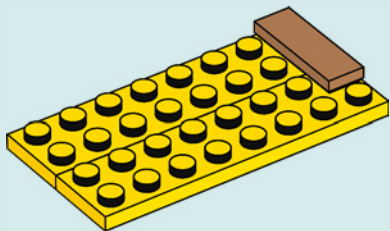

4

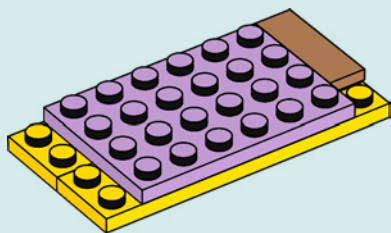

5

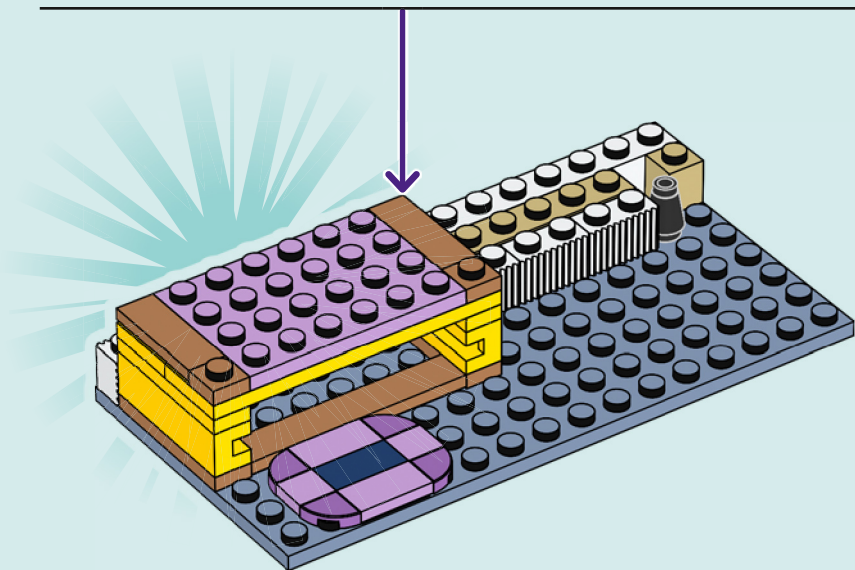
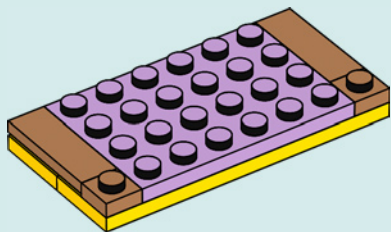

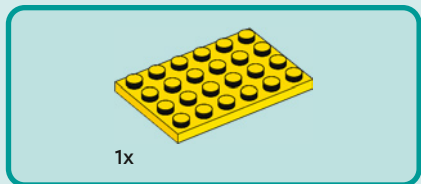

10

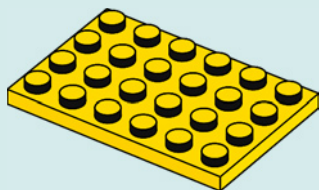



3x

11



3x

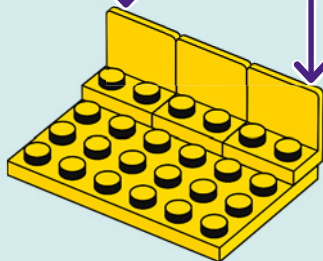



2x

12

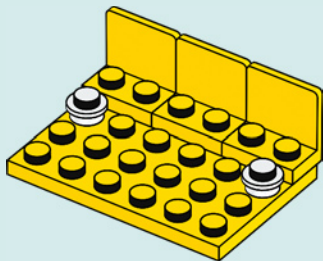

2x

13

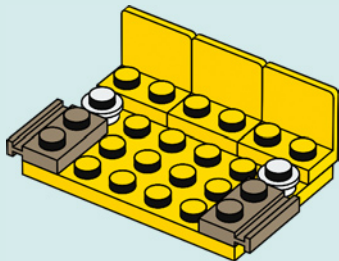



1x



1x



1x

14

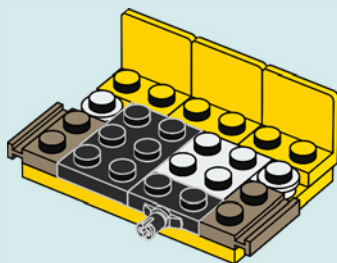

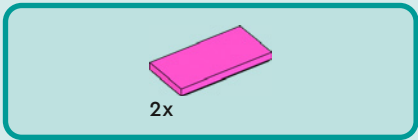

15

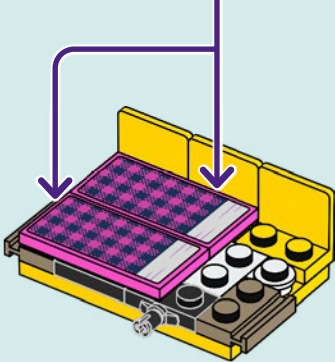
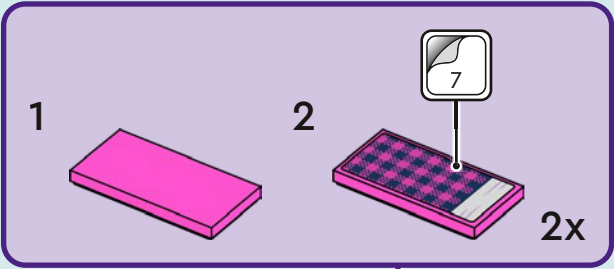



1x

16

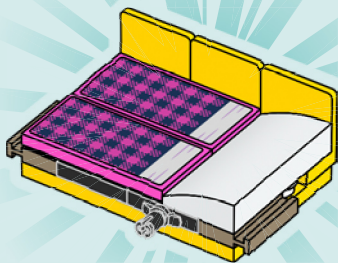

17

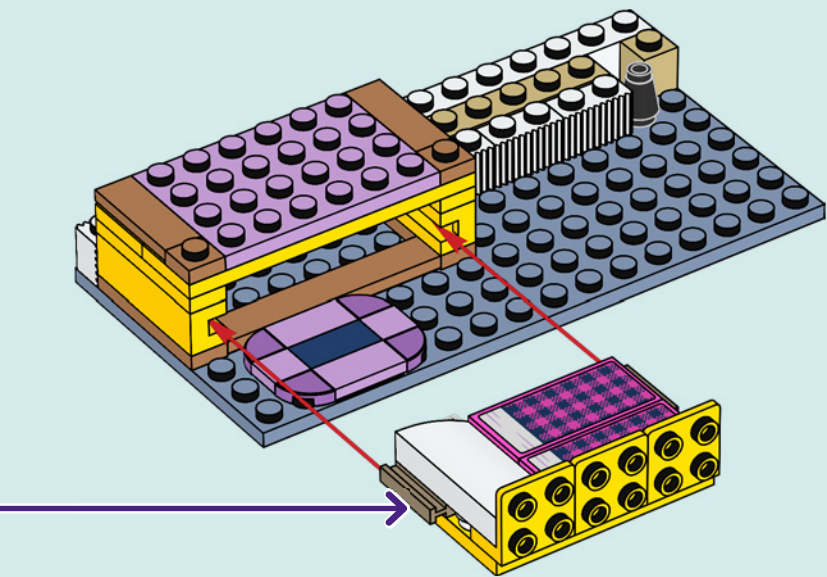

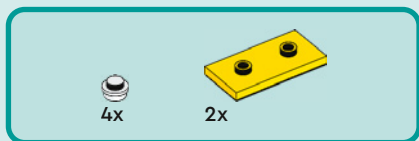

18

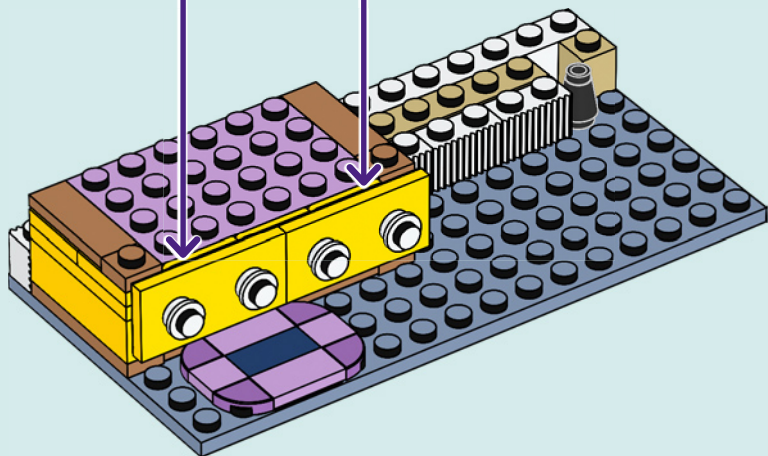
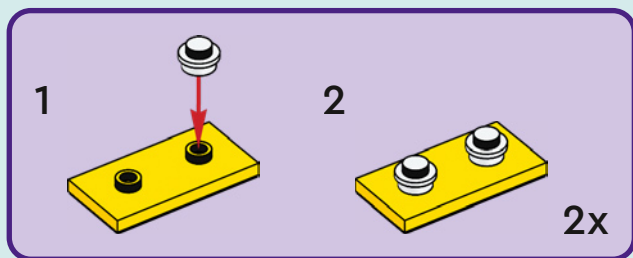



2x

19

1

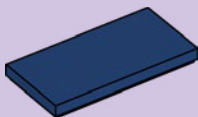

2



2x

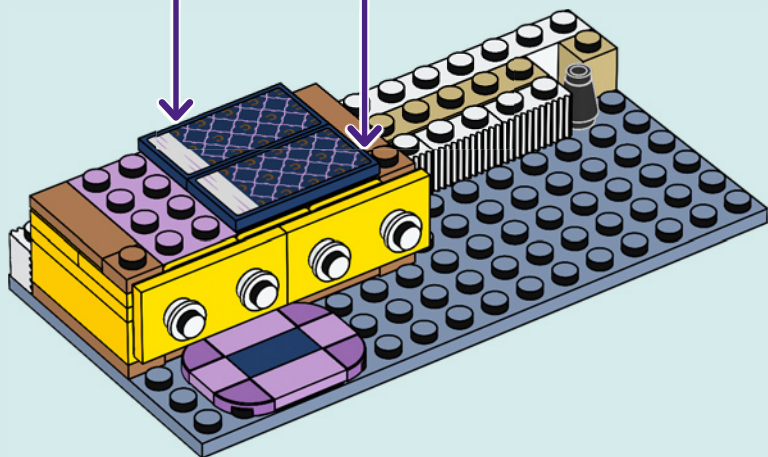



1x



1x

20

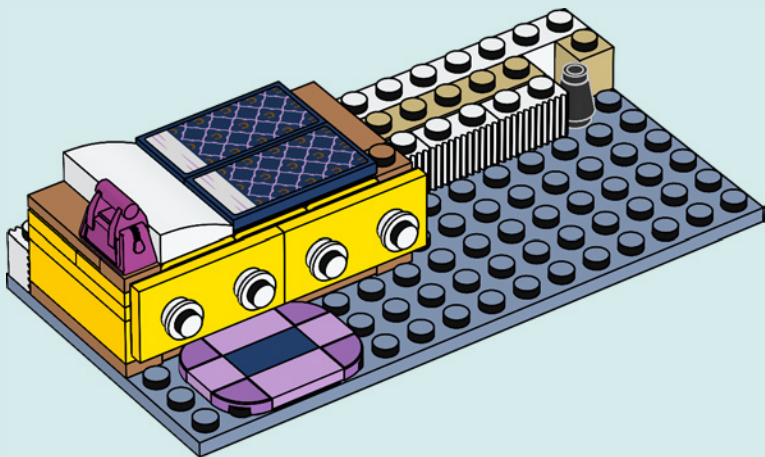



2x

22

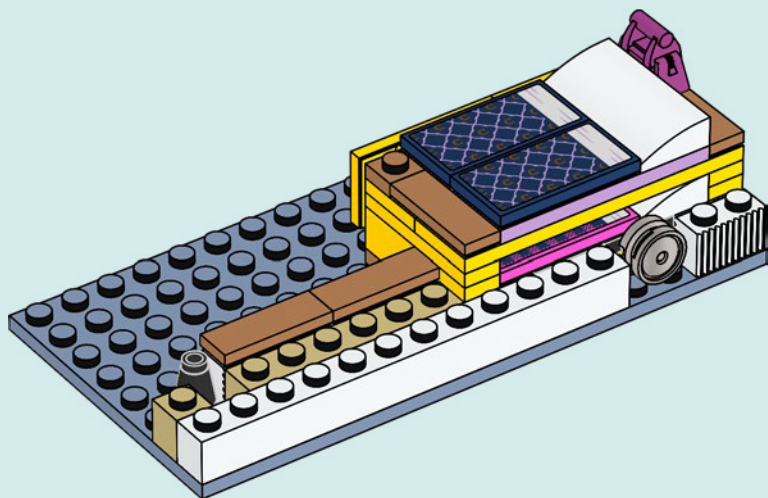



3x



1x

23

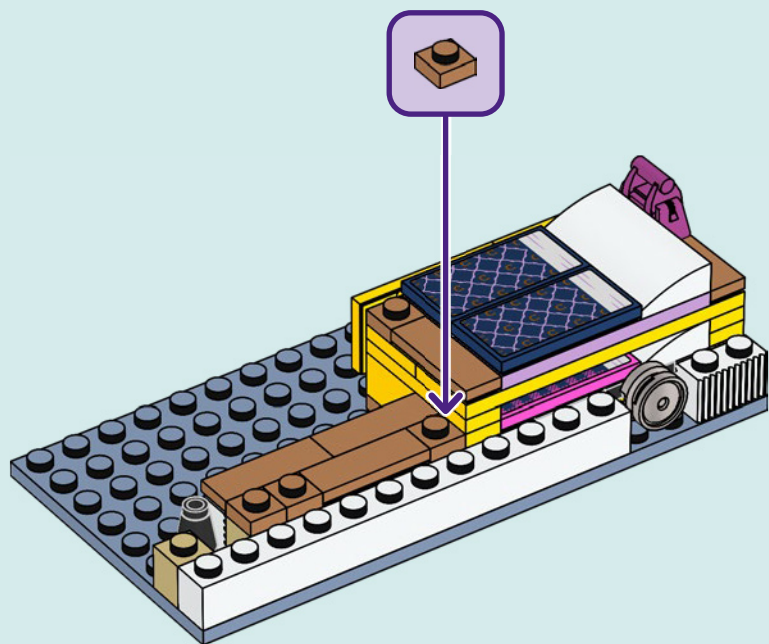

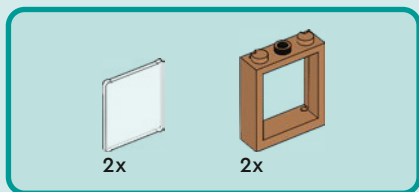

24

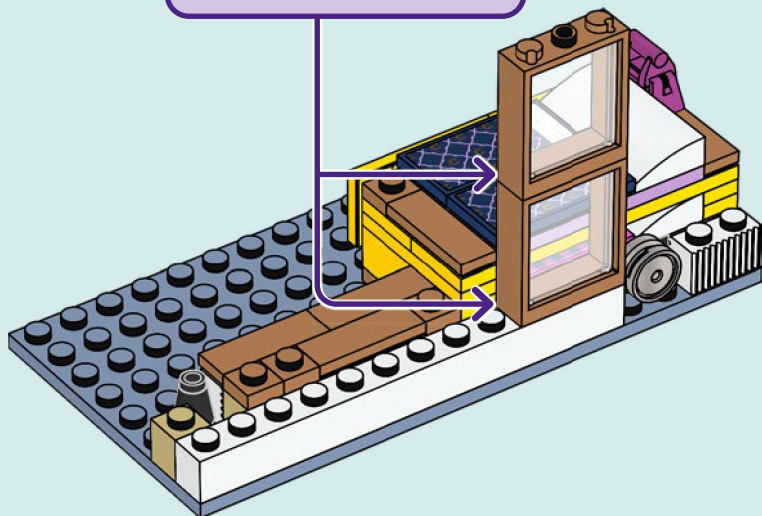
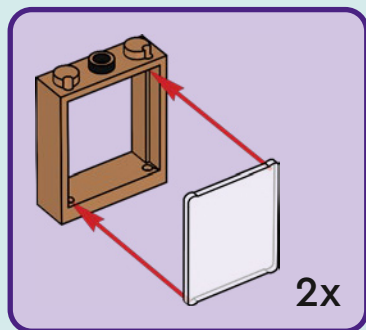

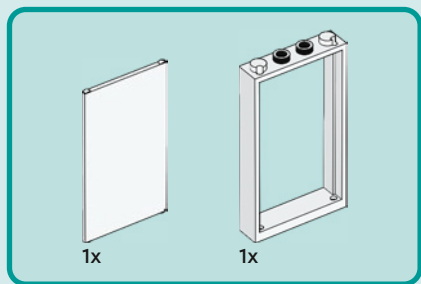

25

1

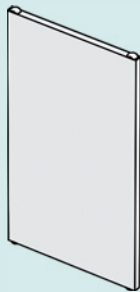

2



3

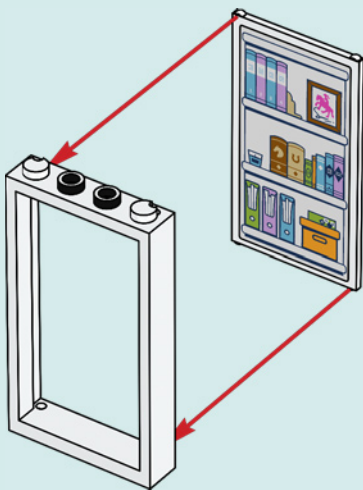

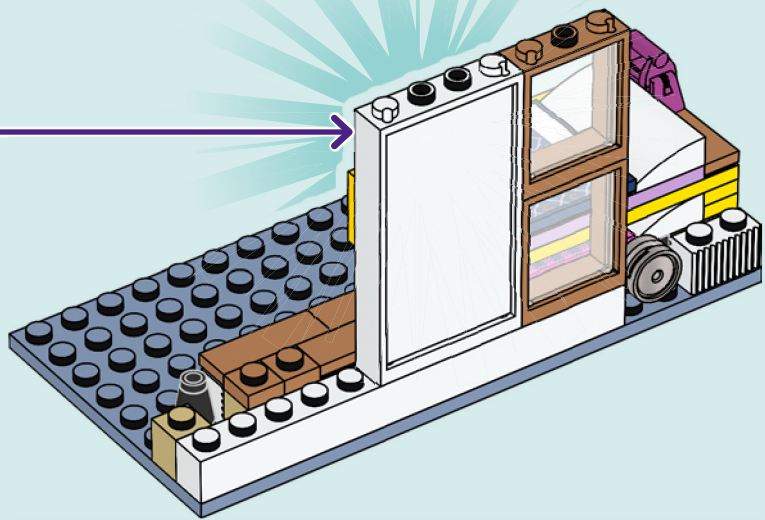

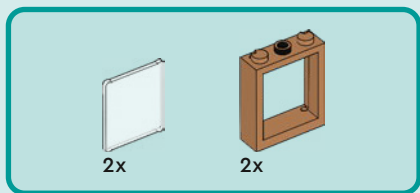

26

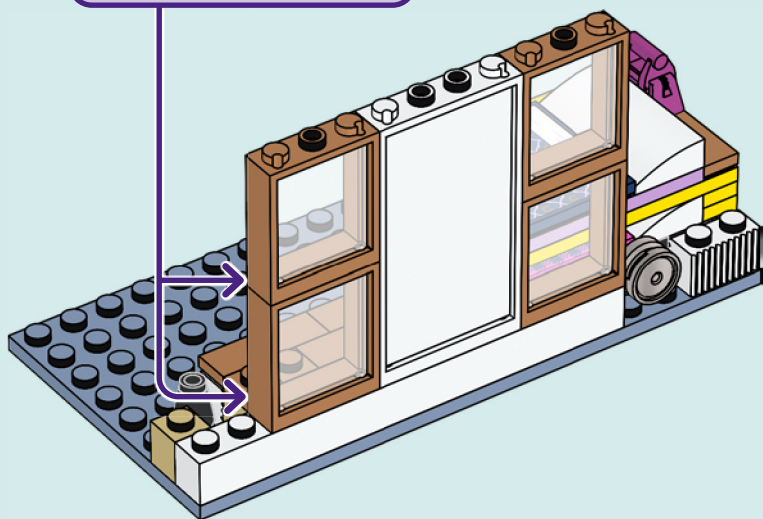
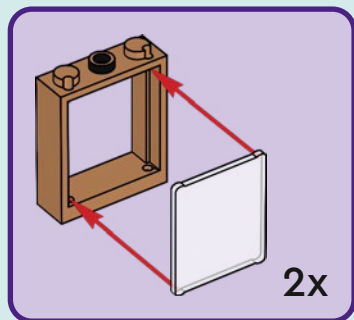



2x

27

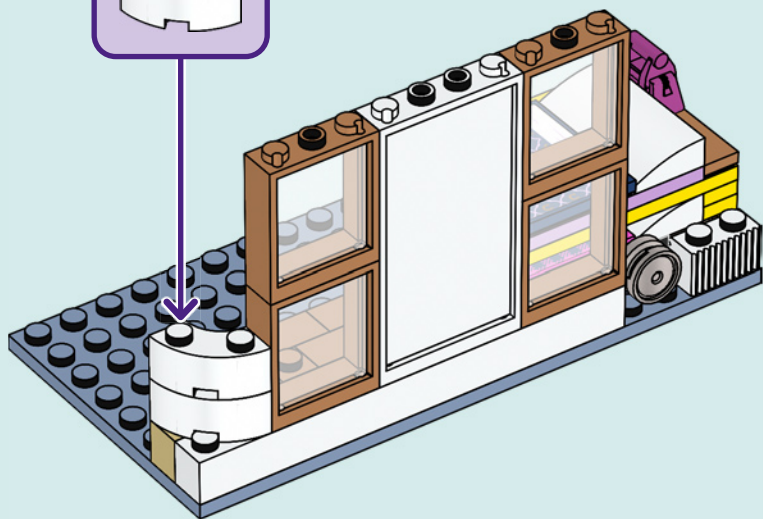
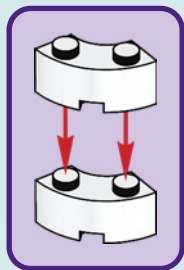

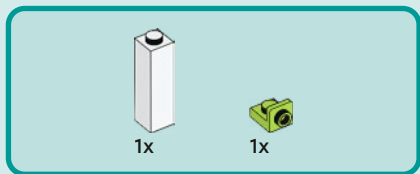

28

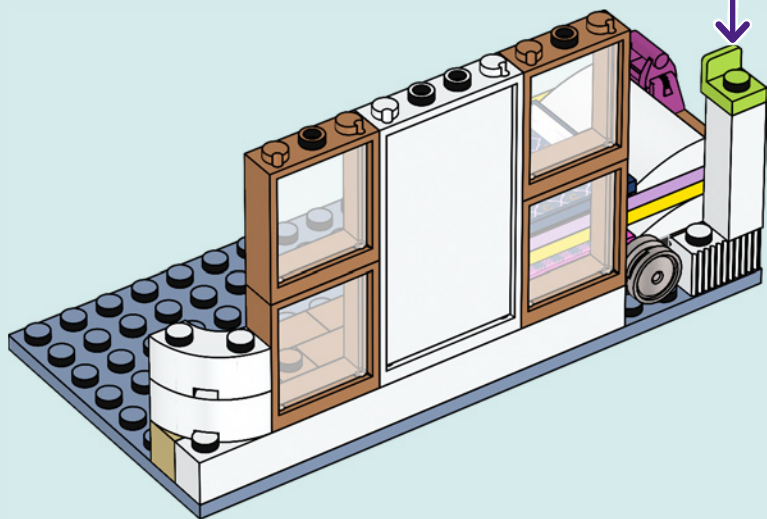
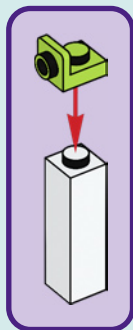

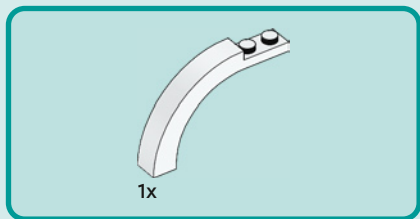

29

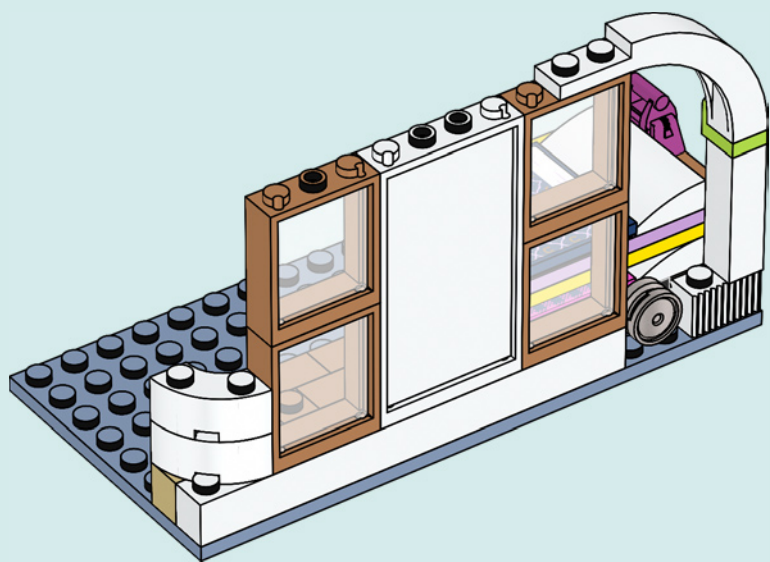



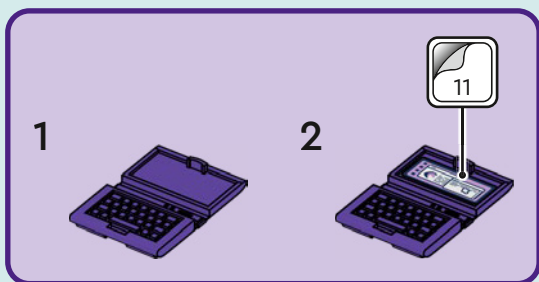
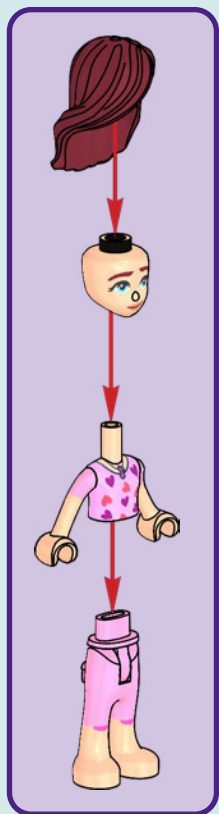

PAISLEY





1x

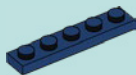

1x

30

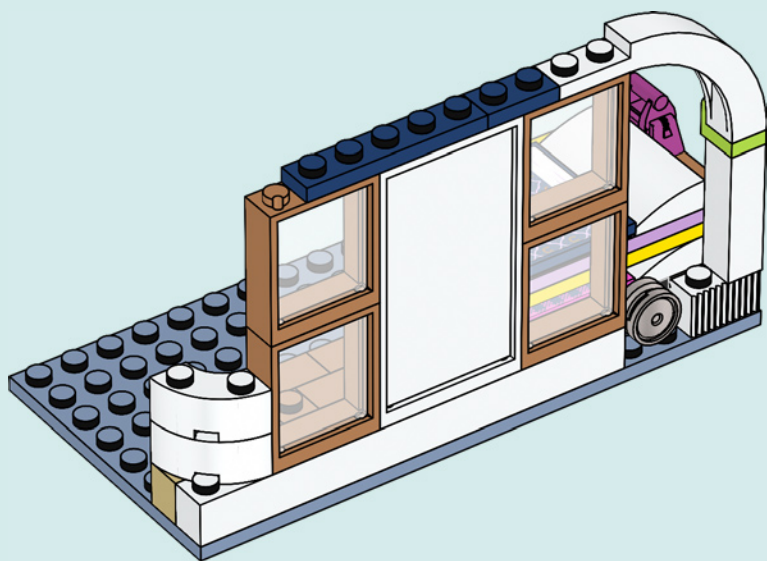



4x

31

1

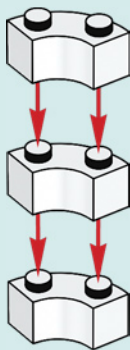

2

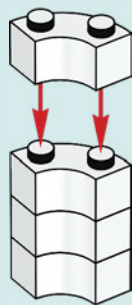

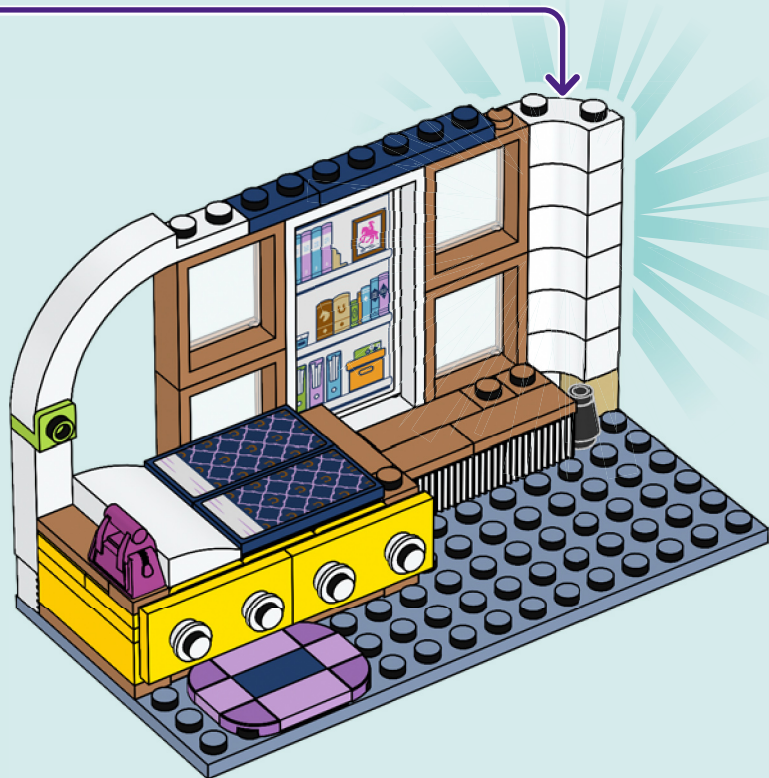



1x



1x

32

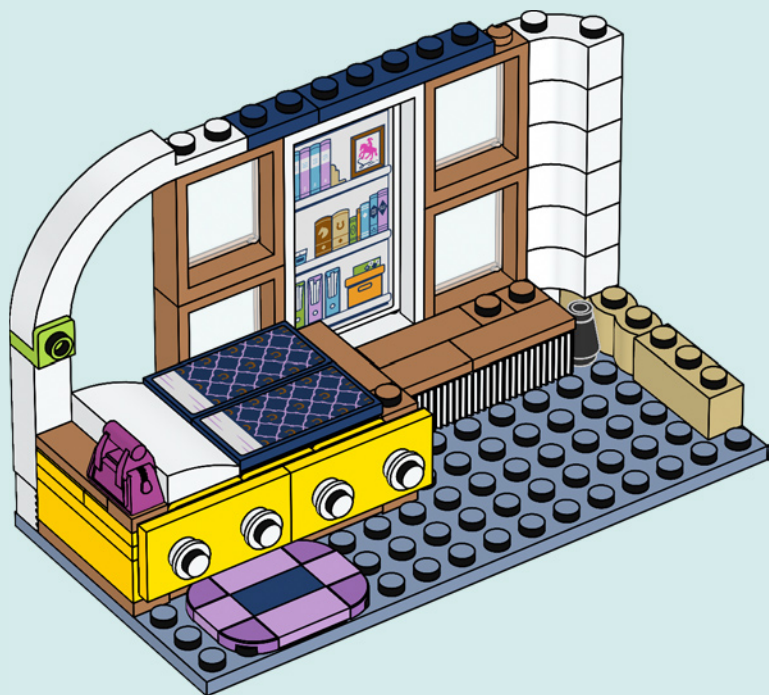



1x



1x

33



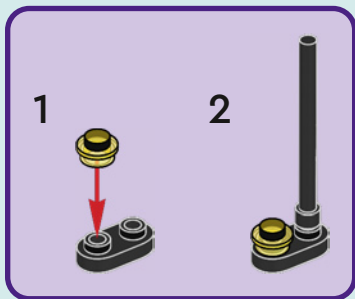
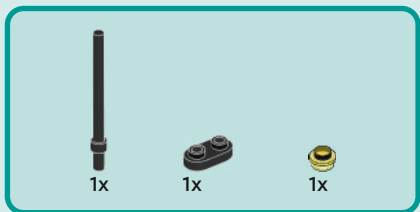

34

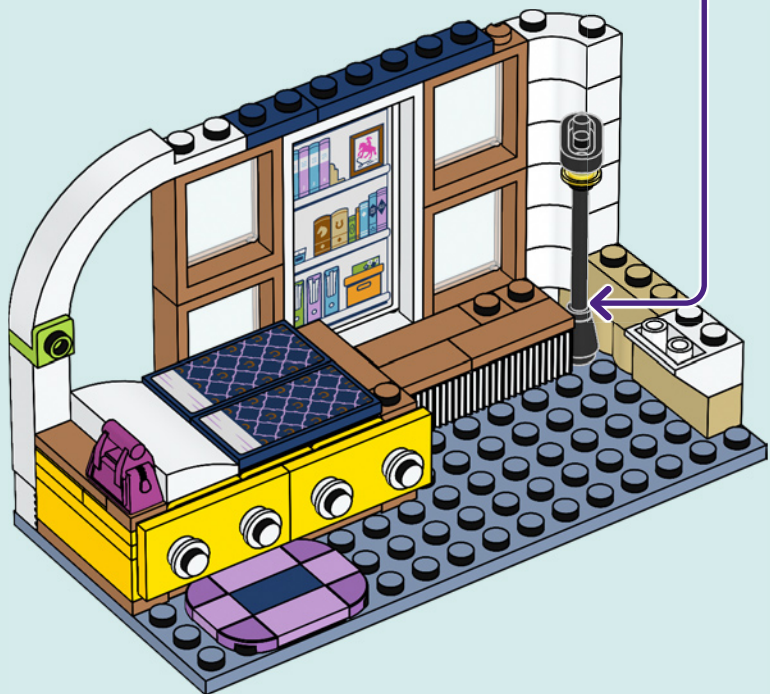

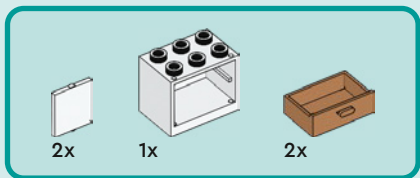

35

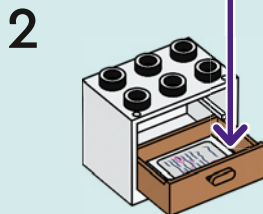
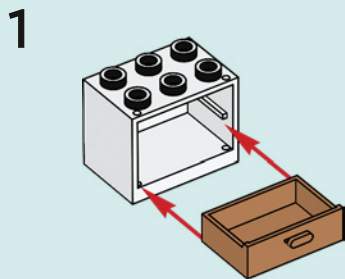
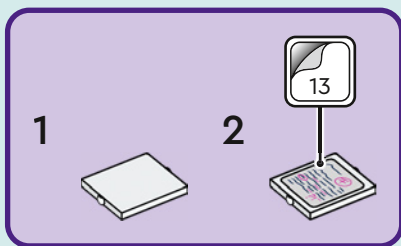

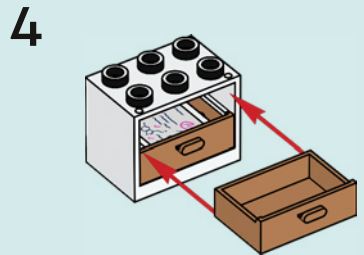
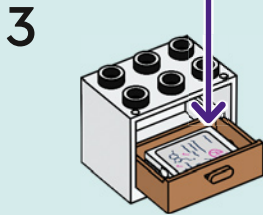
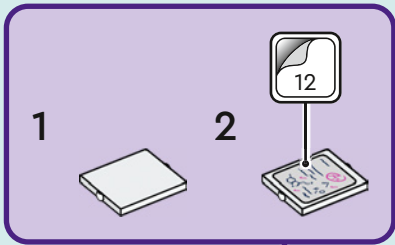

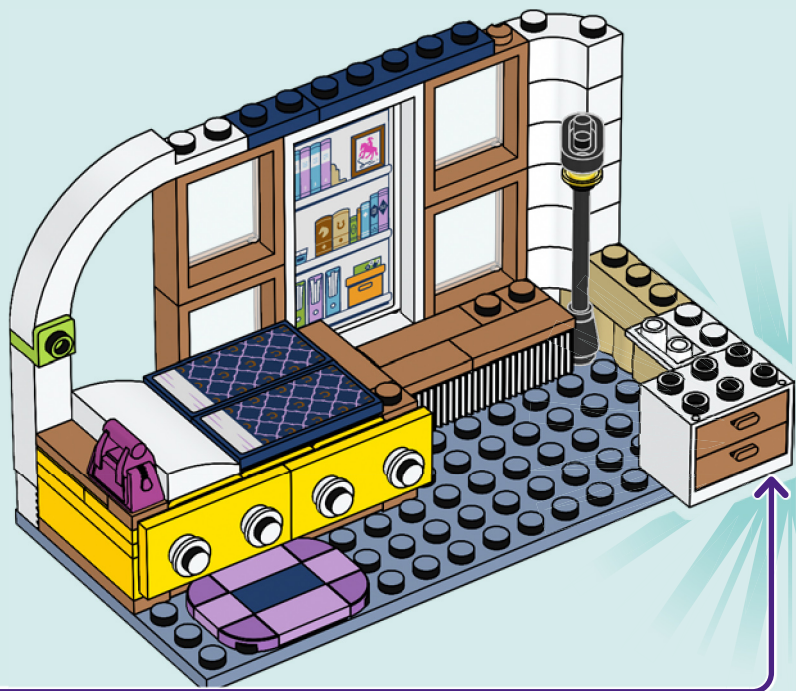

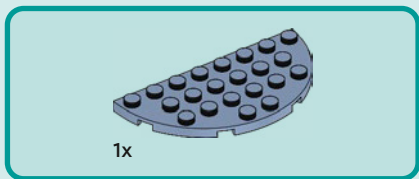

36

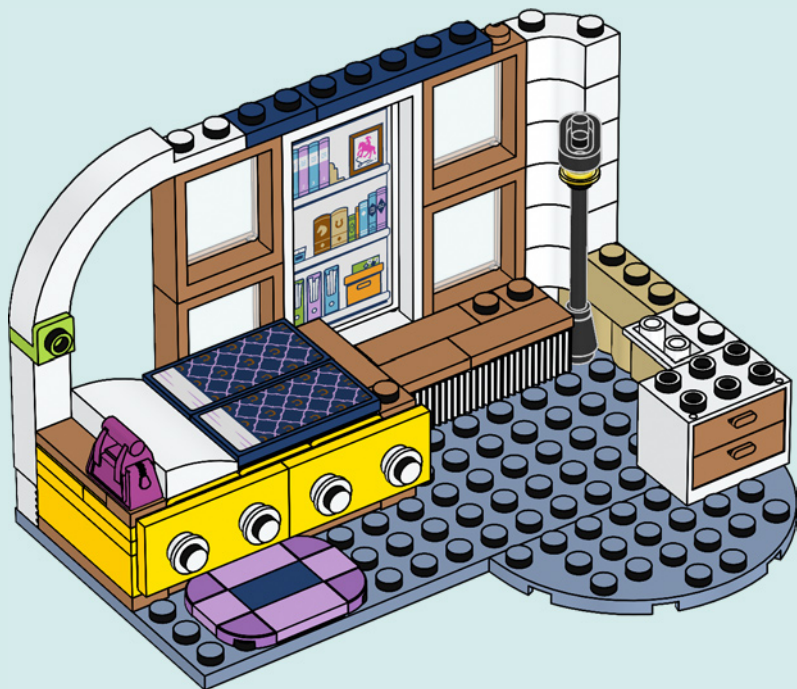

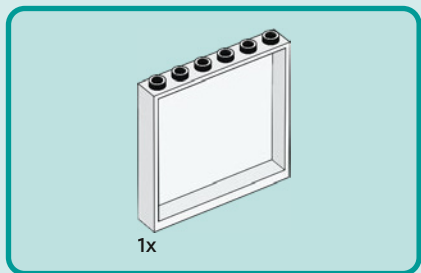

37

1

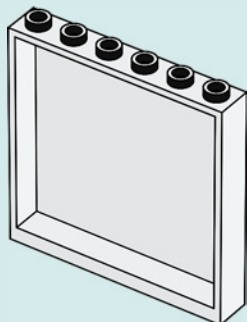

2

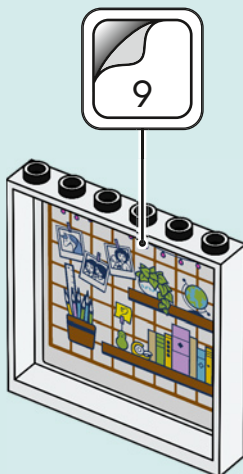

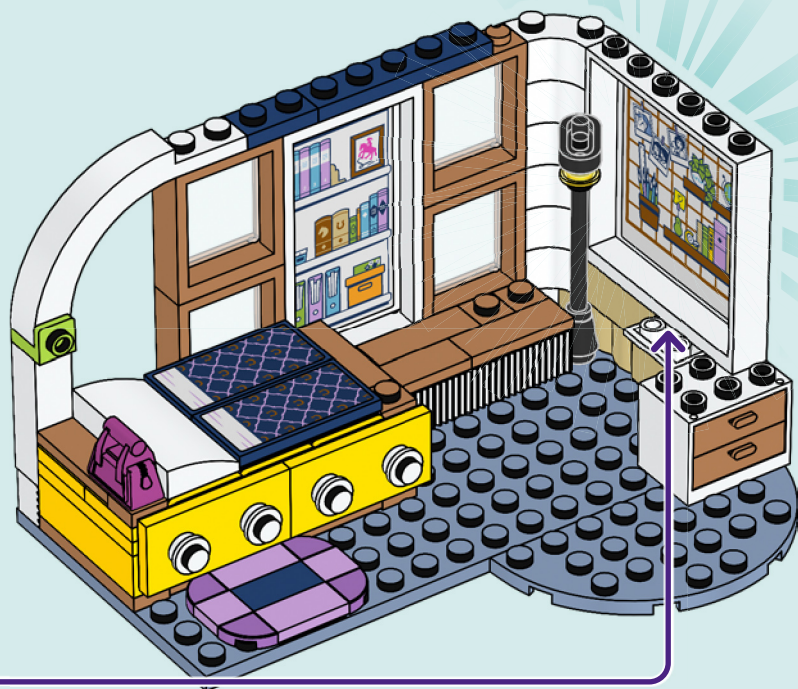



1x

38





2x

39



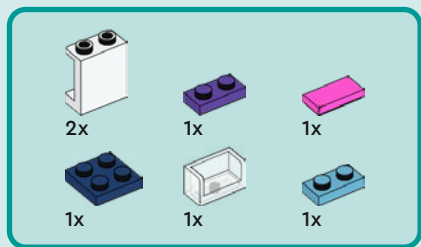

40

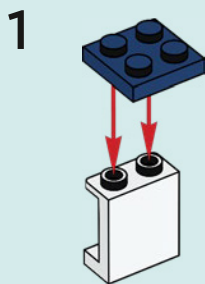

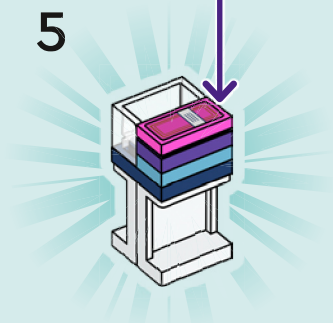
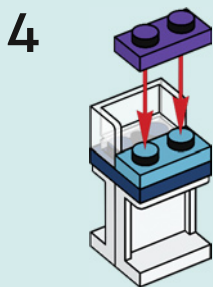
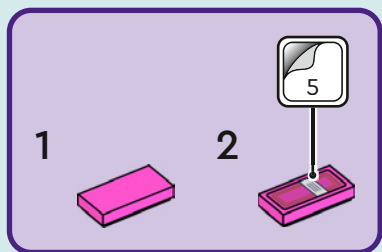

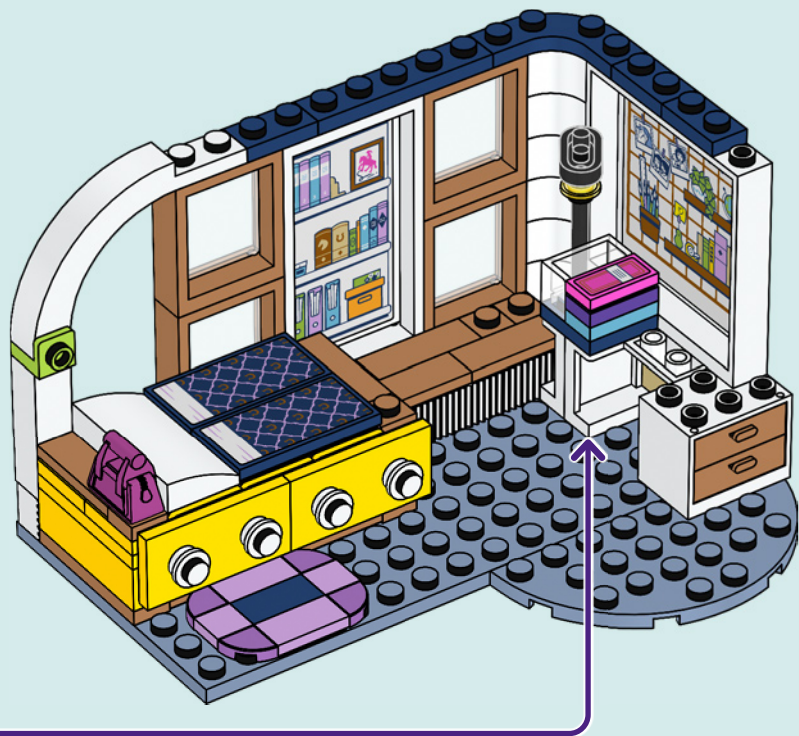

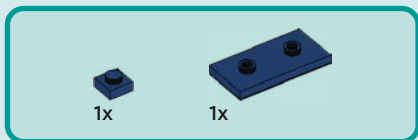

41





1x



1x

42





1x



1x

43

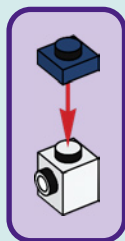



1x



1x

44

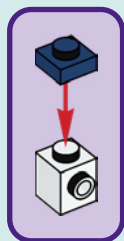



1x



1x



45





1x

46



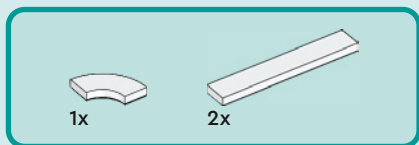

47





1x



1x



1x

48



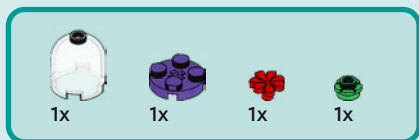

49

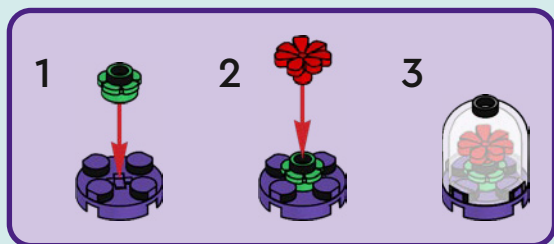

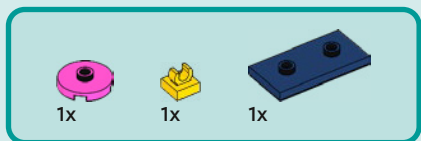

50





1x



1x

51

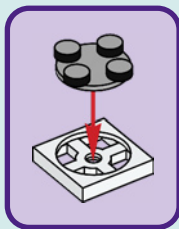



3x

52

1



2



3x





1x



1x

53





1x



1x



1x

54

1



2



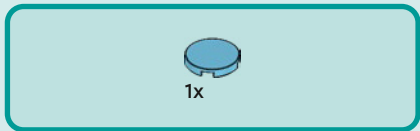

55

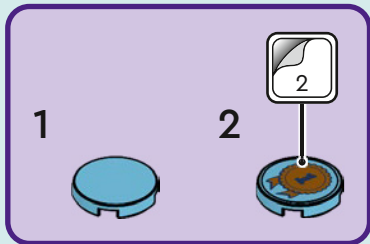



1x



1x

56

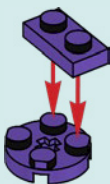

2x

57

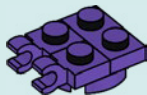



2x

58

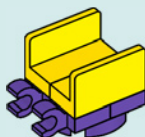

1x



1x

59

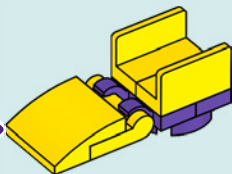
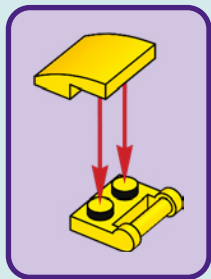

60

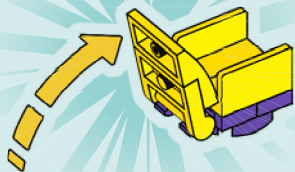



1x



1x

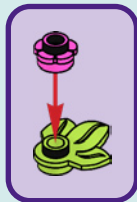

61





2x



2x

62



2x





1x

63



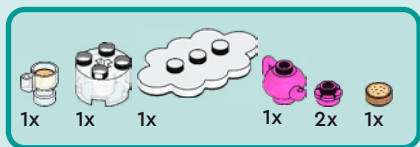

64

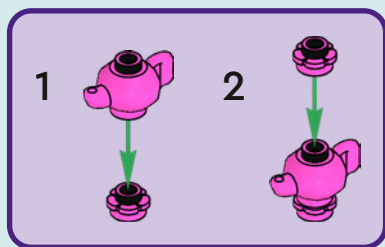

1



2



3







1x



1x



1x

65

1

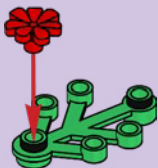

2



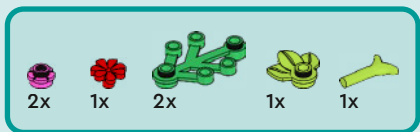

66

1

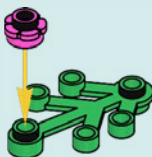

2



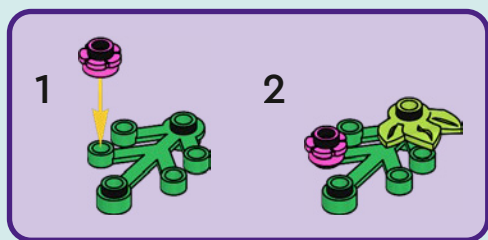

3

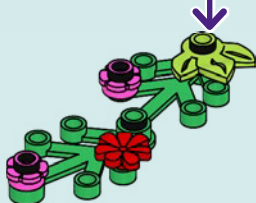

4

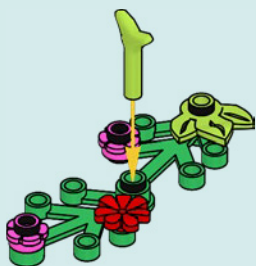







Friends



LEGO

Friends

PAISLEY

AUTUMN

ALIYA

ZAC



LEO

LIANN

OLLY



NOVA





Friends

41731



41728



41743





6x
614101

1x
625401

3x
4558952

1x
302401

1x
6055541



1x
6253658

6x
4567449

2x
6256077

1x
4600294

4x
287701

2x
4585458

1x
306901

1x
6285777

1x
6329599

1x
6157985

2x
6347309

1x
6366391

1x
368001

1x
6172674

1x
302201

1x
6256050



1x
6223667



1x
4619665



1x
4558208



1x
6262945

2x
4583297

2x
663601

1x
6185956



1x
4504228

1x
611201

1x
4113915

1x
4218749

2x
4162465

1x
4112982

5x
6182260



1x
6348056

2x
6146219

3x
6208753

1x
4501232



1x
6079007

2x
6057457

2x
371024

2x
6424448

1x
303224

2x
303424



1x
6170421



1x
4529236



1x
6210270



1x
6370669



1x
302126



1x
6306748



1x
6286876



1x
6273152



1x
6248909



4x
6278710



4x
4616711



1x
6329699



1x
4177932



1x
6135287



3x
6268814



2x
6357616



1x
6340333



1x
6350724



1x
6395609



1x
6416663



1x
6428467

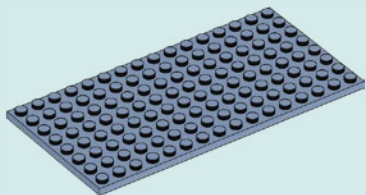

1x
6424449



1x
6424447



1x
4568637



1x
4540203



1x
4244627



1x
6251044



1x
6240225



1x
6240216



1x
6409769



2x
6365620



1x
6258352



1x
6258353



6x
6286831



1x
6420268



1x
6416470



1x
6382577



1x
6101858



3x
4184108



3x
4528981



3x
4528488



1x
6037890



1x
6361984



2x
6357956



2x
4569836



1x
6384913



5x
6209679



1x
6133667



2x
6223767



1x
6056381



2x
6056261



1x
6416612



1x
6416464



2x
6347297



2x
6030534



2x
4655695



1x
6141902



1x
6416490



1x
6429226



1x
6186672



1x
6173139



1x
6173109



1x
6409768



1x
6287854



5x
6215606



5x
6365746



4x
6422086



2x
6126118



2x
6167700



1x
6102995



1x
4624473



4x
6145255



1x
6097419



1x
6213681



4x
6199893



2x
6211403



2x
6345796

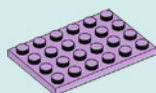

1x
6334052



LEGO.com/service

YOU COULD

WIN



Scan this QR code or go to
LEGO.COM/PRODUCTFEEDBACK
and give us your short feedback
about this LEGO® set for a chance
to win a cool LEGO prize.

Terms and Conditions apply*

DE: Du könntest GEWINNEN. Es gelten die Teilnahmebedingungen* **FR: Tu pourrais GAGNER.** Des conditions s'appliquent* **IT: Potresti VINCERE tu.** Termini e condizioni sono applicabili* **ES: Puedes GANAR.** Aplican términos y condiciones* **PT: Poderá GANHAR.** Aplicam-se termos e condições* **JA: プレゼント付き! 利用規約が適用されます*** **ZH: 轻松获奖. 条款和条件适用*** **KO: 상품의 주인이 되어보세요. 소정의 약관이 적용됩니다*** **RU: Вы можете ВЫИГРАТЬ.** Действуют положения и условия* **PL: Szansa na WYGRANĄ.** Obowiązują warunki korzystania* **CS: Máte šanci VYHRÁT.** Platí všeobecné smluvní podmínky* **SK: Máte šancu VYHRÁT.** Platia všeobecné zmluvné podmienky* **HU: TE IS NYERHETSZ.** Felhasználási feltételek érvényesek* **RO: Ai putea CÂȘTIGA.** Se aplică termeni și condiții* **BG: Можете да СПЕЧЕЛИТЕ.** Има определени правила и условия* **LV: Tu vari LAIMĒT.** Ir spēkā noteikumi un nosacījumi.* **ET: Sul on võimalus VÕITA.** Kehtivad tingimused* **LT: Jūs galite LAIMĖTI.** Taikomos sąlygos*

*[LEGO.com/productfeedback-terms](https://www.lego.com/productfeedback-terms)

LEGO, the LEGO logo and the FRIENDS logo are trademarks of the LEGO Group.
©2023 The LEGO Group.

6493772