



# MONKIE KID 悟空小侠™

80032





Check for compatibility  
Kompatibilität prüfen  
Vérifier la compatibilité  
Controlla la compatibilità  
Comprueba tu compatibilidad  
Verificar a compatibilidade  
Ellenőrizd a kompatibilitást  
Pārbaudīt saderību  
检查兼容性

[LEGO.com/devicecheck](https://LEGO.com/devicecheck)



# 乐高®拼搭指引



LEGO® Building Instructions



Download on the  
App Store



GET IT ON  
Google Play



腾讯应用宝  
安卓应用商店

Apple and the Apple logo are trademarks of Apple Inc.  
Google Play and the Google Play logo are trademarks of Google LLC.  
Tencent and the Tencent logo are trademarks of Tencent Inc.



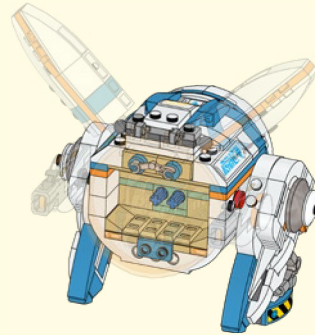
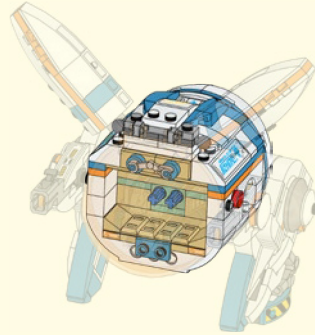
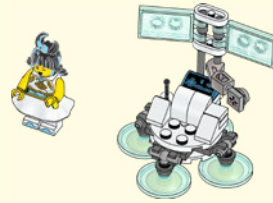

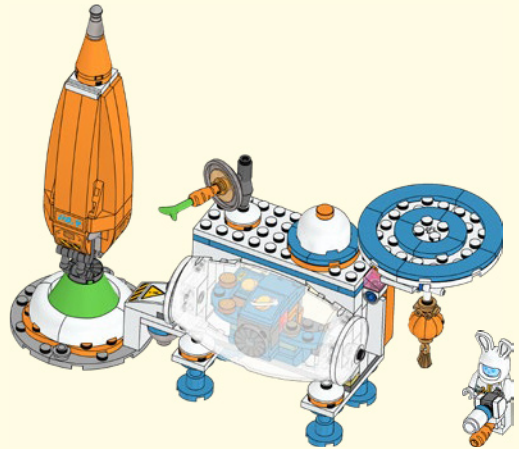
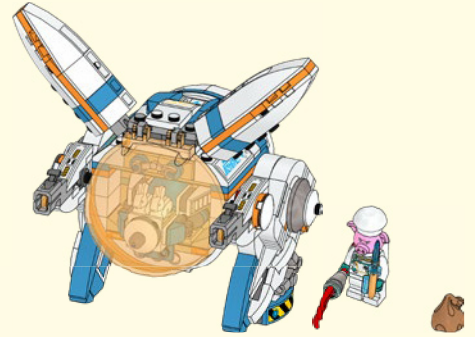



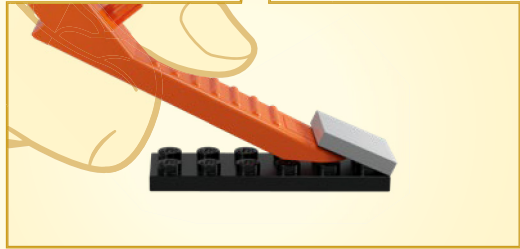
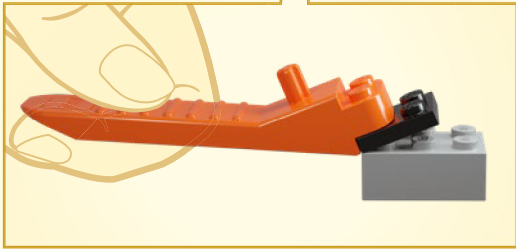
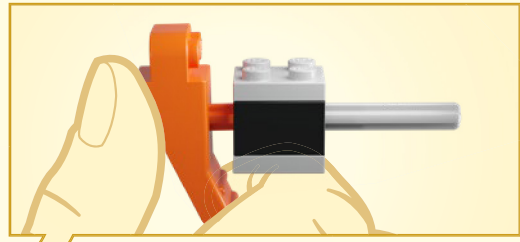
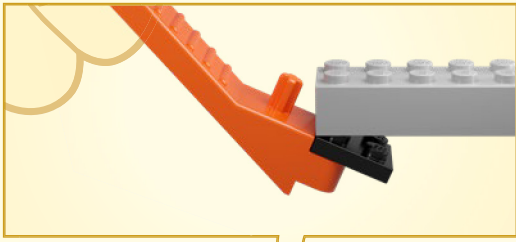





1x



1x



1x



1x



1x

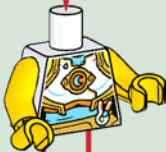





1

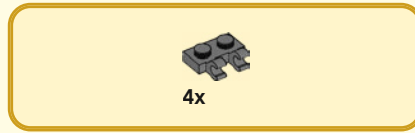

2

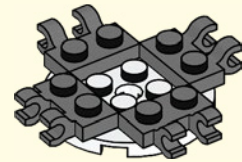



1x

3

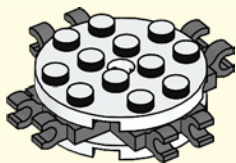

1x



2x

4

1

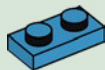

2

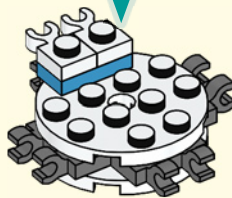
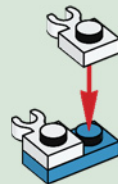



2x

5

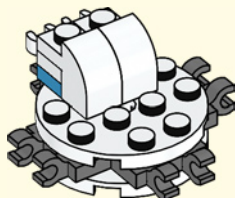

2x

6

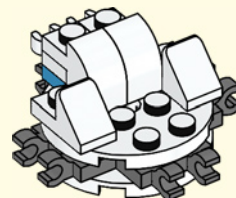



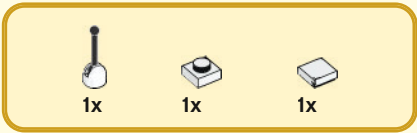

7

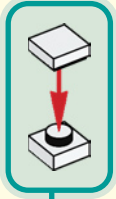

8

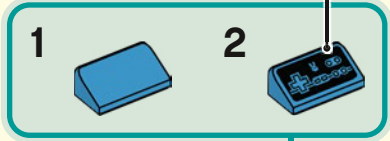

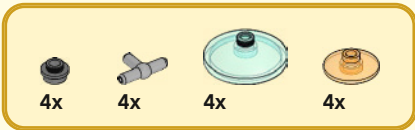

9

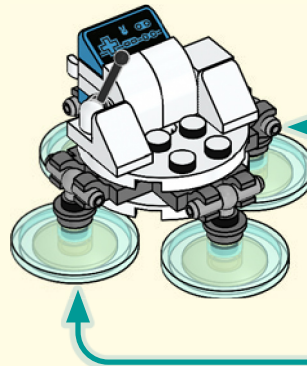
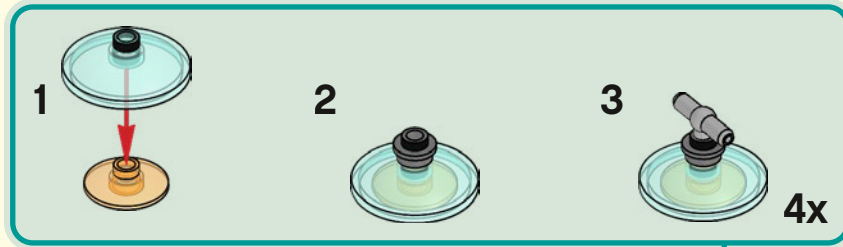

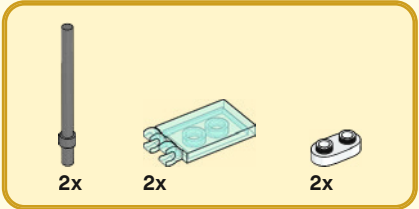

# 10

1



2

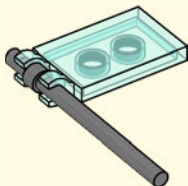

3



4

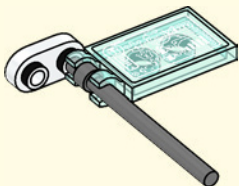

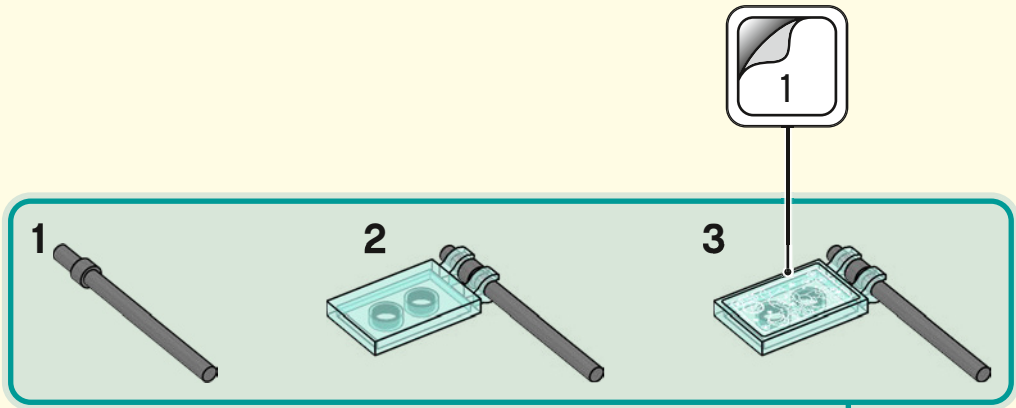

5

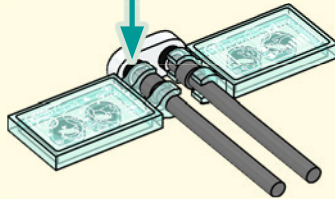

6

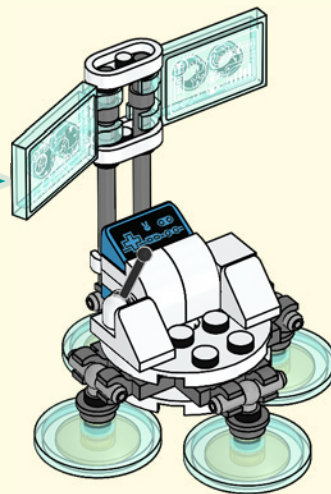
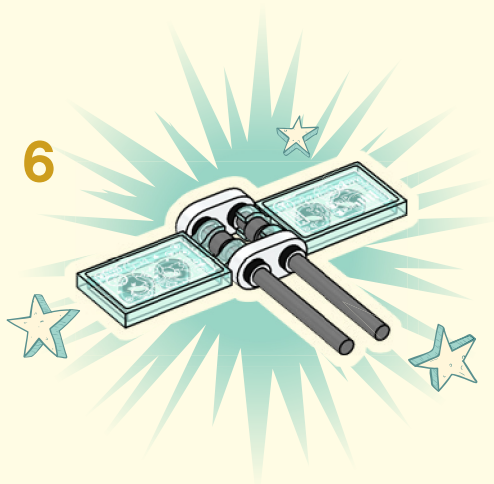



1x



1x



1x

# 11

1



2

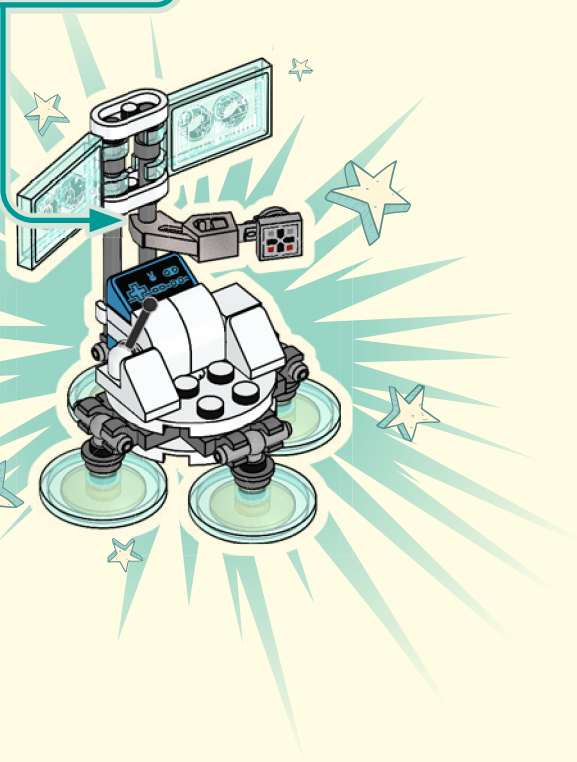





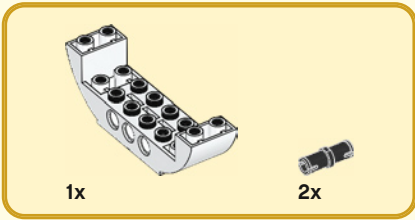
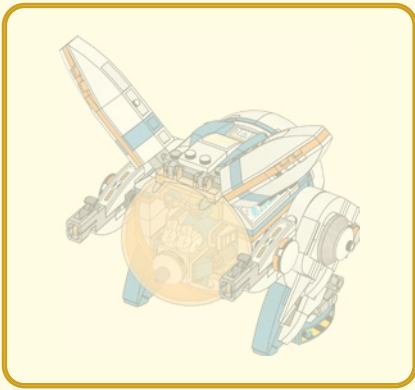

1

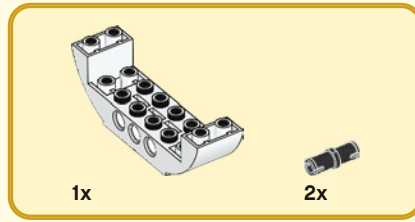
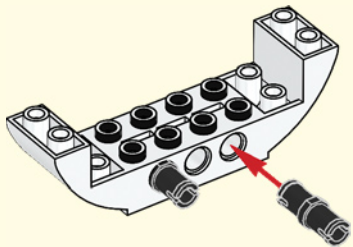

2

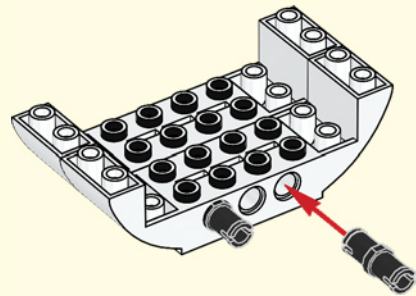

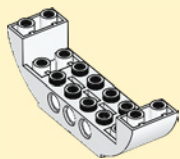

1x

3

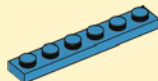
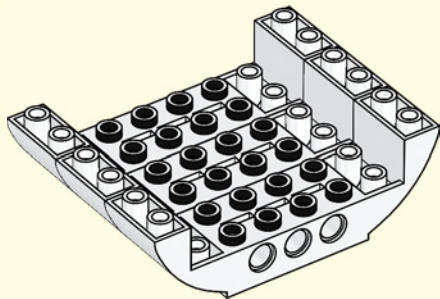

1x

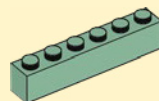

1x

4

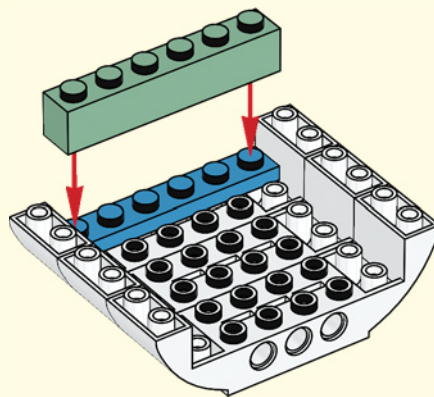

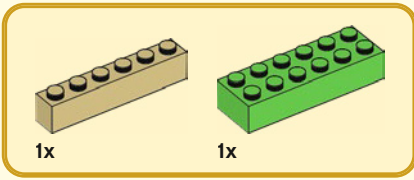

5

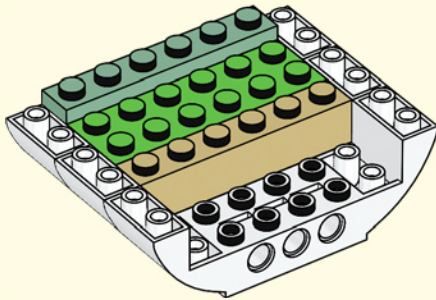

6

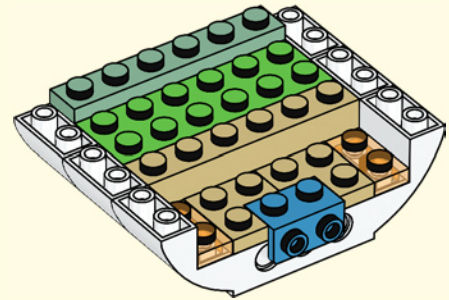



7

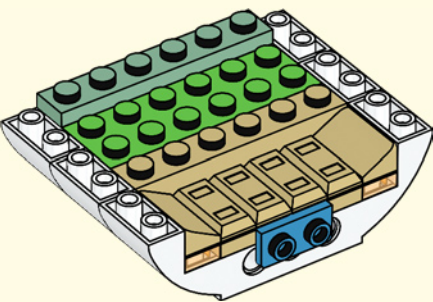

8

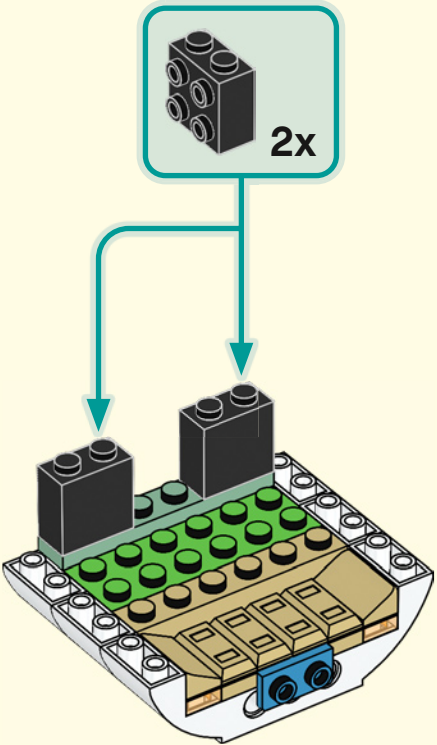



2x



2x

9

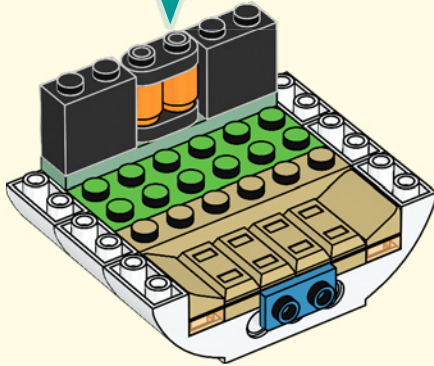

2x

10

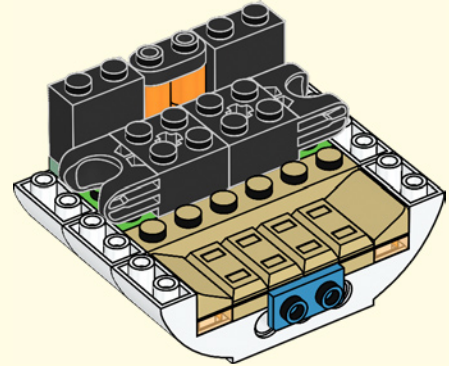





1x



2x

11

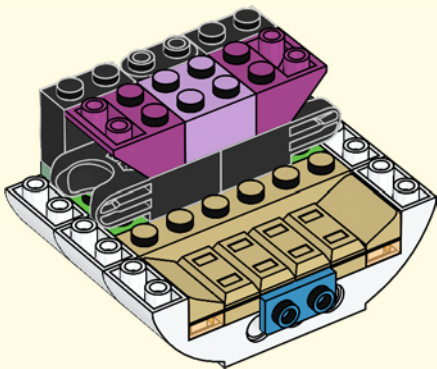

2x



2x

12

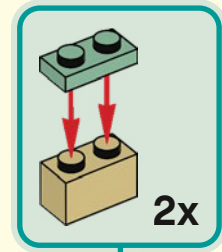

2x

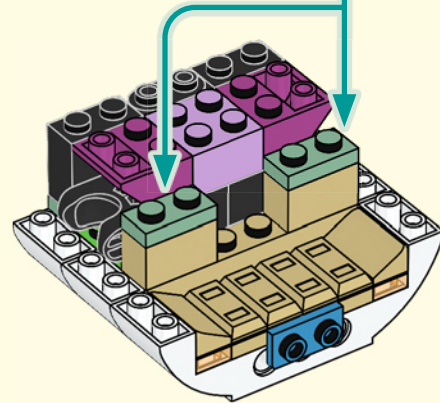



13

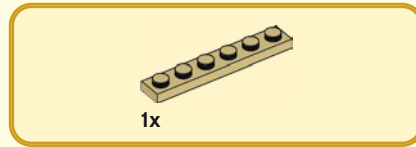
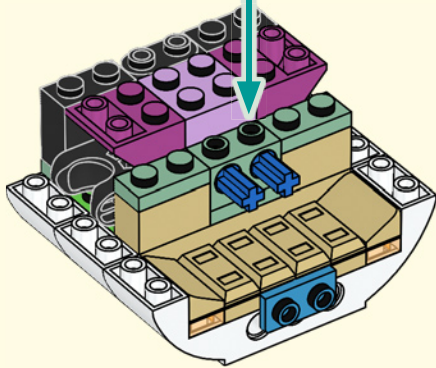
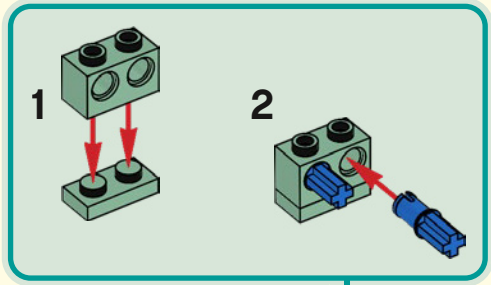

14

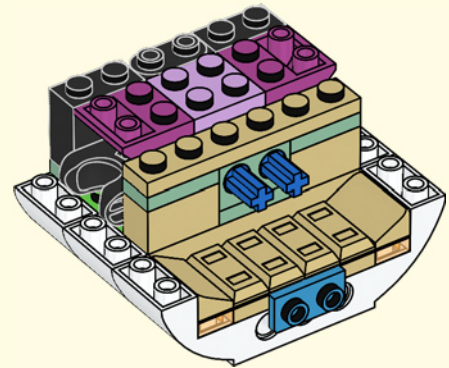

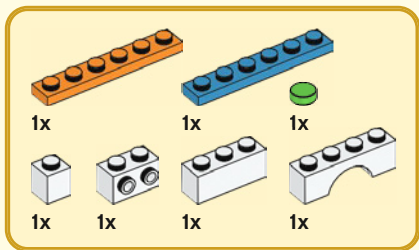

15

1

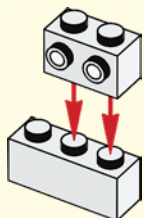

2

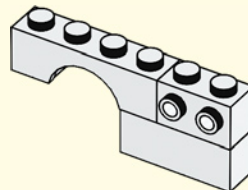

3

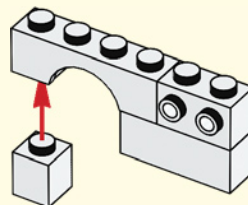

4

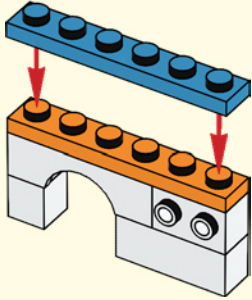

5

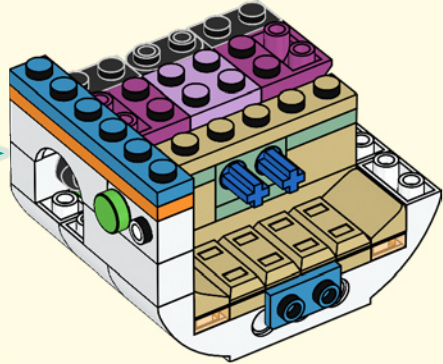
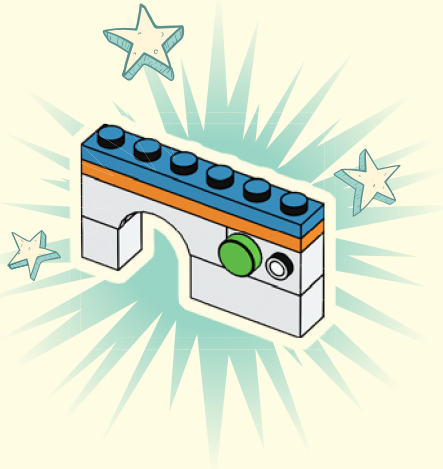

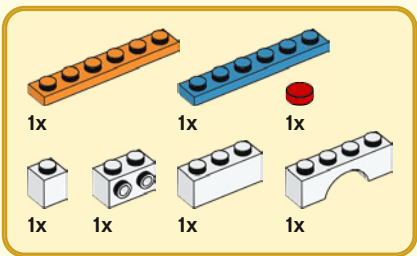

16

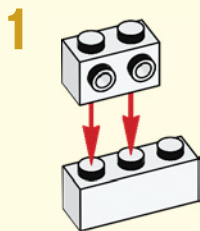

2

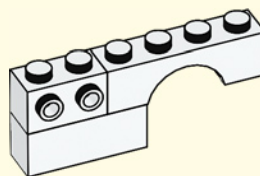

3

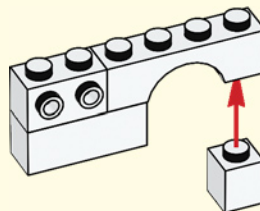

4

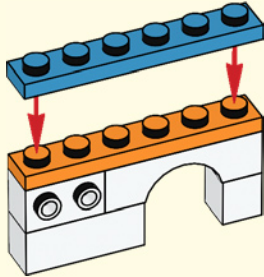

5

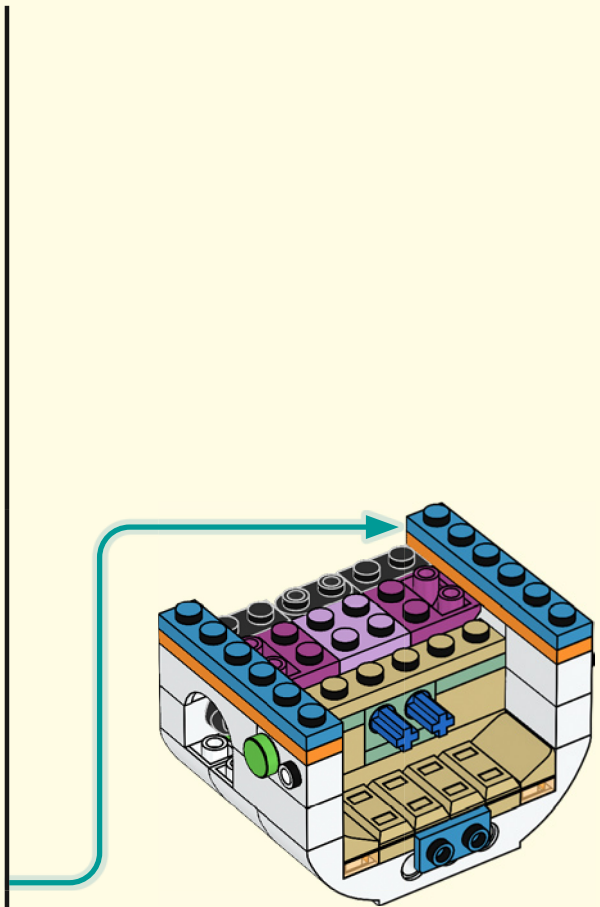
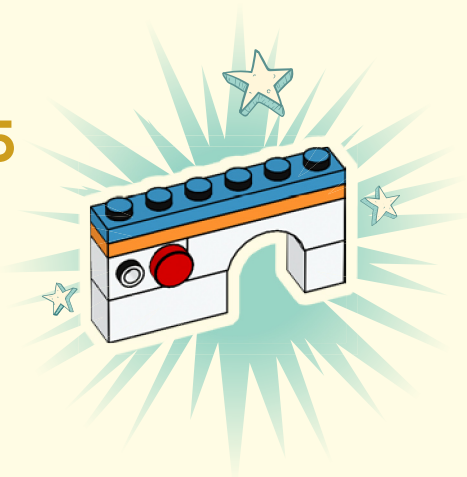



17

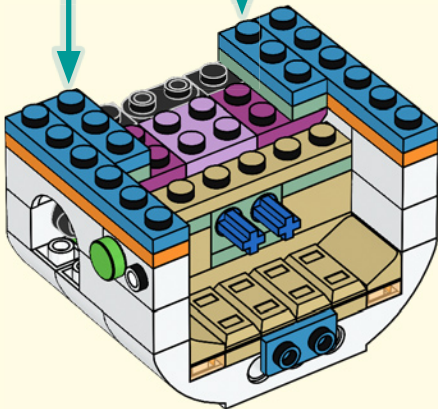
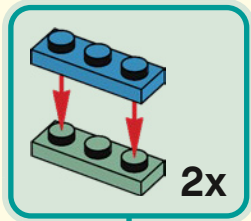

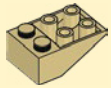

3x



1x

18

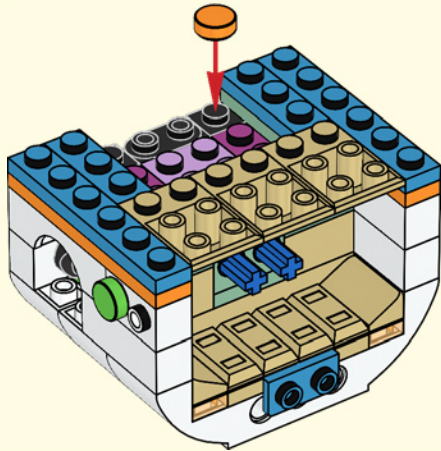

2x



2x

19

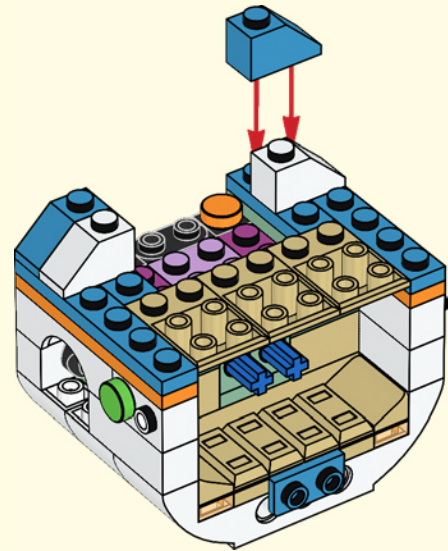



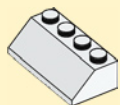

2x

20

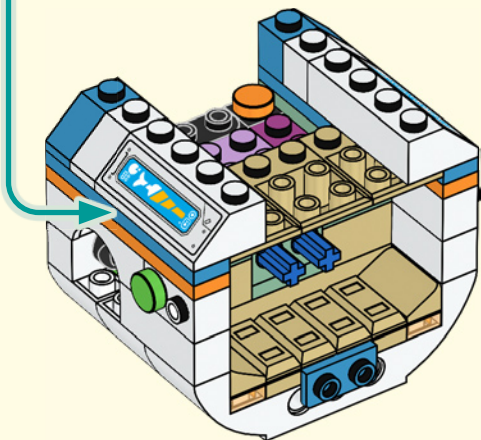
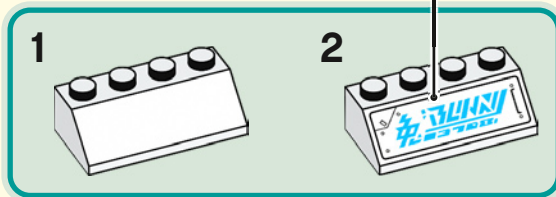
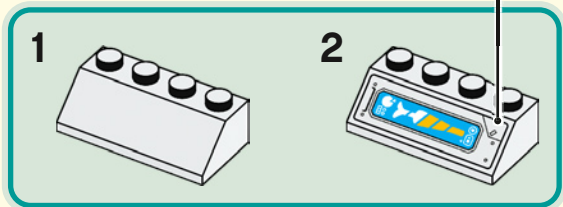

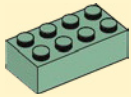

1x

21

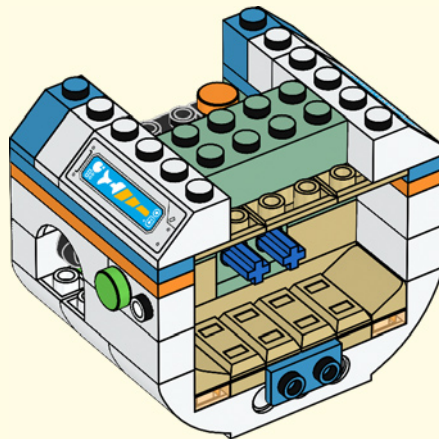

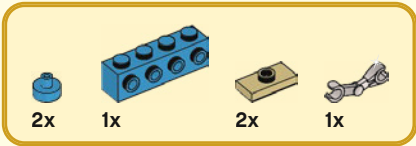

22

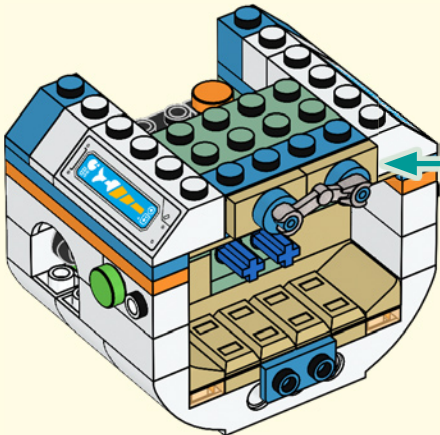
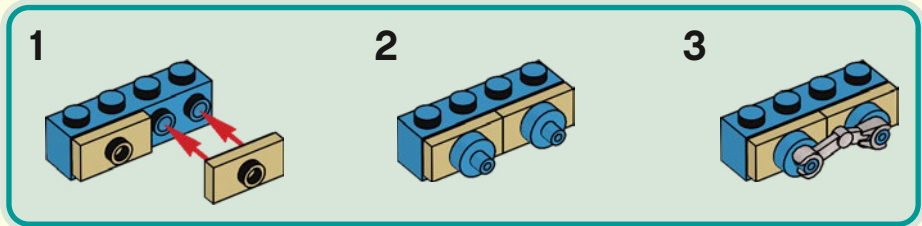



23

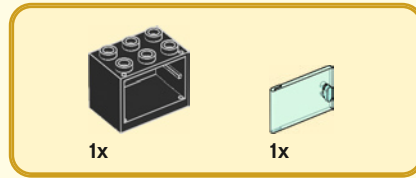
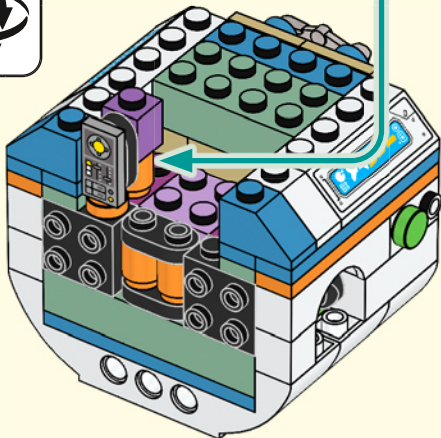
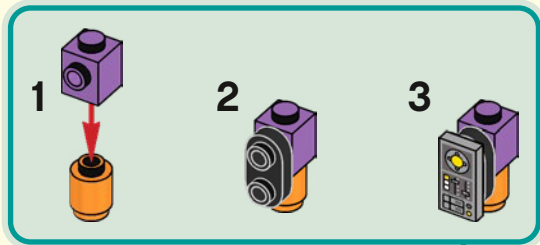

24

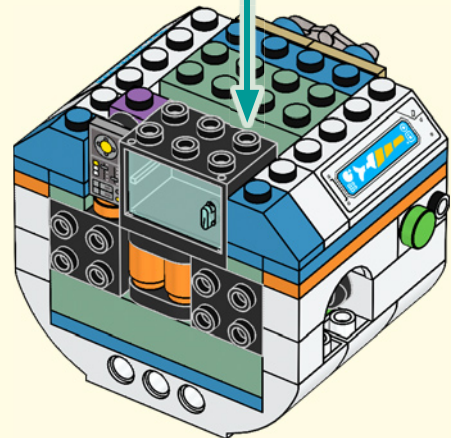
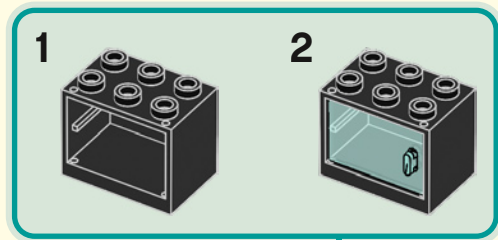



1x

25

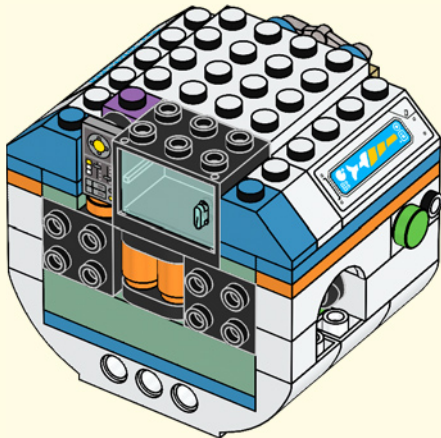

2x



2x



2x

26

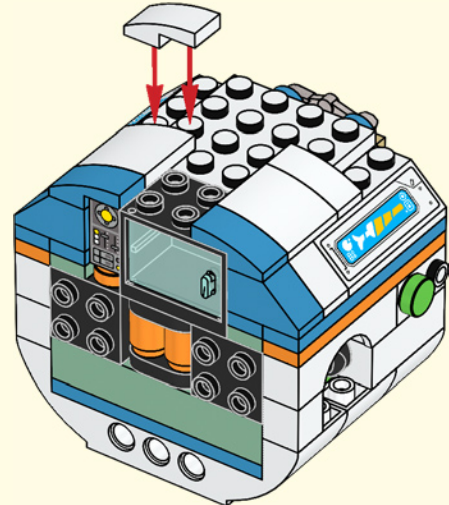



1x



1x

27

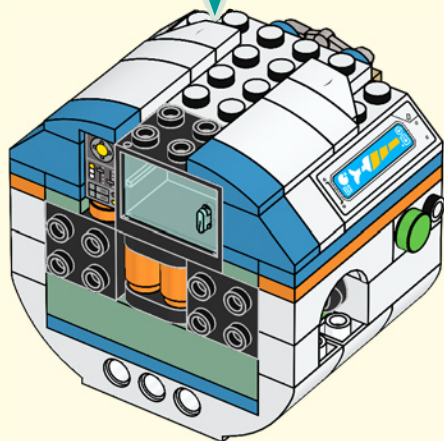

2x



1x



1x

28

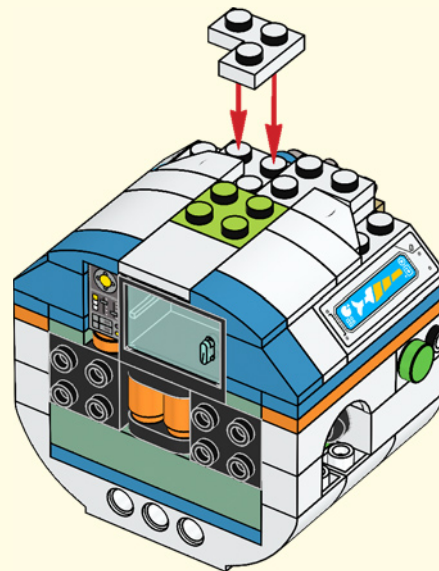

29

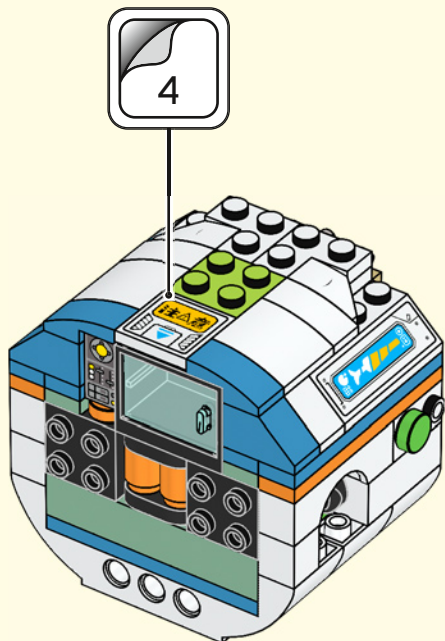

30

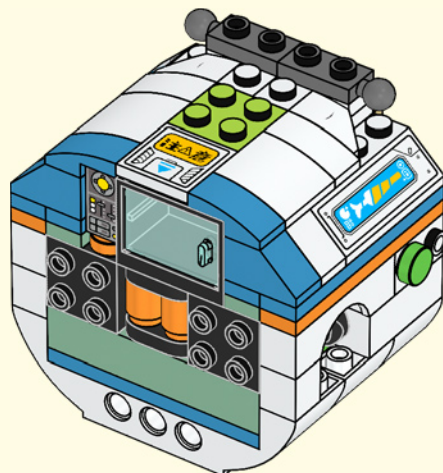





1x

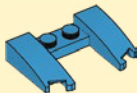

1x

31

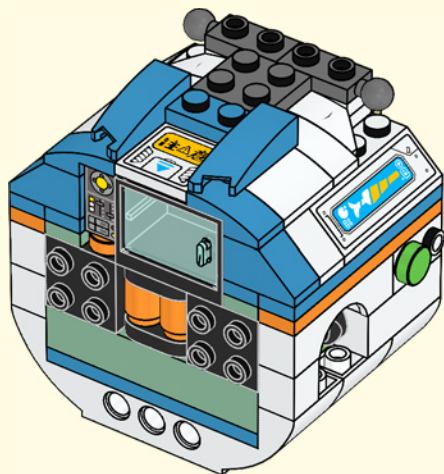

1x



1x

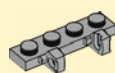

1x

32

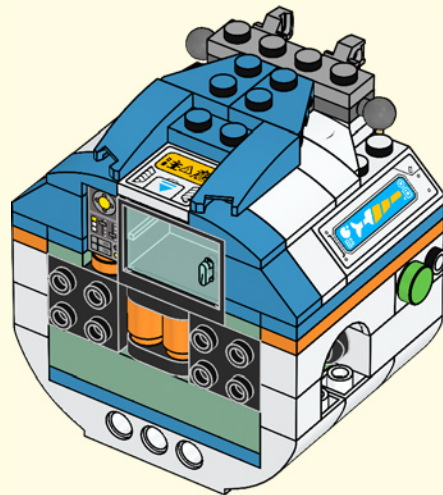





1x



1x

33

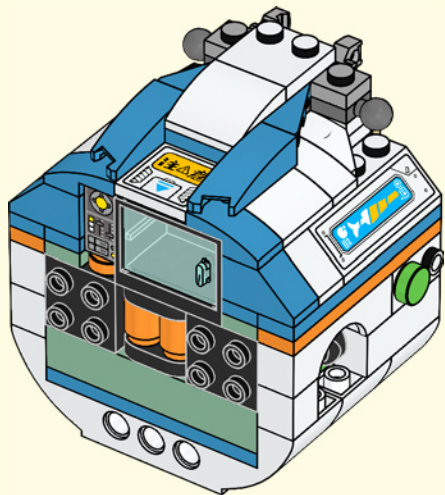

34

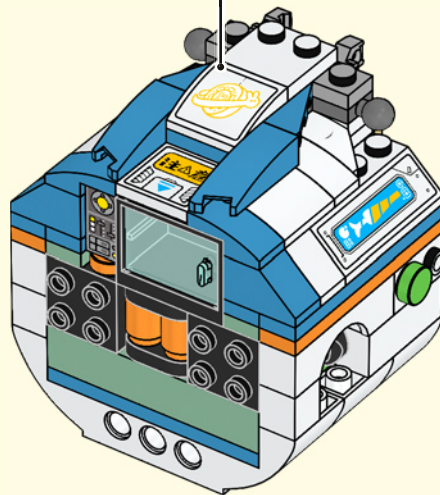

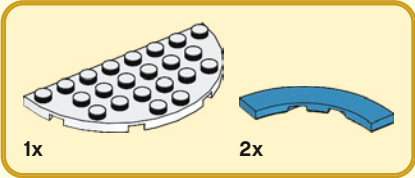

35

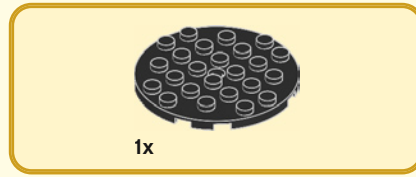
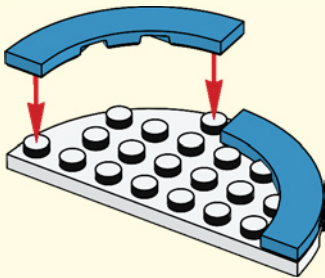

36

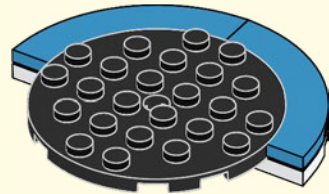



37

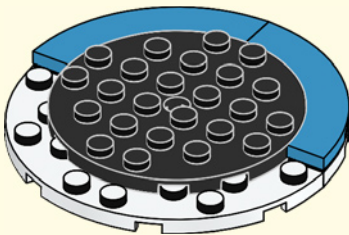

38

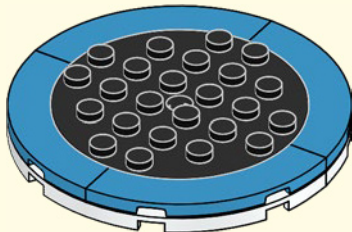

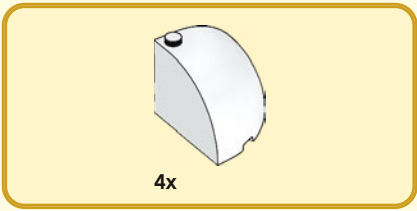

39

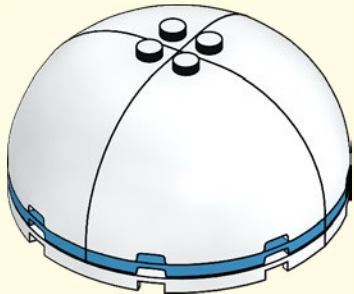

40

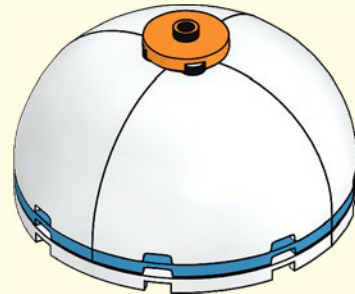



41

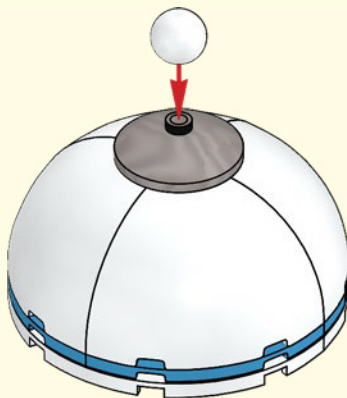

42

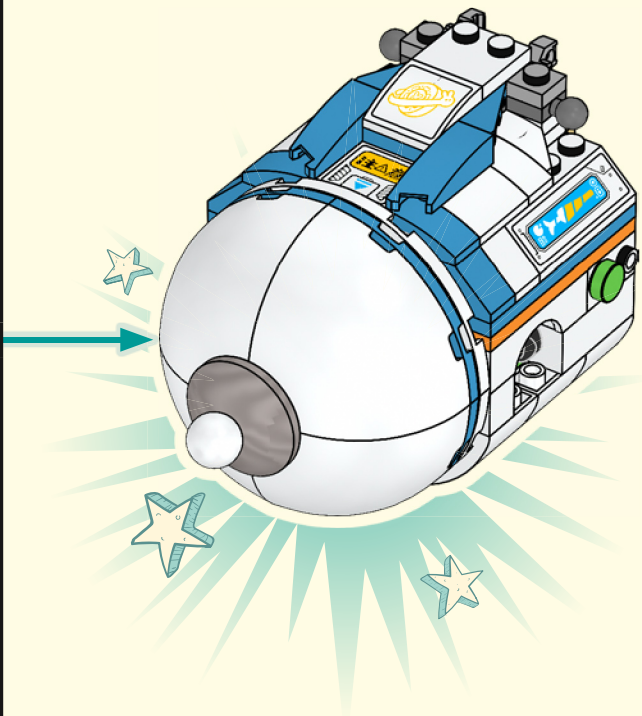



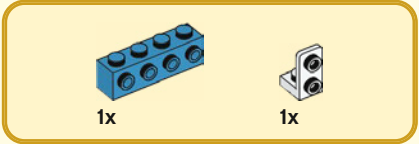
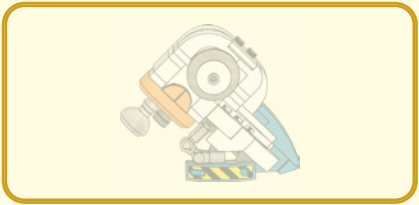

43

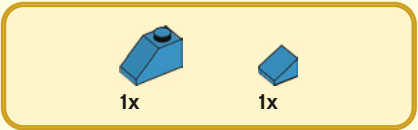
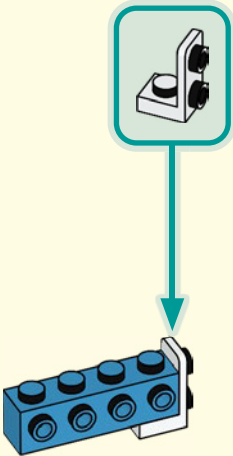

44

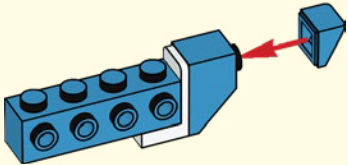

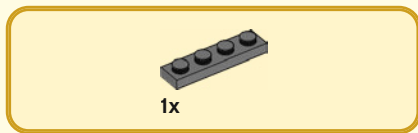

45

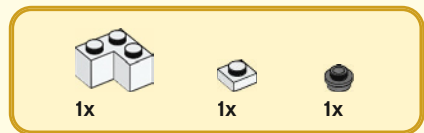
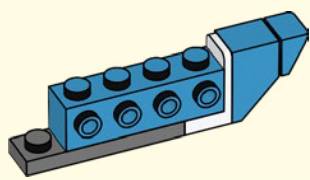

46

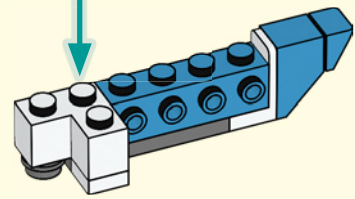
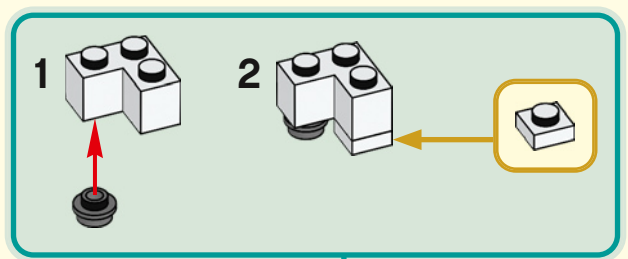



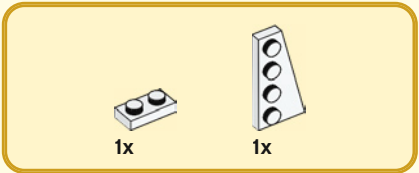

47

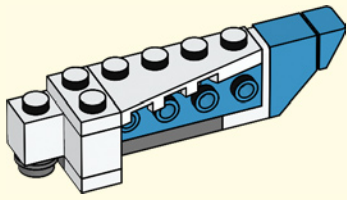

48

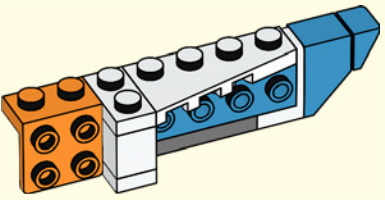

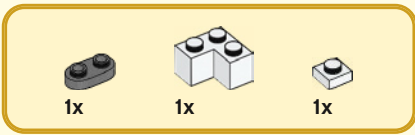

49

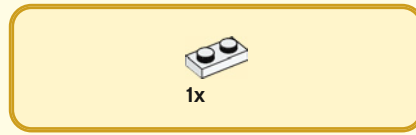
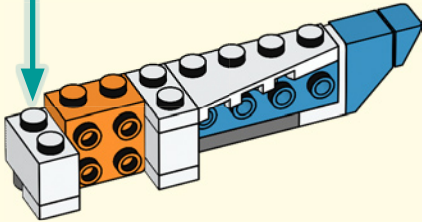
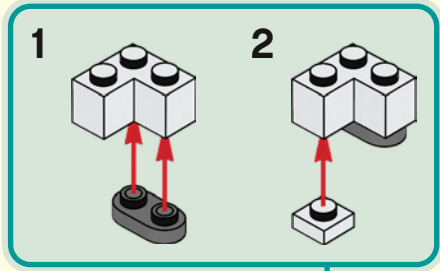

50

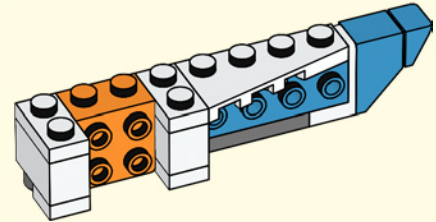

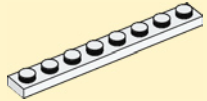

1x



1x

51

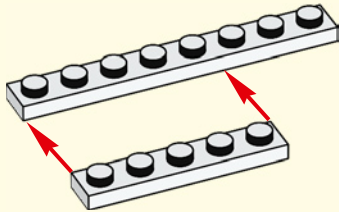

1x

52

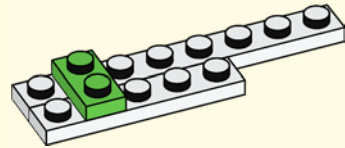



53

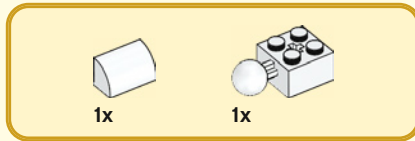
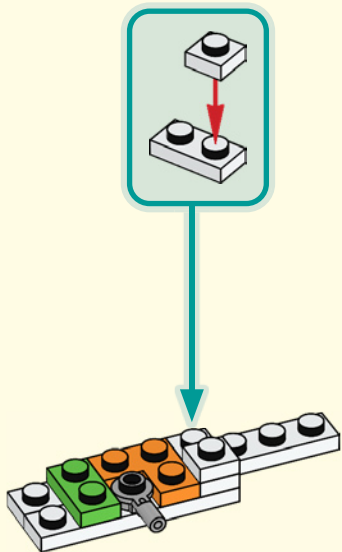

54

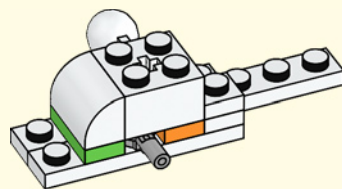

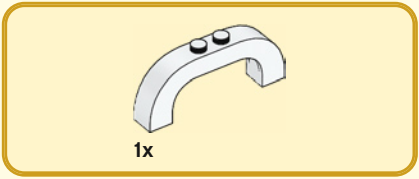

55

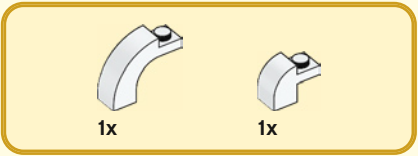
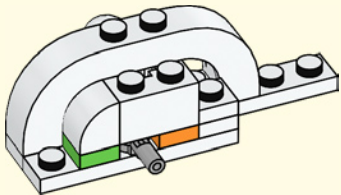

56

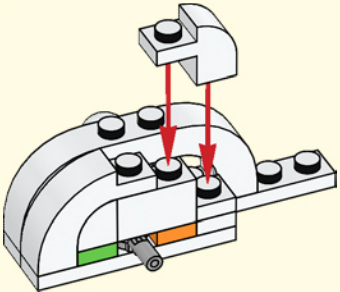

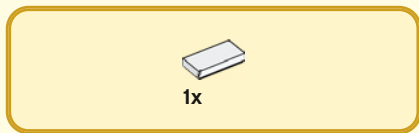

57

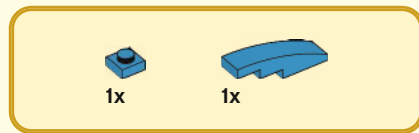
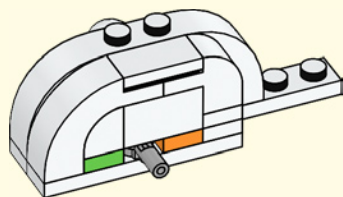

58

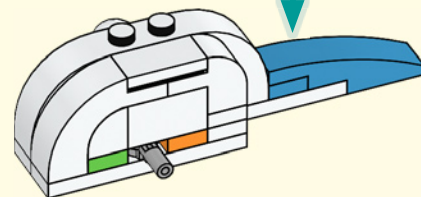
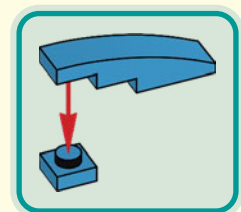

59

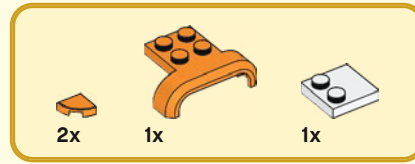
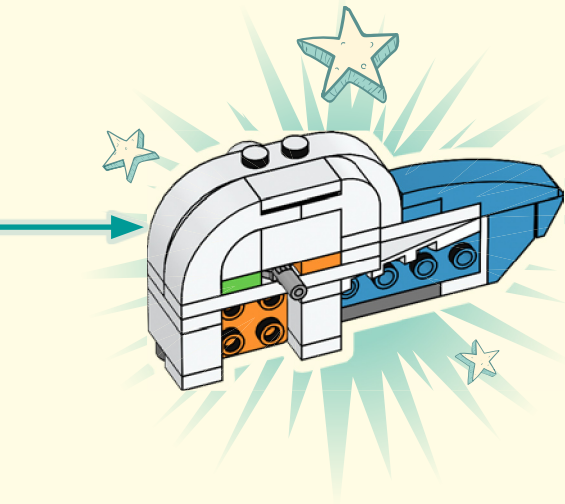

60

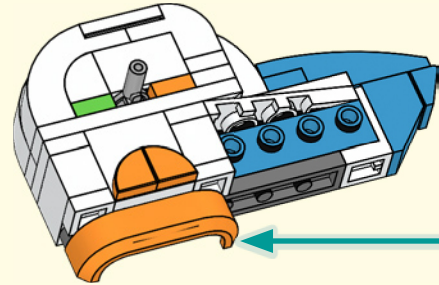
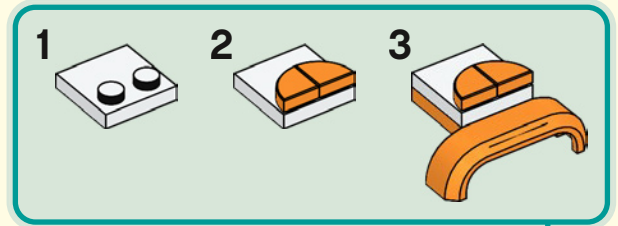

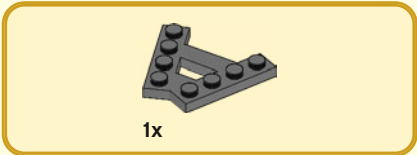

61

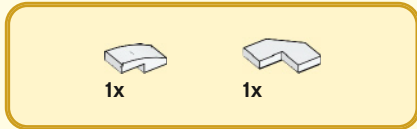
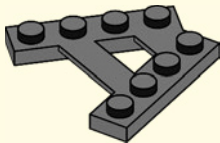

62

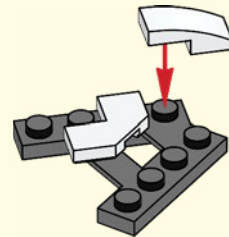





# 63

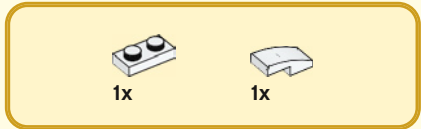
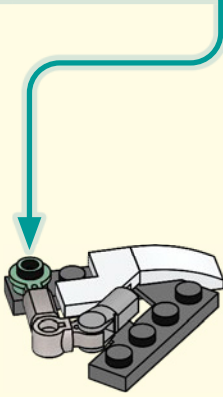
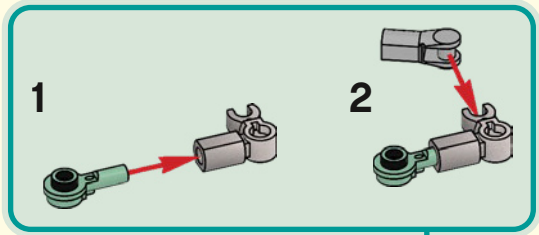

# 64

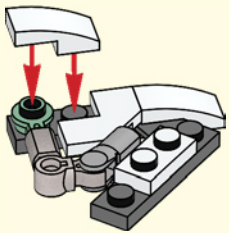

# 65

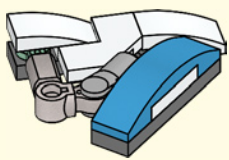

66

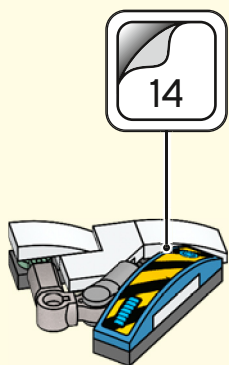

67

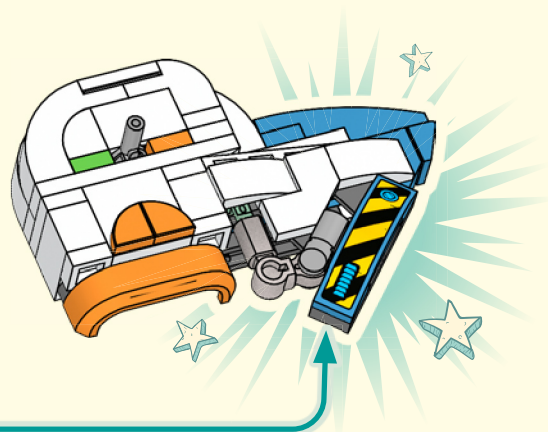

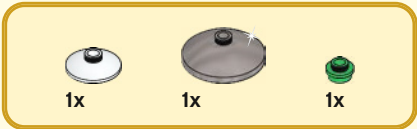

68

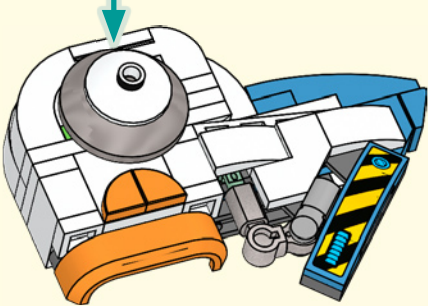
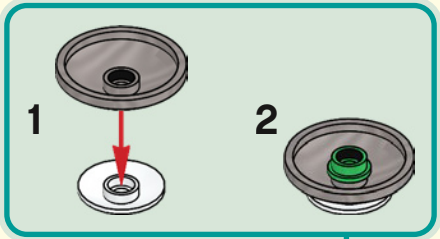

69

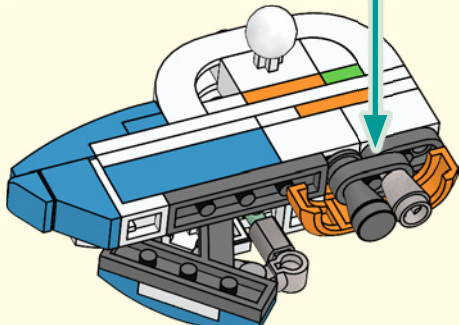
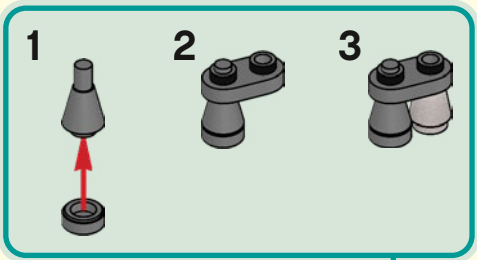



70

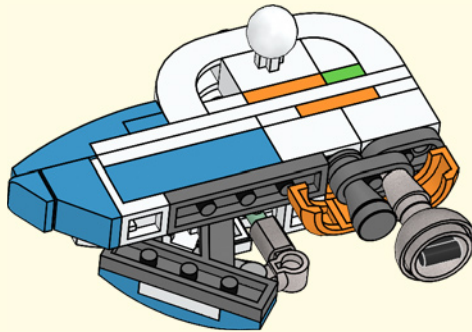
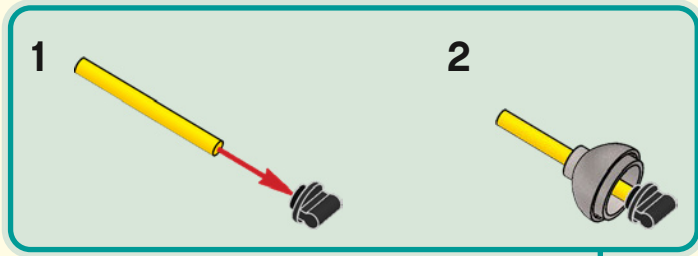

71

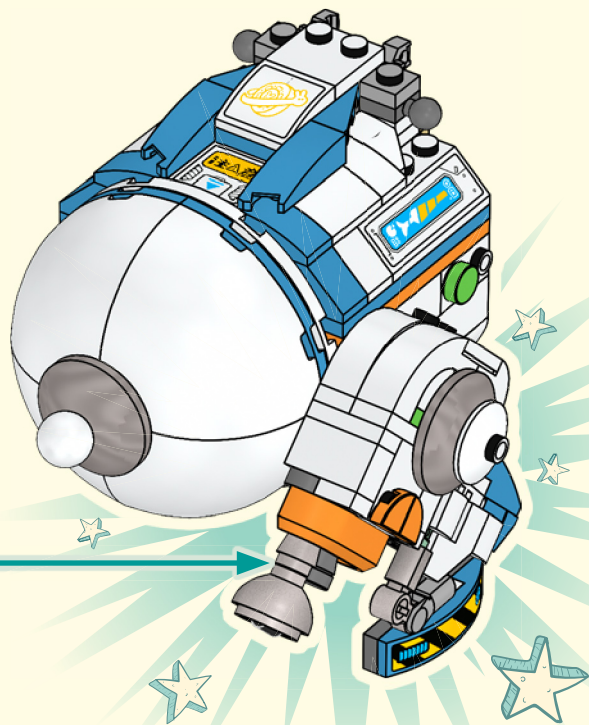

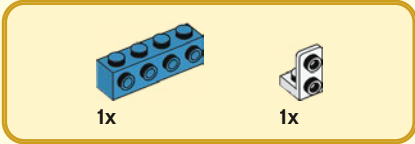
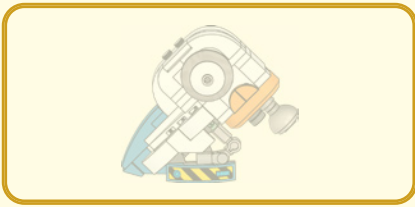

72

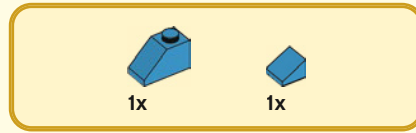
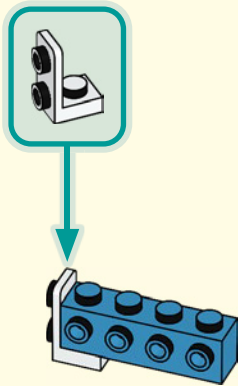

73

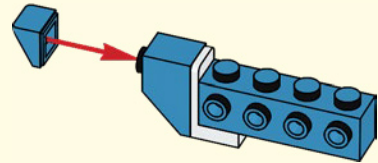

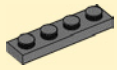

1x

74

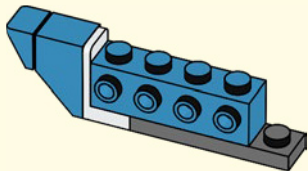

1x



1x



1x

75

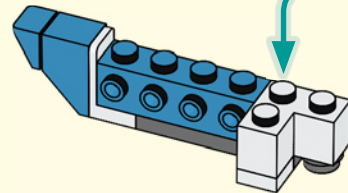
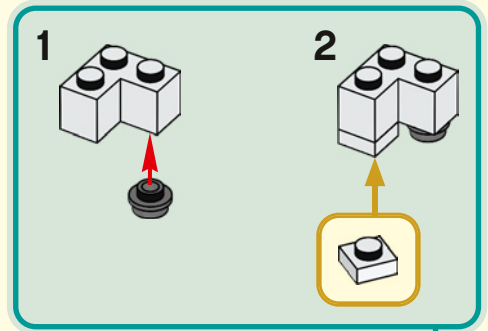

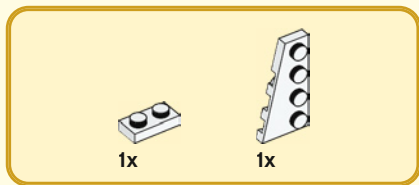

76

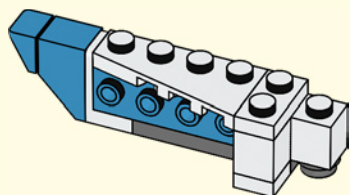

77

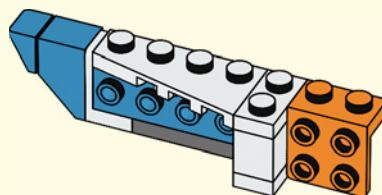



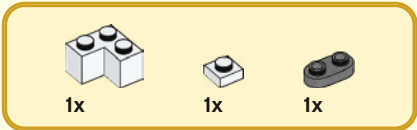

78

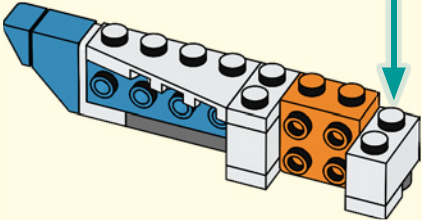
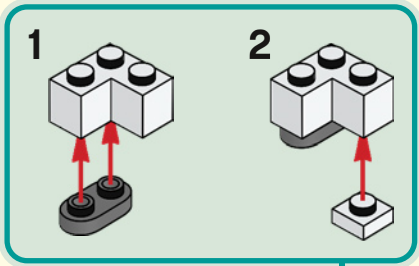

79

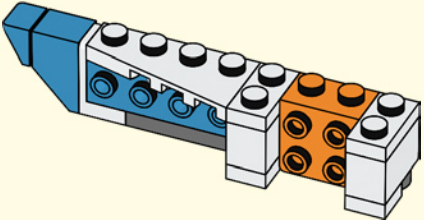

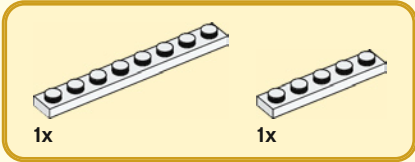
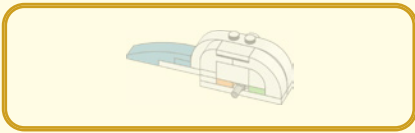

80

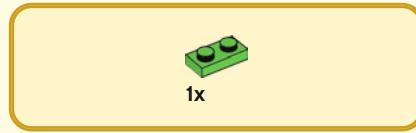
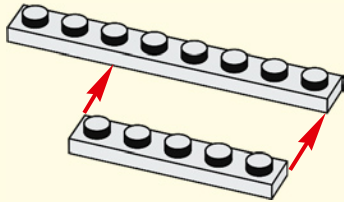

81

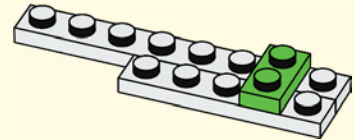



82

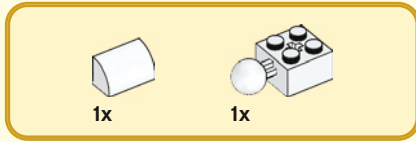
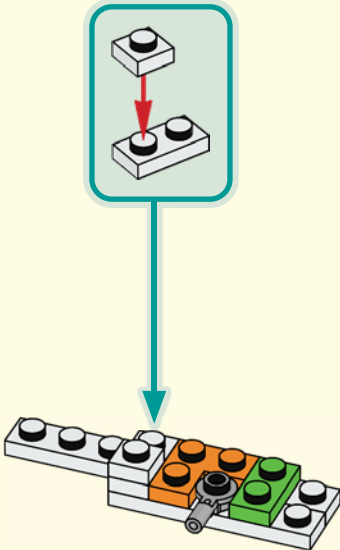

83

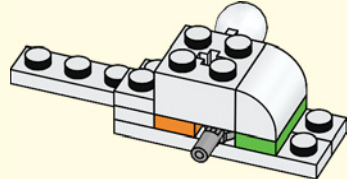

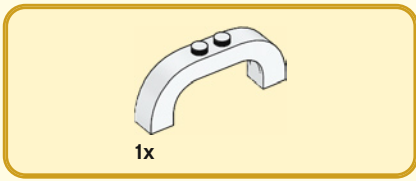

84

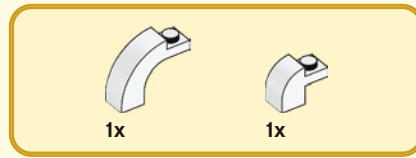
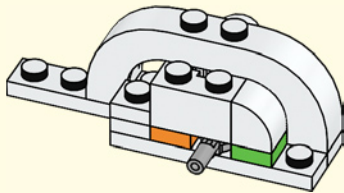

85

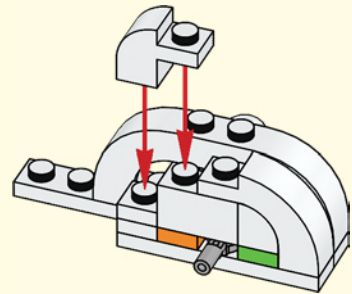



1x

86

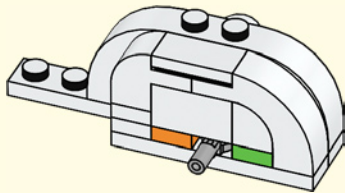

1x



1x

87

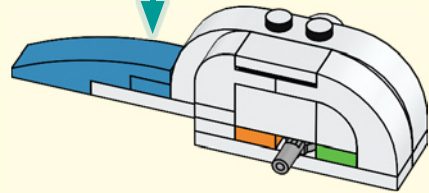
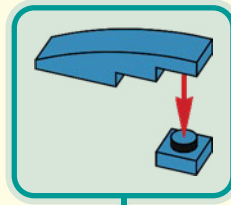

88

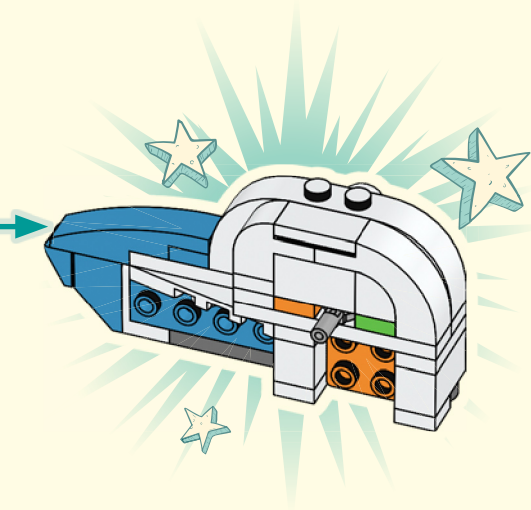

89

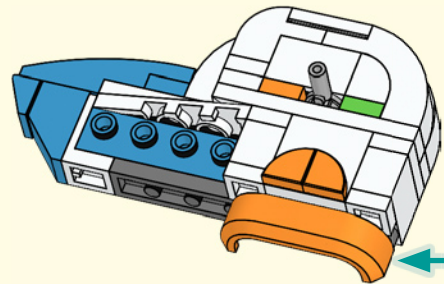
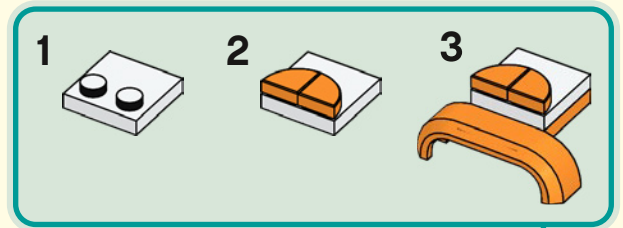

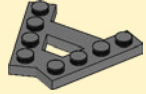

1x

90

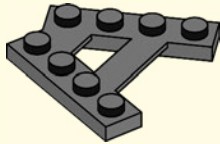

1x



1x

91

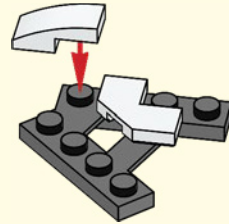



92

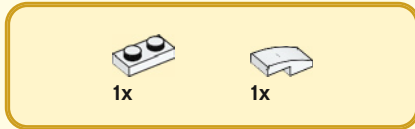
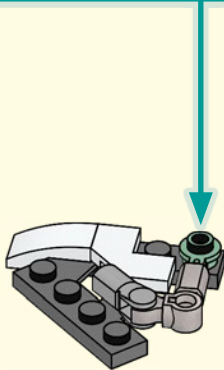
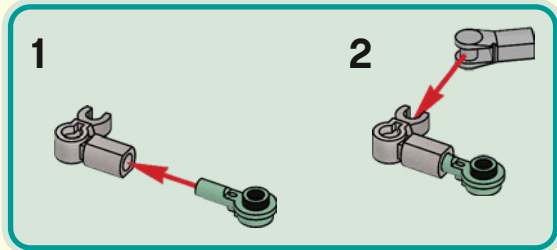

93

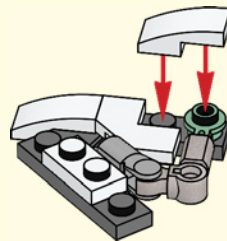





94

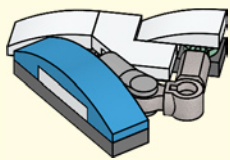

95



96

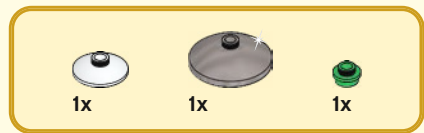
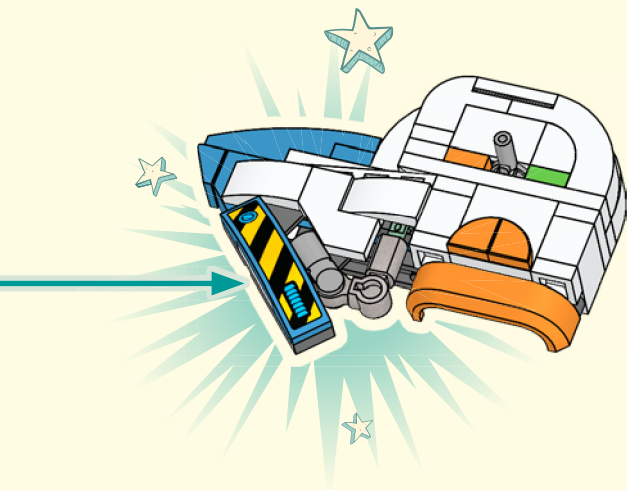

97

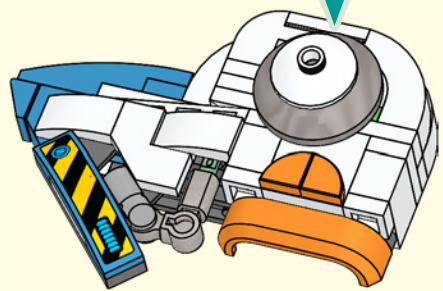
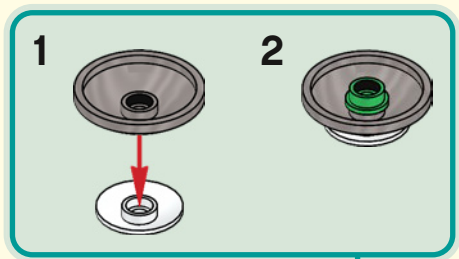



98

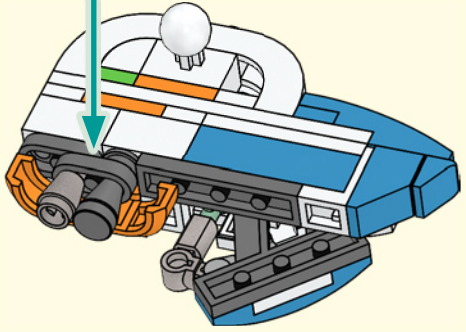
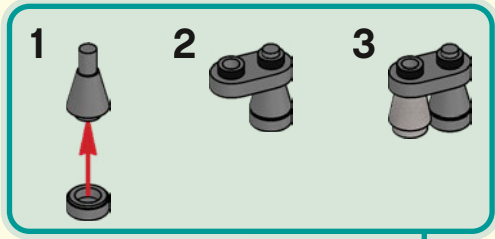

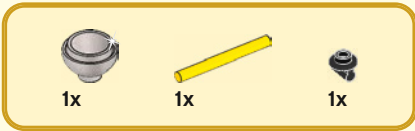

99

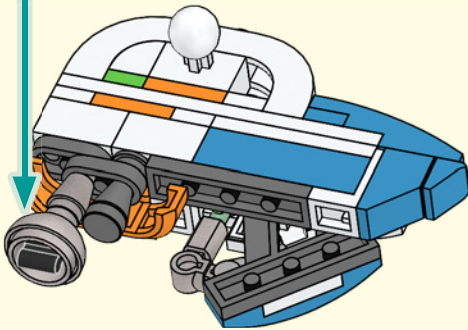
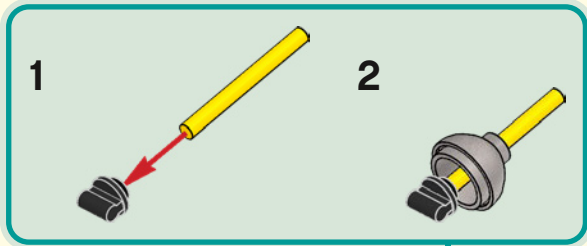

100

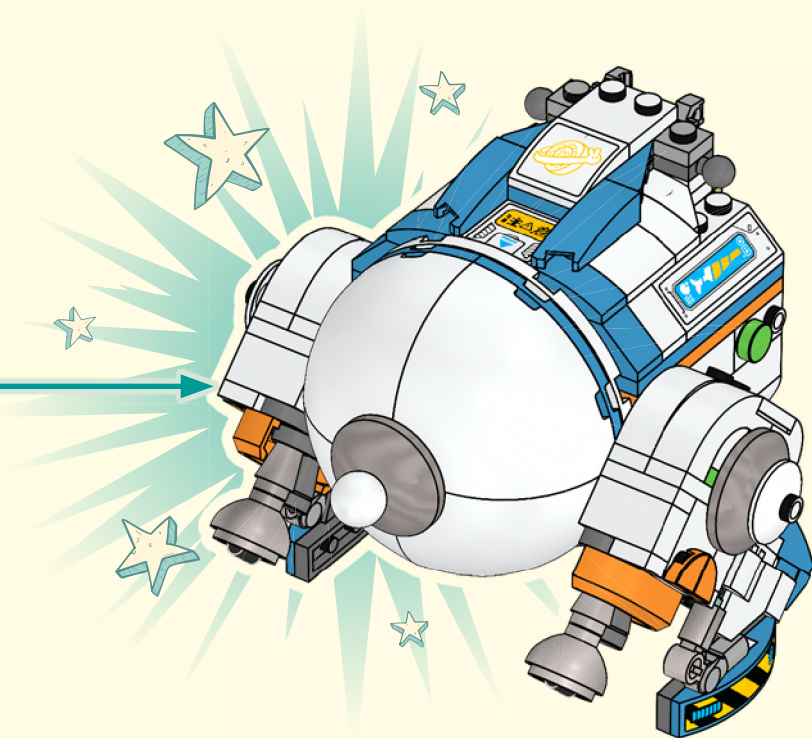



2x

101

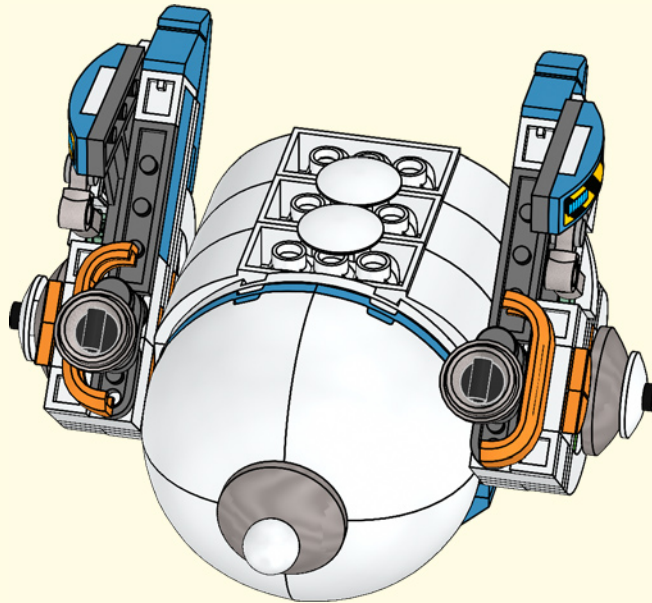



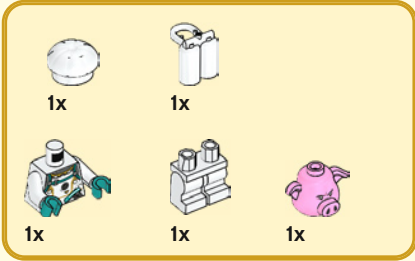

1

1

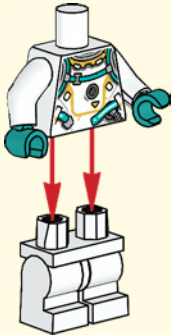

2

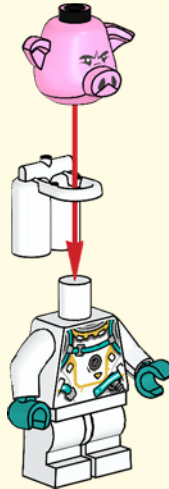

3

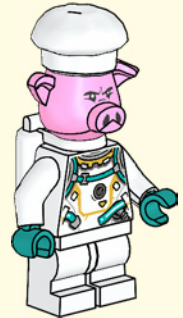





2

1

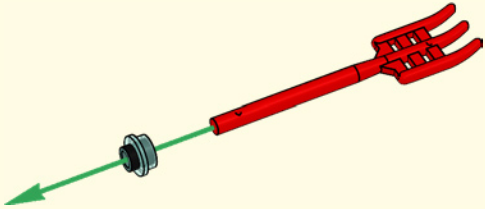

2

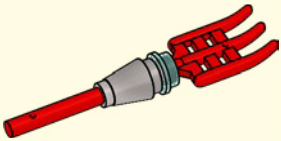

3

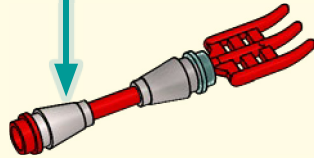
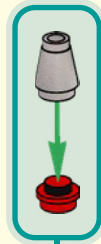

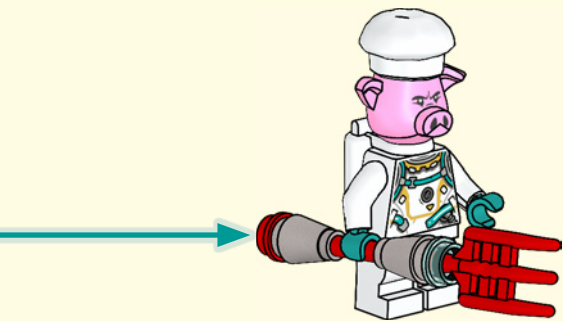

3

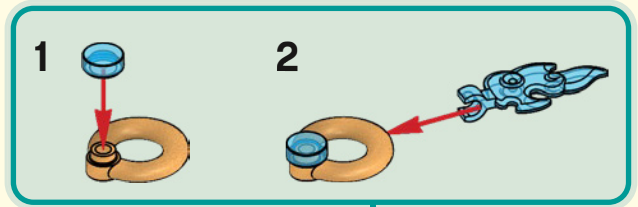

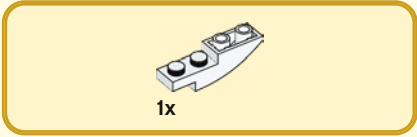

1x

102

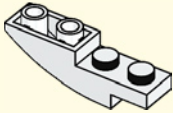

1x



1x

103

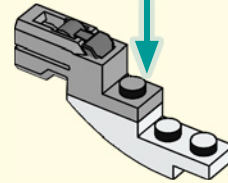
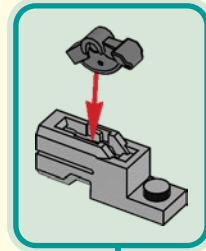



1x



1x

104

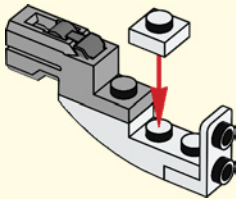

1x



1x

105

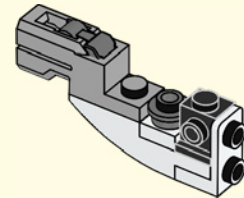



106

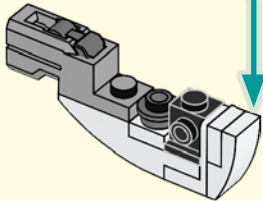
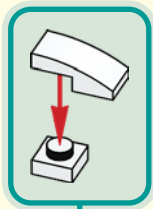

107

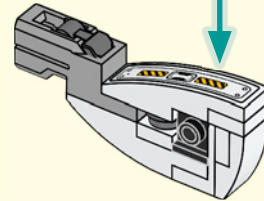
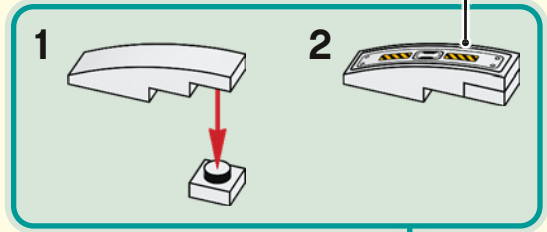



108

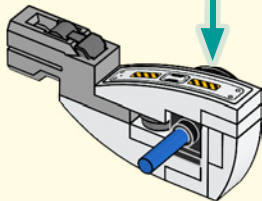
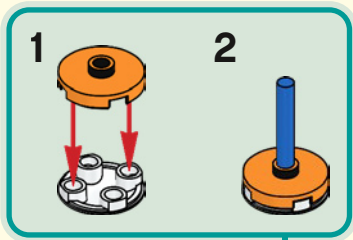

109

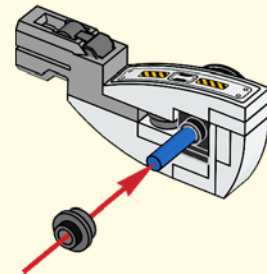

110

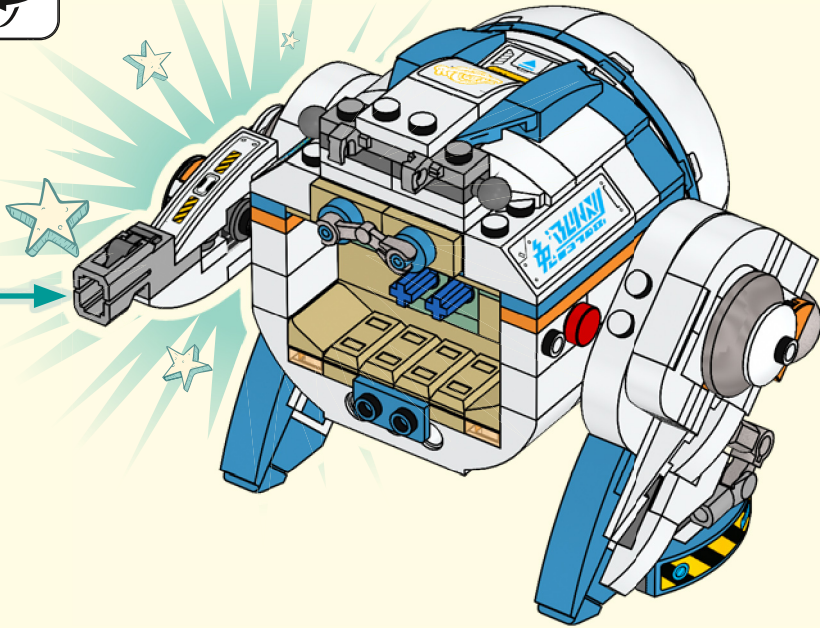

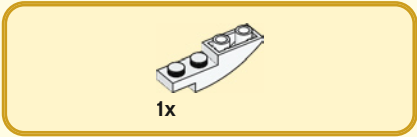

111

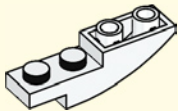

112

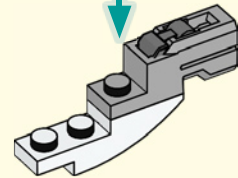
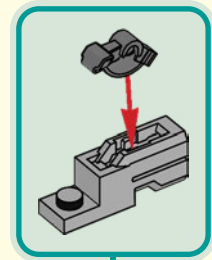





1x



1x

# 113

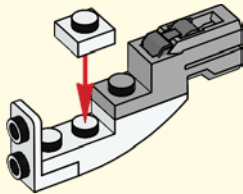

1x



1x

# 114

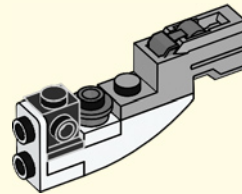



1x



1x

# 115

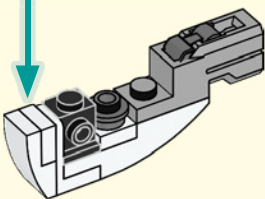
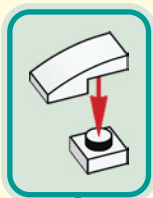

1x



1x

# 116

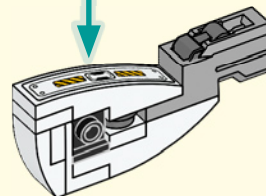
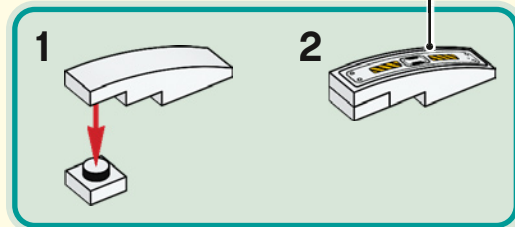



117

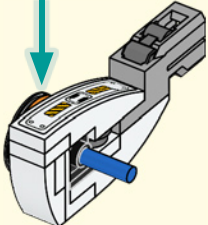
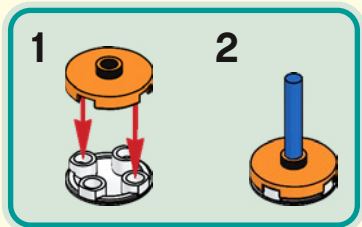

118

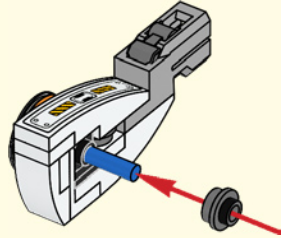

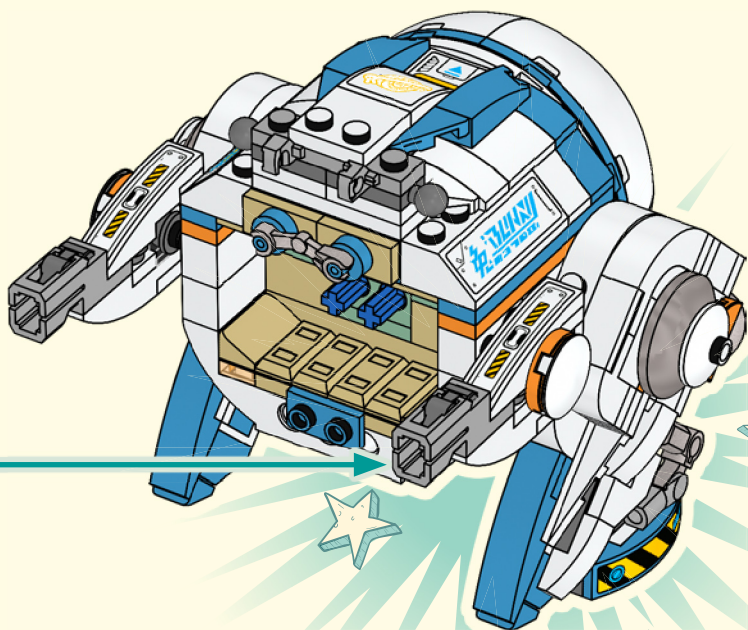

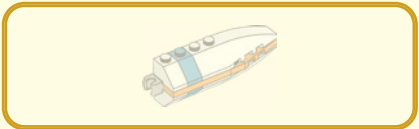

1x

1x

# 120

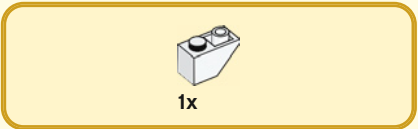
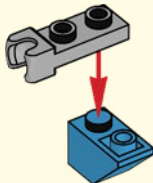

1x

# 121

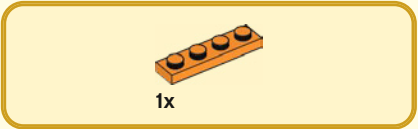
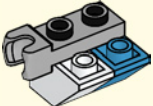

1x

# 122

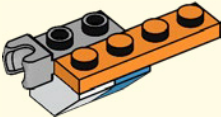

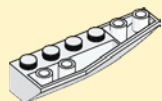

1x

123

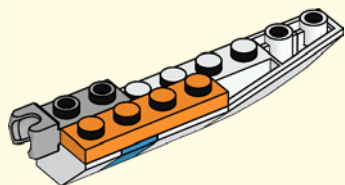

1x



1x



1x

124

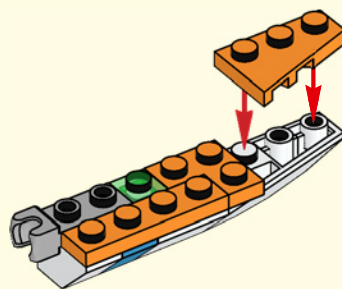



1x



1x

125

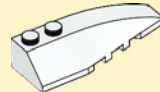
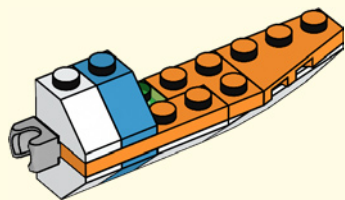

1x

126

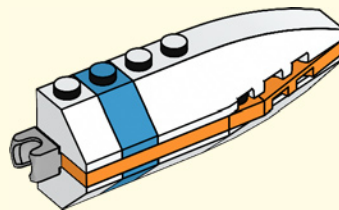

127

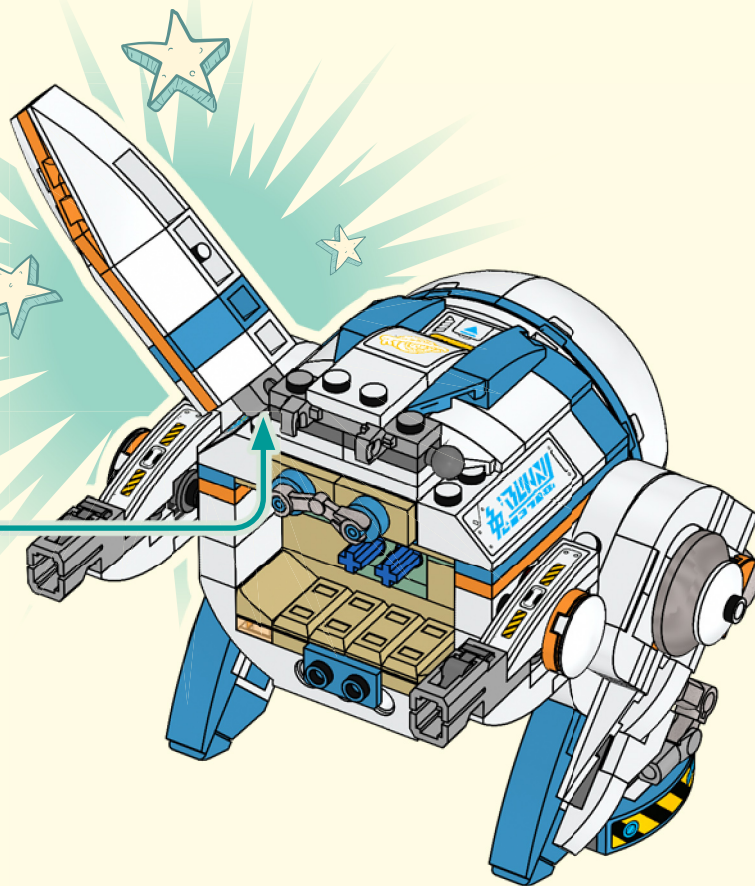



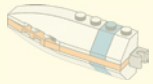

1x



1x

128

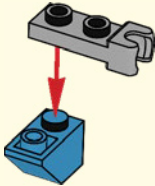

1x

129

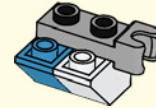

1x

130

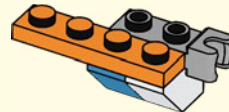

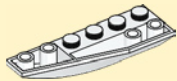

1x

131

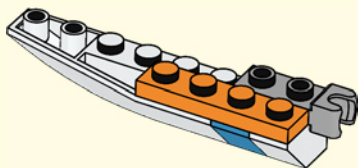

1x



1x



1x

132

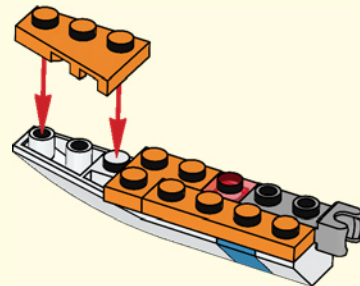



1x



1x

133

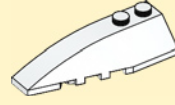
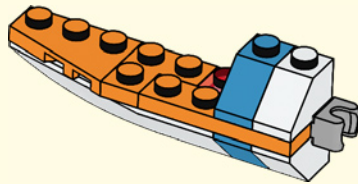

1x

134

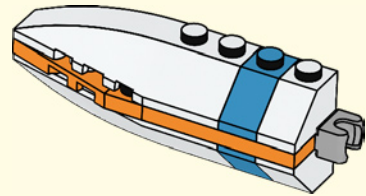

135

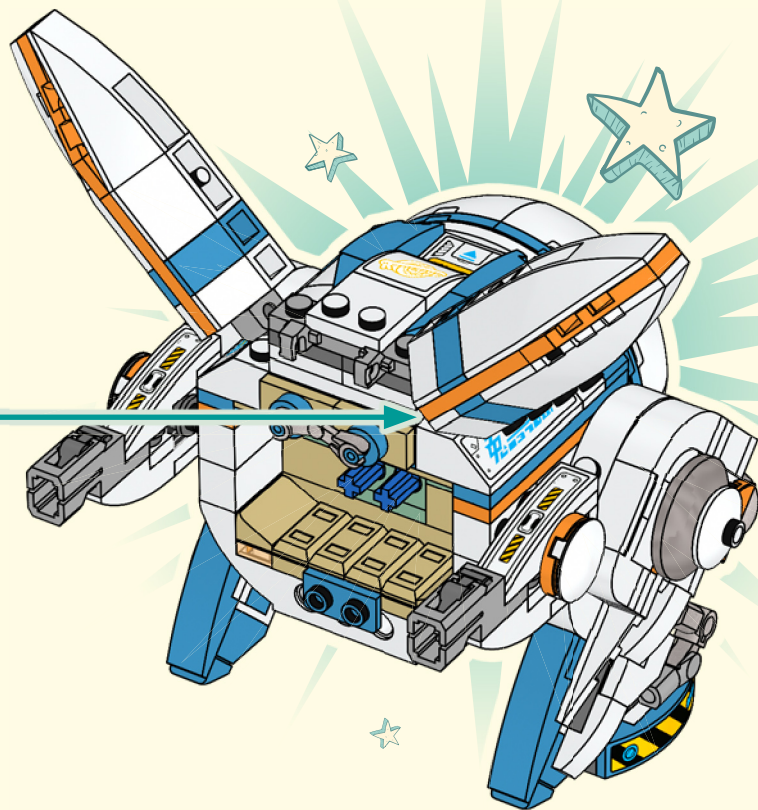

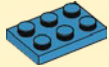

1x

136

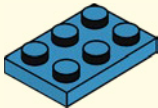

2x

137

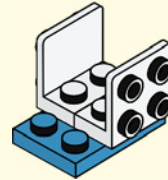

2x

138

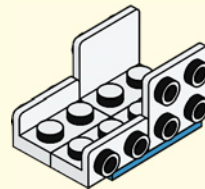



139

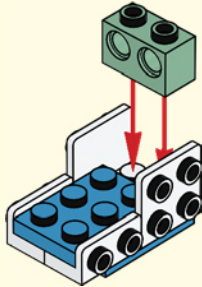

140

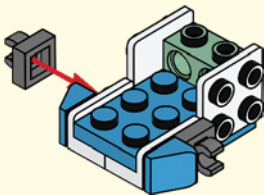

141

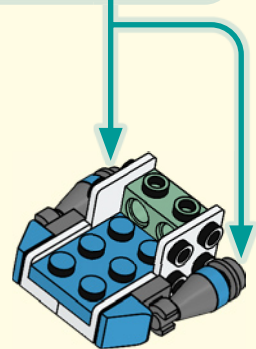
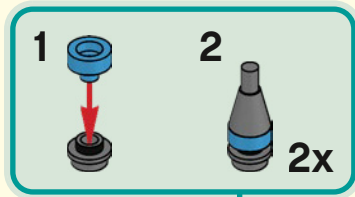



1x

142

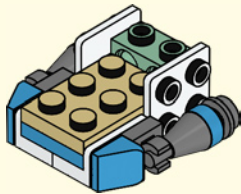

2x



2x

143

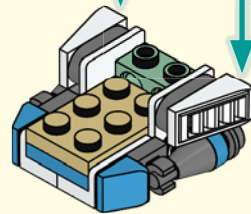
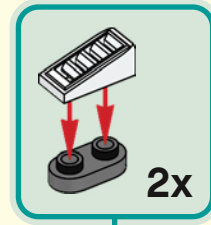



1x

144

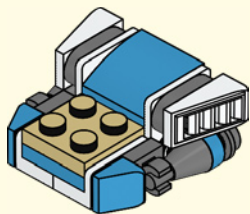

1x

145

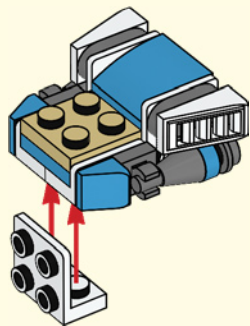

1x



1x



1x

146

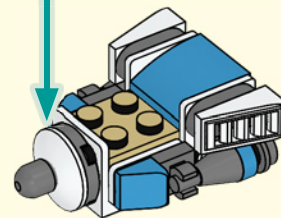
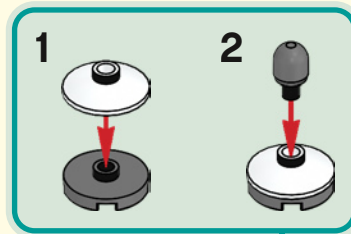





1x

147

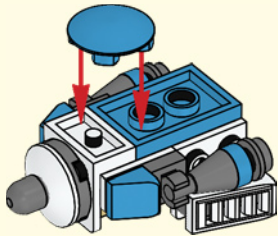

2x

148

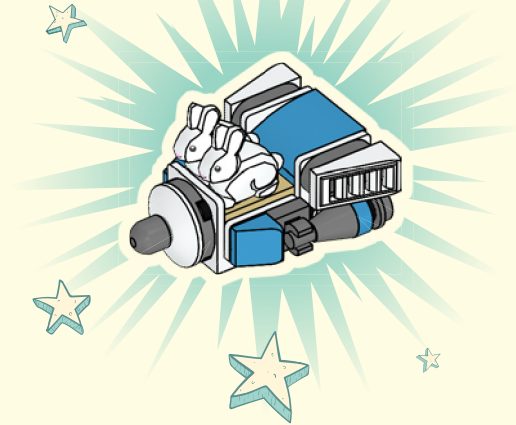

149

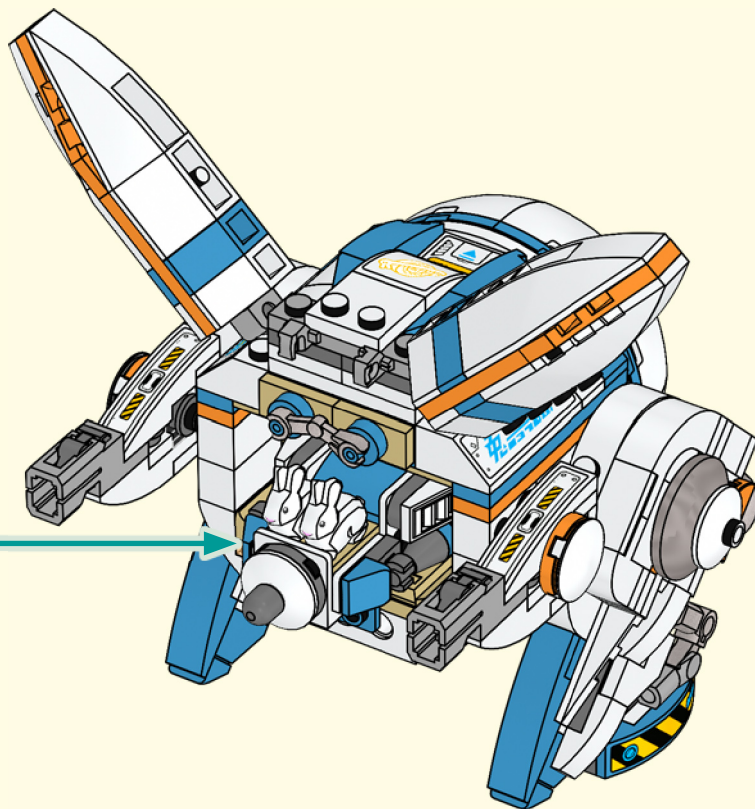

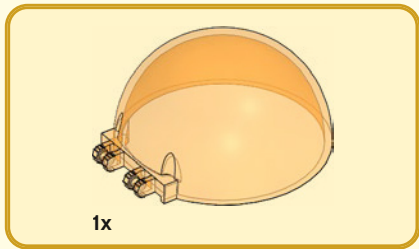

150

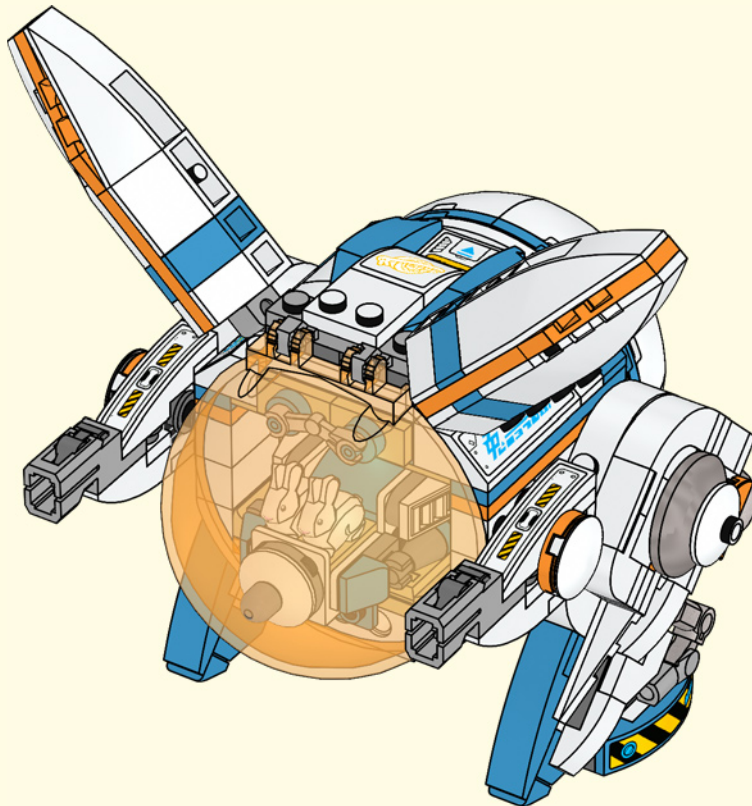



2x

151

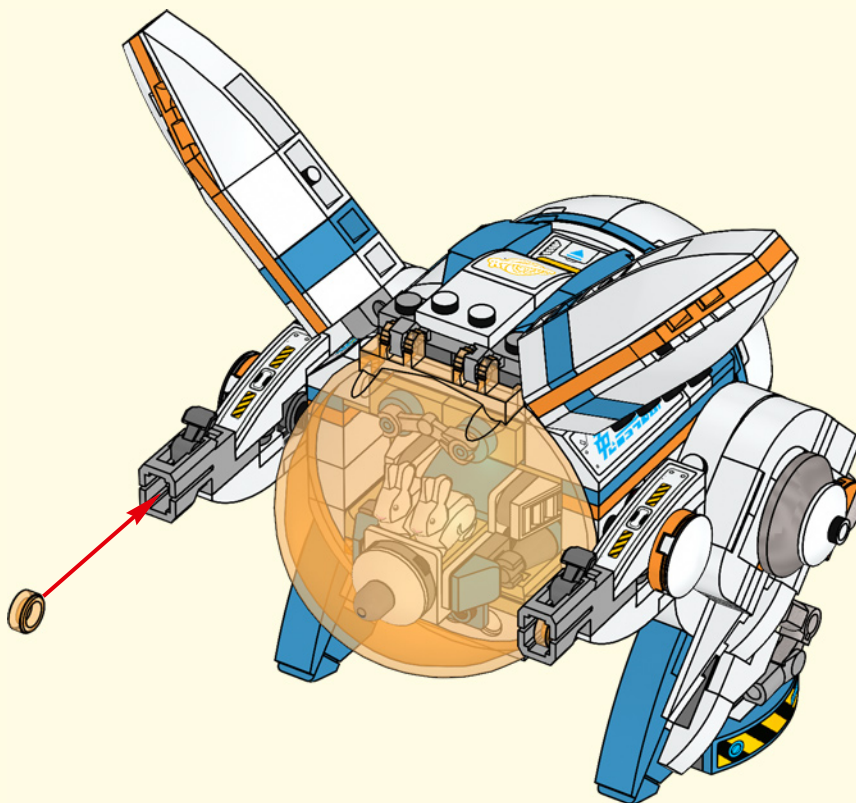



4x

152

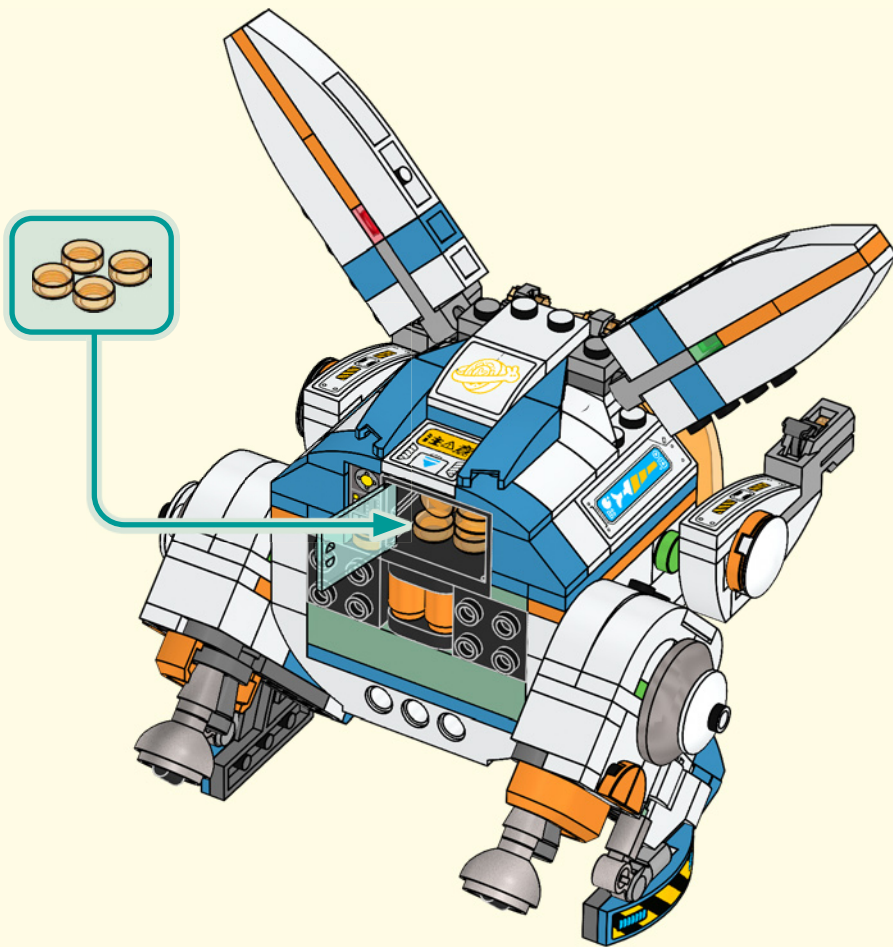
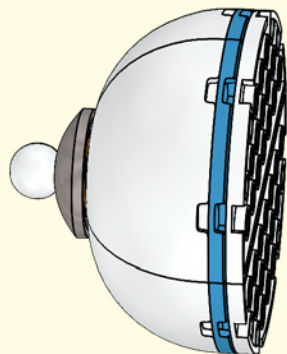

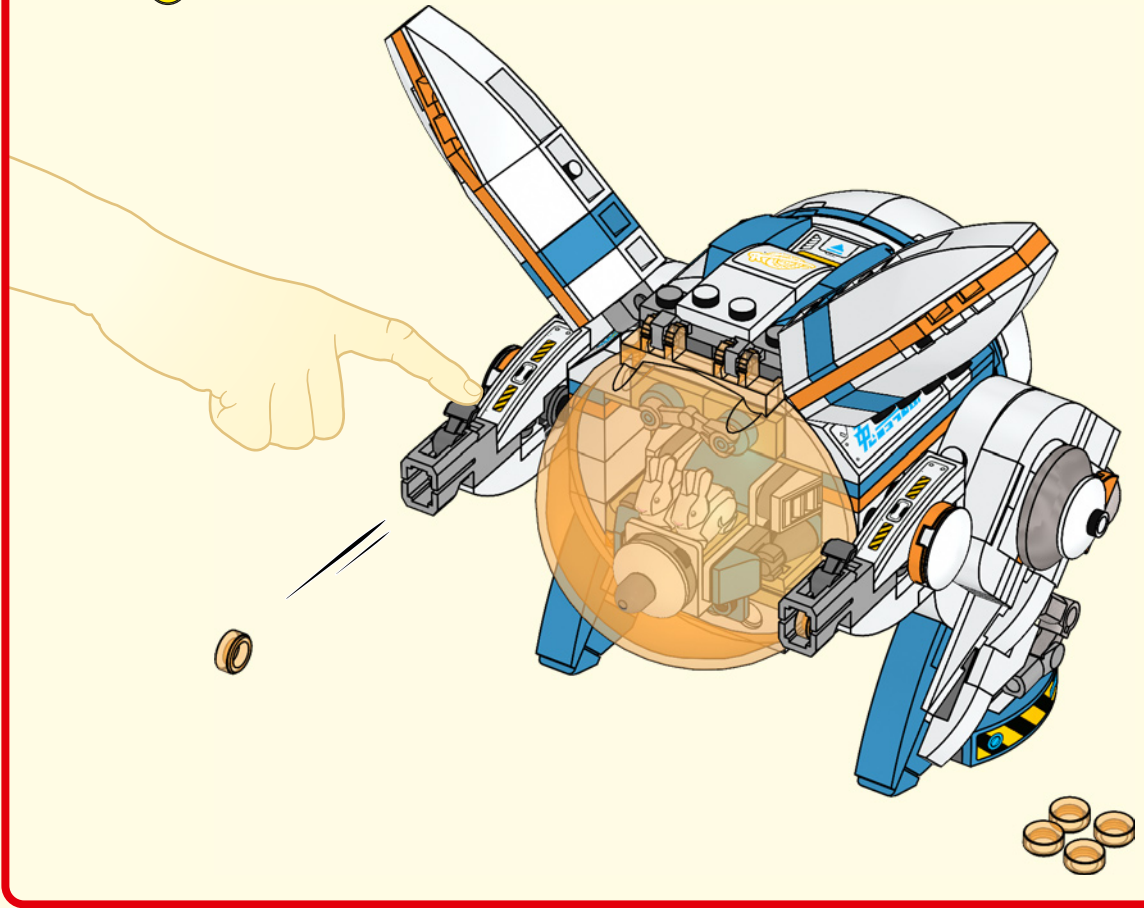







1x

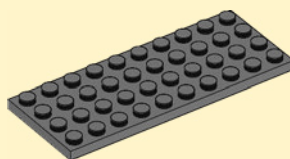

1x



1x

1

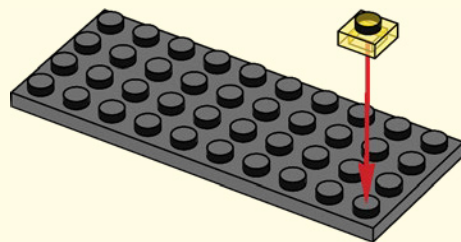





2

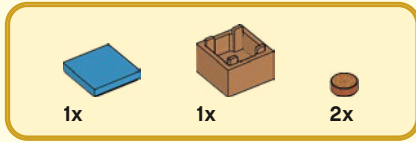
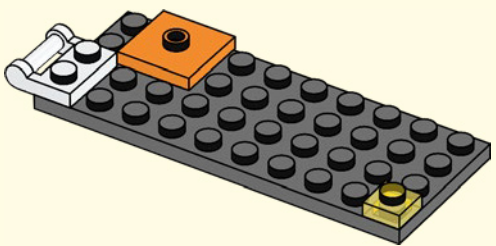

3

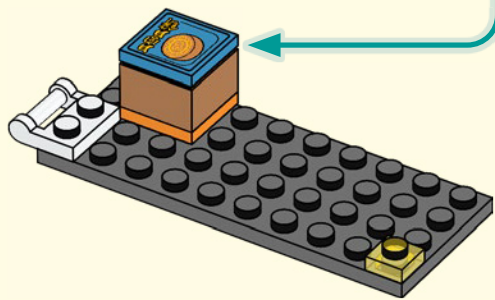
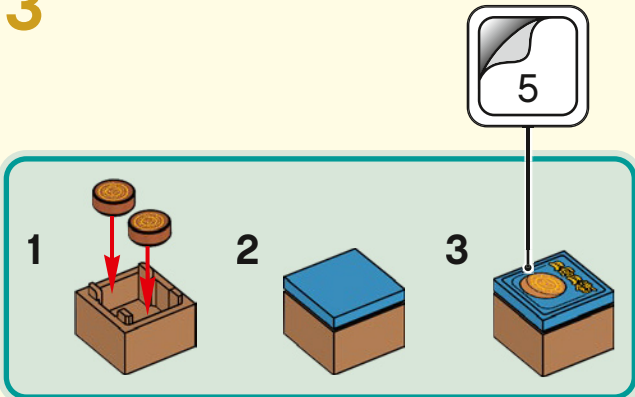



2x



2x

4

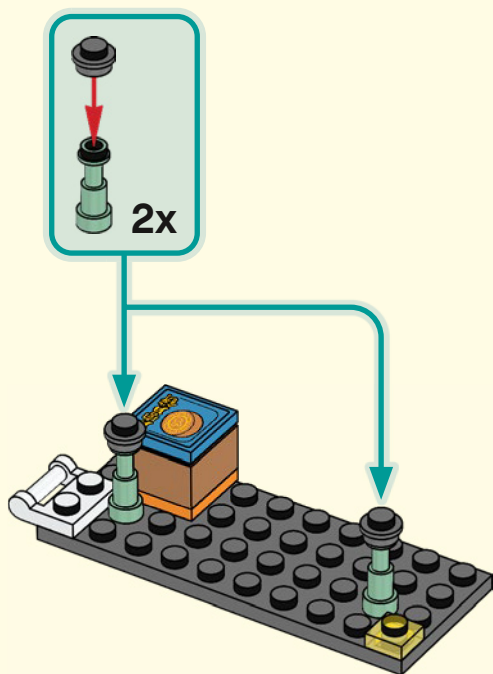

1x



2x

5

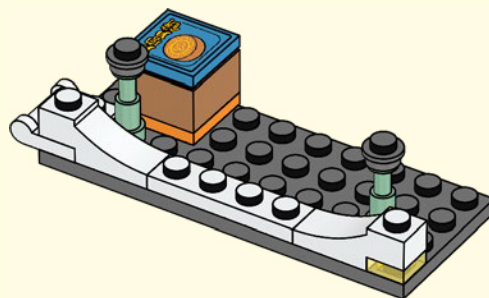

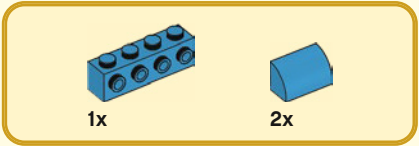

6

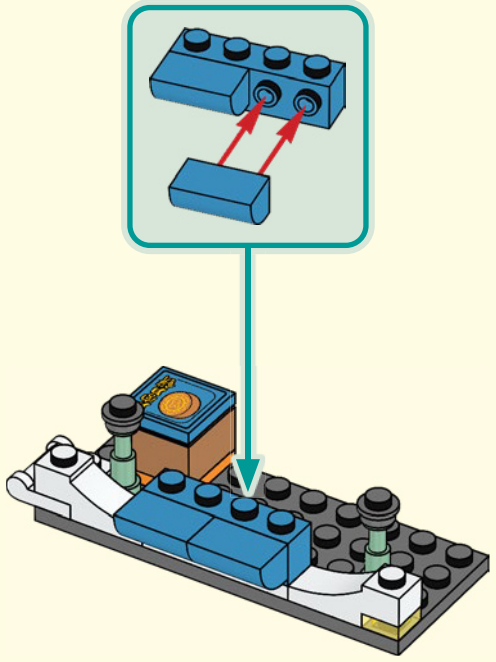

7

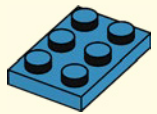



2x

8

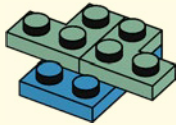

2x

9

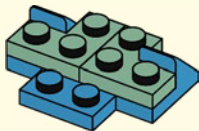

1x



1x

10

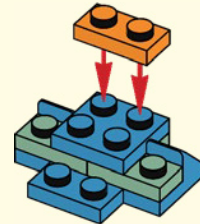



11

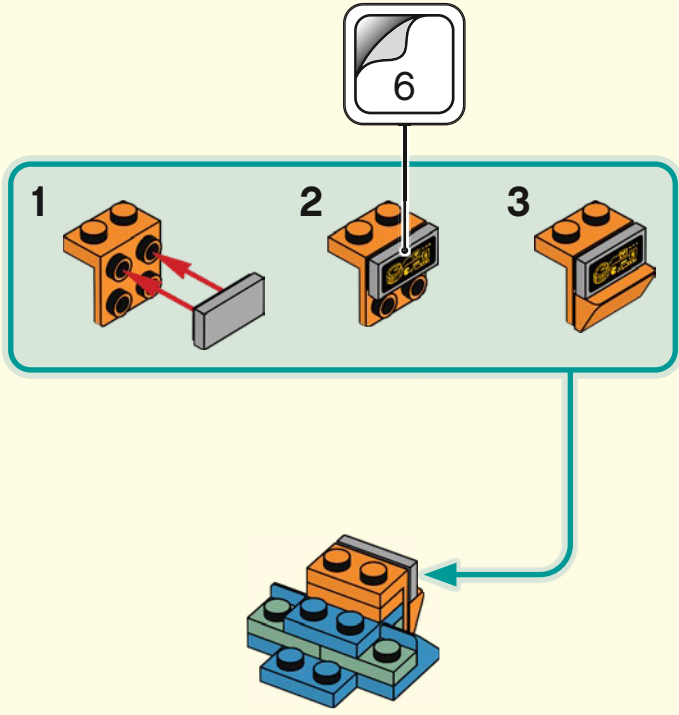



1x

12

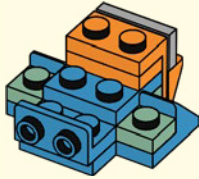

1x



1x



1x

13

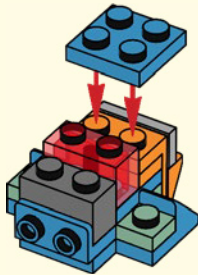

1x

14

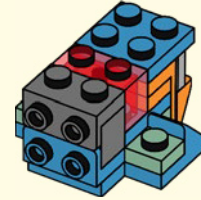

1x

15

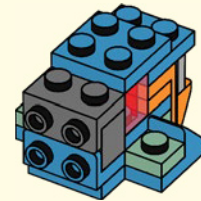



1x



2x

16

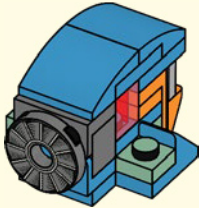

17

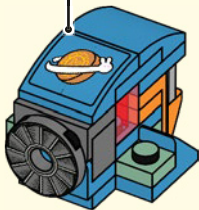

18

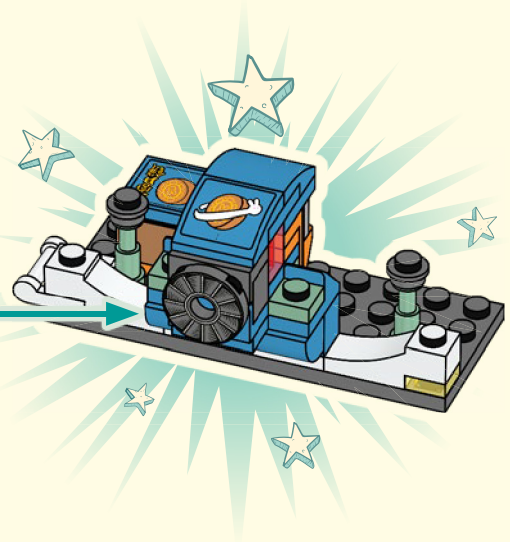



2x



1x

19

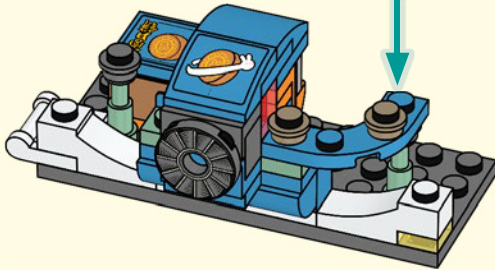
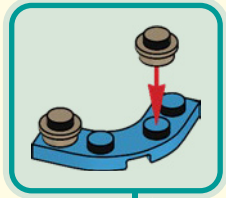

1x



2x

20

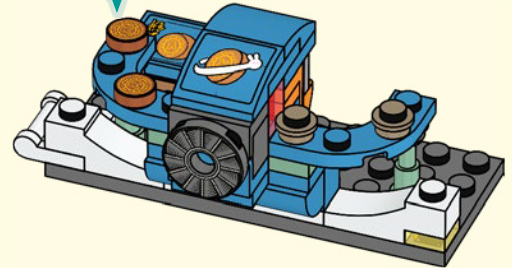
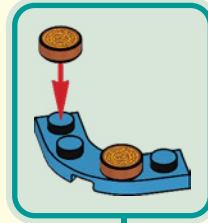



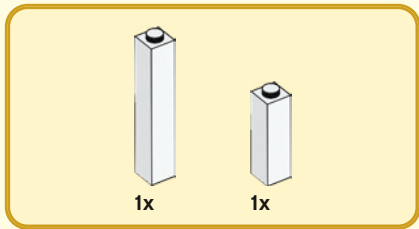

21

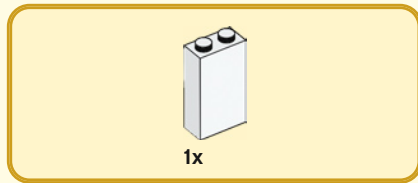
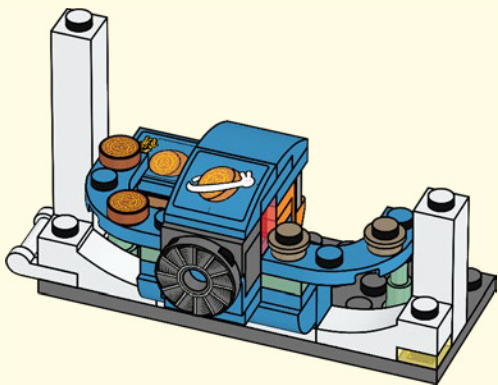

22

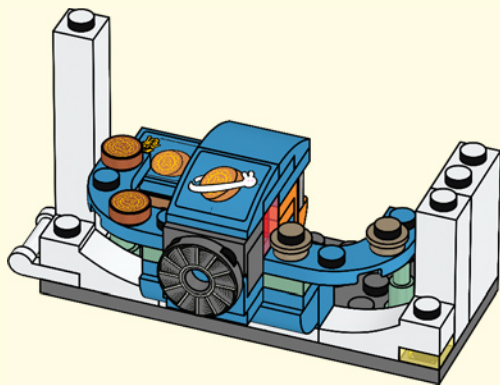



1x

23

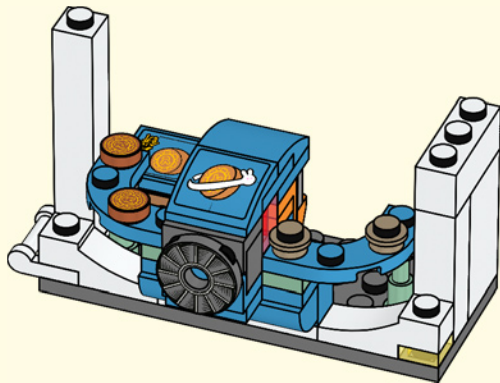

1x

24

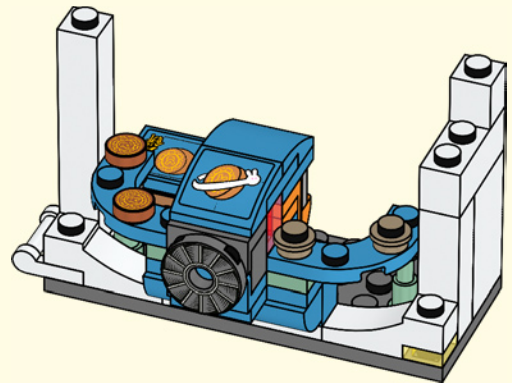

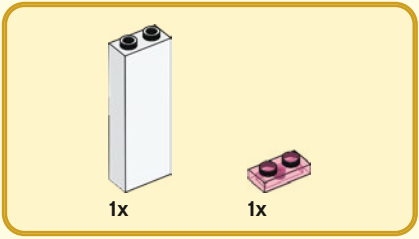

25

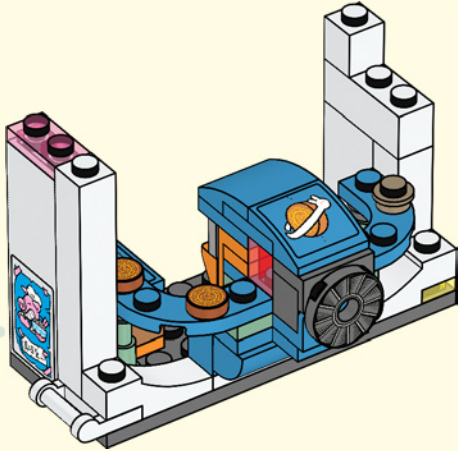
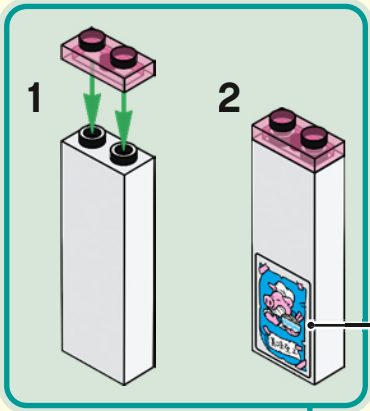



26

1

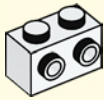

2

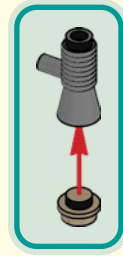
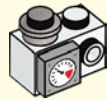

3

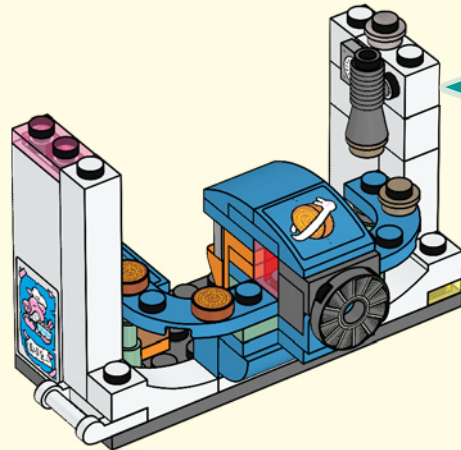
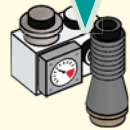



2x



4x

27

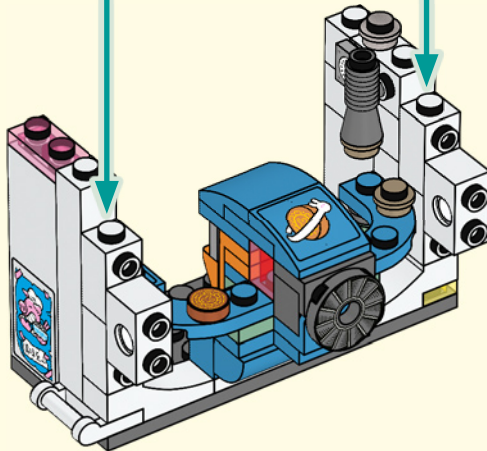
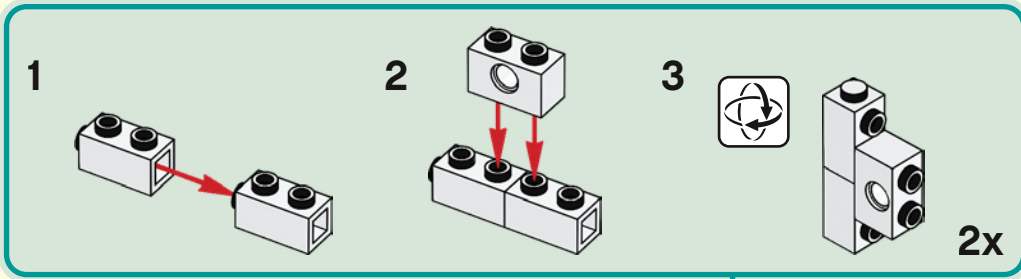

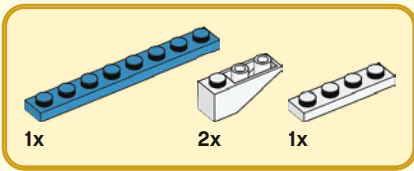

28

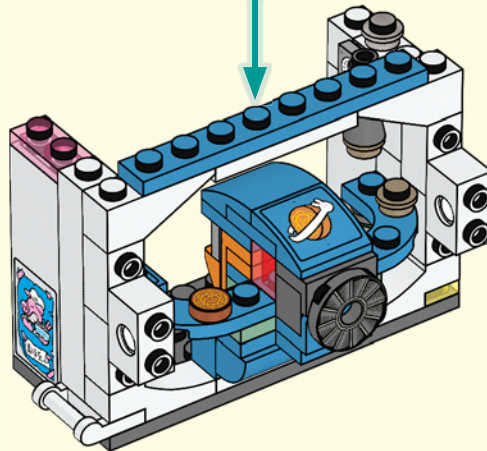
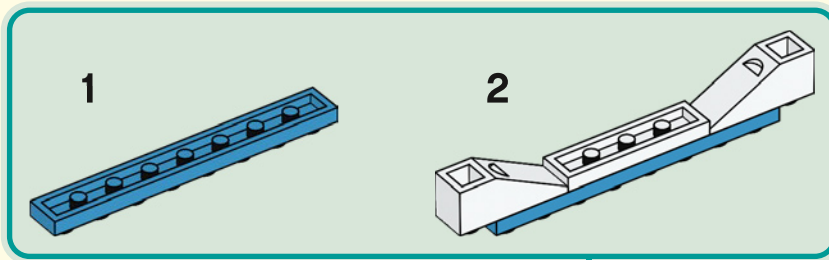

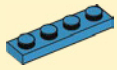

1x

29

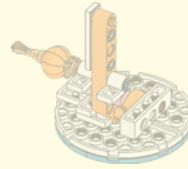
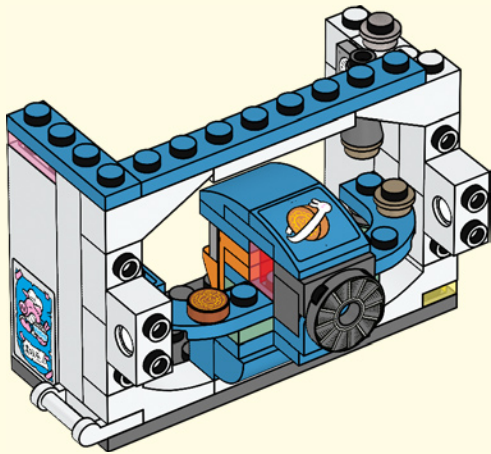

1x



1x

30

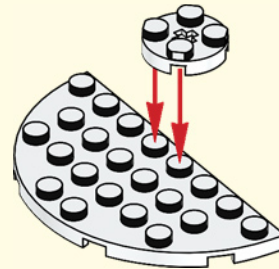

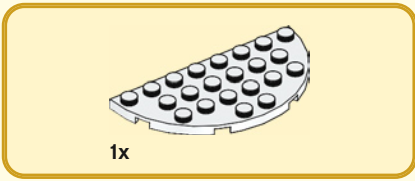

31

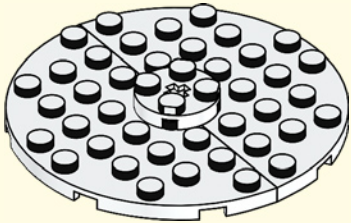

32

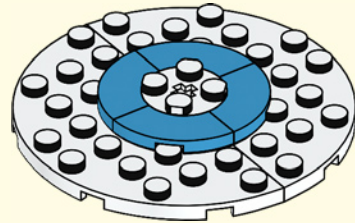





4x

33

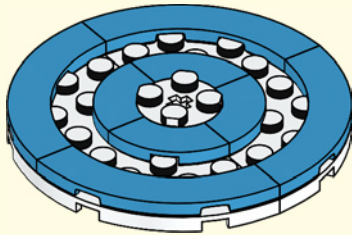

1x



1x

34

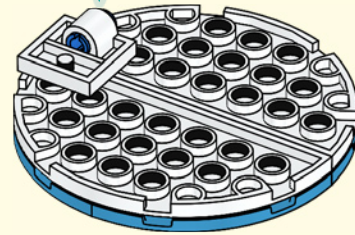
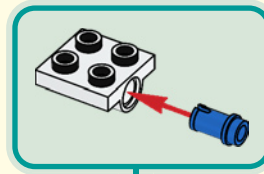



2x

35

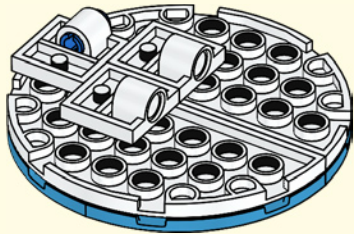

1x

36

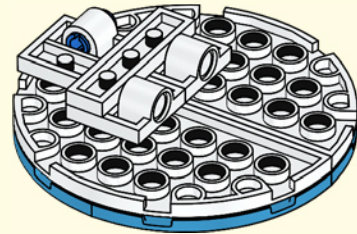



1x

37

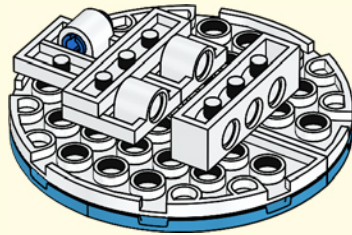

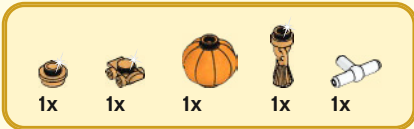

38

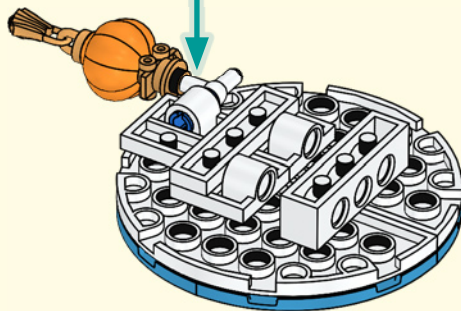
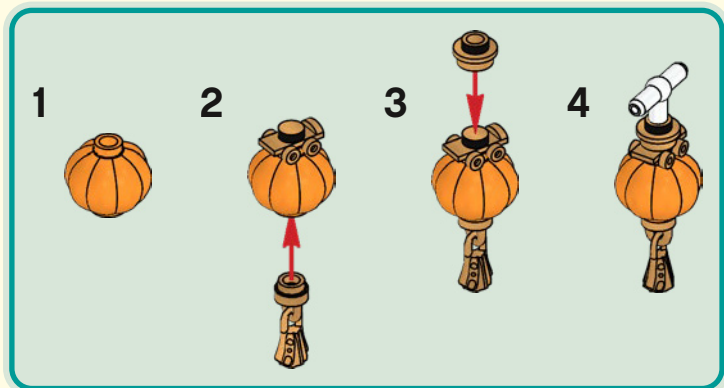

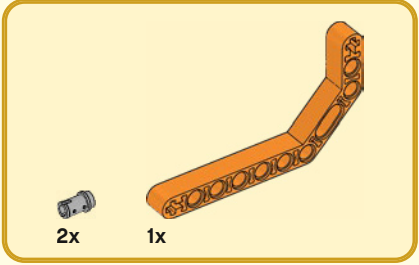
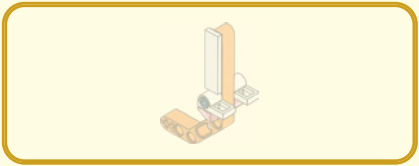

39

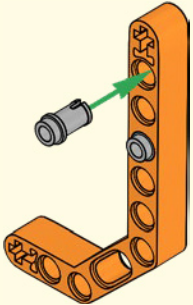

40

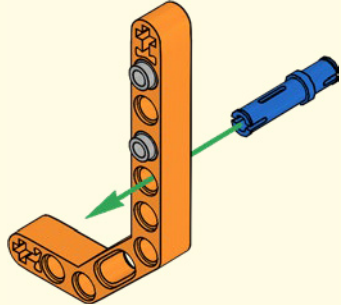



41

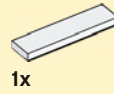
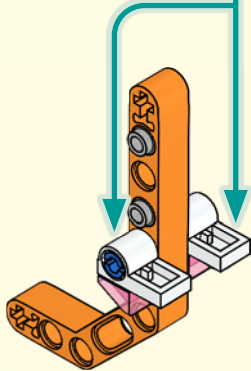
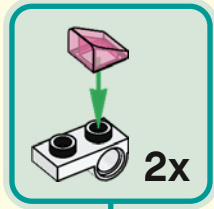

42

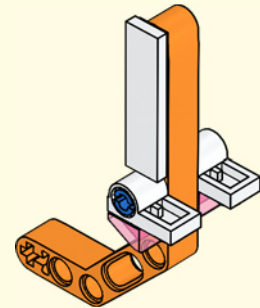

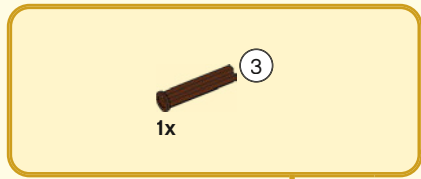

43

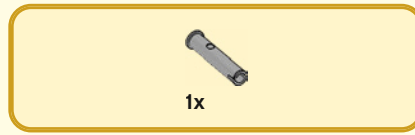
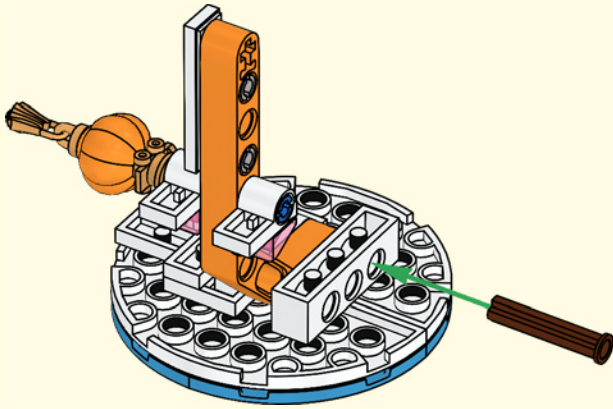

44

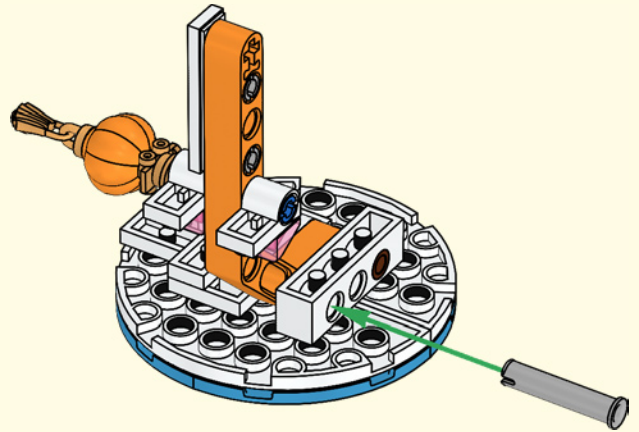

45

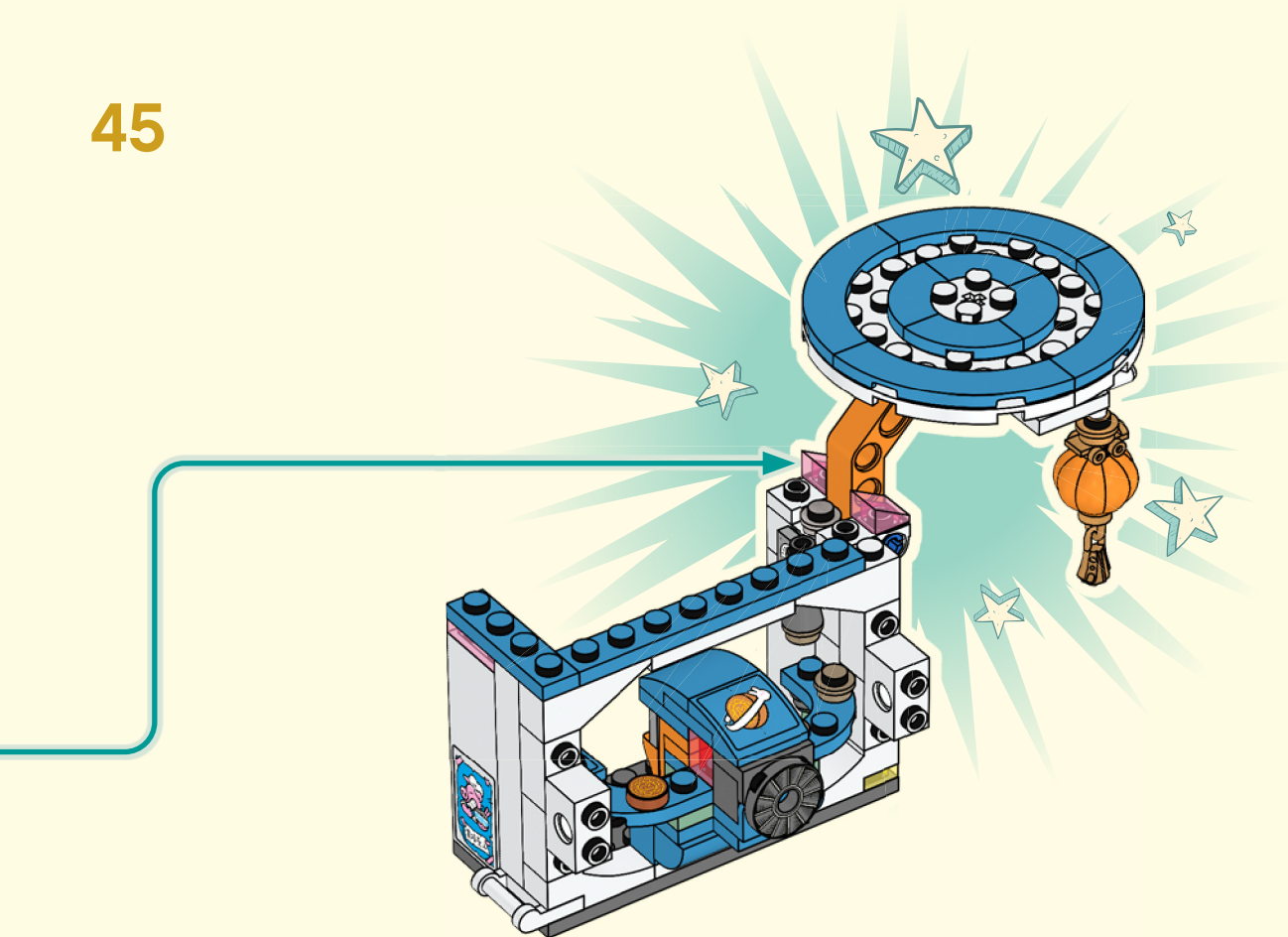



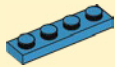

1x

46

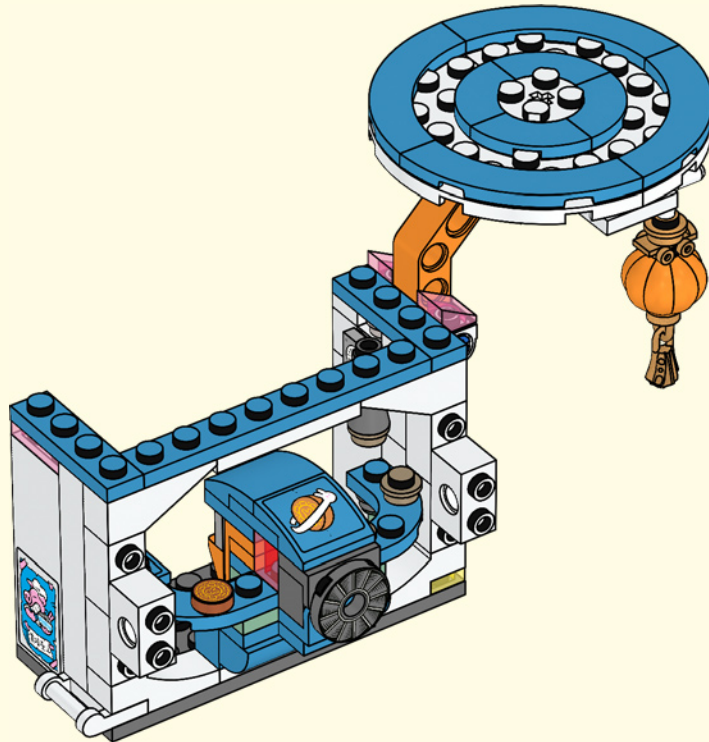

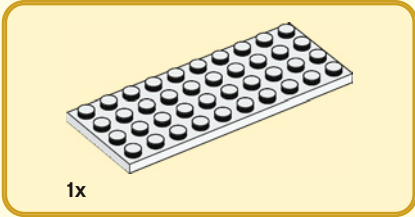
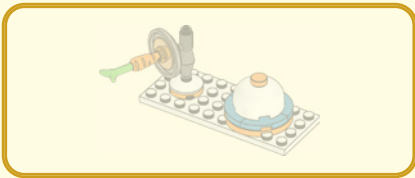

47

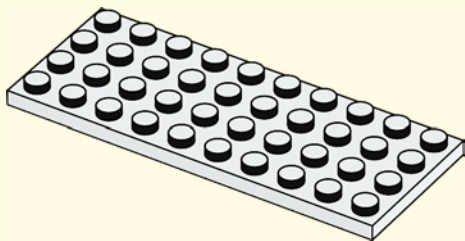

48

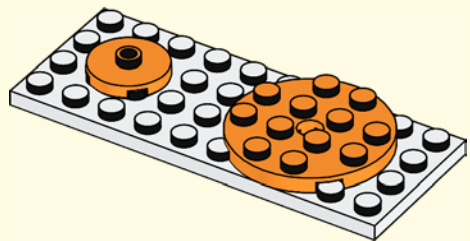

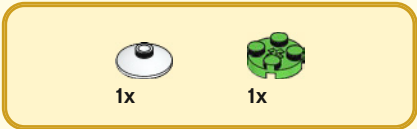

49

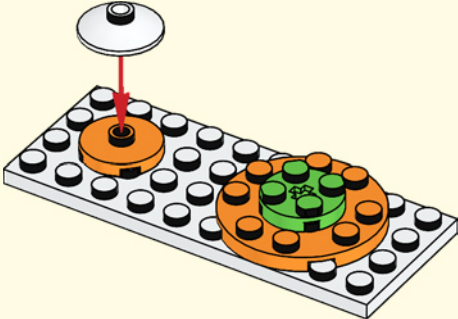

50

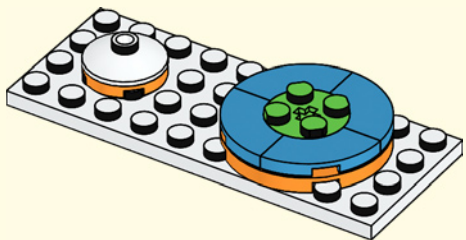

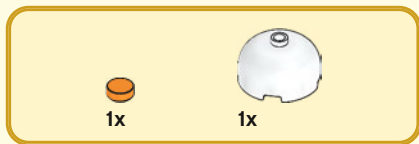

51

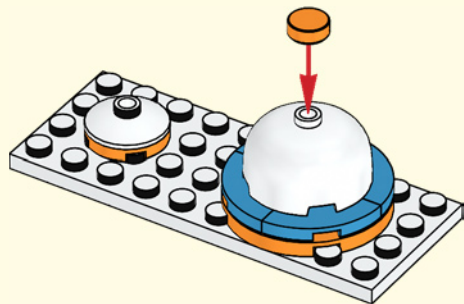

52

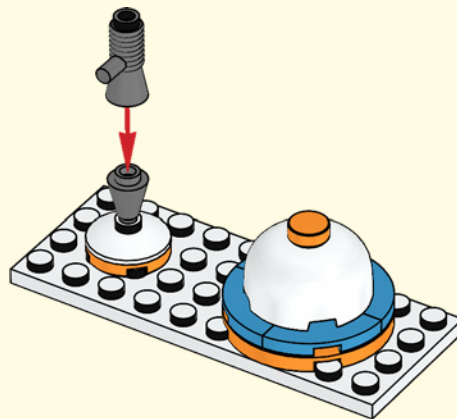

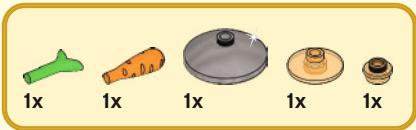

53

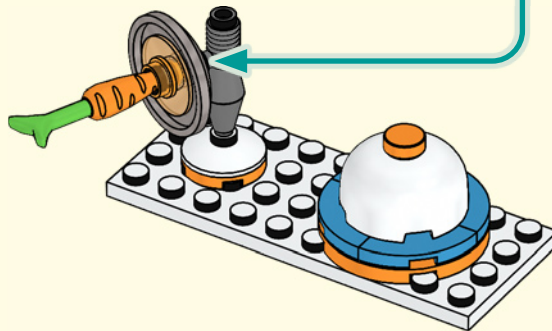
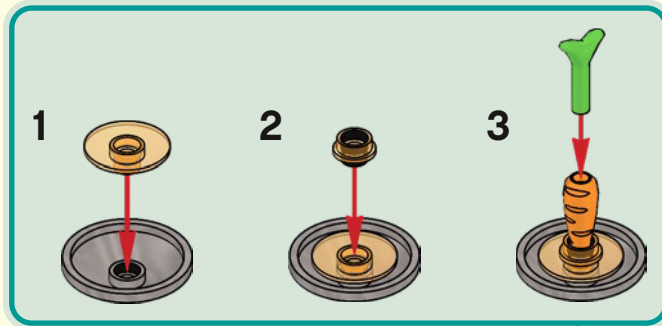



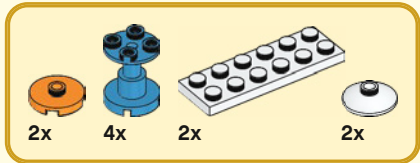

# 55

1



2

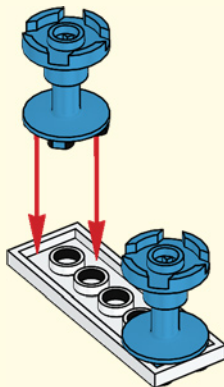

3

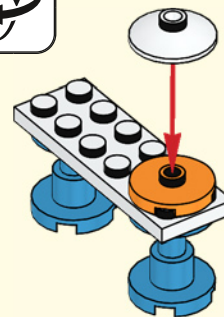

2x





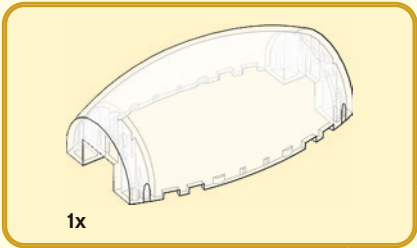

56

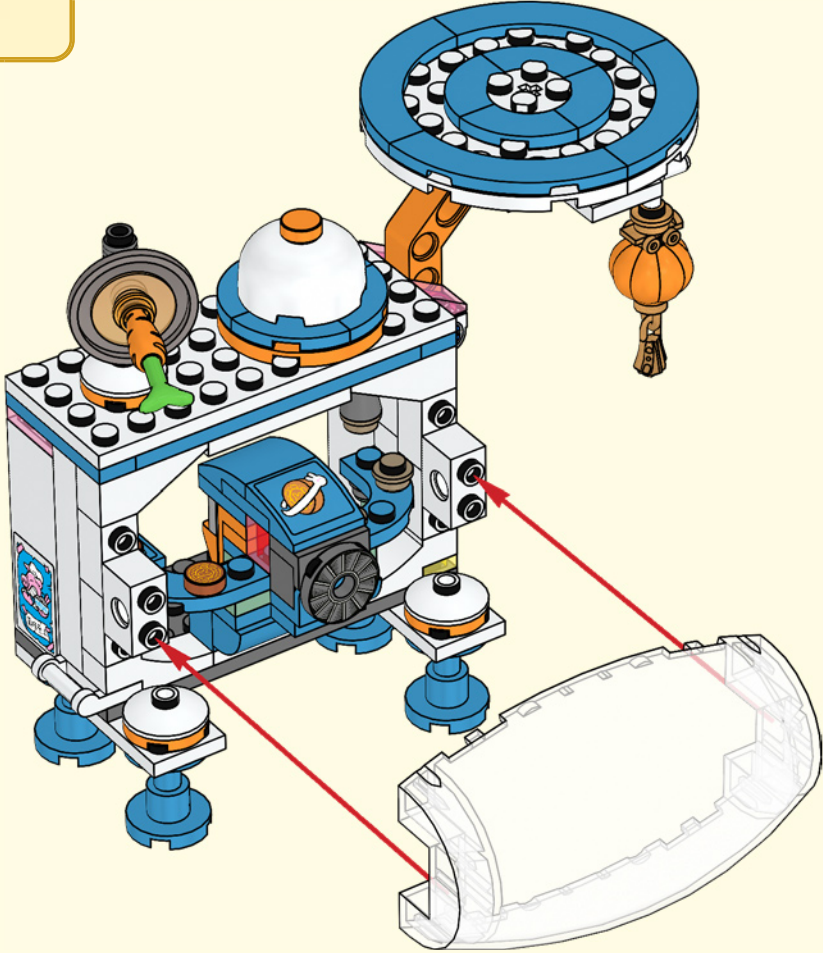

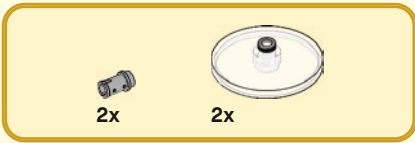

57

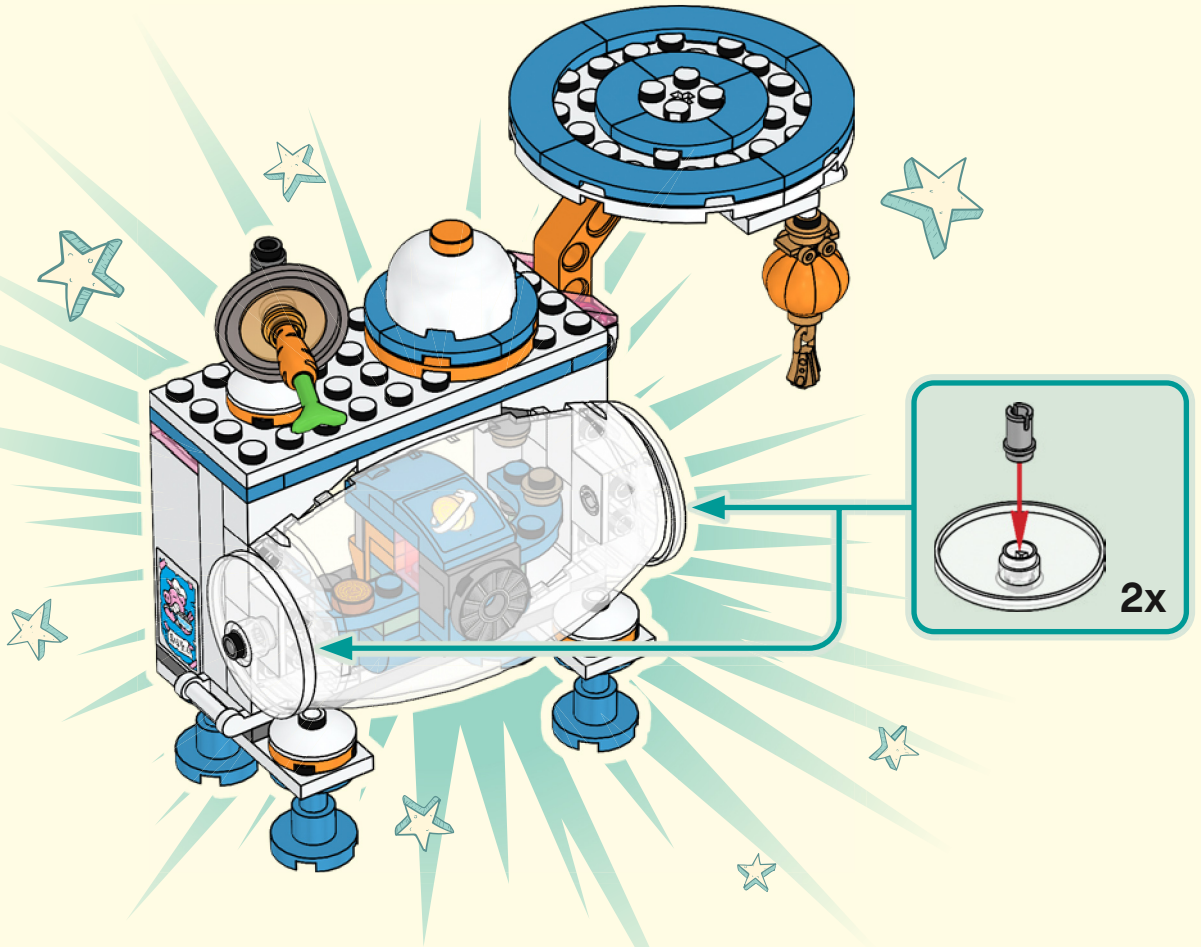



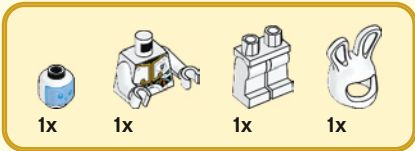

1

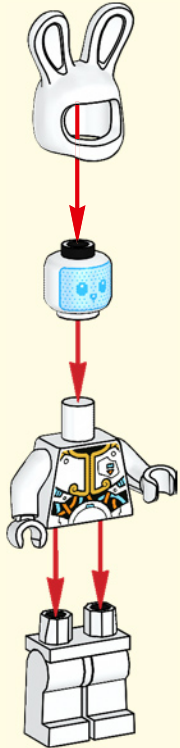

2

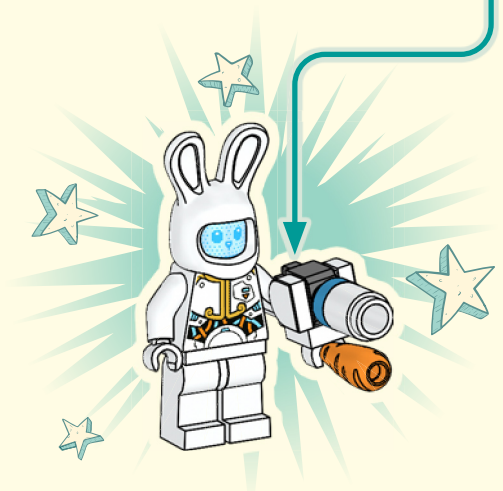
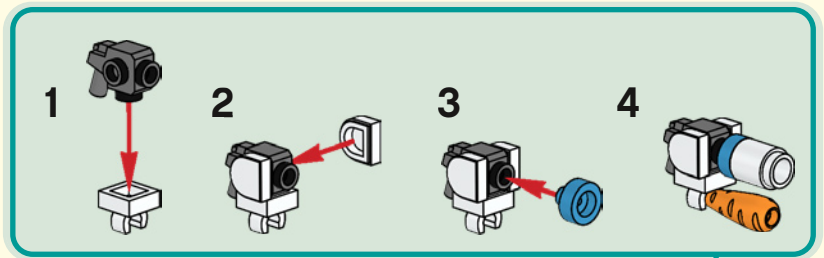

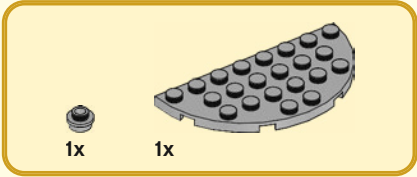

58

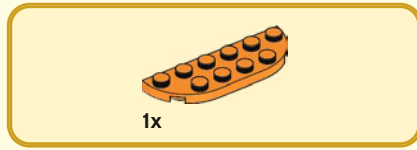
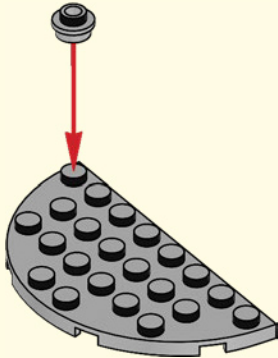

59

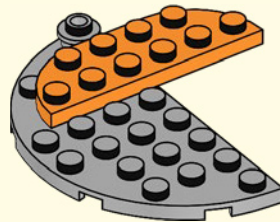

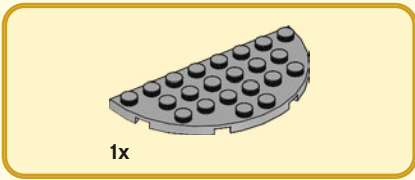

60

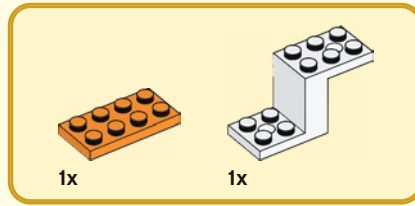
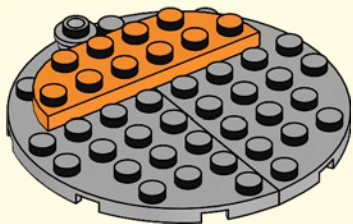

61

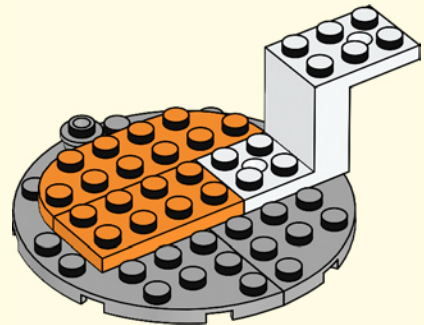

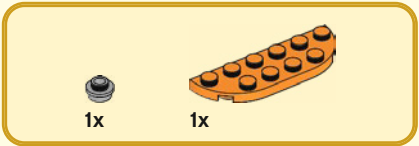

62

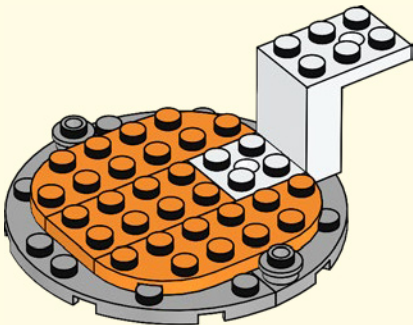

63

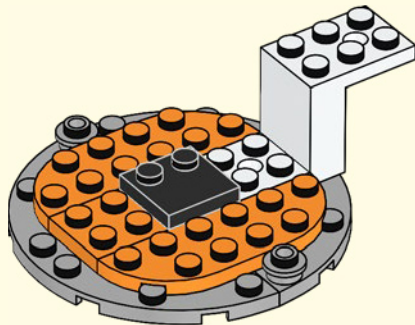



4x

64

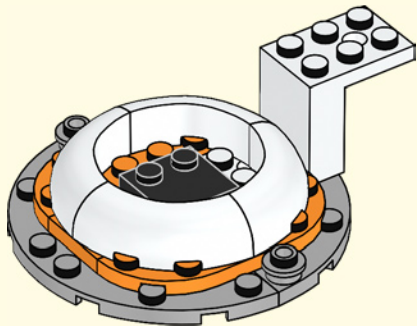

1x

65

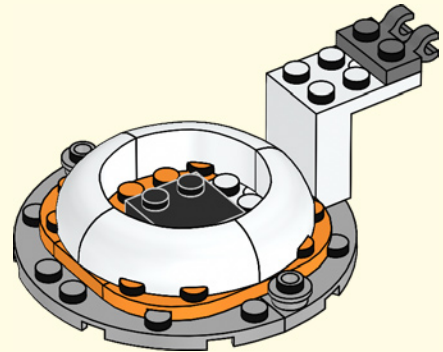





1x

66



1

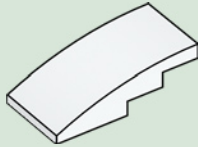

2

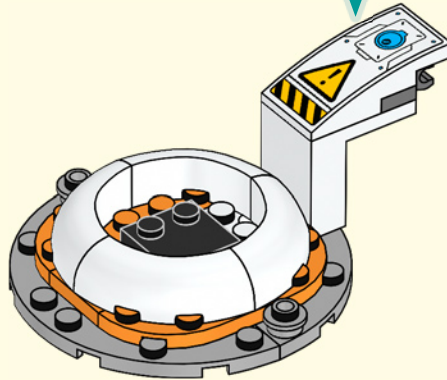
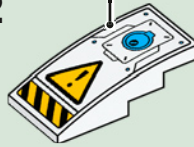



67

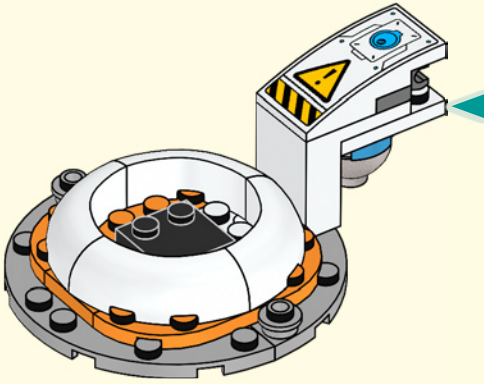
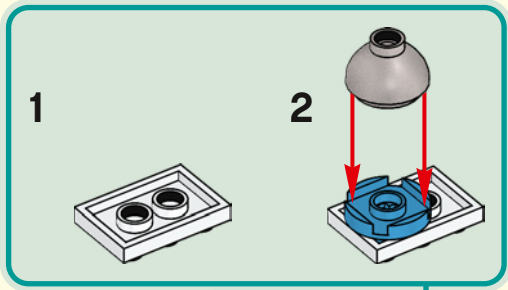

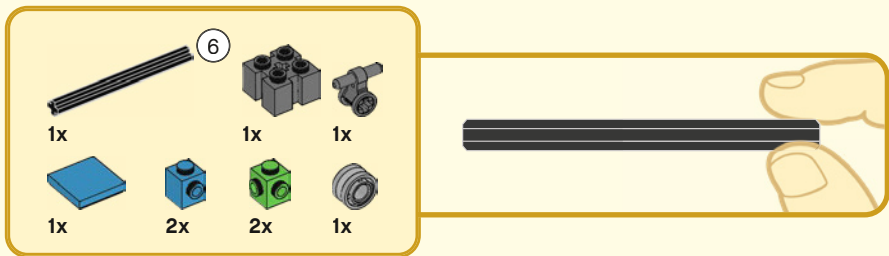

68

1

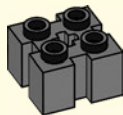

2

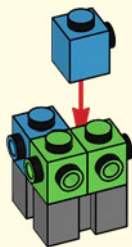

3



4

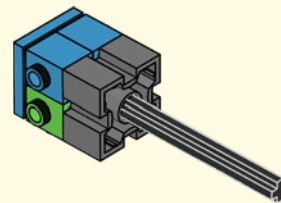

5

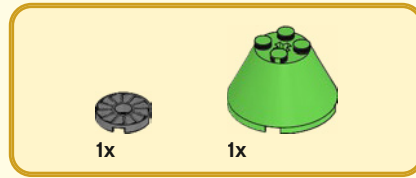
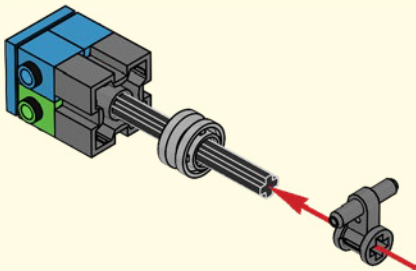

69

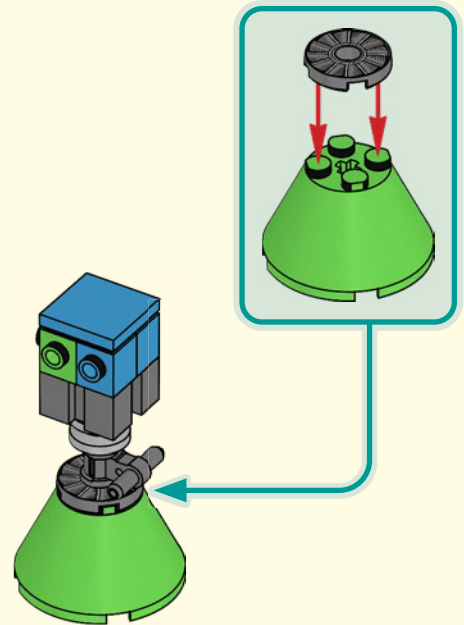



2x

70

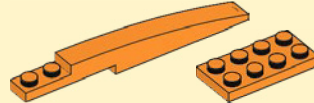
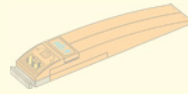
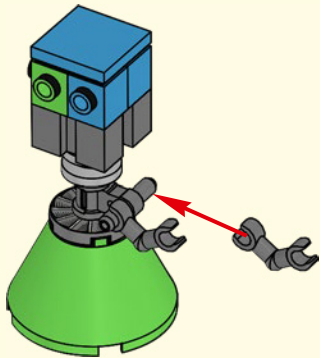

2x

1x

1x

1x

1x

71

1

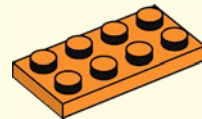

2

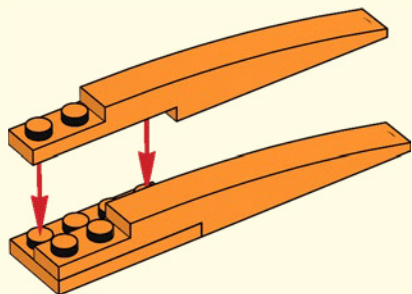

3

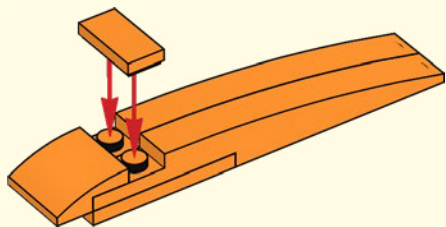

4

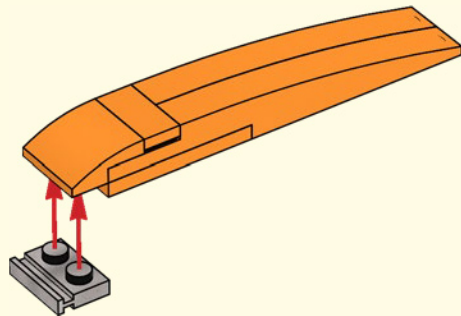

5

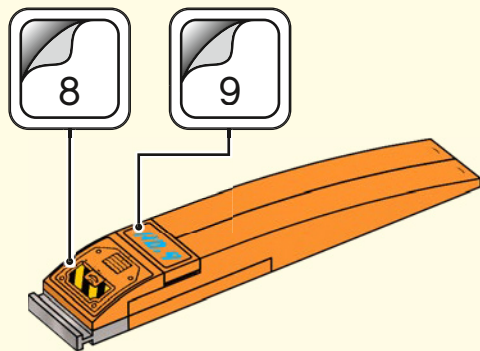

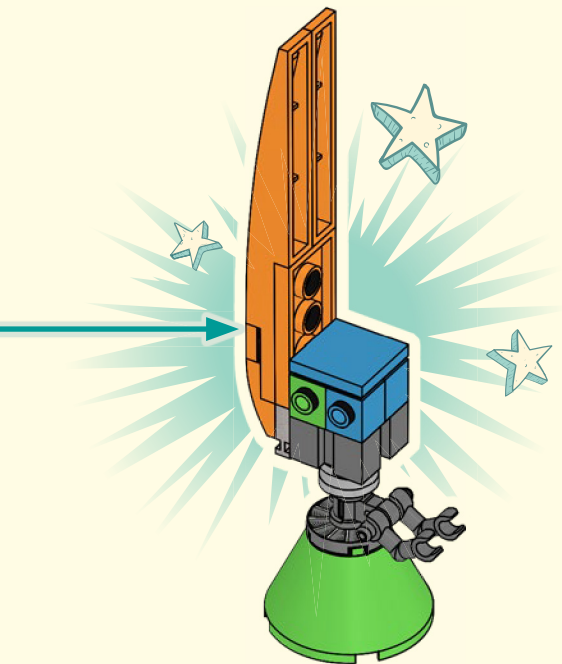

4x

72

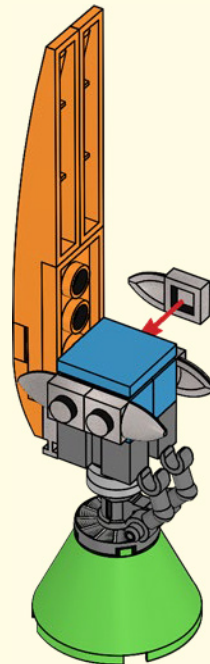



73

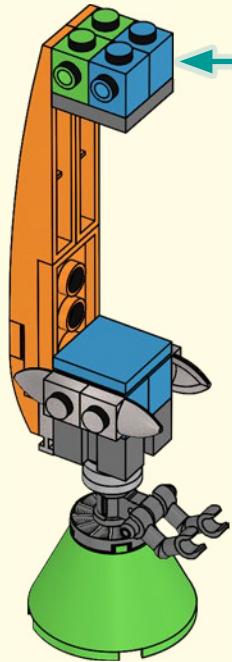
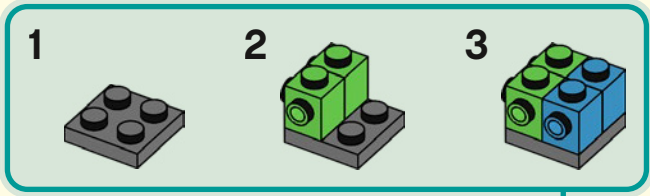



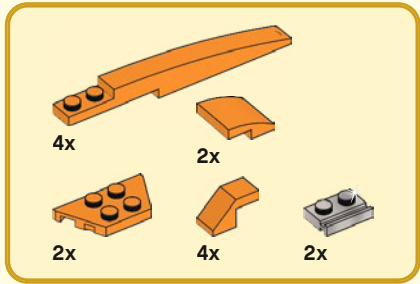
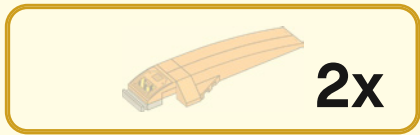

74

1

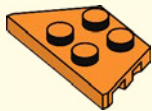

2

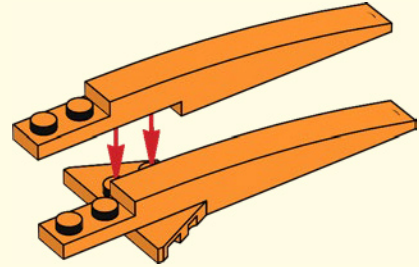

3

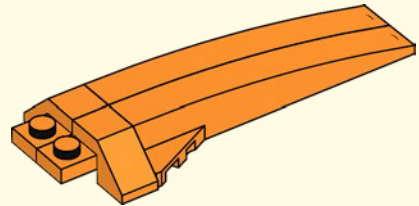

4

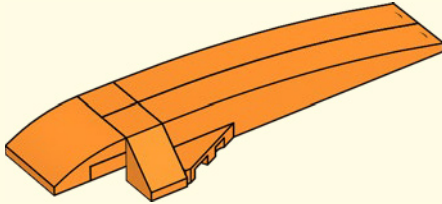

5

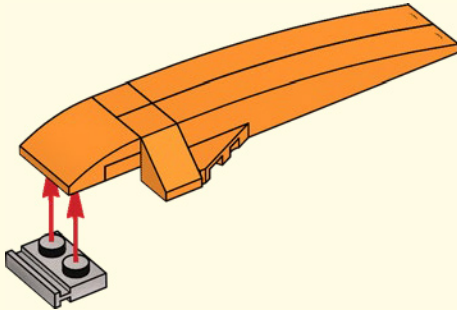

6

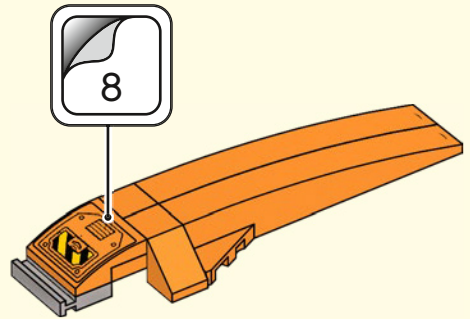

2x



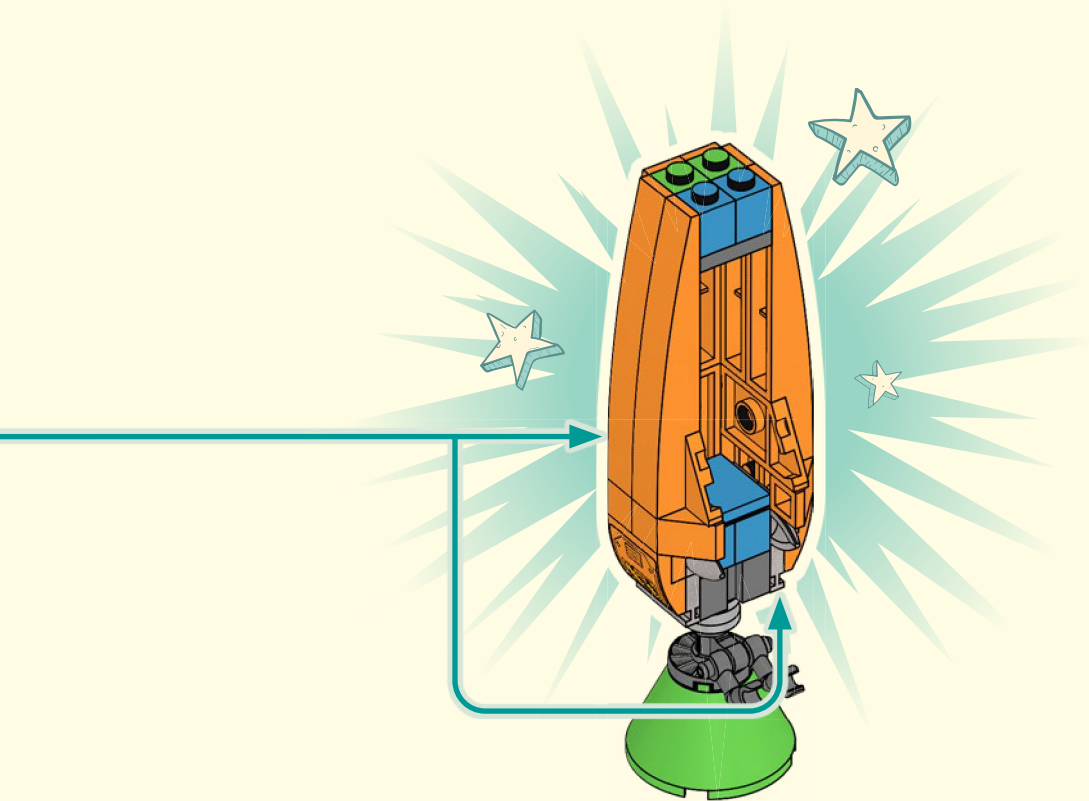



1x



1x

75

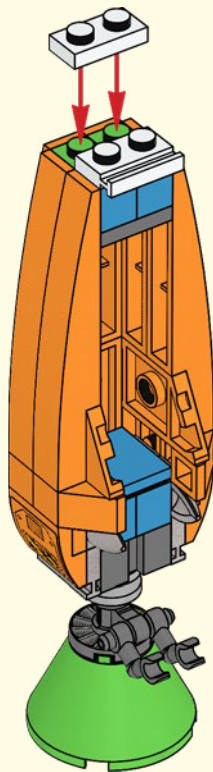



76

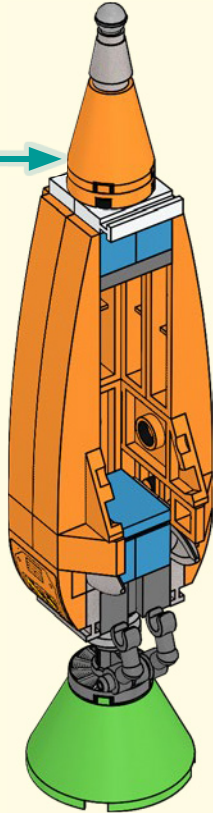
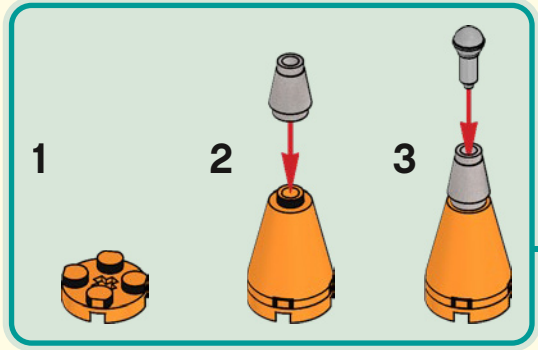



77

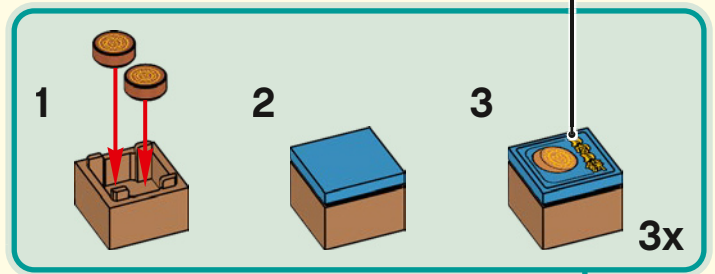

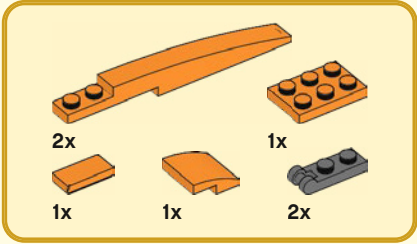
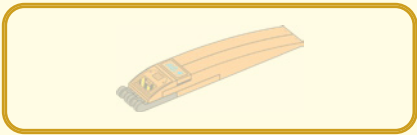

78

1

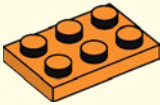

2

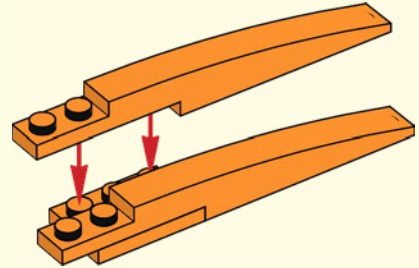

3

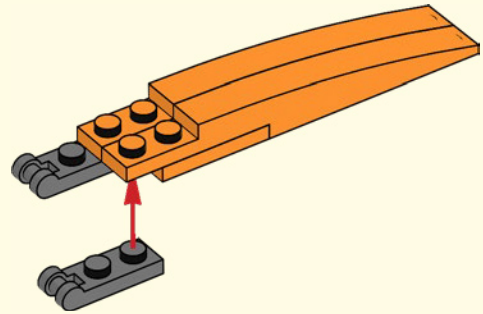

4

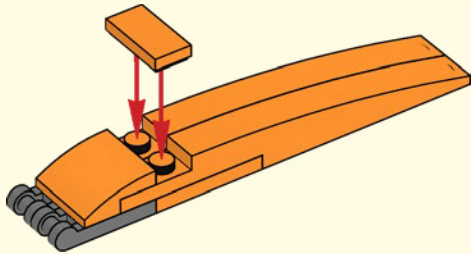

5

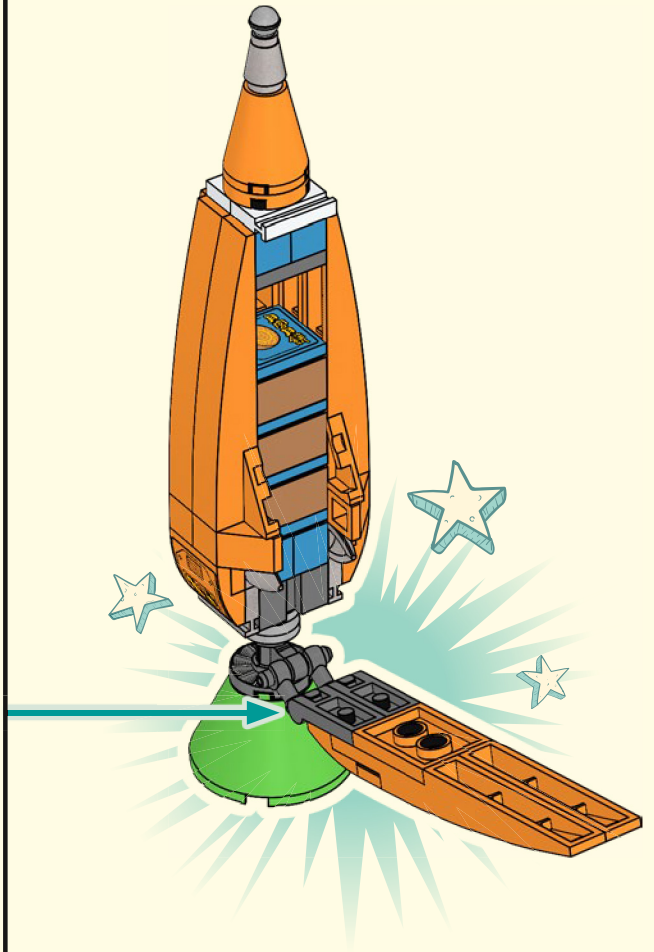
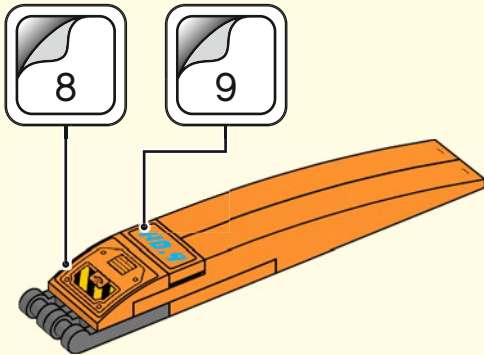



79

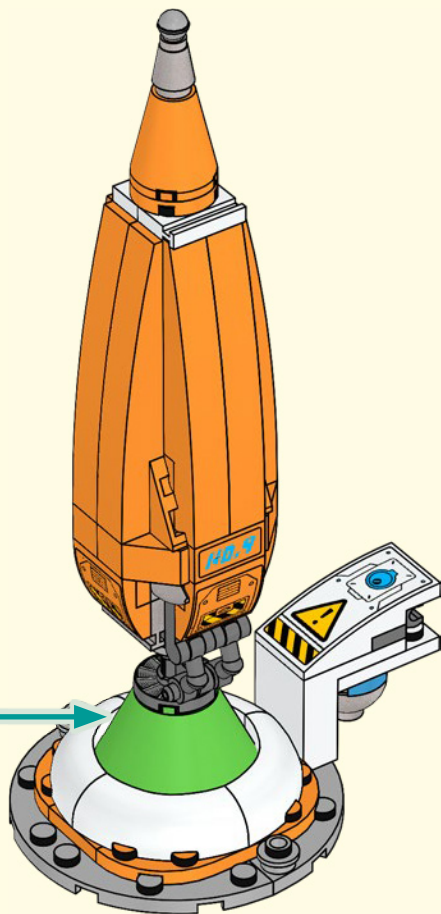

80

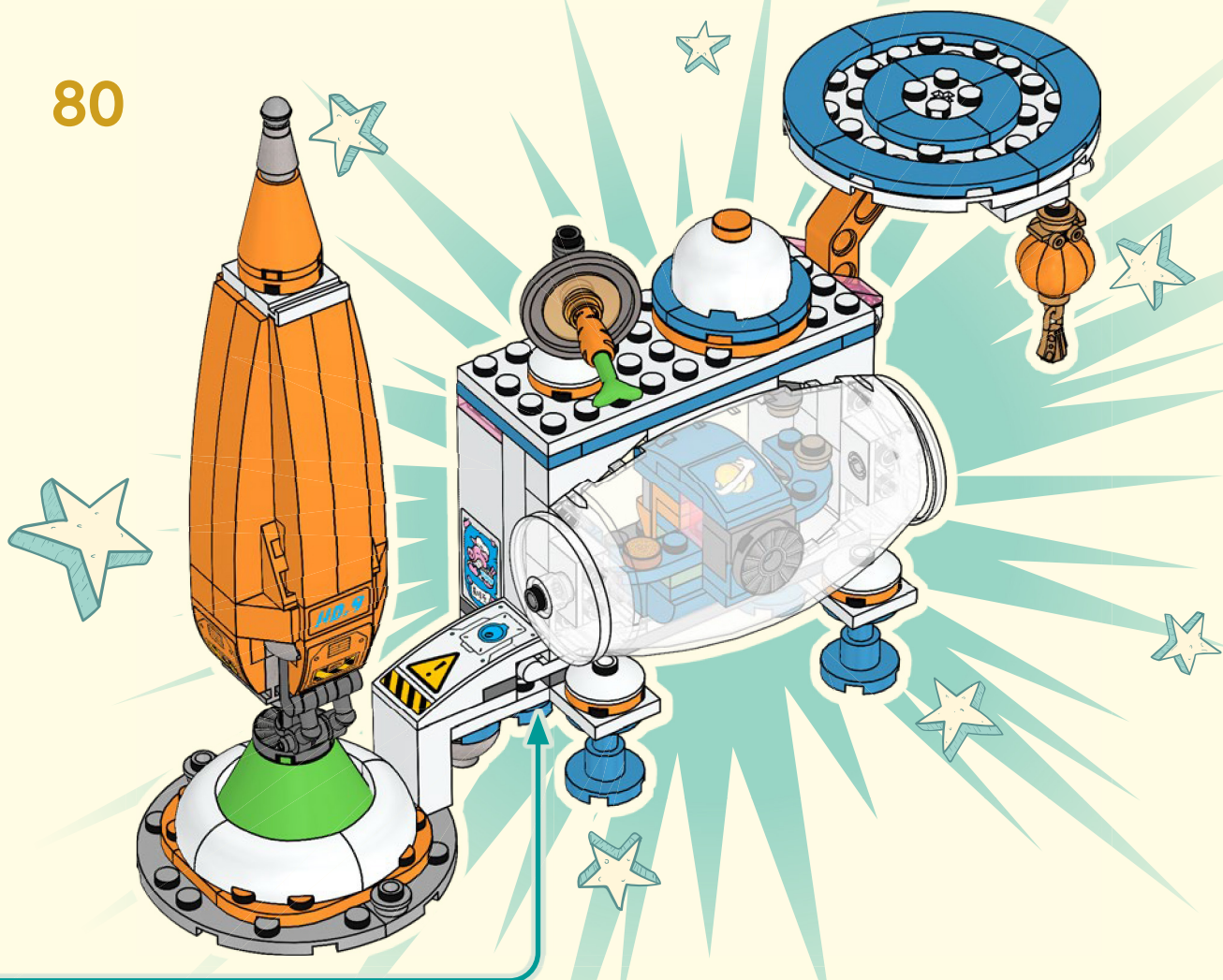

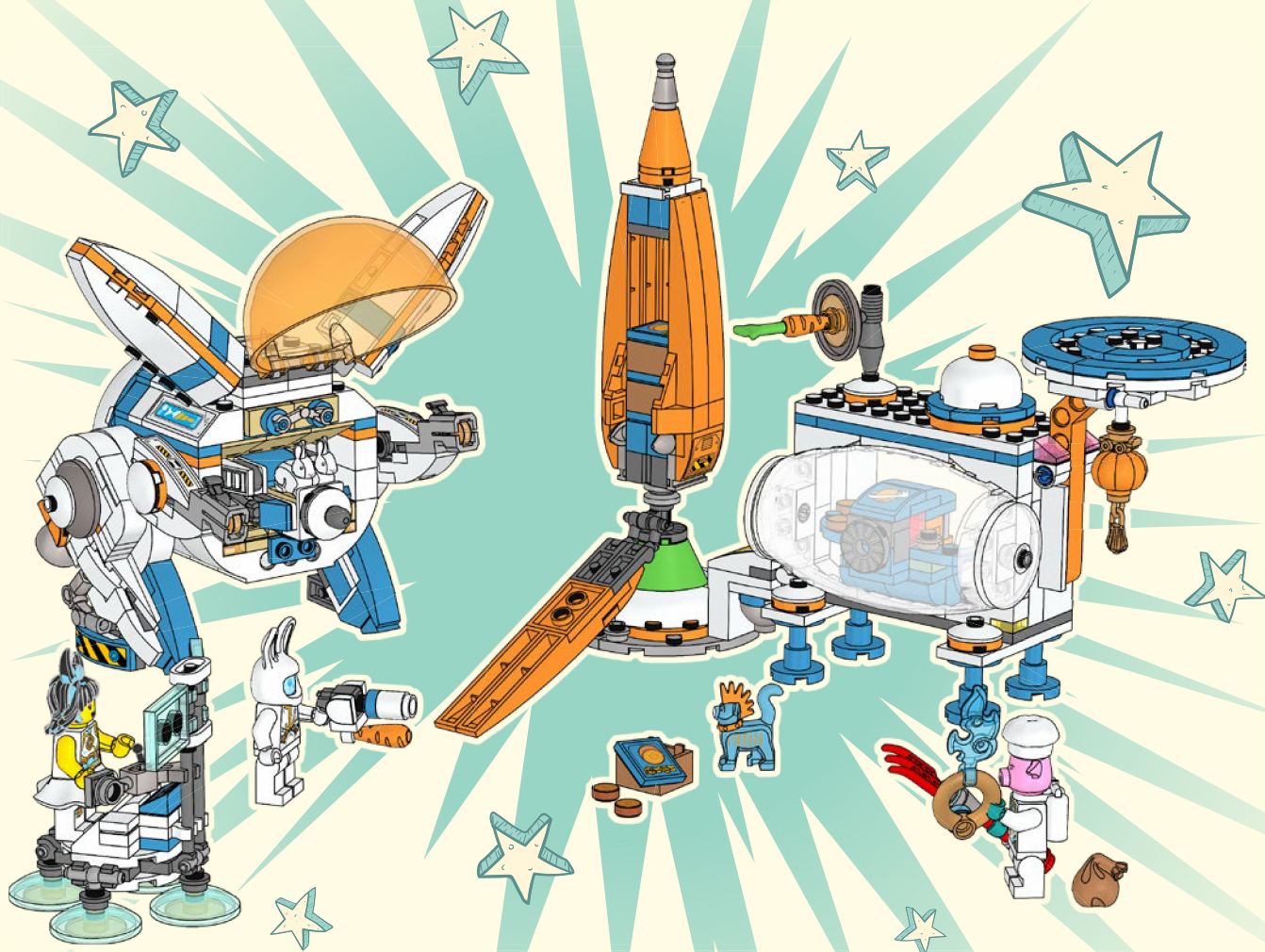





# MONKIE KID 悟空小侠™

80030



80033



80034



80032



80035



80031





# MONKIE KID 悟空小侠™

80036





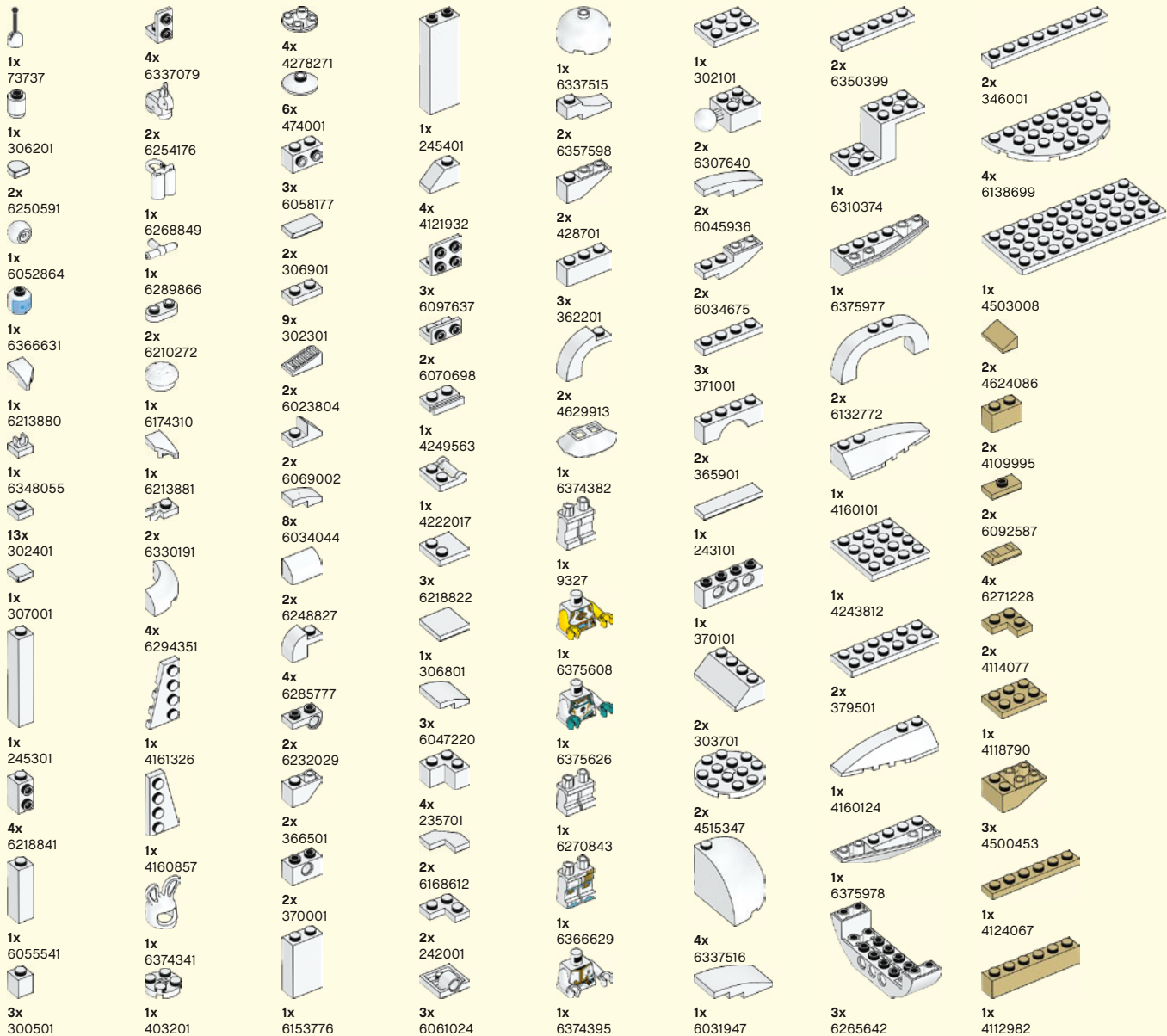





Customer Service

Kundenservice

Service Consommateurs

Servicio Al Consumidor

LEGO.com/service or dial





# WIN

Terms & Conditions apply

Scan this QR code or go to **LEGO.COM/PRODUCTFEEDBACK** and give us your short feedback about this LEGO® set for a chance to win a cool LEGO prize.



## GEWINNE

Scanne diesen QR-Code oder geh auf [LEGO.COM/PRODUCTFEEDBACK](https://LEGO.COM/PRODUCTFEEDBACK)

und gib uns dein kurzes Feedback zu diesem LEGO® Set. Dann hast du die Chance, einen coolen LEGO Preis zu gewinnen.

Es gelten die Teilnahmebedingungen

## GAGNE

Scannez ce code QR ou rendez-vous sur [LEGO.COM/PRODUCTFEEDBACK](https://LEGO.COM/PRODUCTFEEDBACK)

pour donner votre avis sur ce produit LEGO® et avoir une chance de gagner un prix LEGO.

Voir Conditions Générales

## GANAN

Escanea este código QR o visita [LEGO.COM/PRODUCTFEEDBACK](https://LEGO.COM/PRODUCTFEEDBACK)

y comparte con nosotros tu opinión sobre este set LEGO® para tener la oportunidad de ganar un fantástico premio LEGO.

Términos y Condiciones aplicables

## 获取奖品

只需扫描此二维码或访问 [LEGO.COM/PRODUCTFEEDBACK](https://LEGO.COM/PRODUCTFEEDBACK),

就这款乐高®套装提供简短反馈, 就有机会赢得很酷的乐高奖品。

《条款及条件》适用

LEGO and the LEGO logo are trademarks of the/son des marques de commerce du/son marcas registradas de LEGO Group.  
©2022 The LEGO Group.

6429468