



Disney

41164



Disney
FROZEN II

 [LEGO.com/disney](https://www.LEGO.com/disney)



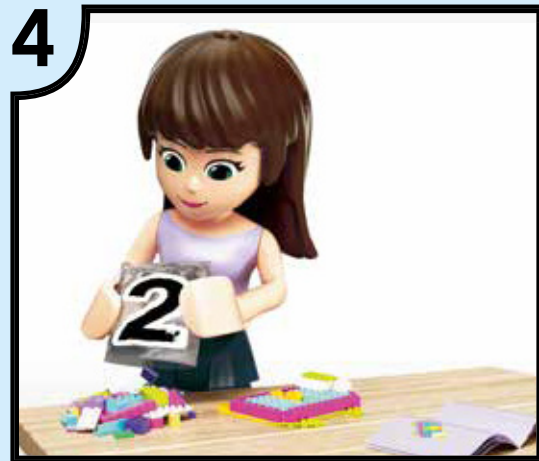
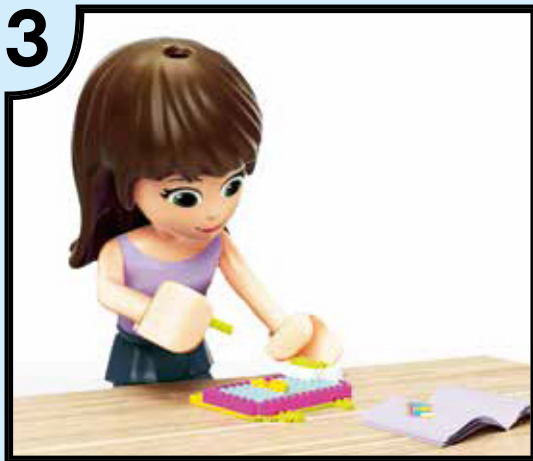
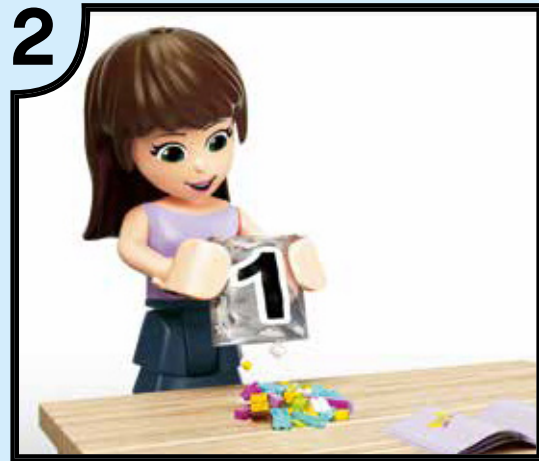

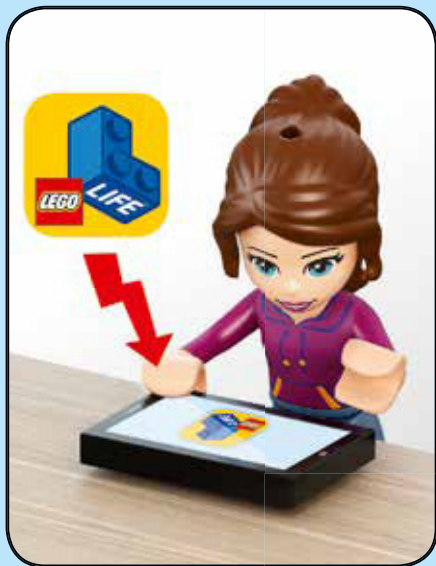

- 1** Download the LEGO® Life App
Lade dir die LEGO® Life App
herunter
Télécharge l'application LEGO® Life
Télécharger l'application LEGO® Life
Scarica l'app LEGO® Life
Descarga la app LEGO® Life
Descarrega a App LEGO® Life
Töltsd le a LEGO® Life Appot!
Lejupielādē lietotni LEGO® Life
下載 LEGO® Life 应用程序

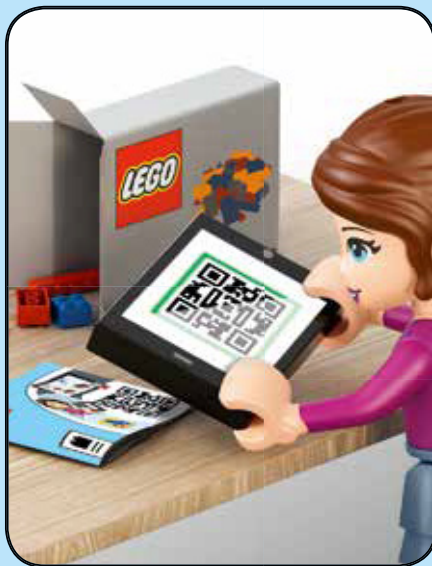

- 2** Scan the code on the front cover
Scanne den Code auf der Titelseite
Scanne le code sur la page de
couverture
Scanner le code sur la page
couverture
Scansiona il codice sulla copertina
Escanea el código de la portada
Faz scan do código na frente da capa
Olvasd be a borítón látható kódot!
Noskenē kodu uz priekšējā vāka
扫描封面上的二维码



- 3** Get the Building Instructions
Hol dir die Bauanleitung
Obtiens les instructions de montage
Obtenir les instructions de montage
Scarica le istruzioni per la
costruzione
Consulta las instrucciones de
construcción
Obtém as Instruções de Construção
Szerezd be az építési útmutatókat!
Saņem būvēšanas instrukcijas
获取拼搭说明

LEGO.com/apps

Check for compatibility
Kompatibilität prüfen
Vérifier la compatibilité
Controlla la compatibilità
Comprueba tu compatibilidad

Verificar a compatibilidade
Ellenőrizd a kompatibilitást
Pārbaudīt saderību
检查兼容性

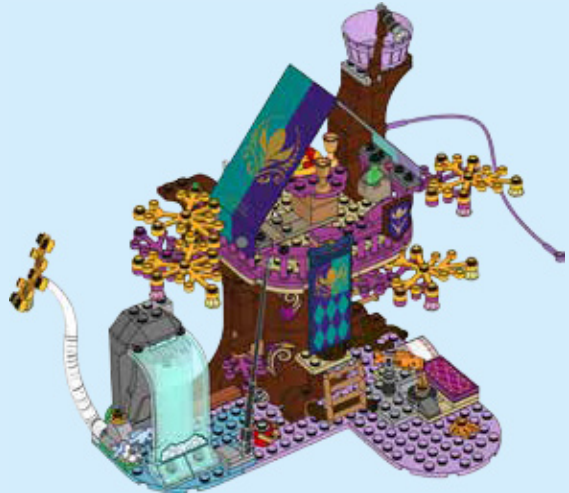
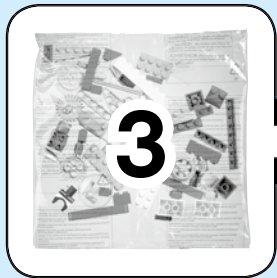
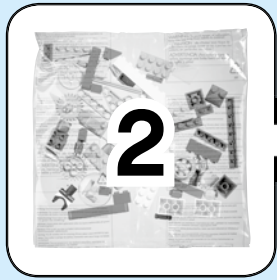

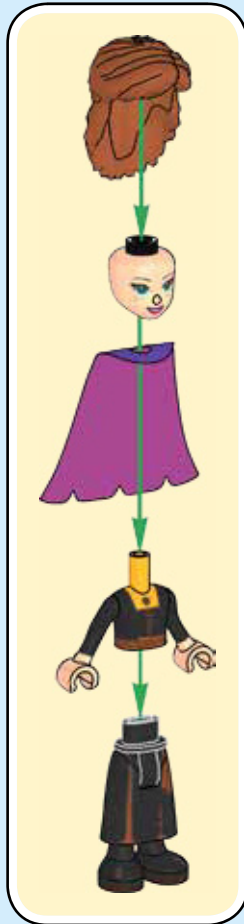
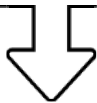
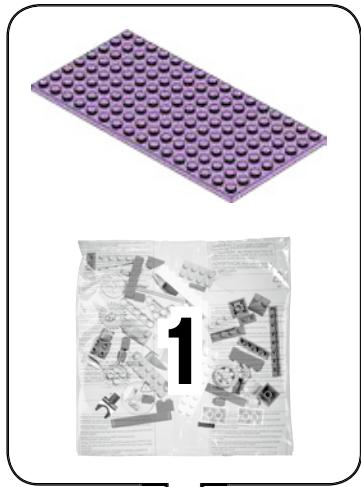



1x



1x



1x



1

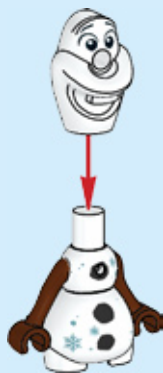

2



1

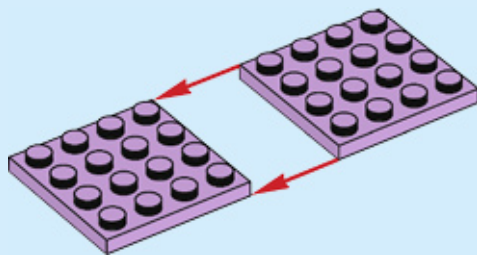

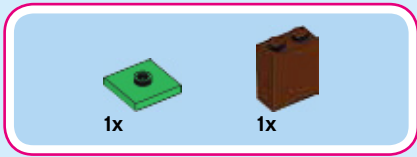

2

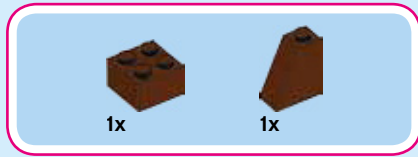
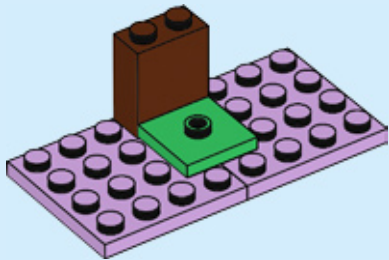

3

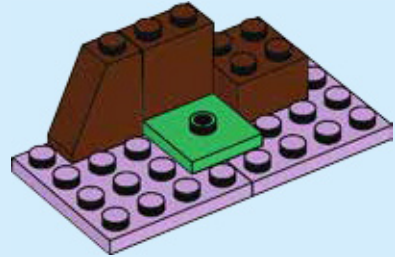

4

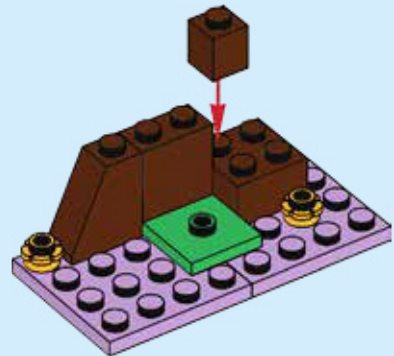



2x

5

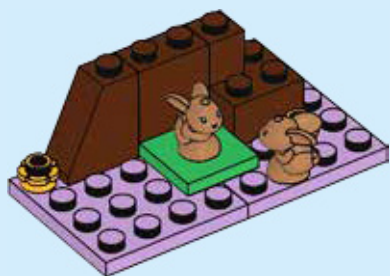

1x



1x

6



2x

7



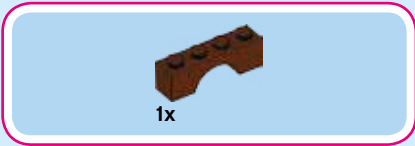

8

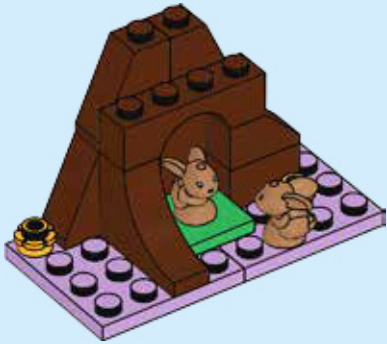

9

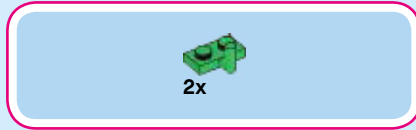
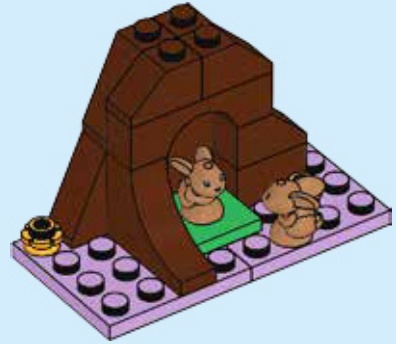

10



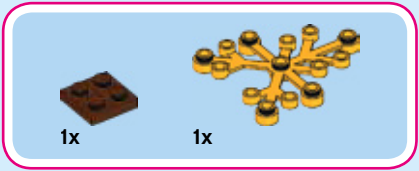

11

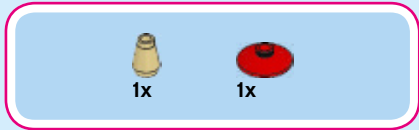

12

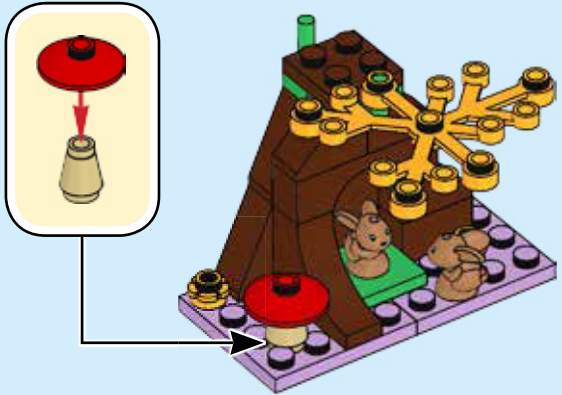

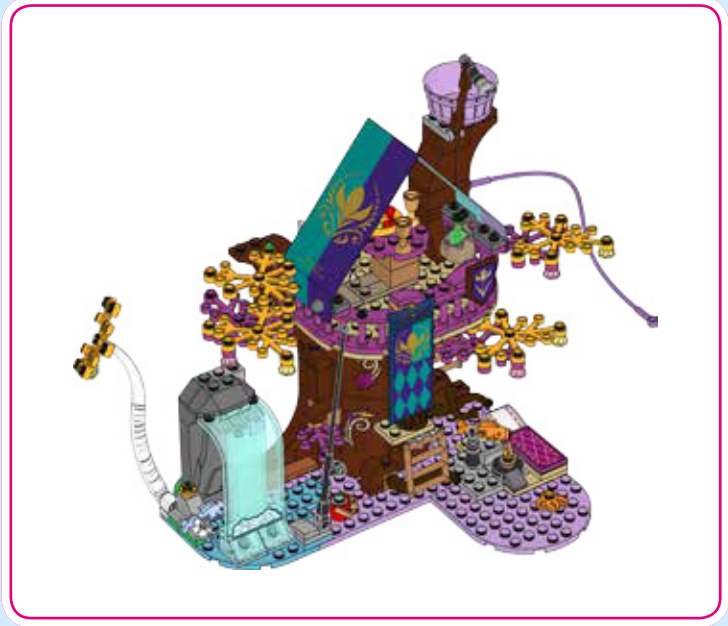

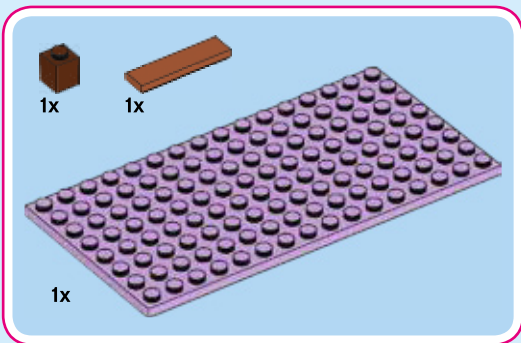
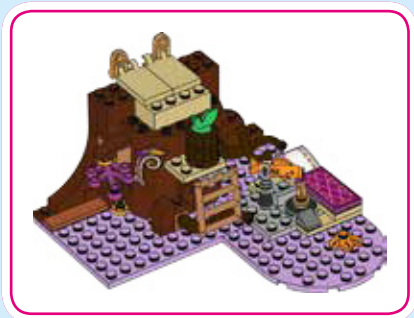

1

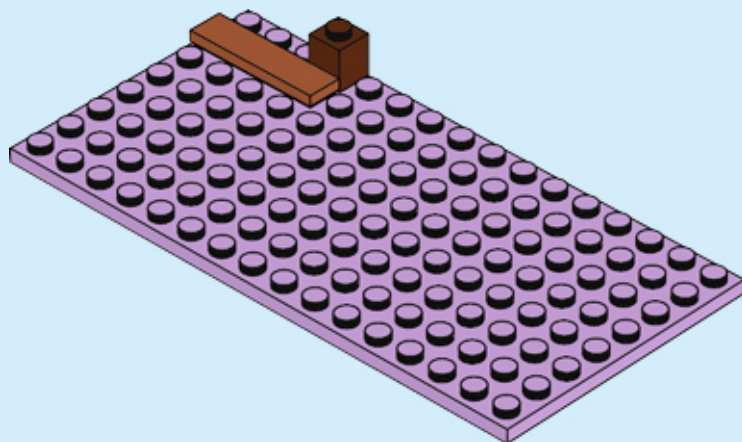

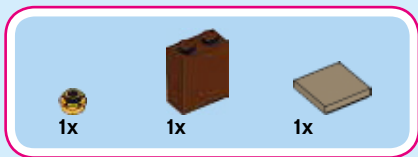

2

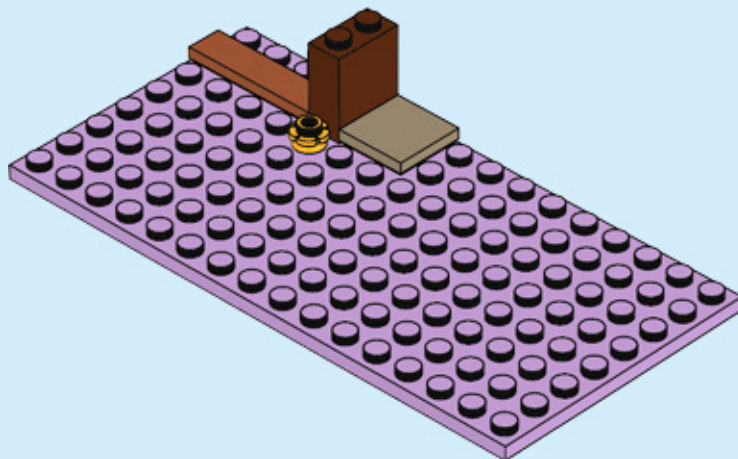

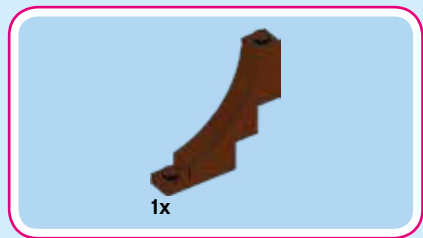

3

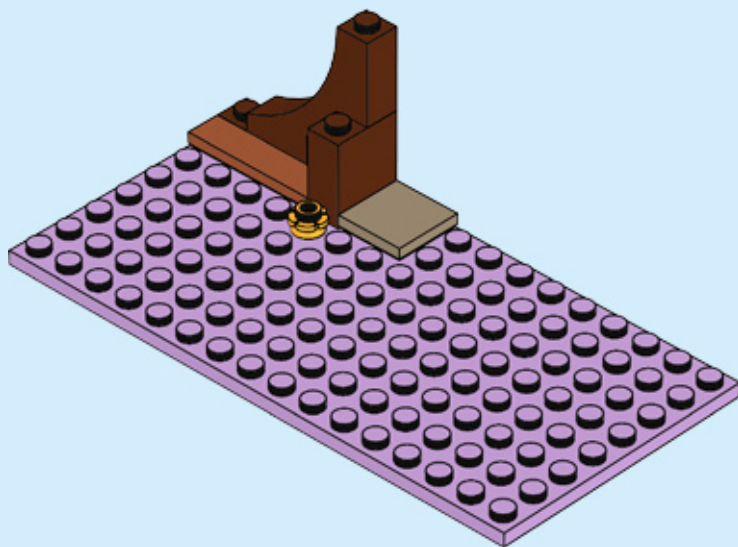



4

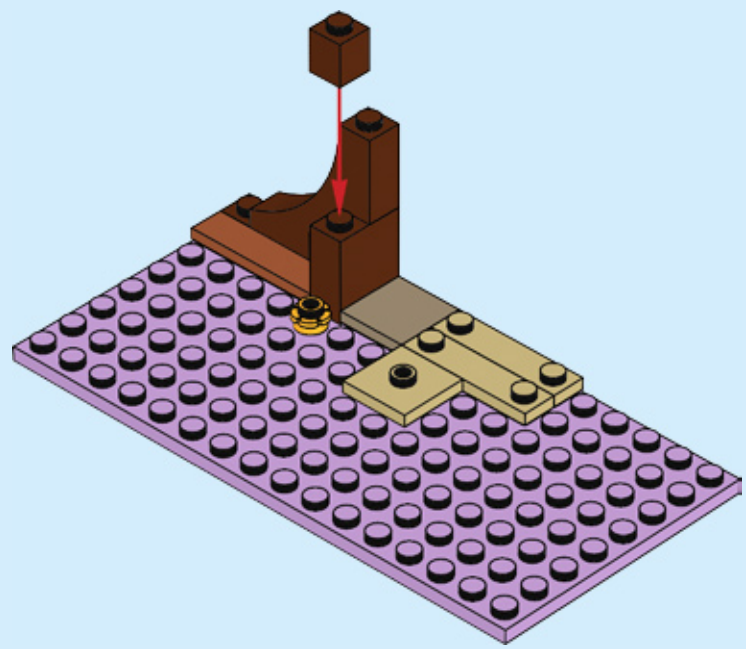

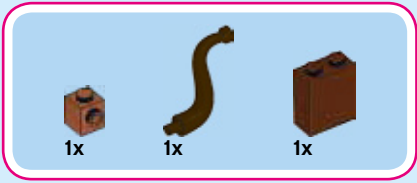

5

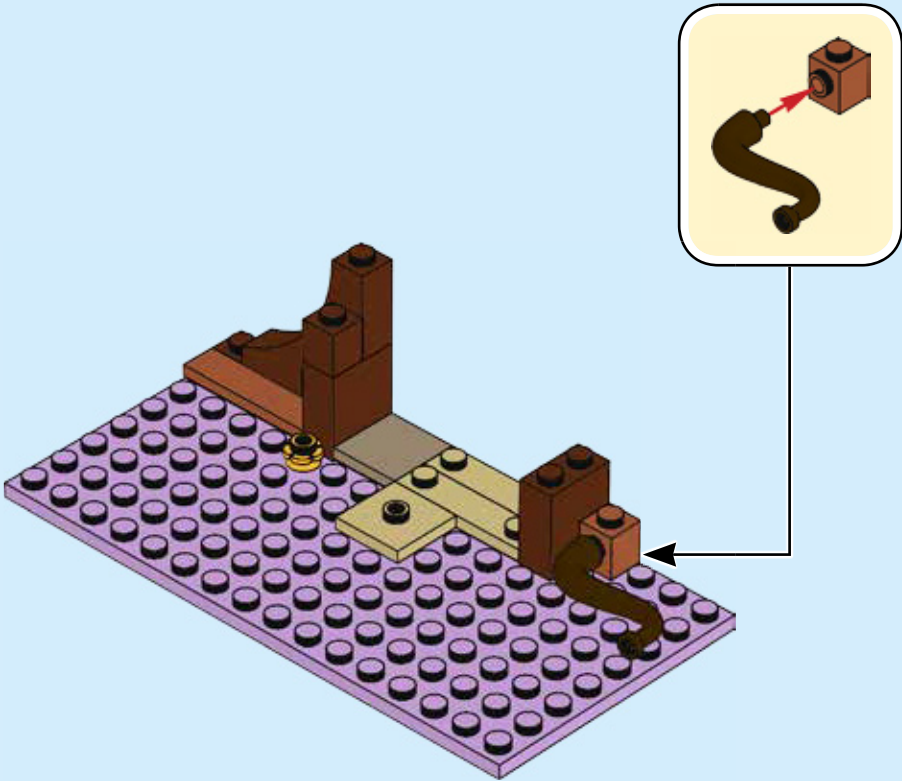

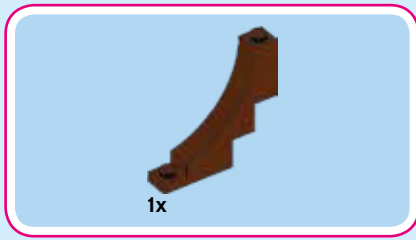

6

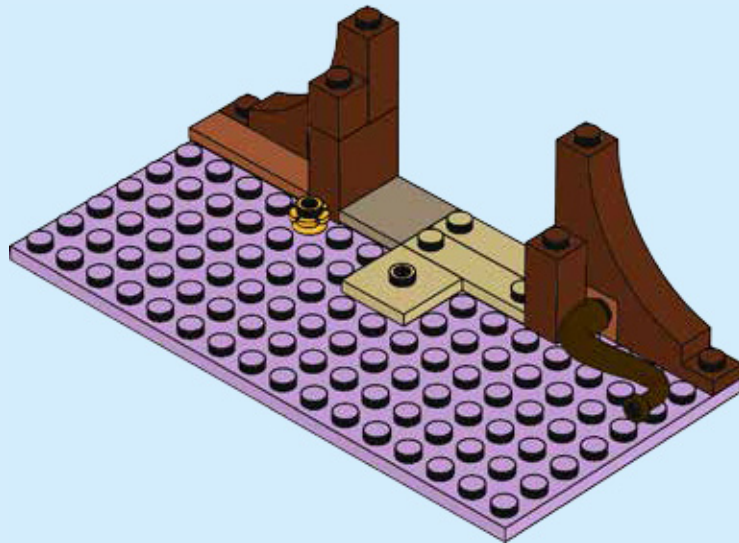

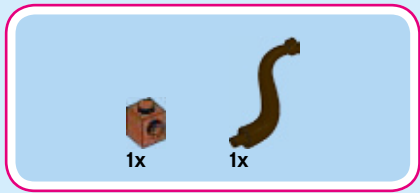

7

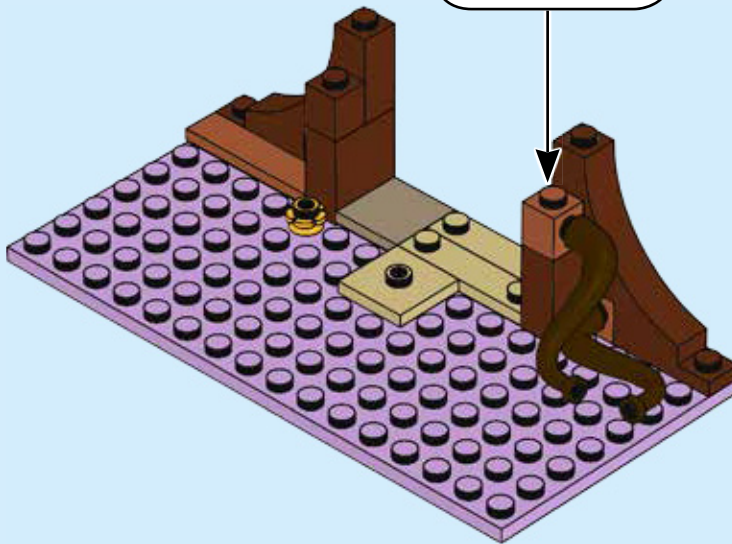
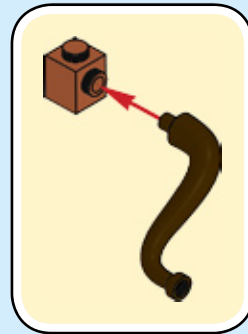

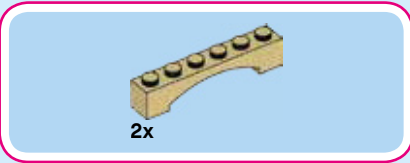

8

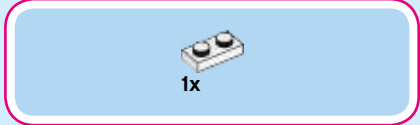
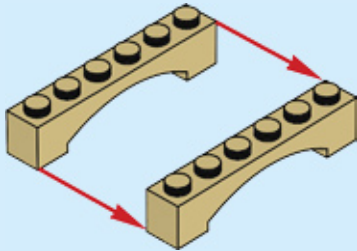

9

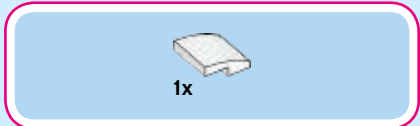
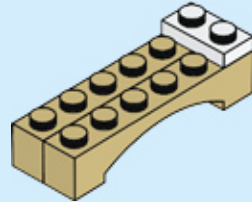

10

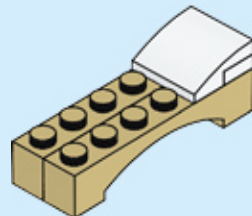

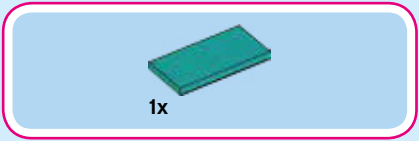

11

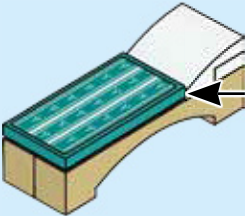
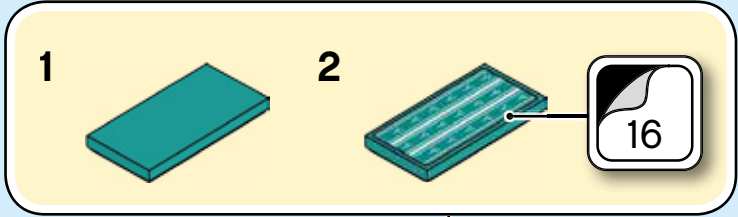

12

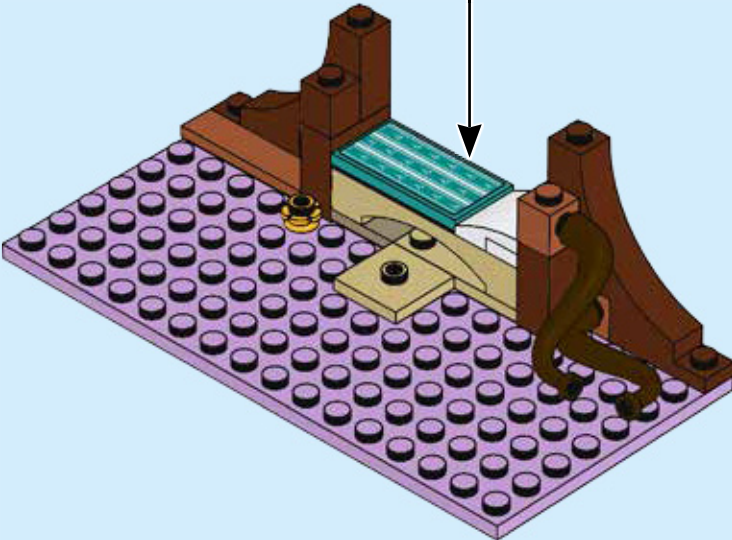



13

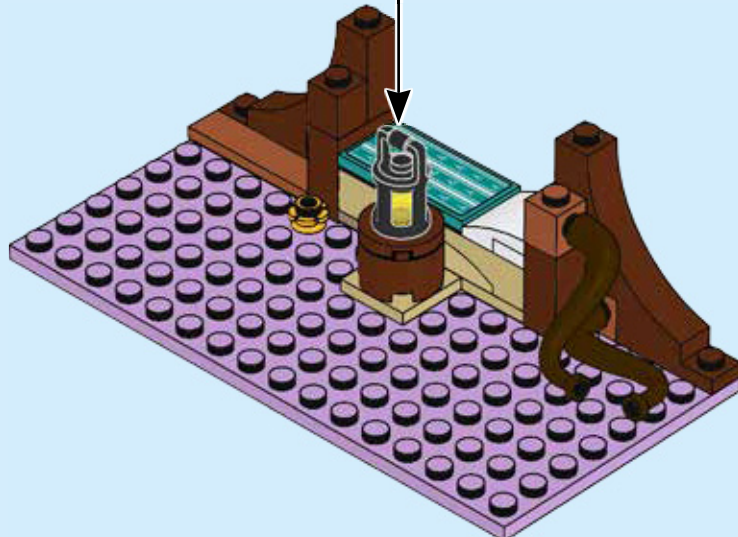
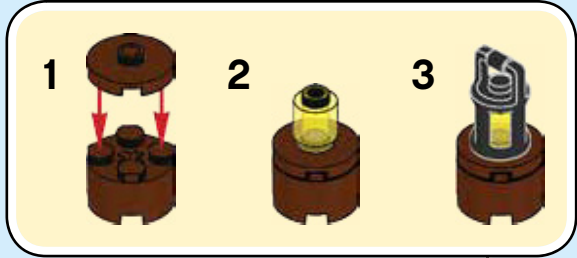

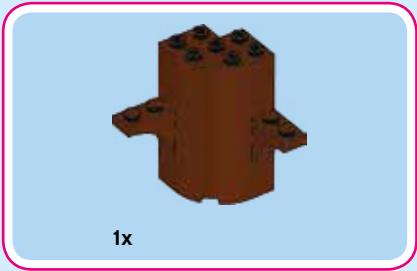

14

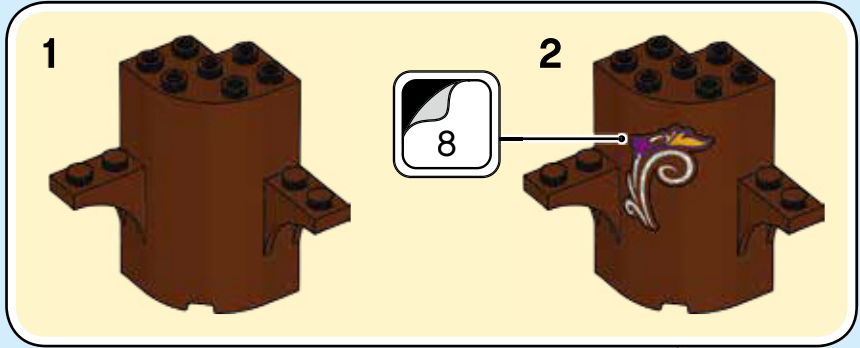

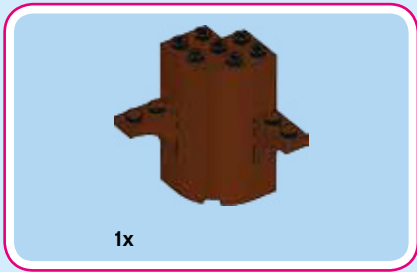

15

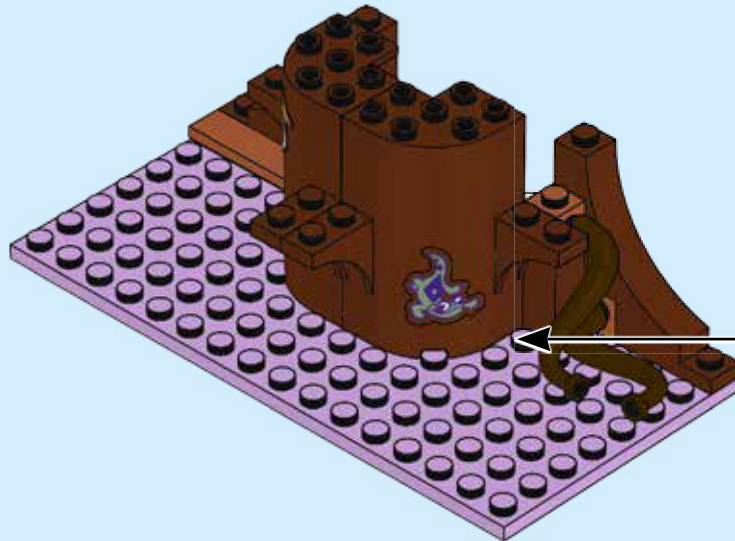
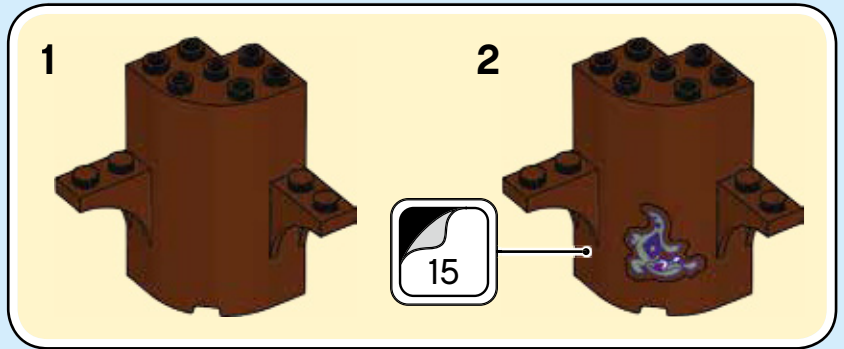



1x

16

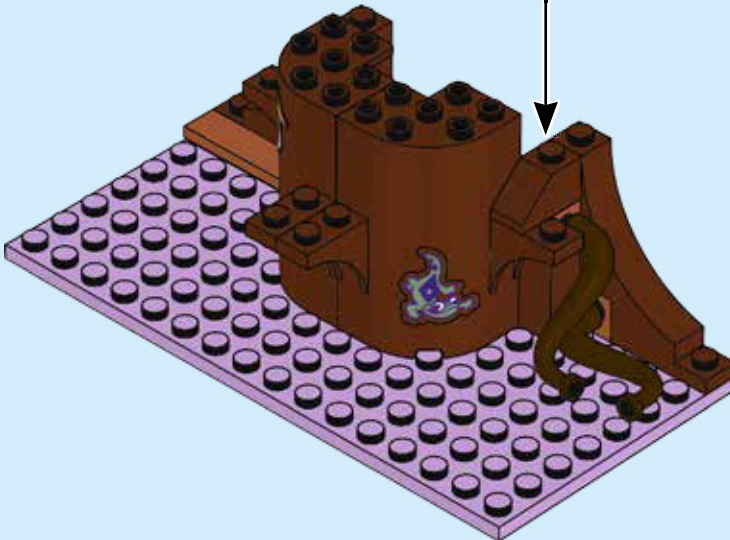



17

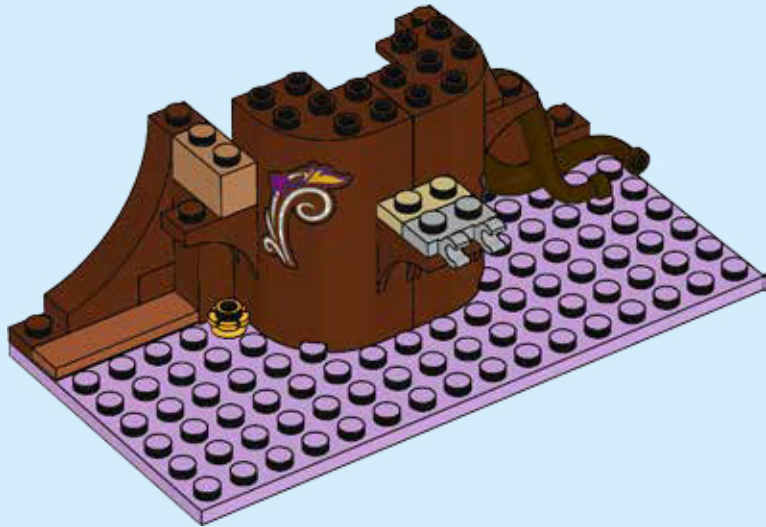

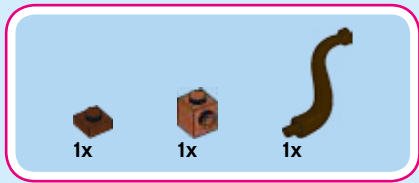

18

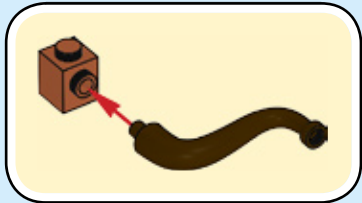



19

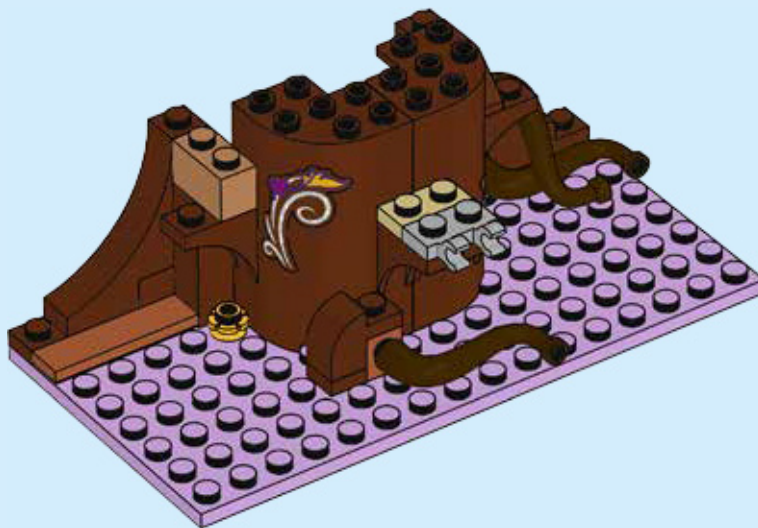

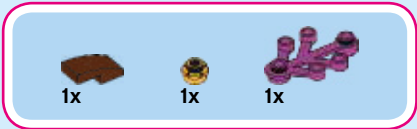

20

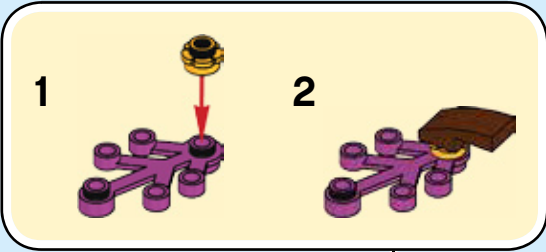

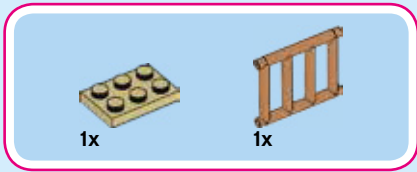

21

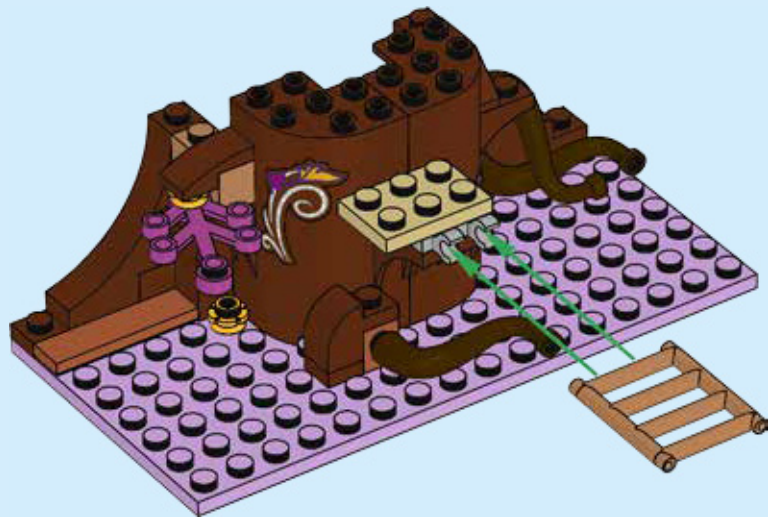

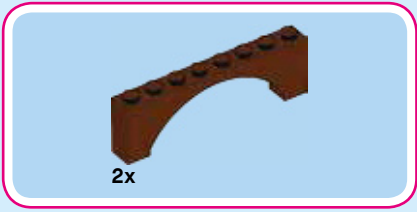

22





23





1x

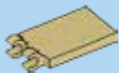

2x

24

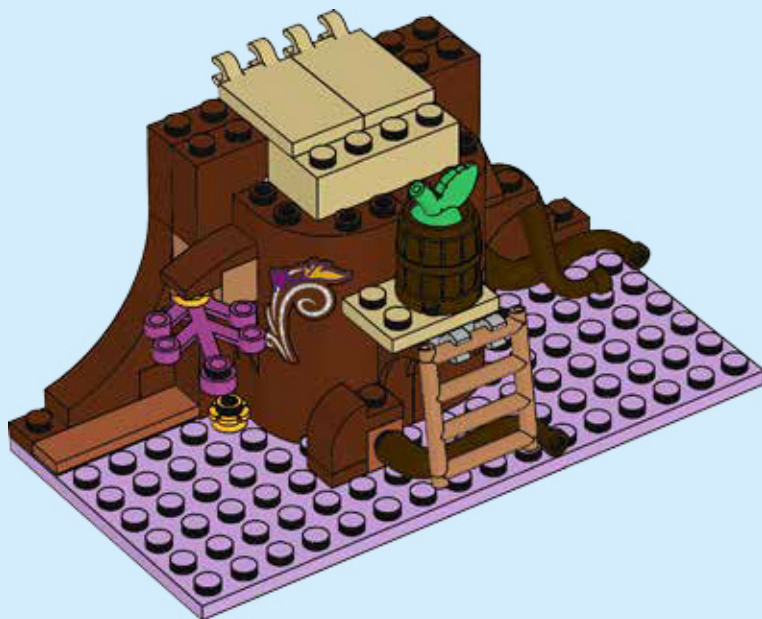



2x

25

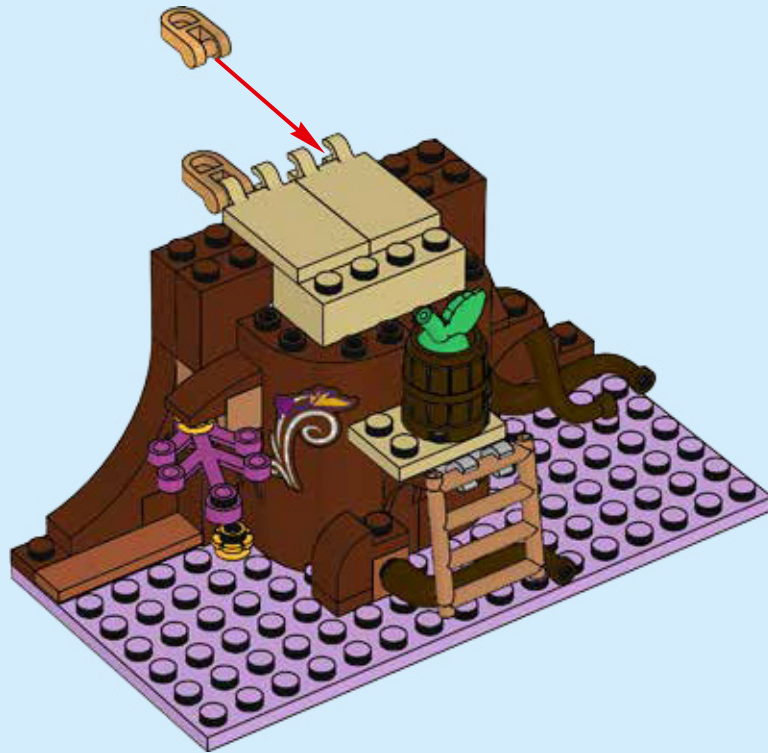



1x

26

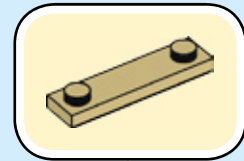
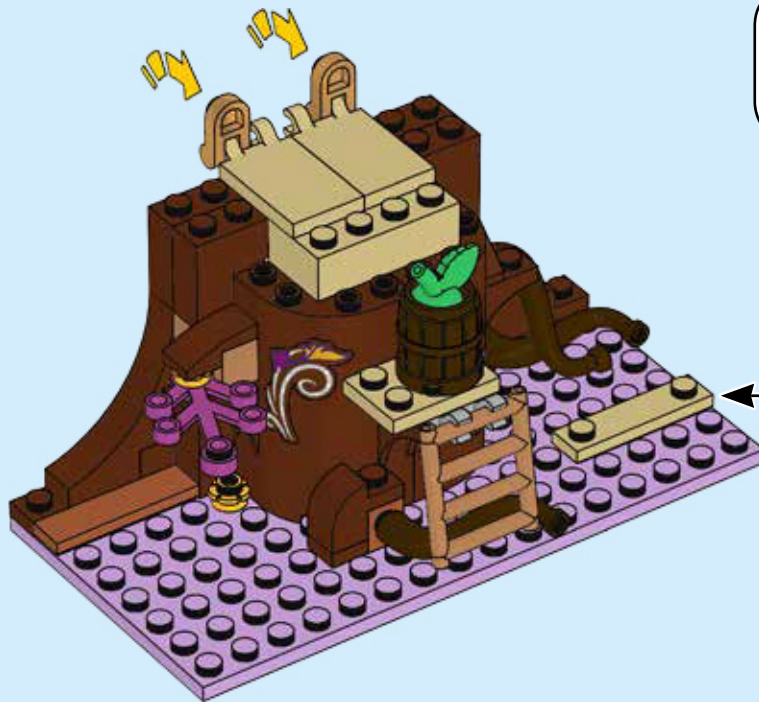

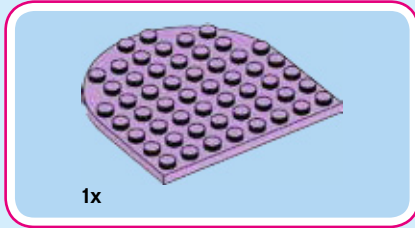

27

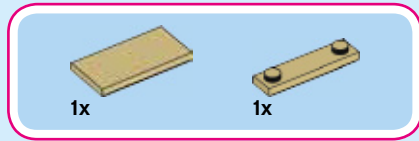
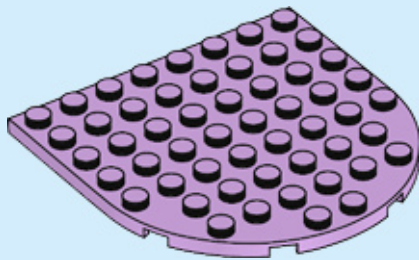

28

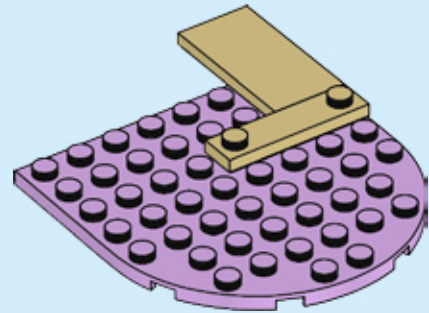

29

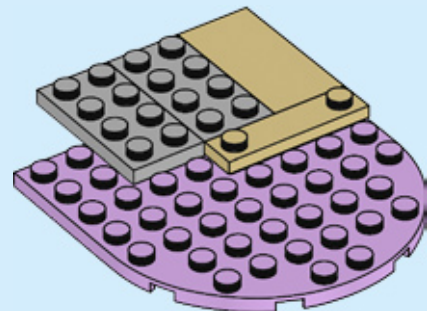



30

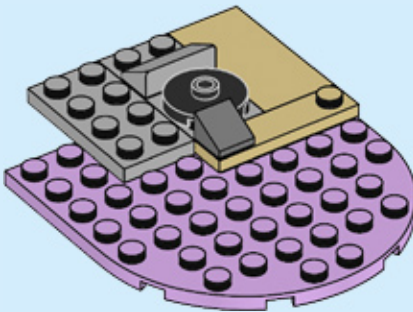

31

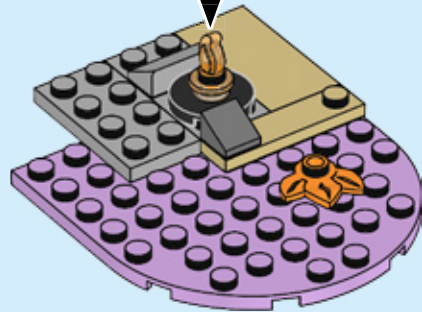
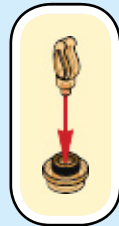

32

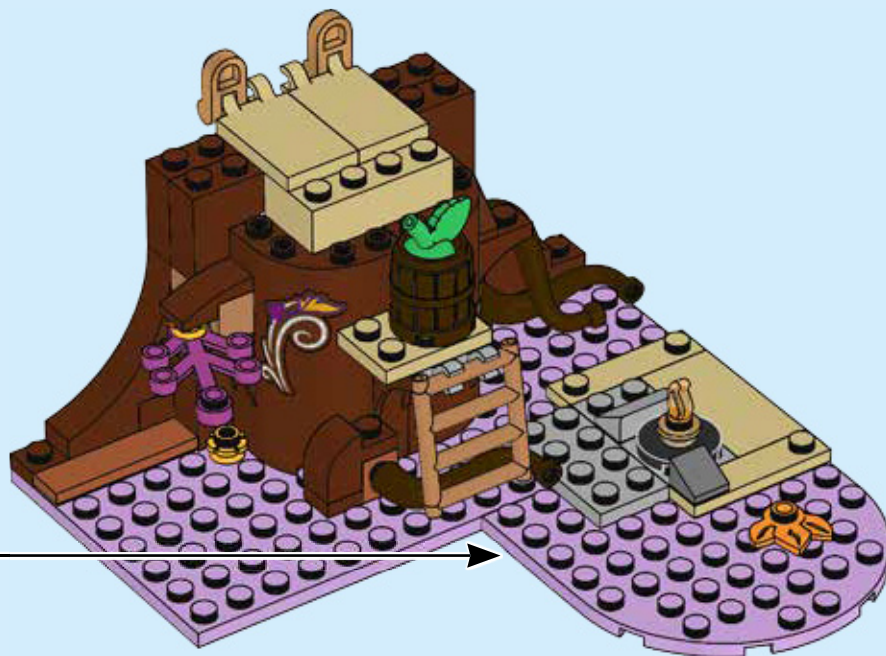

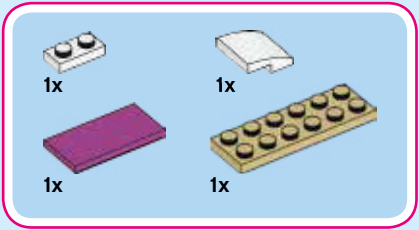

33

1

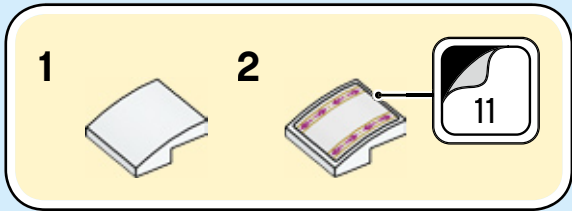
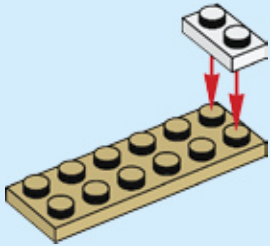

2

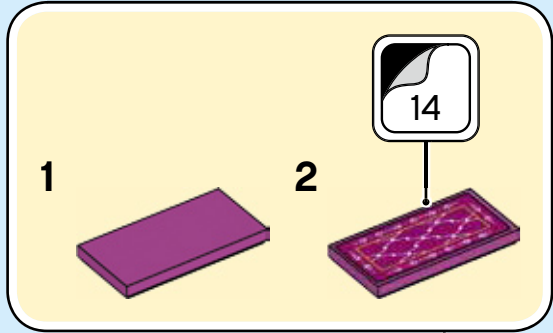
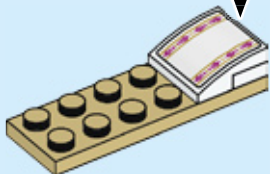

3

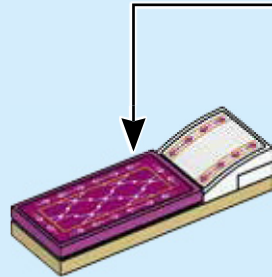





34

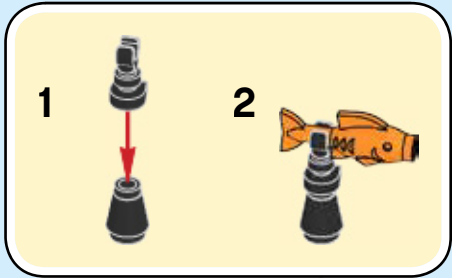

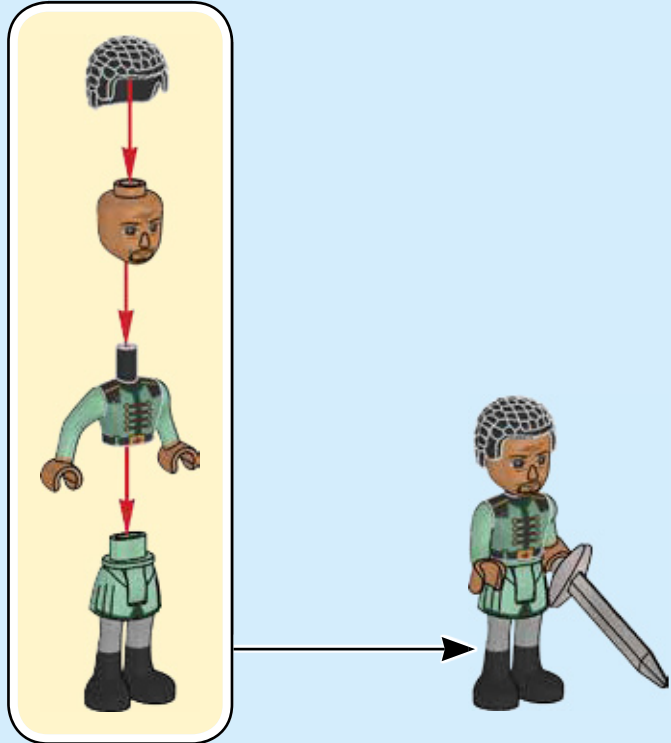

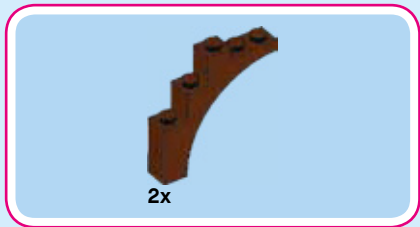

35

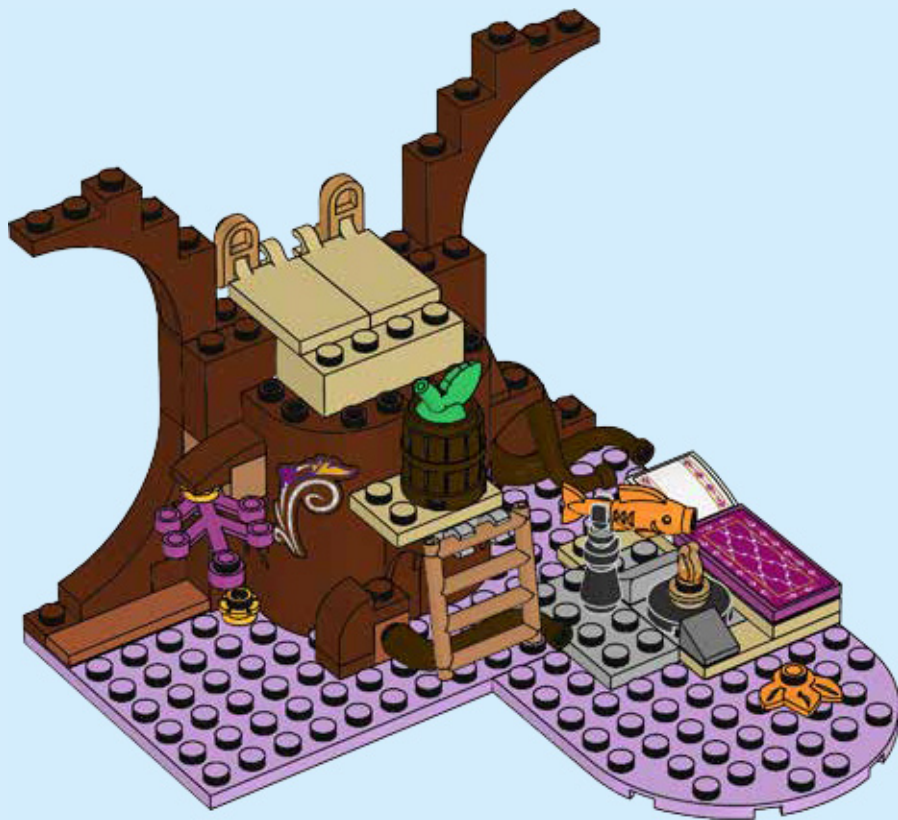

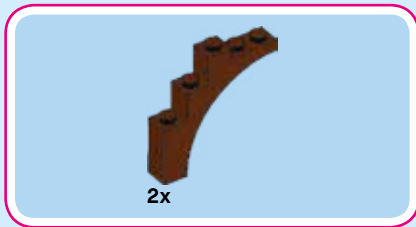

36

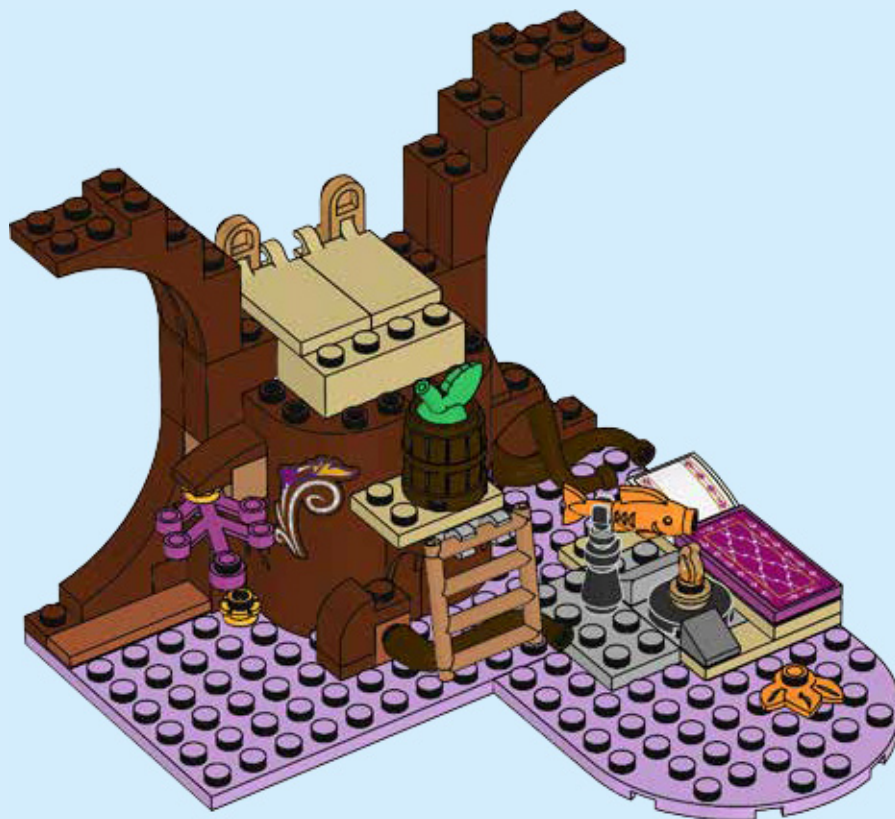

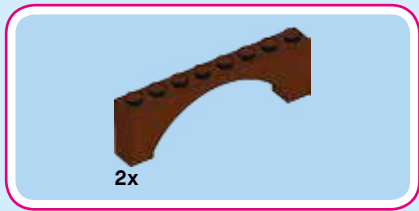

37

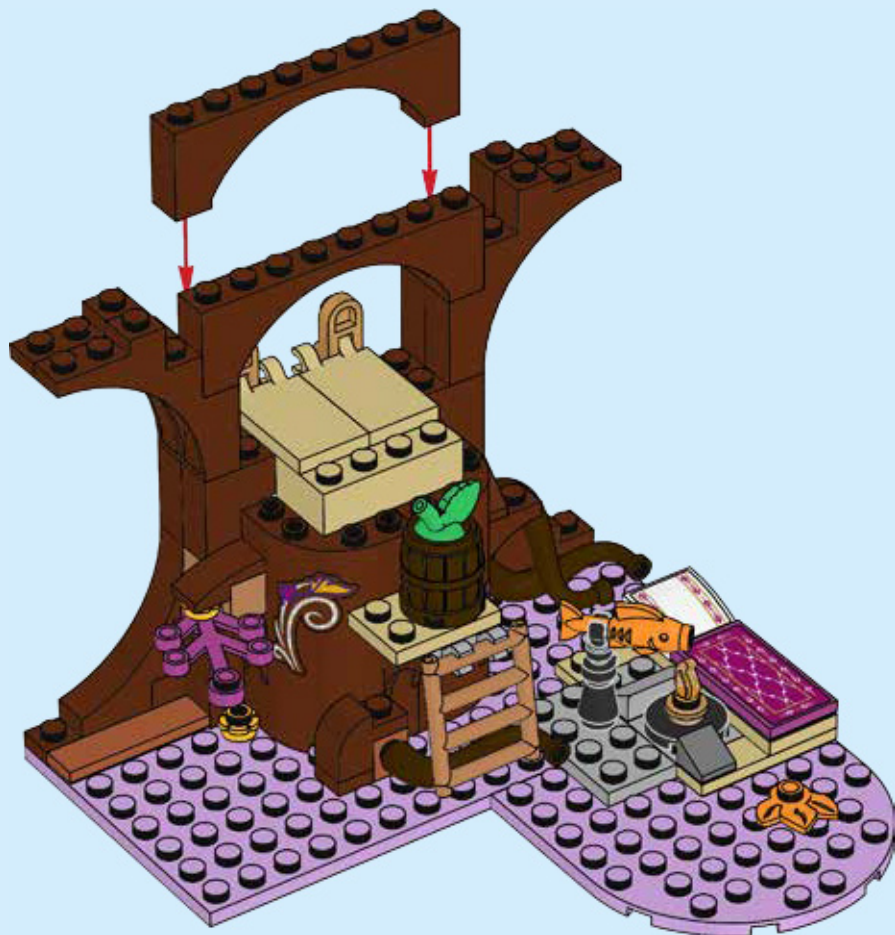



38

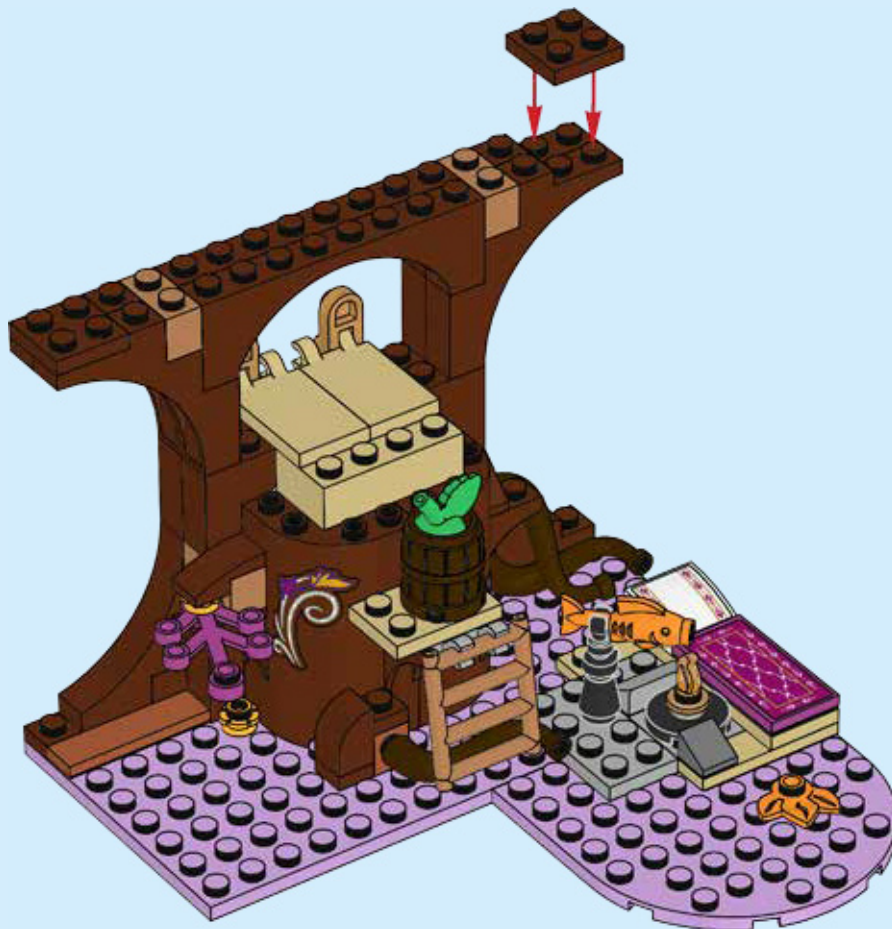

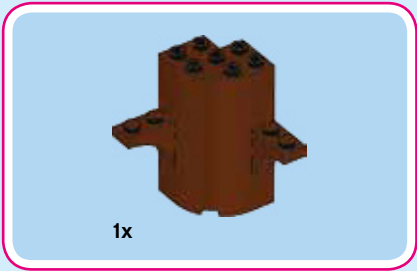

39

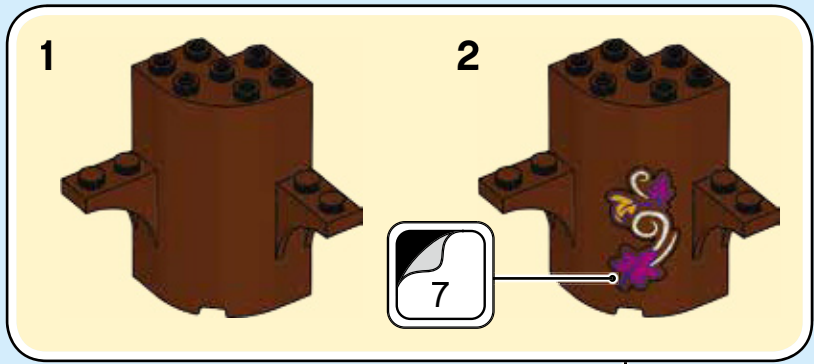

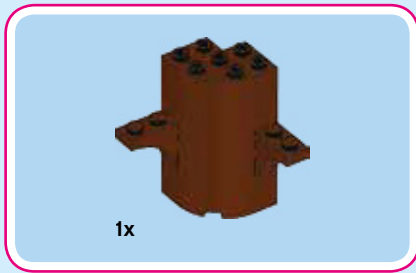

40

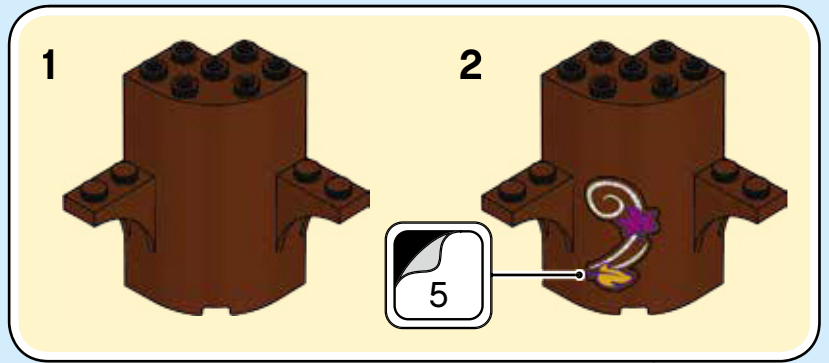
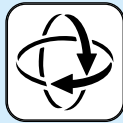



1x



1x

41





42

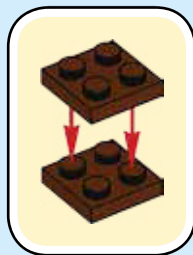

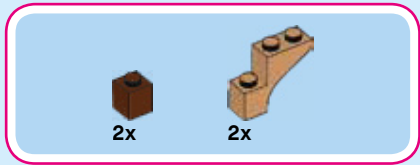

43

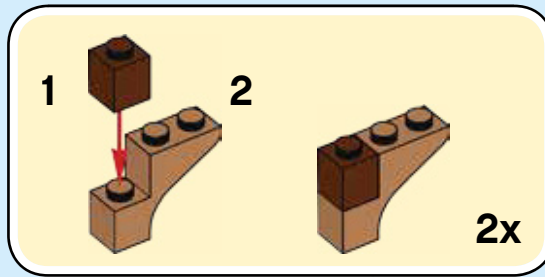

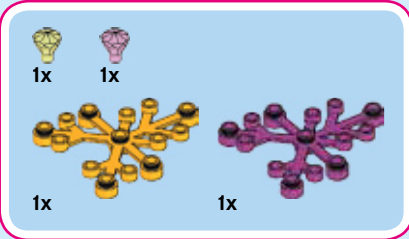

44

1



2



3





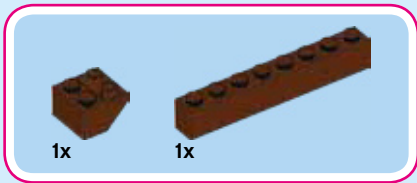

45

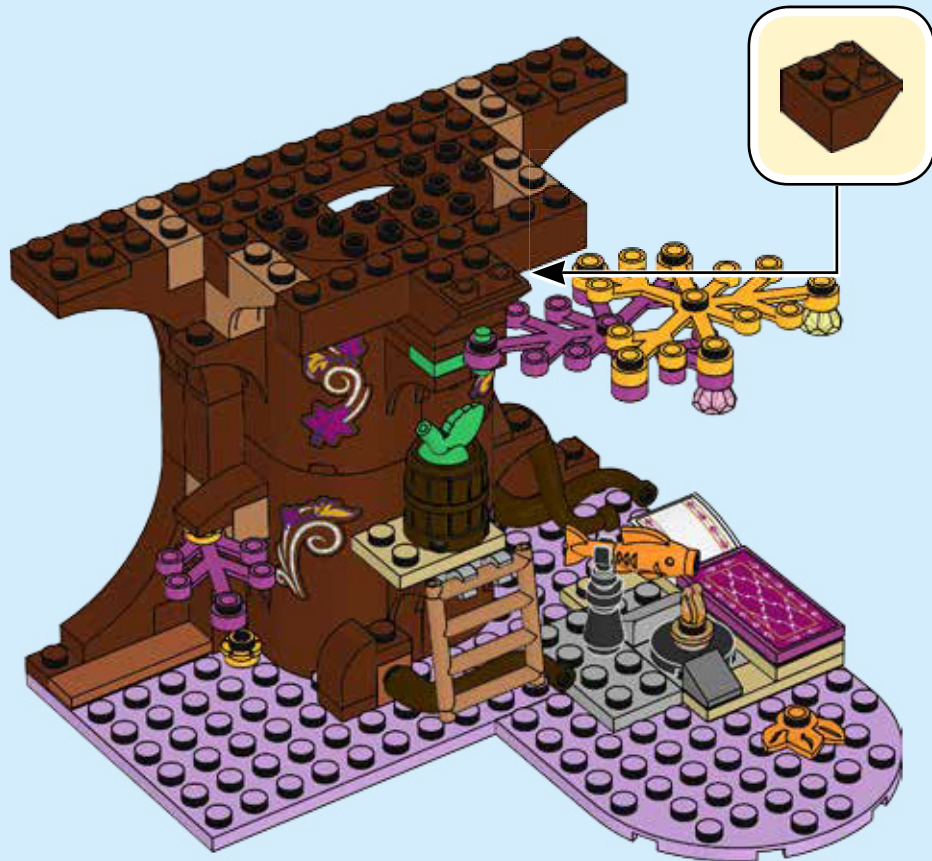



1x



2x

46

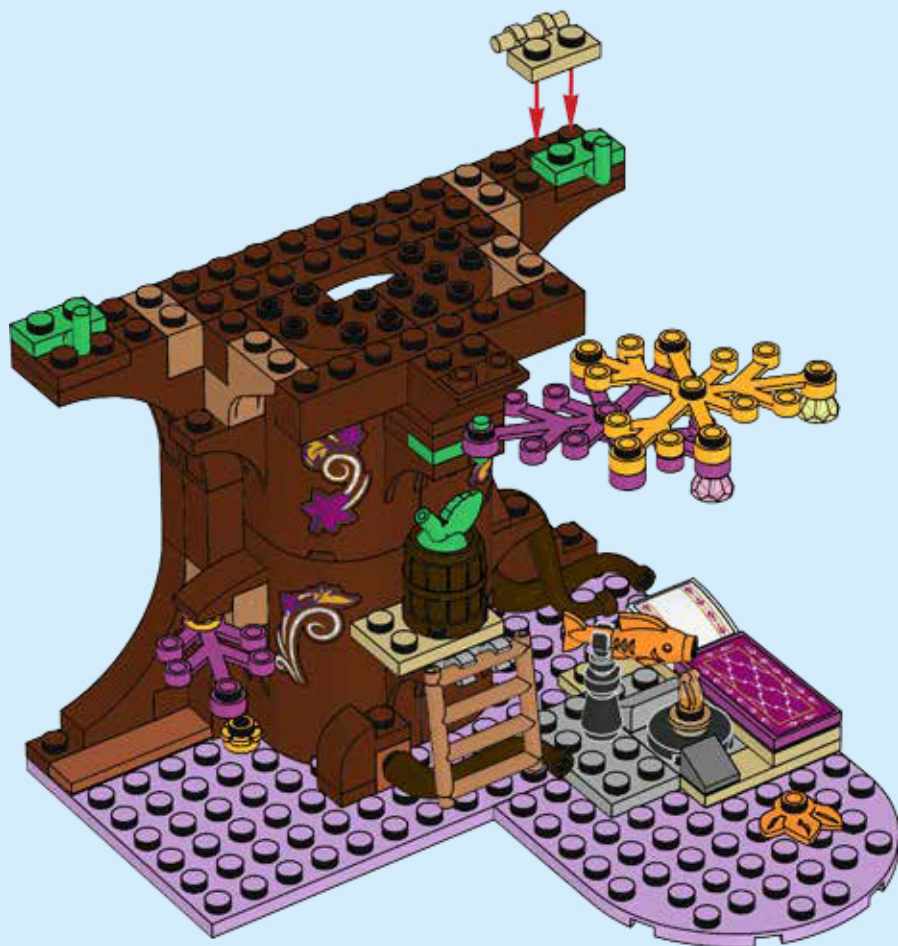

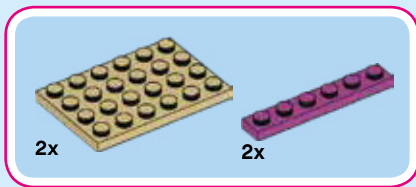

47

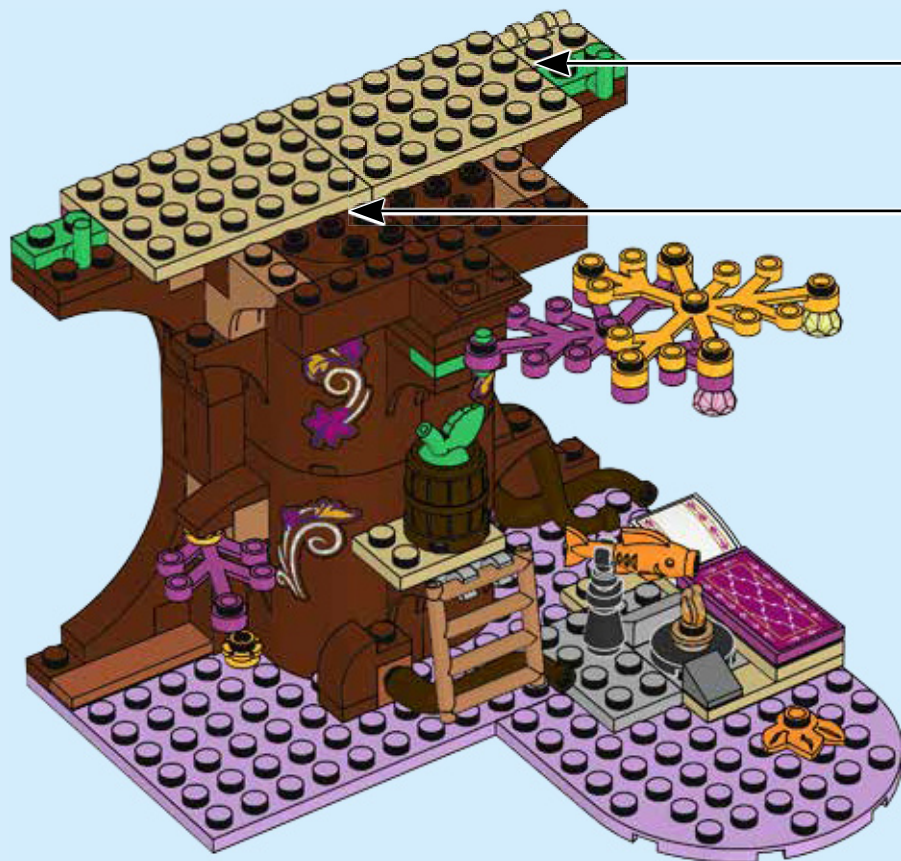
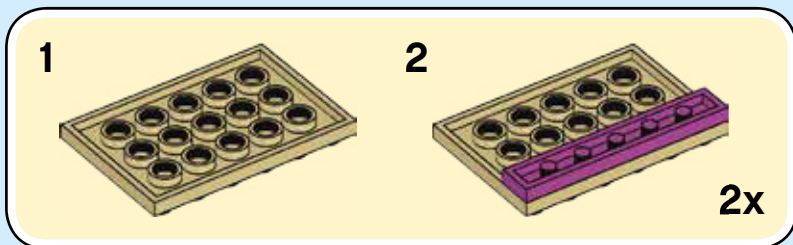

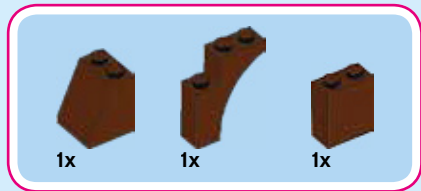

48



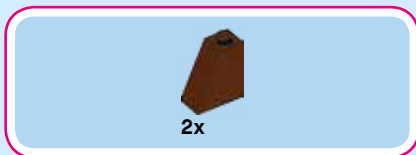

49



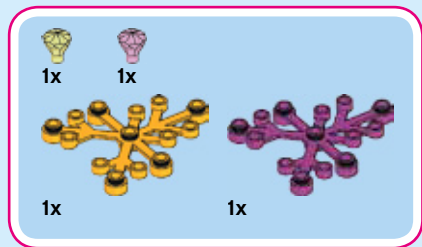

50

1



2



3



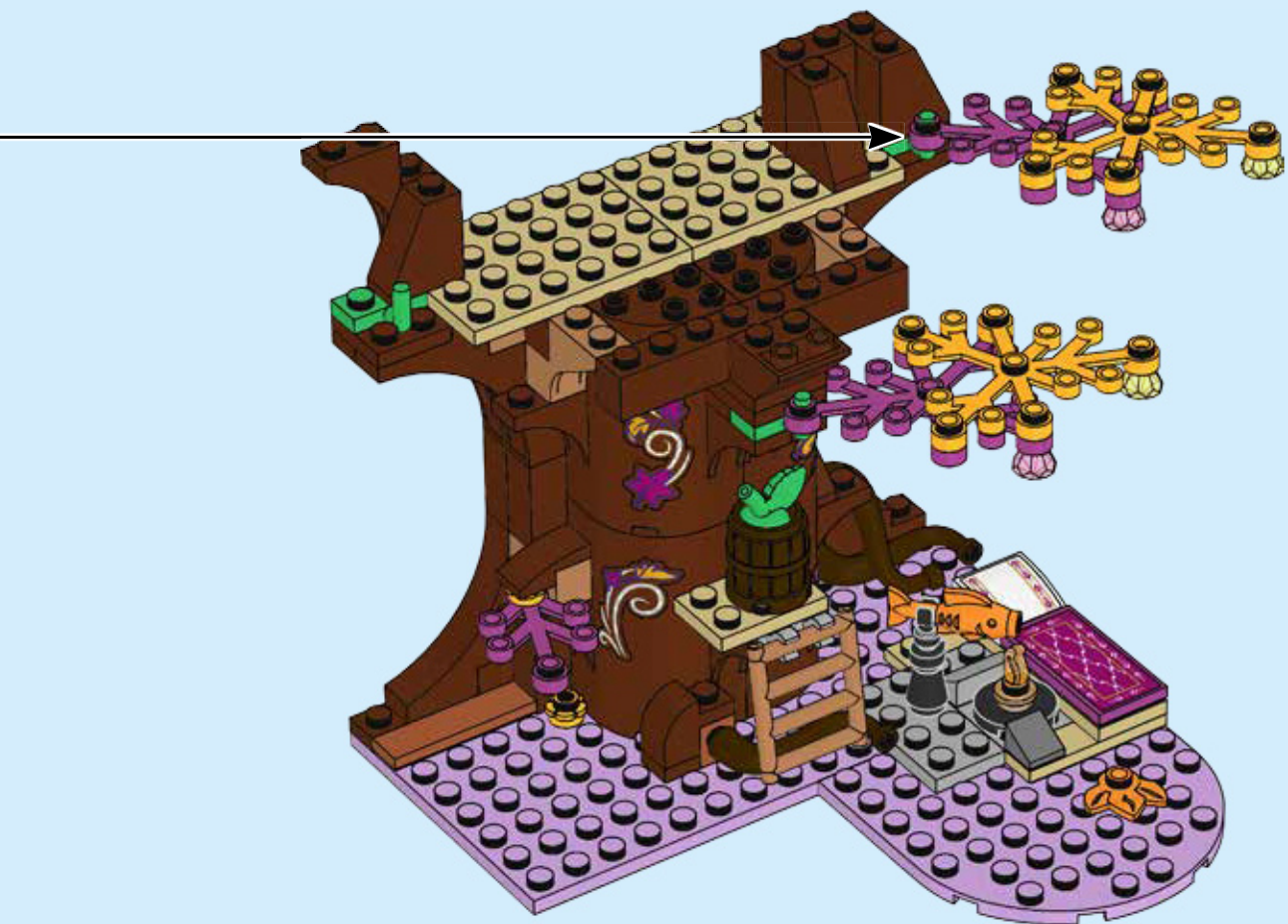

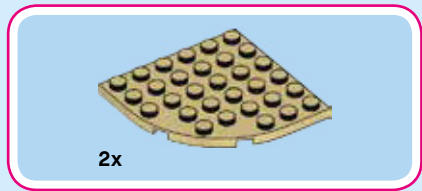

51

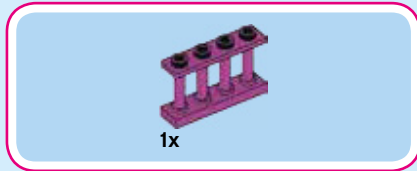
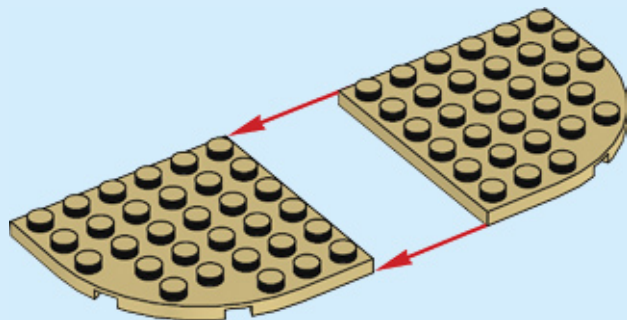

52

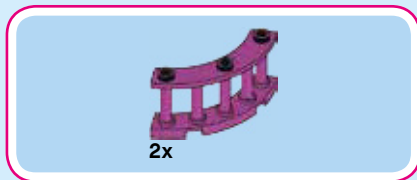
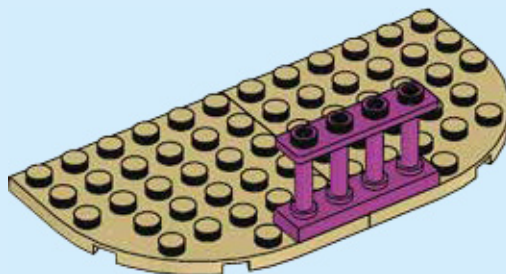

53

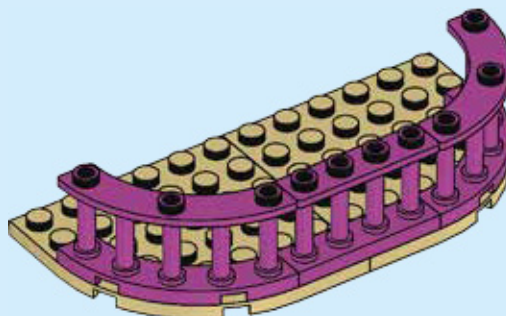

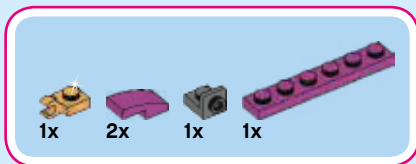

54

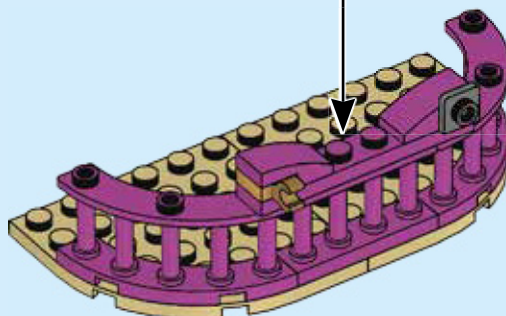
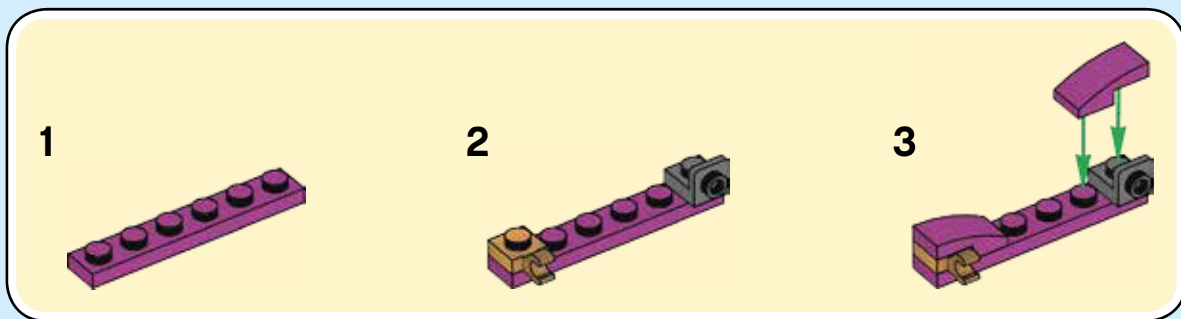

55

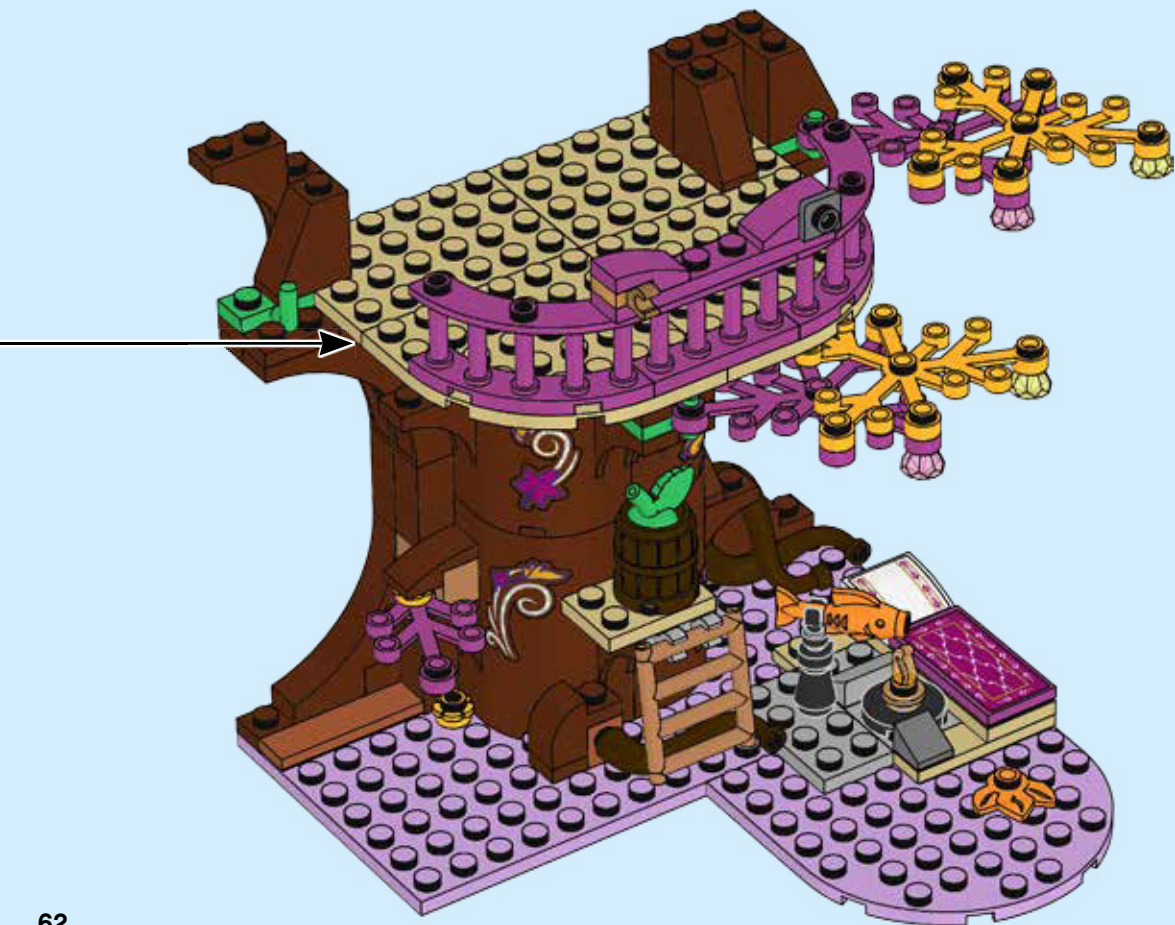

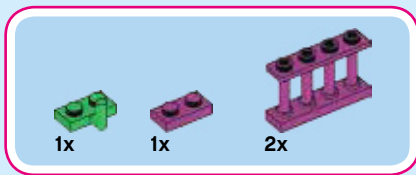

56

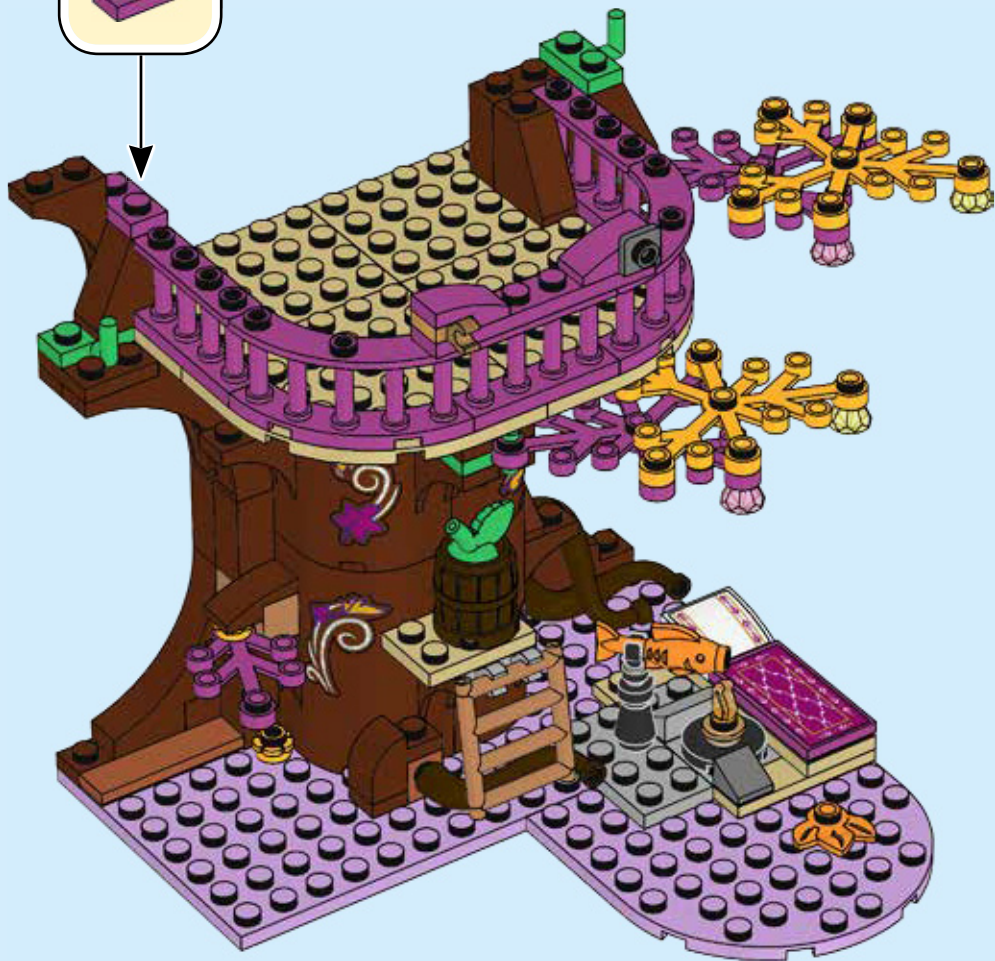
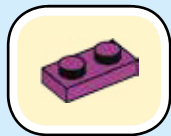

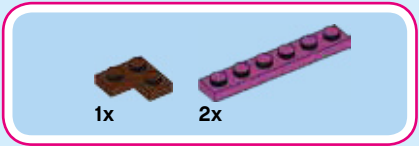

57

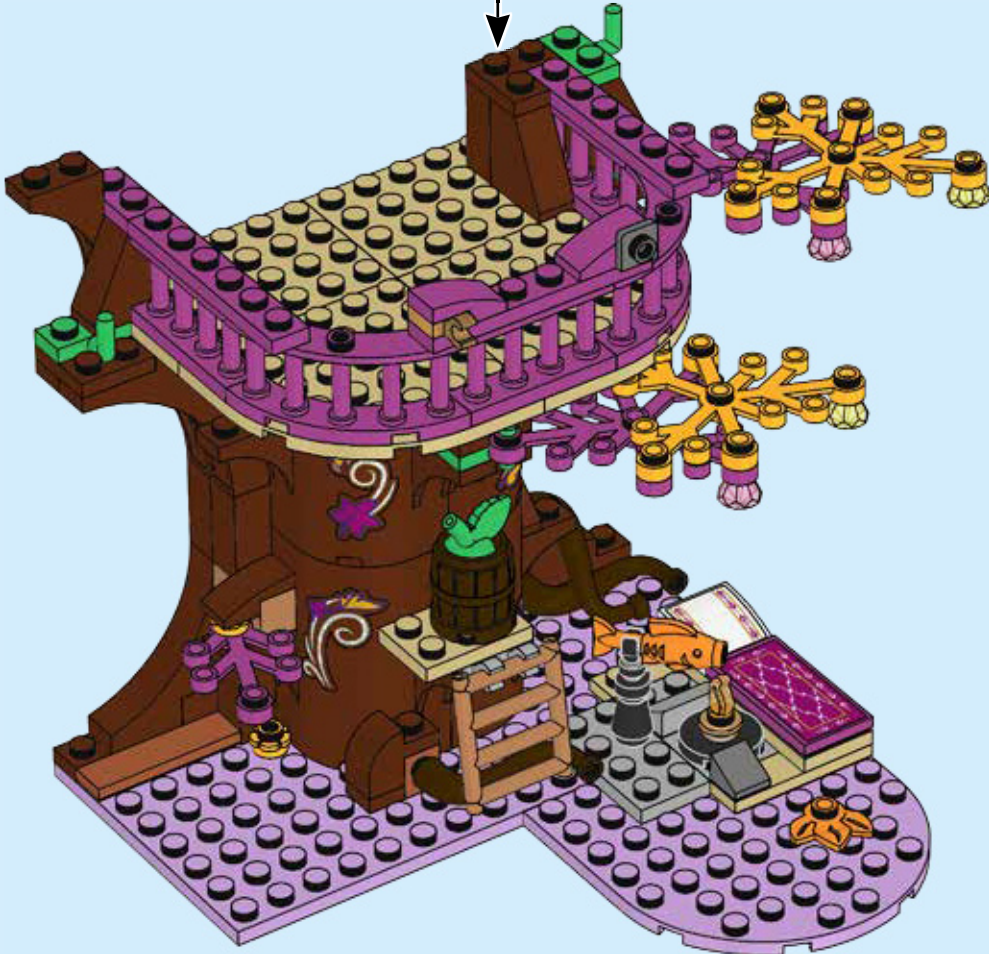



1x



2x

58

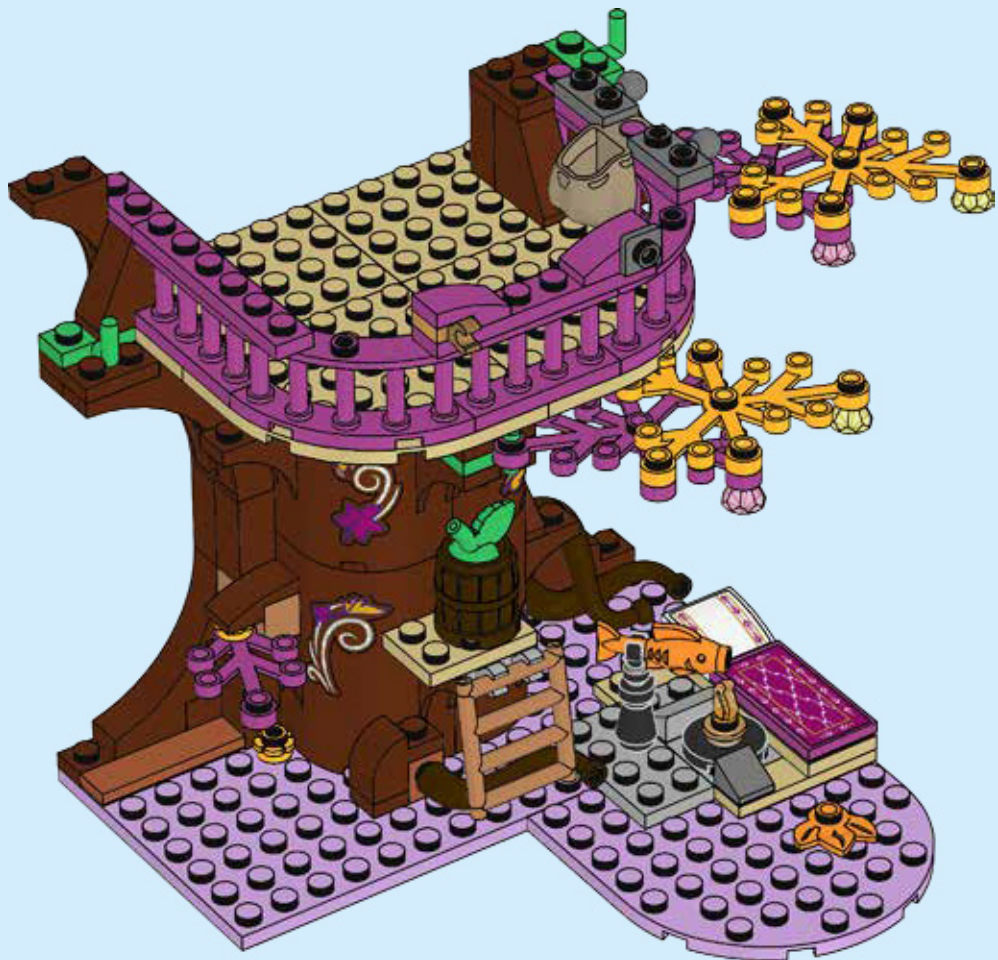



1x



2x

59

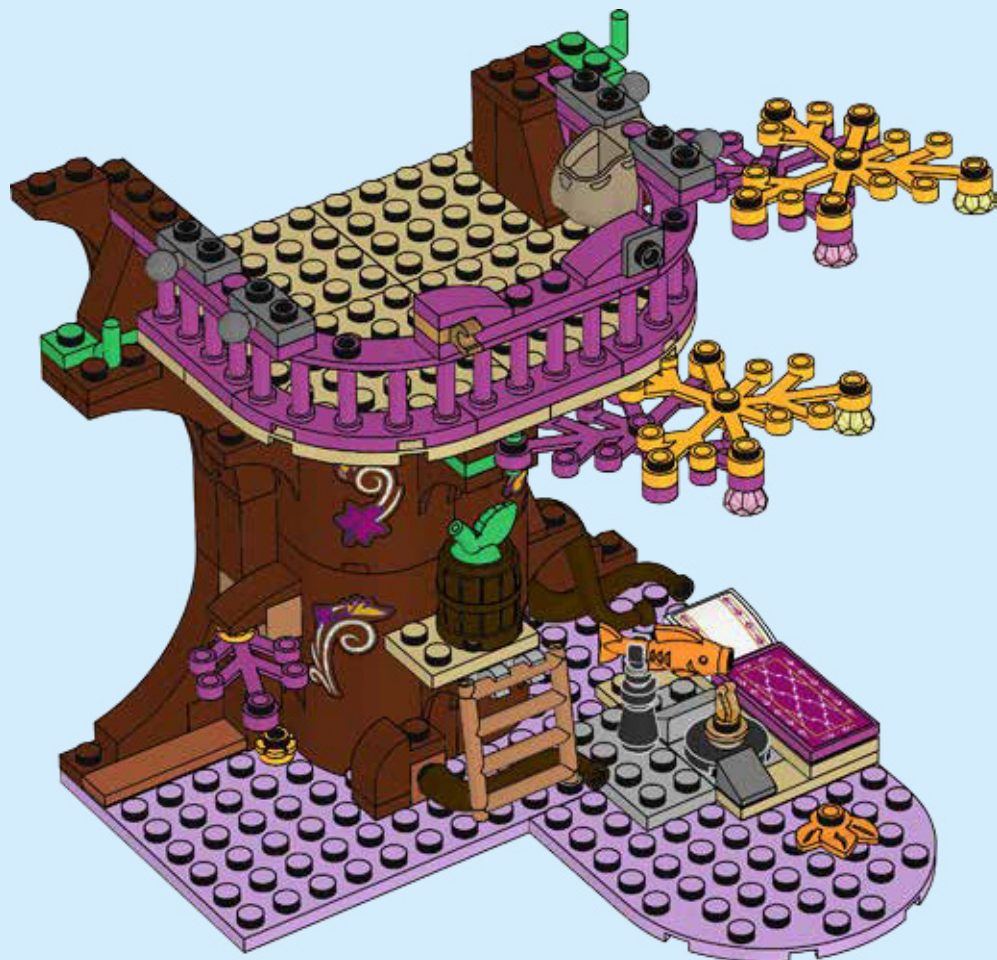



60

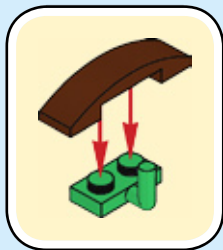

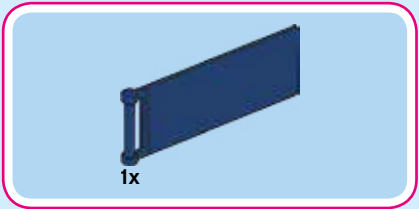

61

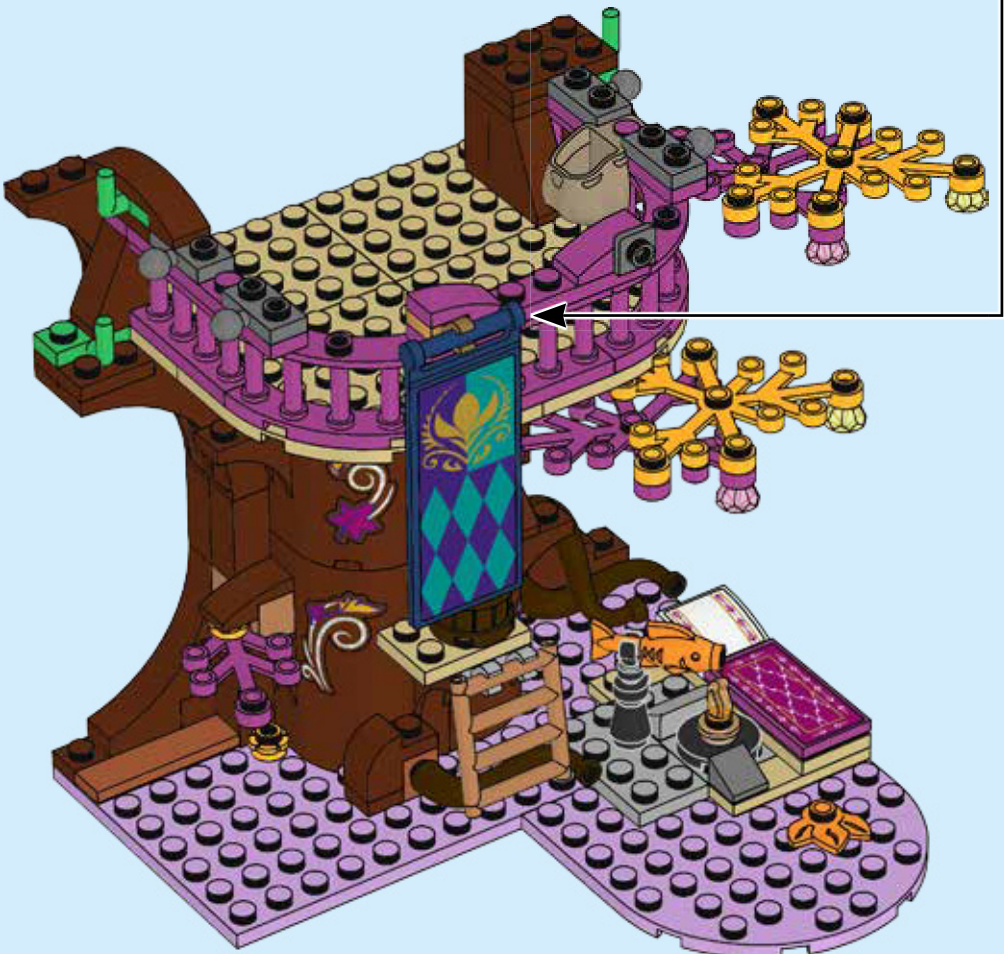
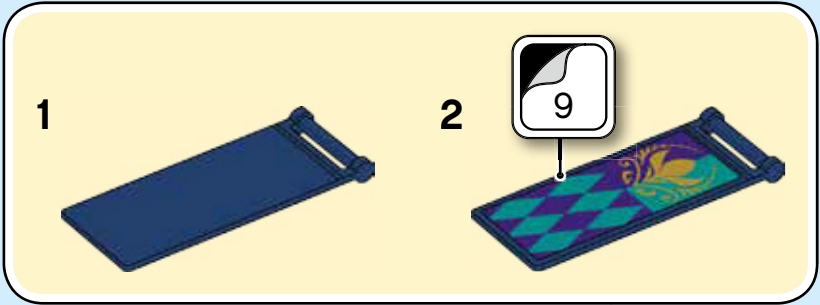

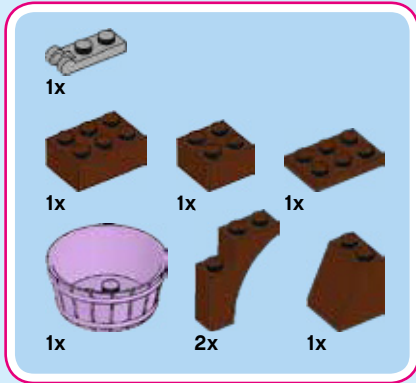

62

1

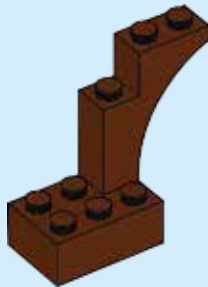

2



3



4



5







63



64





65

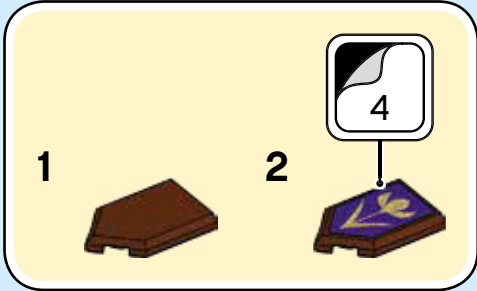

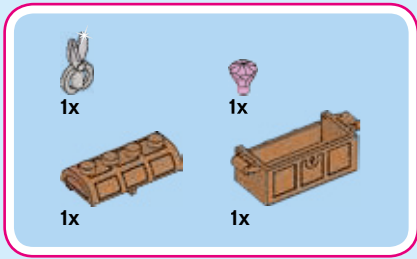

66

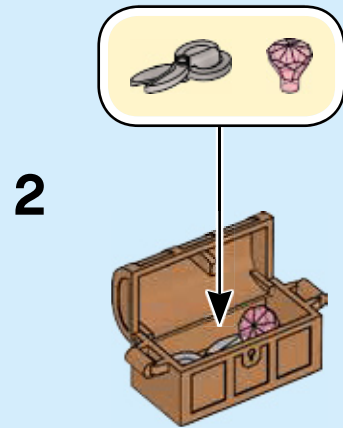
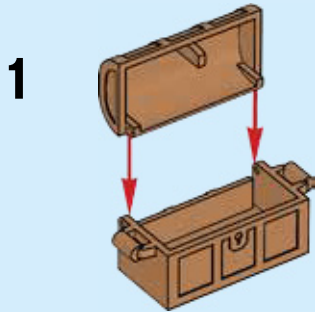

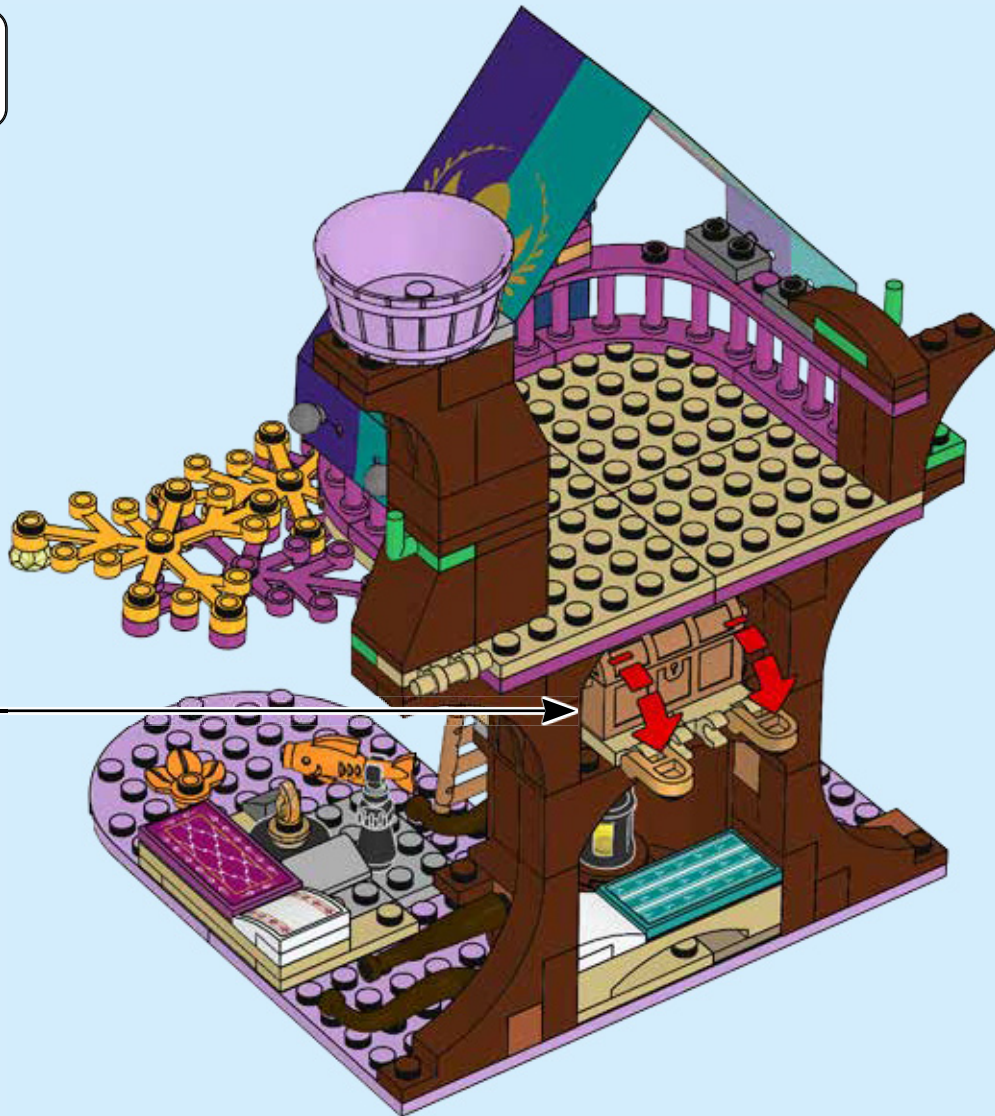

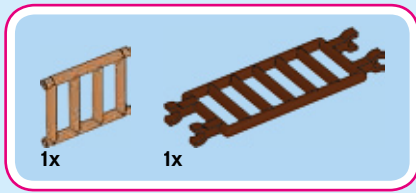

67

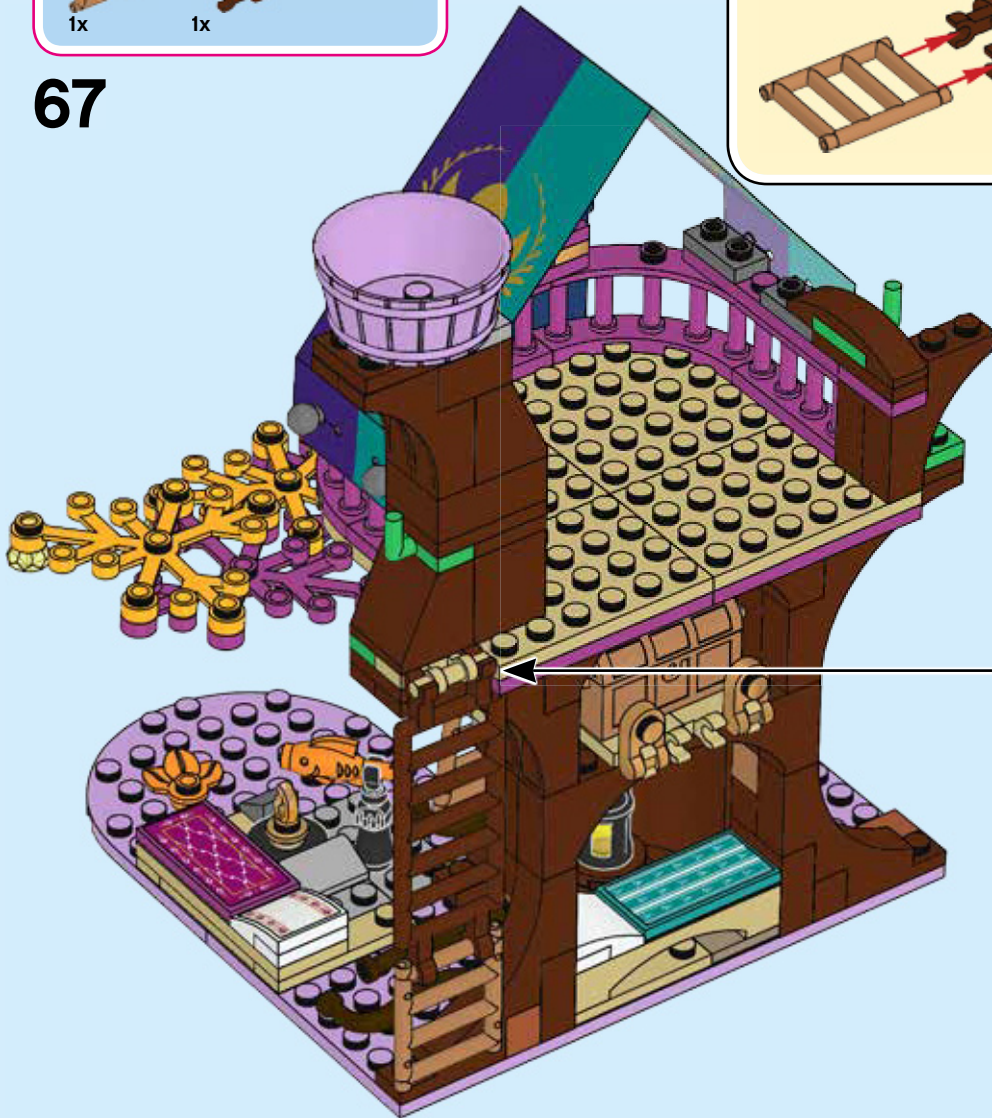
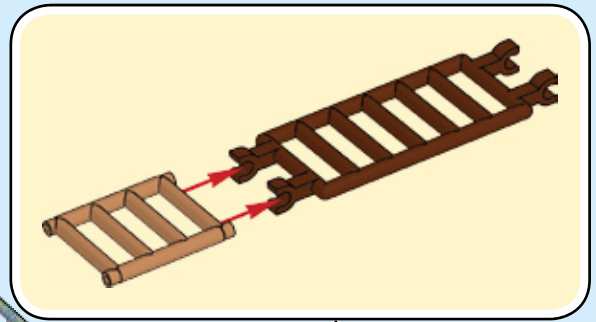

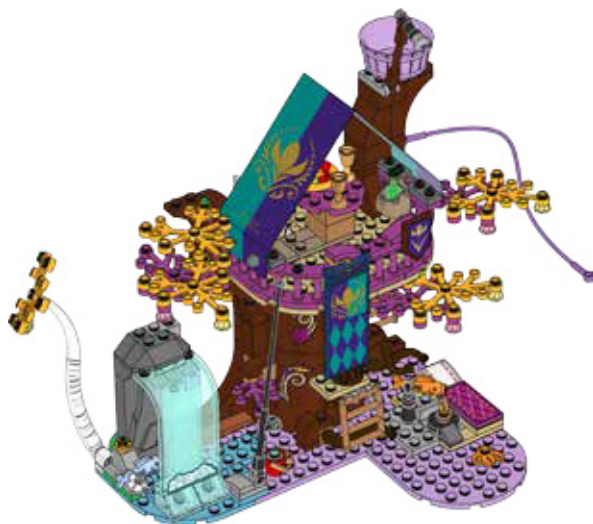
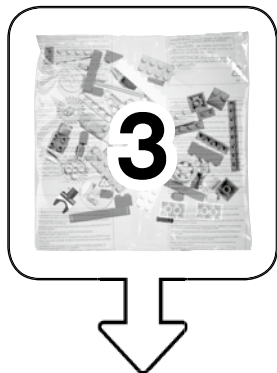

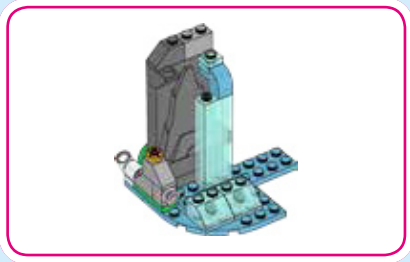

1x

68

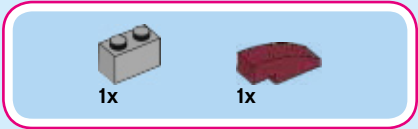
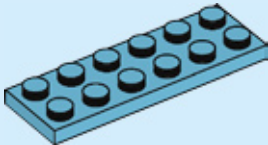

1x

1x

69

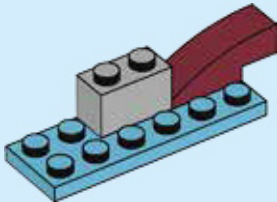



70

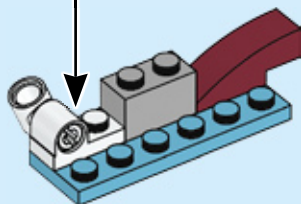
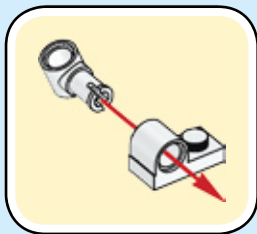

71

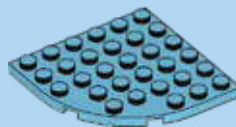
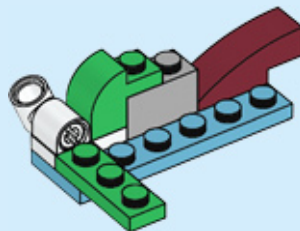

1x

72

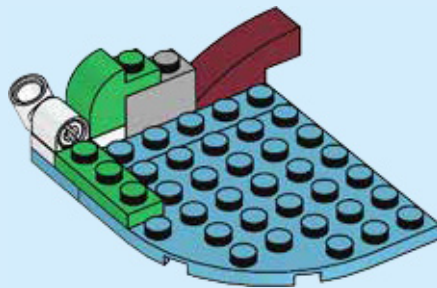

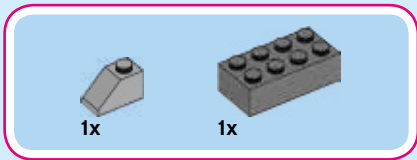

73

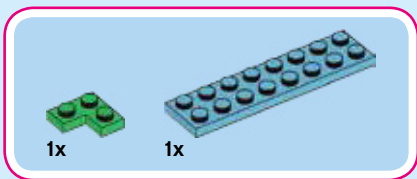
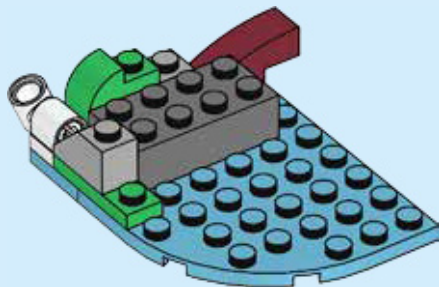

74

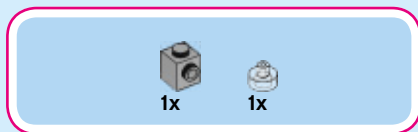
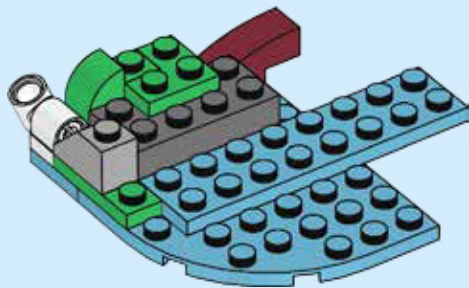

75

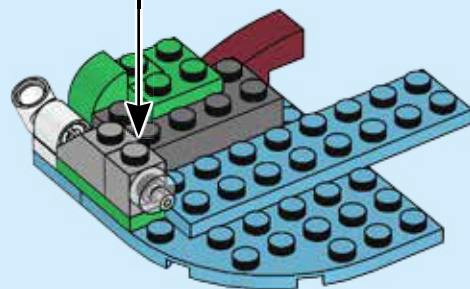
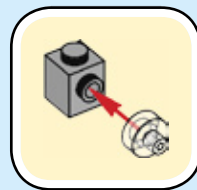

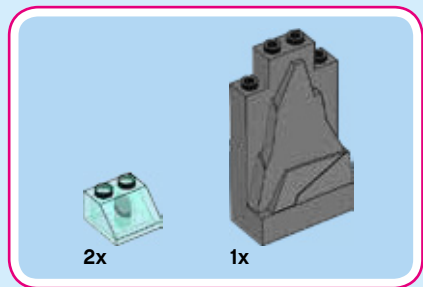

76

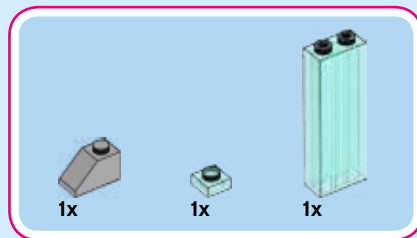
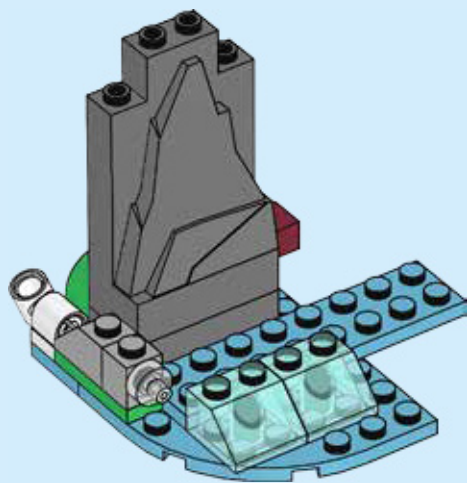

77

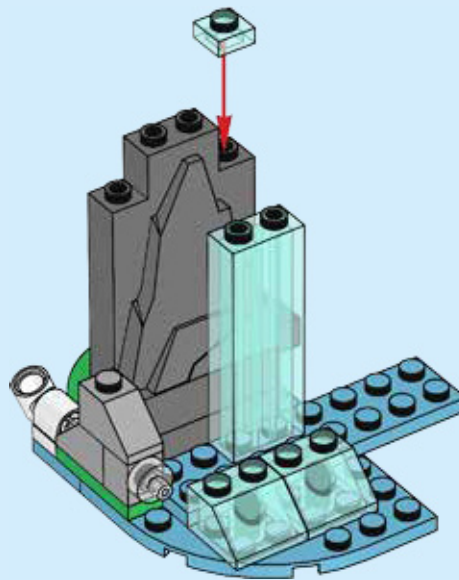



78

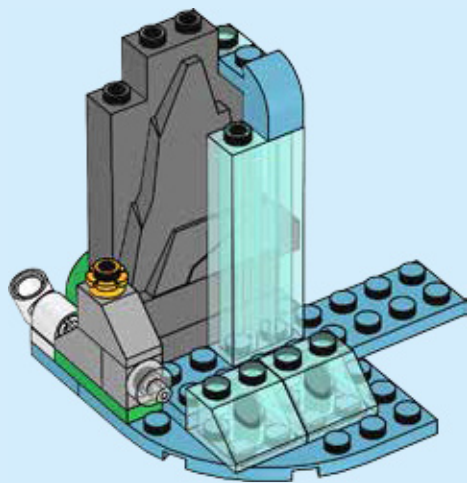

79

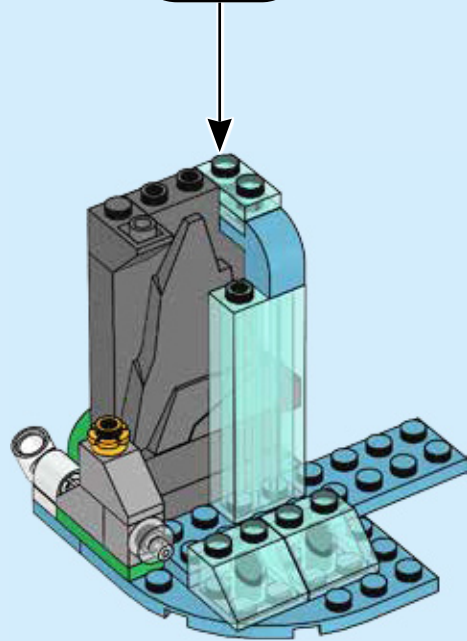
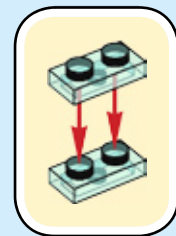

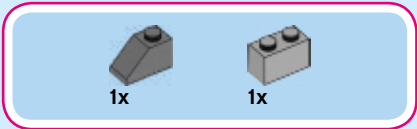

80

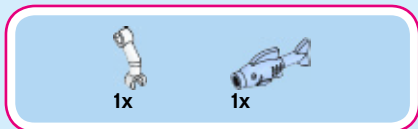
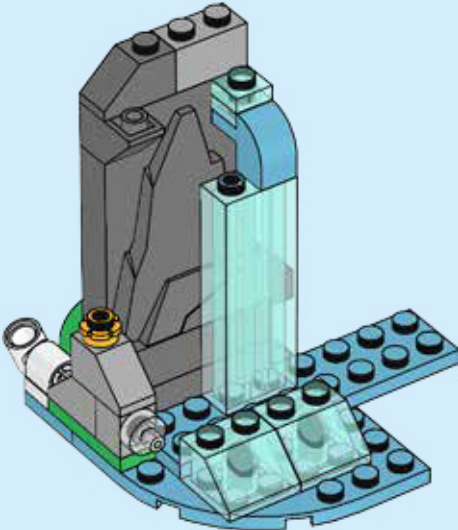

81

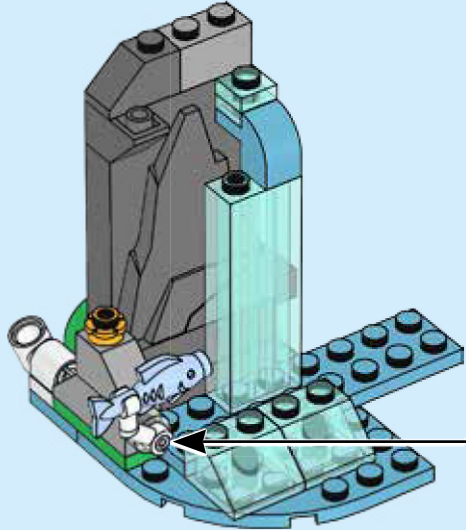
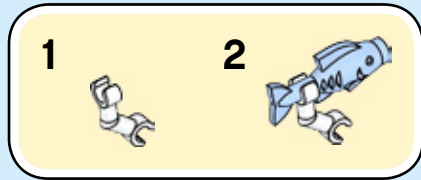

82

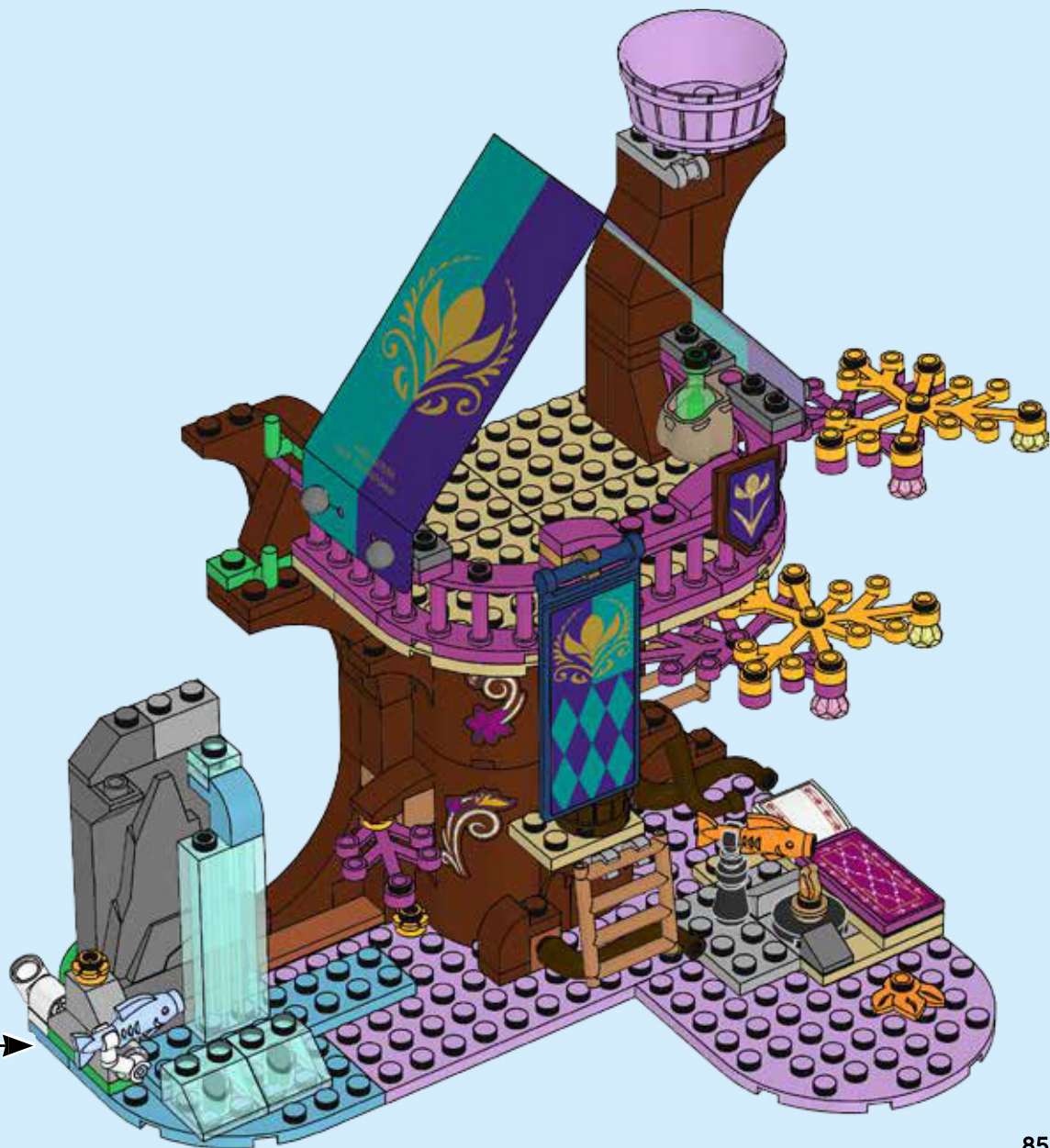

85

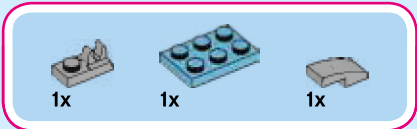

83

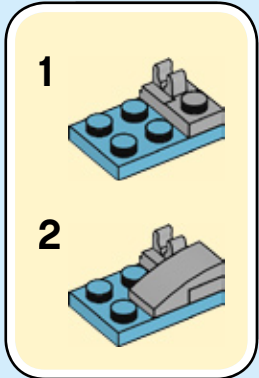

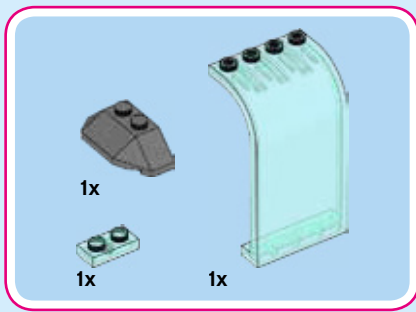

84

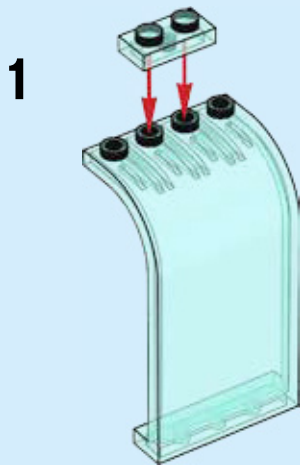



2





3



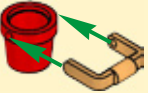

		
1x	1x	1x

85

- 
- 



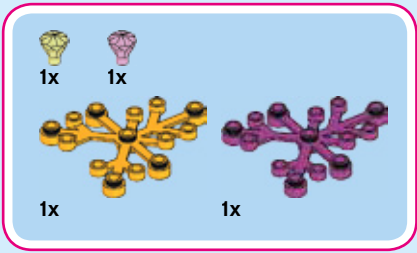

86

1



2



3



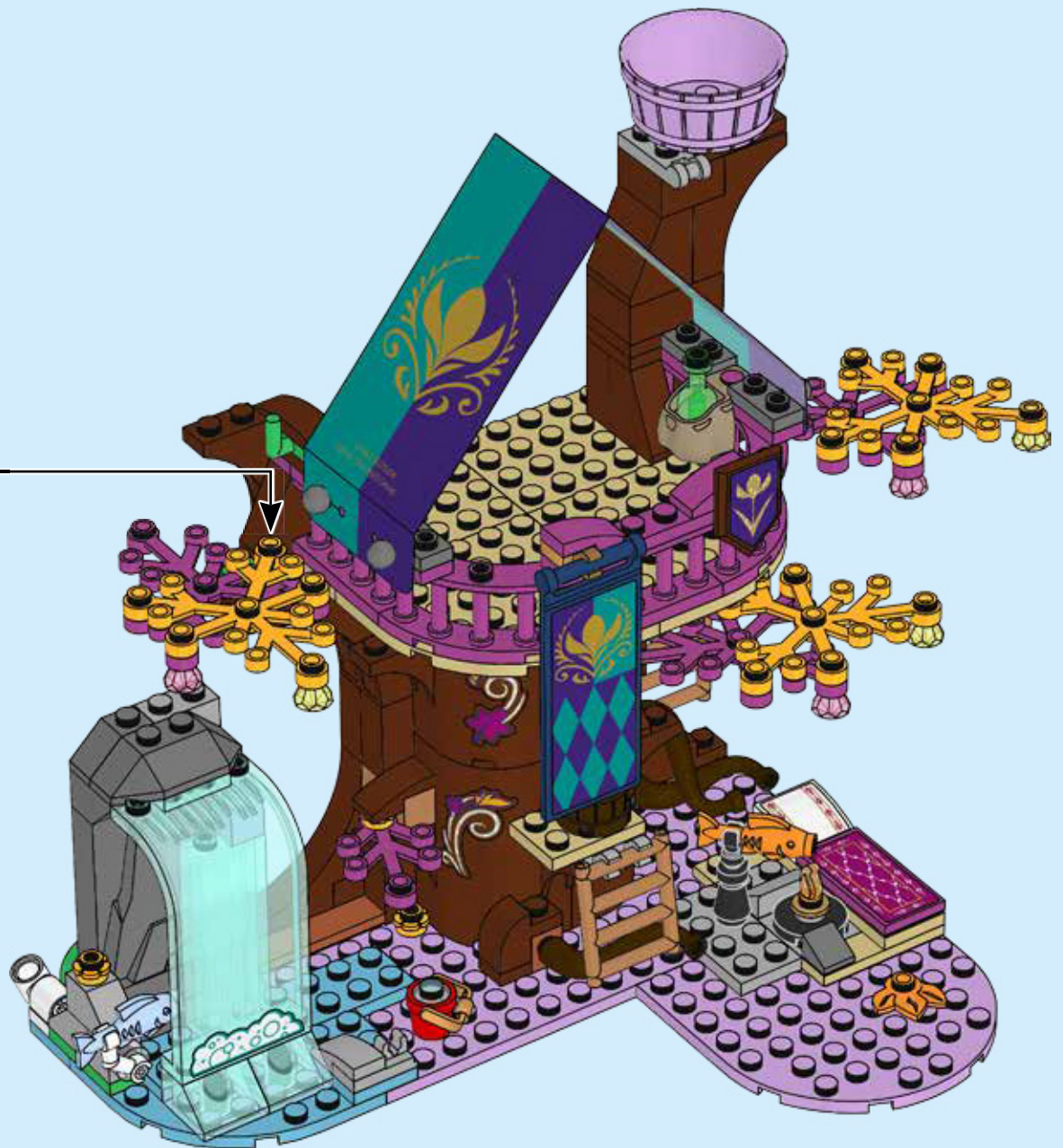

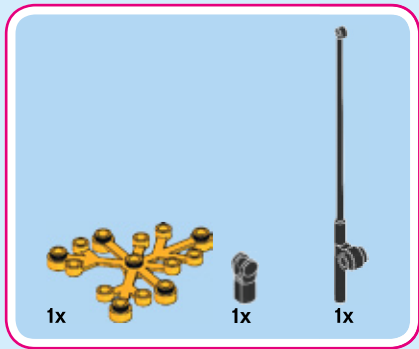

87

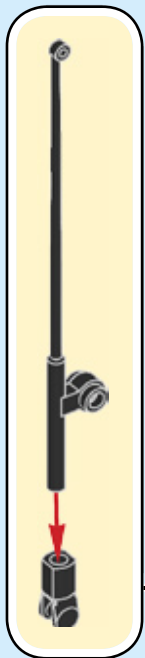



88



1



2



3

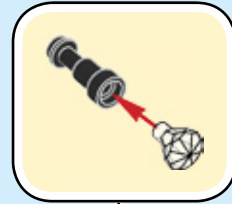

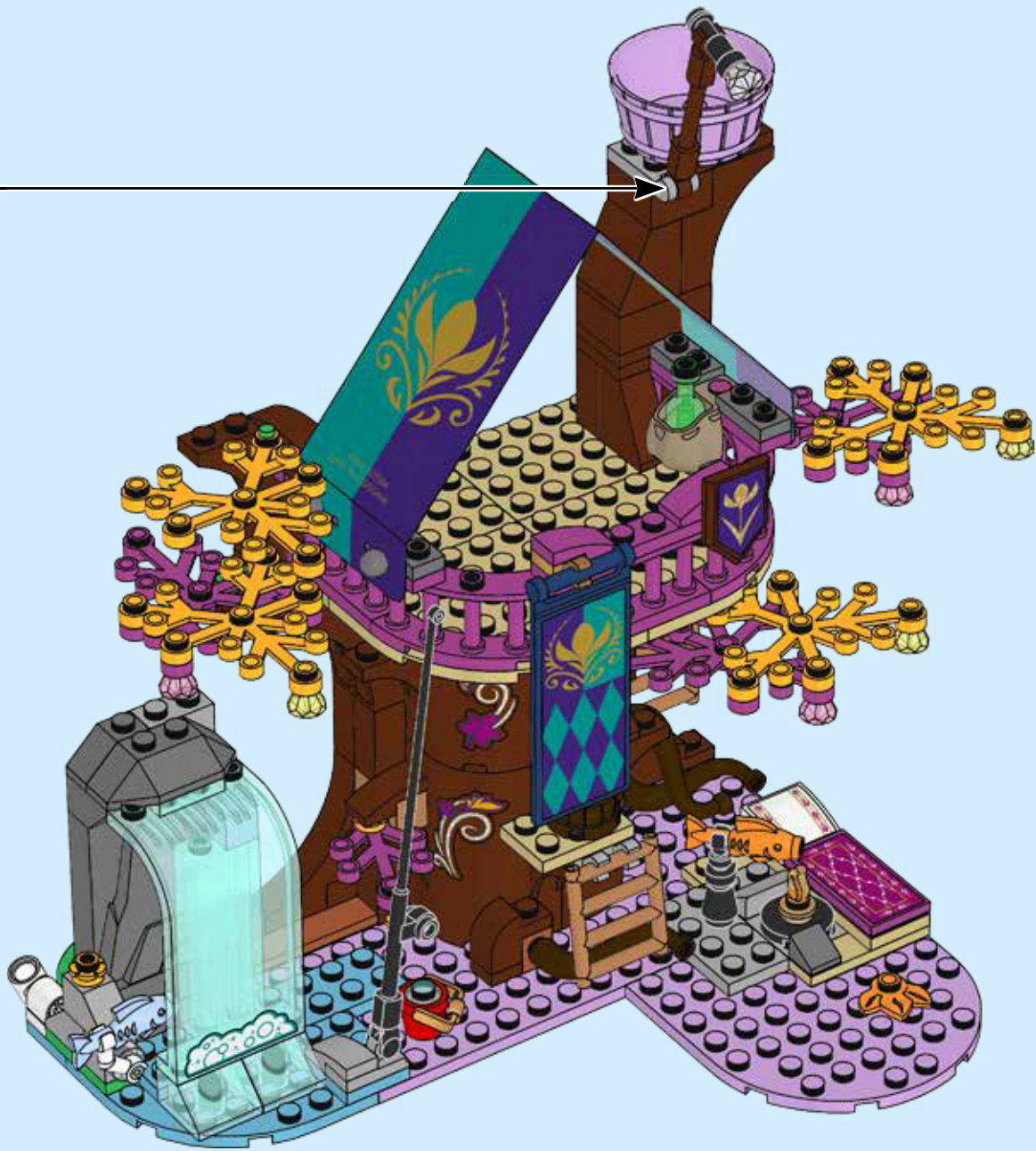

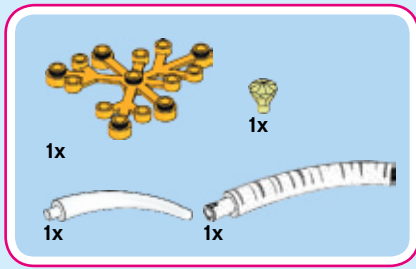

89

1



2



3

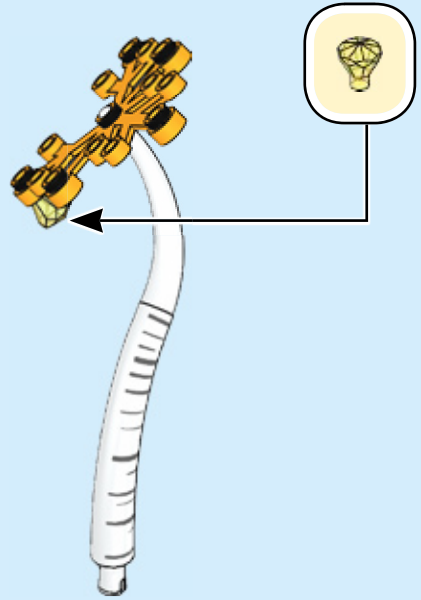



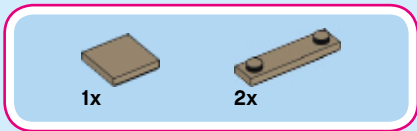

90





1x



1x

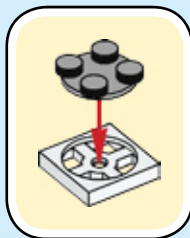

91



98

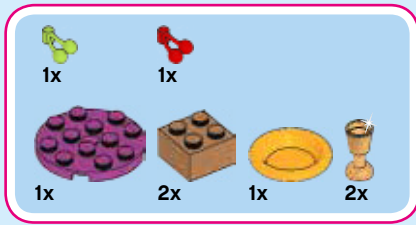

92

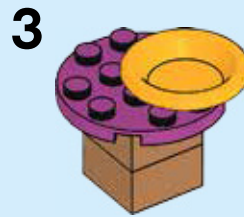
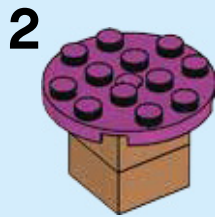
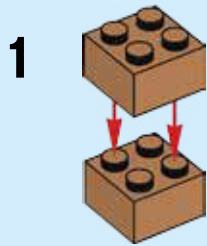



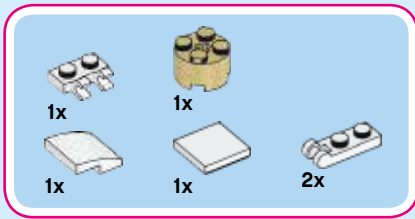

93

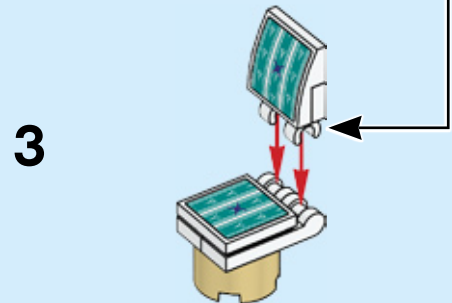
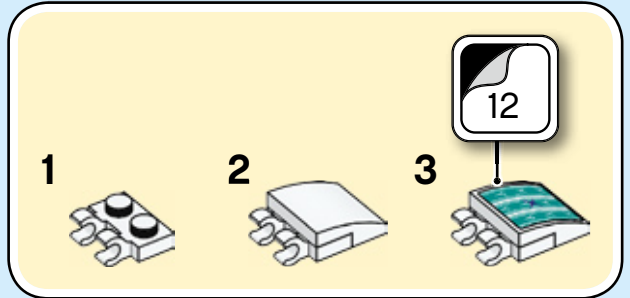
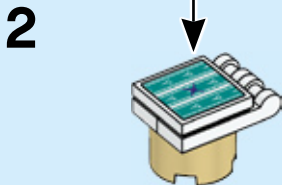
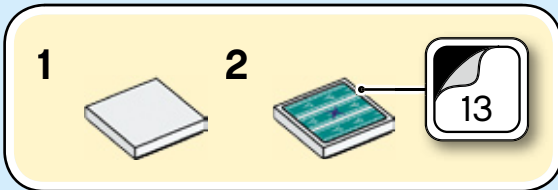
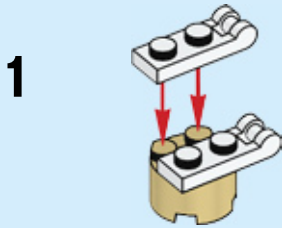



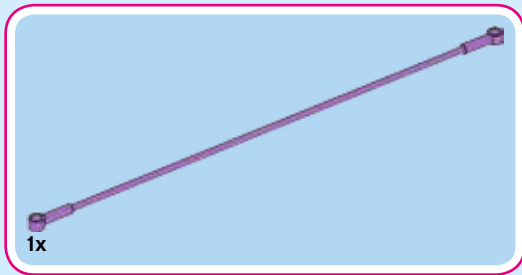

94

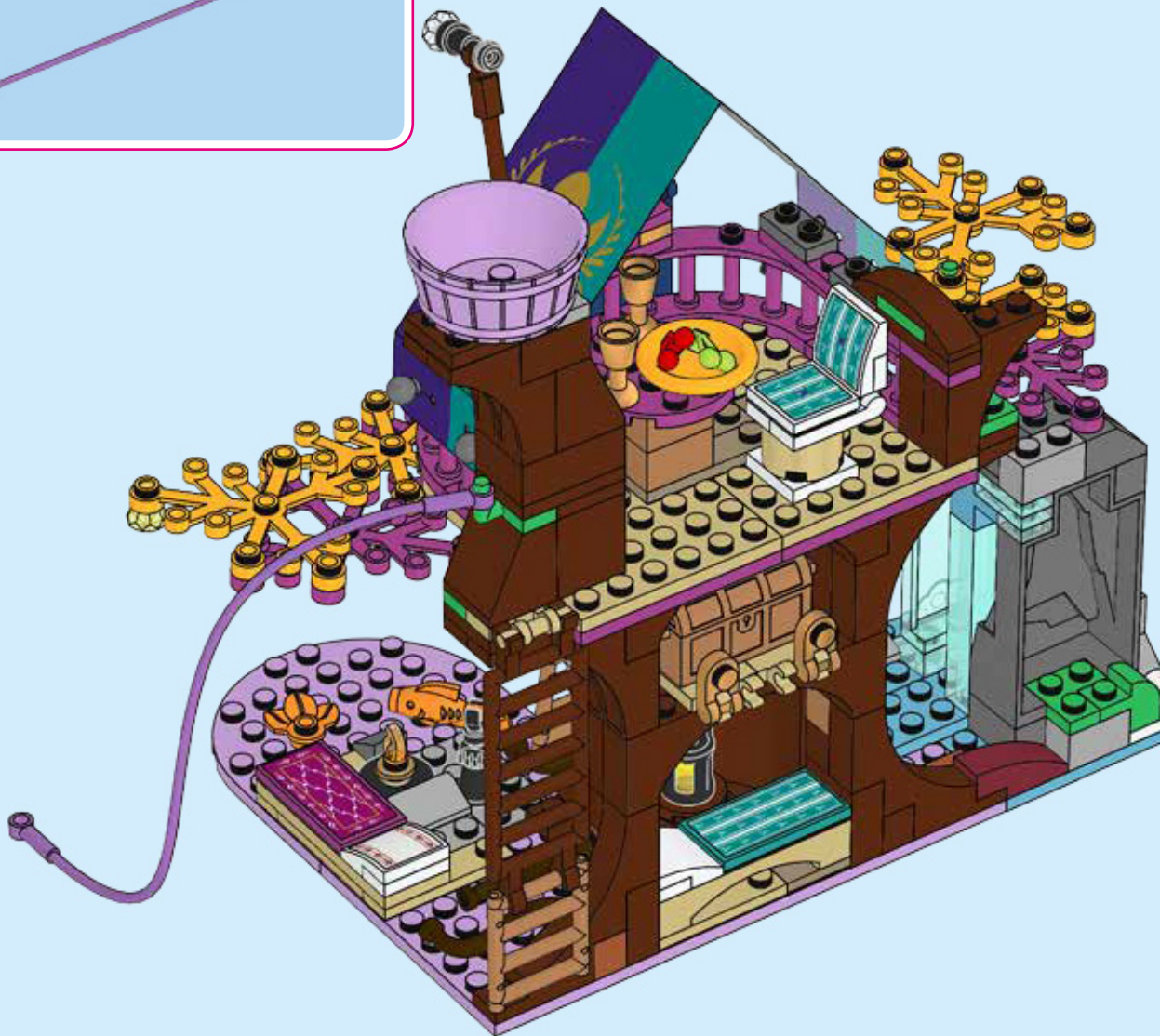

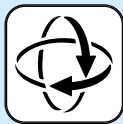



1x

95



1x

96



1x

97





2x

98



2x

99

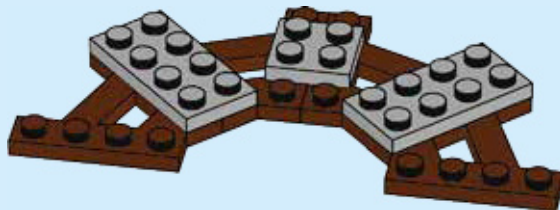

2x

100

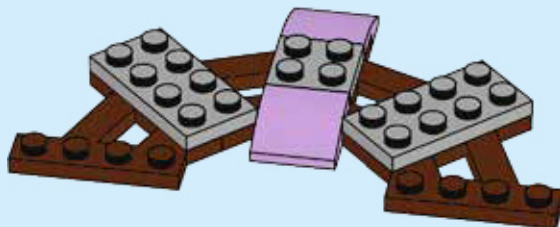

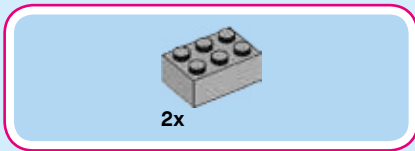

101

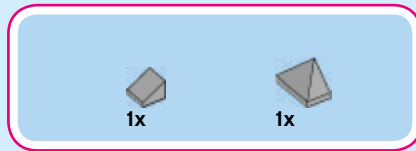
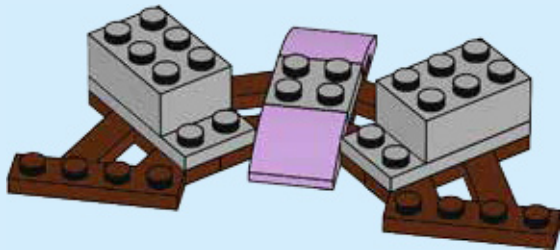

102

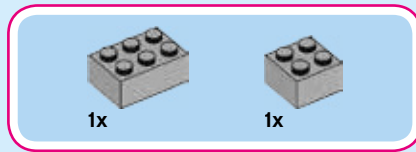
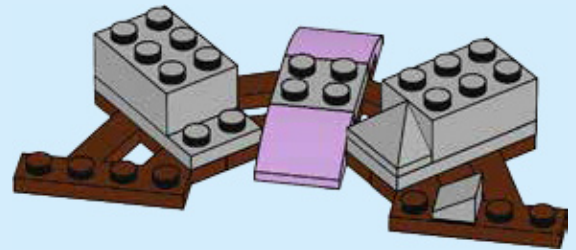

103

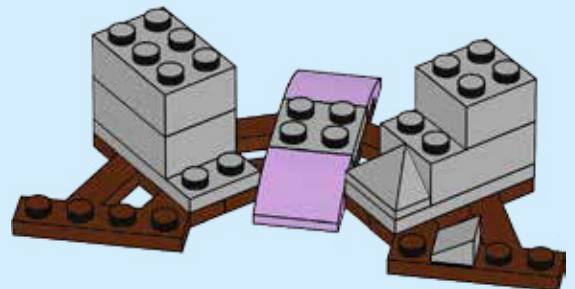



104

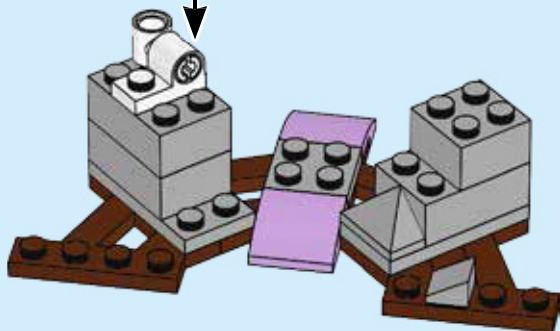
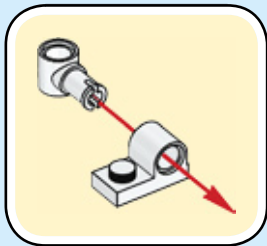

105

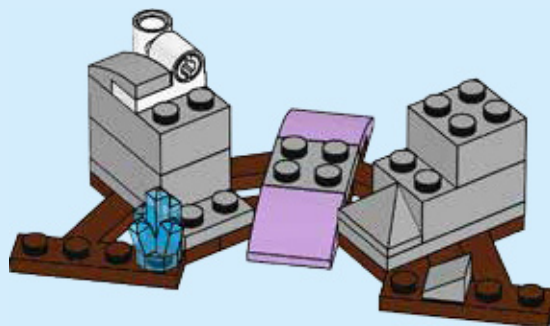

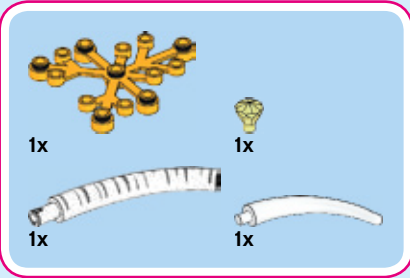

106

1



2





3

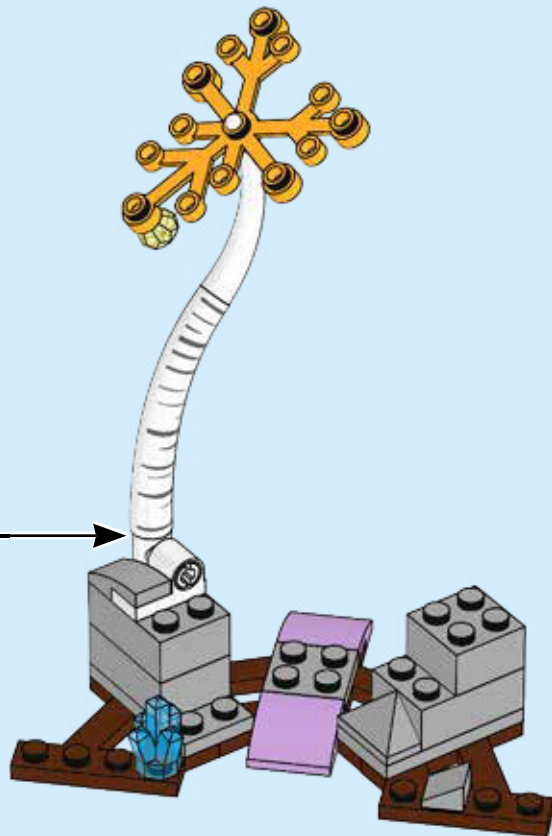

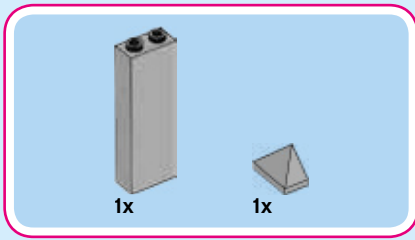

107

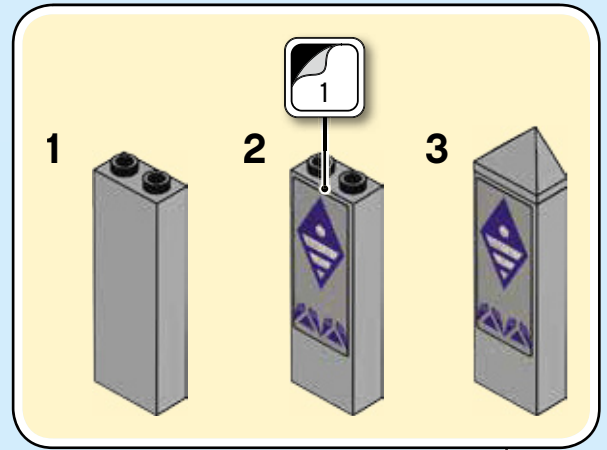
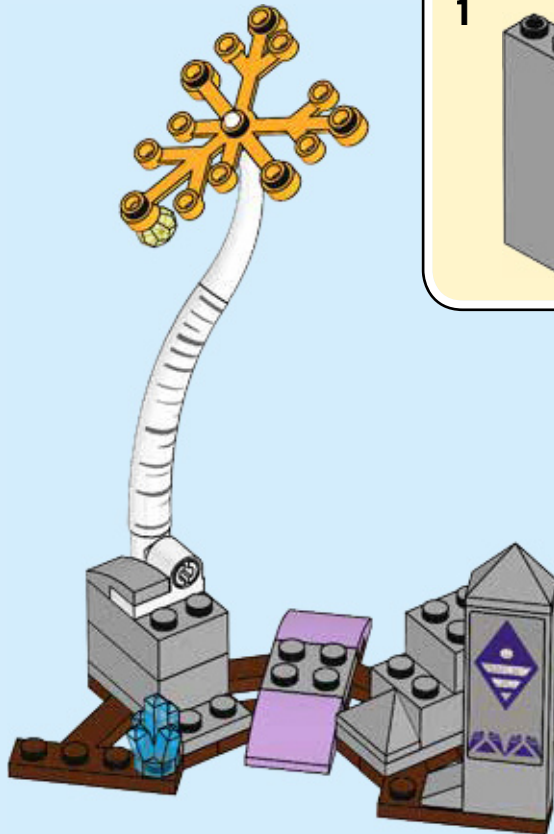

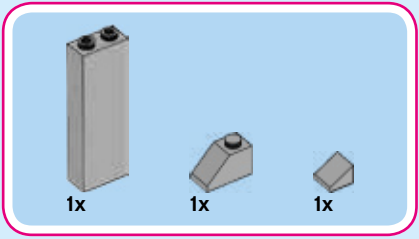

108

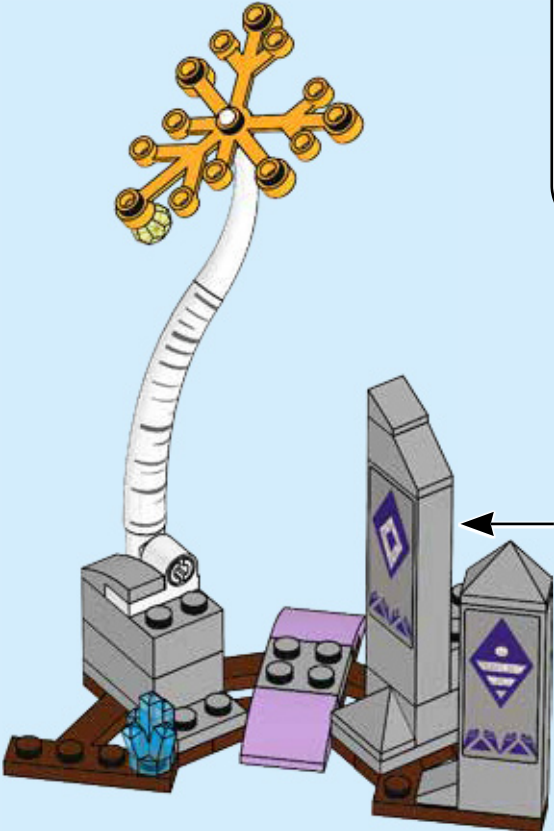
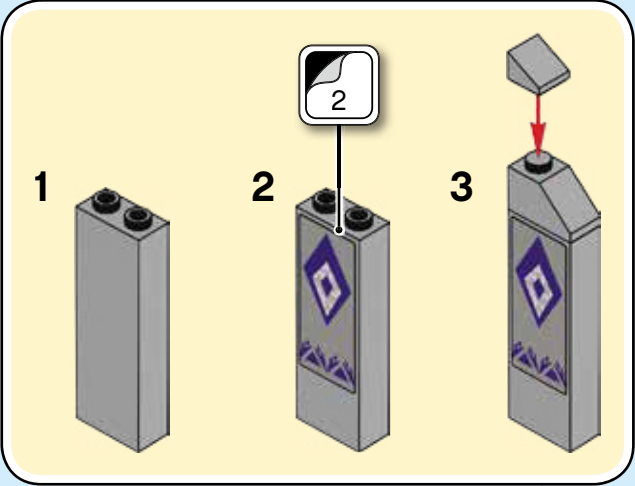

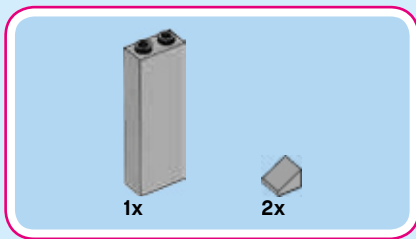

109

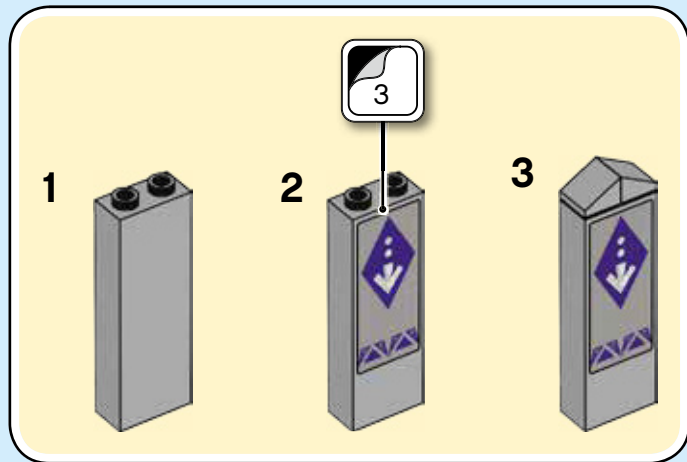
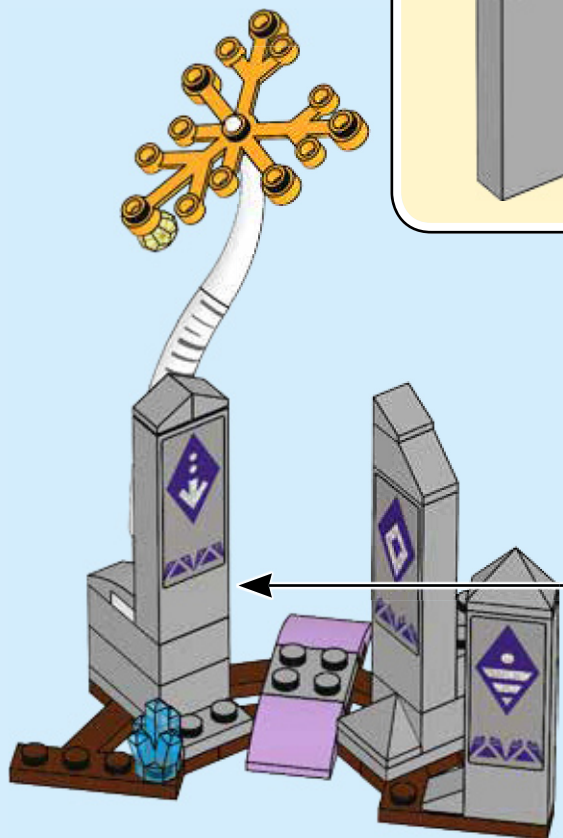

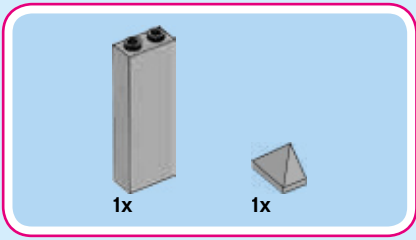

110

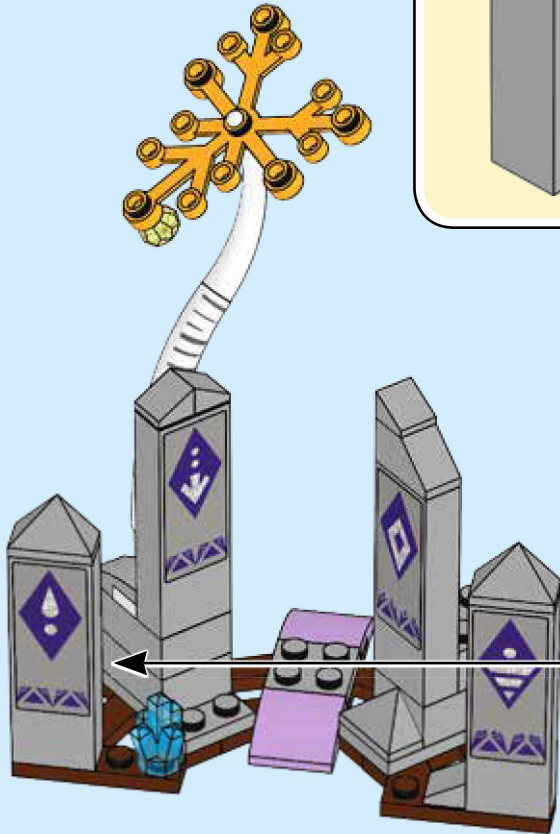
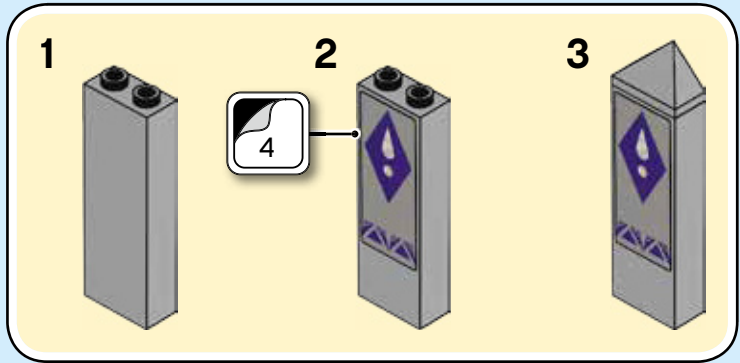



1x

111

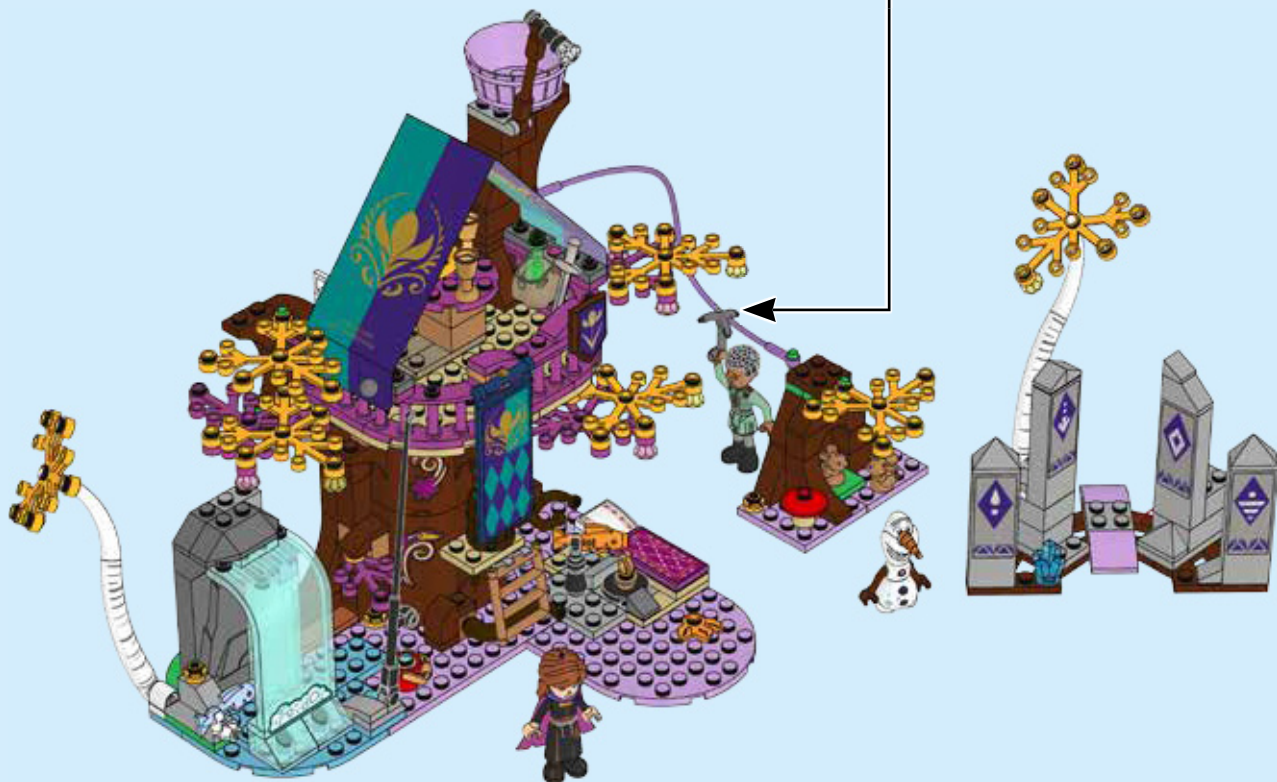



1x
6252200

2x
6253271

1x
6274755

2x
6057414

2x
302301

1x
4556152

1x
368001

1x
306801

3x
6047220

2x
4515364

2x
6110023

2x
6274726

1x
6278114

1x
4529237

1x
4125220

1x
4113917

1x
4140593

1x
4565387

1x
4118790

4x
6257600

2x
6191626

1x
6122047

1x
4114319

2x
4618876

1x
4113993

2x
4114001

2x
6056484

1x
6100565

1x
6003001

1x
4585146

1x
4538456

1x
6143318

1x
6240496

1x
4529236

1x
6270122

1x
6227901

1x
6122096

1x
6276913

1x
6195325

1x
6145252

7x
6261358

1x
6100223

1x
4565321

1x
4157120

1x
4107758

3x
4666322

1x
6276840

1x
6074893

1x
6186867

1x
6247798

1x
6240225

1x
6252043

3x
6240222

1x
6251284

2x
6244885

1x
6244794

1x
6236962

1x
6238674

5x
6247795

1x
6247364

1x
6192792

1x
6253884

1x
4623481

1x
6223065

4x
6247796

1x
6087084

2x
6070763

1x
6103415

1x
6268822

3x
6277611

1x
6096210

1x
4651898

2x
6173072

5x
4654105

3x
6266974



1x
4598955



2x
4507045



2x
6257599



1x
6279790



1x
4541546



1x
6236437



1x
6134722



5x
6209681



1x
4243920



7x
6273388



2x
6080355



5x
4211242



1x
4221744



1x
6102360



2x
4211320



1x
4211166



4x
6172808



1x
4211150



1x
6035547



1x
6069984



5x
4629736



4x
4211199



1x
6075208



5x
4216695



2x
4211210



1x
4211221



1x
4211257



4x
6084573



1x
6245259



1x
4211152



3x
6055086



1x
6133833



2x
4211189



1x
4216668



1x
6177697



1x
4658005



4x
6276850



2x
6097417



4x
6044725



4x
6174242



1x
4263776



1x
6271129



4x
4521921



1x
4558953



3x
6075075



1x
4568637



1x
4540203



2x
6028813



2x
4211388



1x
4598526

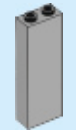

4x
4211363



3x
4211614



1x
4556157



1x
4211397



1x
4211387



1x
4515369



3x
4211386



4x
4211395



1x
4504378



1x
6225494



1x
6269935



4x
6039479



1x
4211096



1x
4211135



1x
6027686



1x
4211085



1x
4513326



1x
6195347



1x
6274753



1x
6278444



2x
4505990



1x
6245278



1x
4523160



2x
6212377



1x
6278987



3x
6171006



1x
6274754



2x
6194752



3x
4569382



2x
6058085



1x
6279789



2x
4568955



2x
6167599



1x
6254218



1x
6102984



1x
6096993



1x
6078442



1x
4655246



1x
4619513



1x
6146926



1x
6253666



1x
6133693



1x
6284172



2x
6112964



1x
6211376



2x
6213252



1x
6275004



1x
6200551

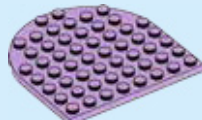

1x
6273856

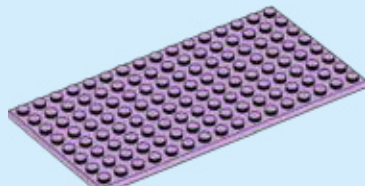

1x
6133814

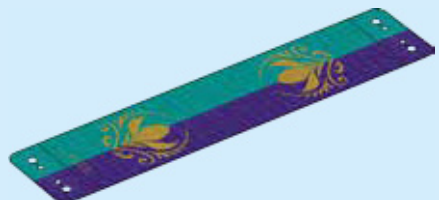

1x
6275204

Customer Service
Kundenservice
Service Consommateurs
Servicio Al Consumidor

LEGO.com/service or dial



: 00800 5346 5555

: 1-800-422-5346



Terms & Conditions apply

LEGO.com/productfeedback

GEWINNE

Erzähle uns auf www.LEGO.com/productfeedback

etwas über die Erfahrungen, die du mit diesem LEGO® Set gemacht hast, und sichere dir die Chance auf einen coolen LEGO Preis!

Es gelten die Teilnahmebedingungen

GAGNE

Rends-toi sur www.LEGO.com/productfeedback

et donne-nous quelques commentaires sur ce produit LEGO® pour avoir une chance de gagner un prix LEGO !

Voir Conditions Générales

GANAN

Visita www.LEGO.com/productfeedback

y envíanos tu opinión acerca de este set LEGO®. ¡Participarás en el sorteo de un premio LEGO!

Términos y Condiciones aplicables

获取奖品

登录 www.LEGO.com/productfeedback

给出关于此乐高®套装的简短反馈，就有机会获得炫酷乐高奖品

《条款及条件》适用