



UniKitty!



40314





1

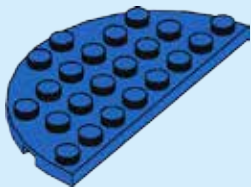

2

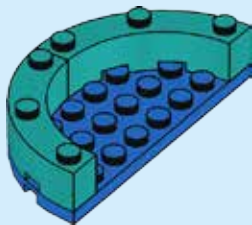

3

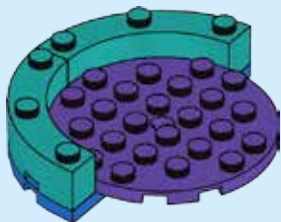

4

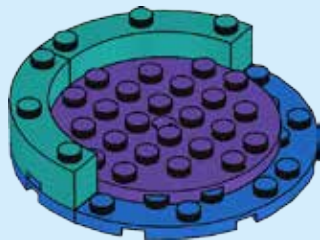

5

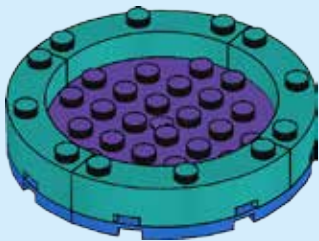

6

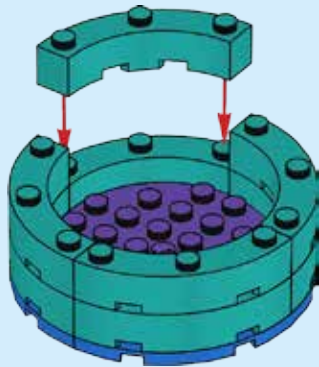

7

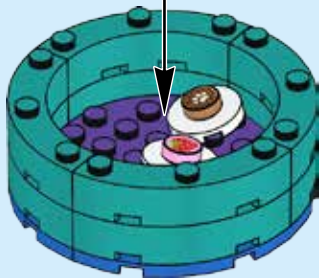
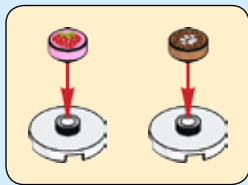

8



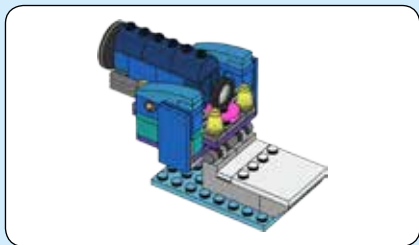

1

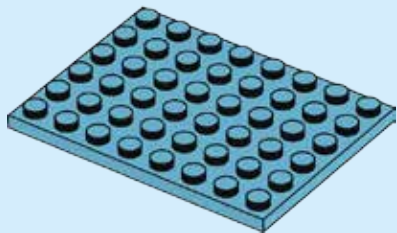

6

2

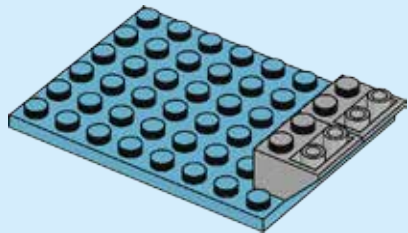

3

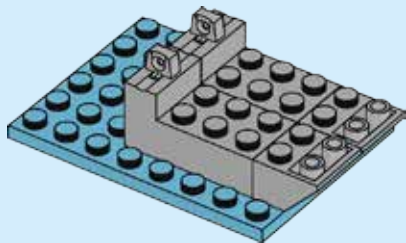

4

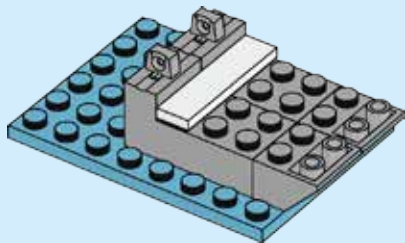

5

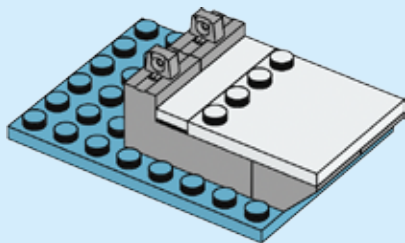

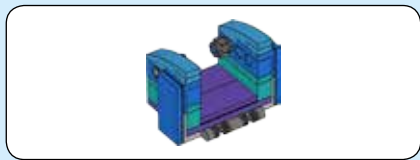

6

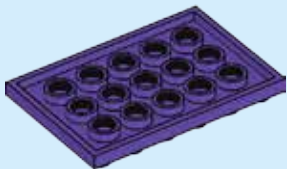

7

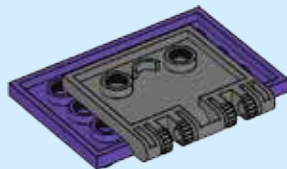

8

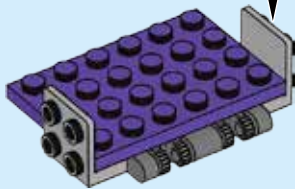
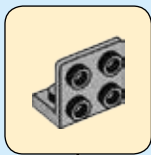
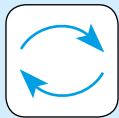

9

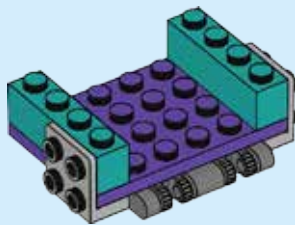

10

10

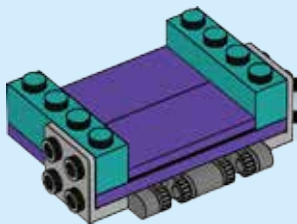

11

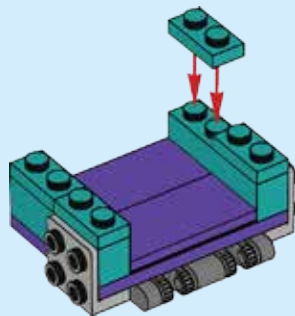

12

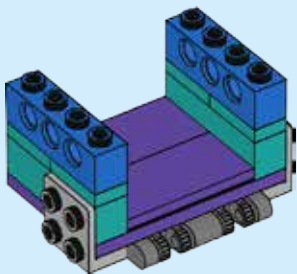

12

13

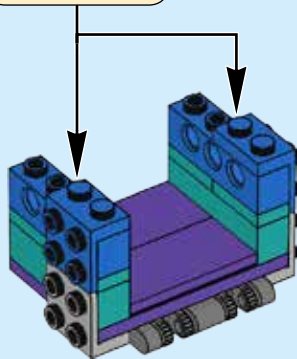

14

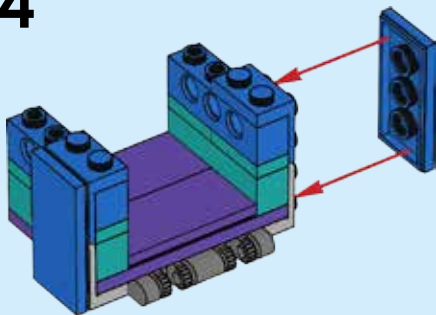

15

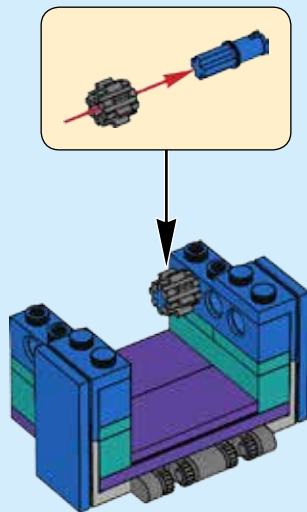

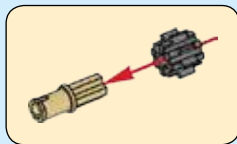

16

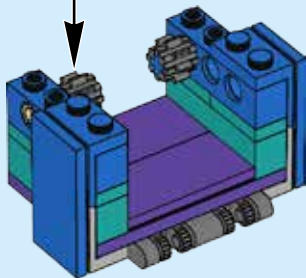

17

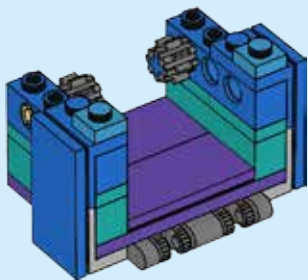

18

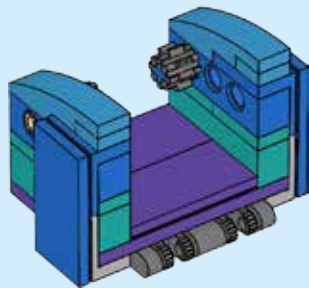

19

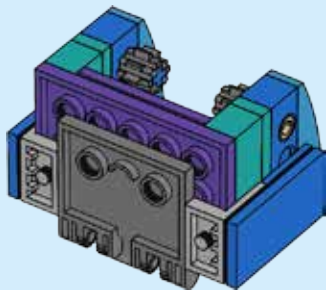
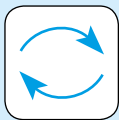

20

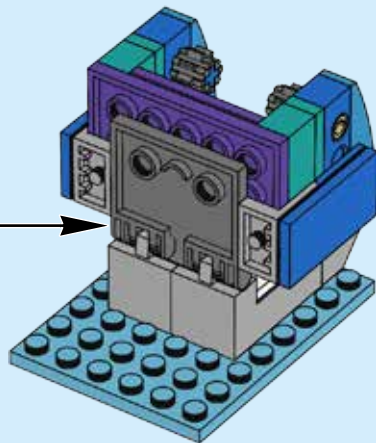



21

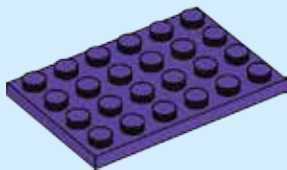

22

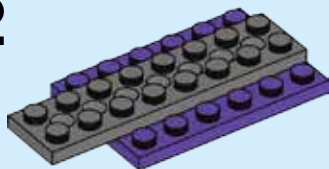

23

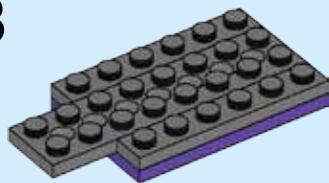

24

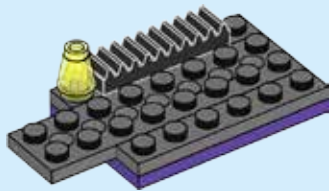

25



26

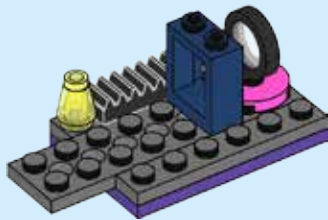

27

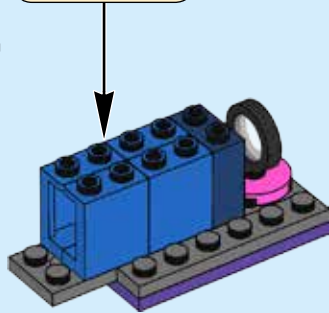
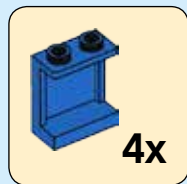

28

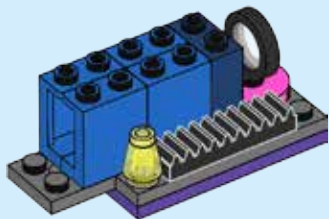

20

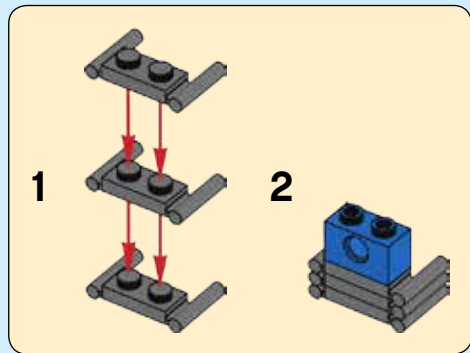

29

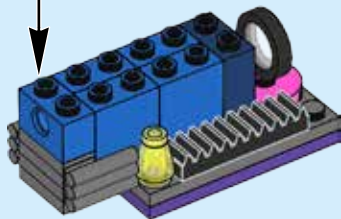

30

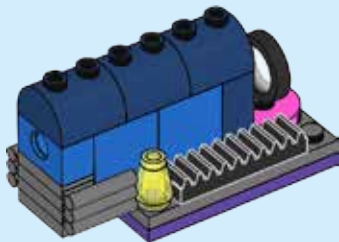

31

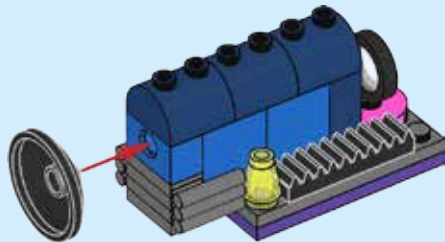

32

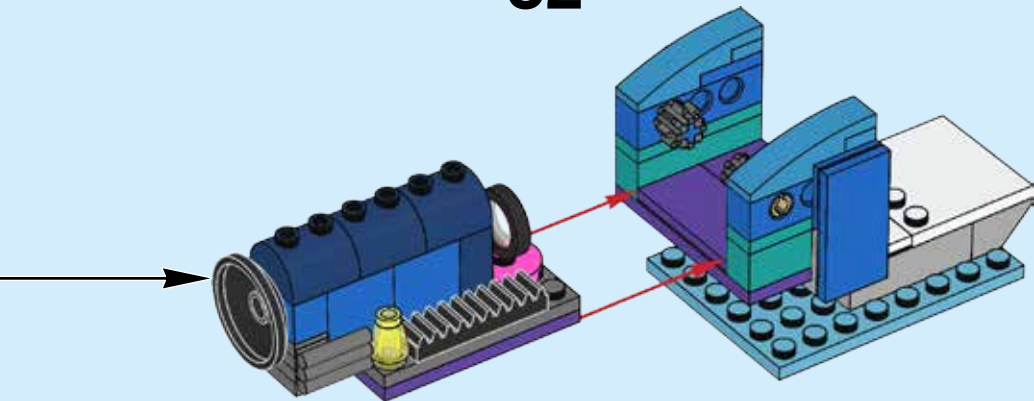

33

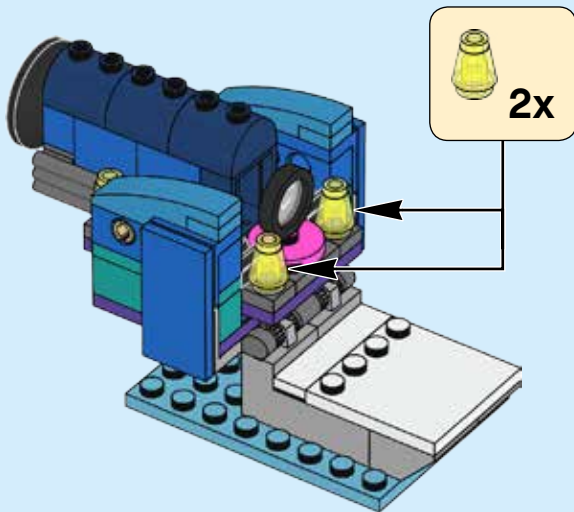

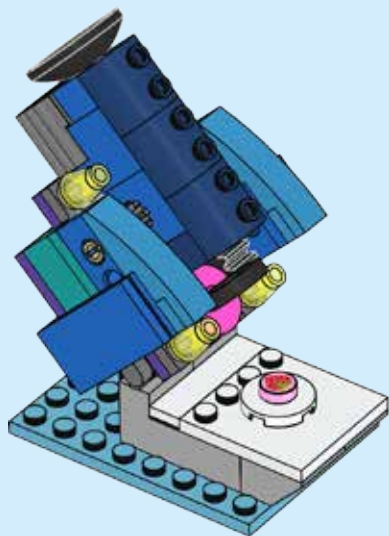







LEGO.COM/UNIKITTY

LEGO.com/service

UNIKITTY! Series © & ™ Warner Bros. Entertainment Inc. & The LEGO Group.
LEGO, the LEGO logo, the Brick and Knob configurations and UNIKITTY are trademarks
of the/son des marques de commerce du/son marcas registradas de LEGO Group.

©2018 The LEGO Group. 6242839

All new characters and elements from UNIKITTY! Series TM & © WBEI and The LEGO Group.
All rights reserved/Tous droits réservés/Todos los derechos reservados.



1x
6173108



2x
6093053



1x
243101



1x
617901



1x
6152676



1x
4666579



4x
4567334



1x
6102555



1x
6223767



1x
6055381



1x
6135595



3x
6175295



4x
6213777



2x
6217660



8x
6213786



1x
370023



4x
4586548



1x
4206482



2x
4560180



2x
6117968



2x
370123



2x
6186378



2x
6151664



2x
6151667

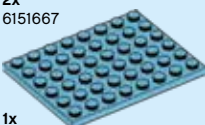

1x
6097036



1x
4260707



2x
6012451



3x
4263176



1x
4552248

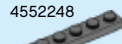

2x
4211056



2x
6167472



1x
6216908



2x
6147032



1x
4180087



2x
4205760



1x
6012466



2x
4654580



2x
4211436



2x
4211436



2x
6097167



Customer Service

Kundenservice

Service Consommateurs

Servicio Al Consumidor

LEGO.com/service or dial



00800 5346 5555 :



1-800-422-5346 :

