



Architecture

21029

Buckingham Palace

London, Great Britain



Buckingham Palace

Buckingham Palace—the official residence of Queen Elizabeth II and a major London tourist attraction—is one of the most recognizable buildings in the world. But the iconic structure so familiar to us today is actually the result

of many years of extensive remodeling. In a history that can be traced back over 300 years, the original building was transformed from a modest townhouse to the lavish royal palace we know and admire today.

*[The largest room in the palace is the Ballroom,
where state banquets take place]*



History

Though many different buildings had previously occupied the site, the official history of Buckingham Palace begins in 1698 when the Duke of Buckingham demolished the existing property and built Buckingham House on the spot where the palace stands today.

The house remained the property of the Dukes of Buckingham until 1761, when King George III acquired the house and its grounds as a private family residence for his wife, Queen Charlotte. Known then as "The Queen's House", the nearby St James's Palace remained the official royal residence.

This changed when George IV came to the throne in 1820 and decided to transform his childhood home into his

official palace. The renowned architect John Nash was given the task in 1826, and over the next five years extended the central block and replaced the existing wings to create an imposing, U-shaped palace.

[The first recorded royal balcony appearance took place in 1851 with Queen Victoria]





Neither King George IV, who died in 1830, nor his younger brother King William IV, who succeeded him but died in 1837, would take up official residence in the palace. Instead, the first royal to live in the palace would be Queen Victoria, who moved there in 1837. When she married in 1840, the palace soon became too small for both its official duties and her growing family. The architect Edward Blore was asked to enlarge the palace and design a new wing that would enclose the central quadrangle.

This new addition, facing The Mall, is the best-known part of the palace today and is reproduced in this LEGO® Architecture model. It also includes the famous balcony used by the royal family to acknowledge the crowds on national occasions.

[There are over 40,000 light bulbs in the palace]

Buckingham Palace Today

As well as being the enduring symbol of the British monarchy, Buckingham Palace is also a major tourist attraction, an art gallery and the location for many official state occasions.

The palace is still very much a working building. It has 775 rooms including 19 state rooms, 240 bedrooms, 92 offices and 78 bathrooms. Over 50,000 guests a year pass through its doors for royal ceremonies, state visits, investitures and garden parties. It is still the official residence of Queen Elizabeth II and the day-to-day workplace of the royal family.

Owned by the British state and not the monarchy, the cost of maintaining the palace has risen steeply as the building's age starts to show and major refurbishments are required. It is estimated that over £150 million will be needed over the next ten years to ensure this iconic structure will remain a part of Britain's heritage.

[The Buckingham Palace kitchen is able to serve a sit-down meal for up to 600 people at one time]



The Architects

John Nash (1752 – 1835)

Born in south London in 1752, John Nash was responsible for much of the layout of Regency London during the reign of George IV. Given the task of transforming a townhouse into a royal palace, he doubled the size of the existing building, added two new wings and clad the whole structure in Bath stone. Though widely considered as an architectural masterpiece, the building costs soon escalated out of control. Nash was eventually removed from his post, never to receive an official commission again.

Edward Blore (1787 – 1879)

The English-born architect was contracted to complete the work started by Nash and was chosen again in 1841 to design the extension to the palace during the reign of Queen Victoria. As well as adding an attic floor to the main block of the palace, Blore designed the new East Front with its main façade and central balcony.

Sir Aston Webb (1849 – 1930)

Many of Blore's contemporaries criticized the simplistic style of his new East Front and in 1913, with the soft French stone he chose starting to crumble, King George V asked Aston Webb to redesign and repair the building's façade. Webb, a renowned London-born architect, remodeled the building to the form we know today and clad the structure in Portland Stone.

*[During the Second World War,
the palace suffered nine direct
bomb hits]*



Facts about Buckingham Palace

Location: London, England

Construction Periods: 1826, 1841, 1913

Architectural Style: French neo-classical

Dimensions: 354 ft. (108 m) by 390 ft. (120 m)

Height: 79 ft. (24 m)

Floor Space: 830,000 sq. ft. (77,000 m²)



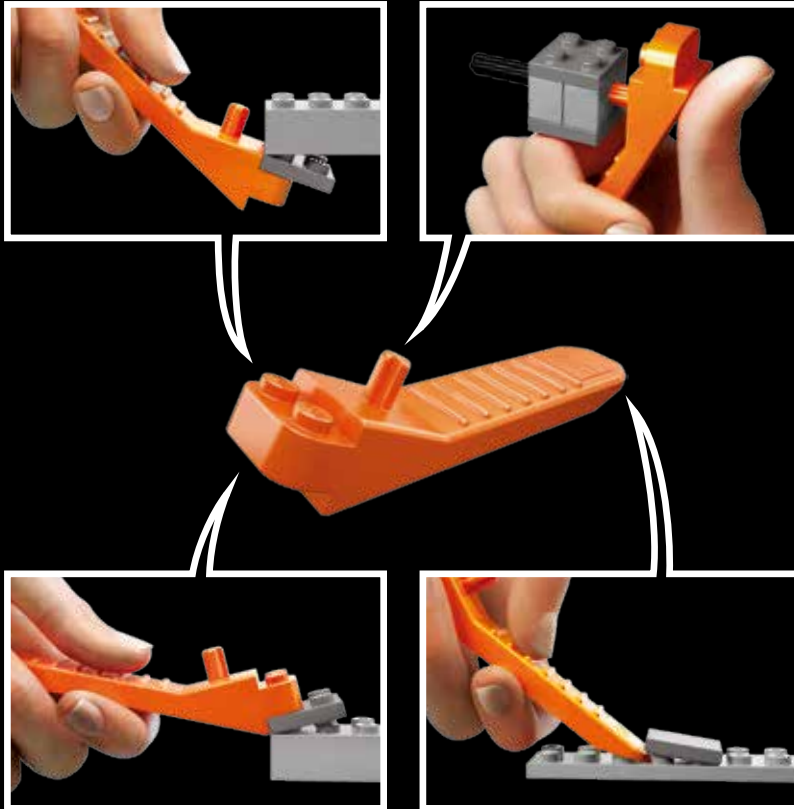

LEGO.com/brickseparator

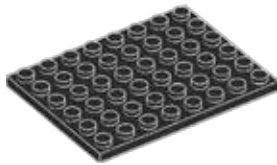

1x

1

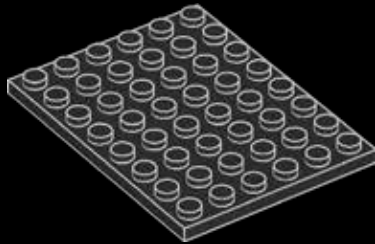

1x

2

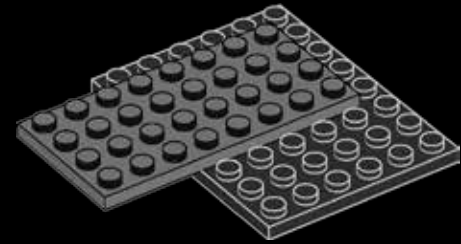

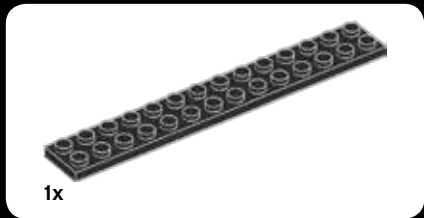

3

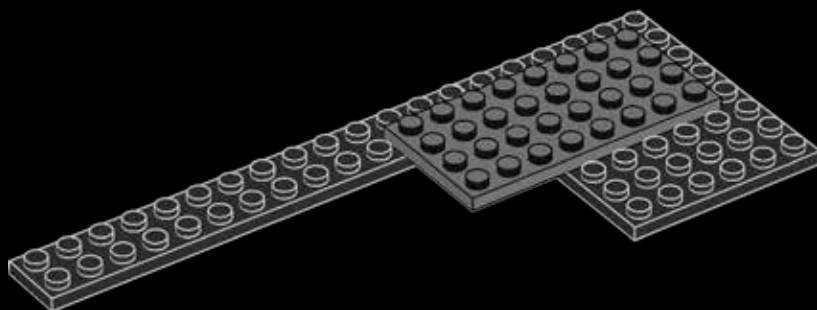

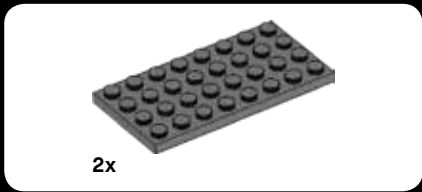

4

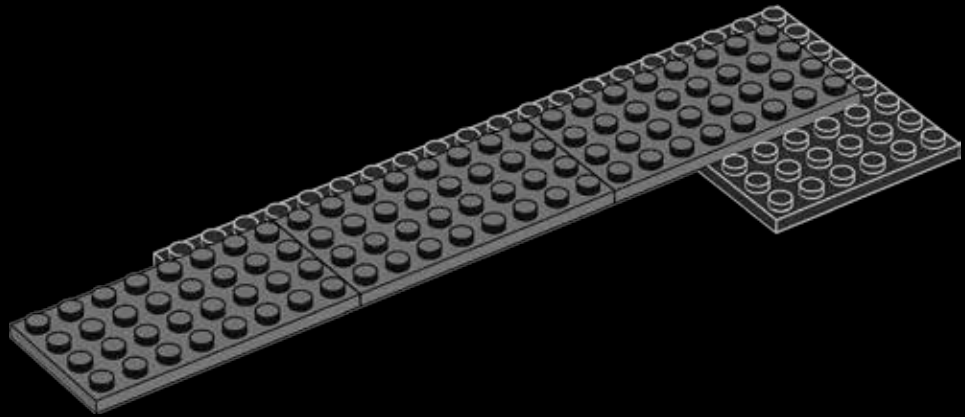

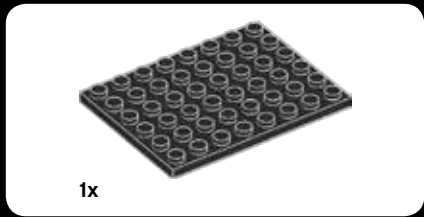

5

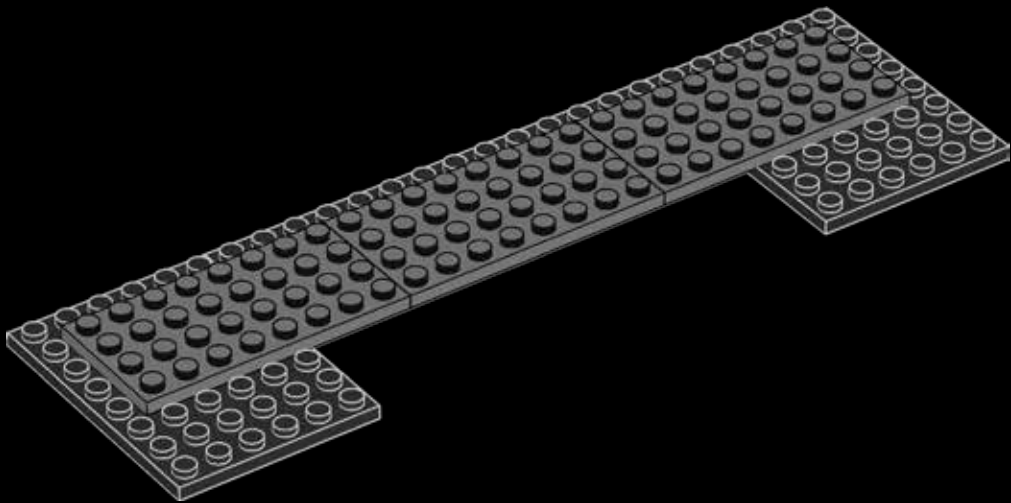

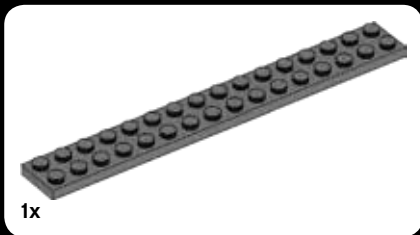

6

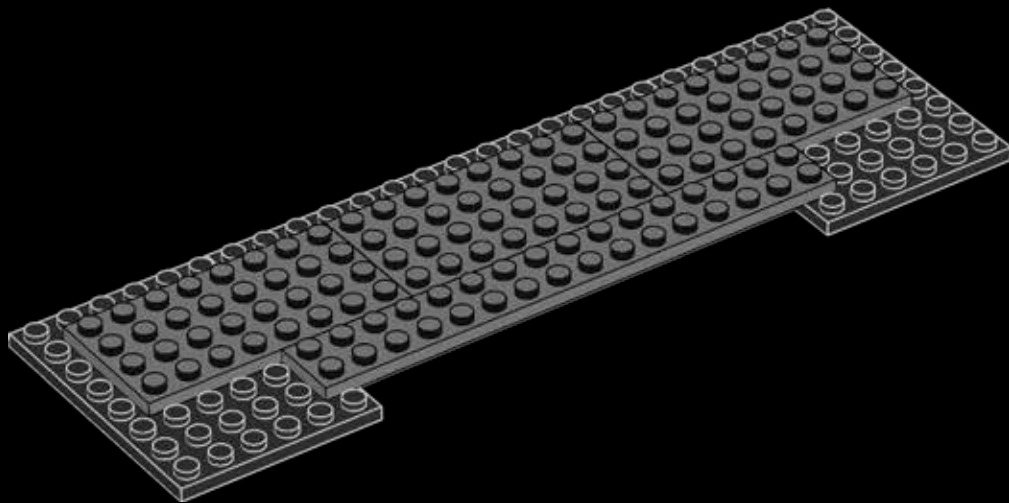



3x

7

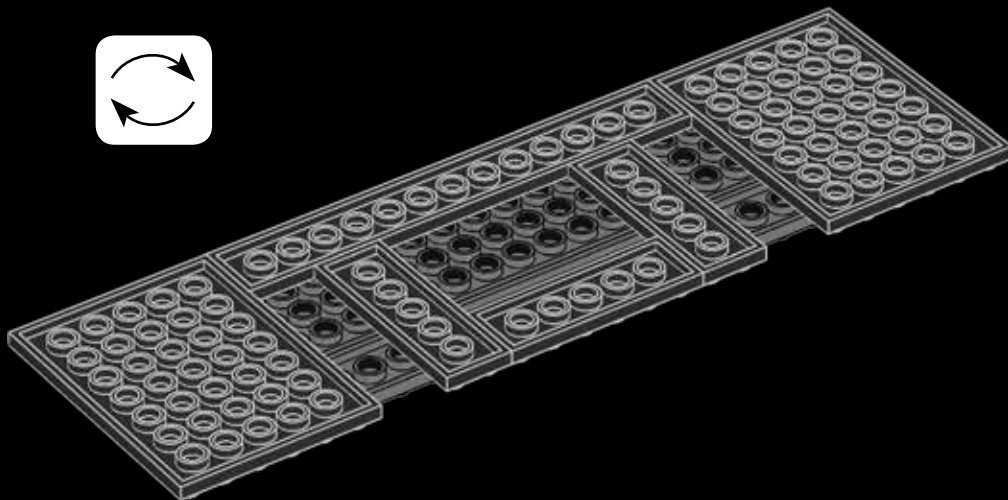

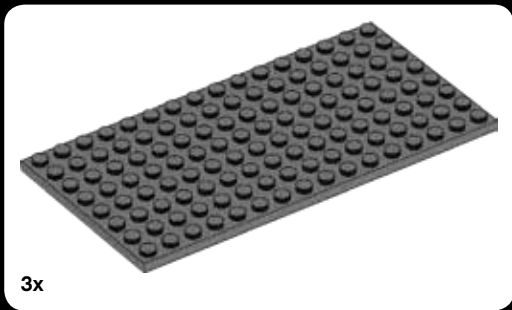

8

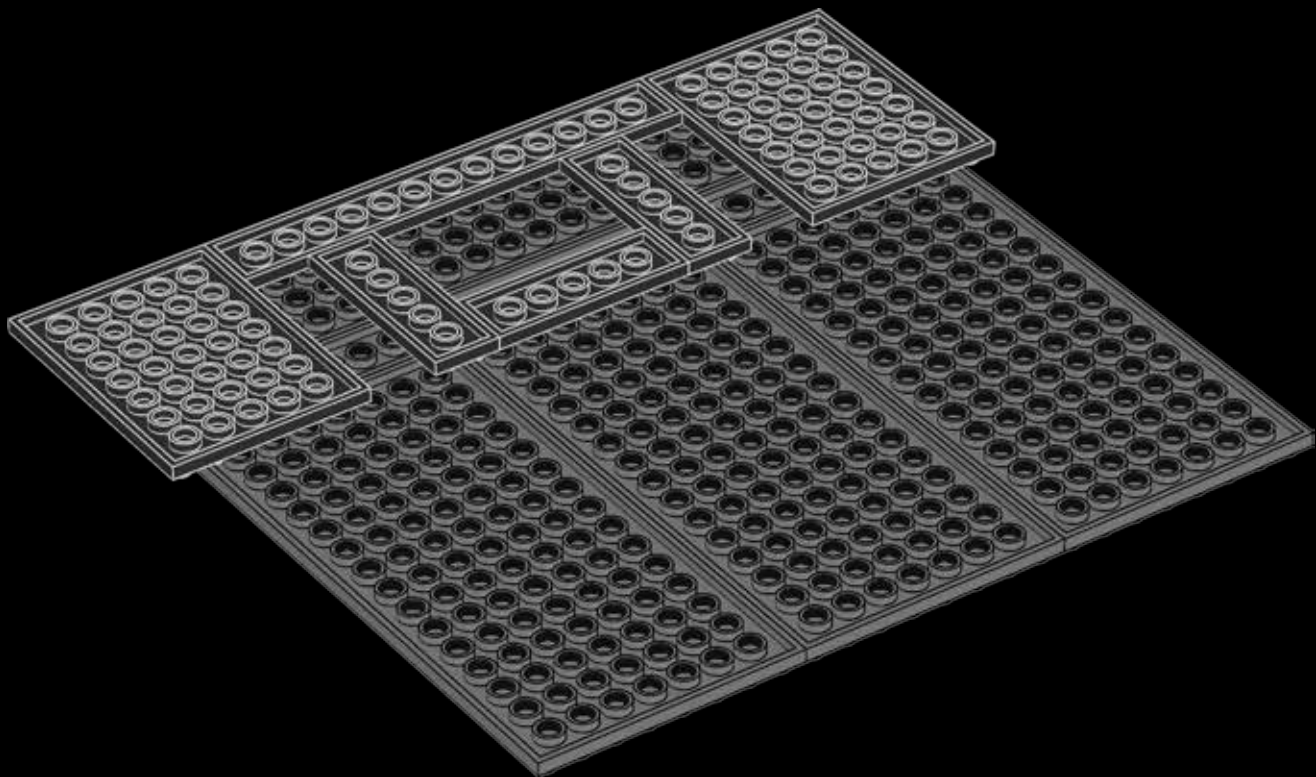

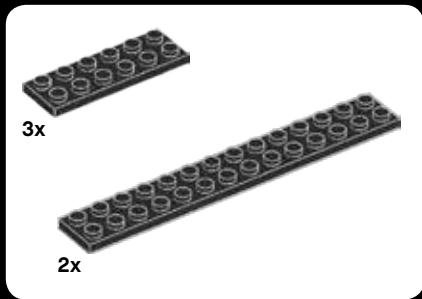

9

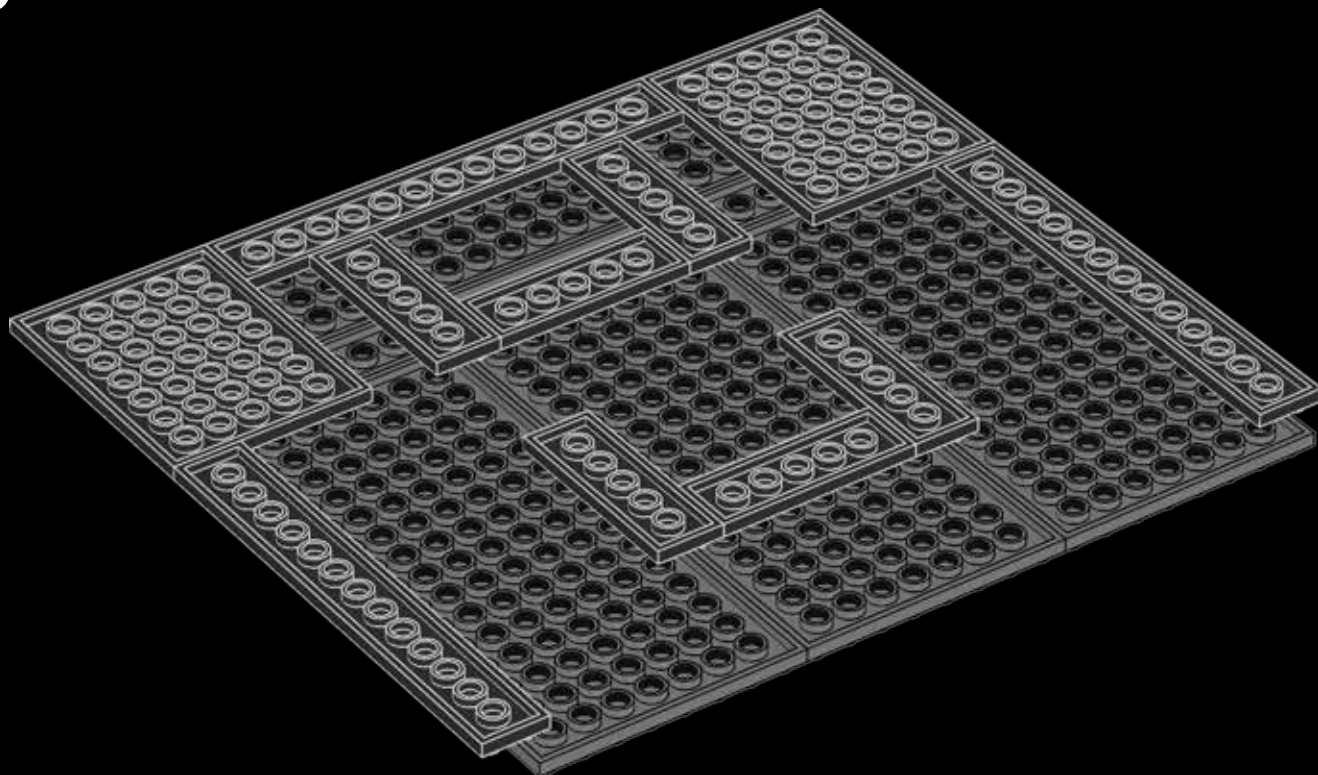

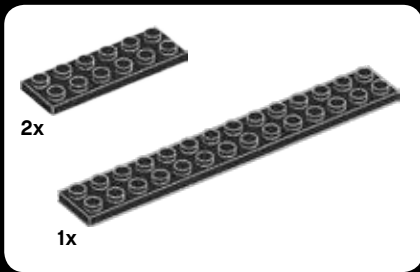

10

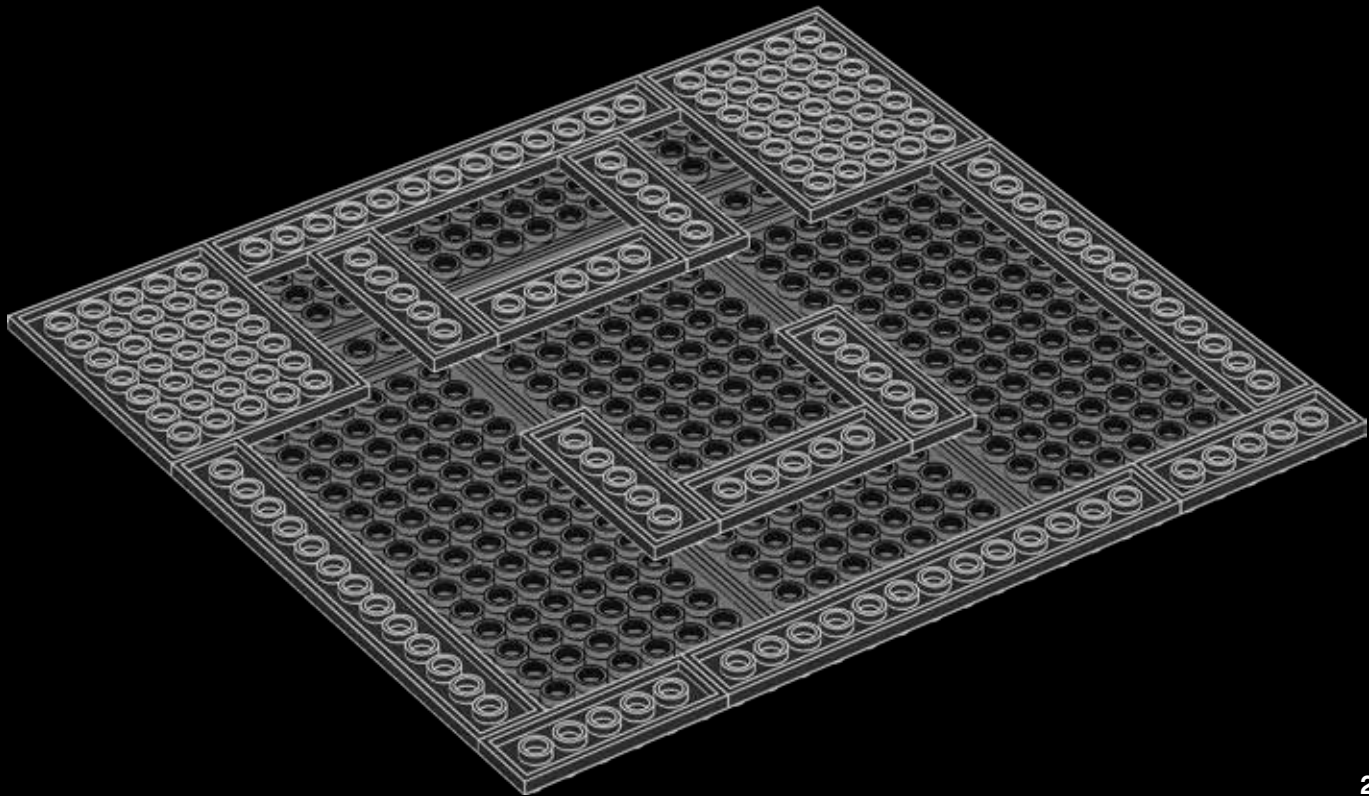



8x

11

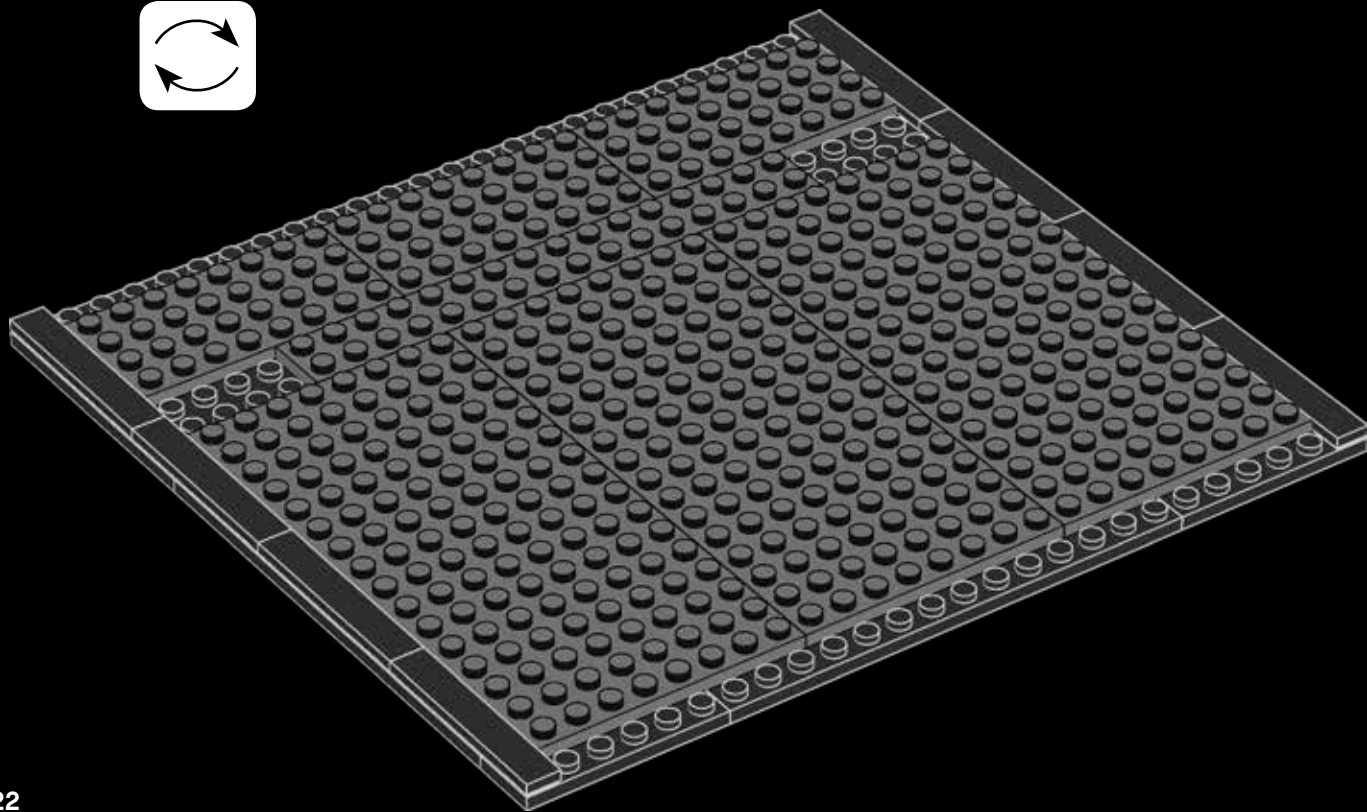

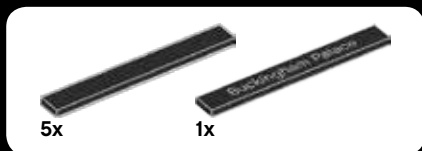

12

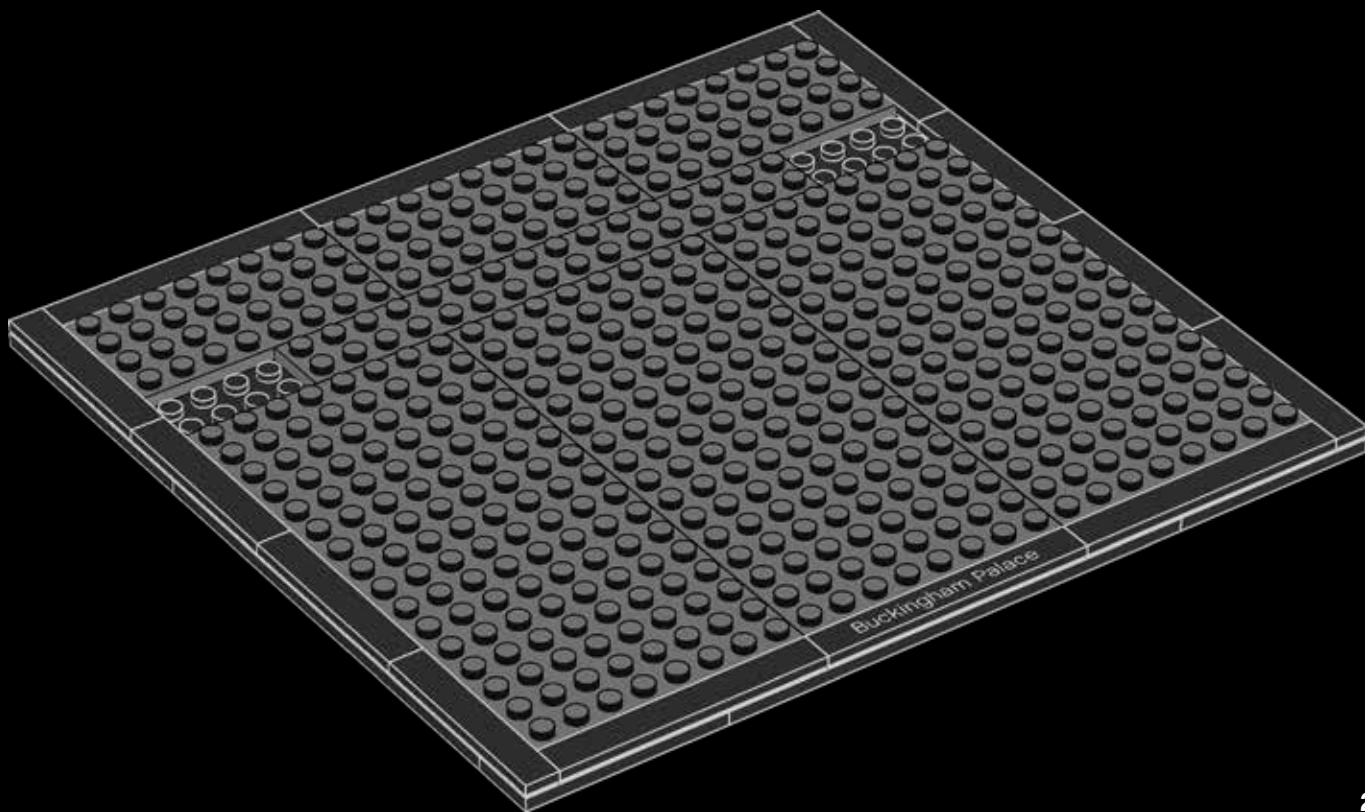



4x



2x



2x

13

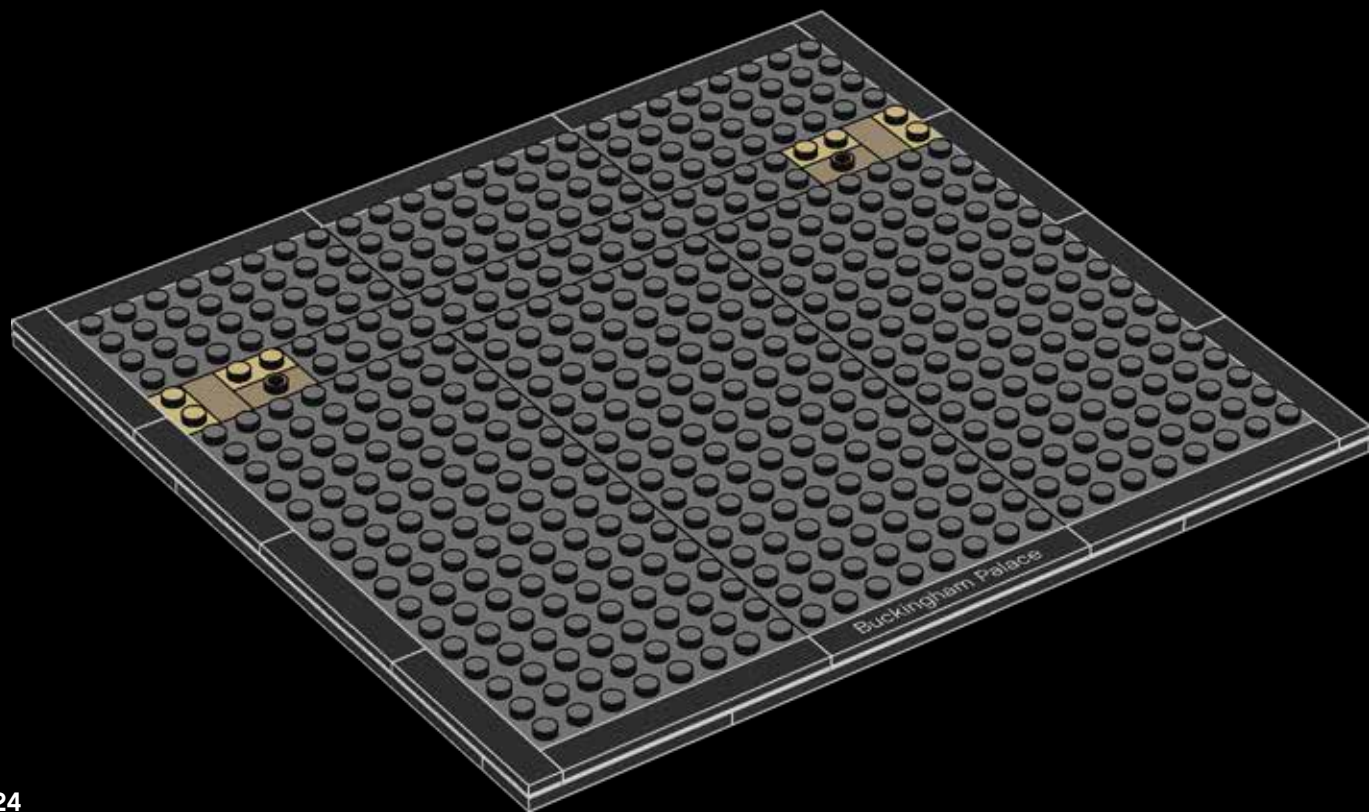

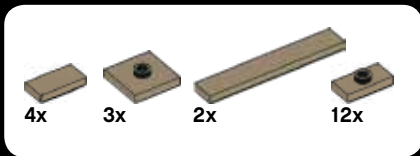

14

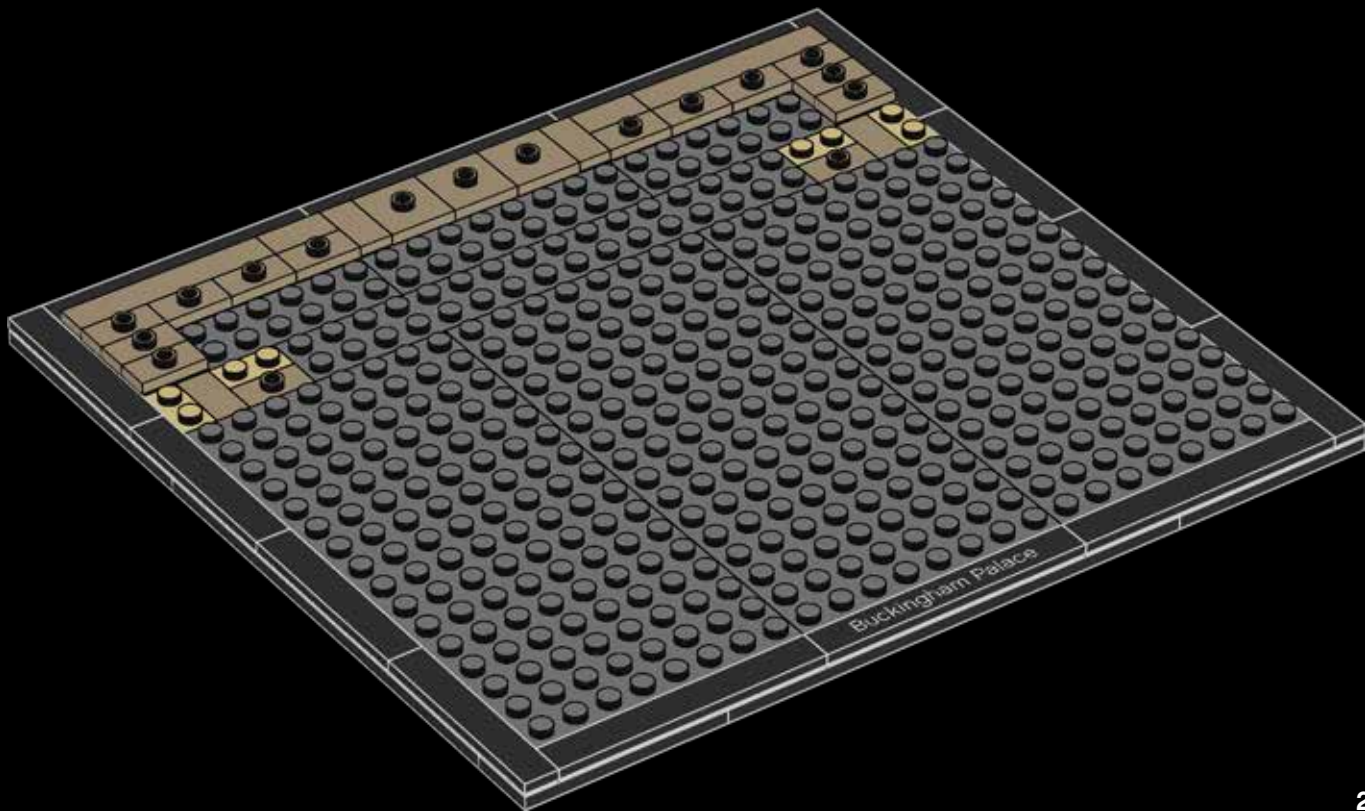

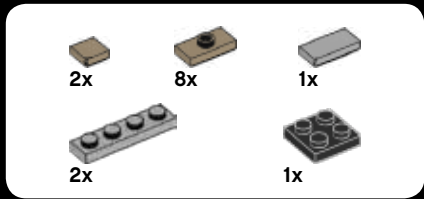

15

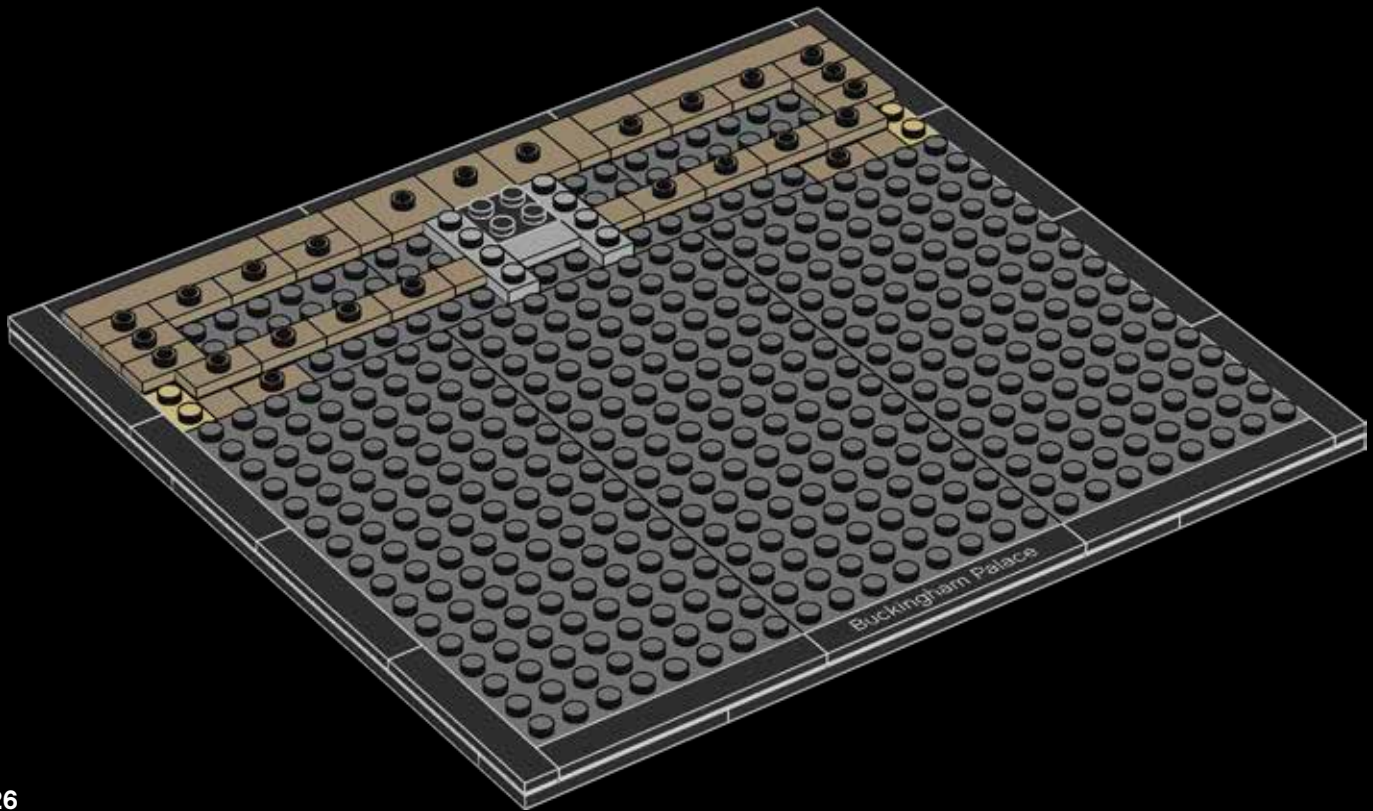

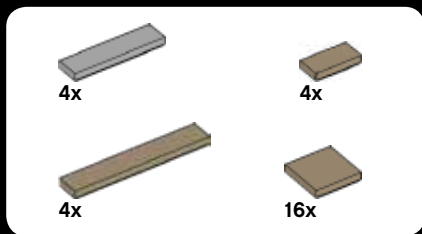

16

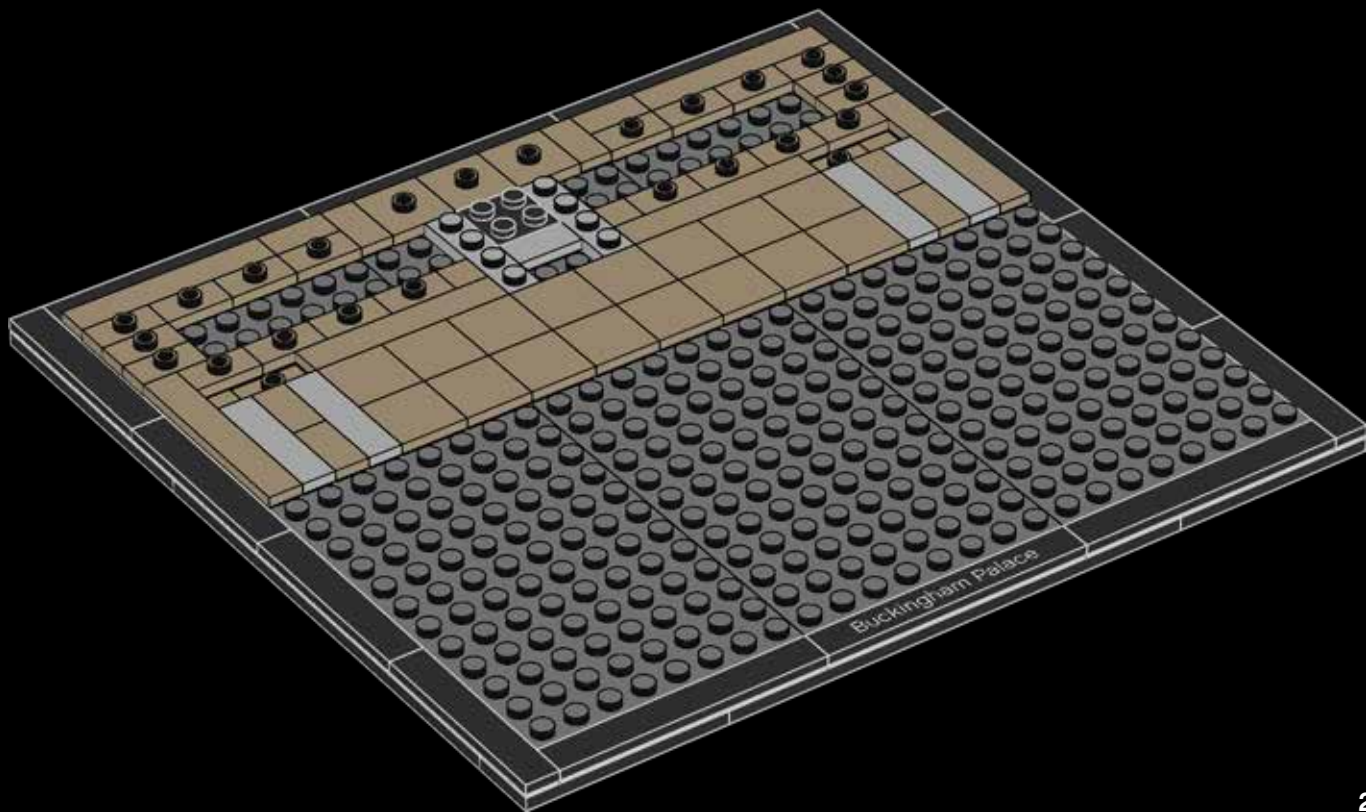

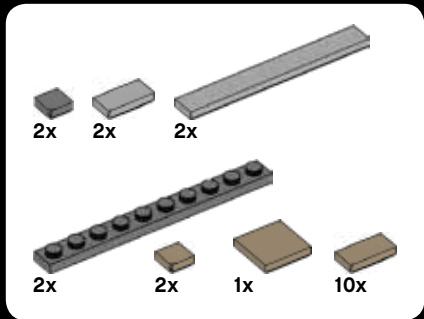

17

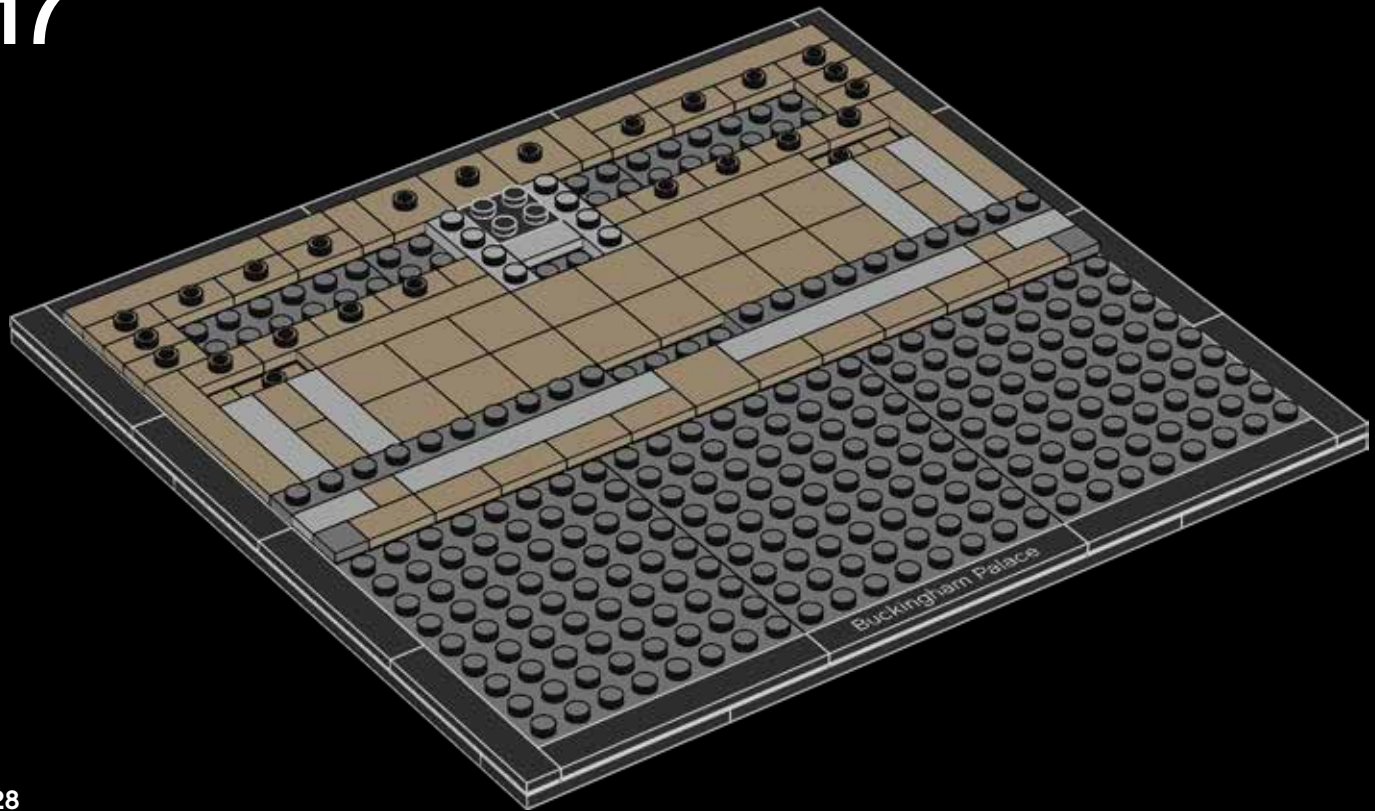

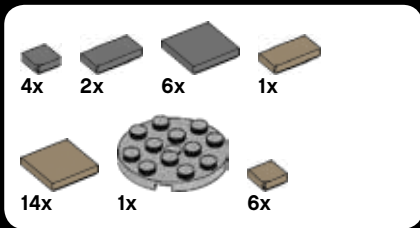

18

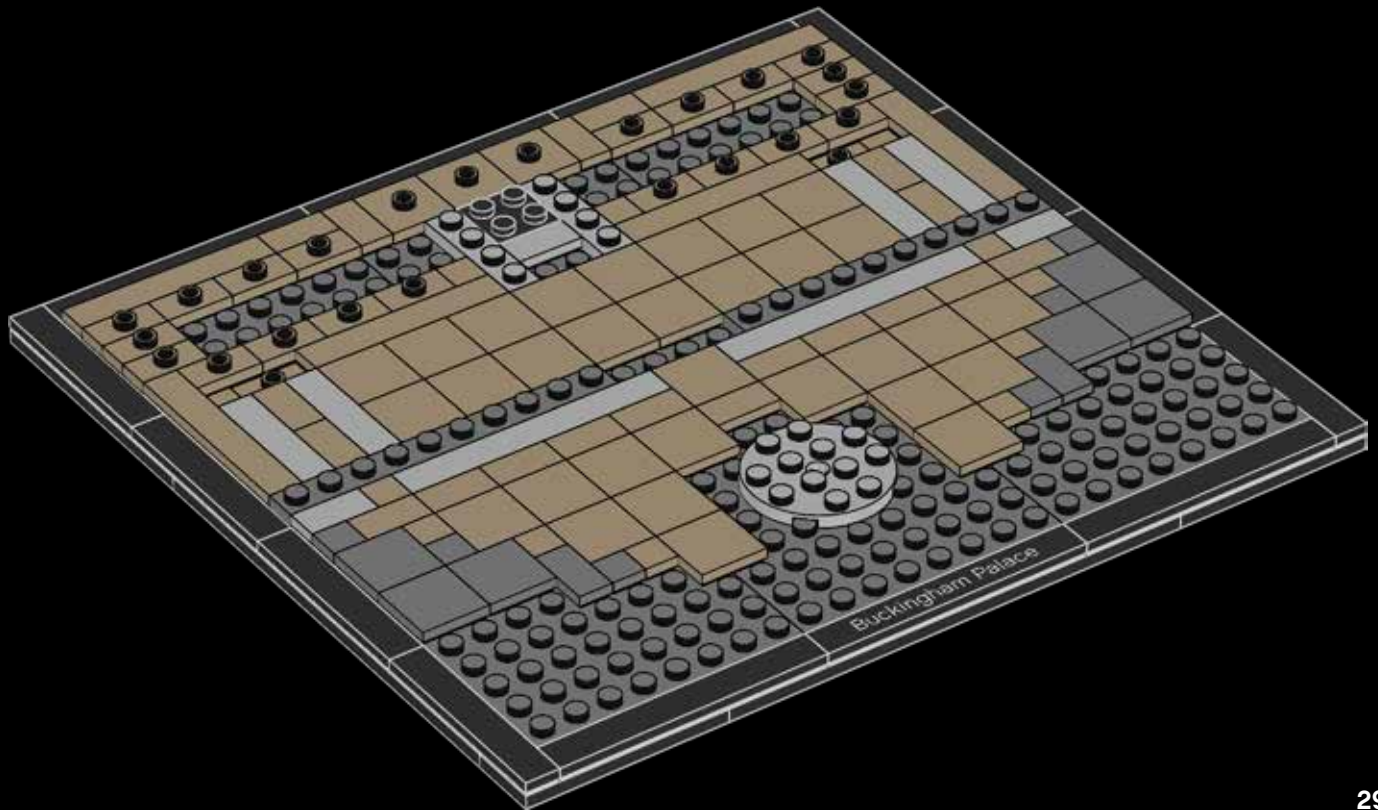

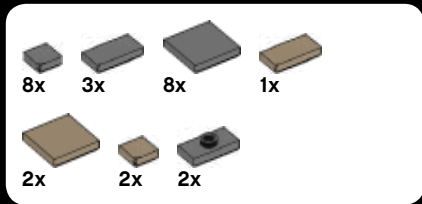

19

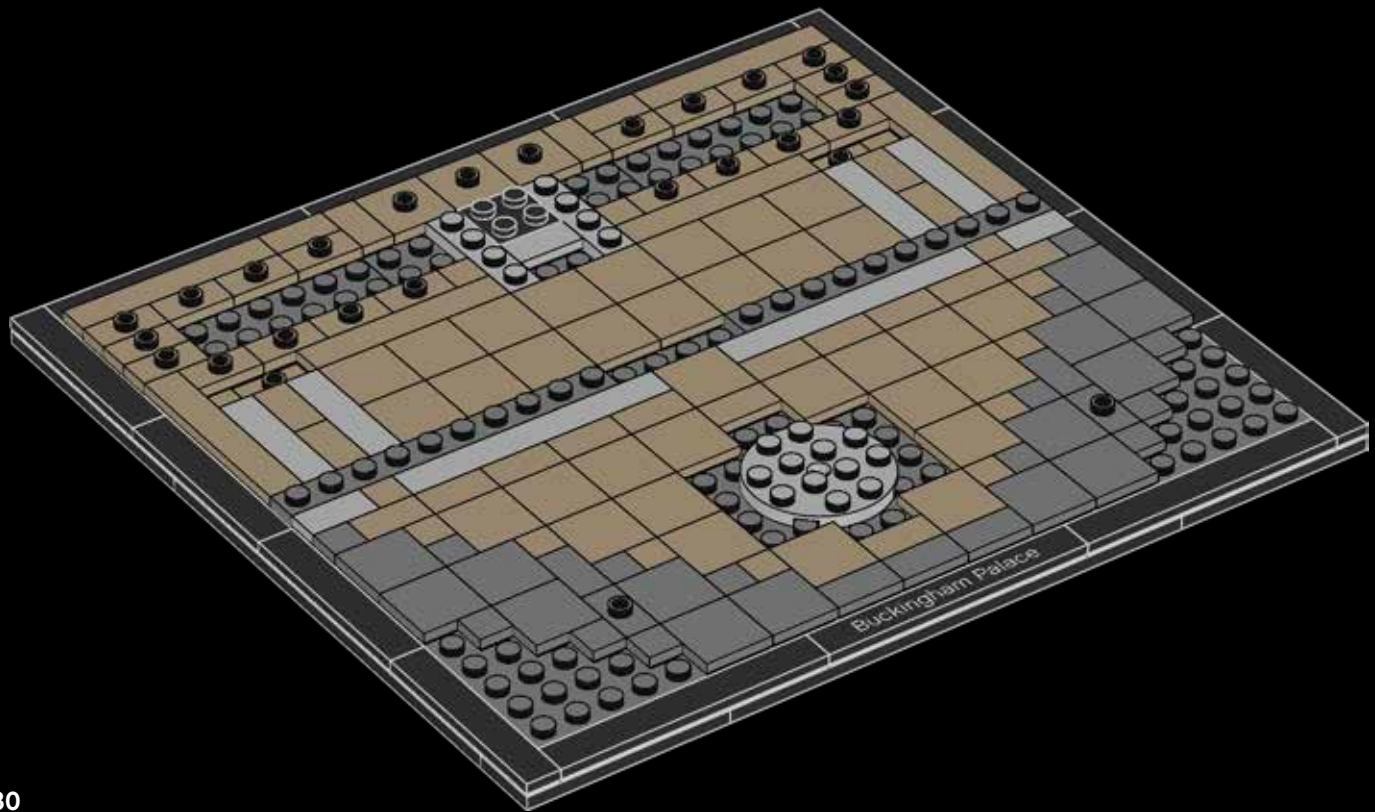



22x



8x

20

The Buckingham Palace garden is the largest private garden in London.

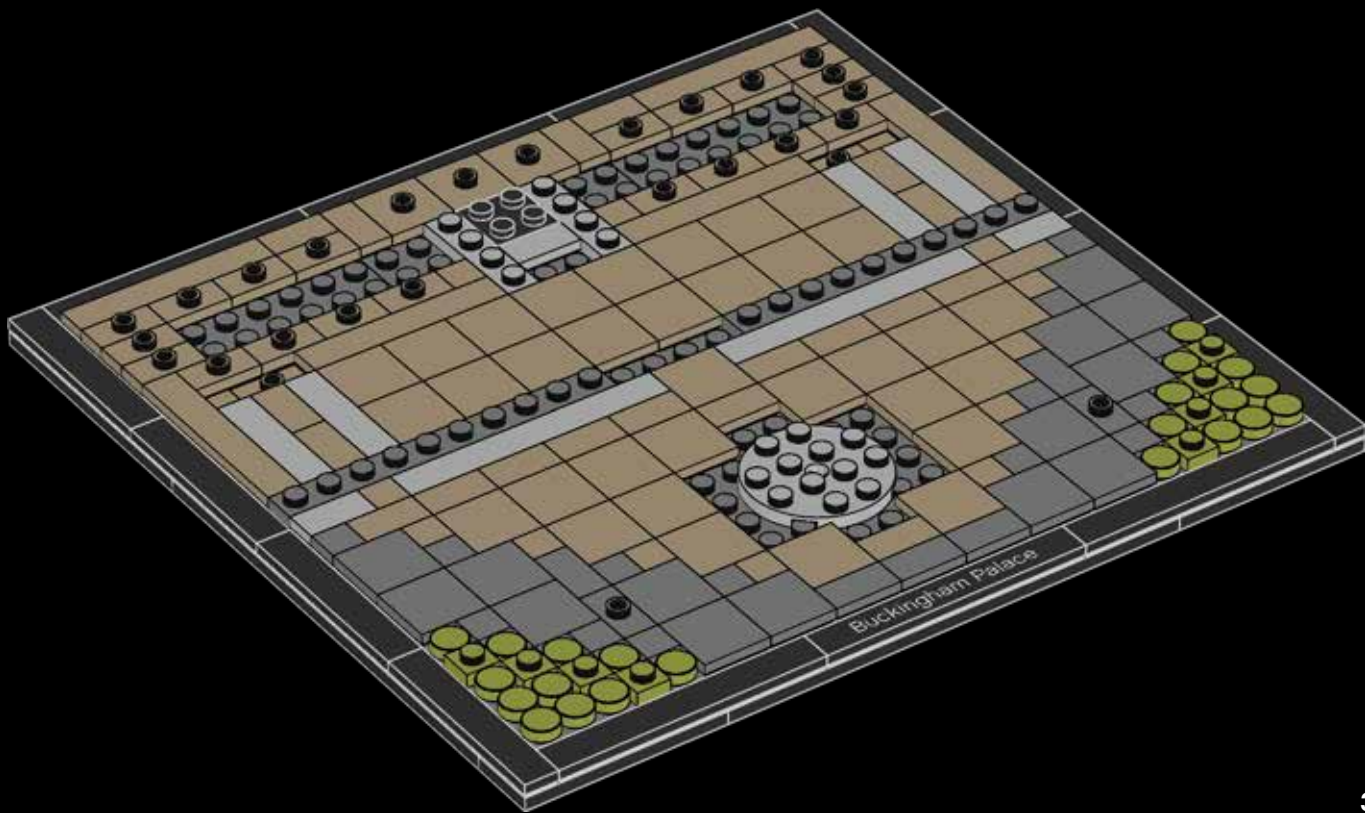

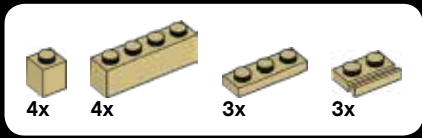

21

1



2

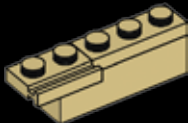

3

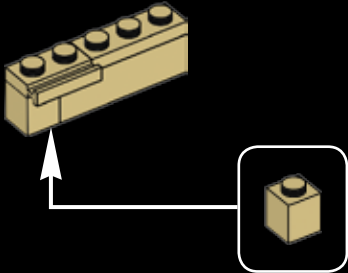

4

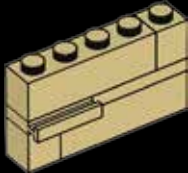

5

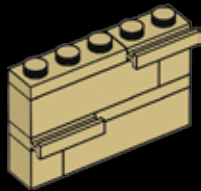

7

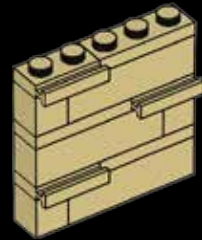

6

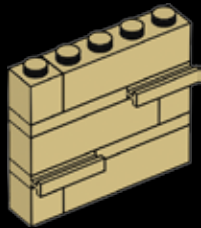

8

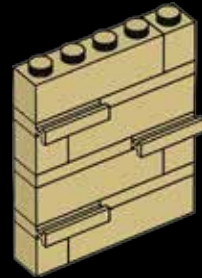

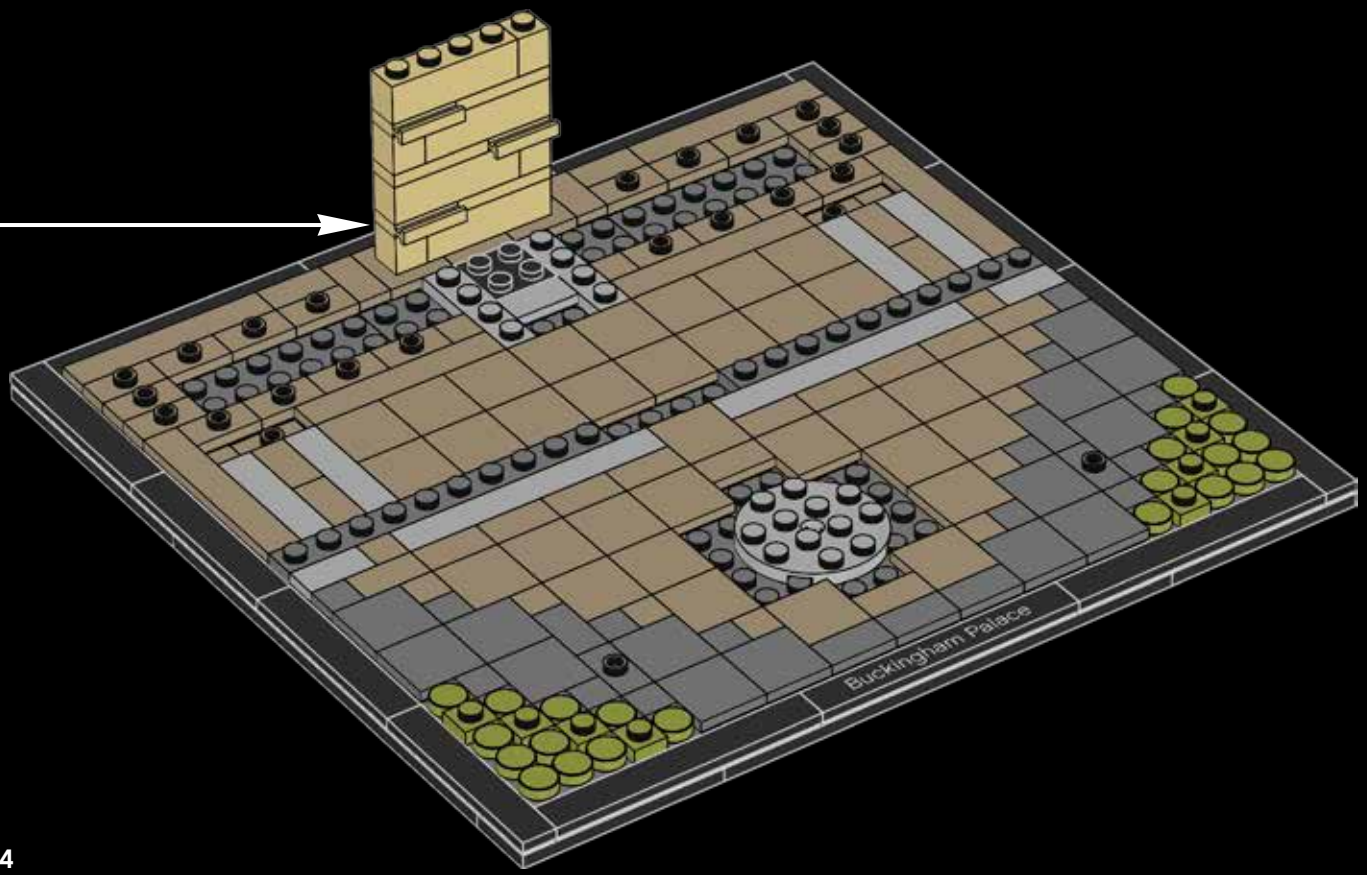



2x

22

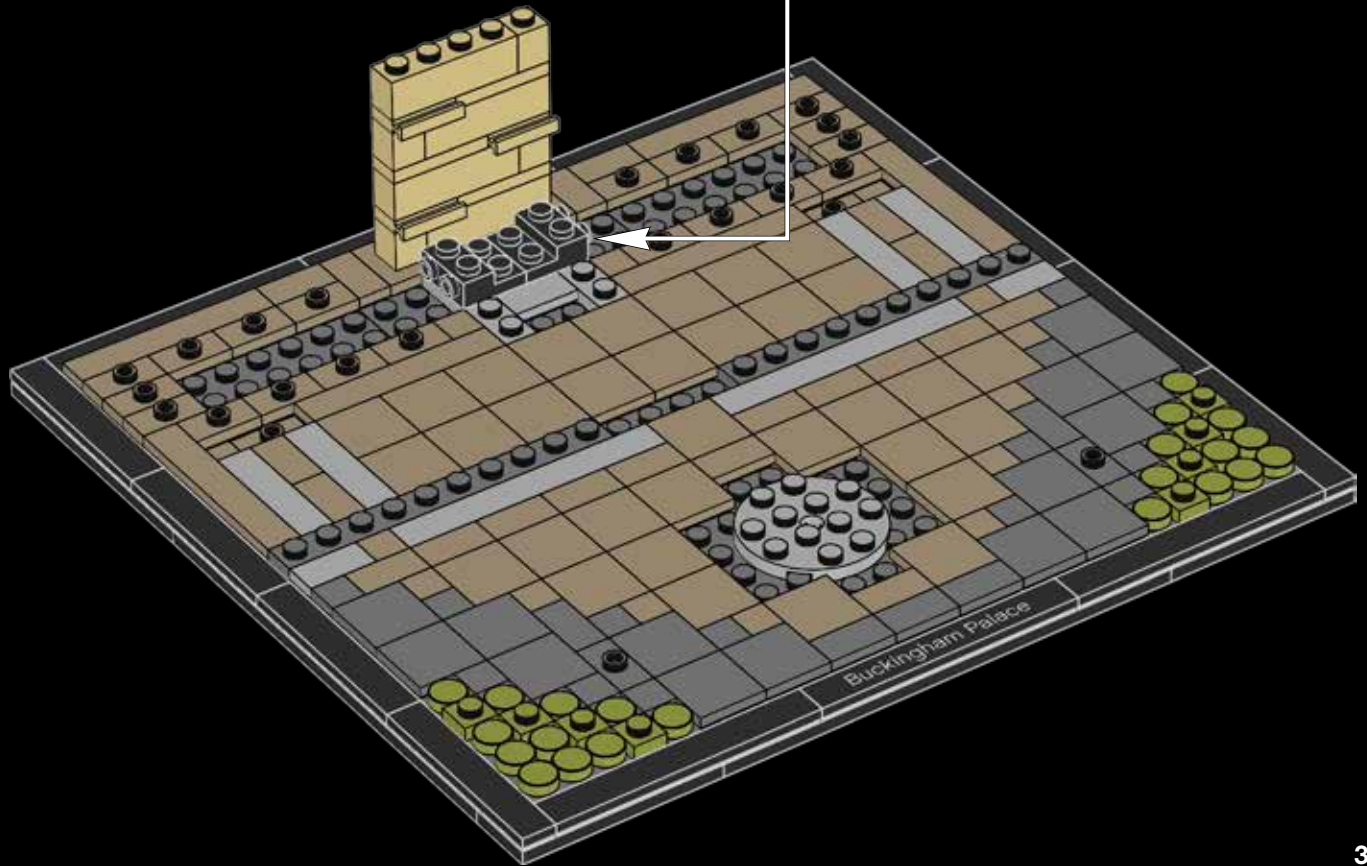
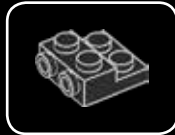



2x

23

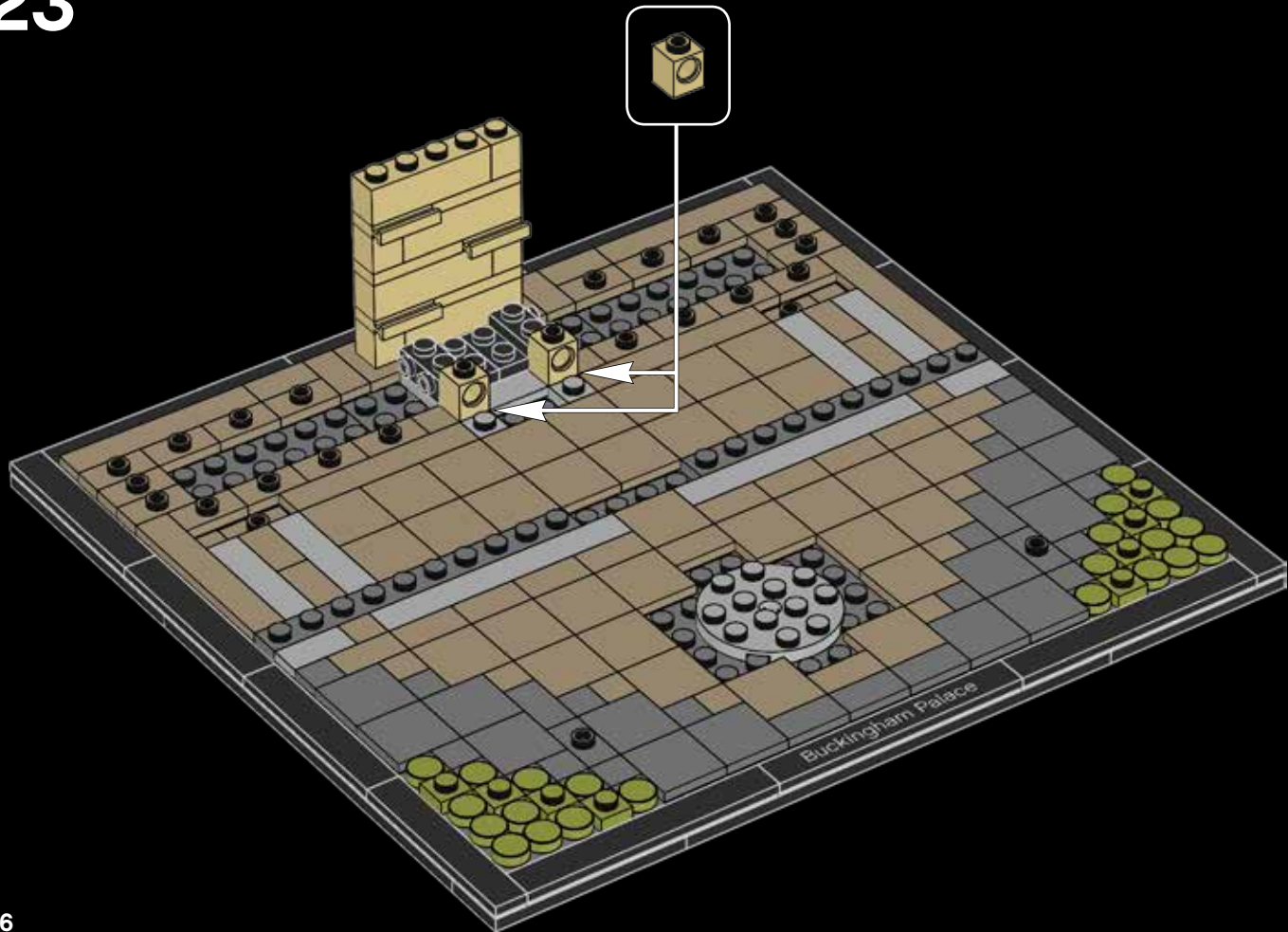



2x

24

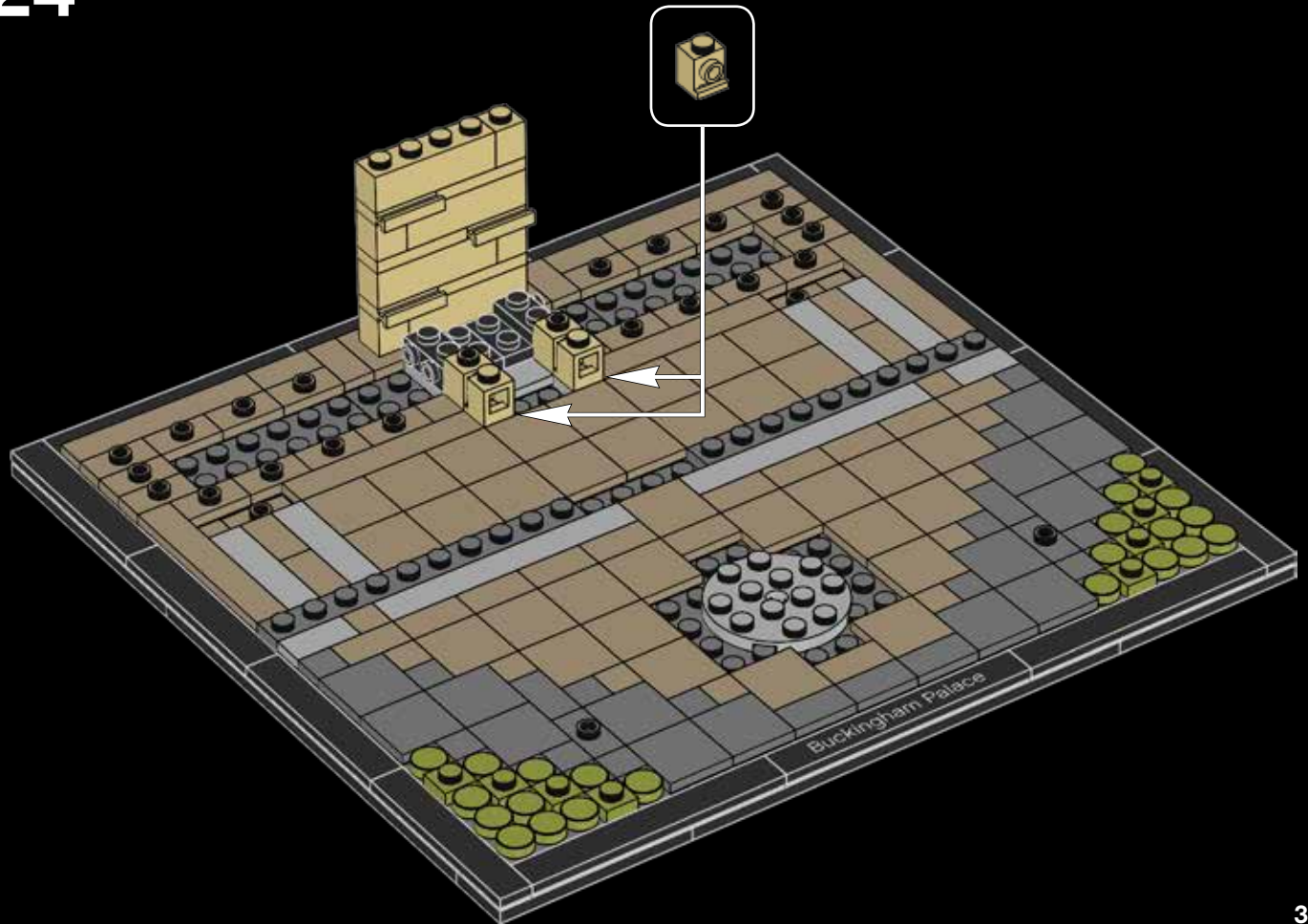



2x



2x

25

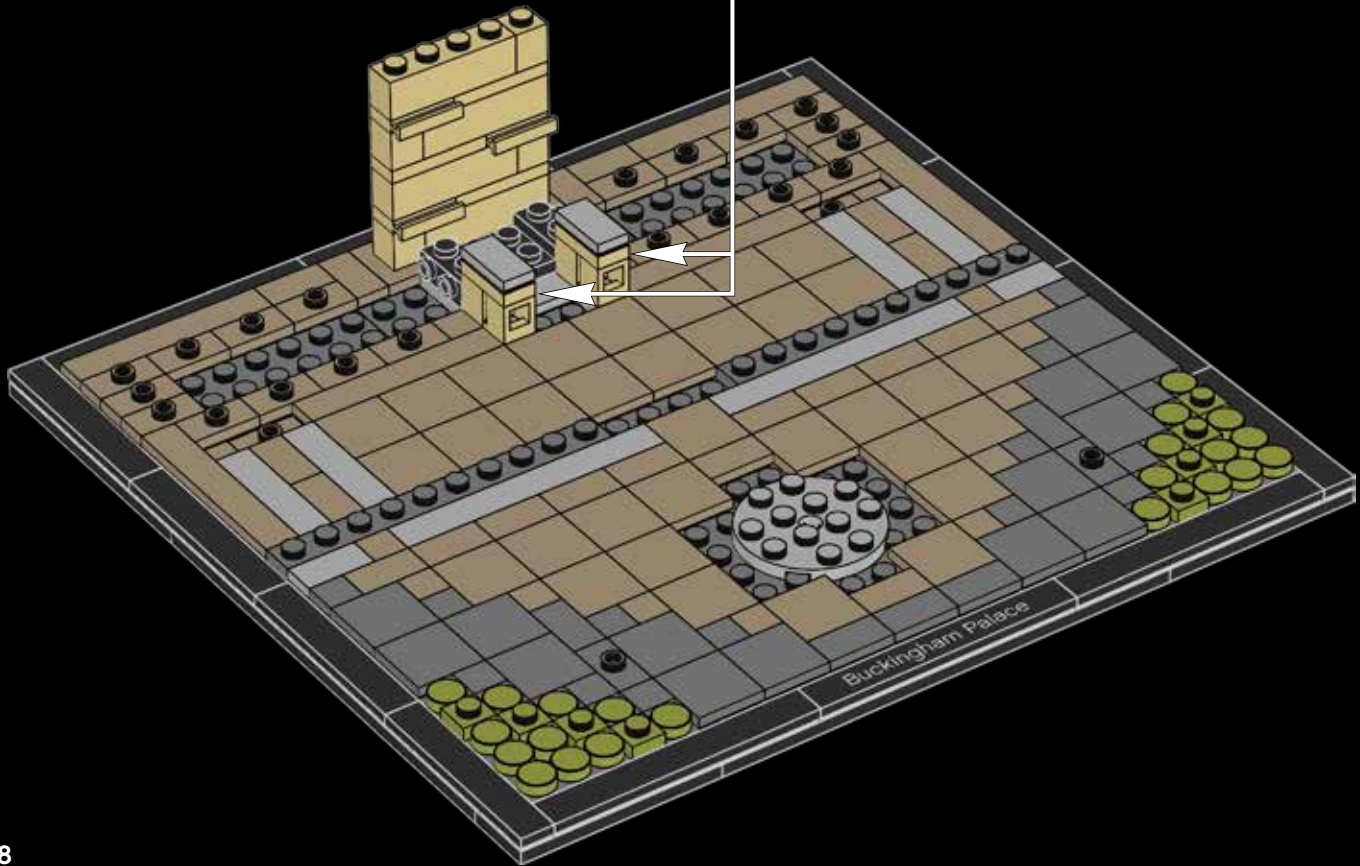
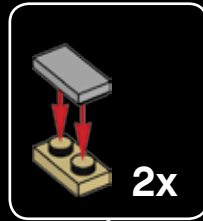



2x

26

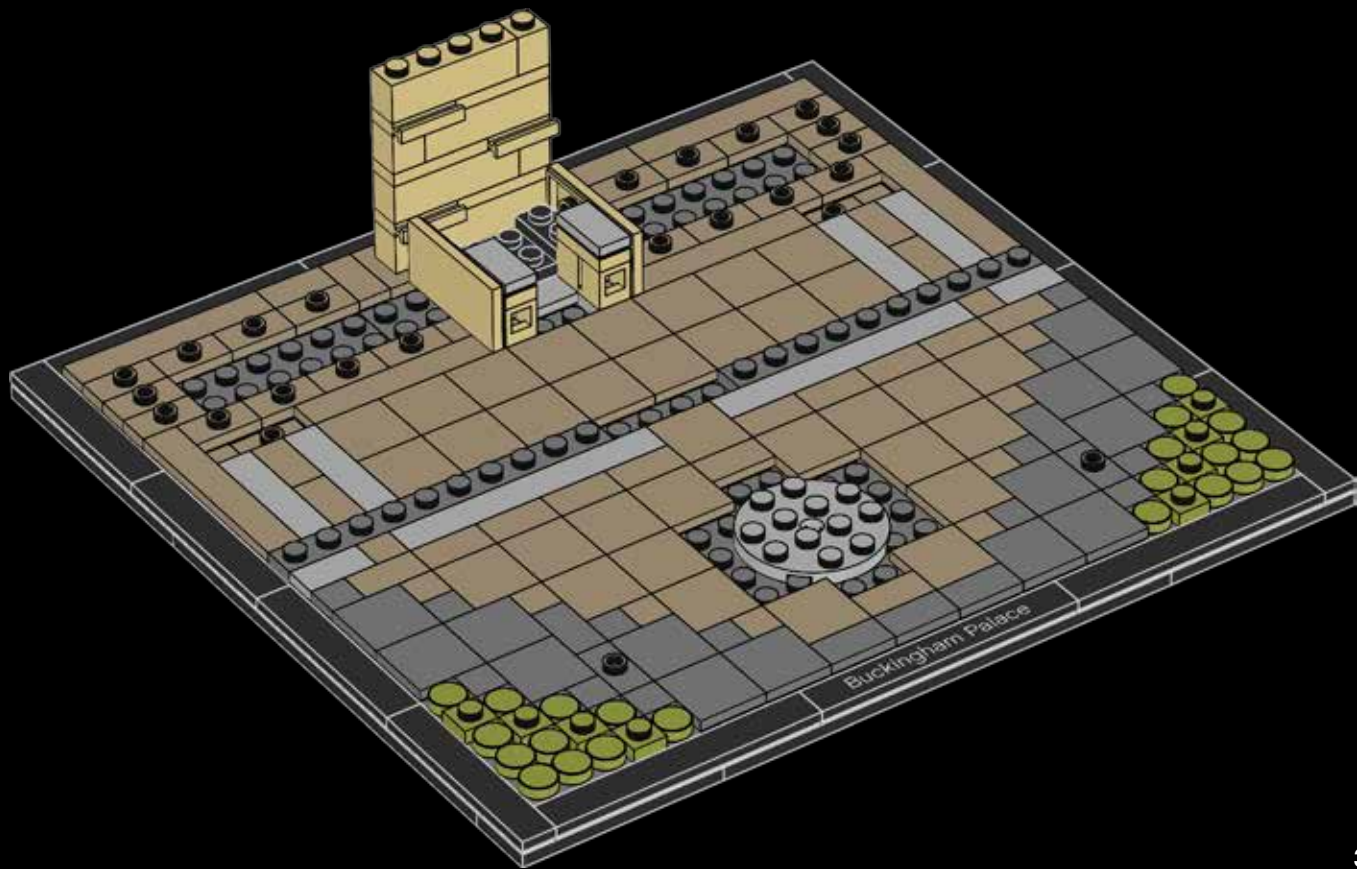



2x



2x



2x

27

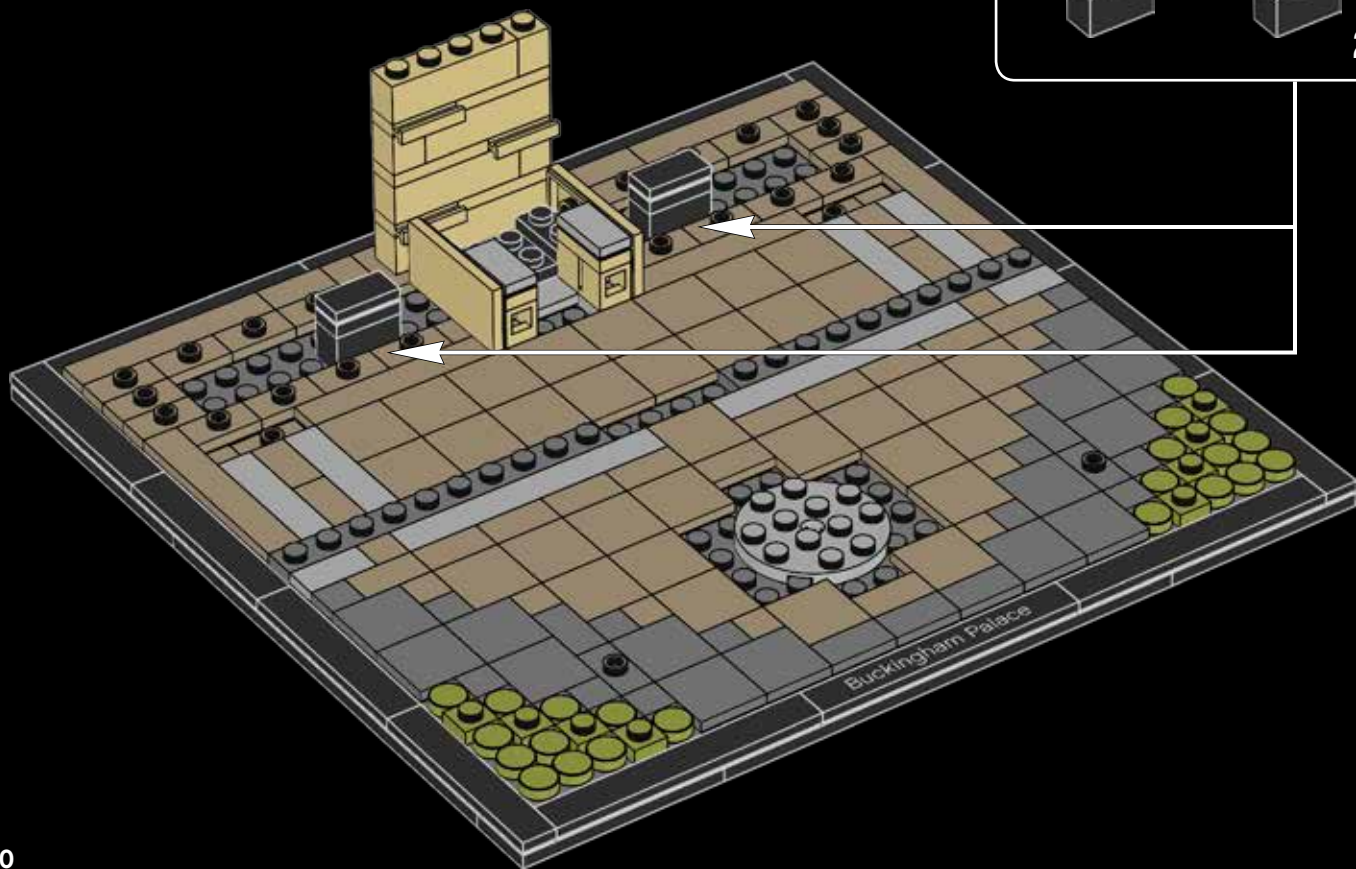
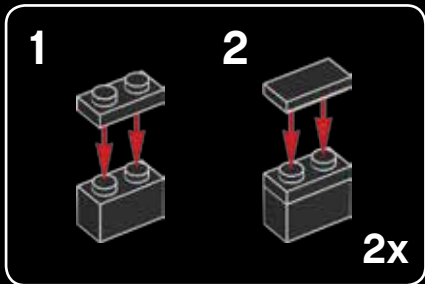

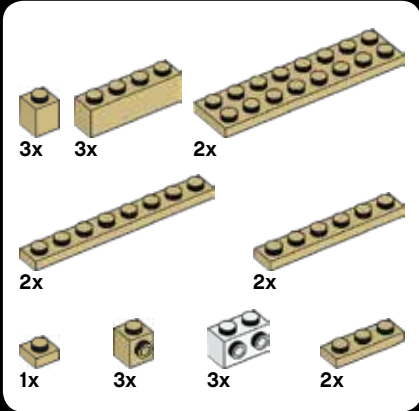

28

1

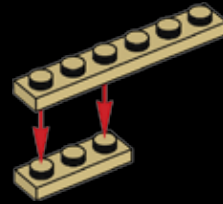

2



3

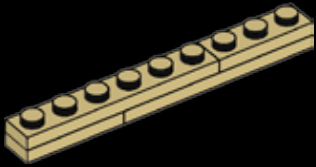

5

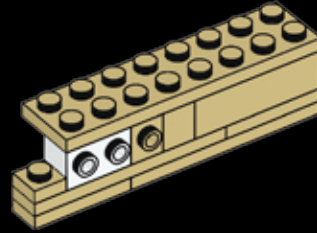

4

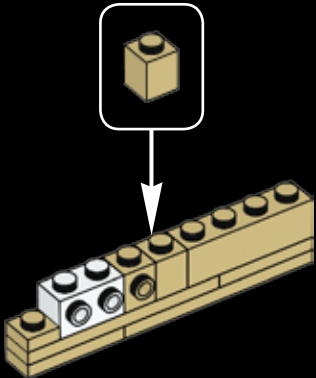

6

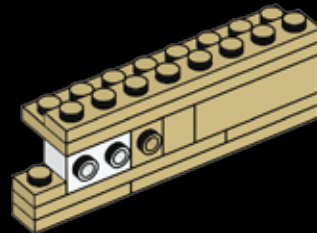

7

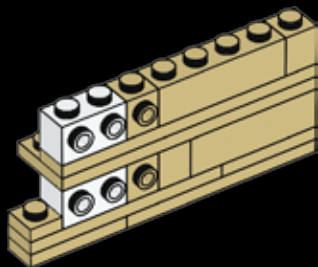

9

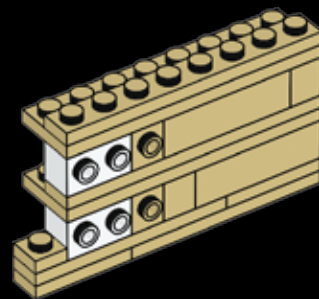

8

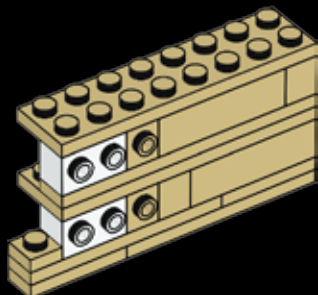

10

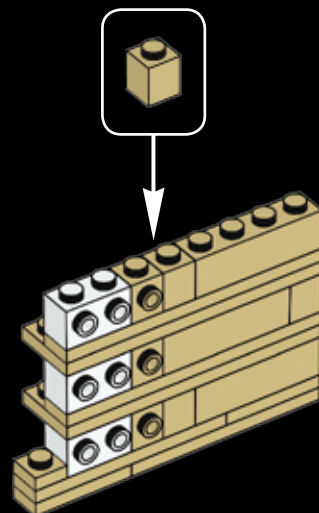

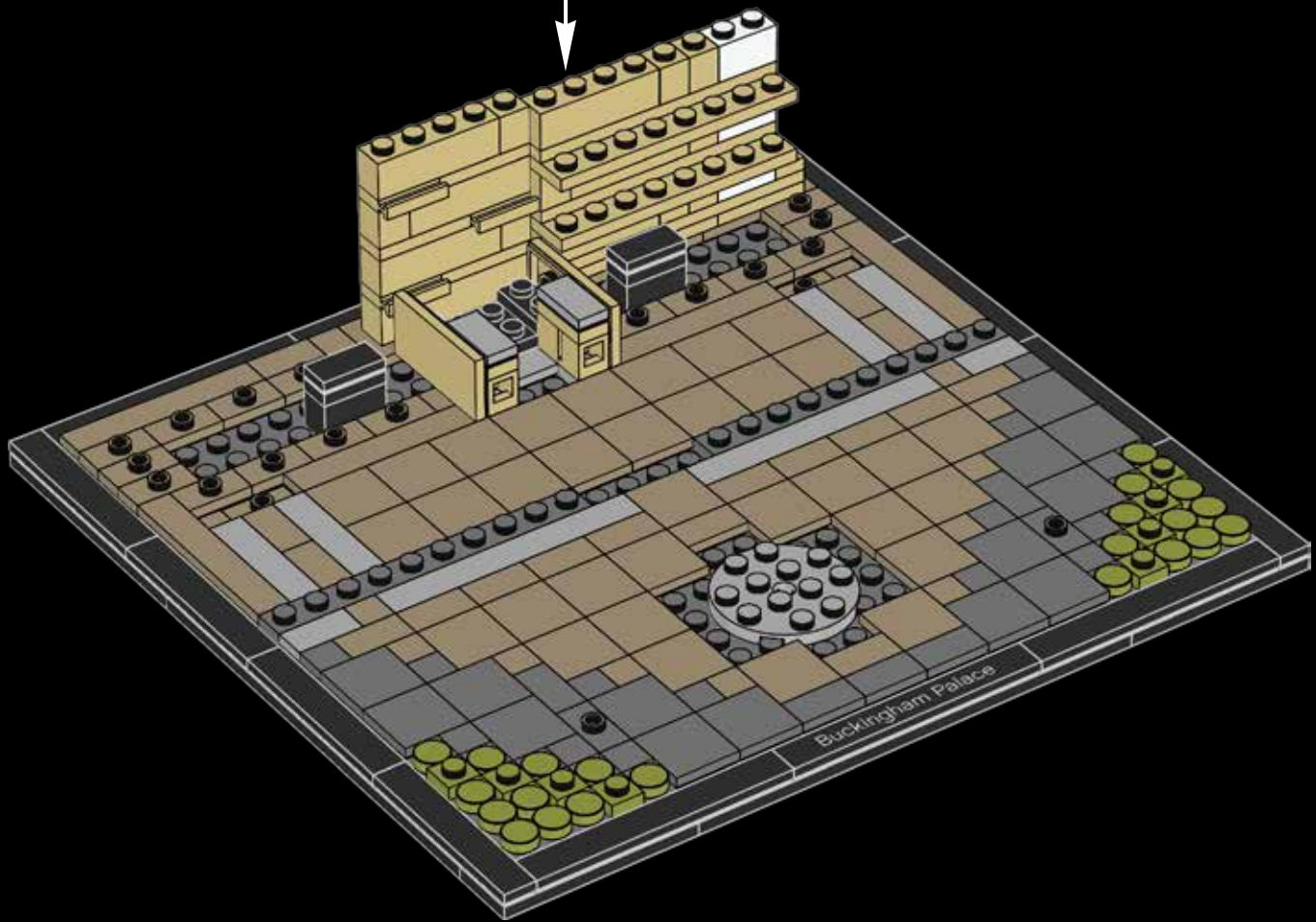

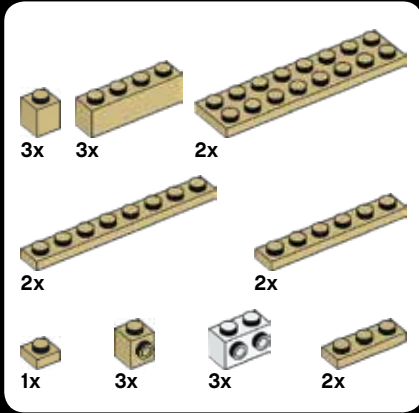

29

1

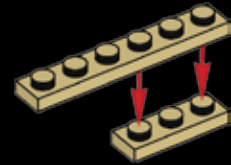

2

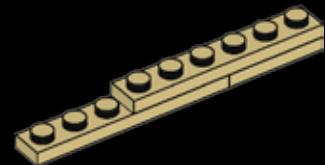

3

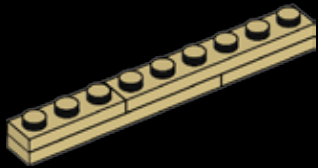

5

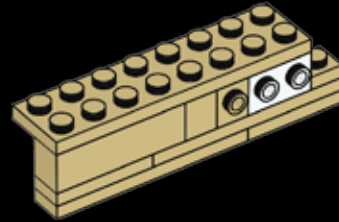

4

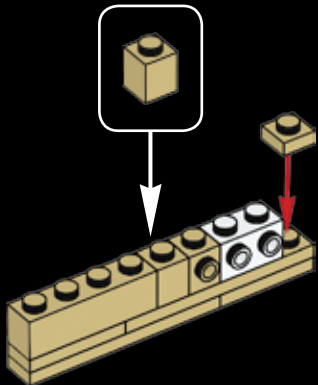

6

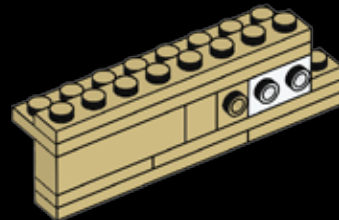

7

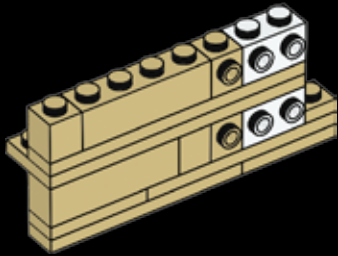

8

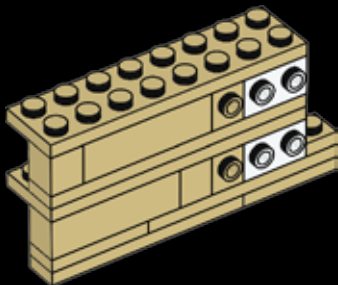

9

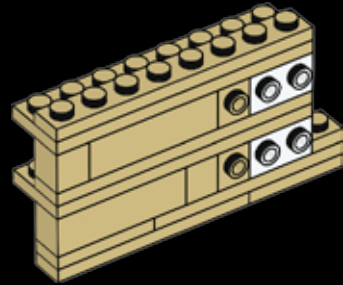

10

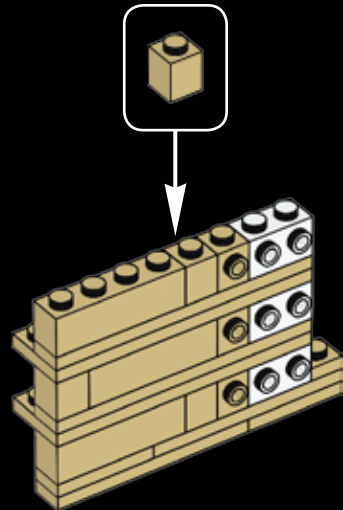

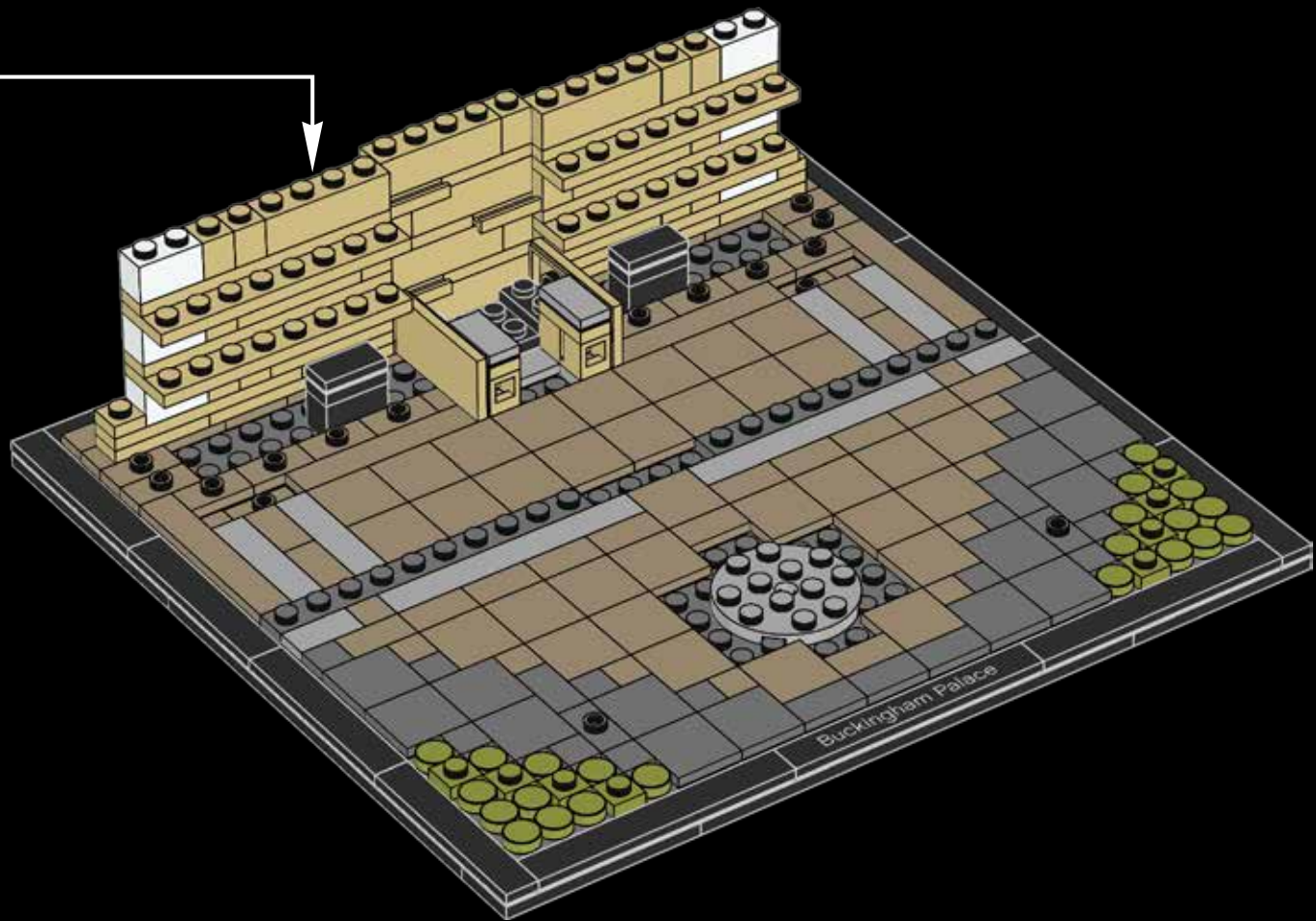



2x

30

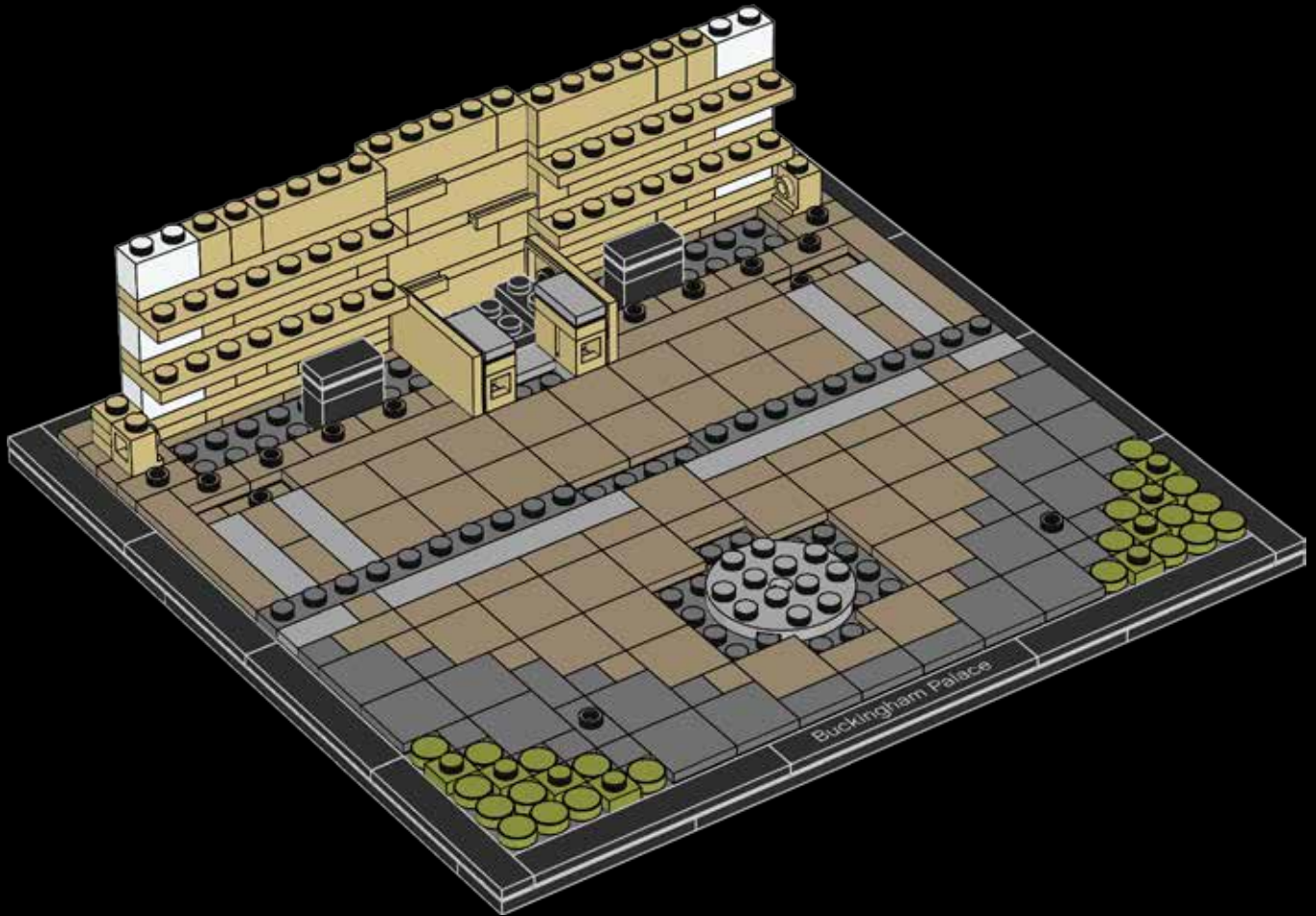



2x

31

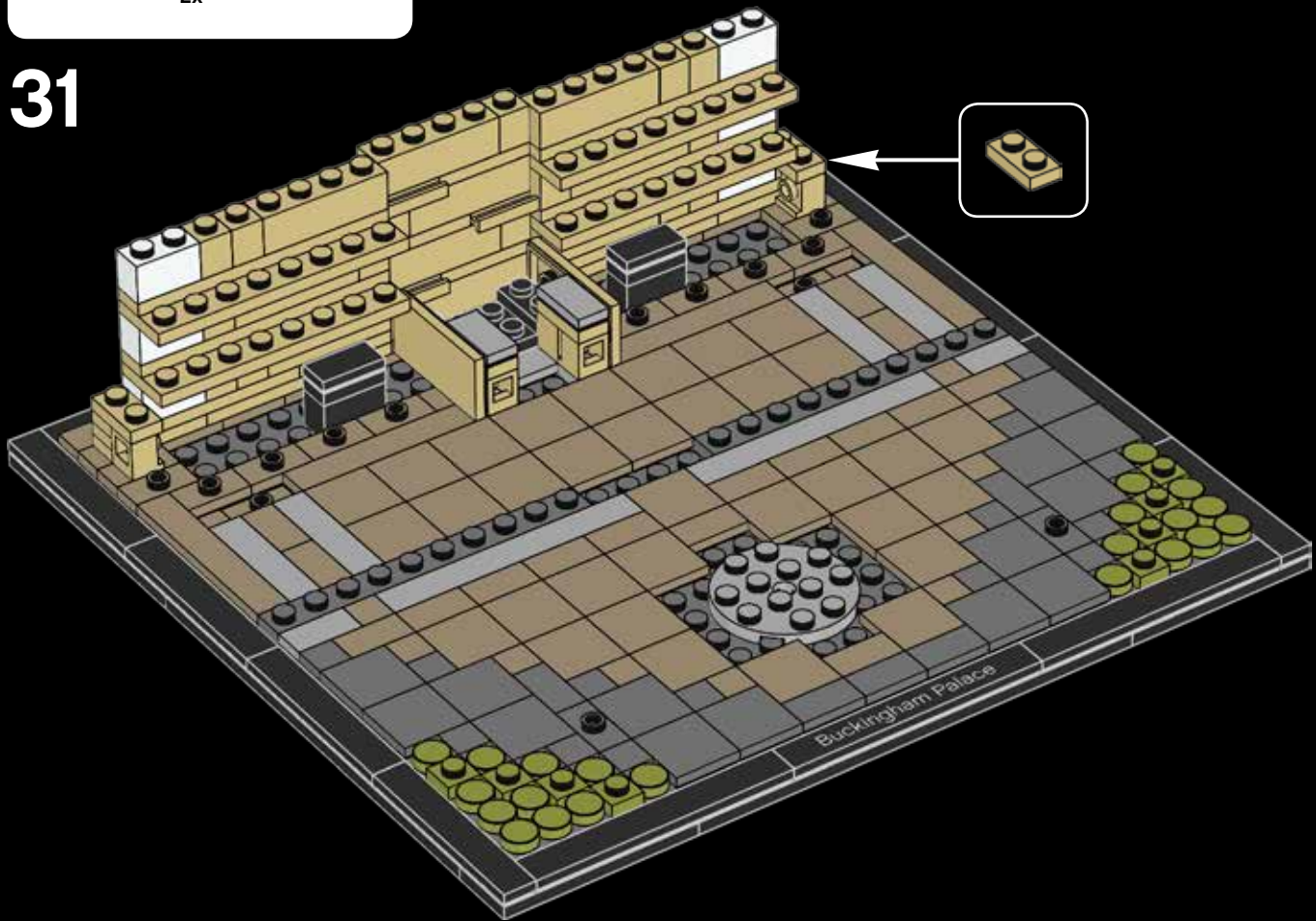



4x



2x



2x

32

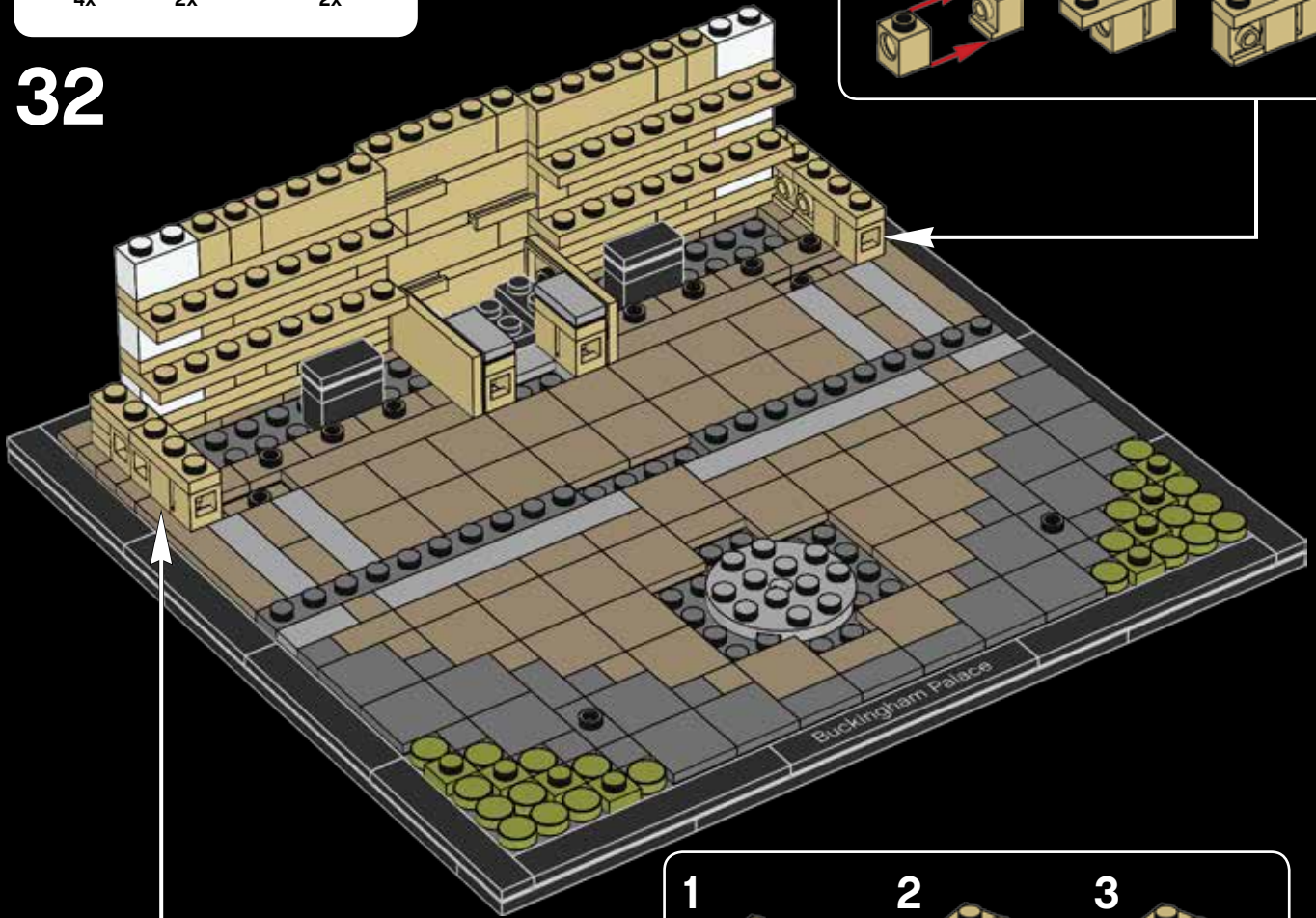

1

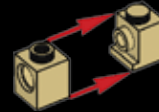

2



3

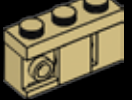

1

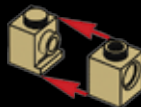

2



3

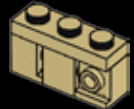



33

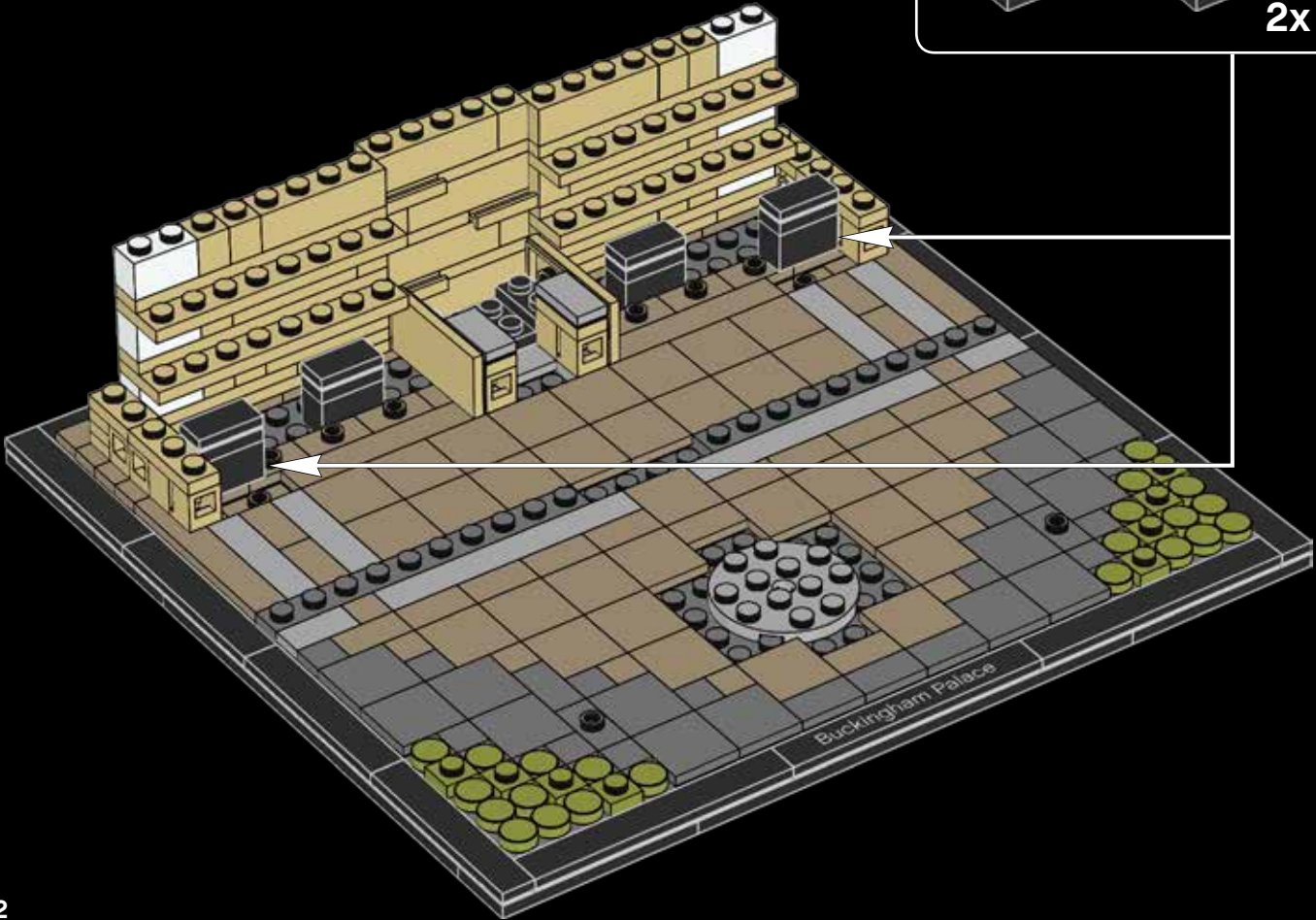
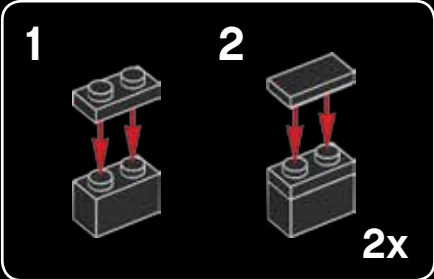



2x



2x

34

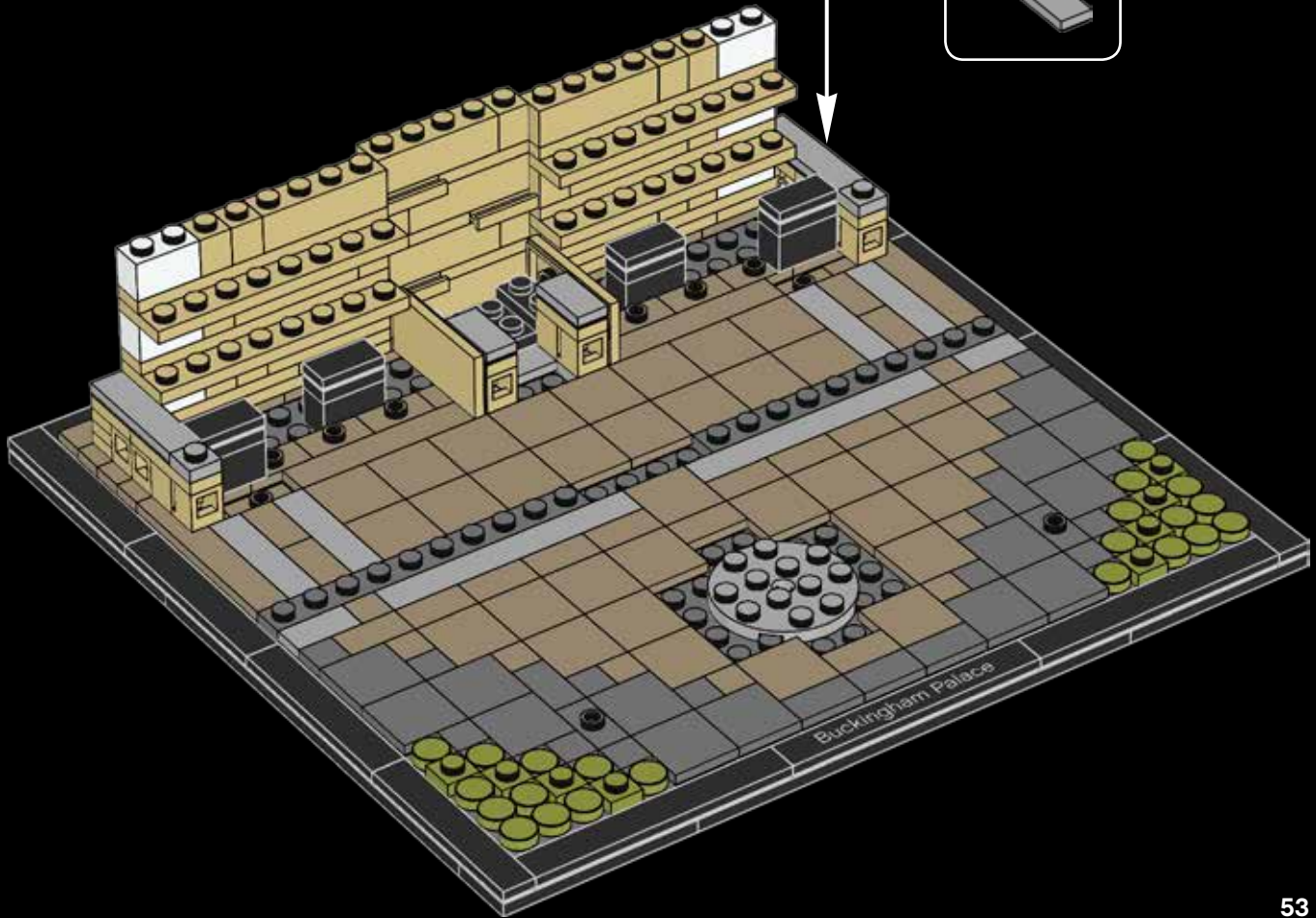
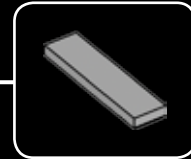

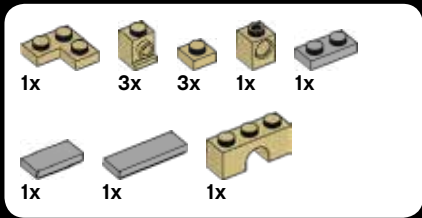

35

1

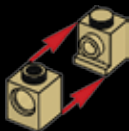

2



3



4



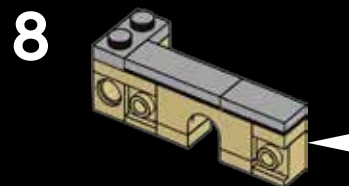
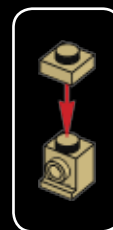
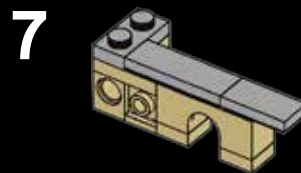
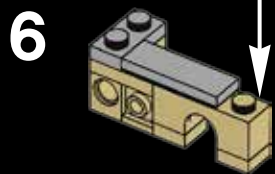
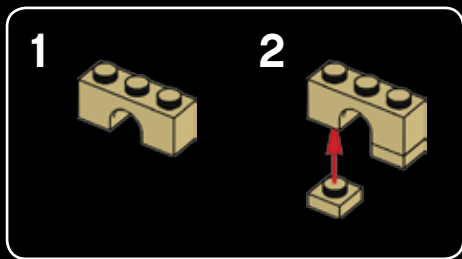
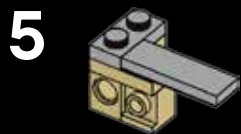

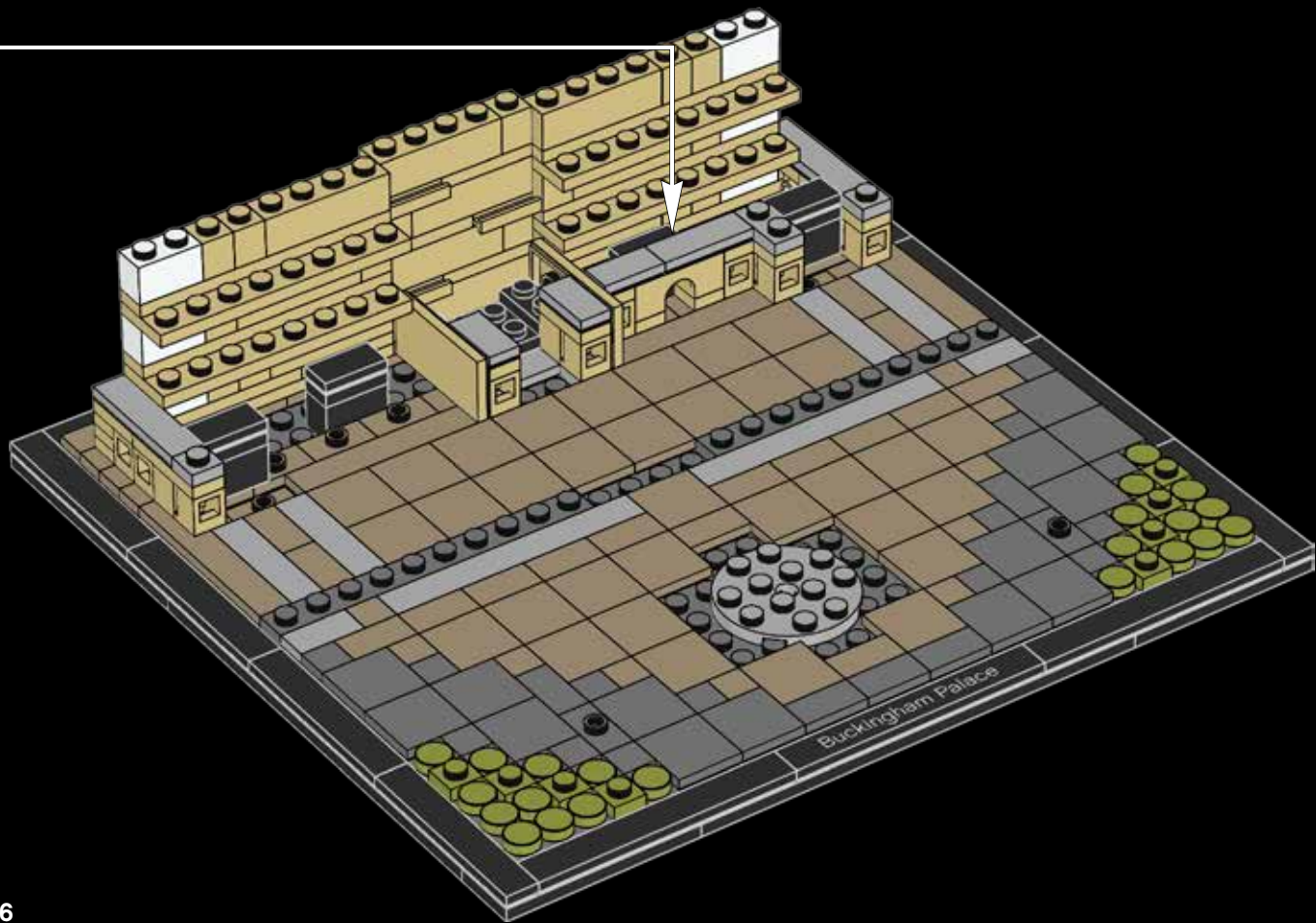

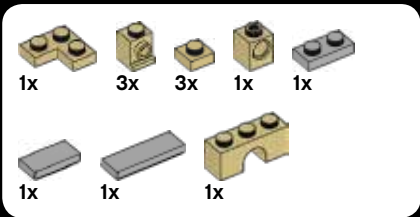

36

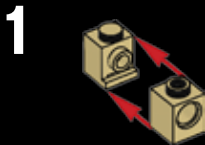

The new east wing meant that the Marble Arch monument, originally the entrance to the palace, had to be moved.



5

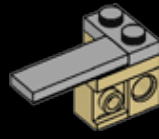

7

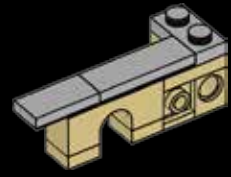

1



2

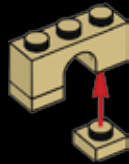

6

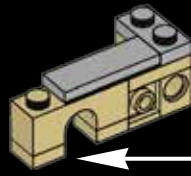

8

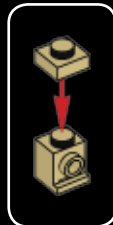
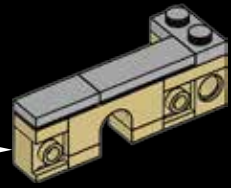

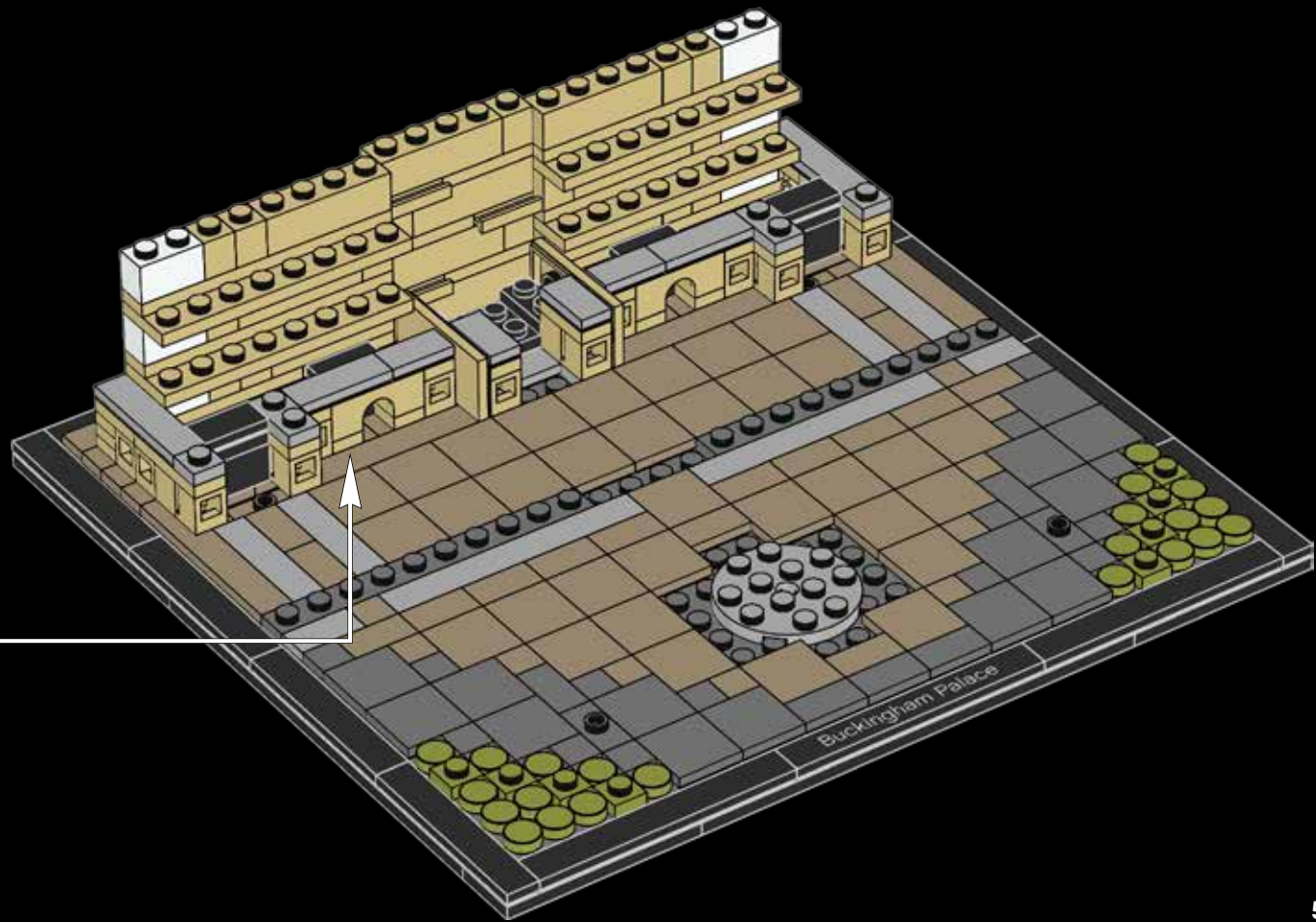

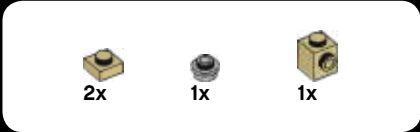

1

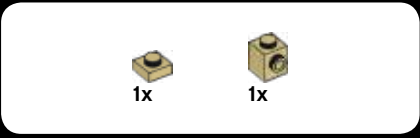
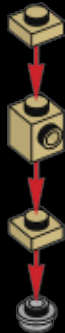

2





8x



6x



8x

3

1



2



3



4

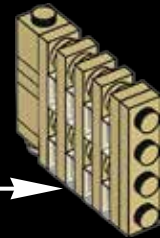
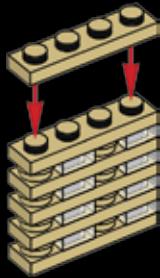

2x

37

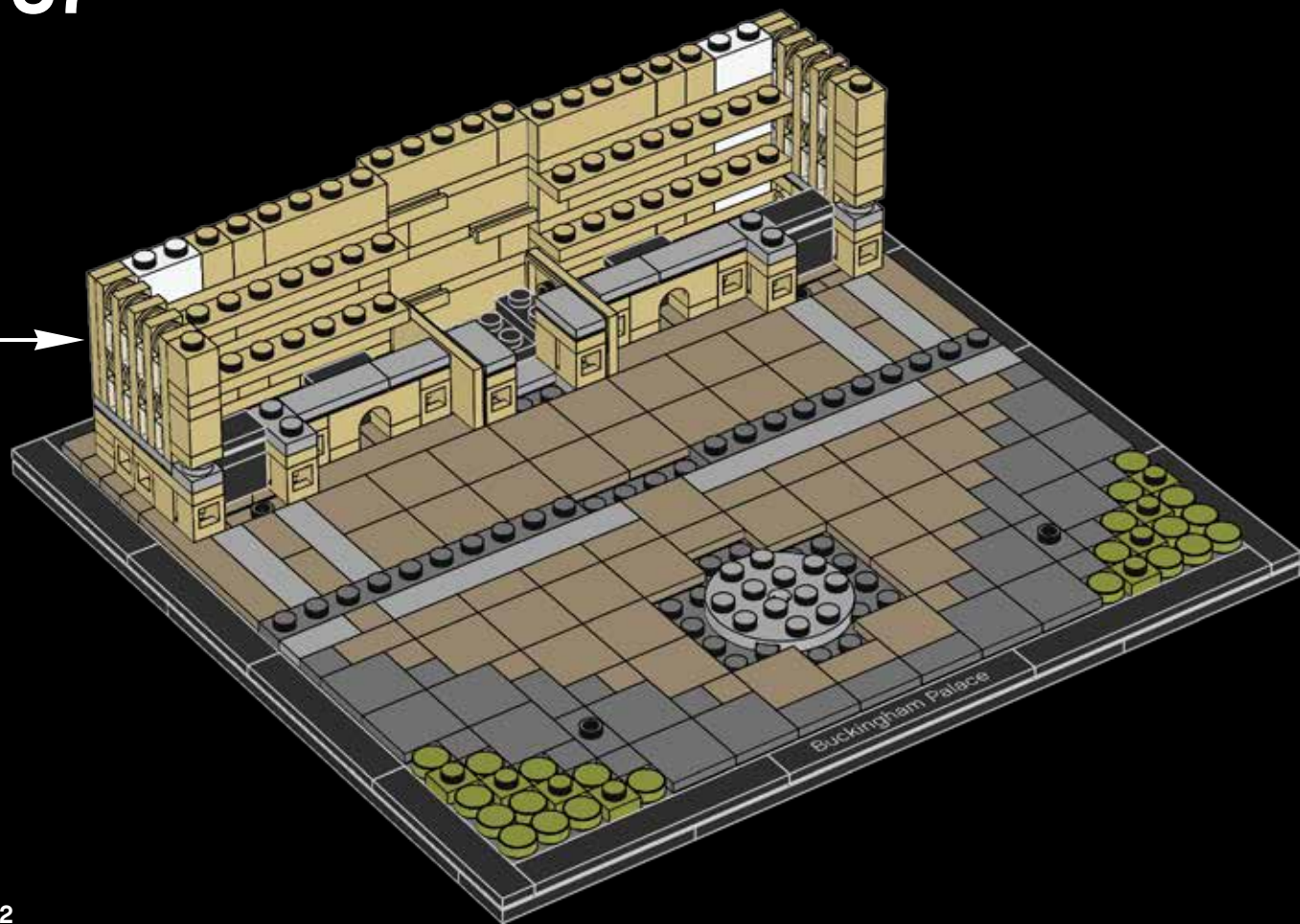



3x



1x

1



1x



1x

2



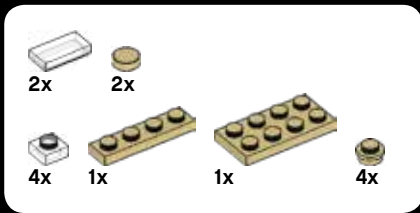

3

1



3



2

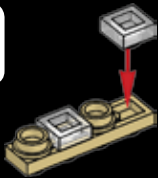

4

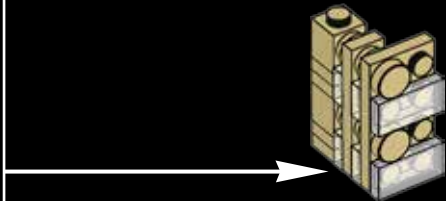
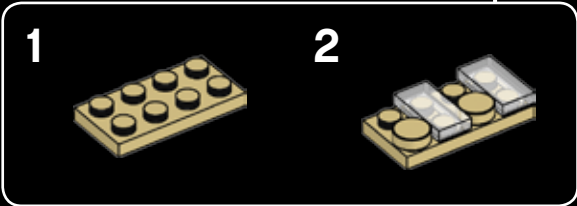
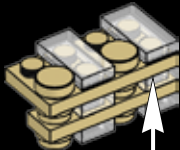

39

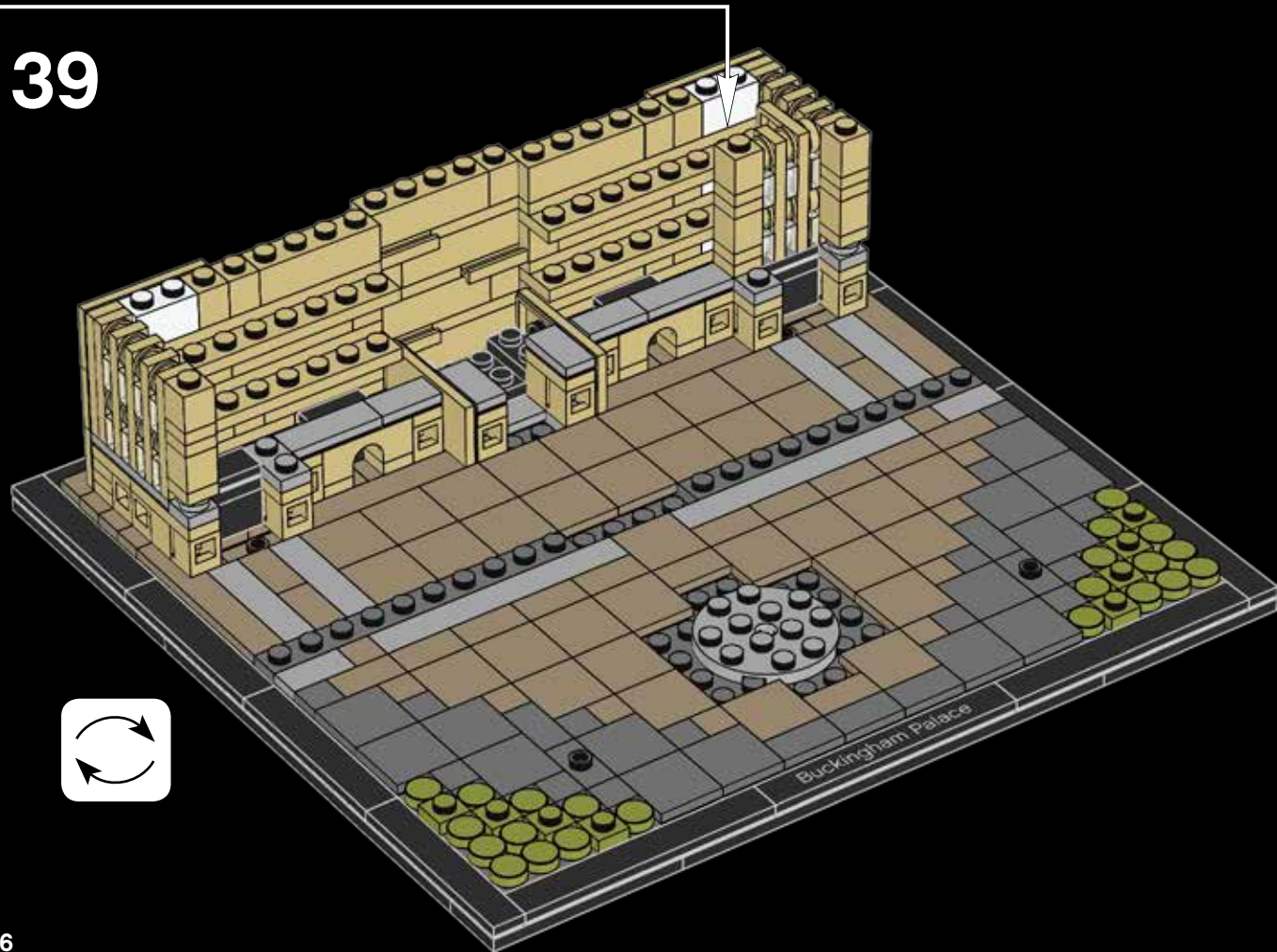



1



2



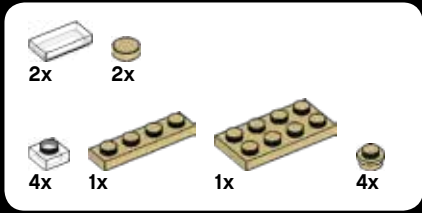

3

1



3

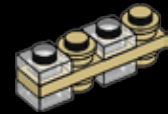

2

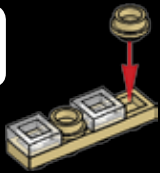

4

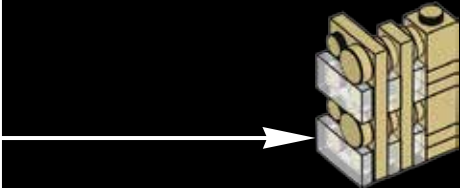
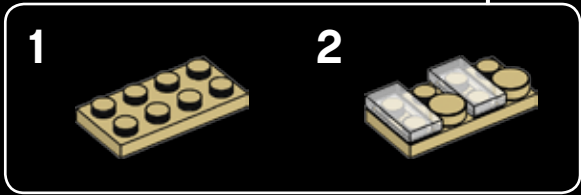
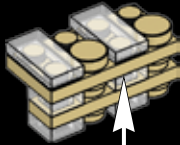

40

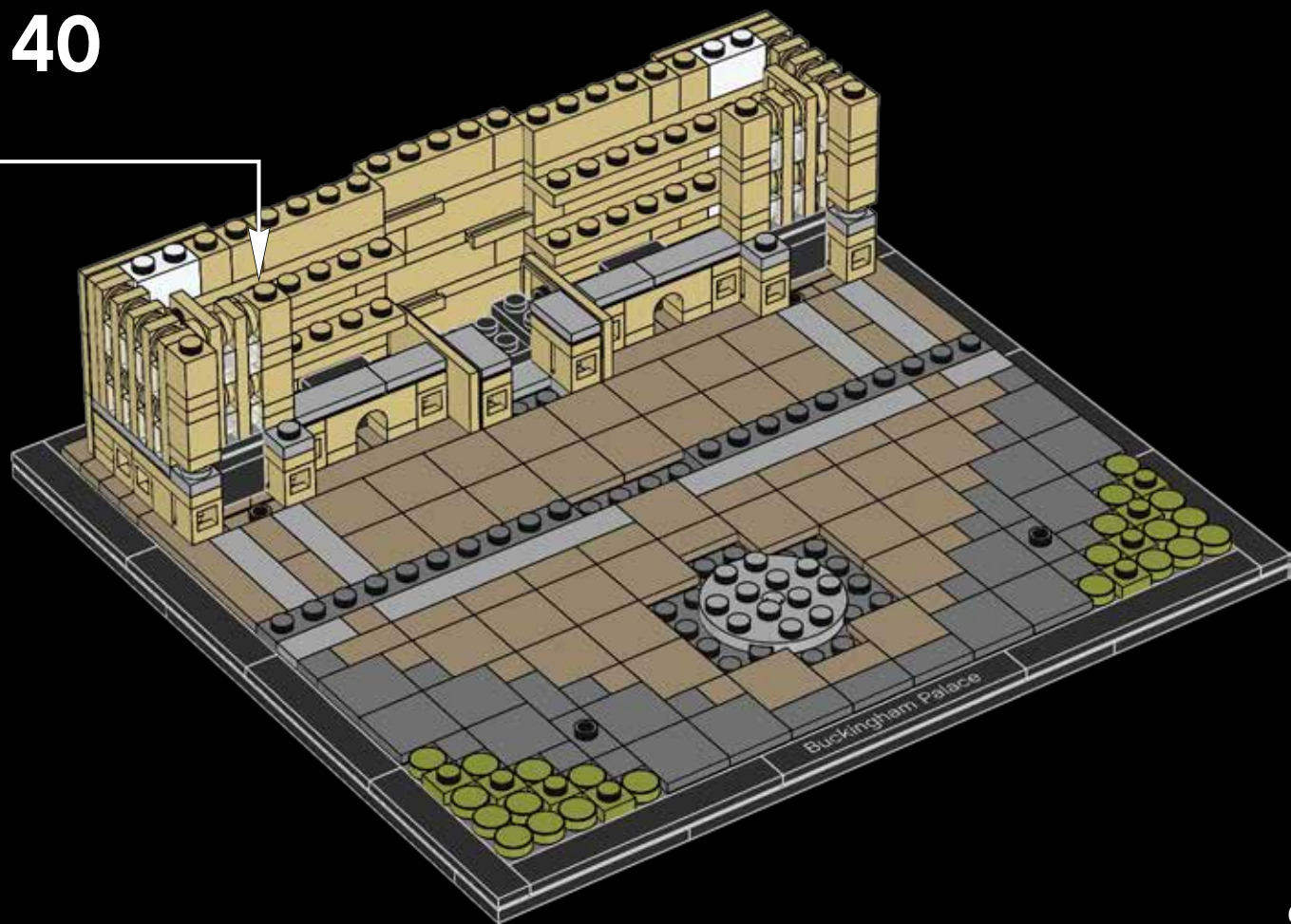



3x

41

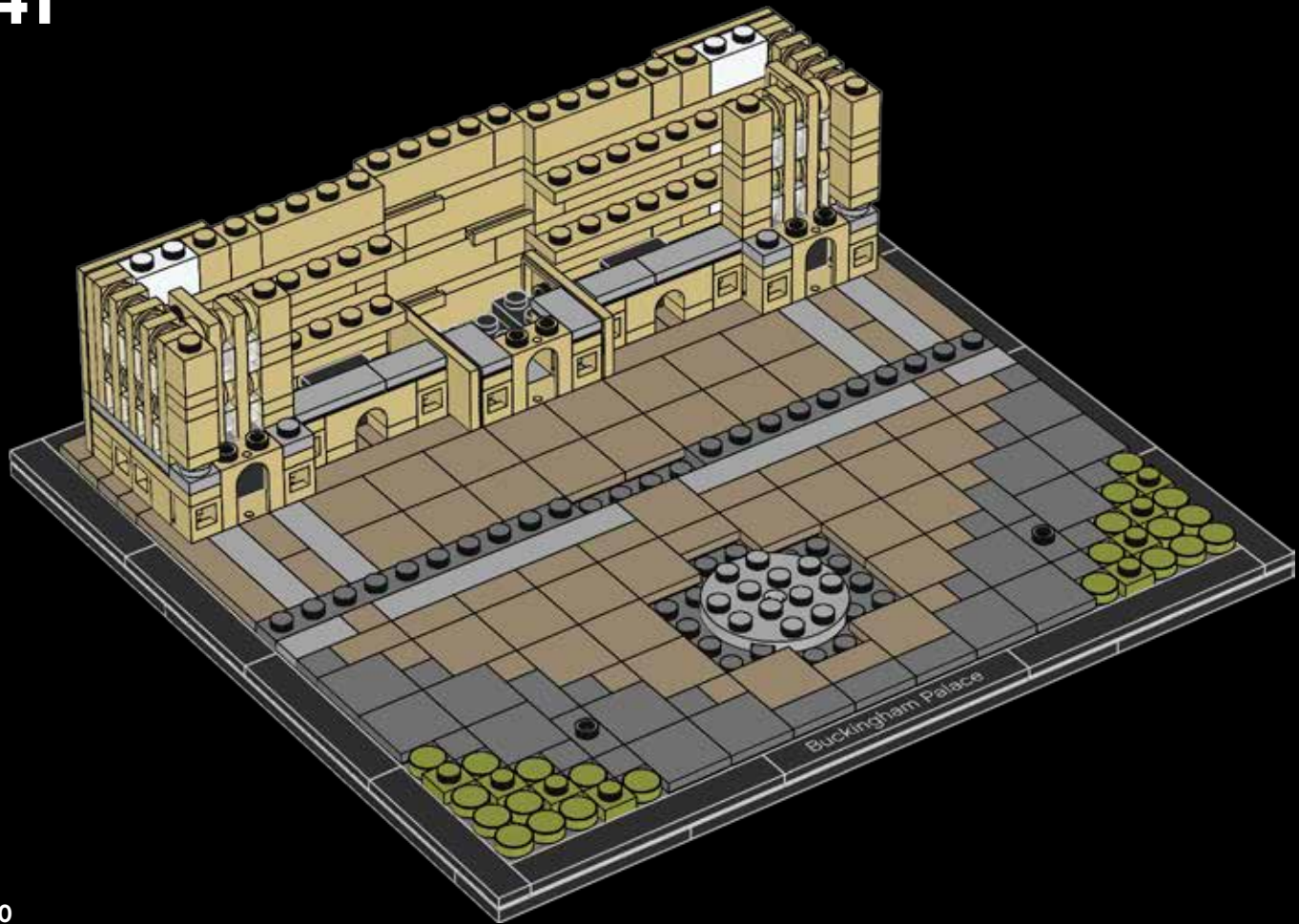

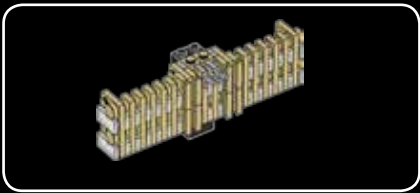

1x



1x

1

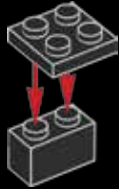

1x

2



1x

3

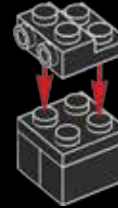

1x

4

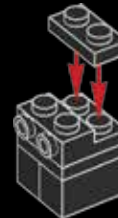



1x

5



2x

6



1x

7



1x

8





1x

9



2x

10



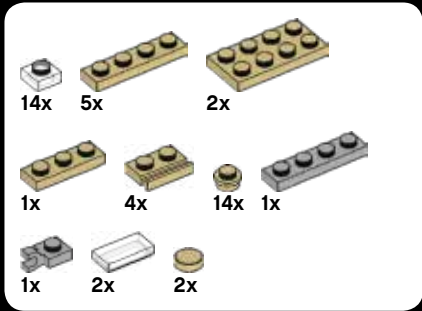

11

1



2

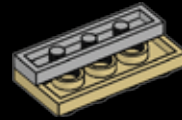

3

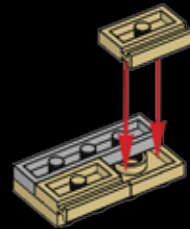

4

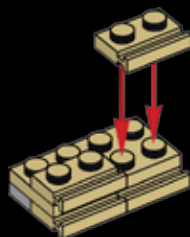

5

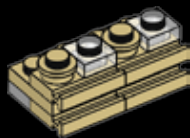

6

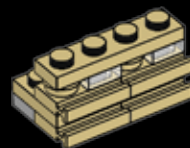

7



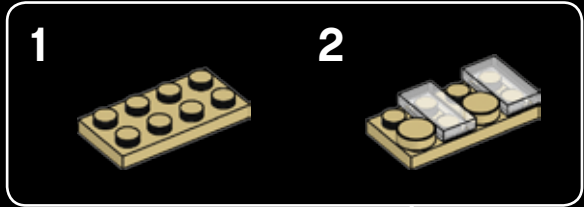

8



9

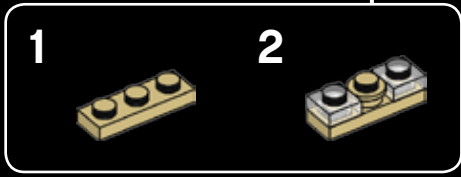
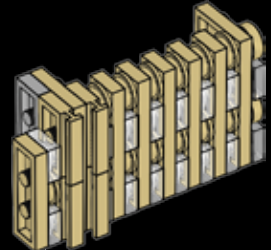

10

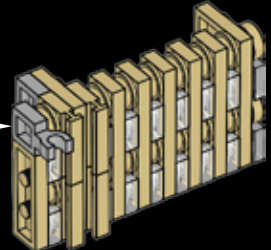
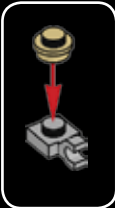

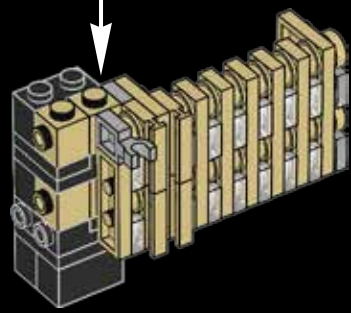

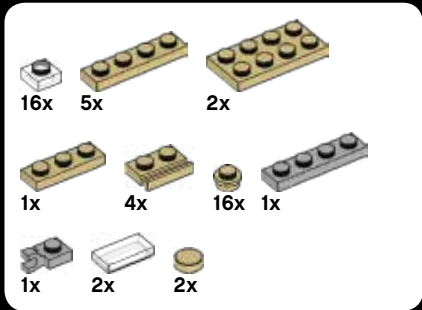

12

1



2

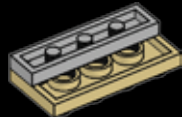

3

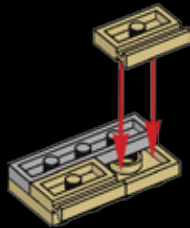

4

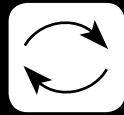
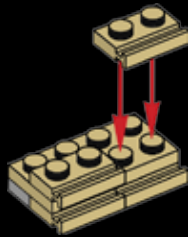

6

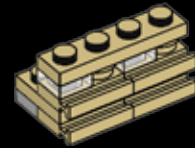

5

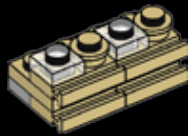

7



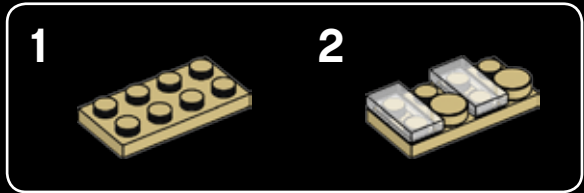

8

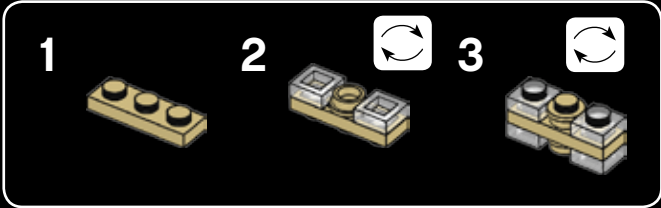

9

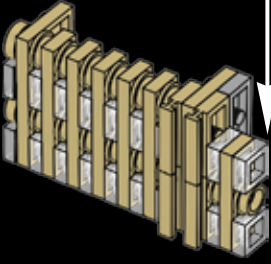

There are 1,514 doors
and 760 windows in
Buckingham Palace.



10

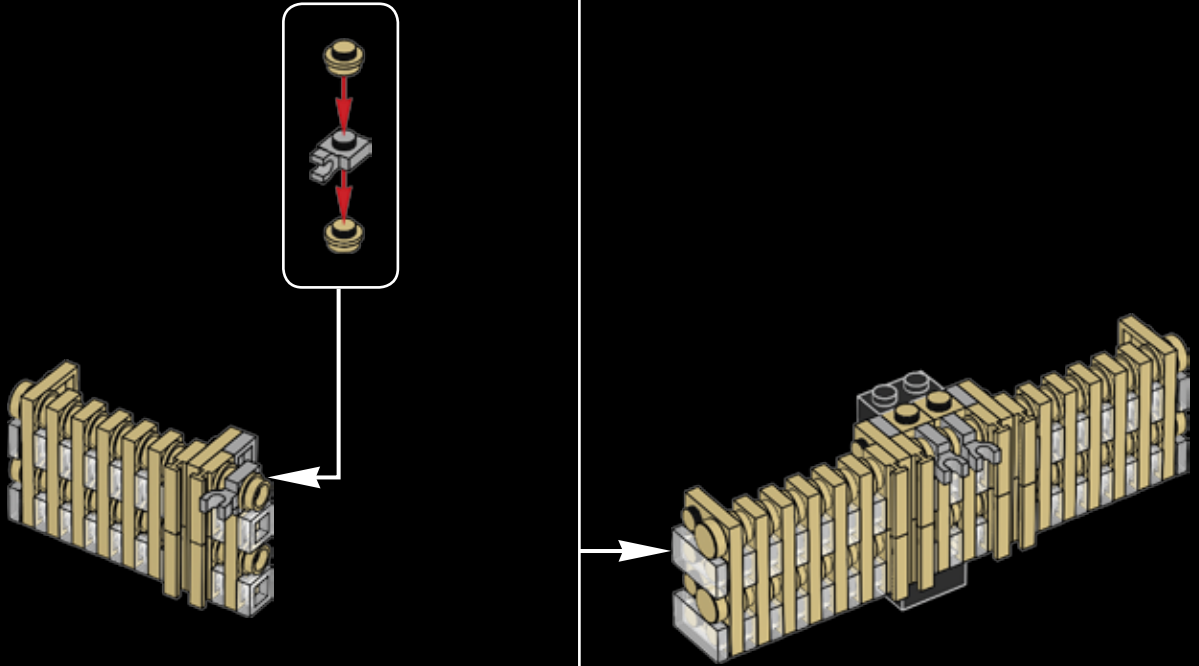

42

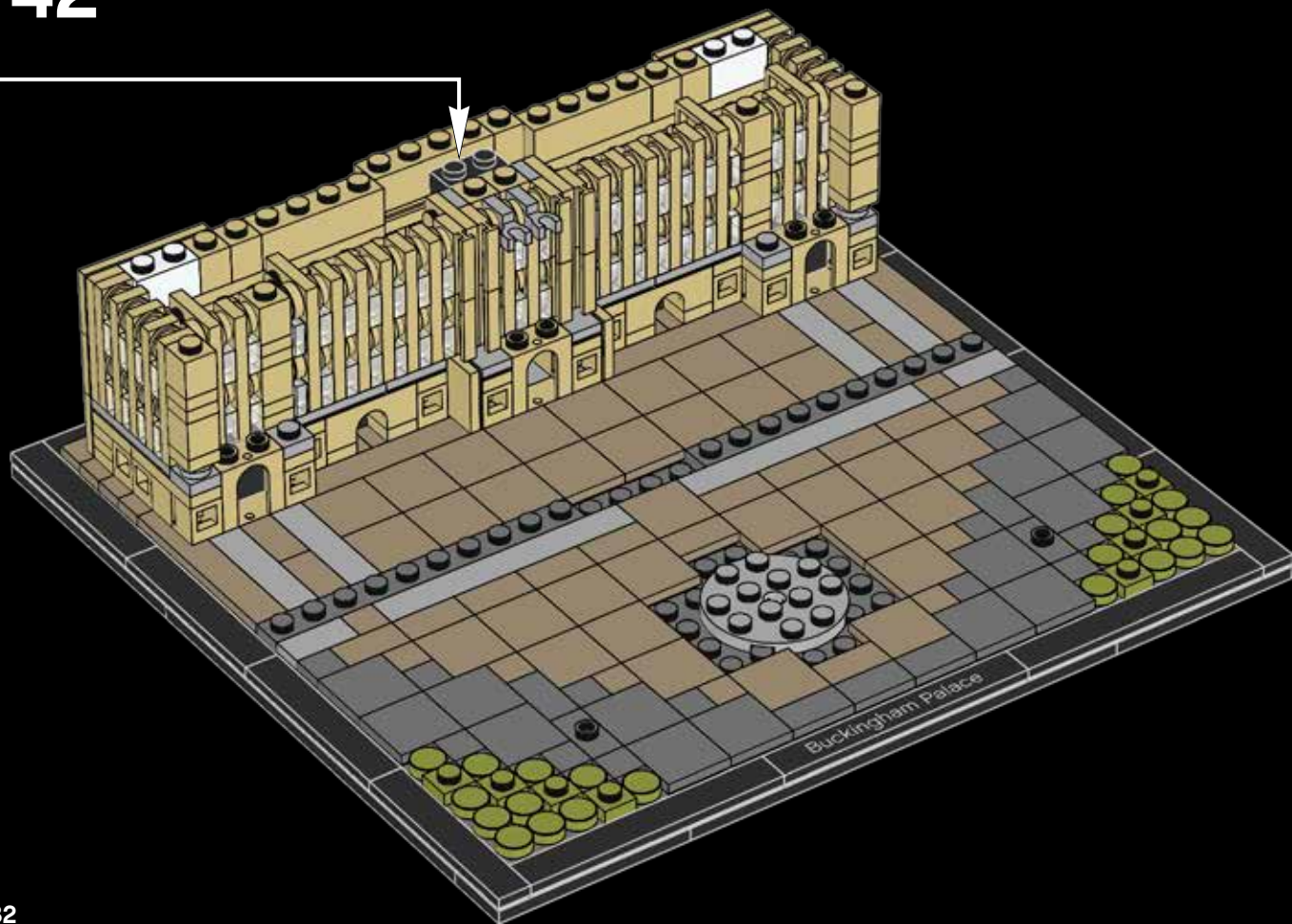



6x

43

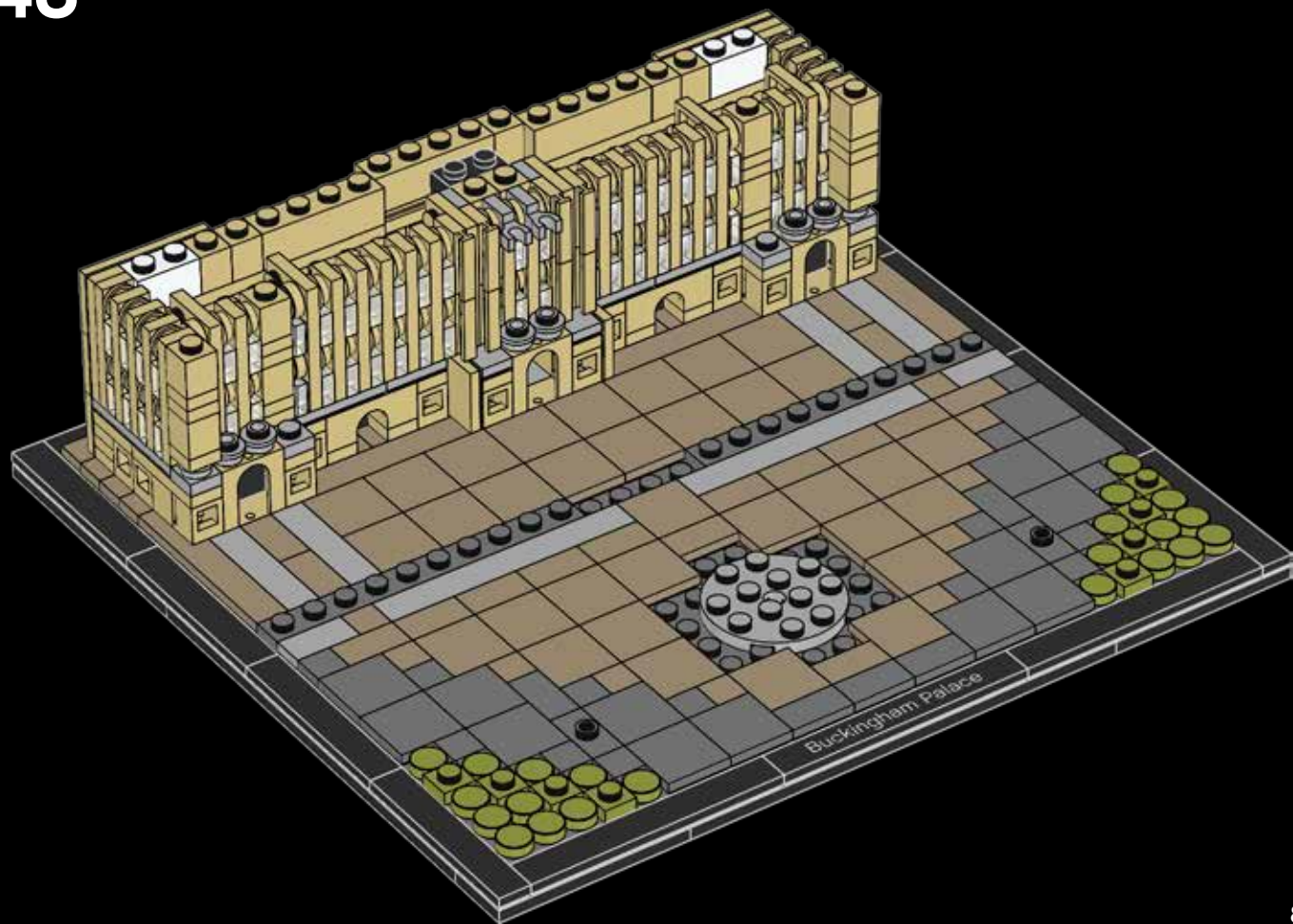

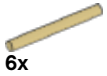

6x

44

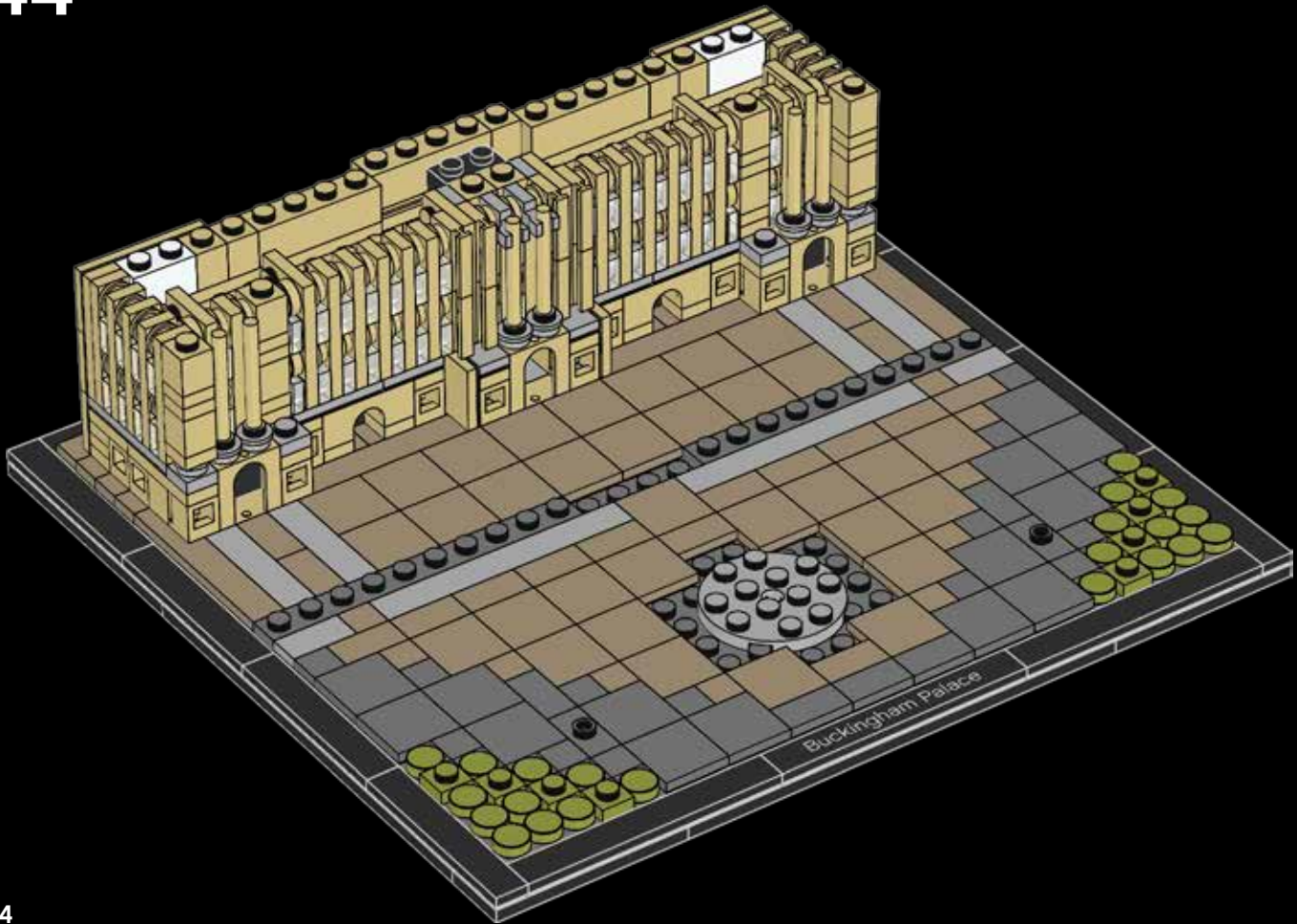

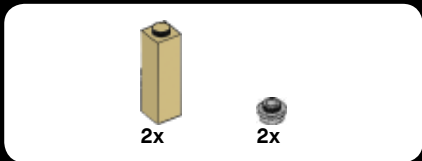

45

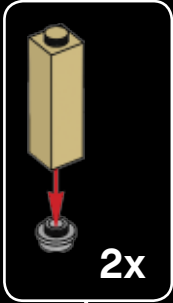
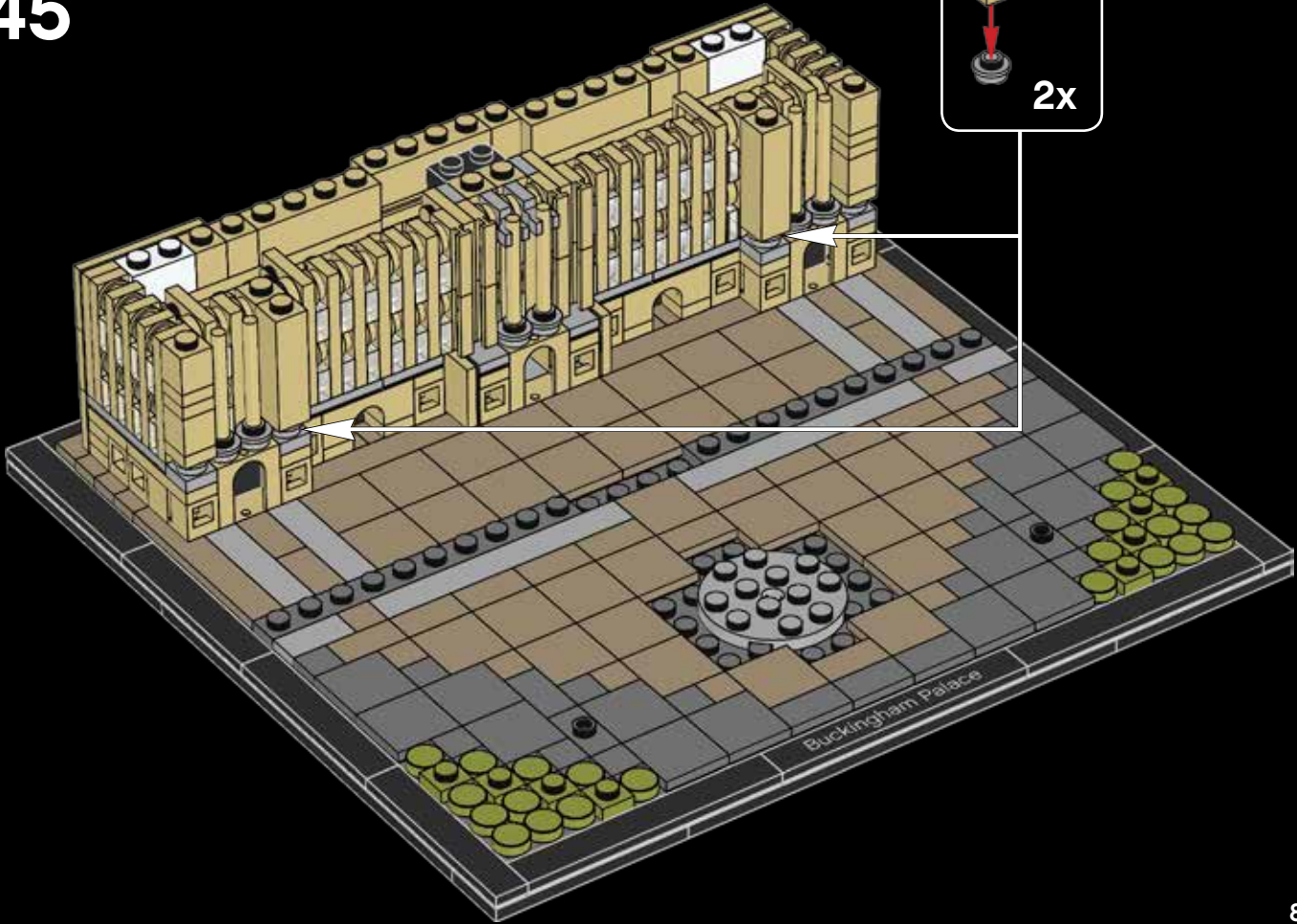

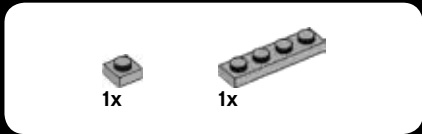

1

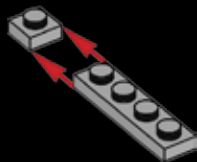

2

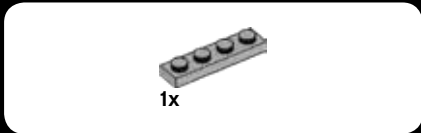

3

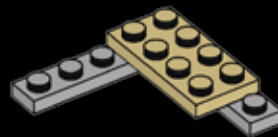

4





1x



1x

5

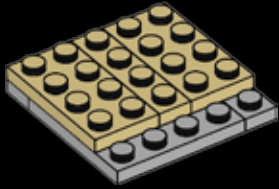

1x



1x

6

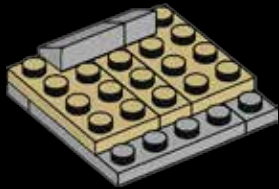

1x

7



2x



1x

8

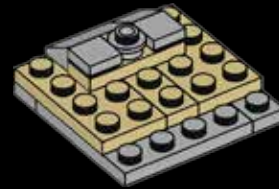



1x



1x

9

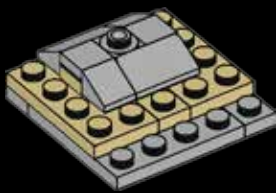

4x



2x



2x

10

1

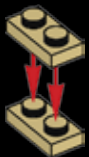

2



2x

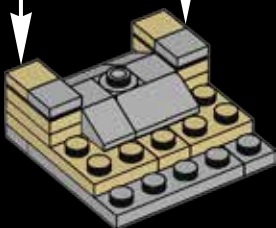

1x

11

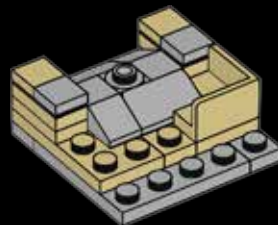



1x

12

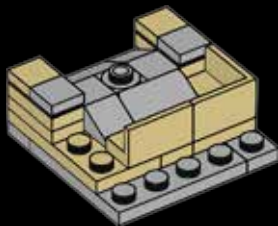

2x

13

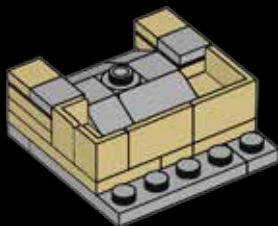

4x

14

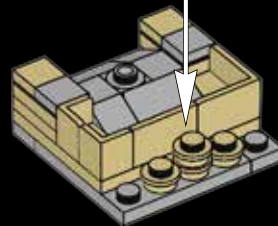

5x

15

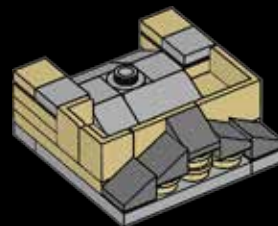

46

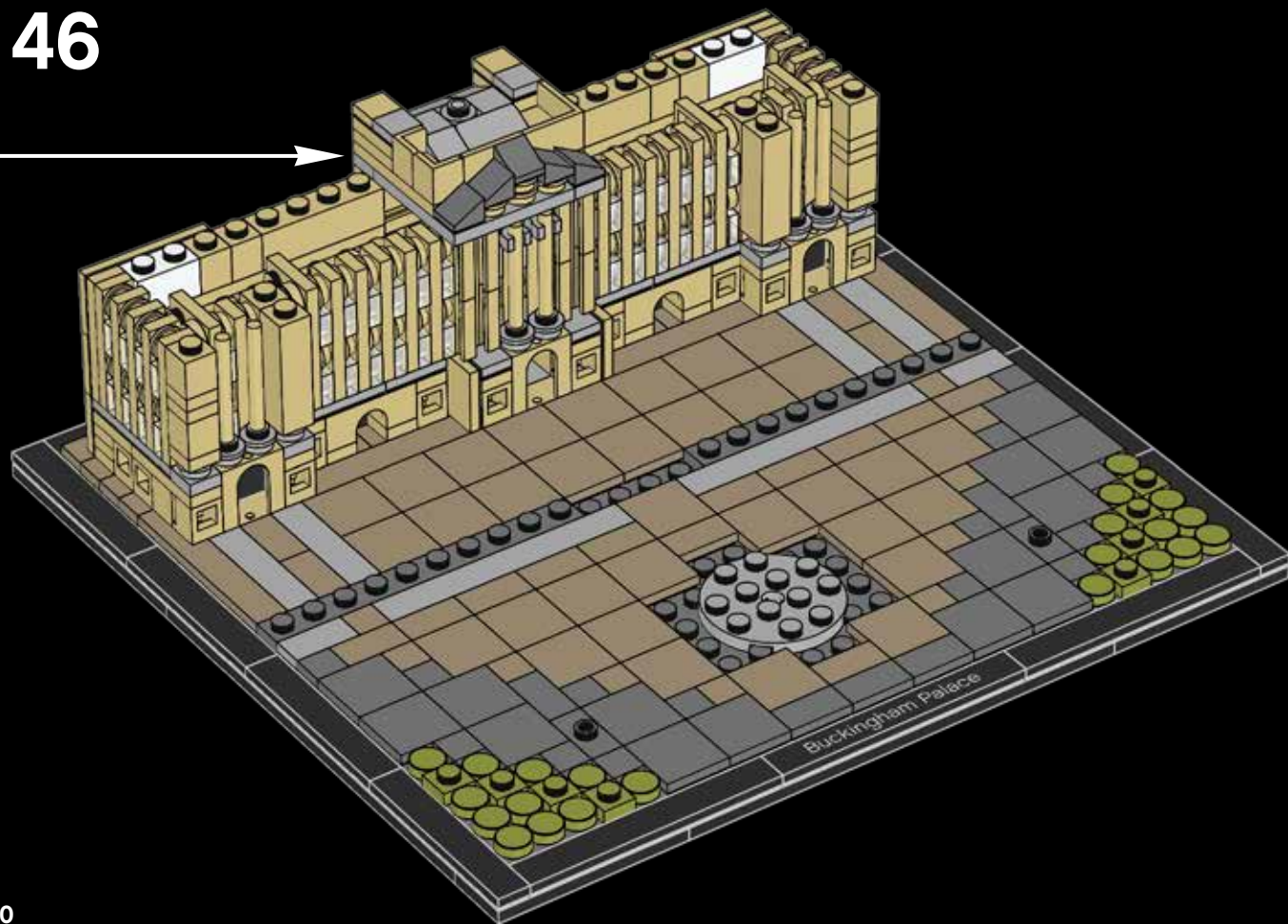

Buckingham Palace has its own chapel, post office, swimming pool and cinema.

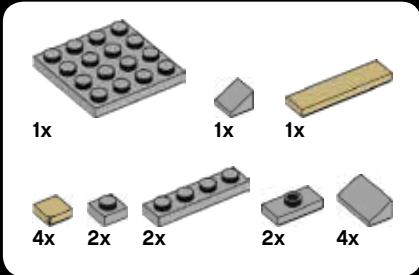

47

1

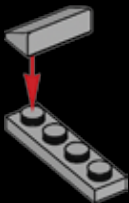

2



3



4



5



6

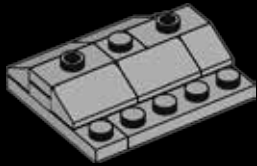

7

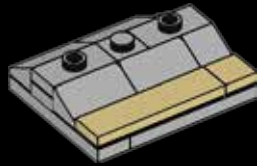

8

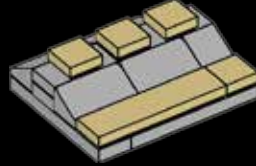

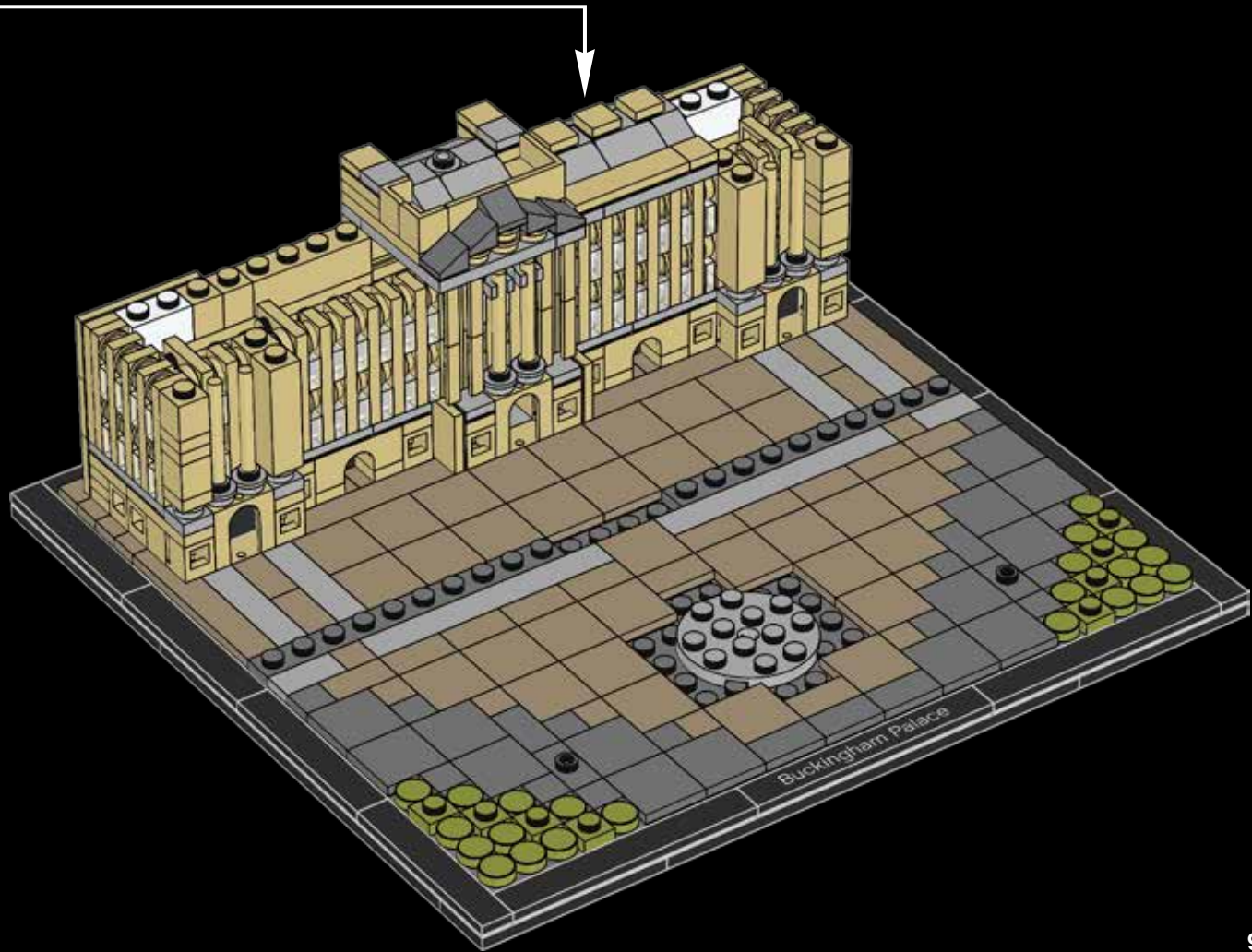

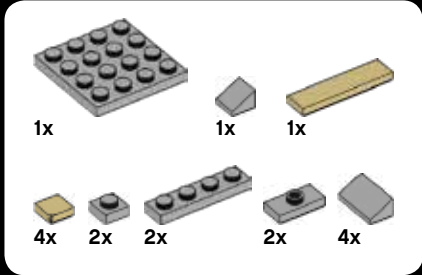

48

1

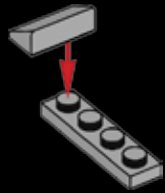

2



3



4



5



6



7

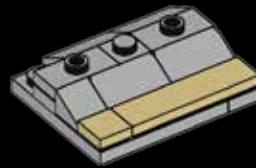

8

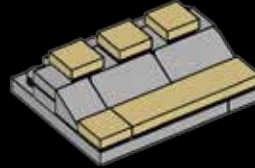

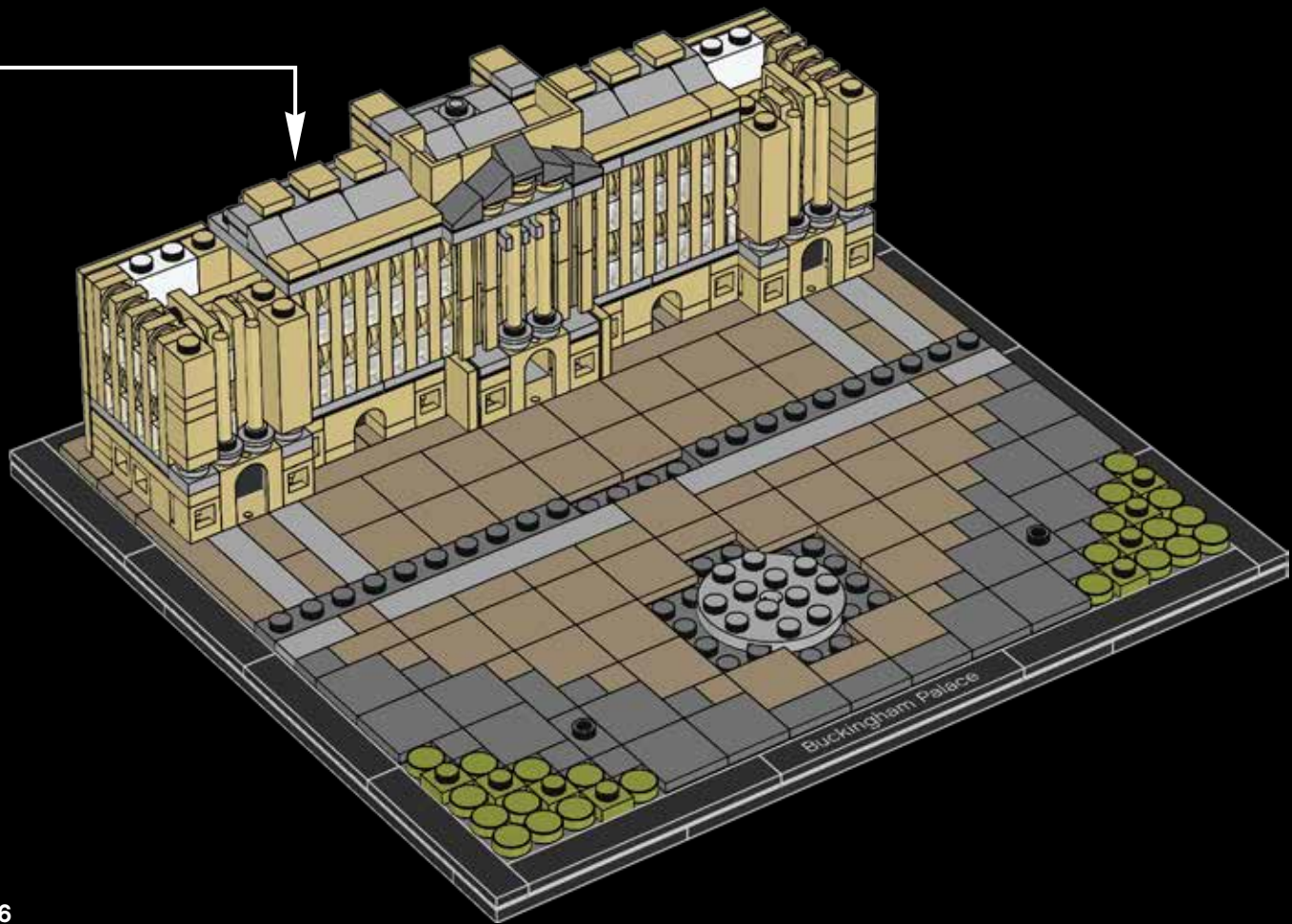

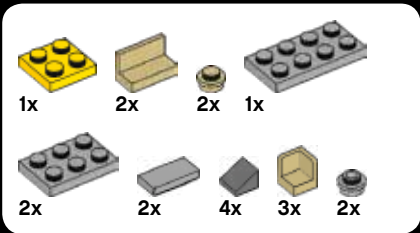

49

1



2



3



4

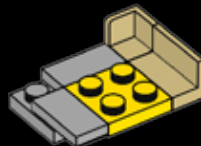

5



6



7



8

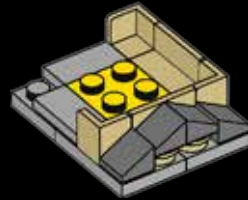

9

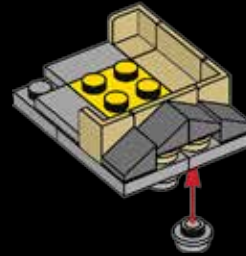

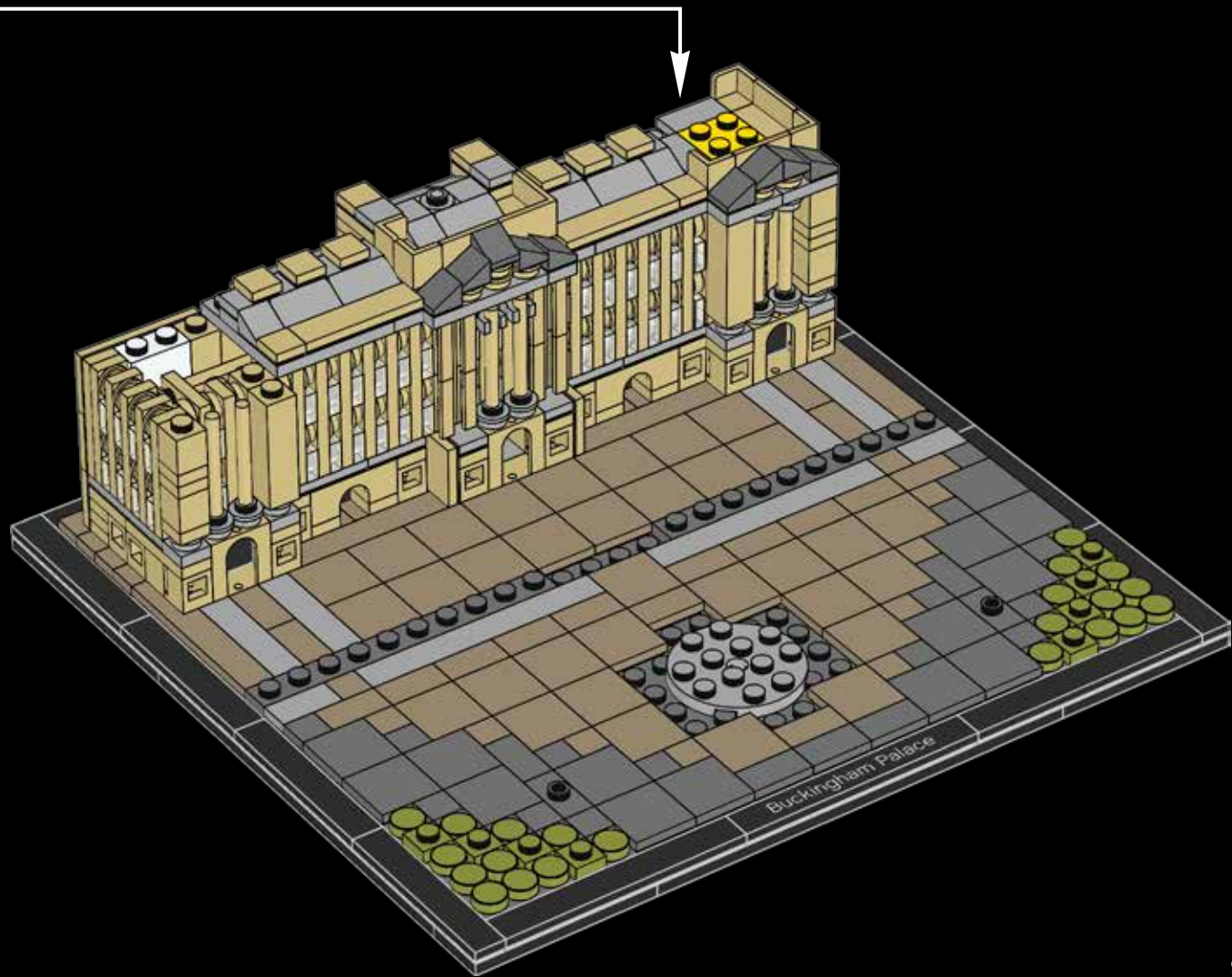

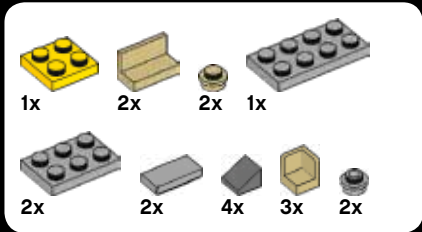

50

1



2



3



4



5



6

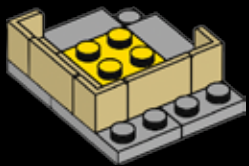

7

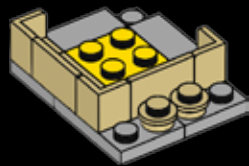

8



9

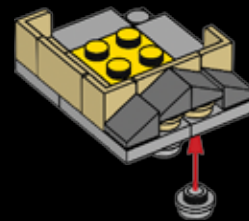





2x



2x



2x

51

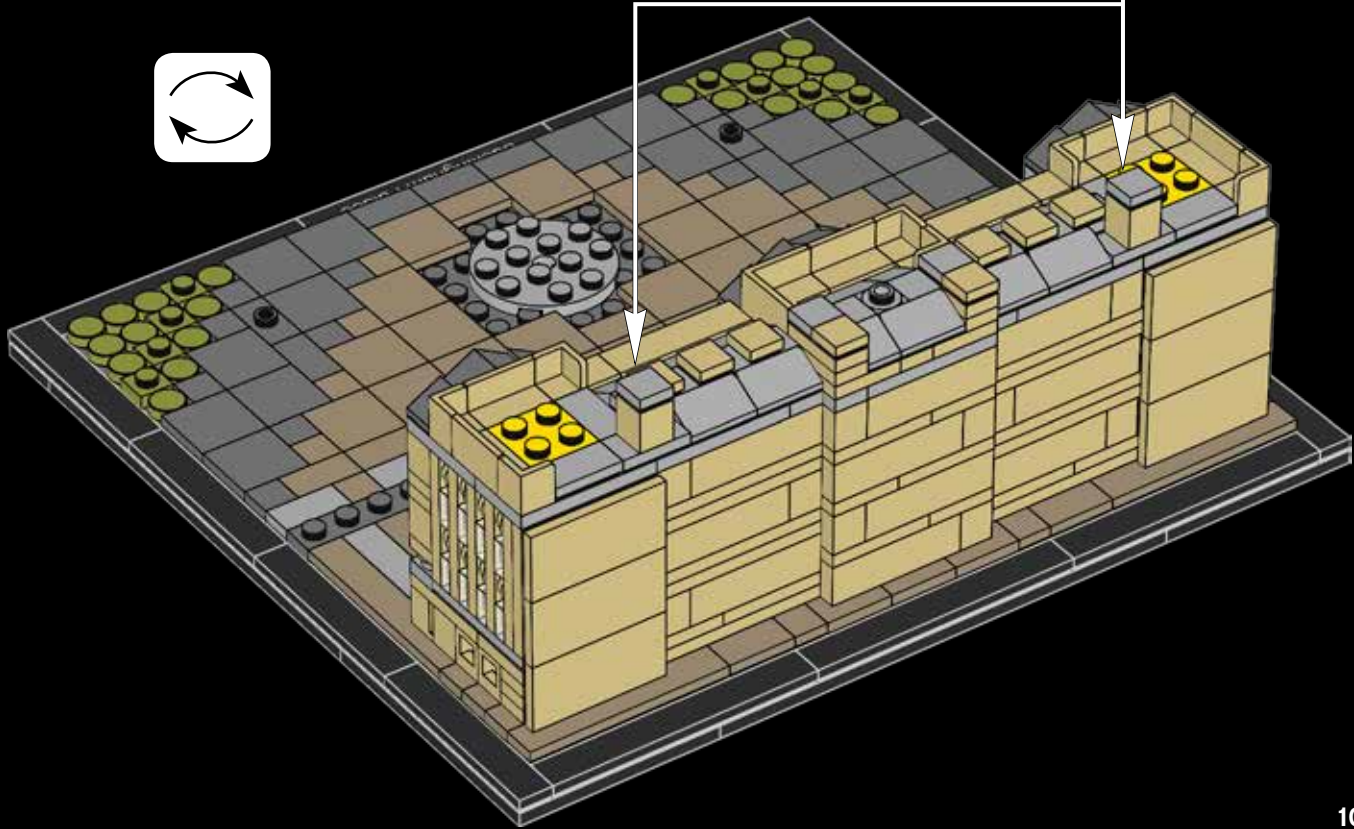
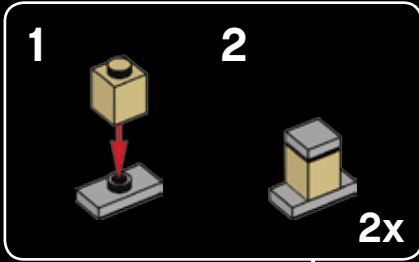



2x



2x



2x



4x



2x



4x



2x

52

1



2



3



4



5



2x

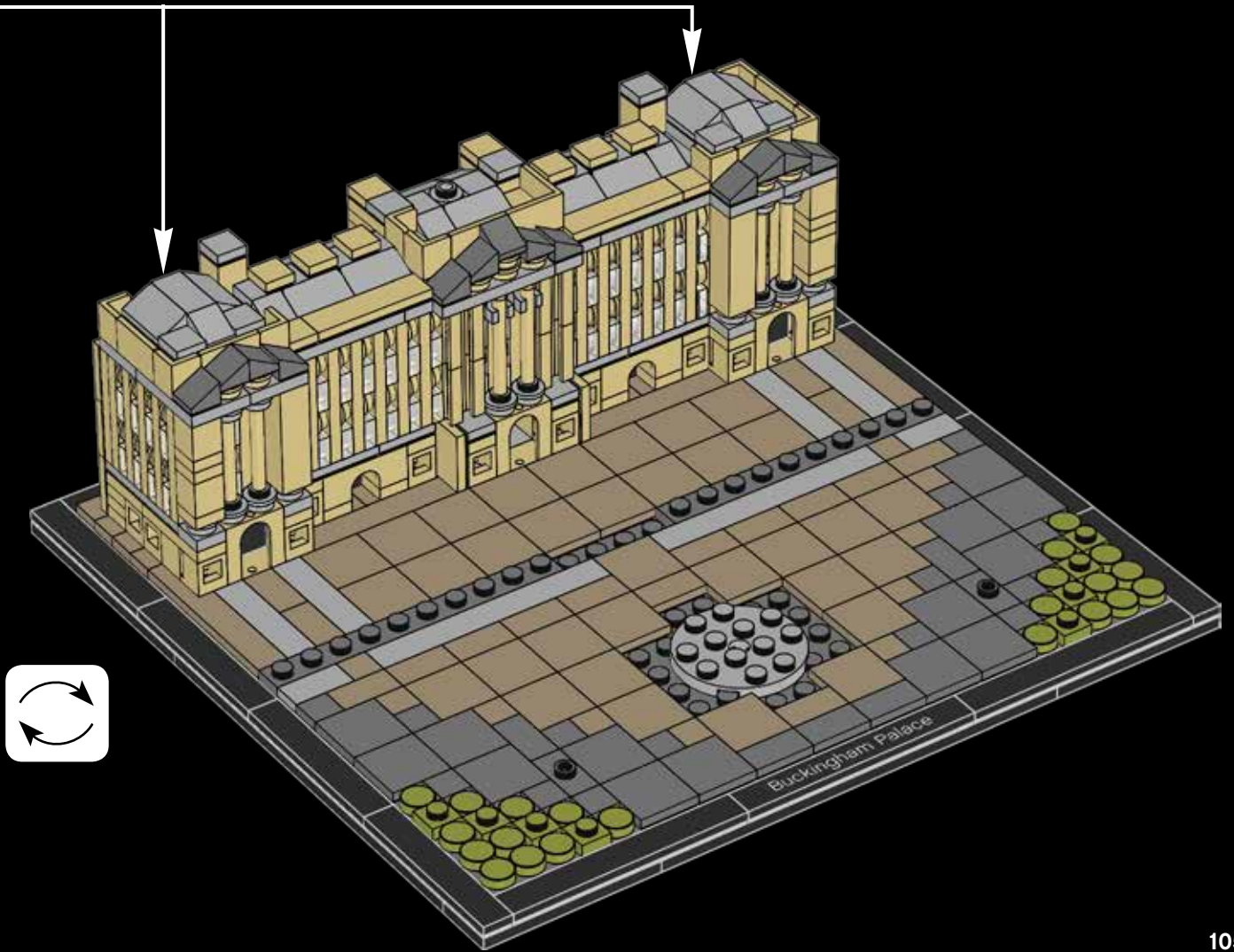



4x

53





4x



2x



2x

54

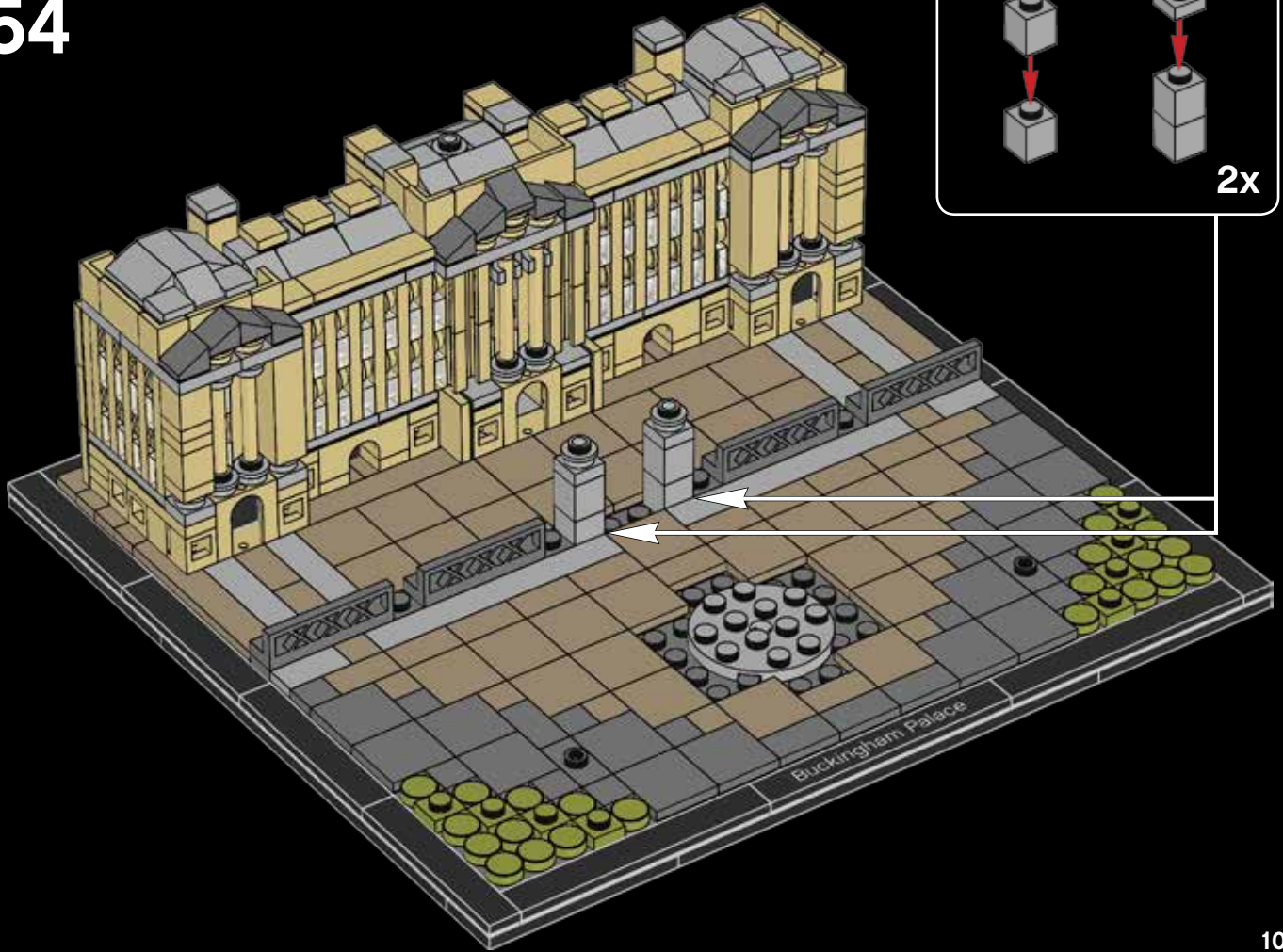

1



2



2x



1x



1x

55





4x



4x



4x

56

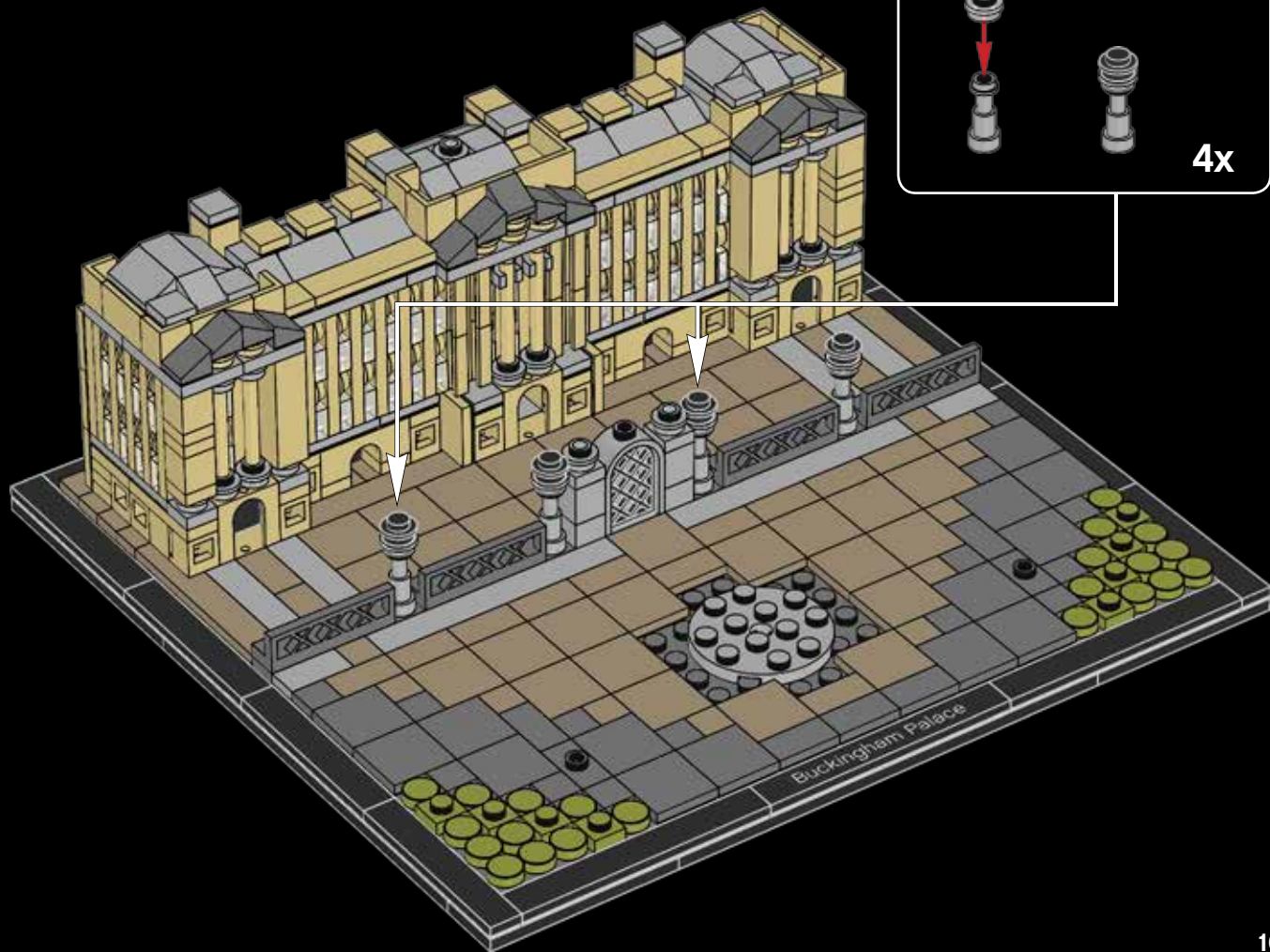

1



2



4x



2x



2x



2x

57

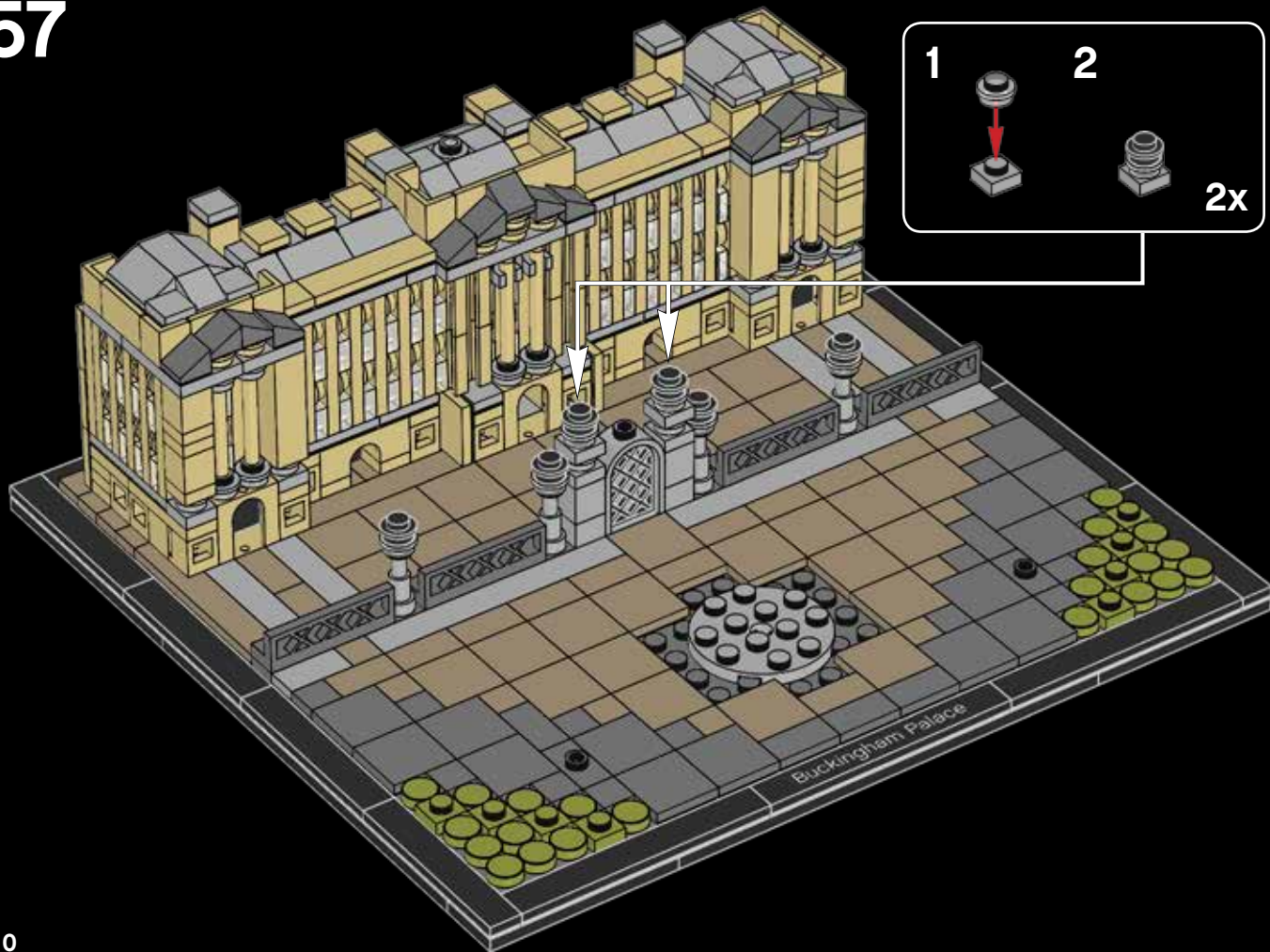

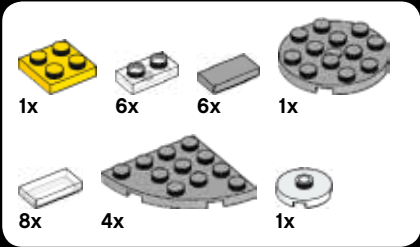

58

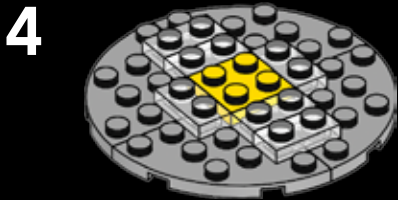
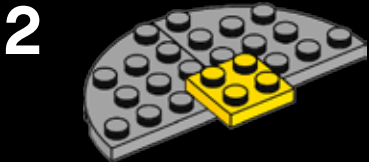
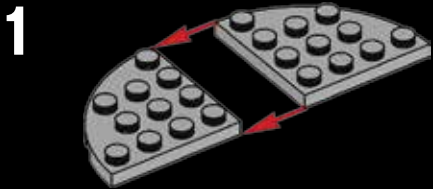

5



7



6



8





Buckingham Palace

- 
2x
- 
1x
- 
1x
- 
4x

59

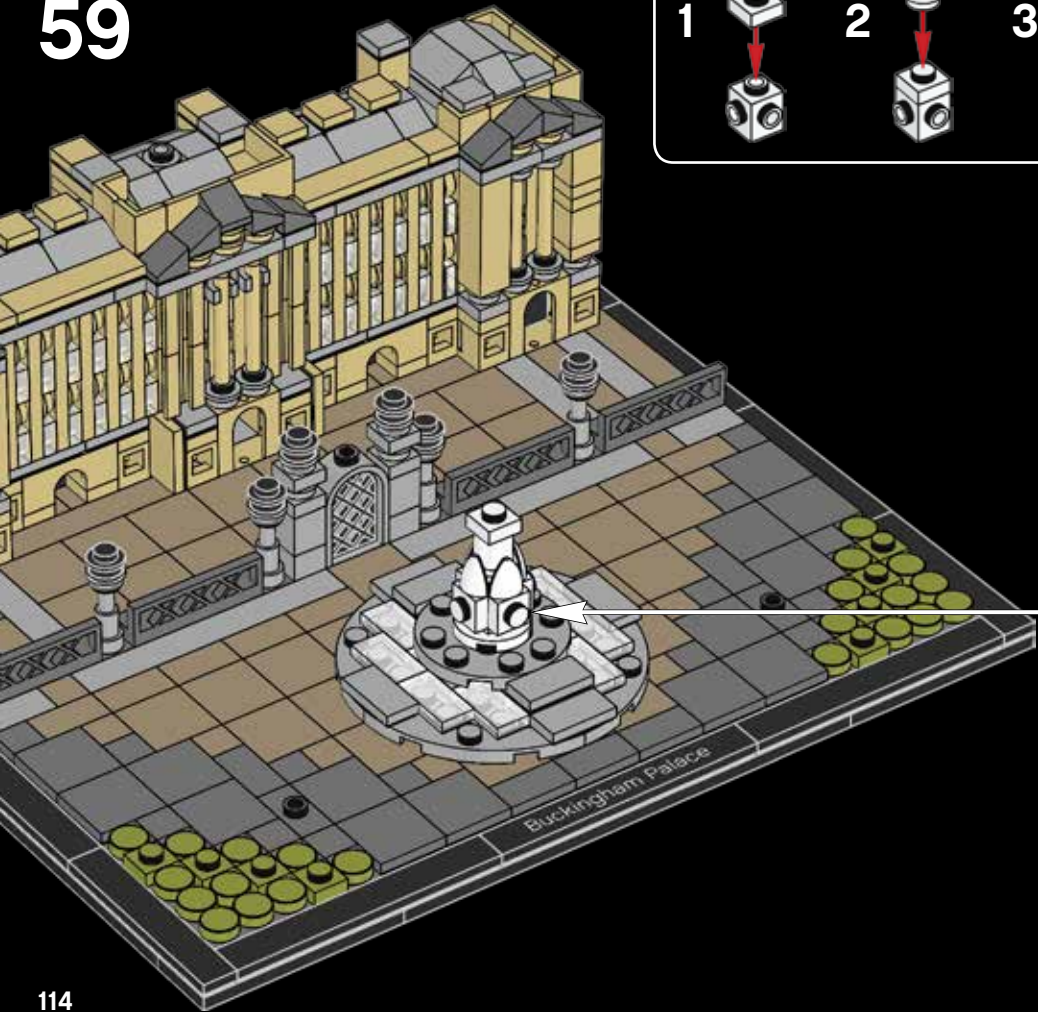
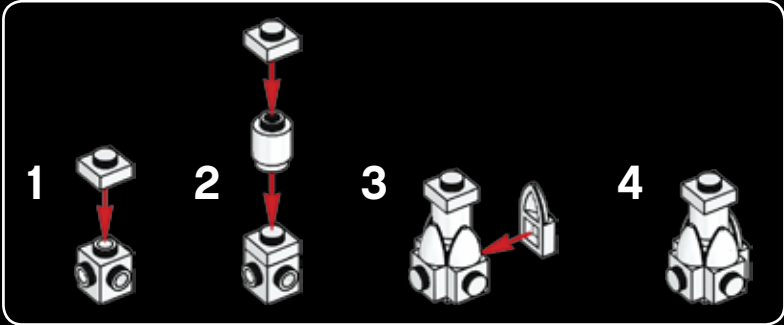

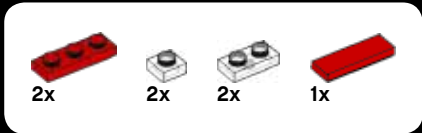

60

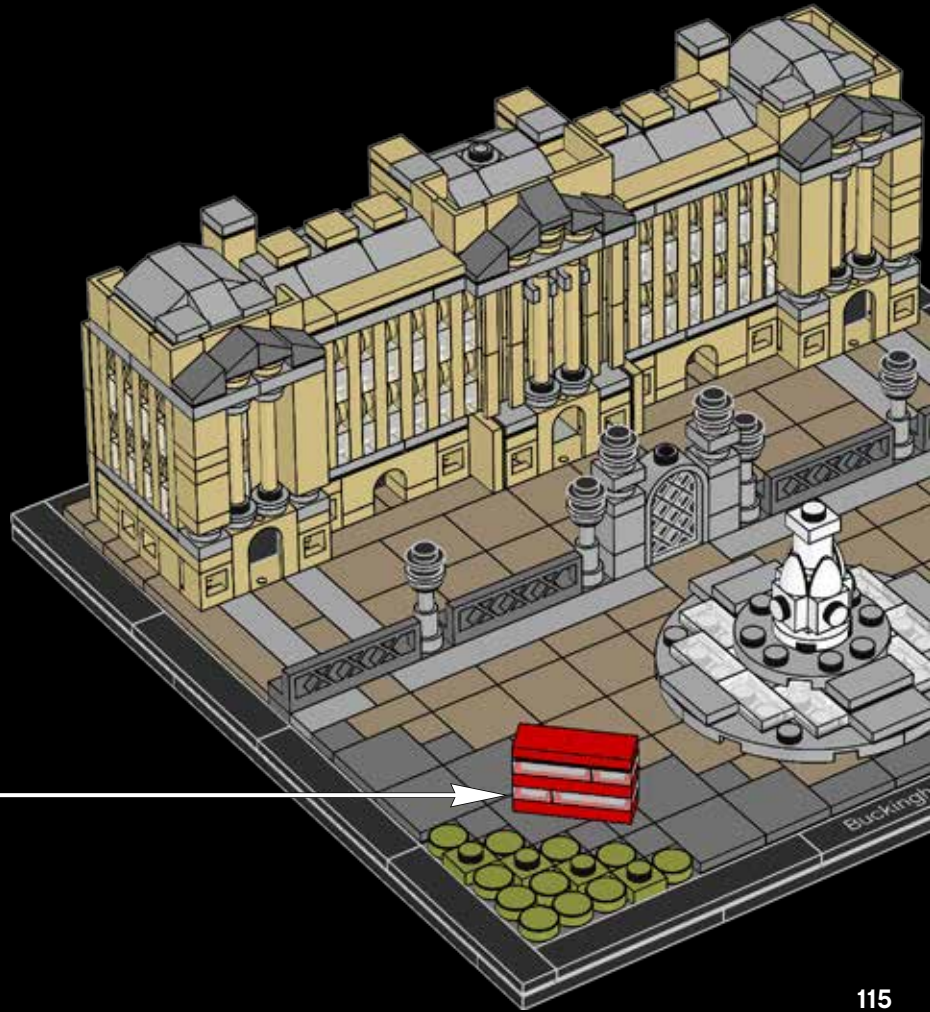
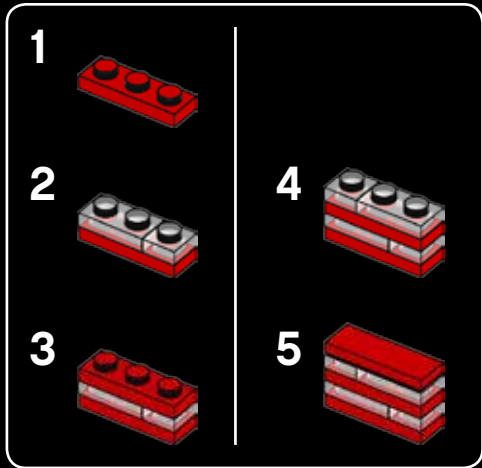



1x



2x



1x

1



2



3



61

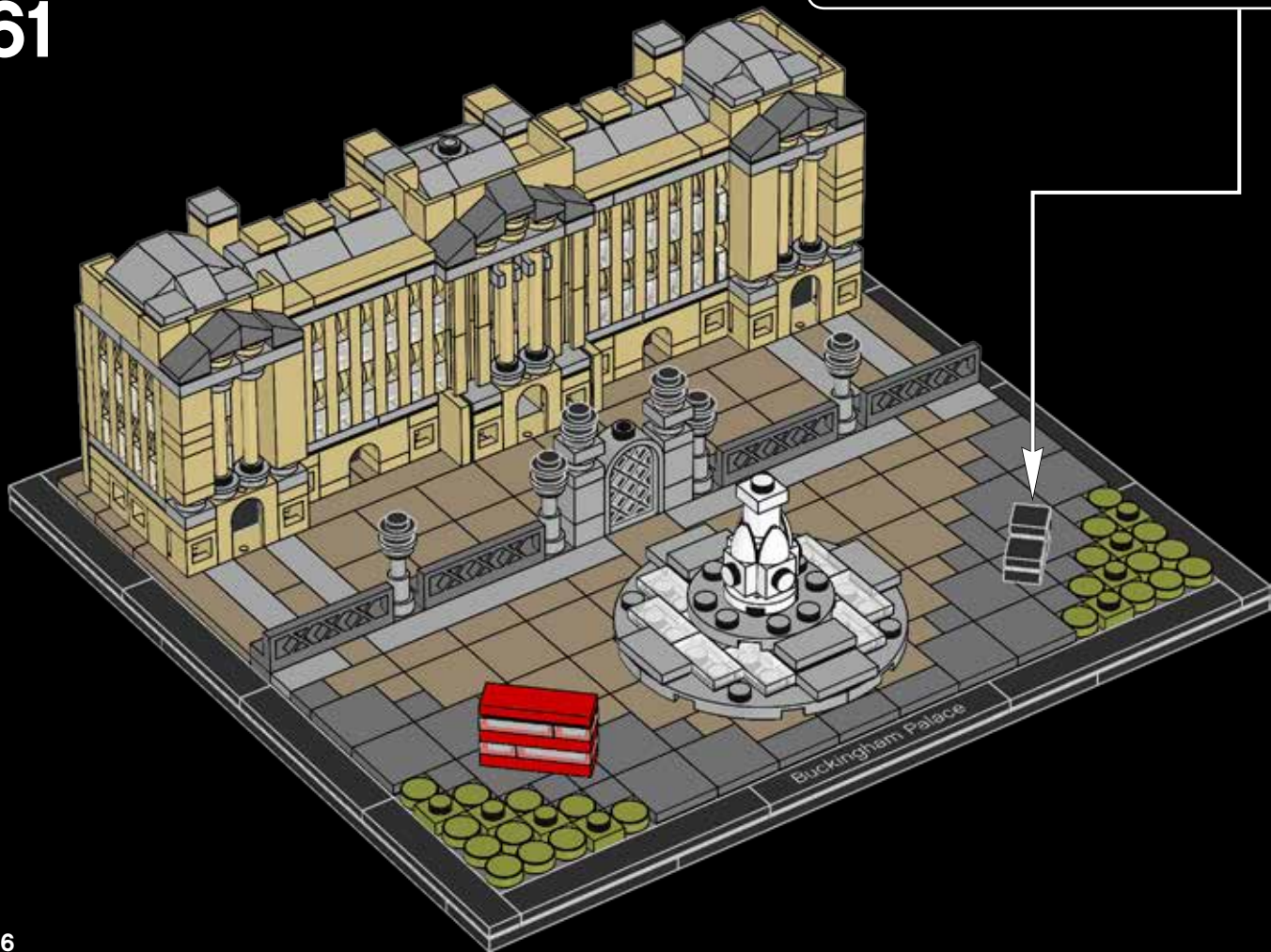

Buckingham Palace



62

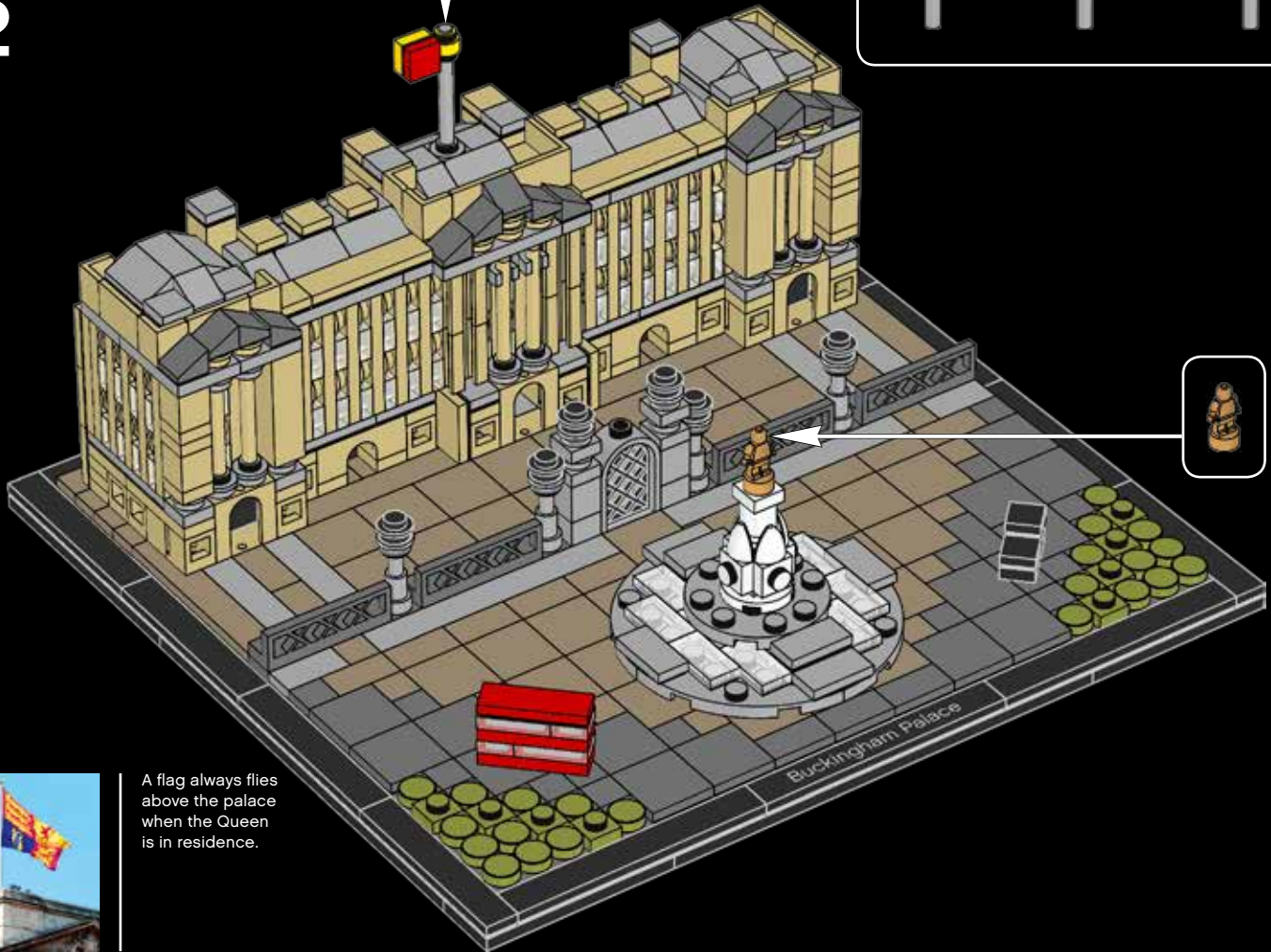
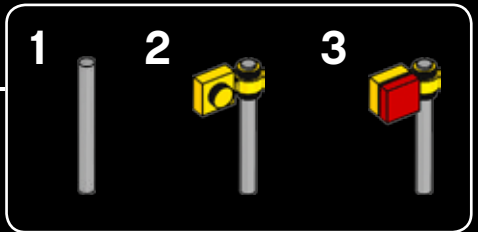

A flag always flies above the palace when the Queen is in residence.

LEGO® Architecture—then and now

There has always been a natural connection between the LEGO® brick and the world of architecture. Fans who build with LEGO elements instinctively develop an interest in the form and function of the structures they create. At the same time, many architects have discovered that LEGO bricks are the perfect way of physically expressing their creative ideas.

This connection was confirmed in the early 1960s with the launch of the LEGO 'Scale Model' line. It matched the spirit of the age where modern architects were redefining how houses look and people were taking an active interest in the design of their new homes. These sets were designed to be different from the normal, brightly colored LEGO boxes; they also included a book on architecture as a source of inspiration.

Decades later, architect and LEGO fan Adam Reed Tucker, revived the idea of expressing architecture using LEGO bricks and in partnership with the LEGO Group, launched the LEGO Architecture line that we know today.

His first models, and the original sets in the current LEGO Architecture series, were interpretations of famous skyscrapers from his hometown of Chicago. Since then LEGO Architecture has developed and evolved, first with well-known buildings from other cities in the United States, and now with iconic structures from Europe, the Middle East and Asia.

The introduction of our LEGO Architecture Studio set echoes the ambitions of the earlier LEGO 'Scale Model' line and widens the potential of the LEGO Architecture series. Now you can enjoy building and learning about specific landmark buildings, or create exciting architectural models from your own fantasy. An inspiring 270-page book, featuring a number of renowned architects from around the world, guides you through the principles of architecture and encourages you in your own creative building.



21050
Studio

Celebrate the world of architecture and collect all the models

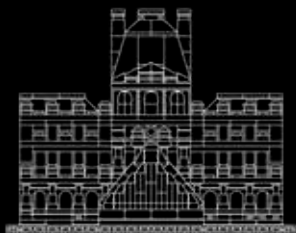

21024
Louvre

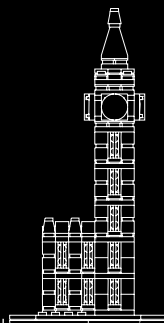

21013
Big Ben

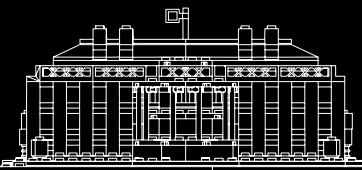

21006
The White House

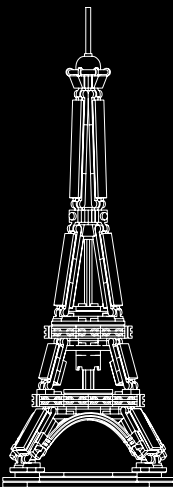

21019
The Eiffel Tower



21020
Trevi Fountain

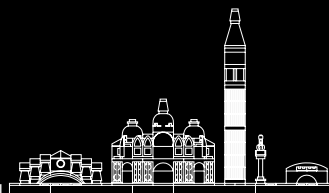

21026
Venice

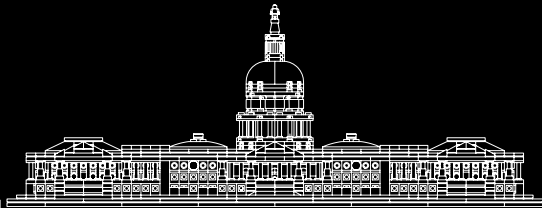

21030
United States Capitol Building

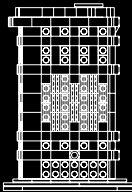

21023
Flatiron Building

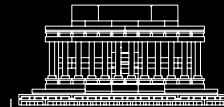

21022
Lincoln Memorial



21027
Berlin



21028
New York City

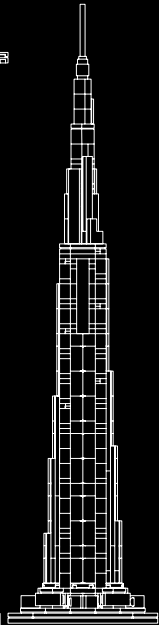

21031
Burj Khalifa

References

Text credits:

www.royalcollection.org.uk

www.royal.gov.uk

Photography:

www.shutterstock.com

Customer Service

Kundenservice

Service Consommateurs

Servicio Al Consumidor

LEGO.com/service or dial



00800 5346 5555 :      

1-800-422-5346 : 