



NEXO KNIGHTS



70323



➔ LEGO.com/hexoknights

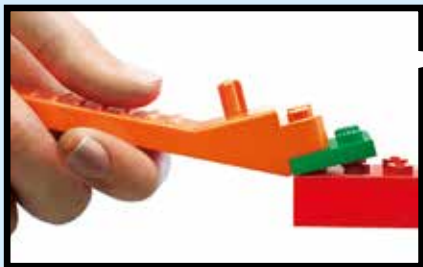
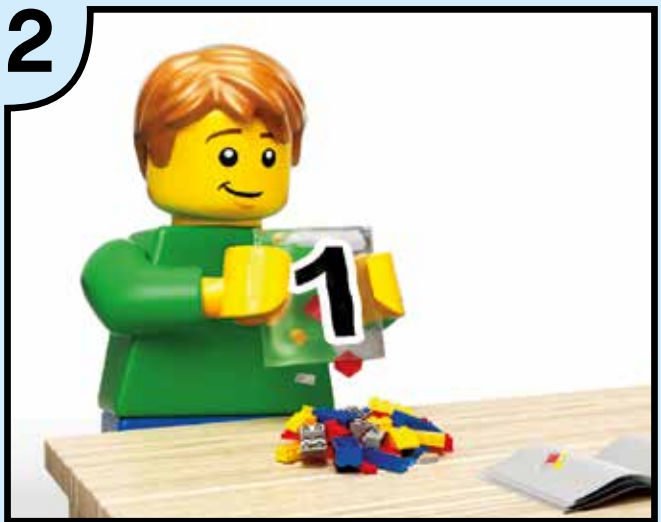

LEGO.com/brickseparator

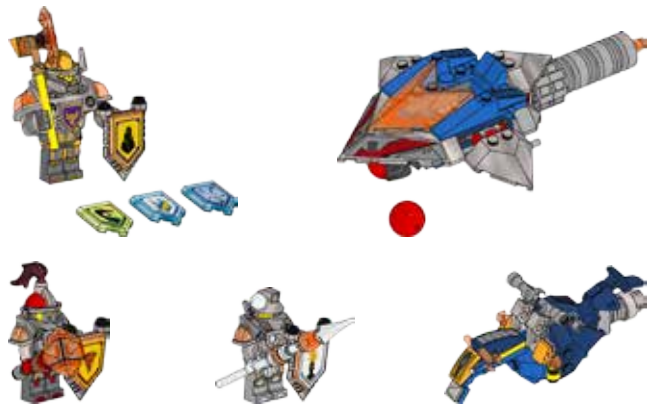

1

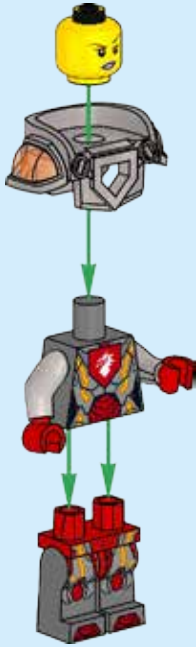

2

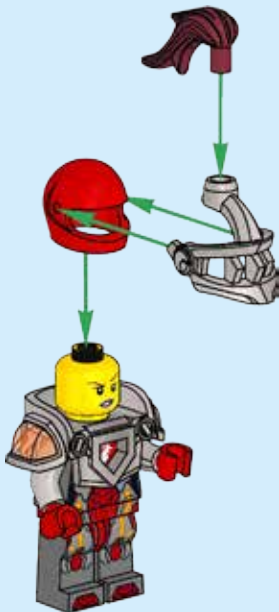

3

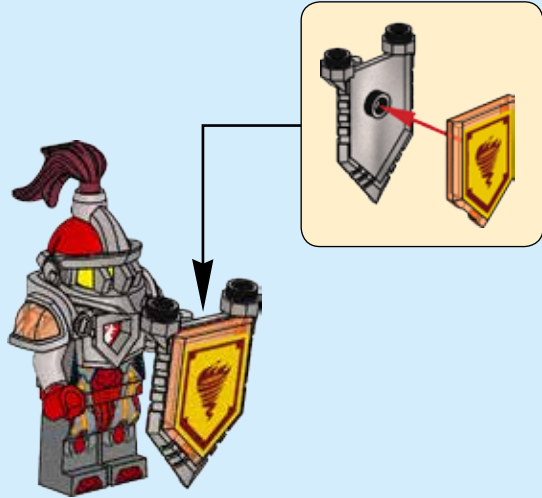

4

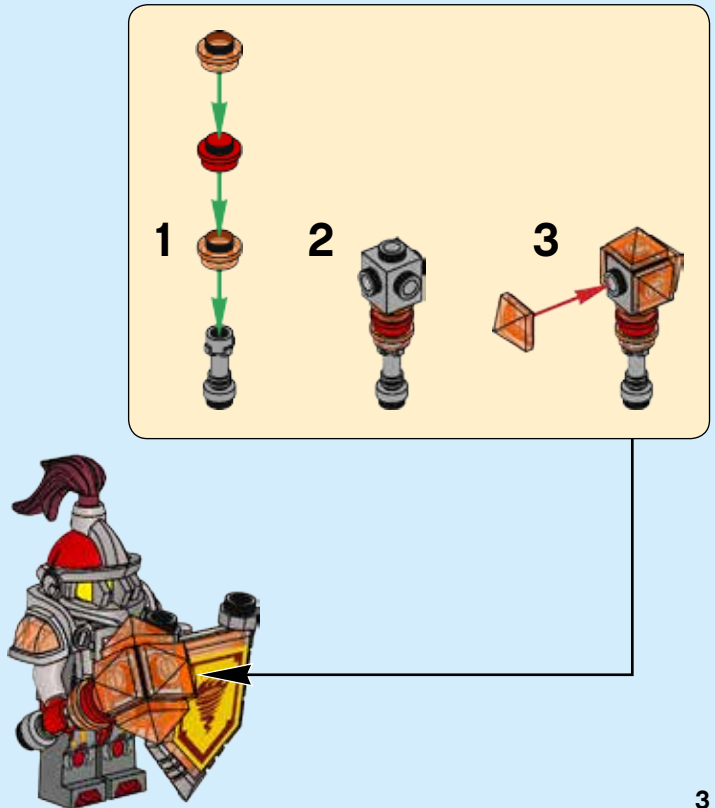

1

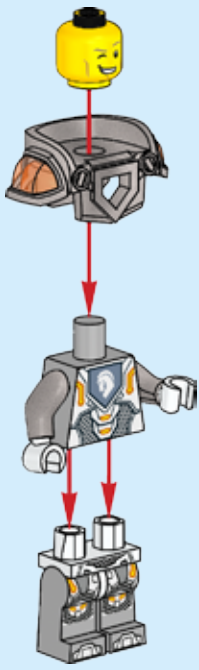

2

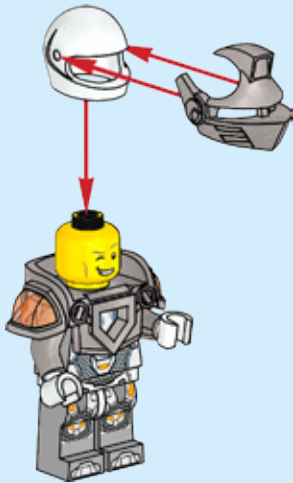

3

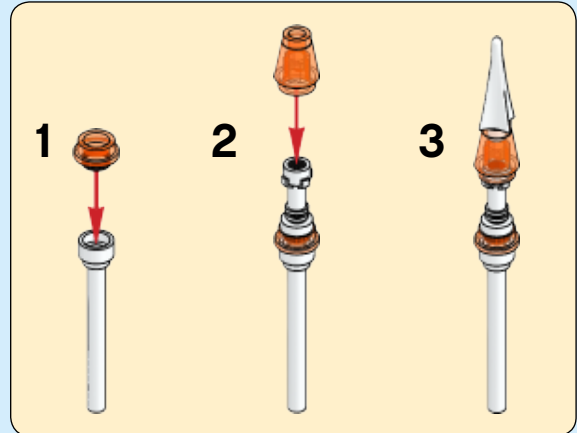
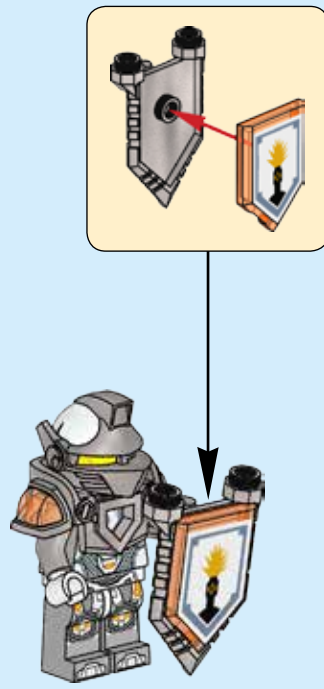

4

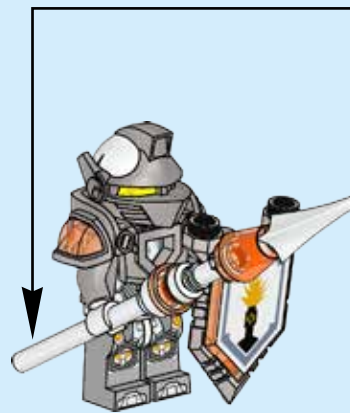

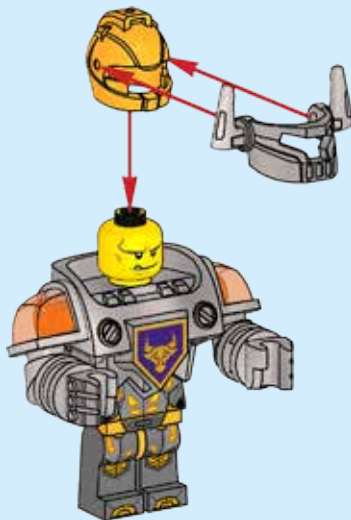
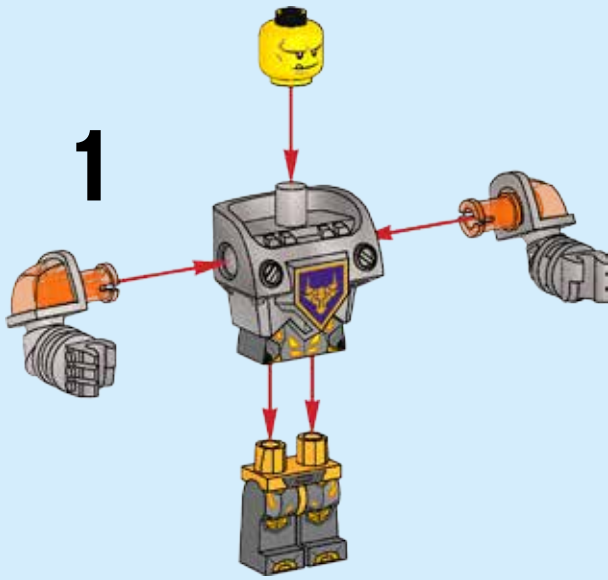

3

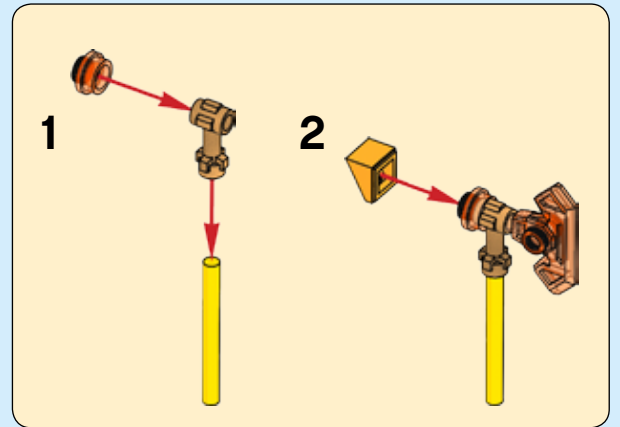

4

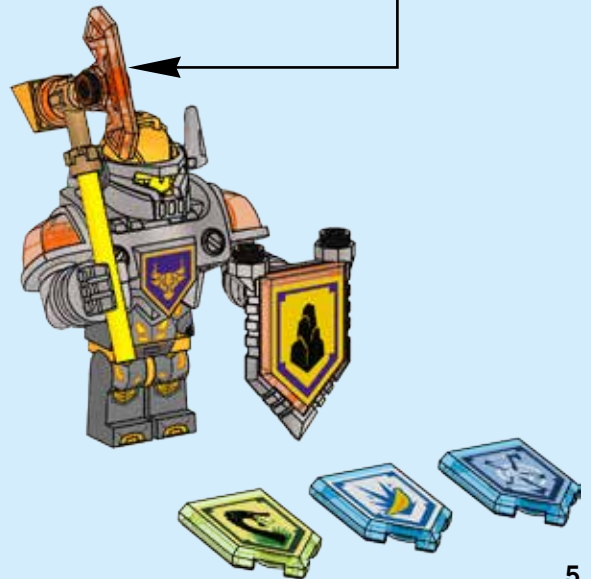

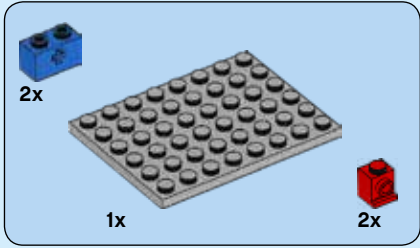
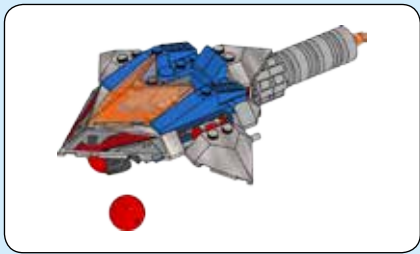

1

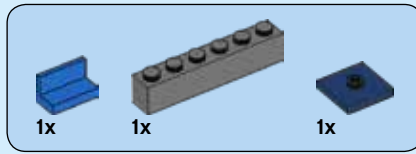
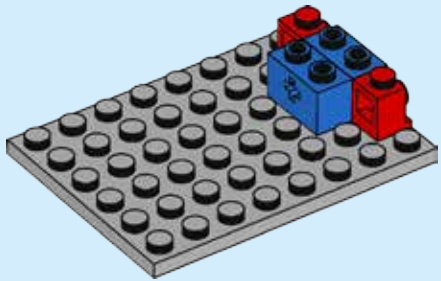

2

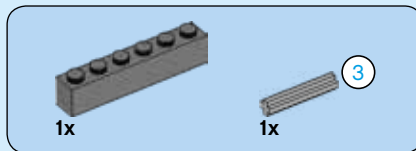
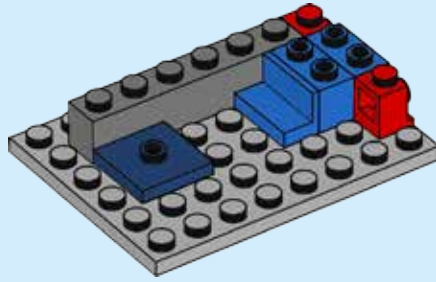

3

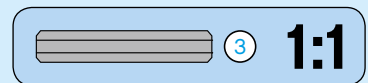
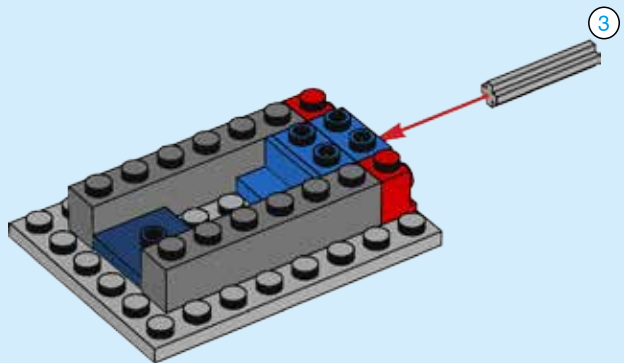

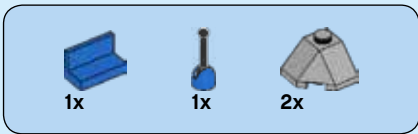

4

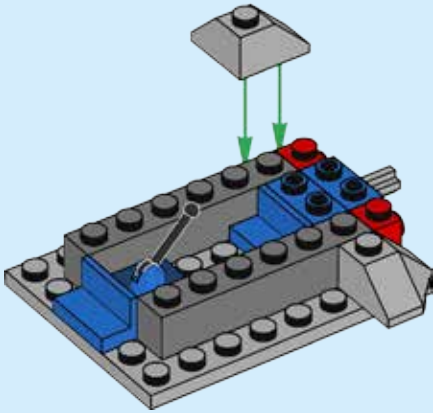

5

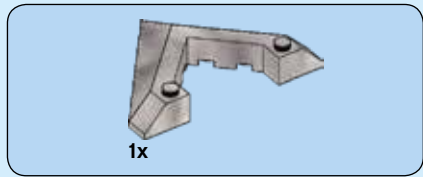
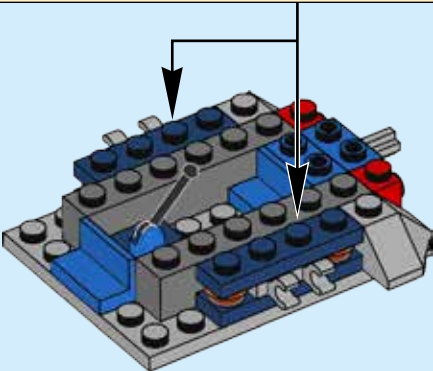
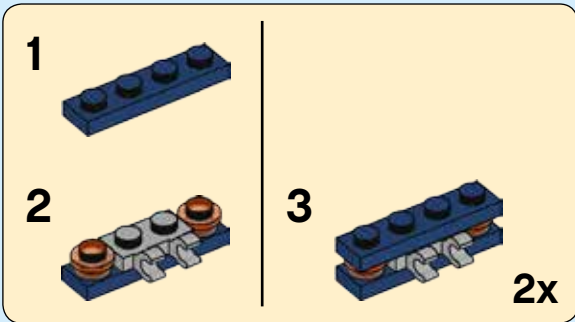

6

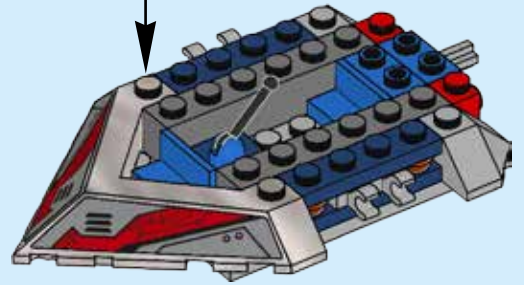
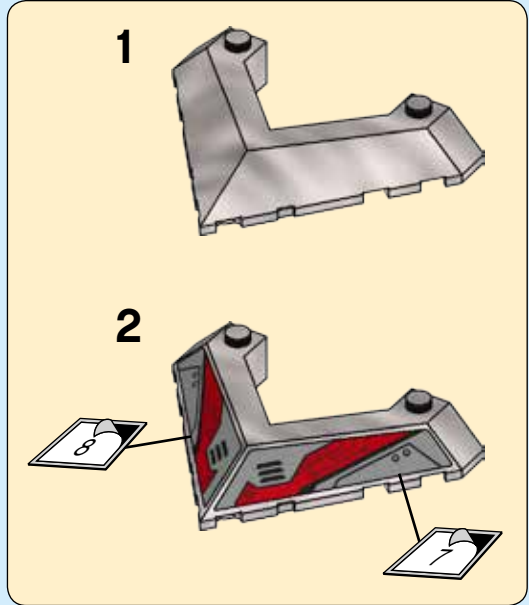

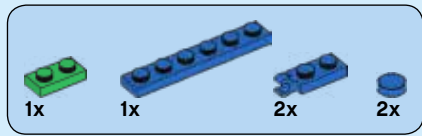

7

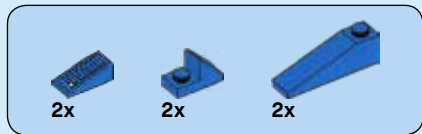
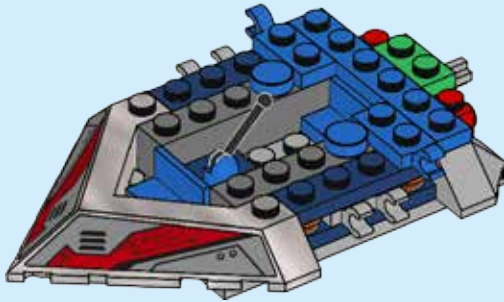

8

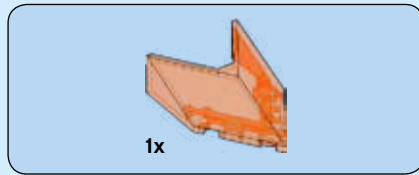
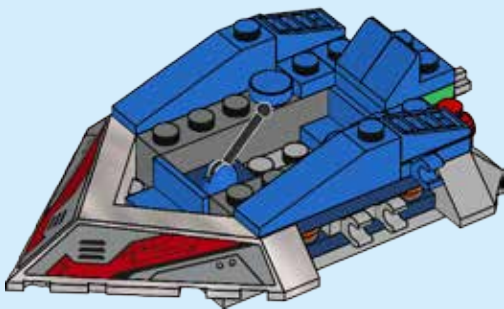

9

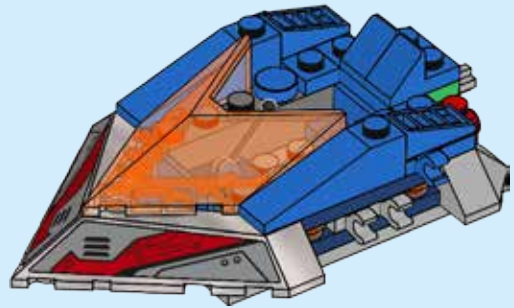



6 1:1

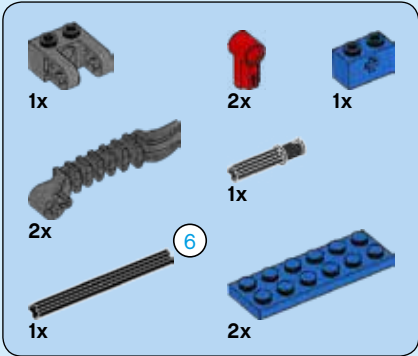

10

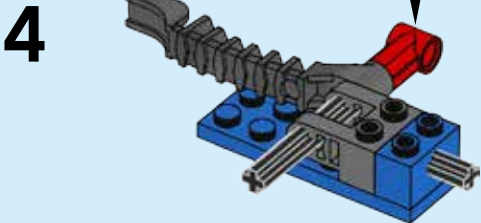
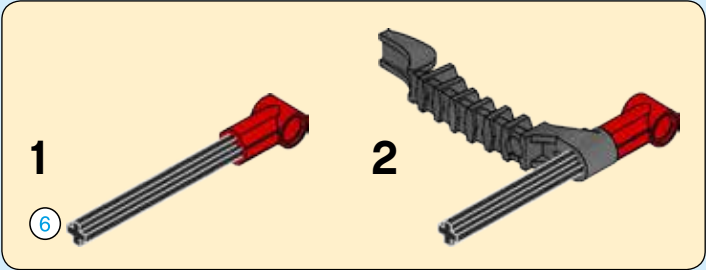
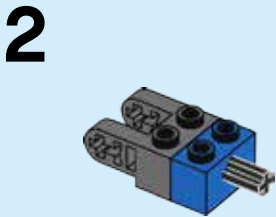
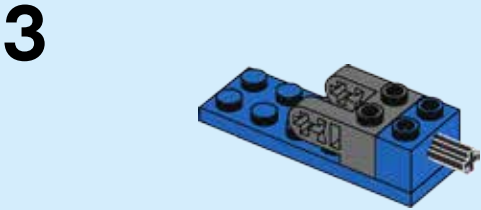
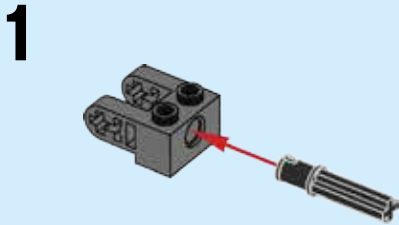



5

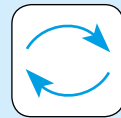
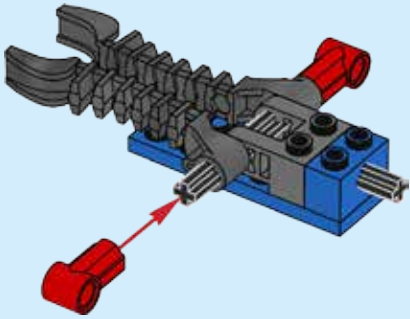

6

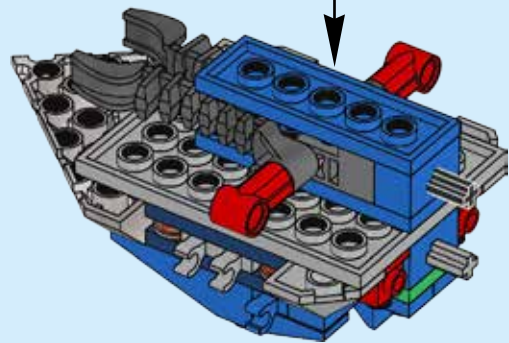
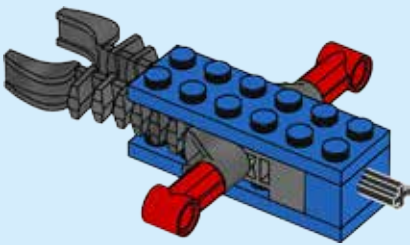

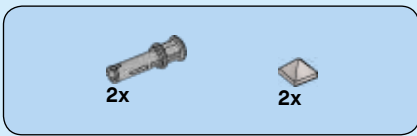

11

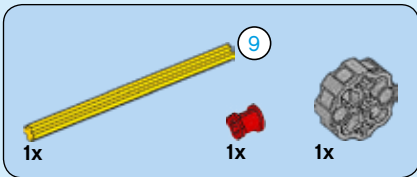
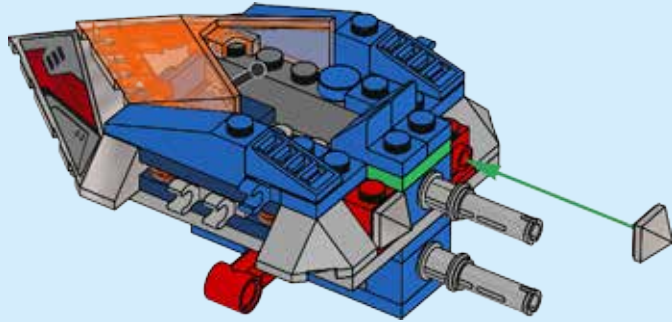
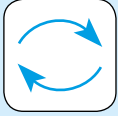

12

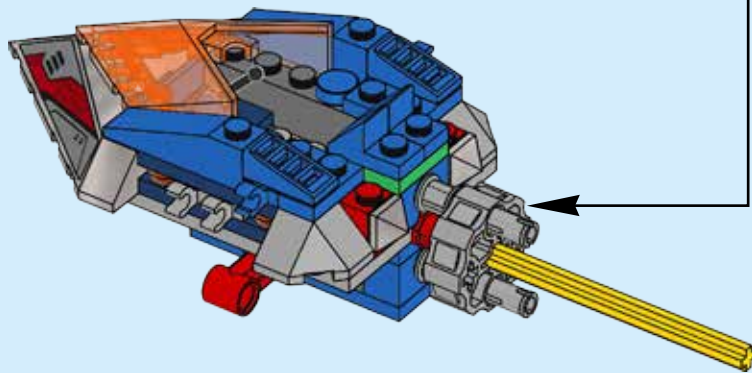
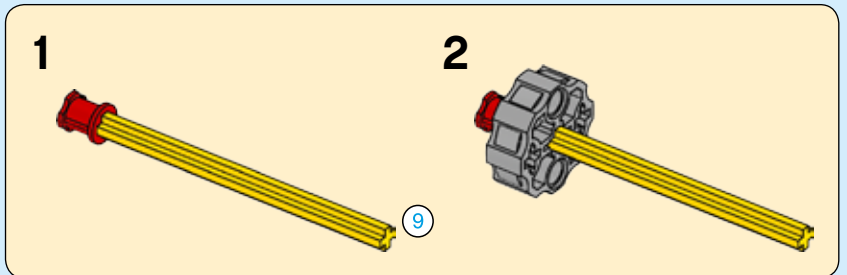



1x

13

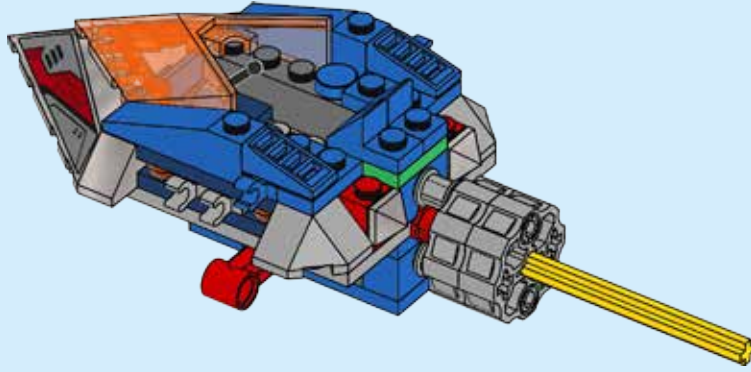

3x

14

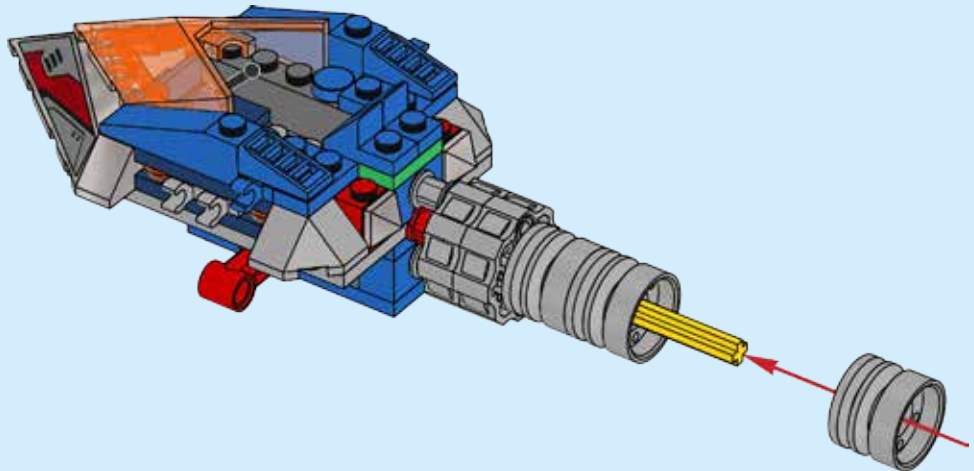

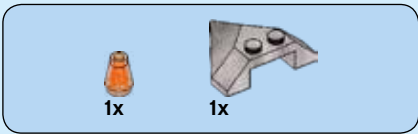

15

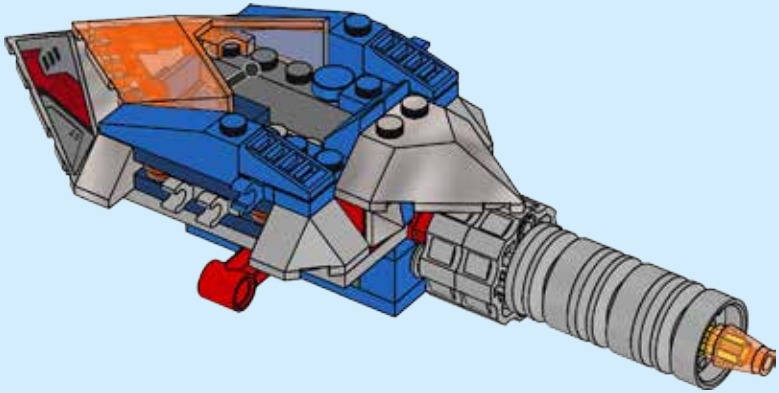

16

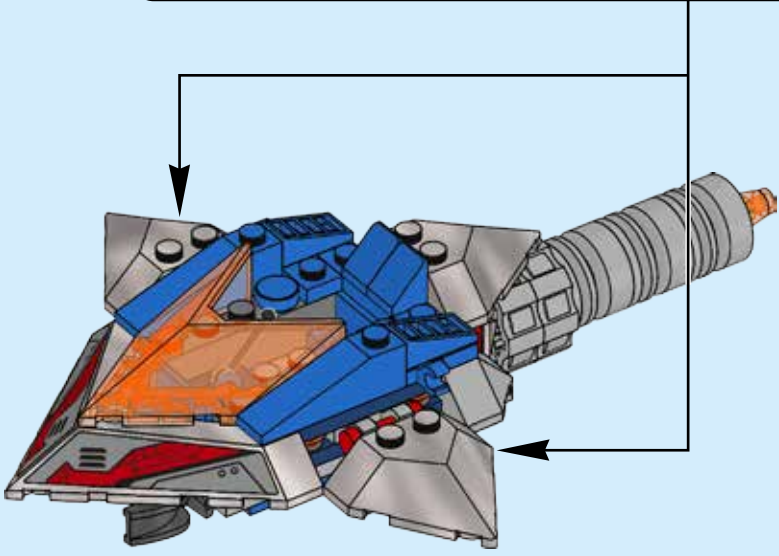
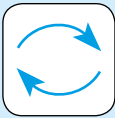

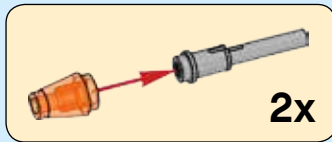
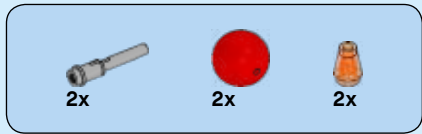

17

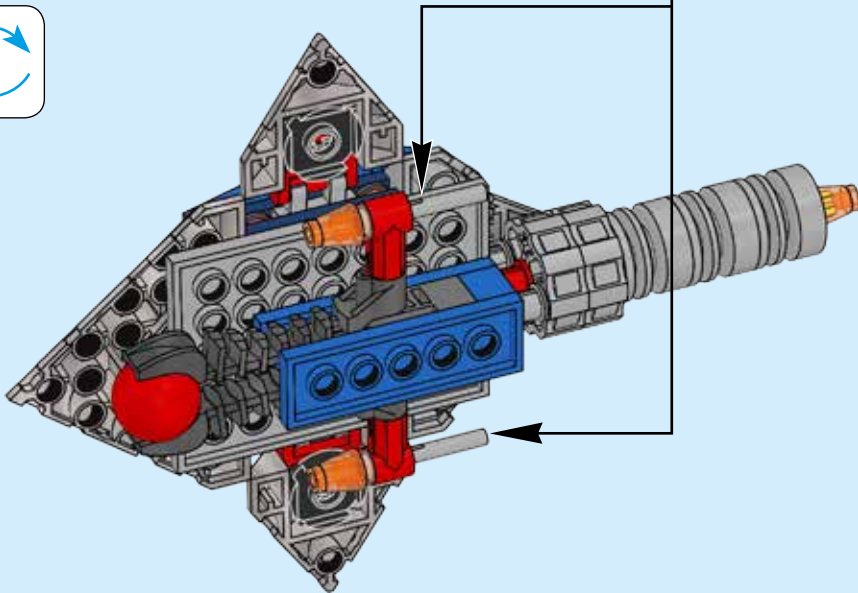
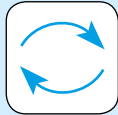

18

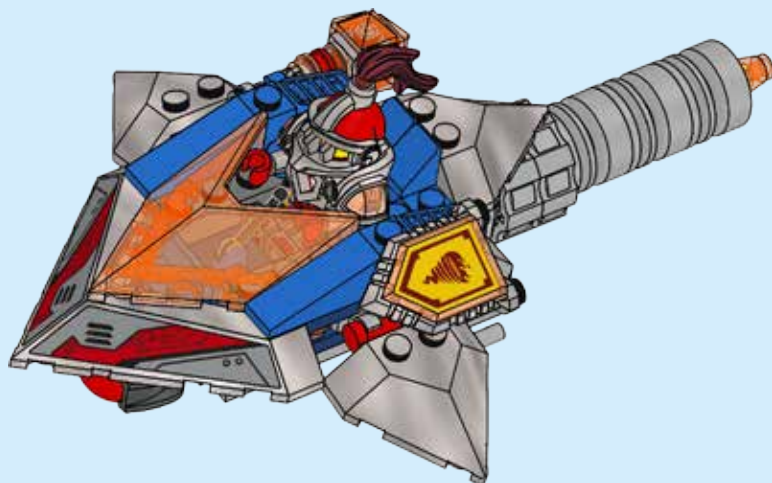
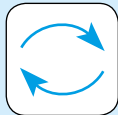

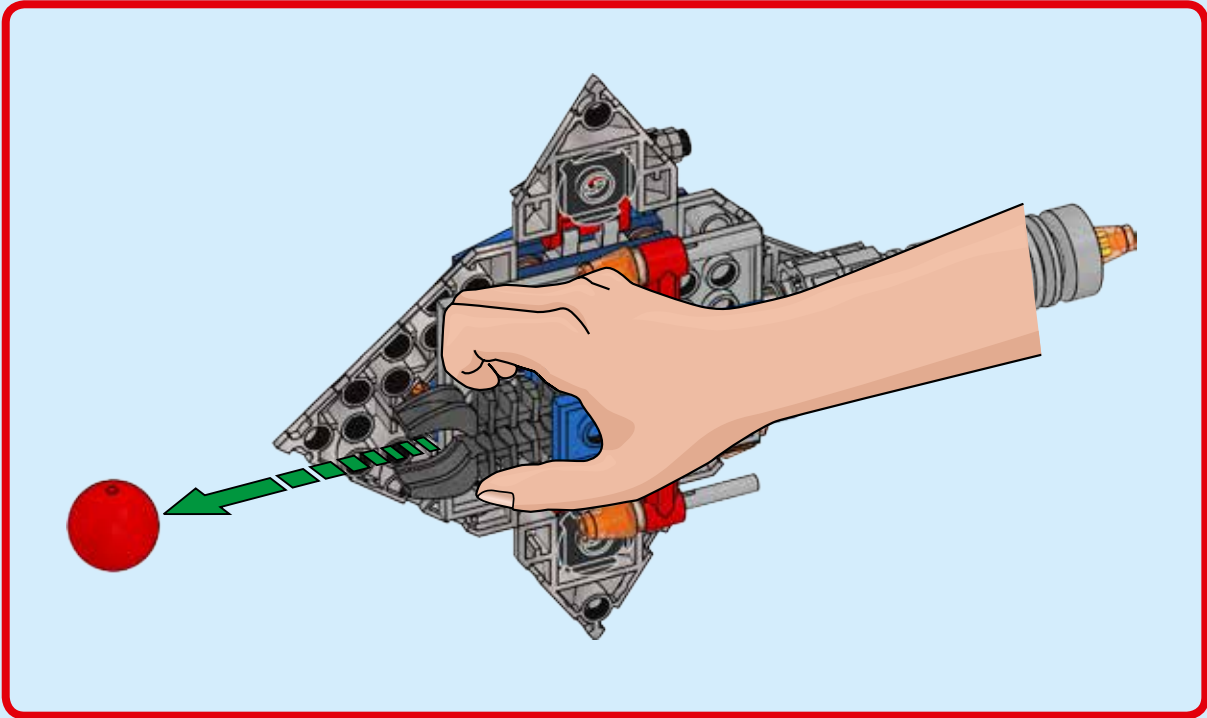
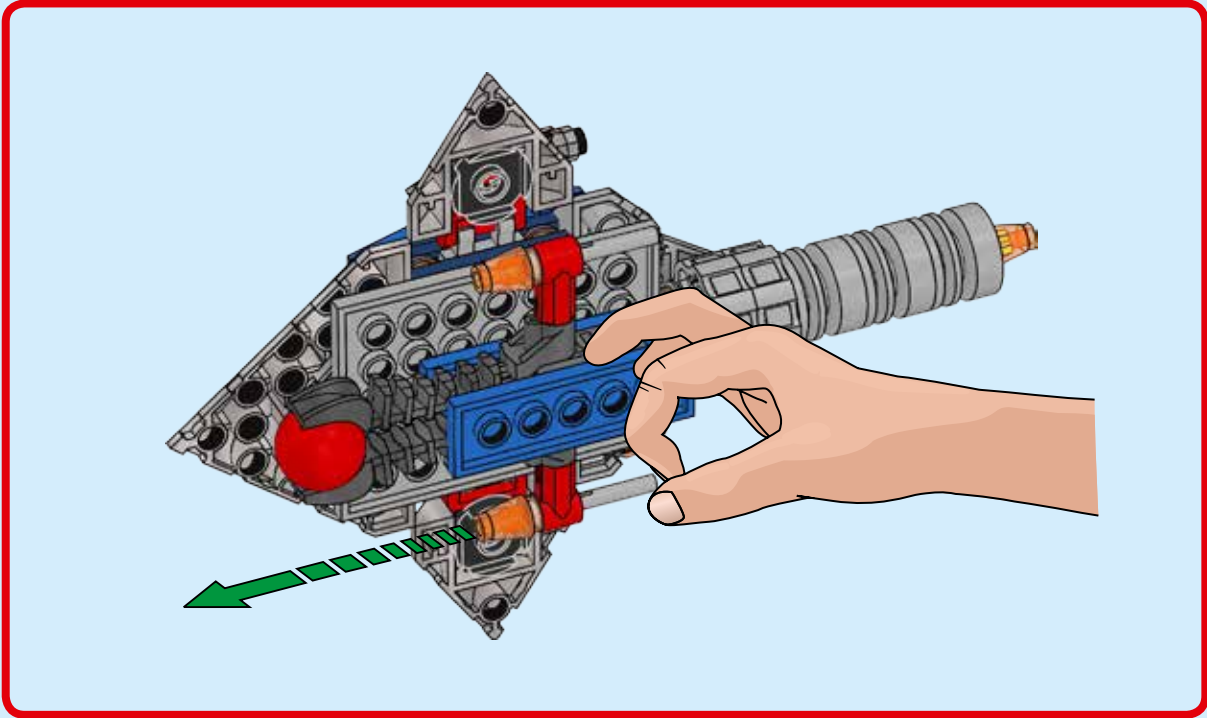

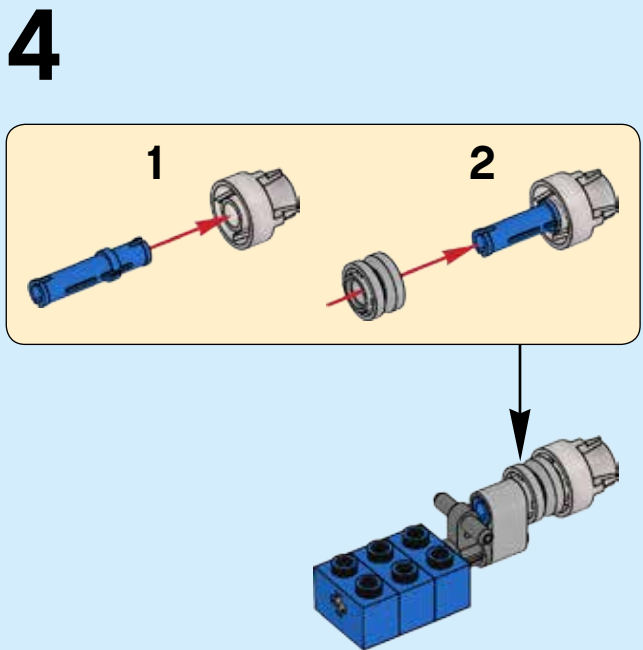
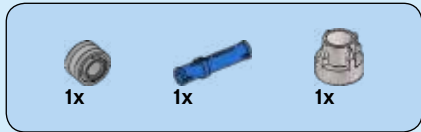
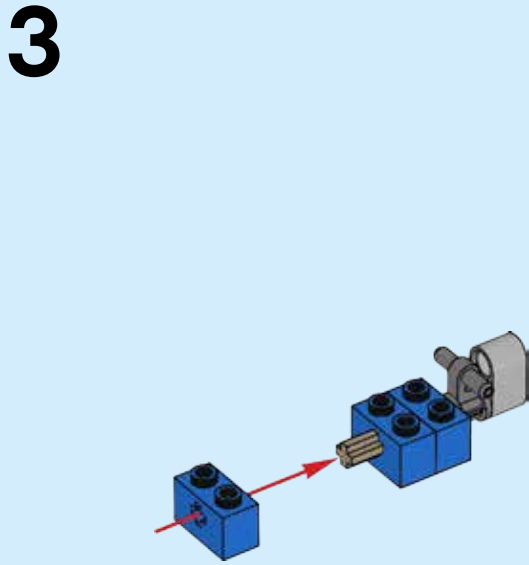
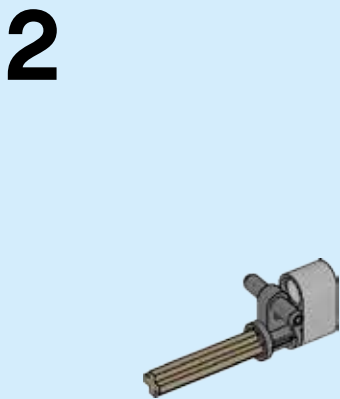
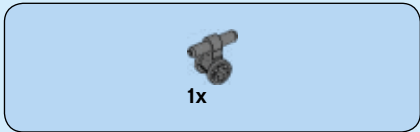
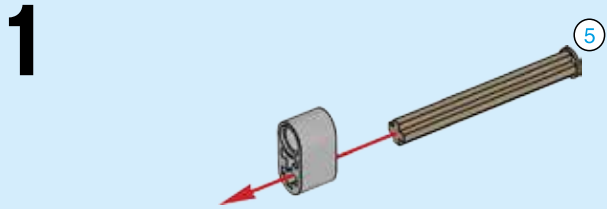
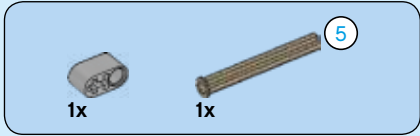



5

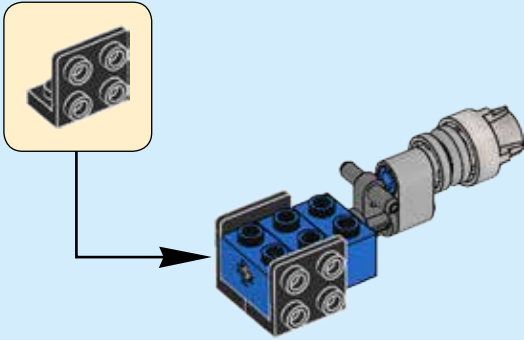

6

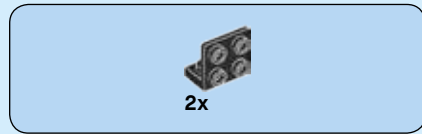
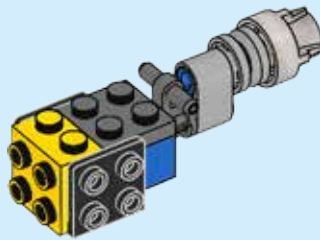

7

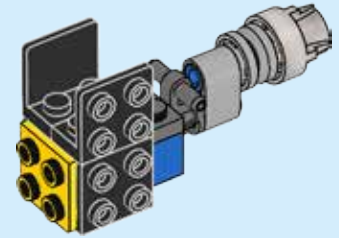

8

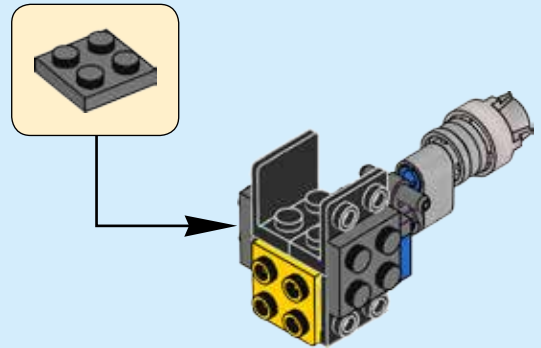



2x

9

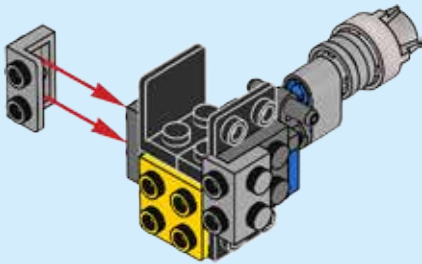

2x



1x

11

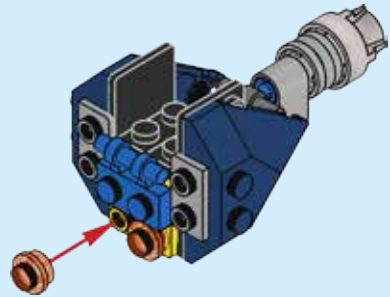

2x

10

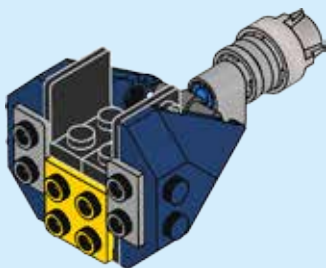

2x

12

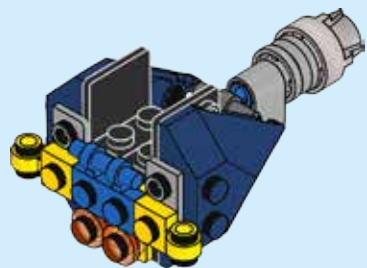



13

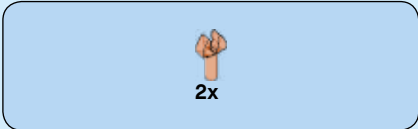
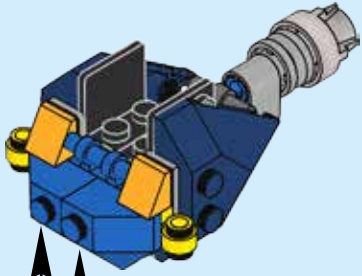

14

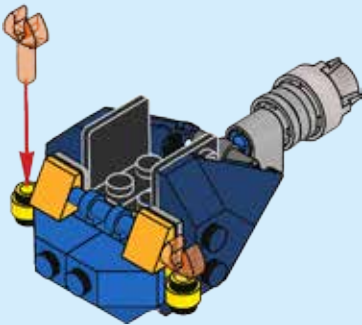

15

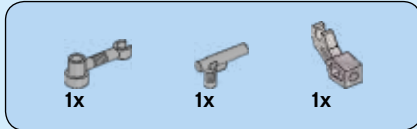
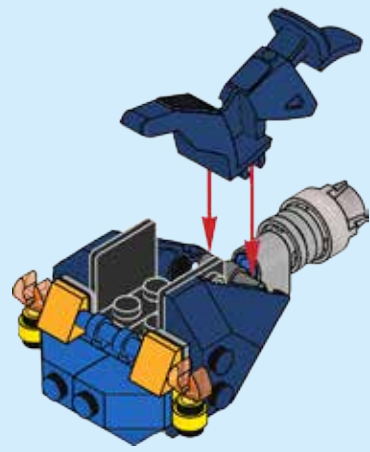

16

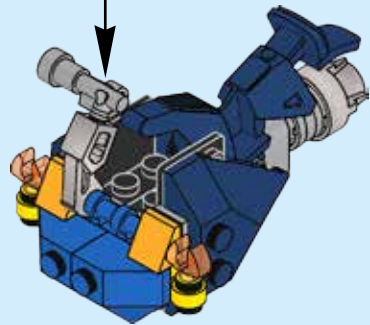
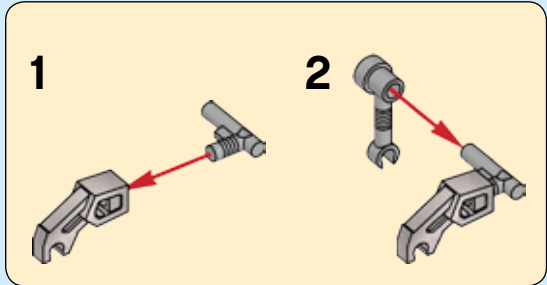

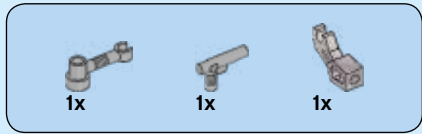

17

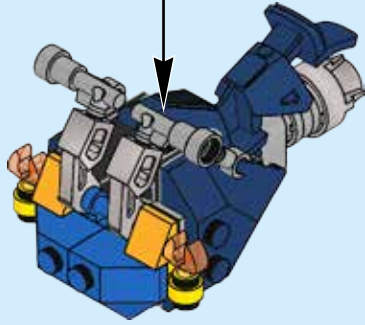
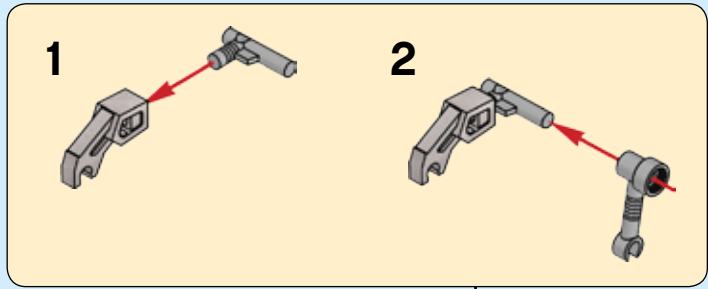

18

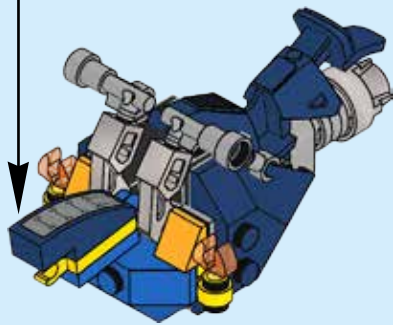
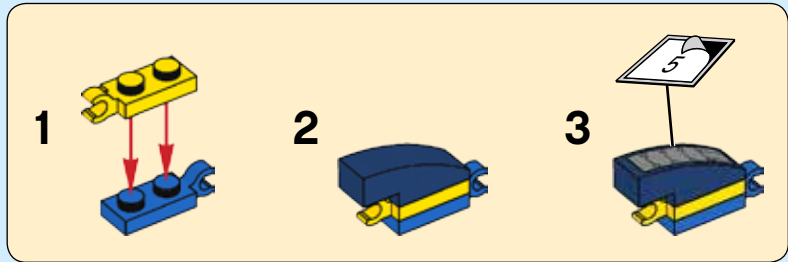

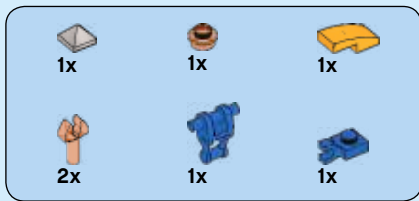

19

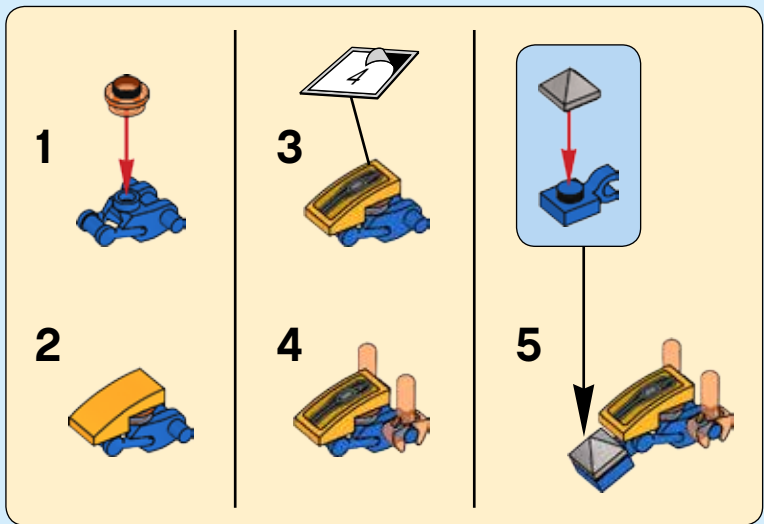

20





2x

+

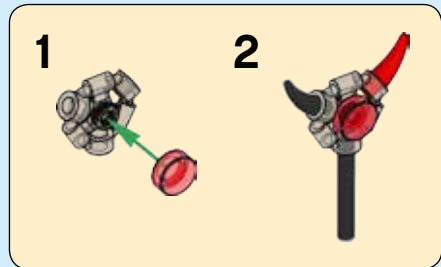
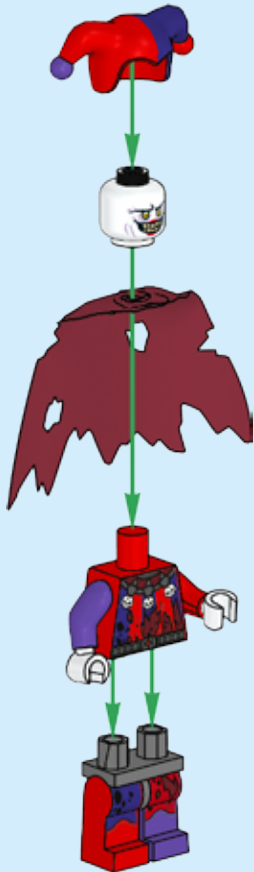
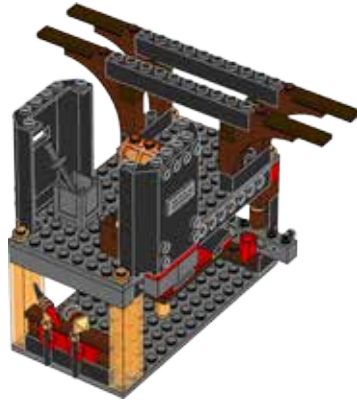

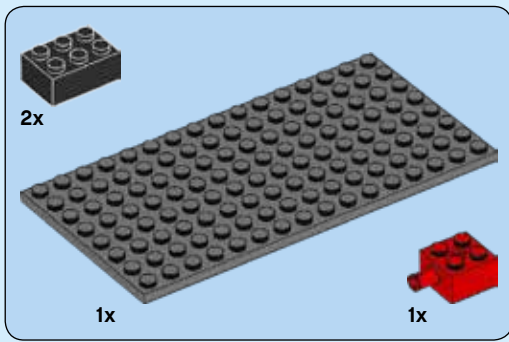

1

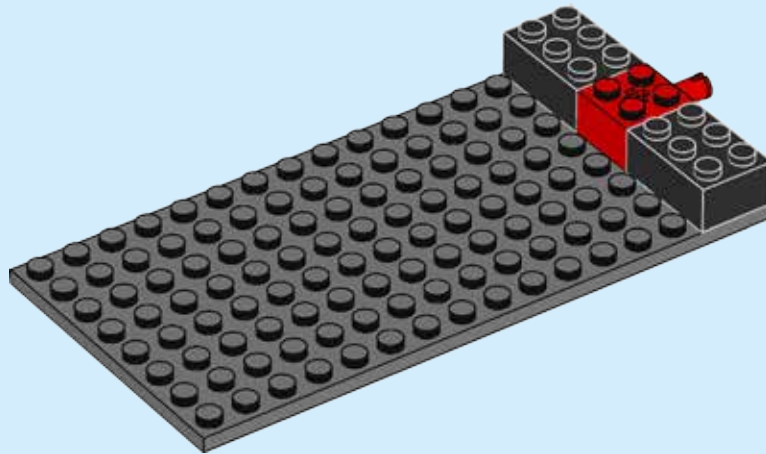

2

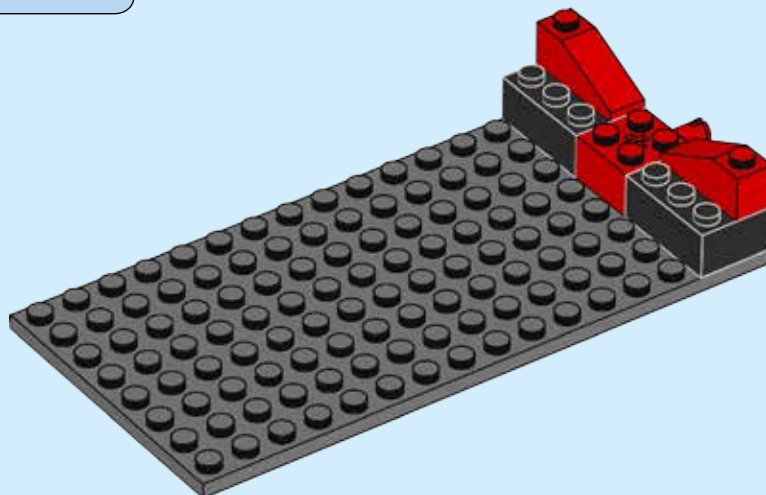

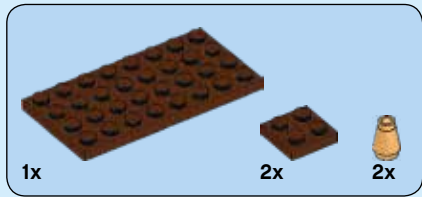

3

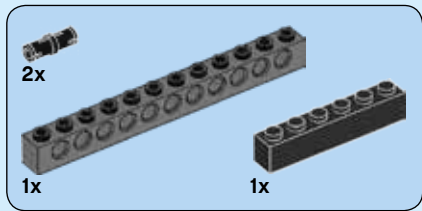
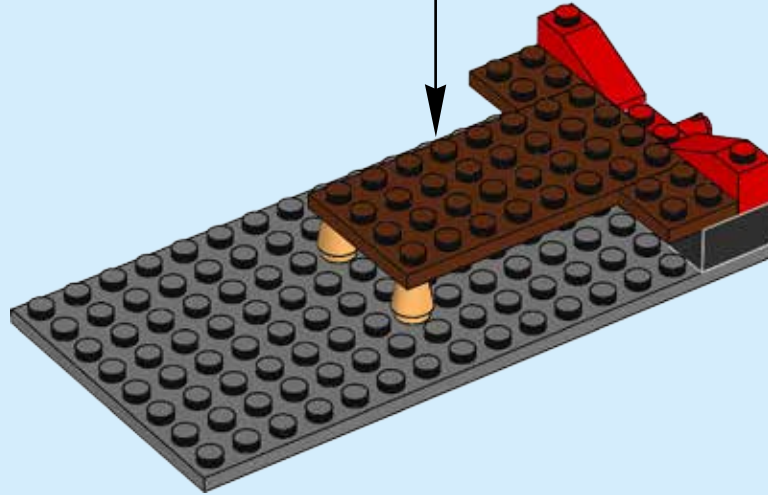

4

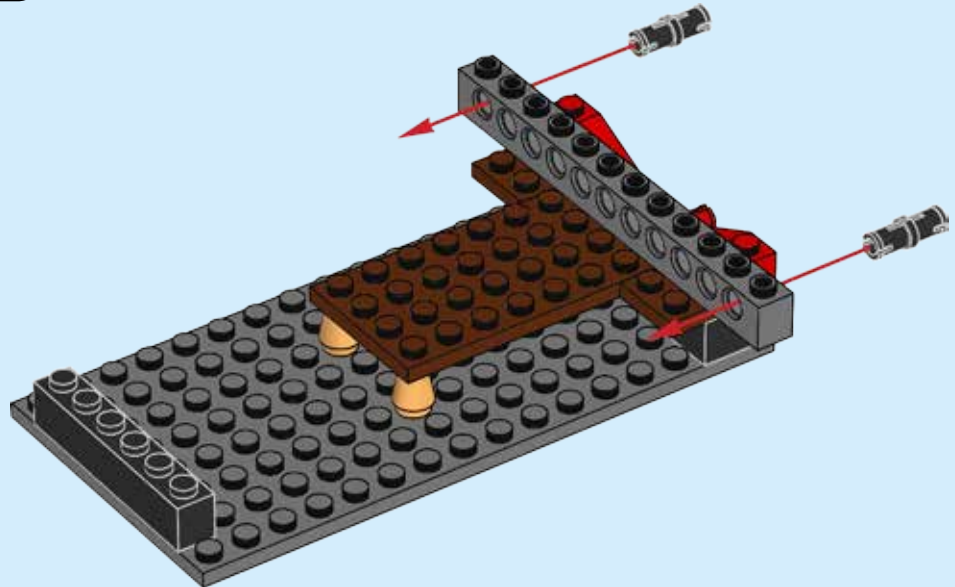

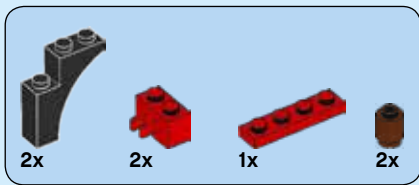

5

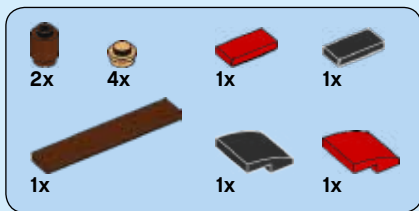
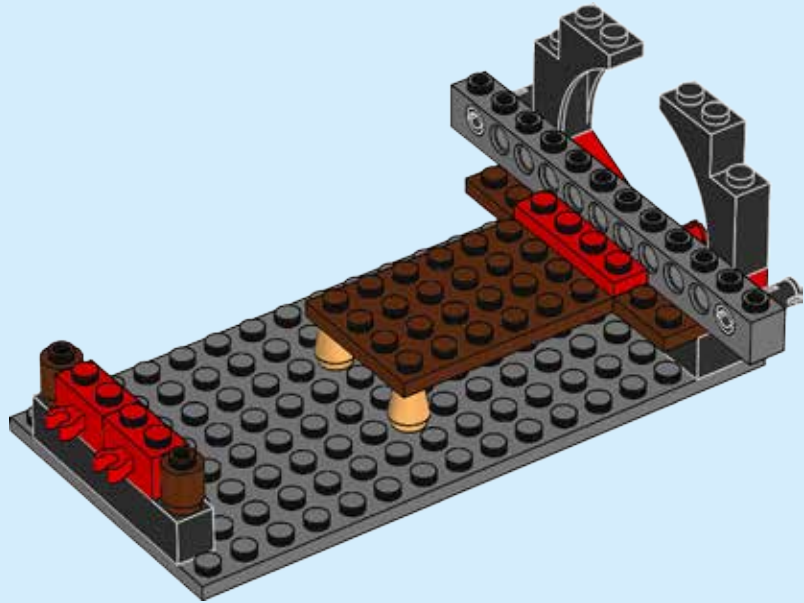

6

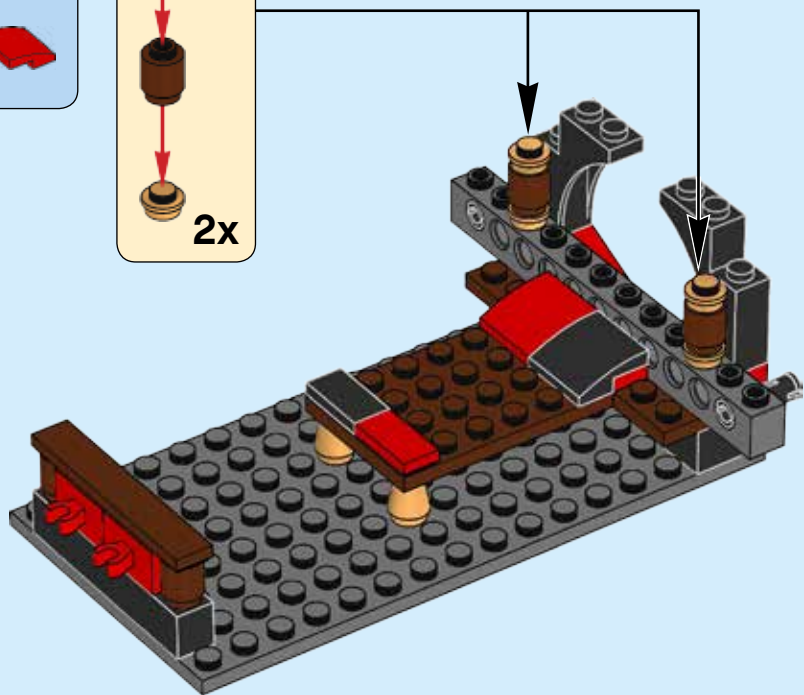
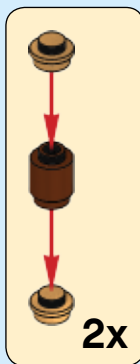

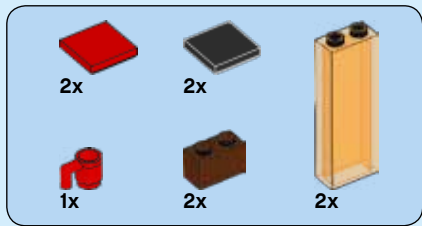

7

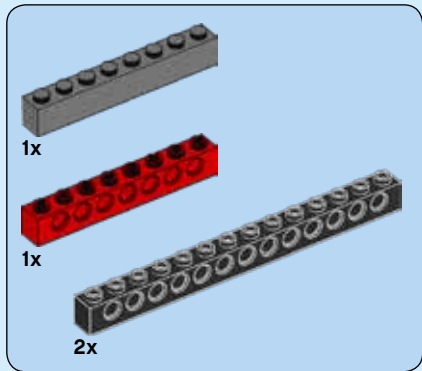
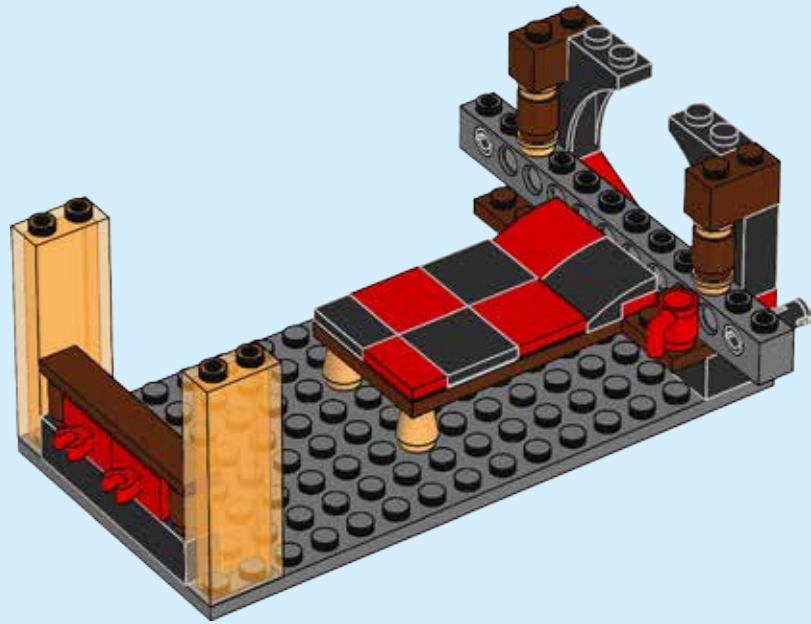

8

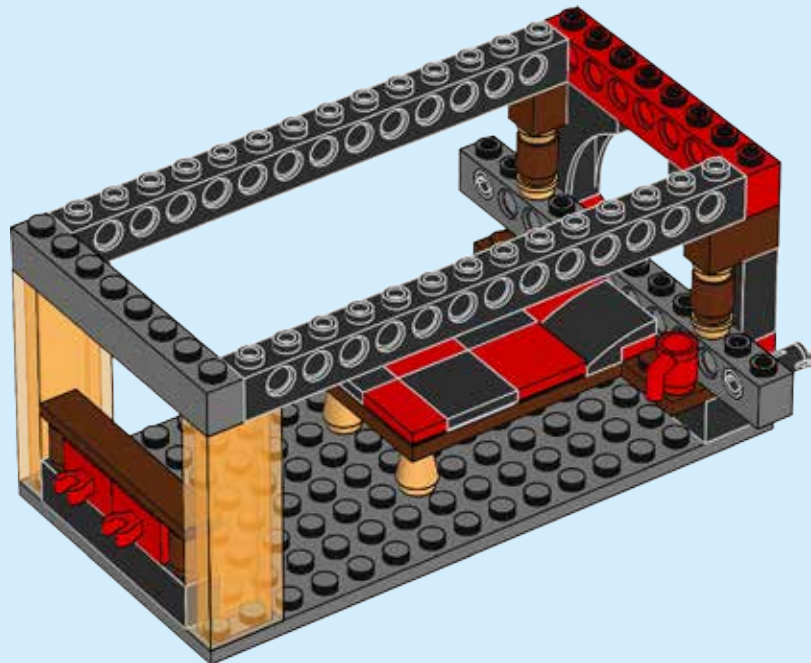

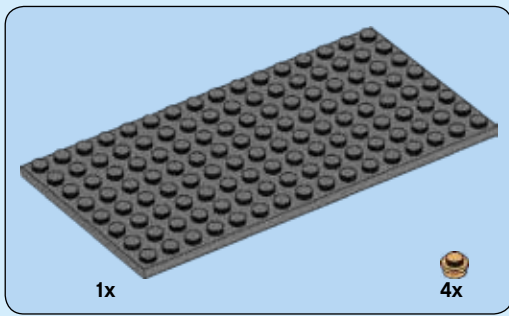

9

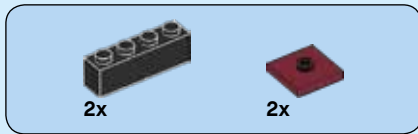
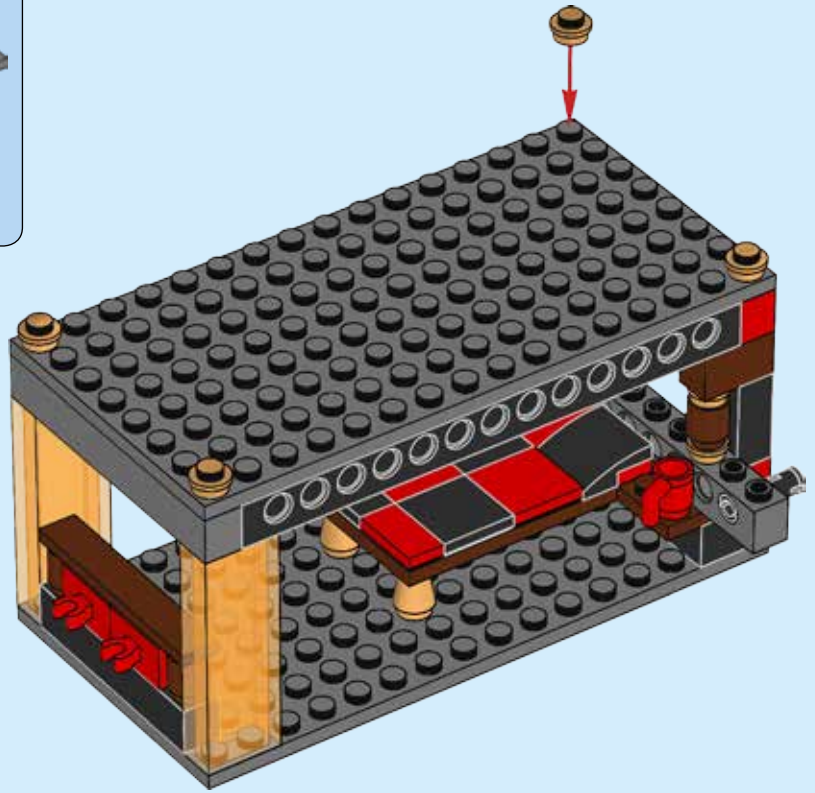

10

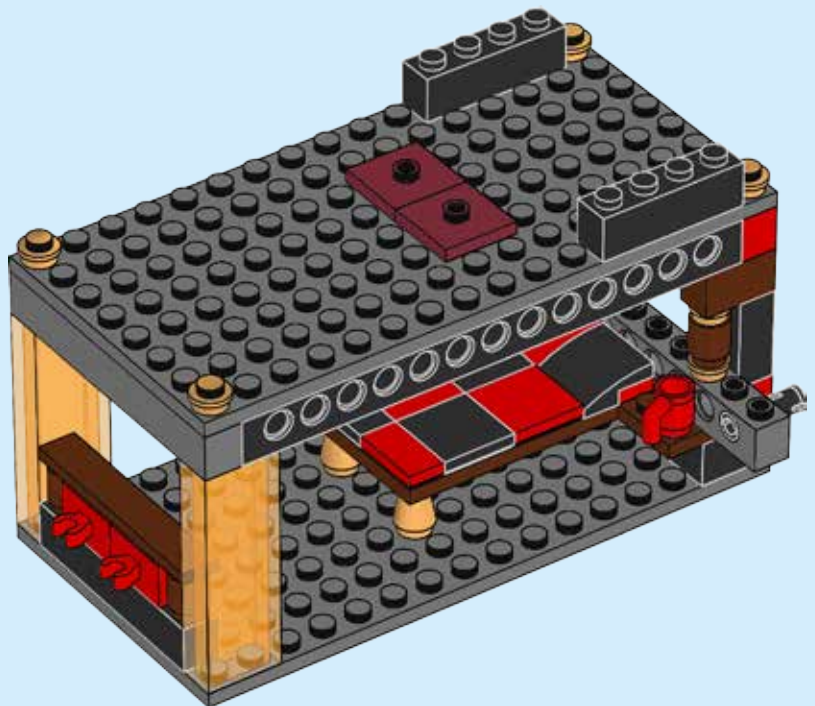

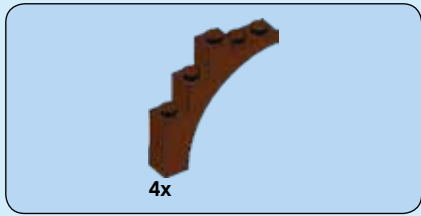

11

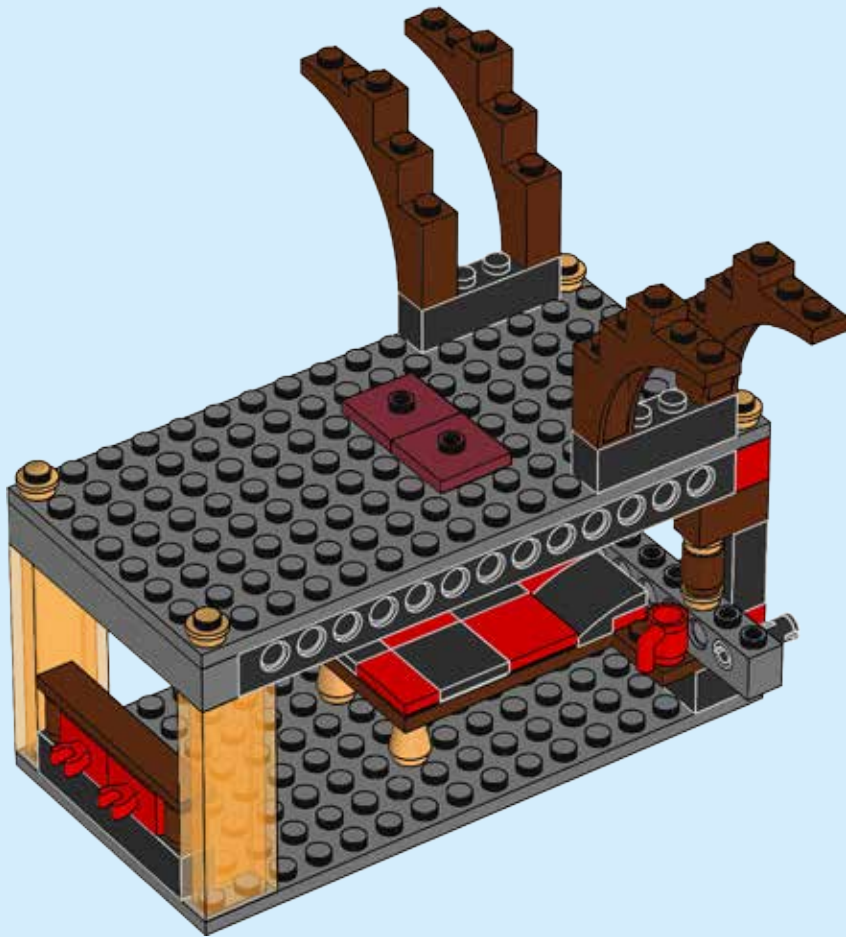

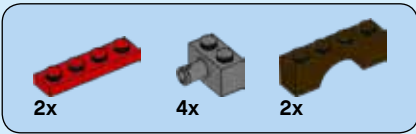

12

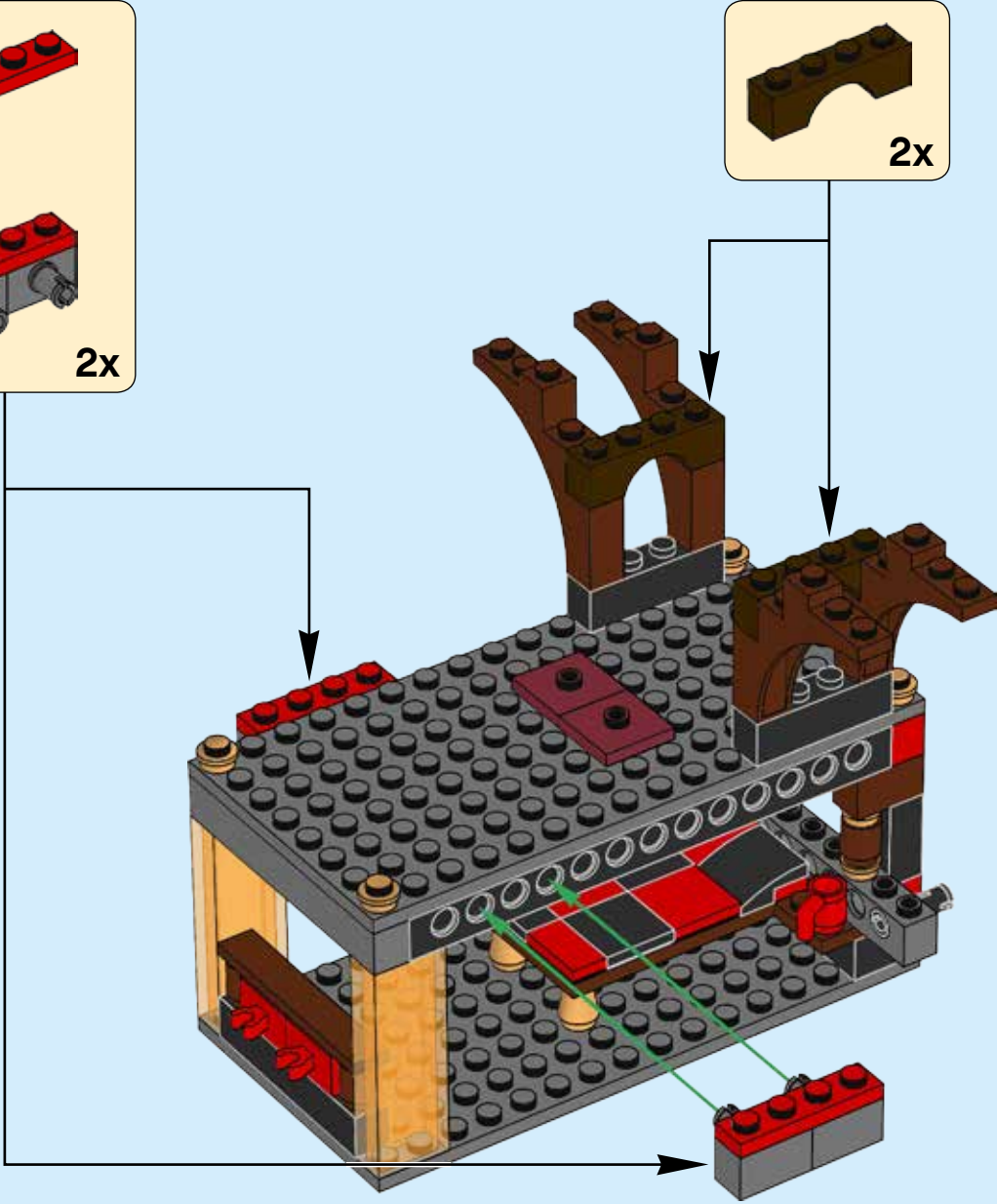
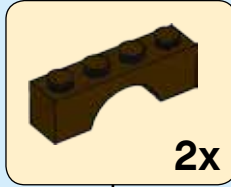
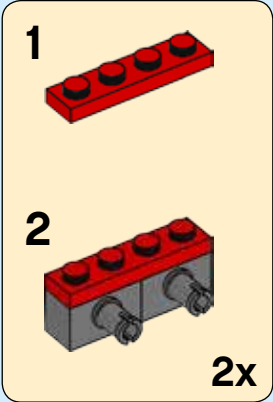

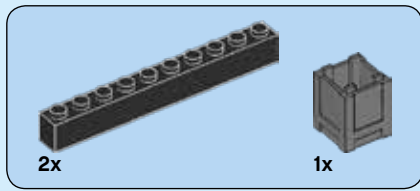

13

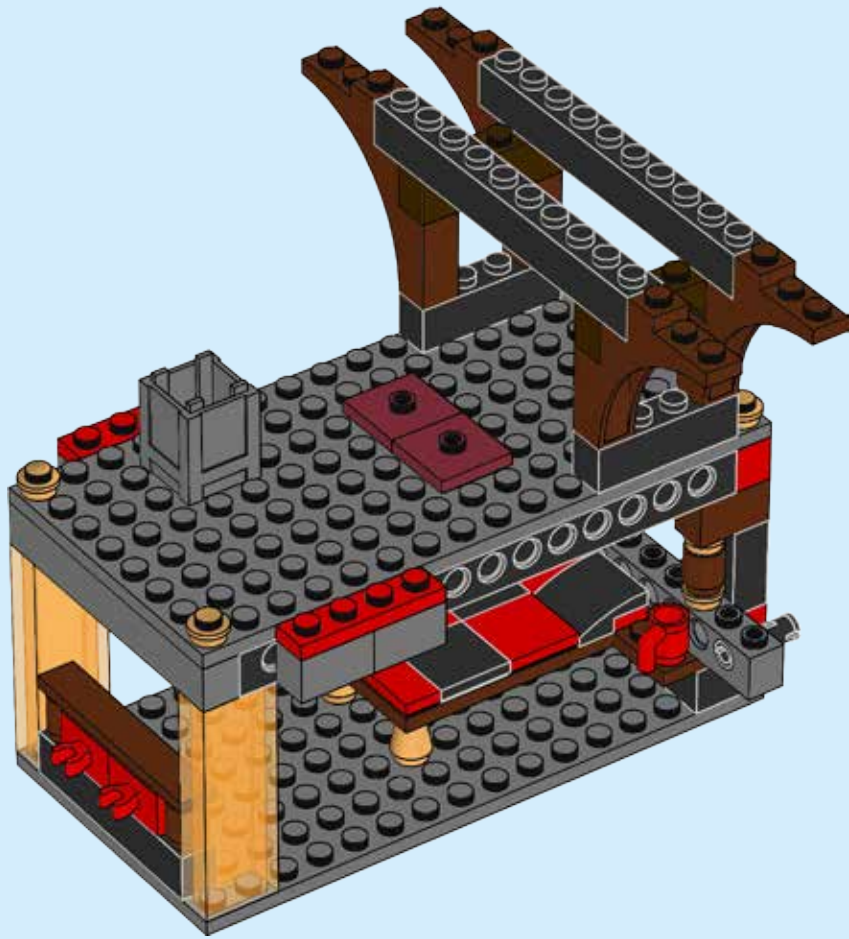

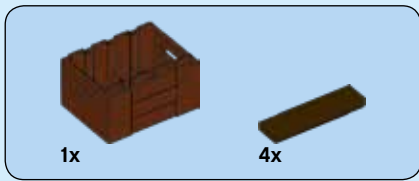

14

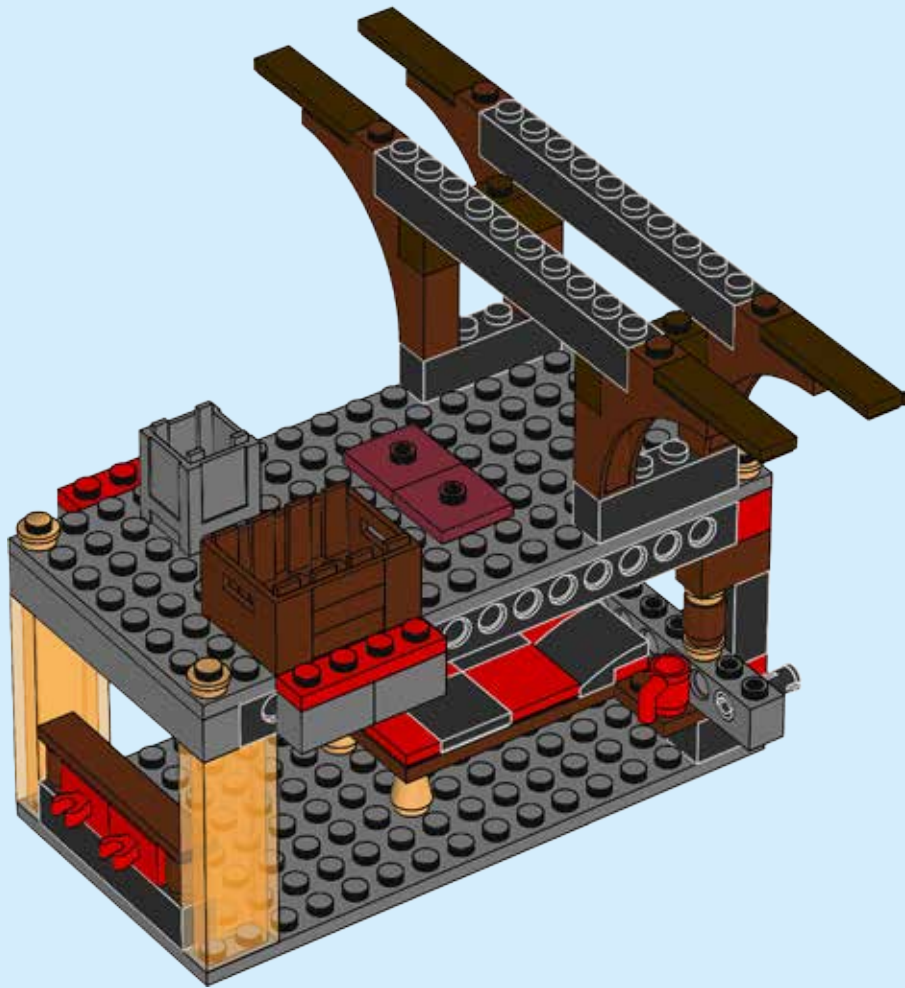

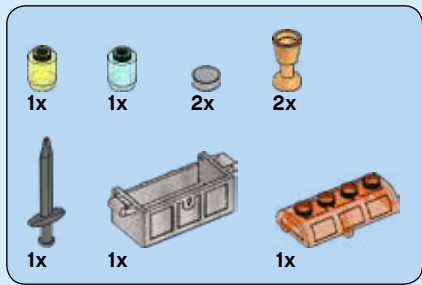

15

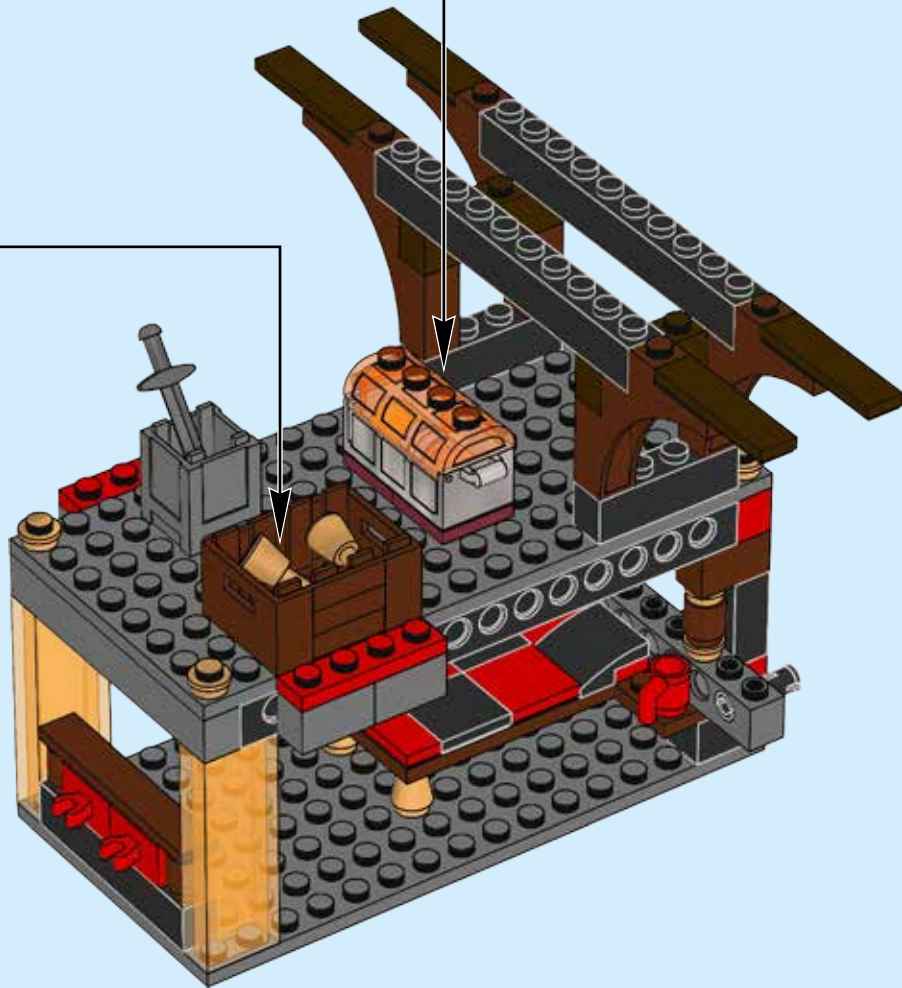
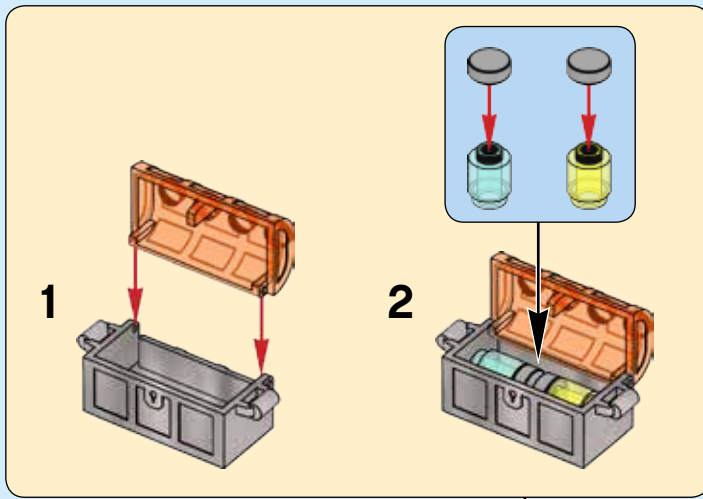

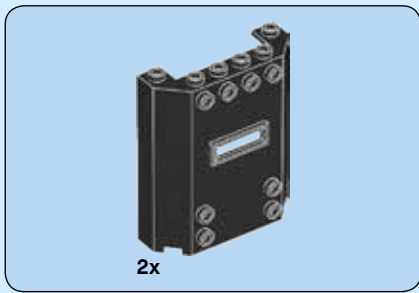

16

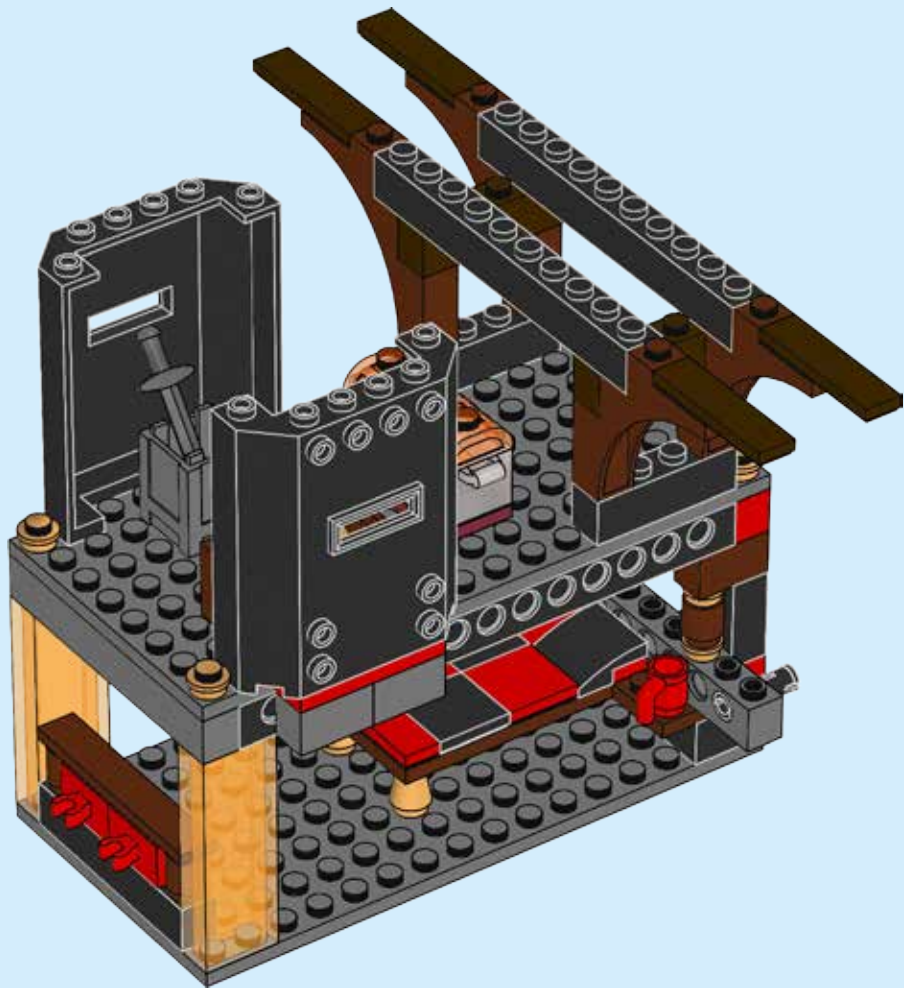

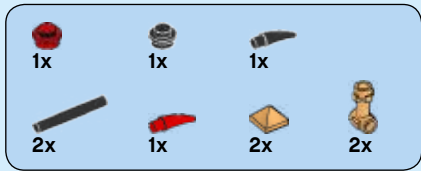

17

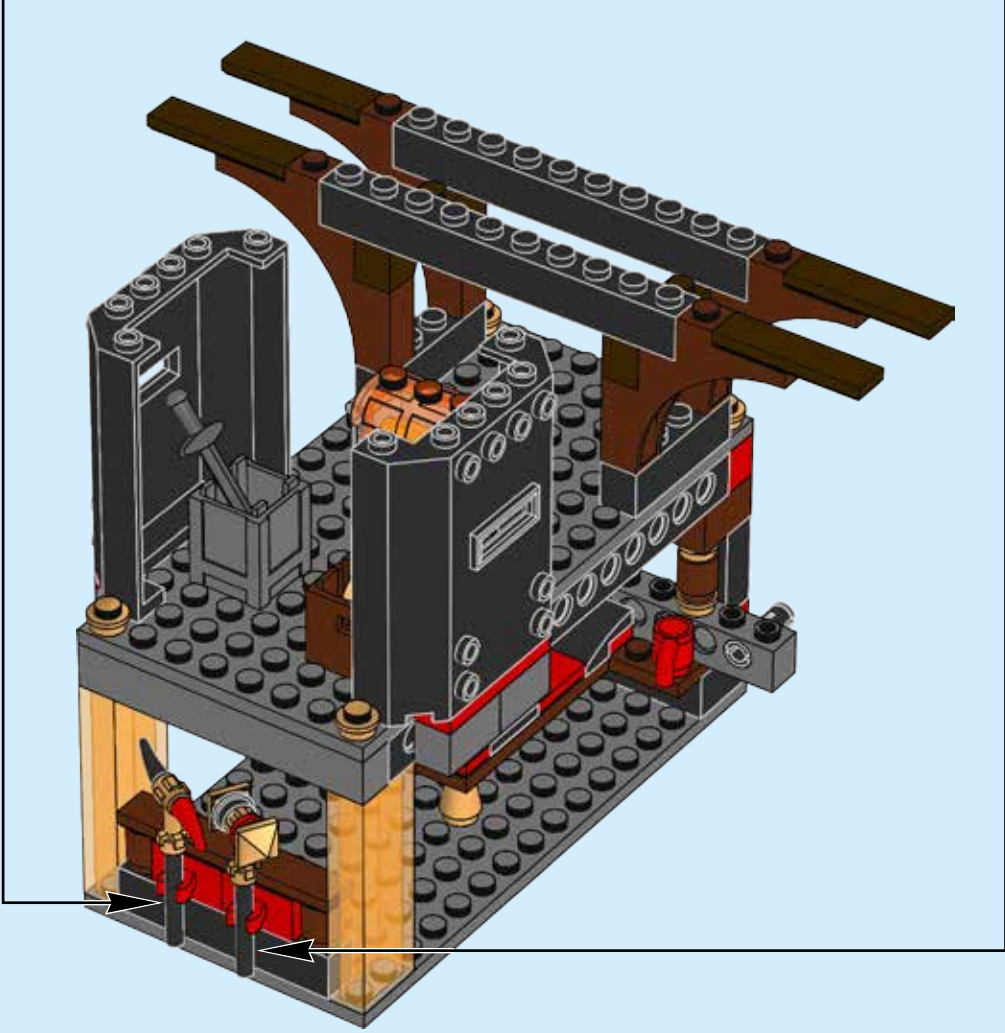
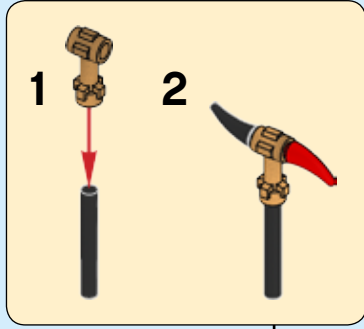

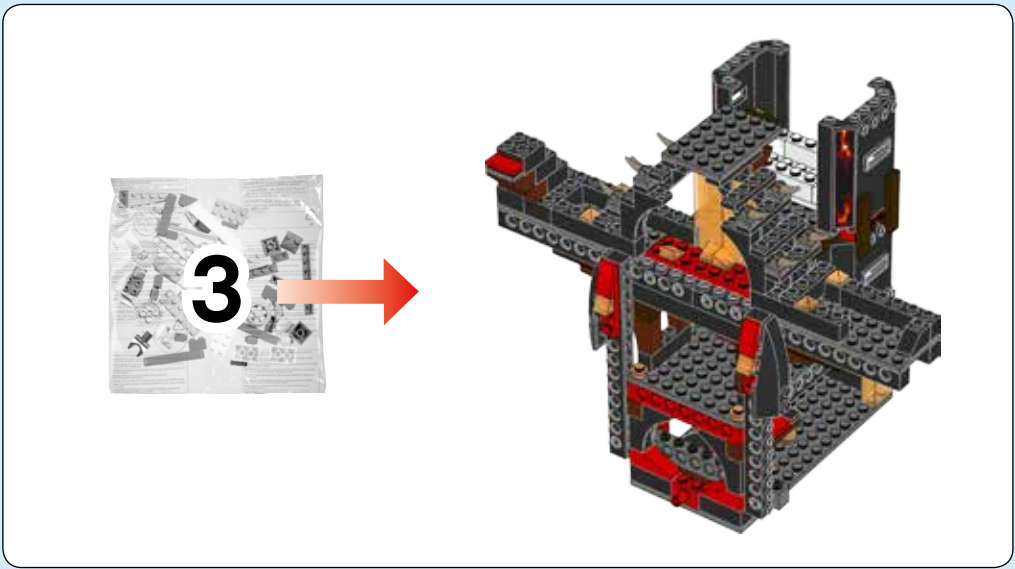

18

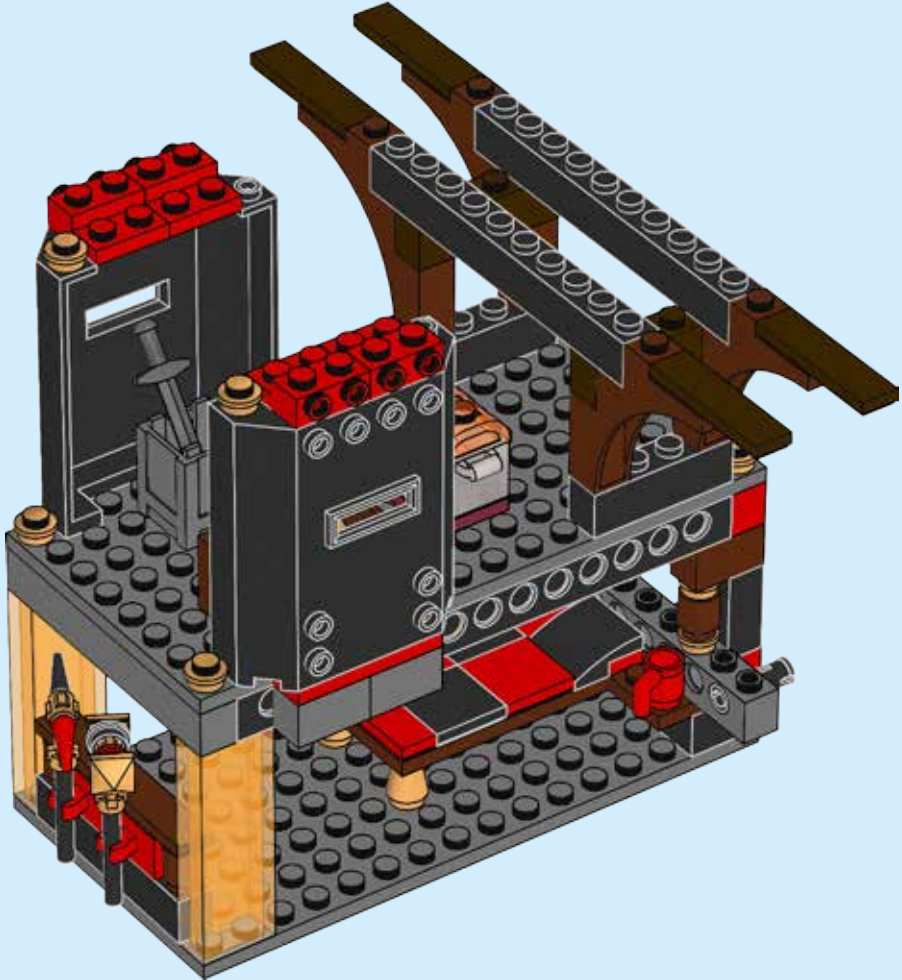

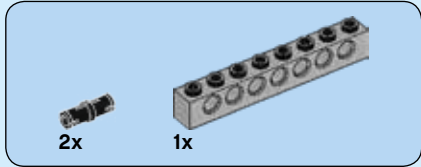
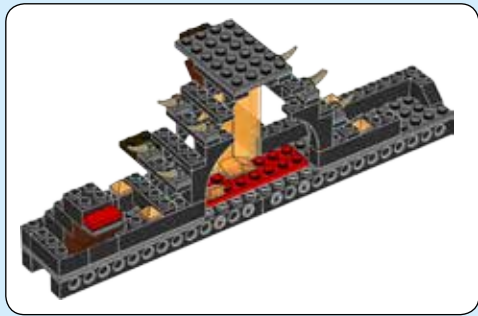

19

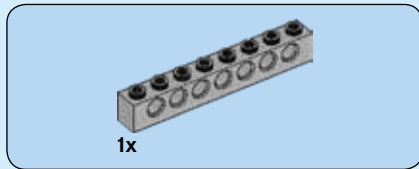
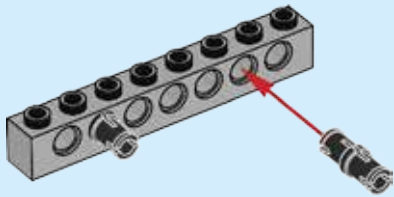

20

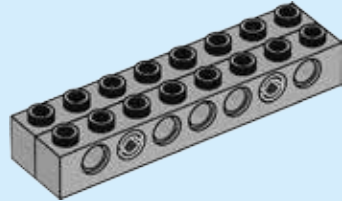

21

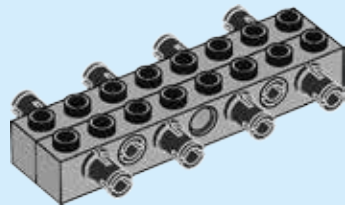

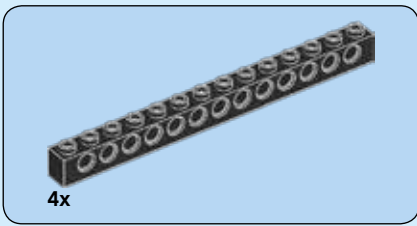

22

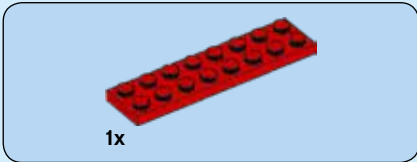
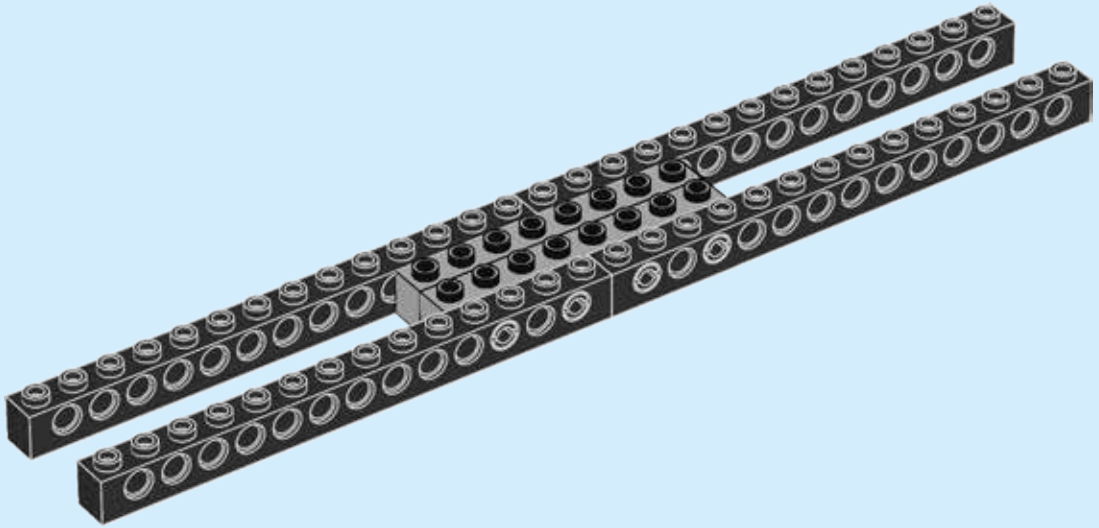

23

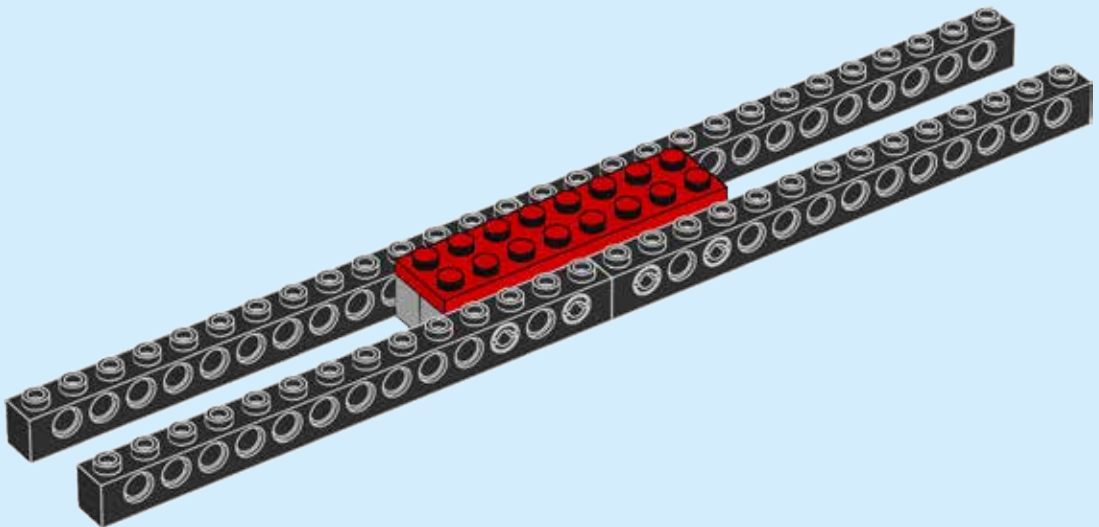

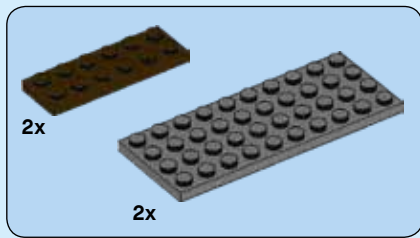

24

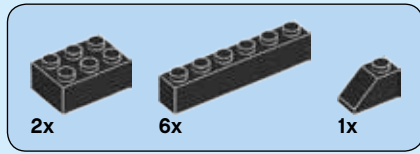
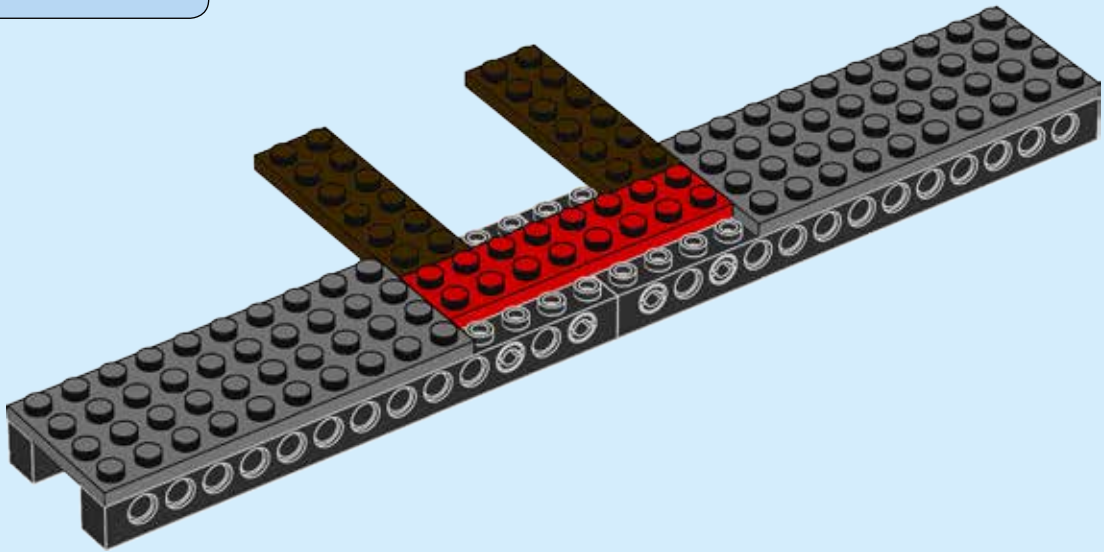

25

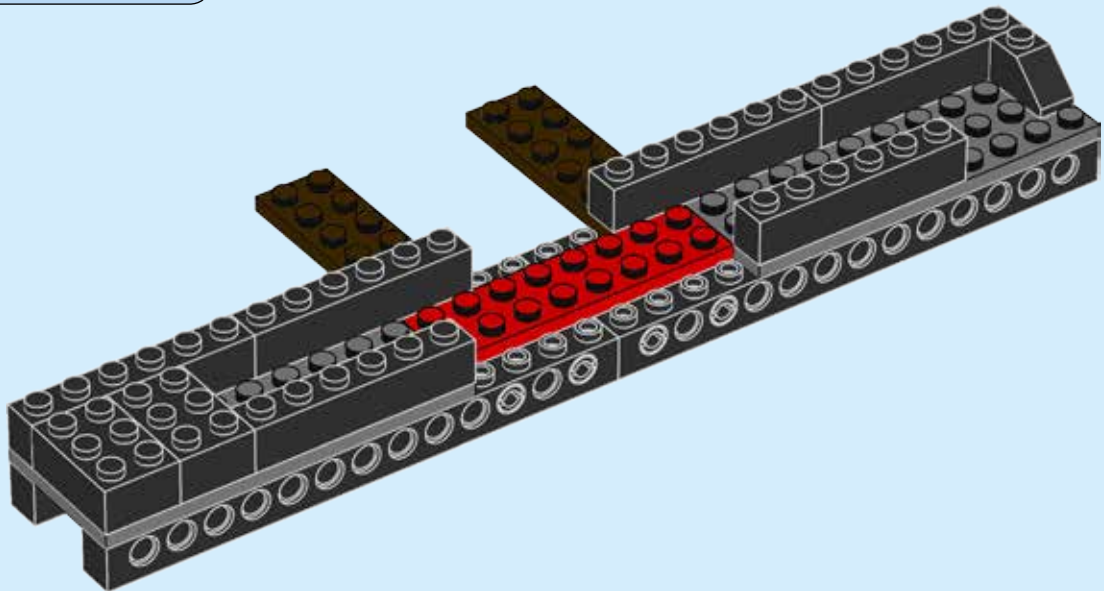

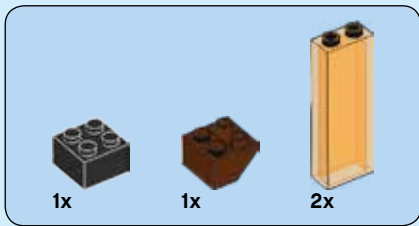

26

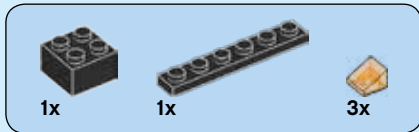
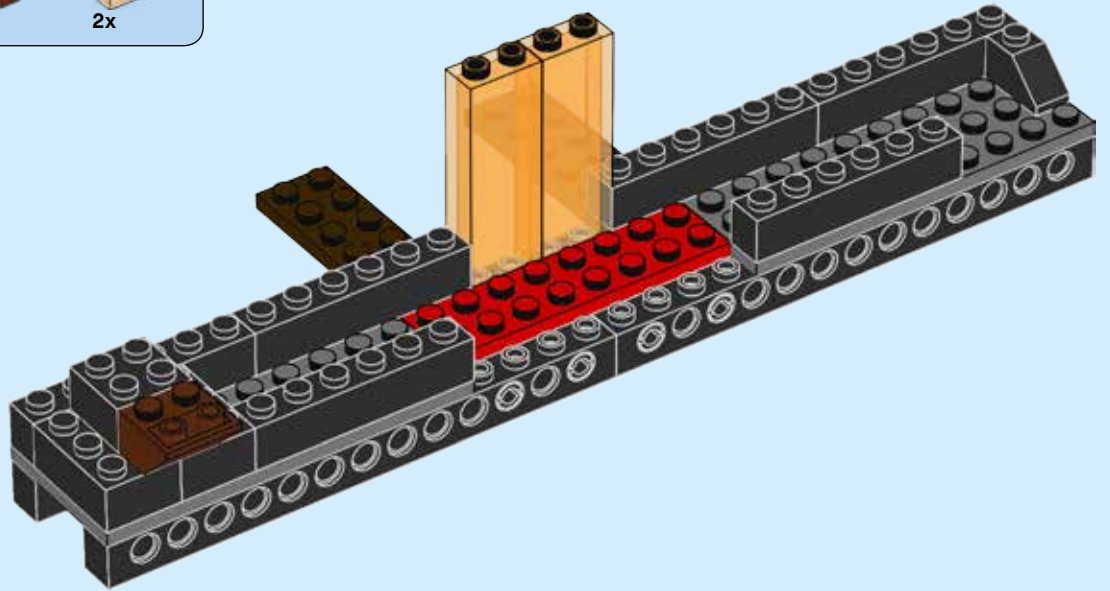

27

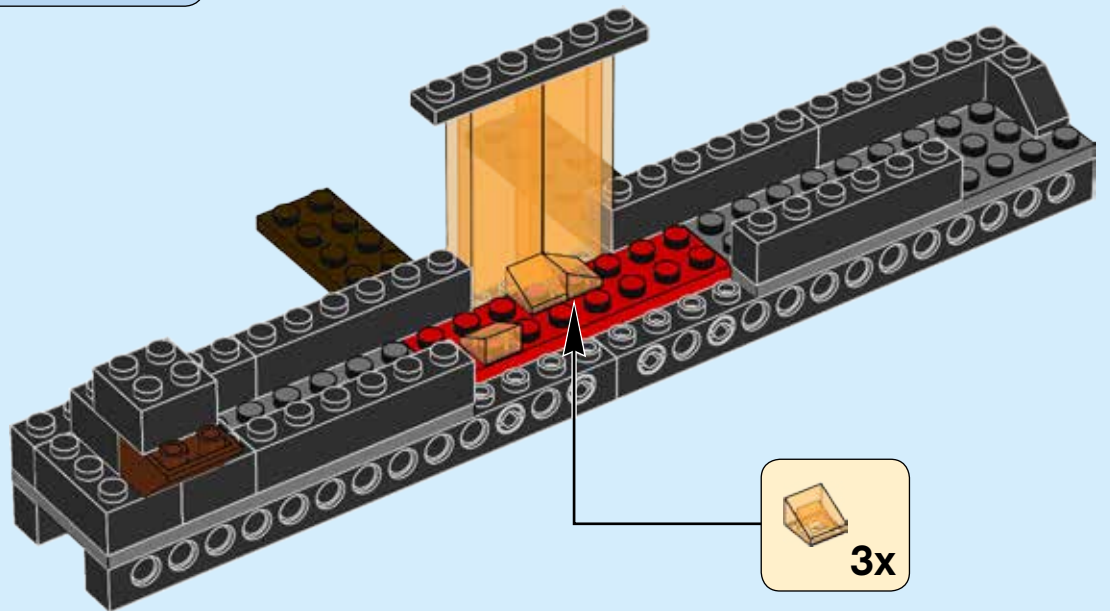



28

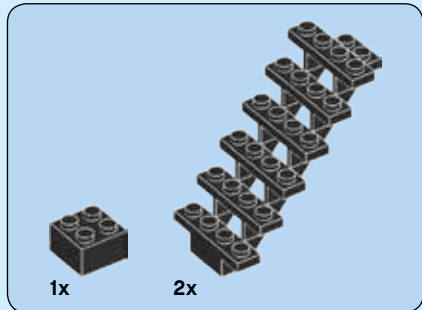
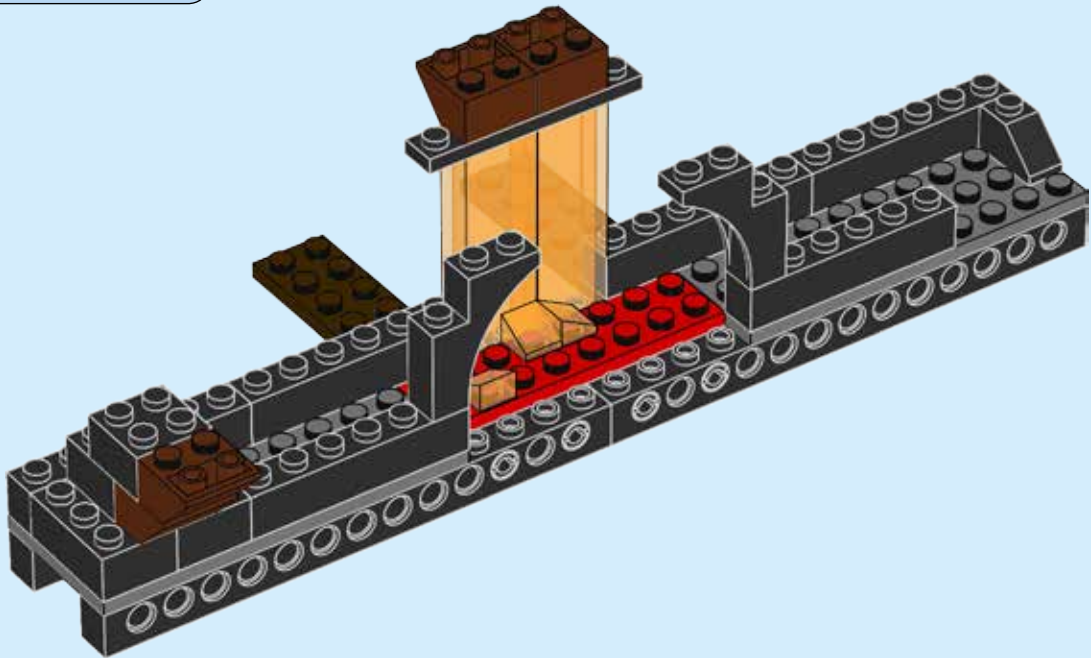

29

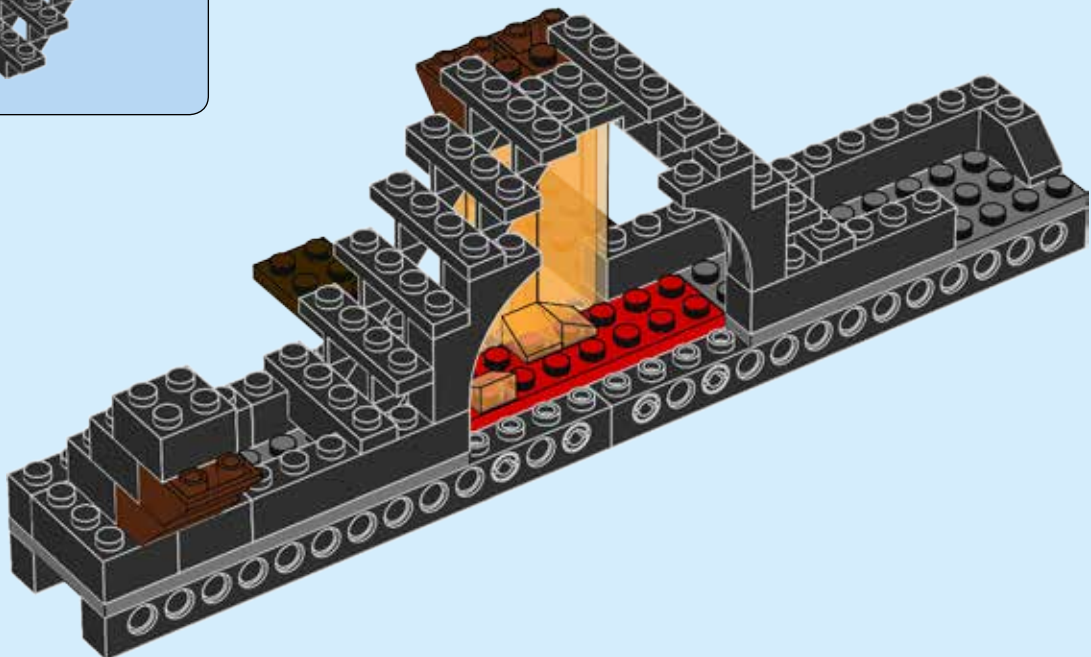

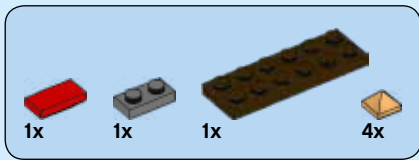

30

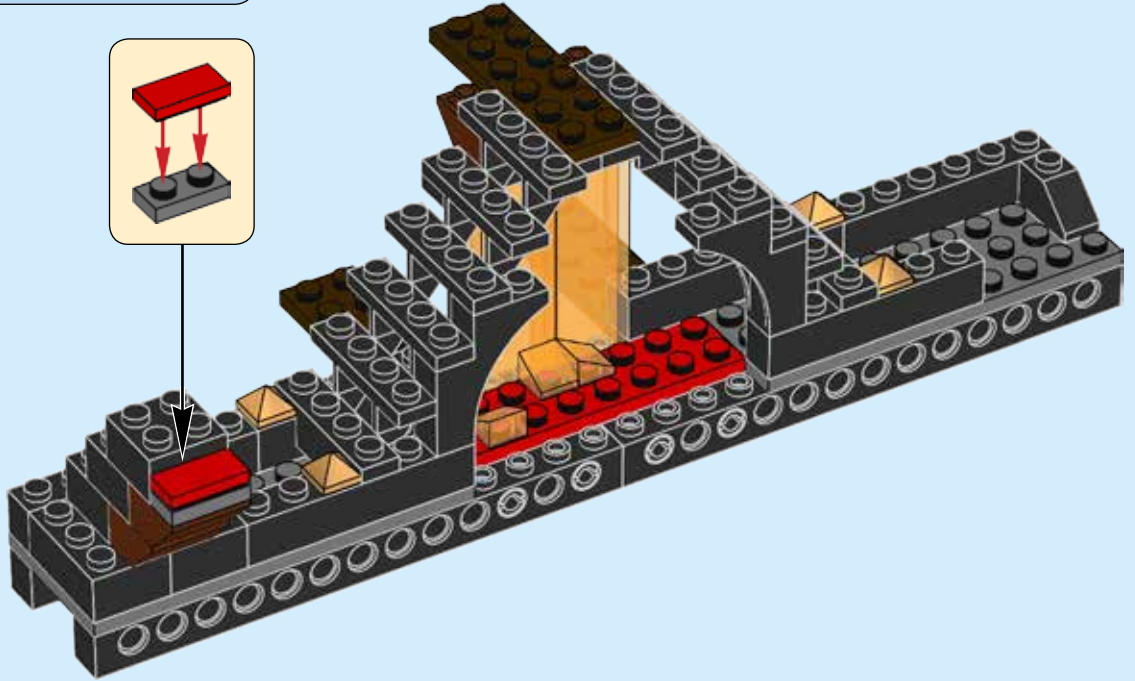
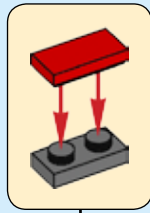

31

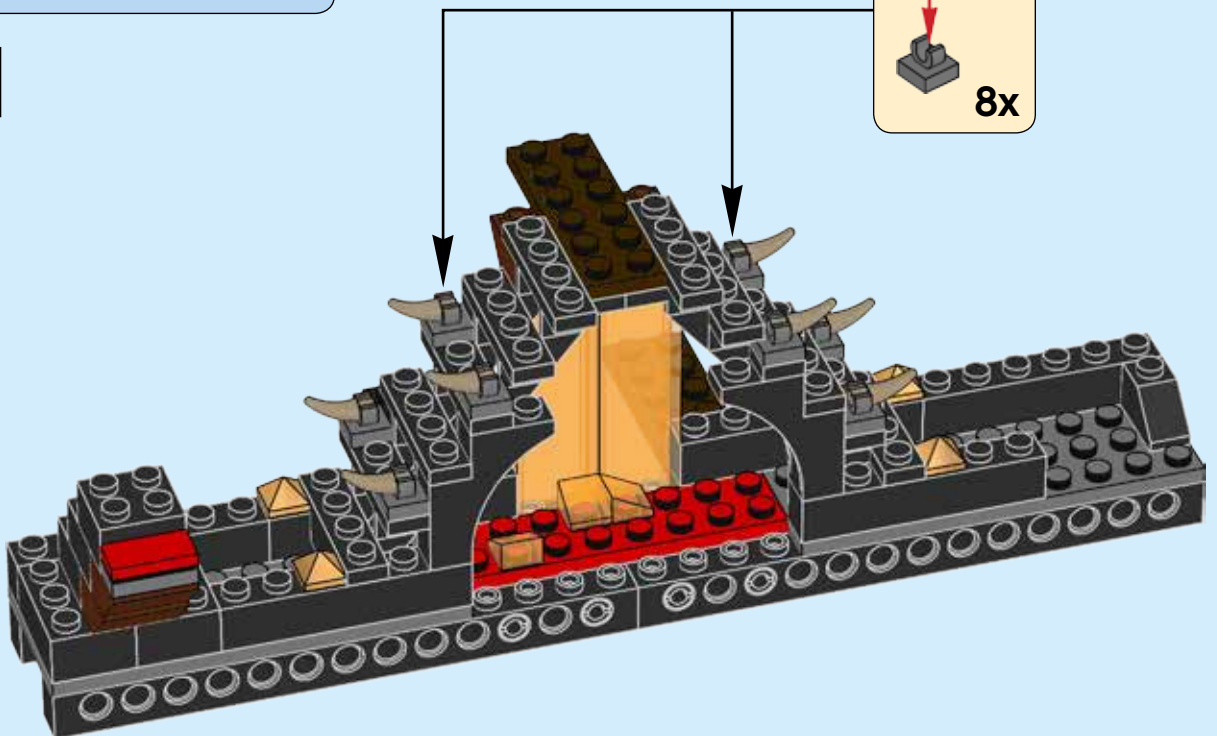
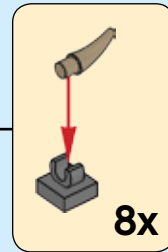

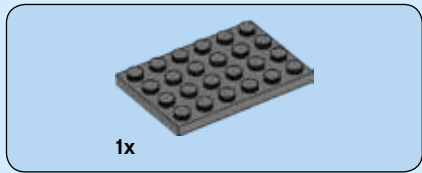

32

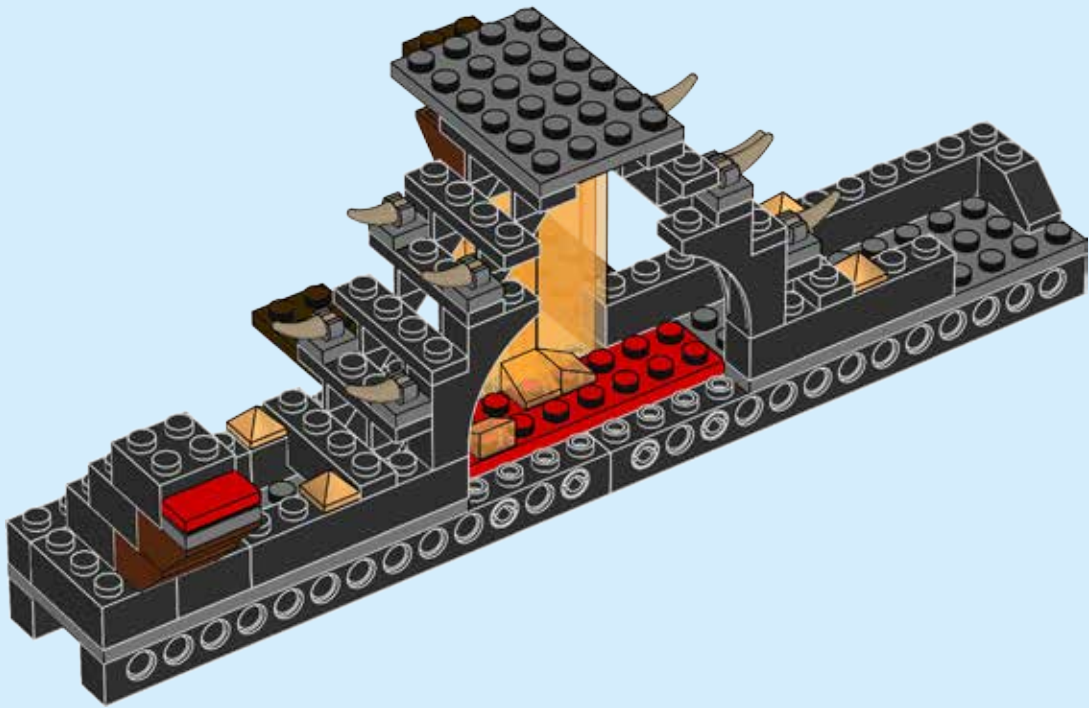

33

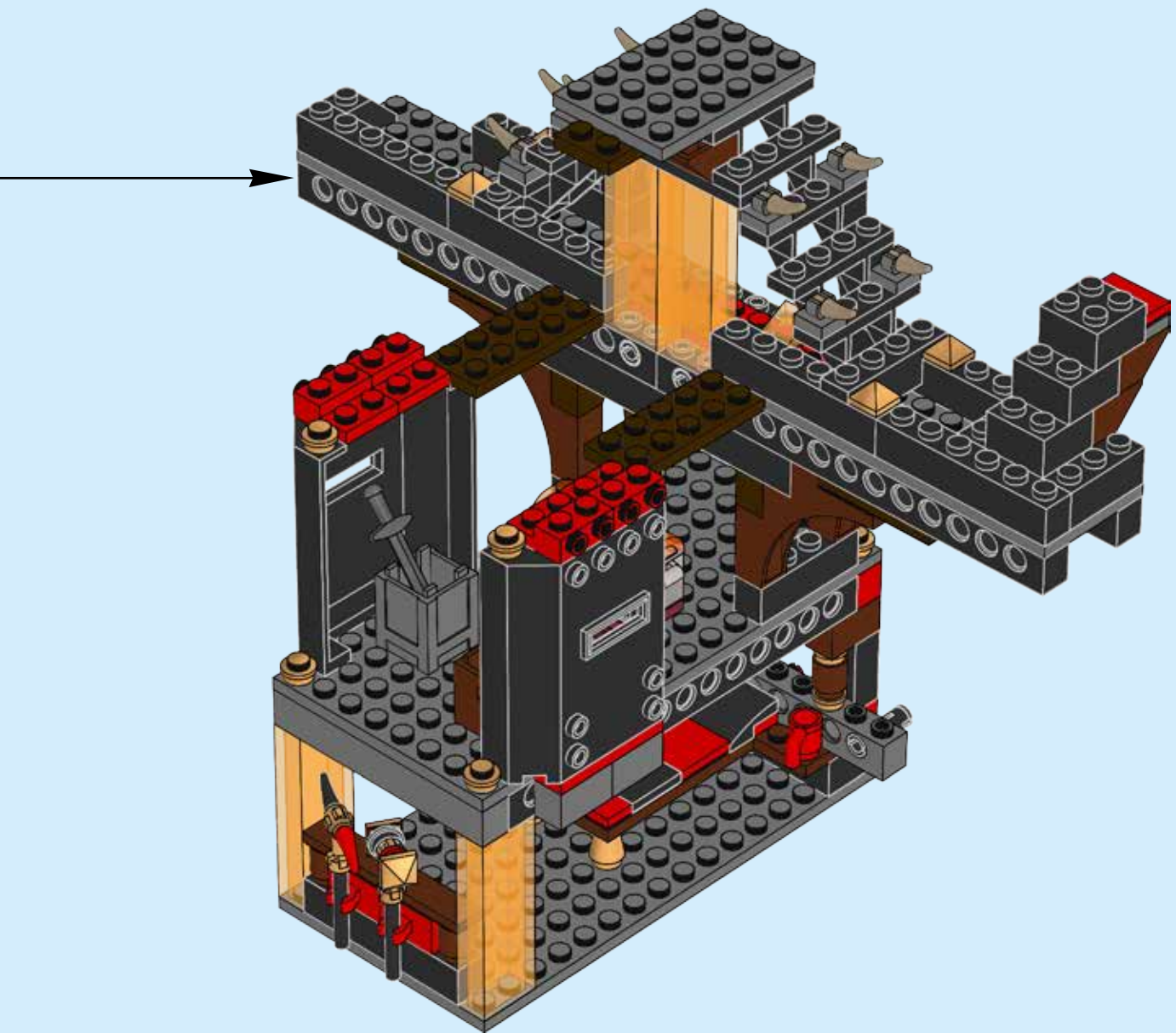

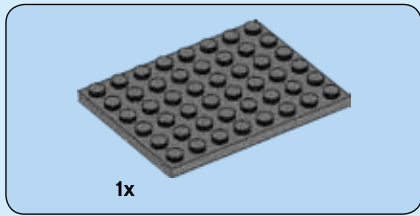

34

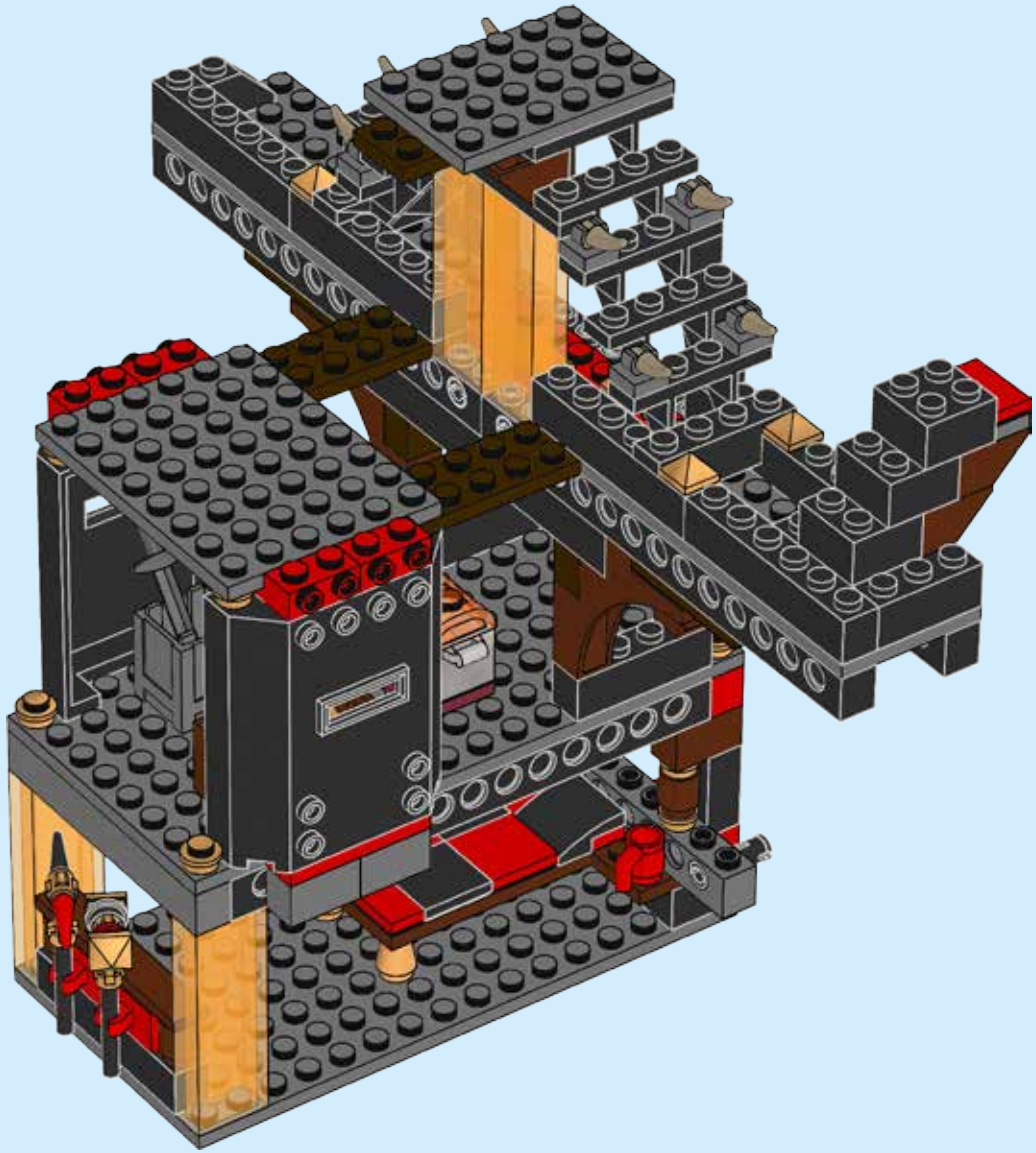

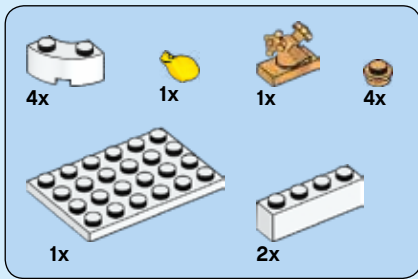

35

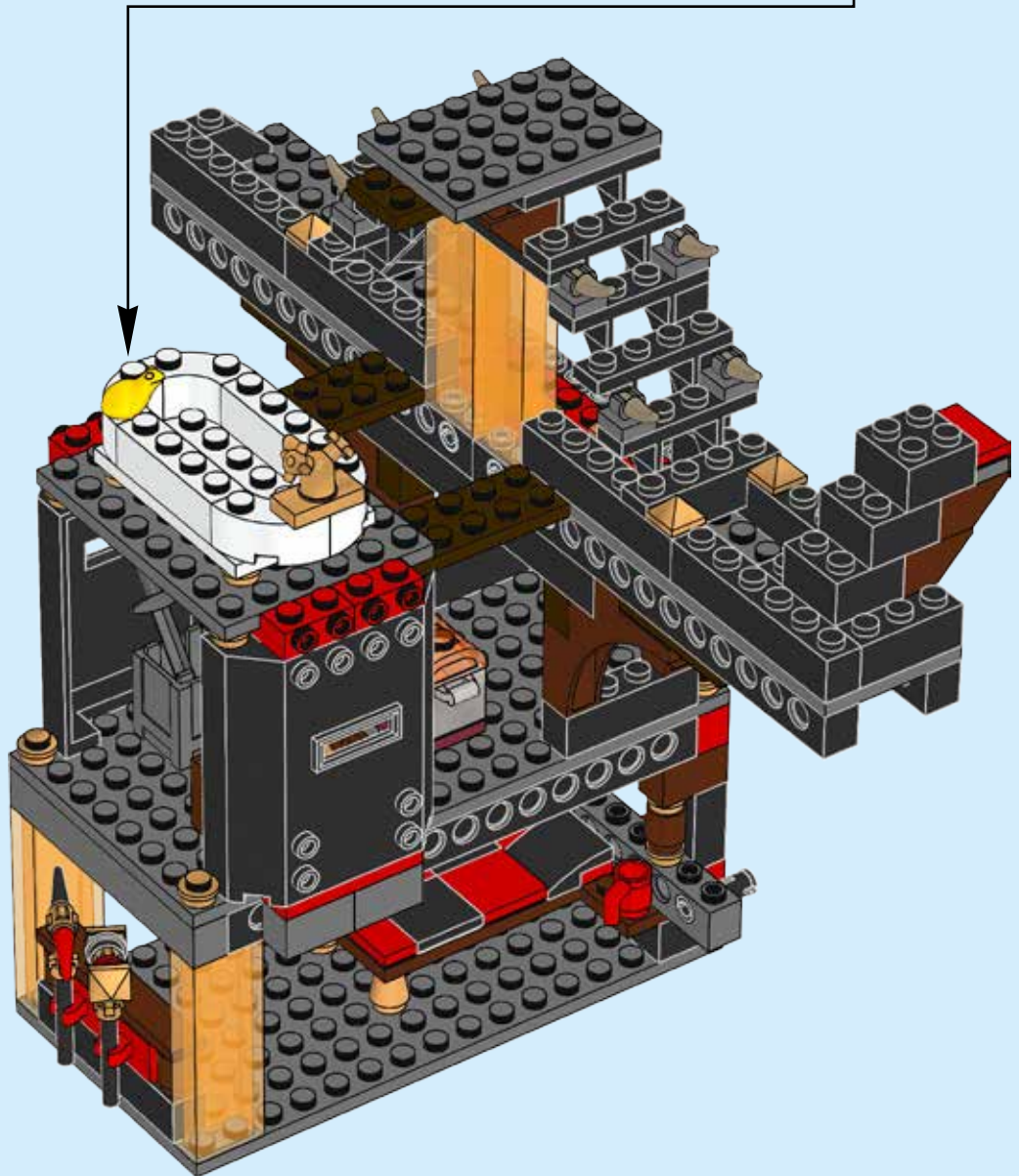
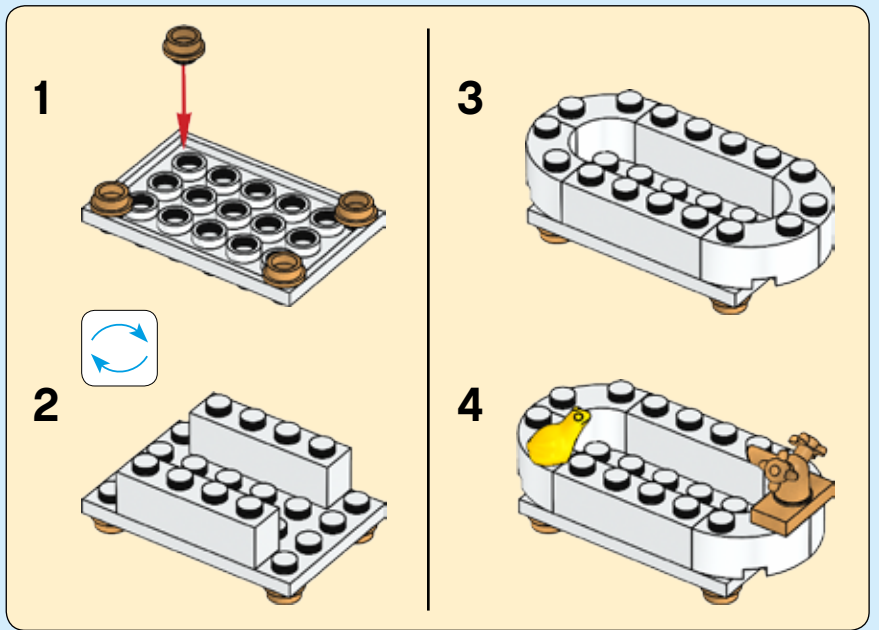

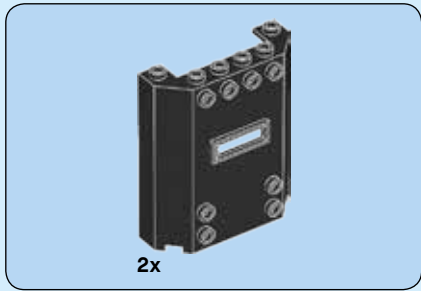

36

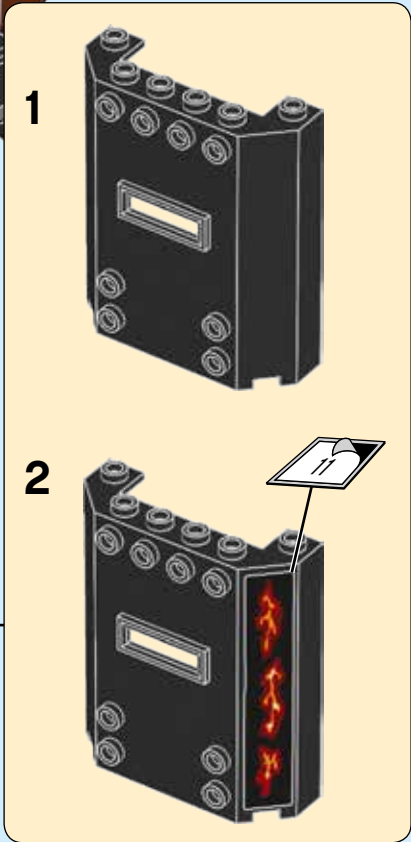
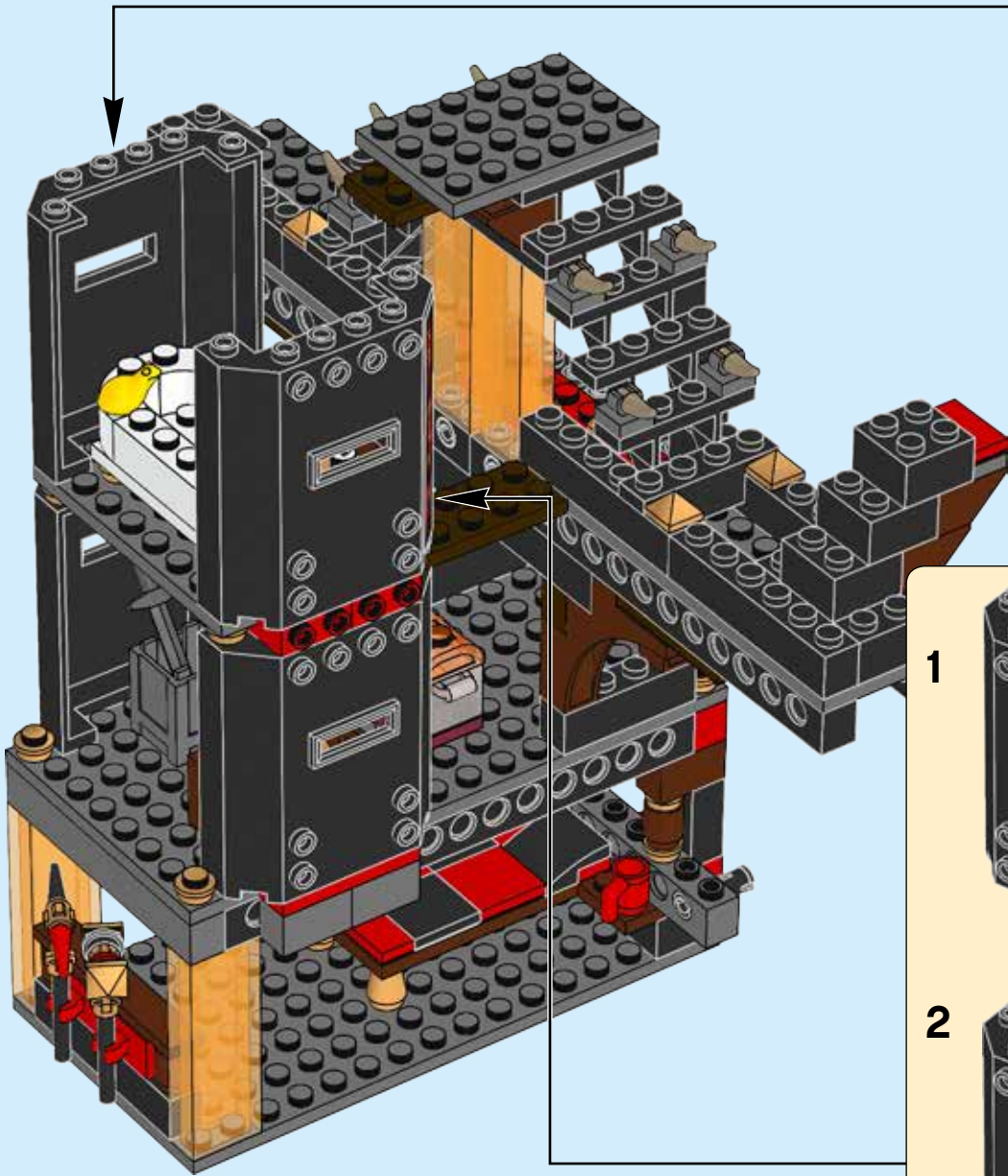
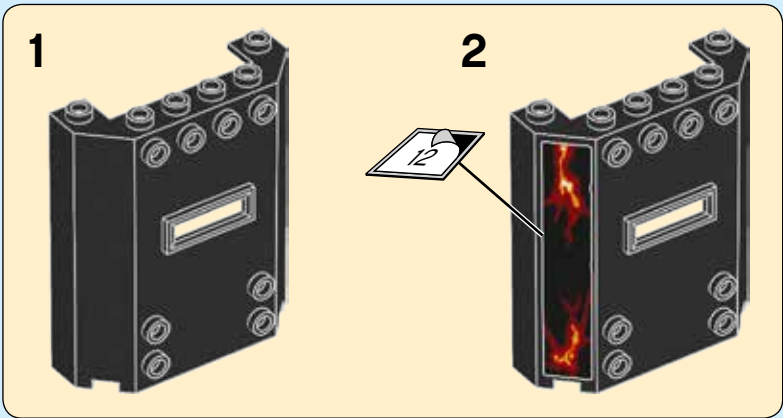

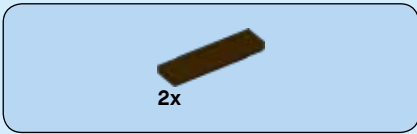

37

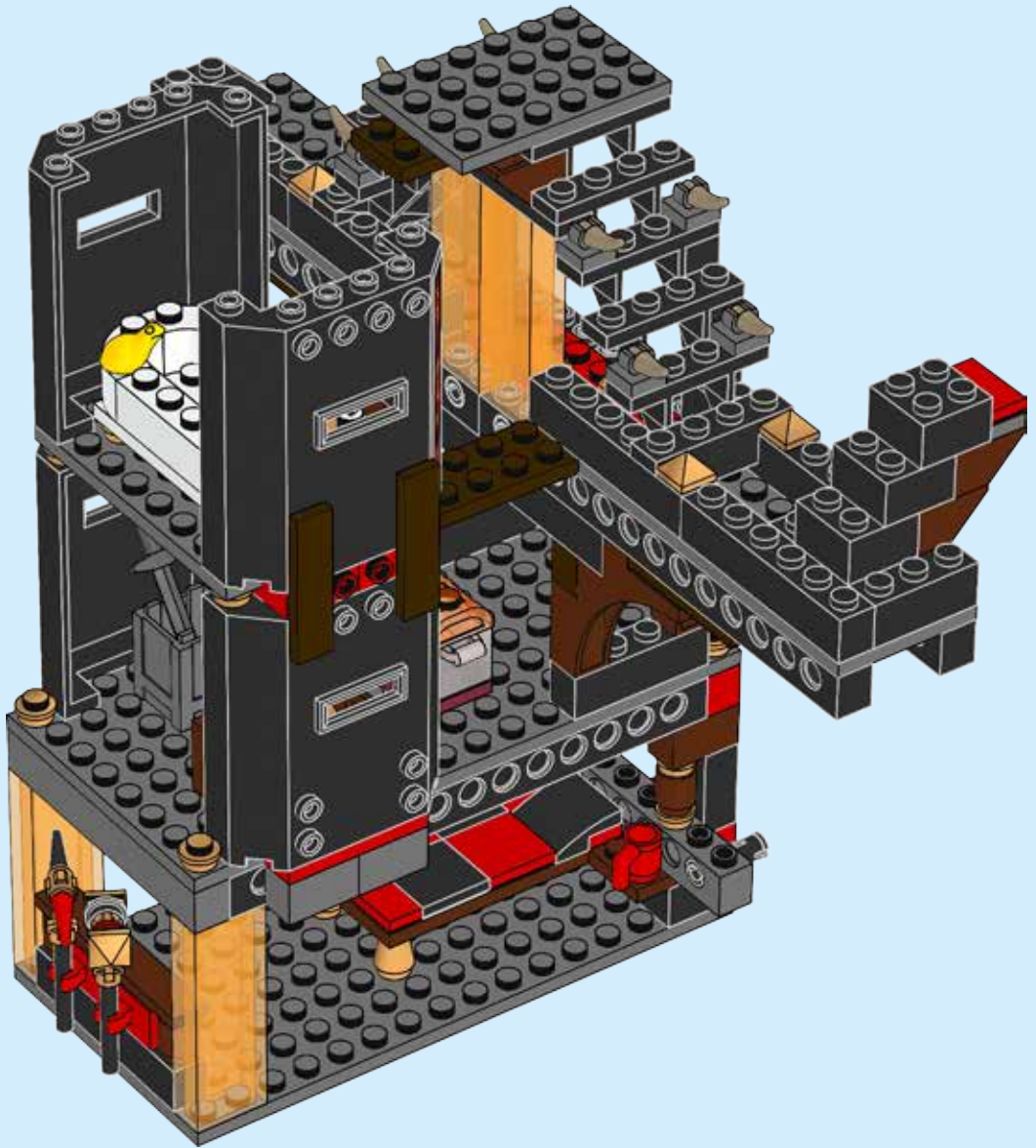

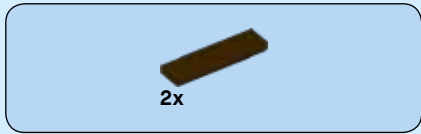

38

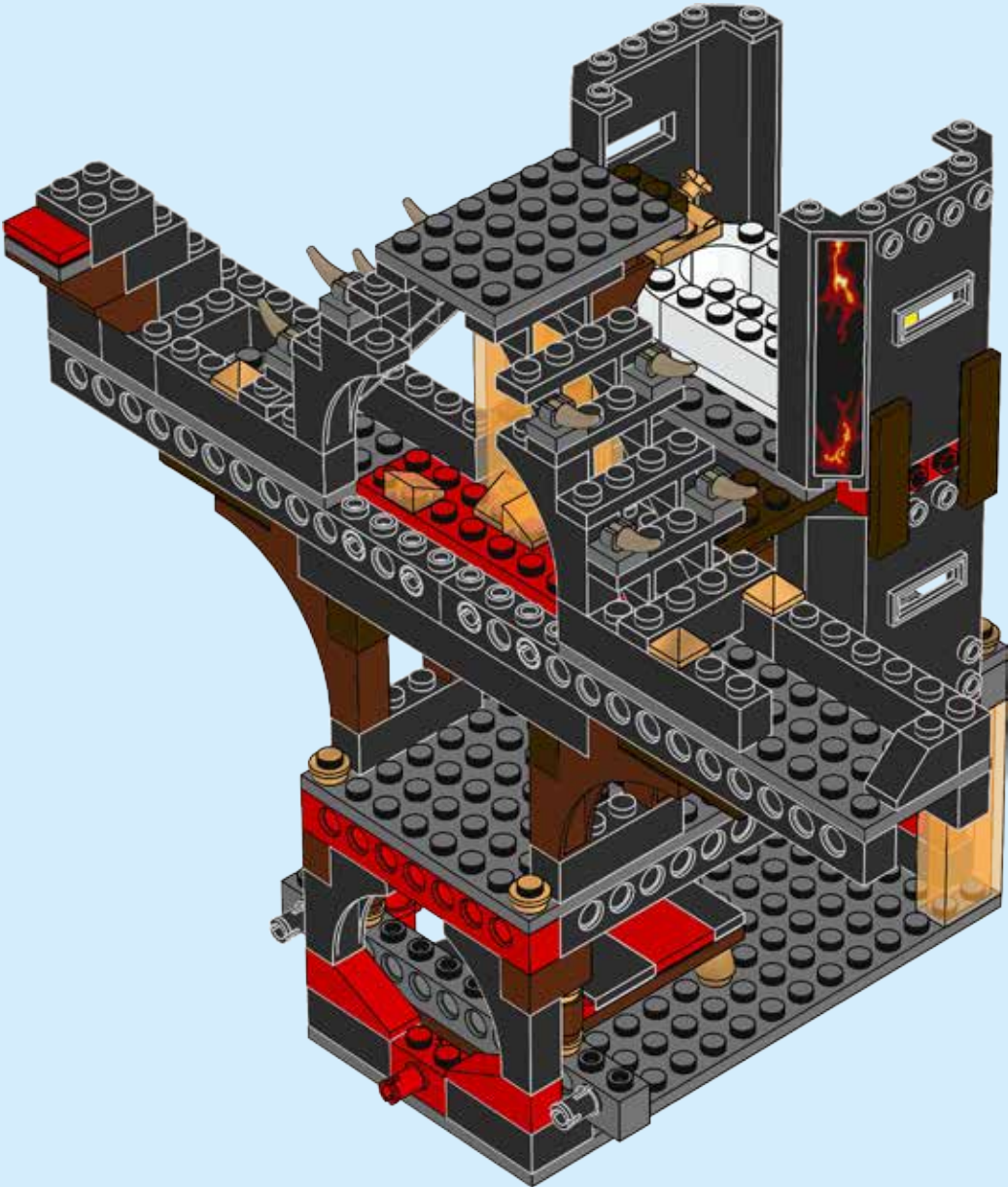
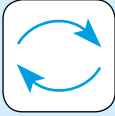



39

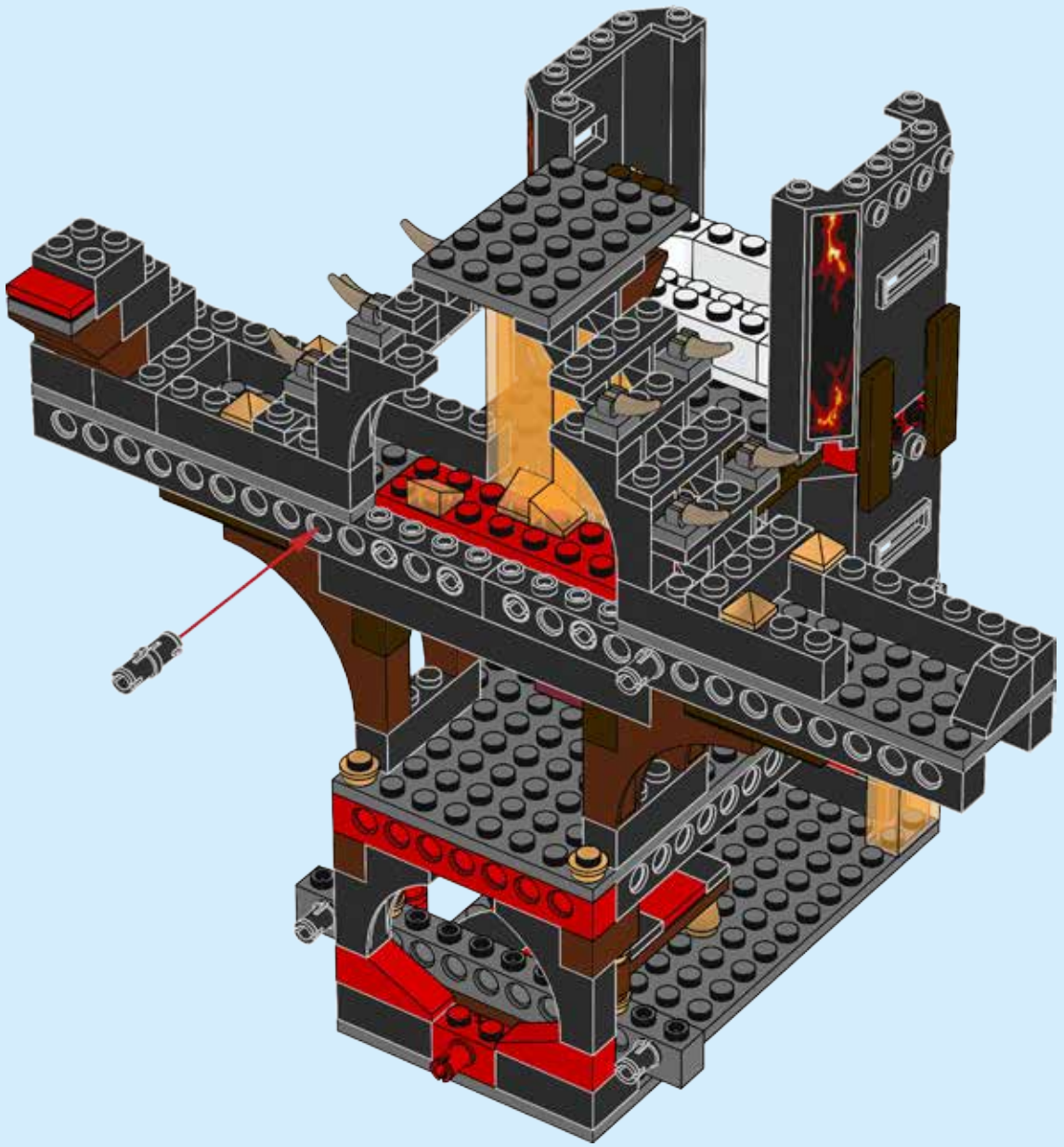

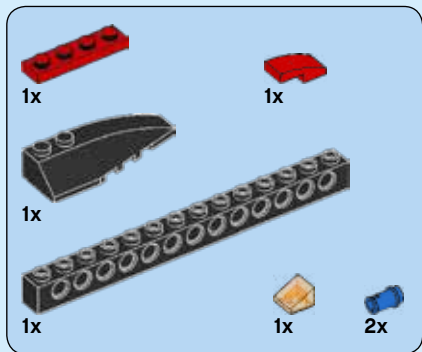

40

1

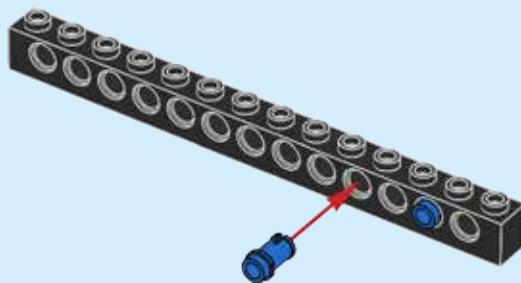

2

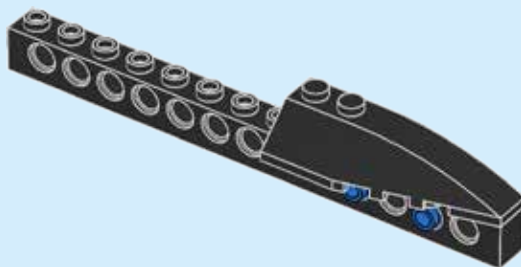

3

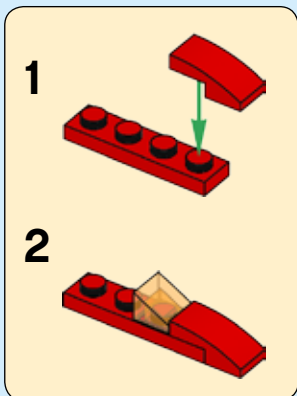
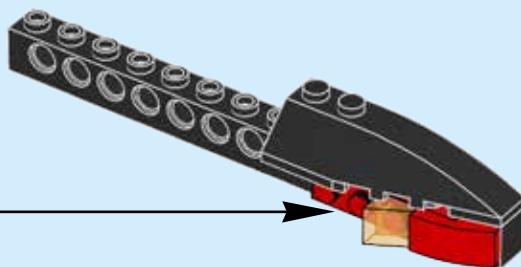

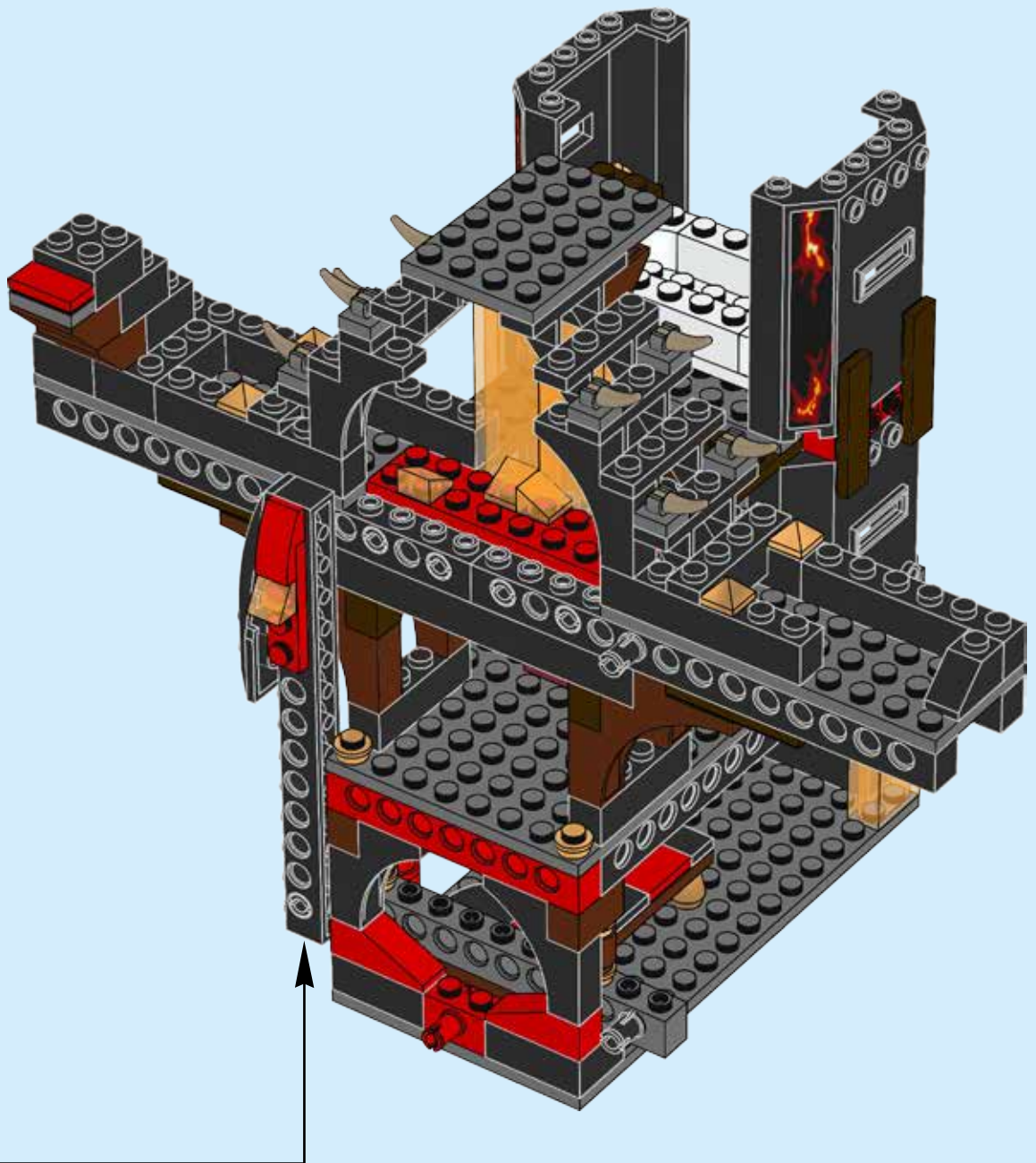

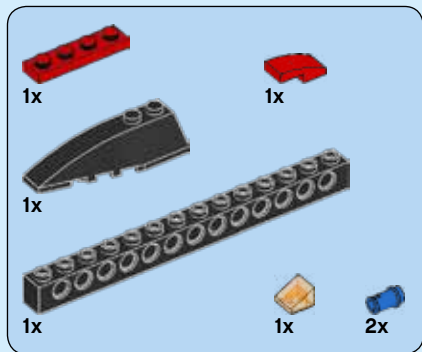

41

1

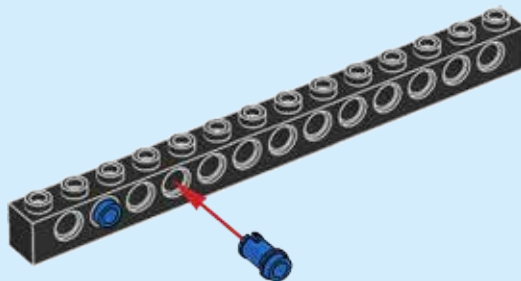

2

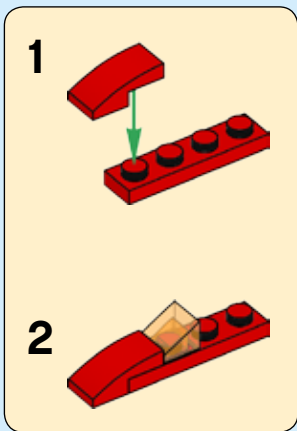
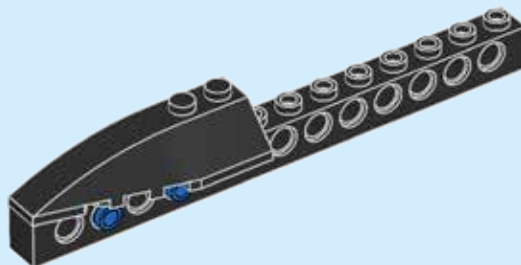

3

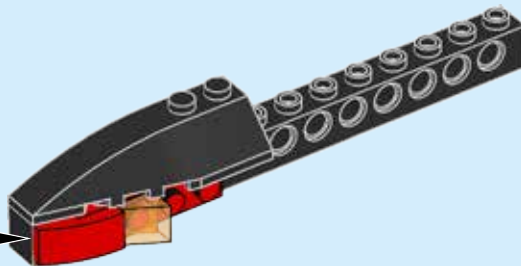

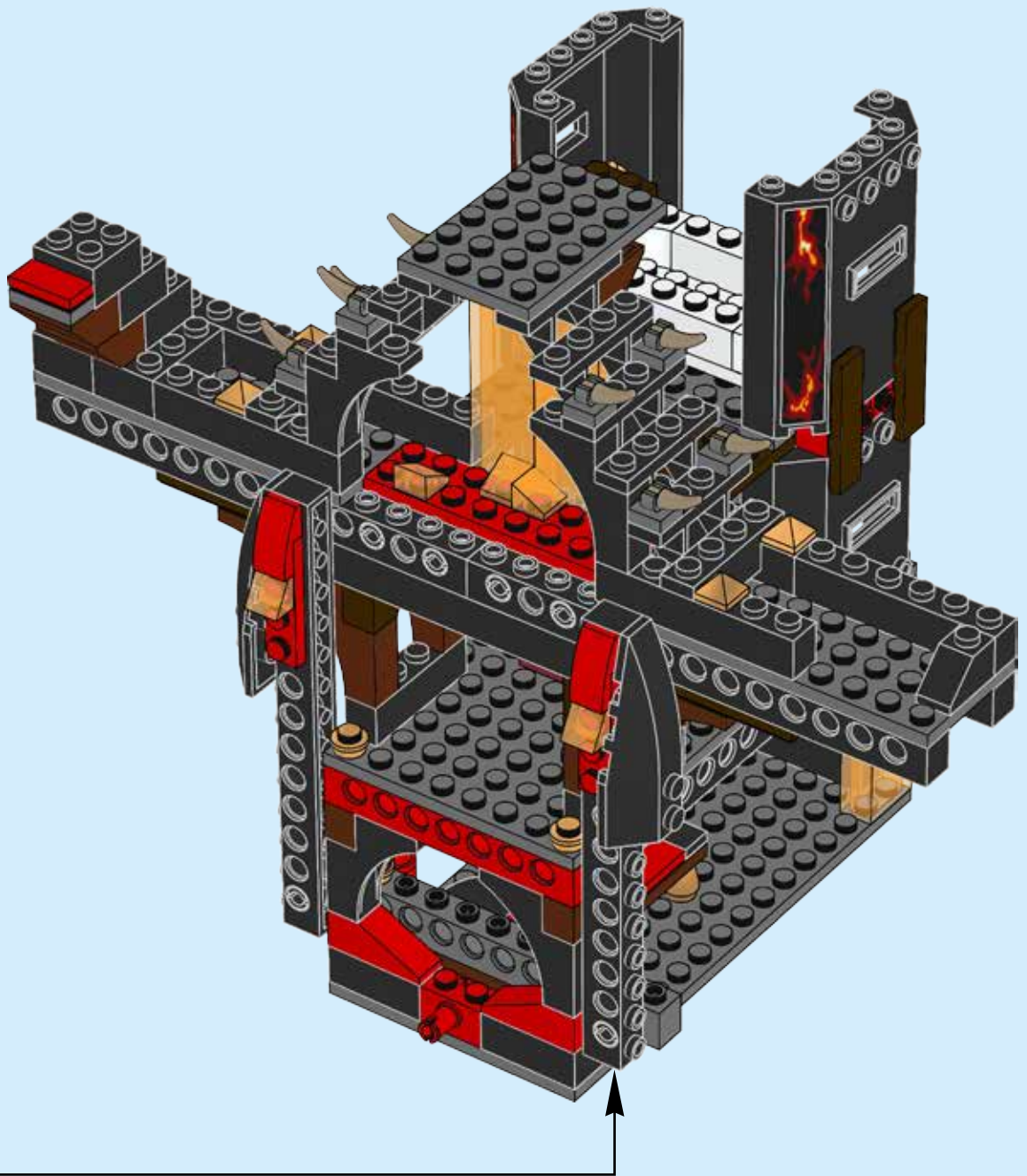

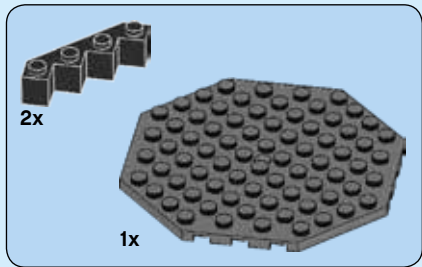
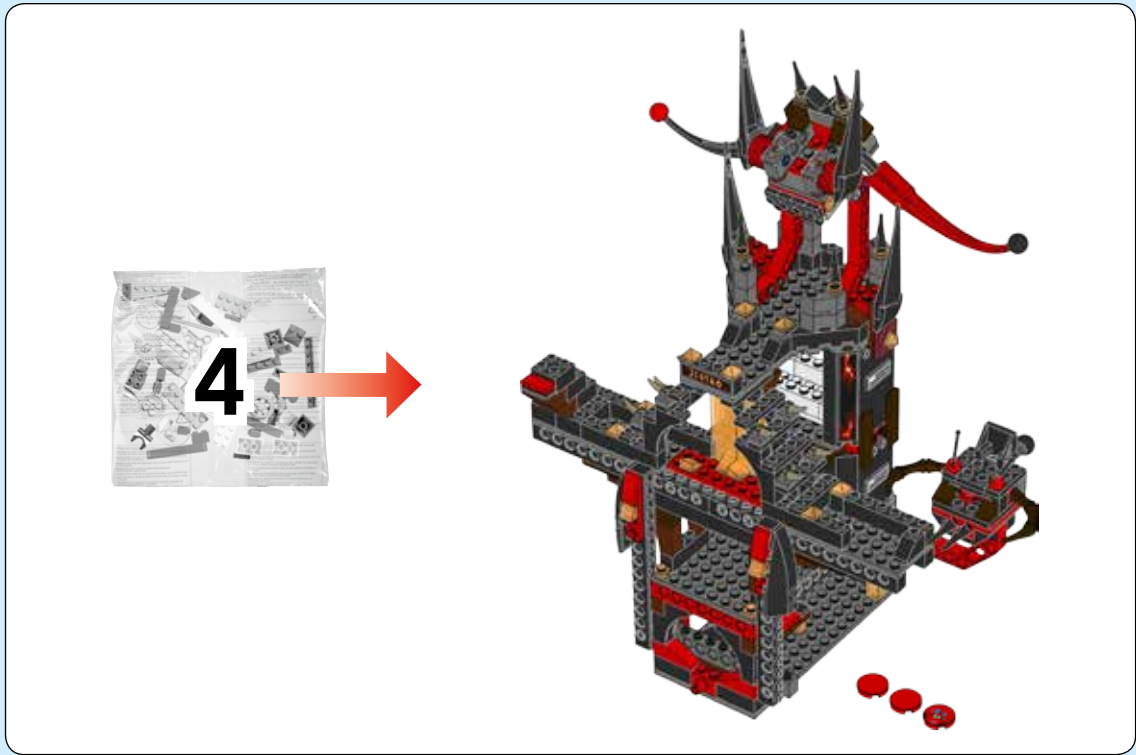

42

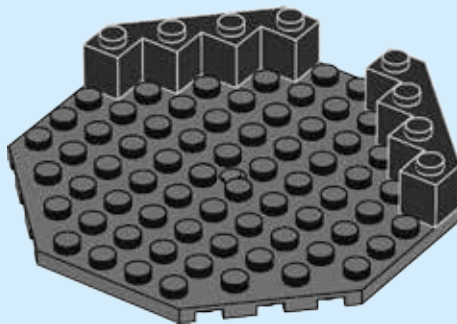

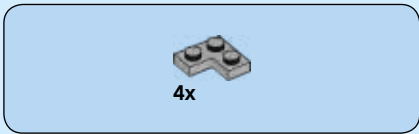

43

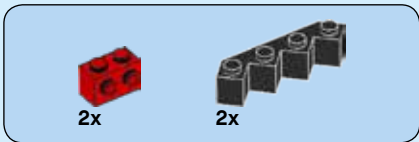
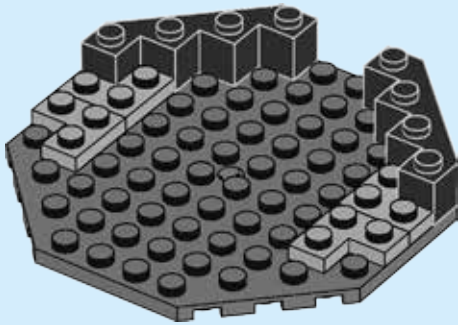

44

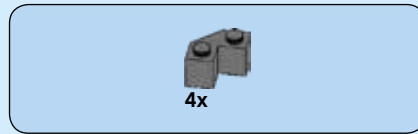
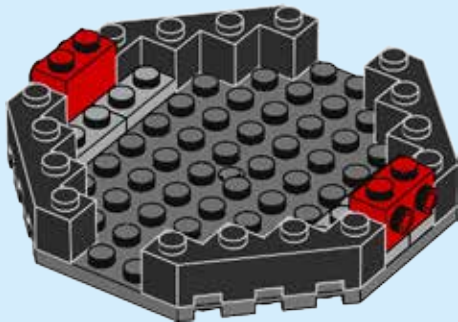

45

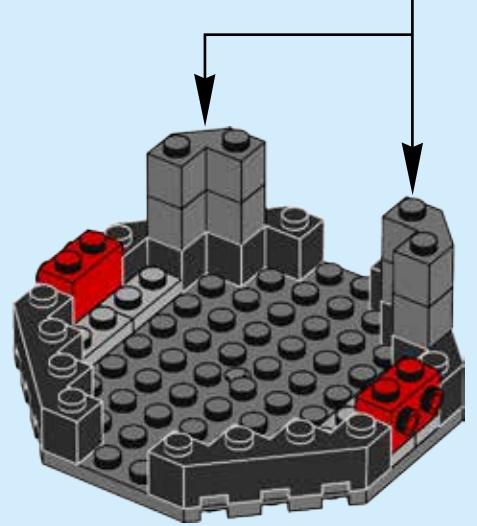
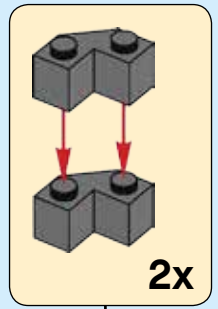

46

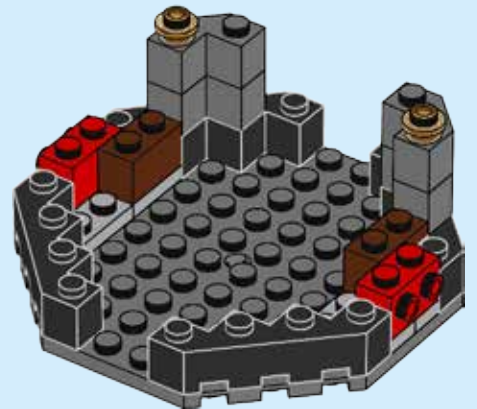

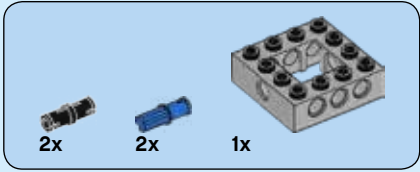
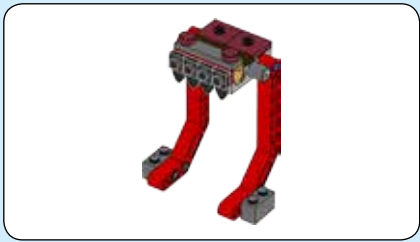

47

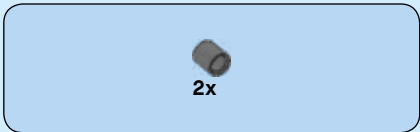
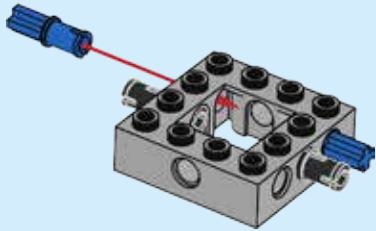

48

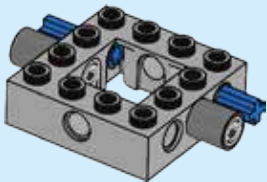

49

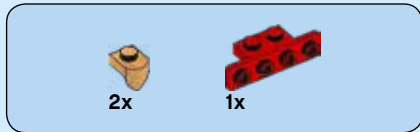
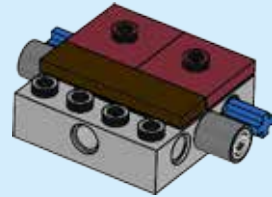

50

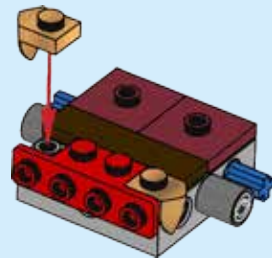

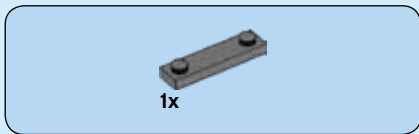

51

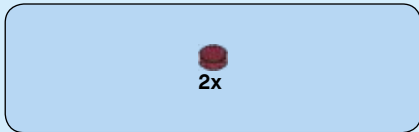
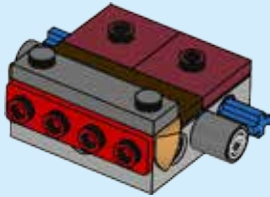

52

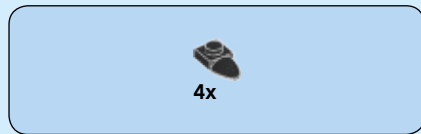
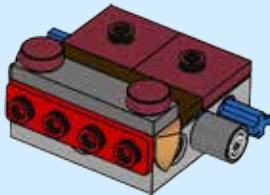

53

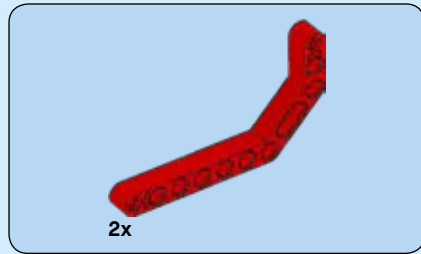
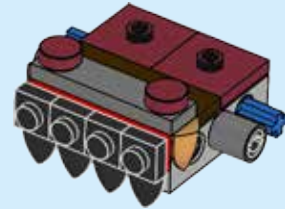

54

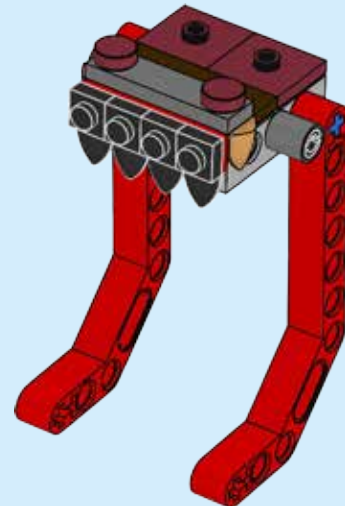



2x

55

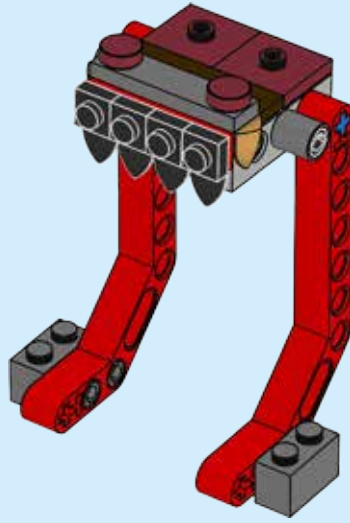

56

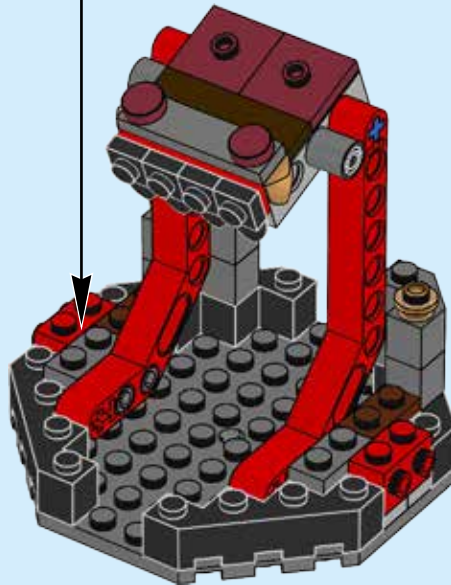



57

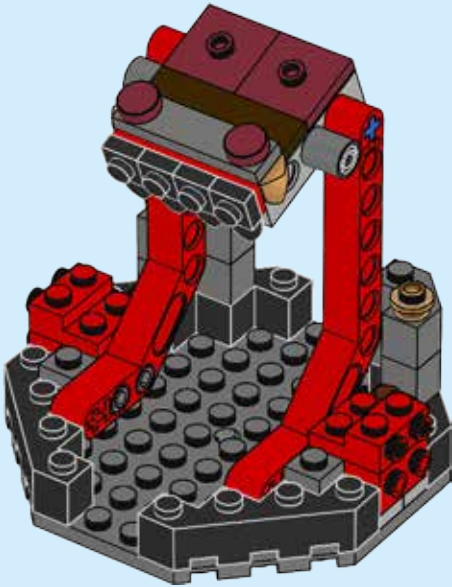

58

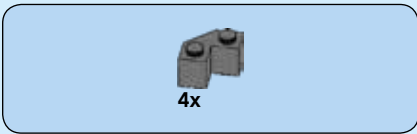
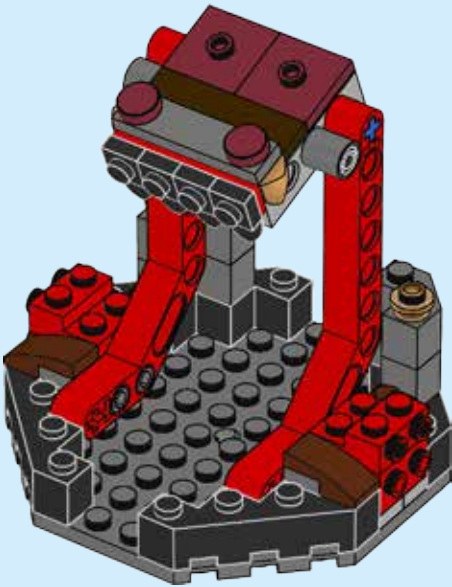

59

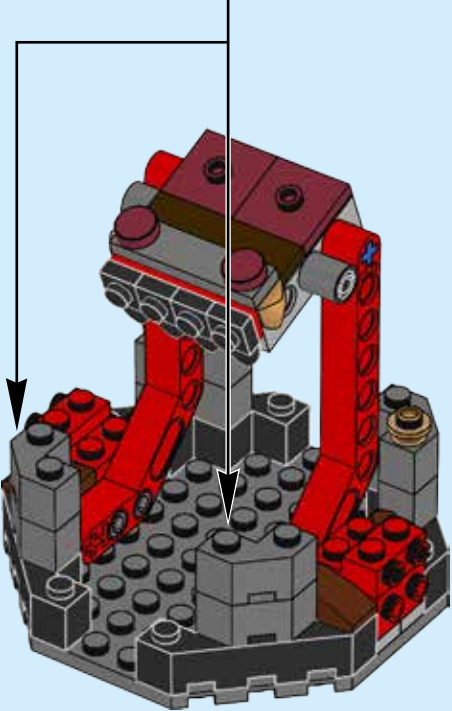
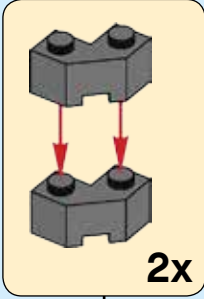



2x

60

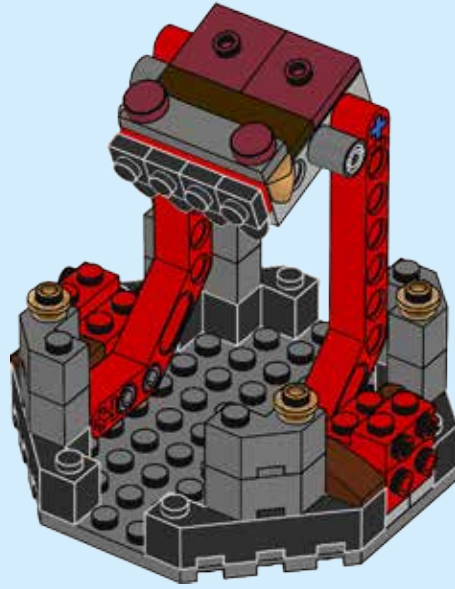

4x

61

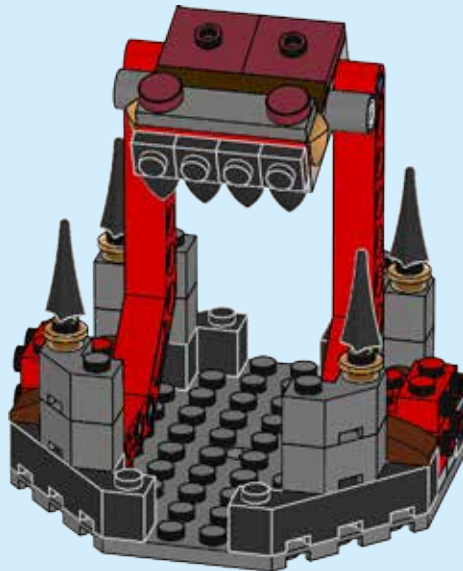

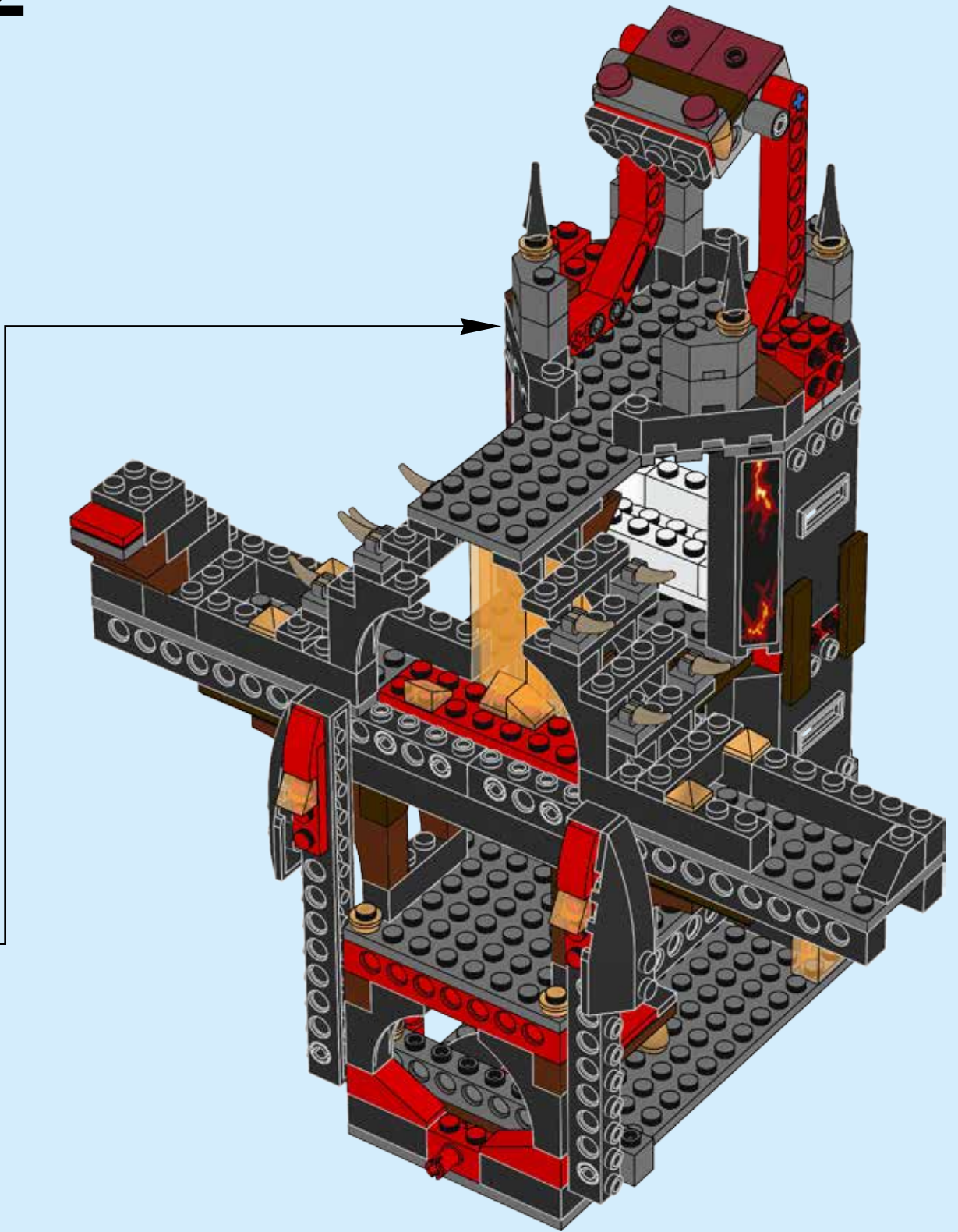

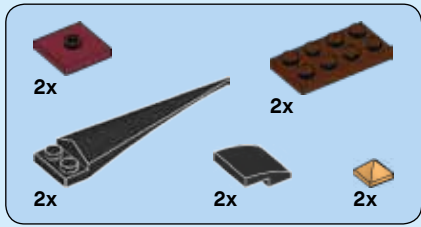

63

1

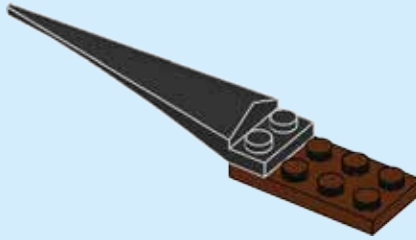

2

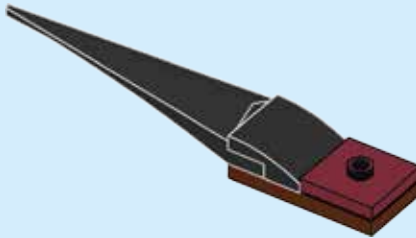

3

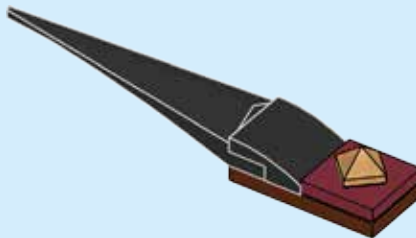

2x

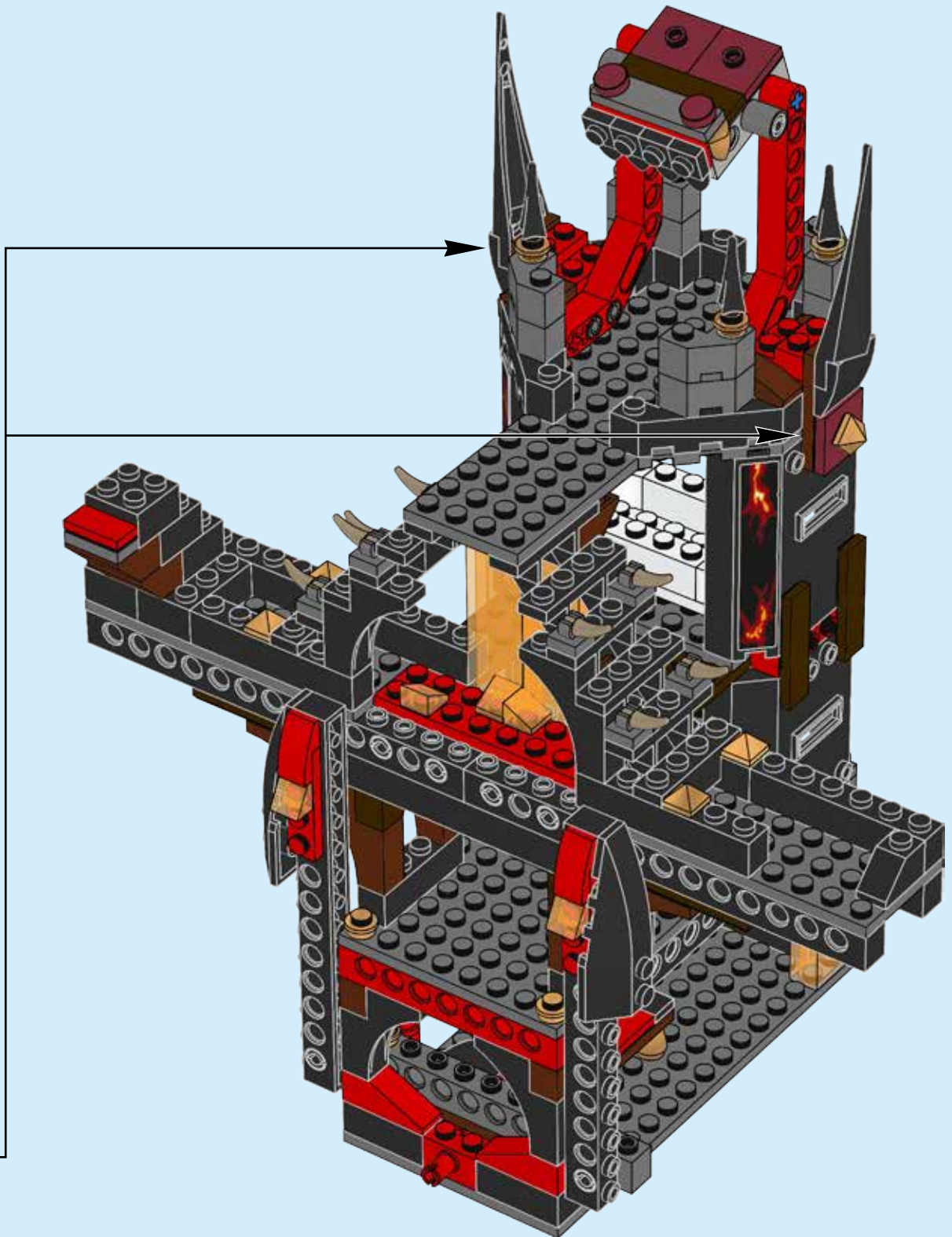



64

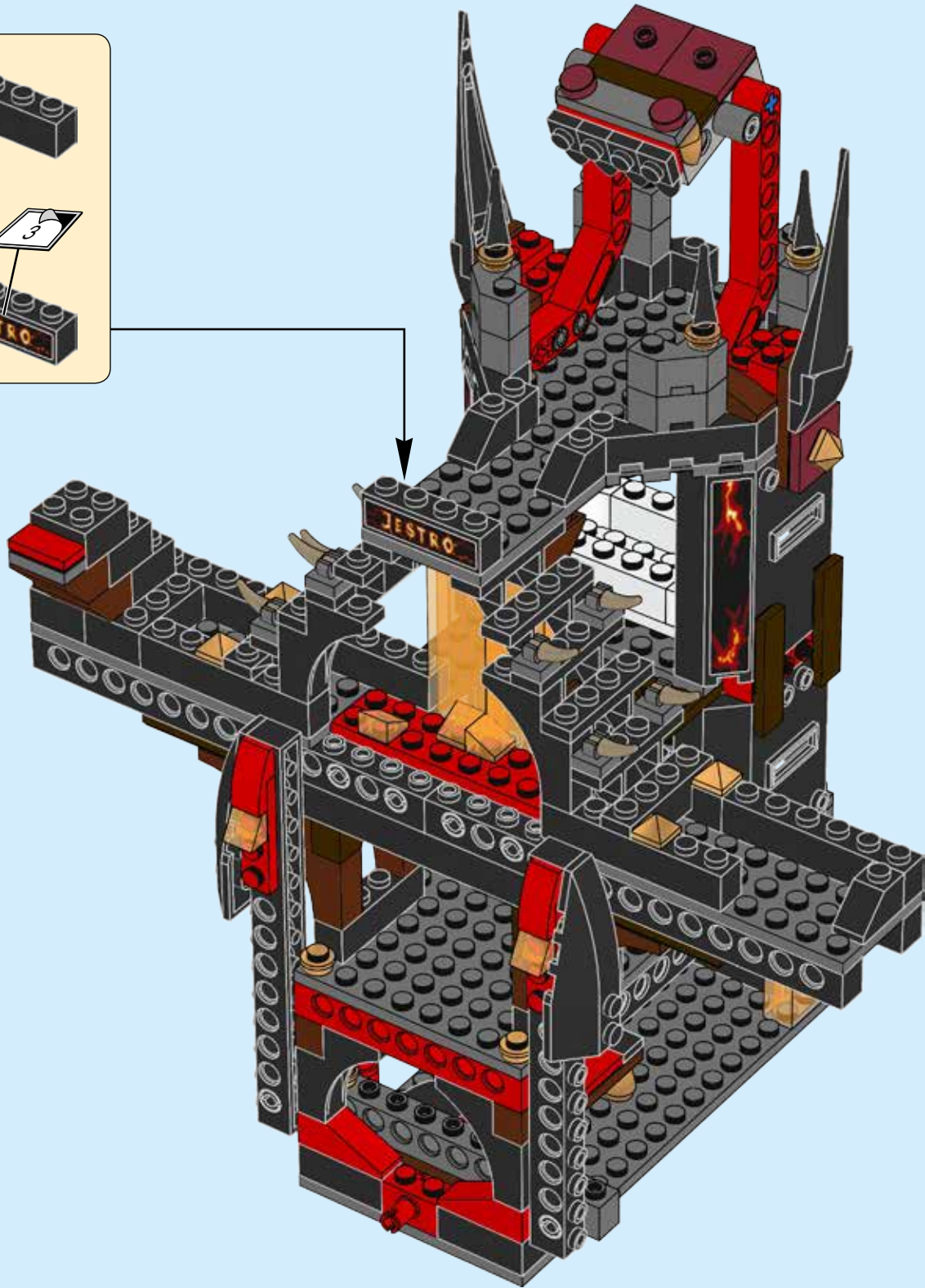
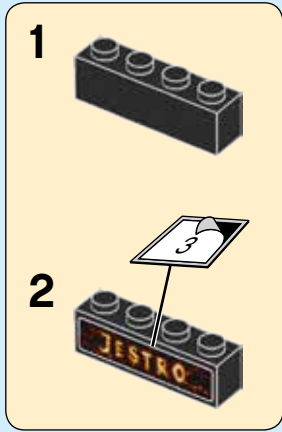

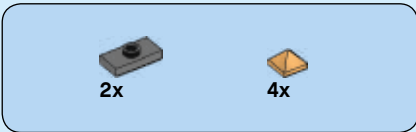

65

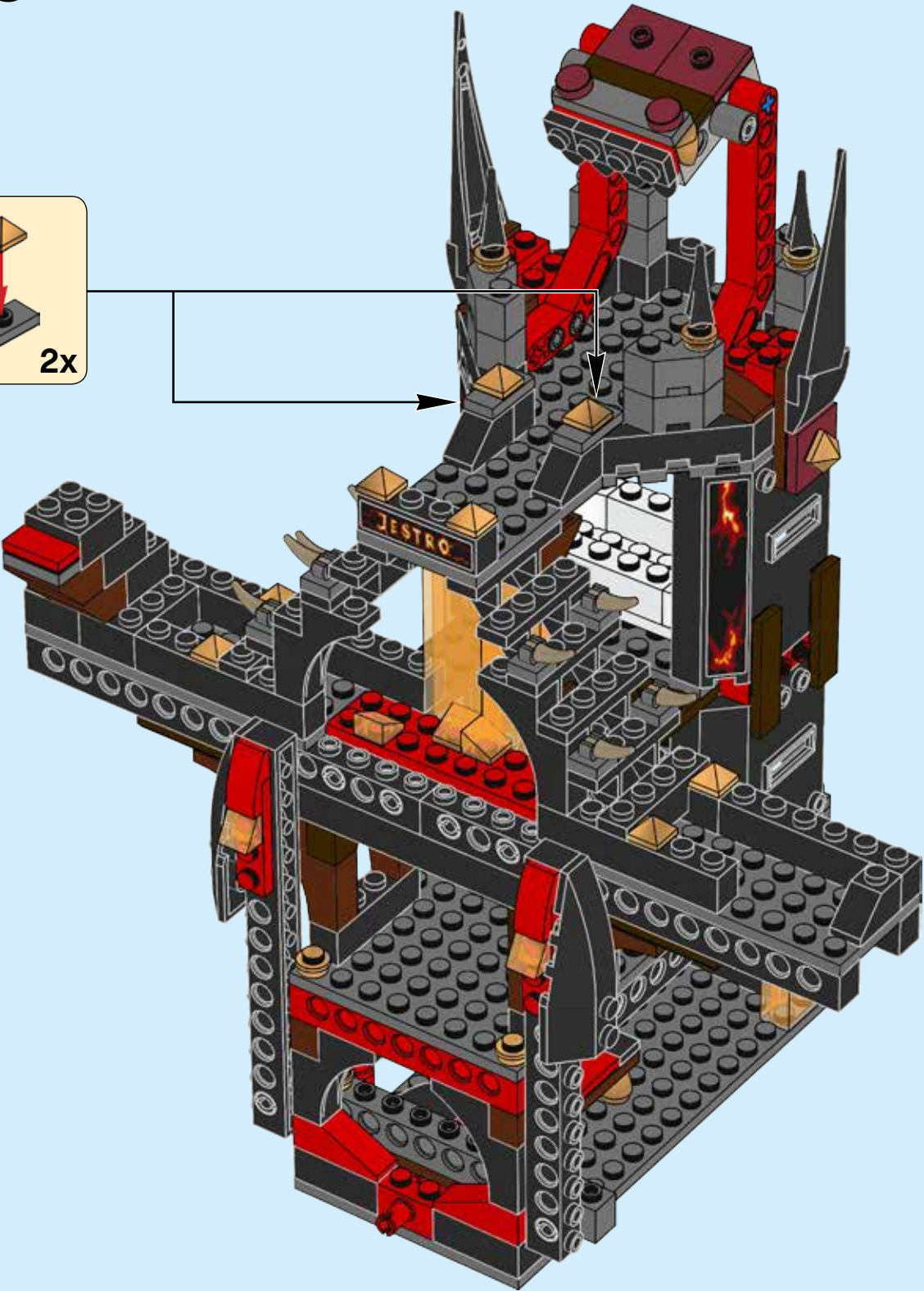
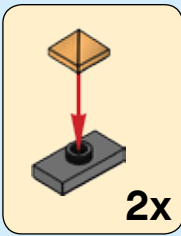

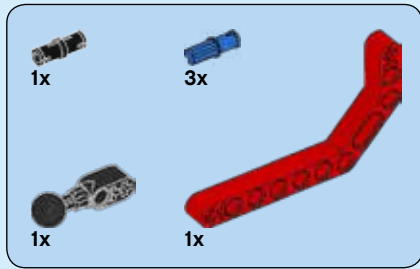

66

1

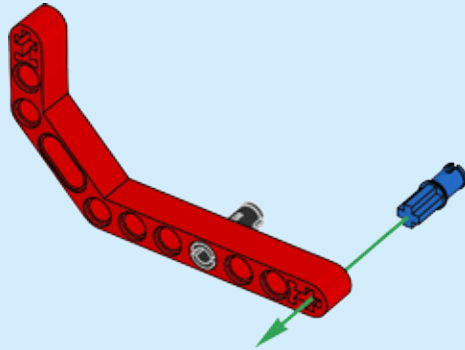

2

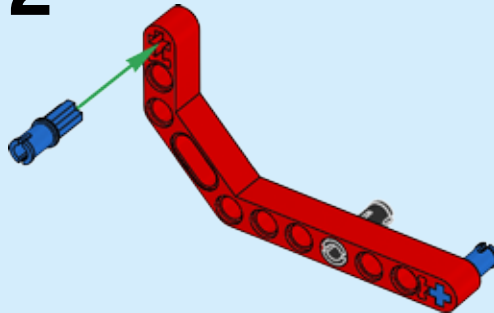

3

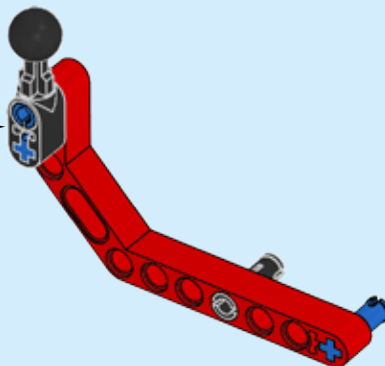
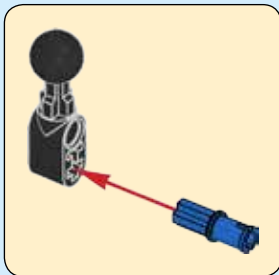

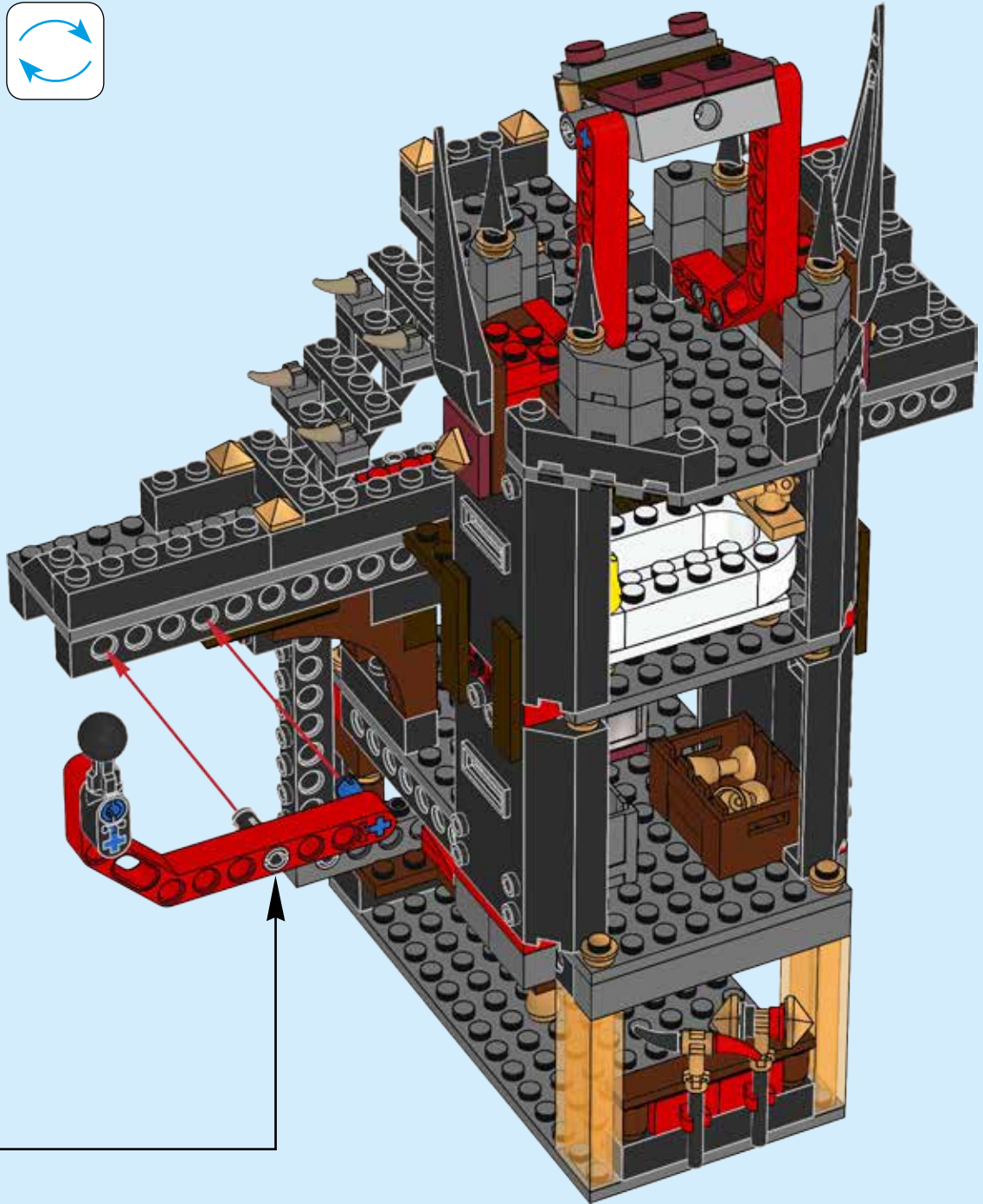
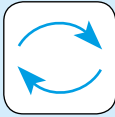

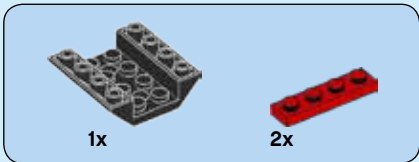

67

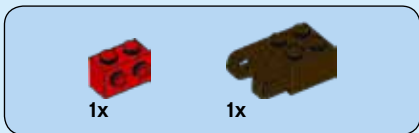
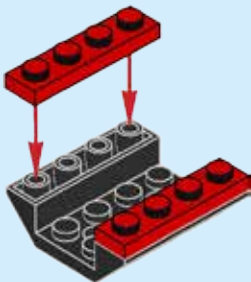

68

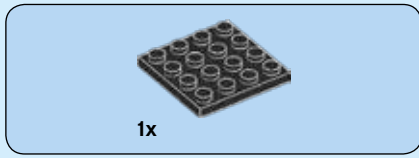

69

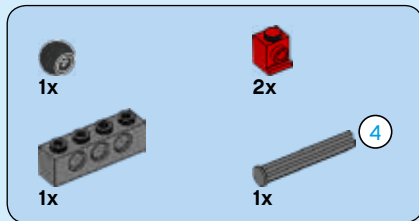
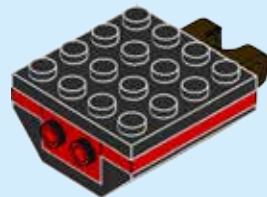

70

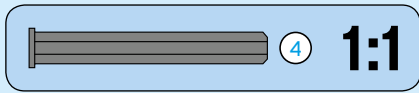
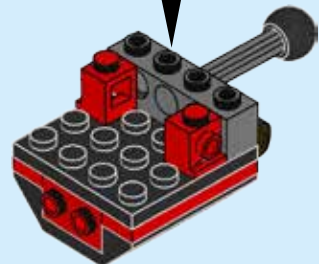
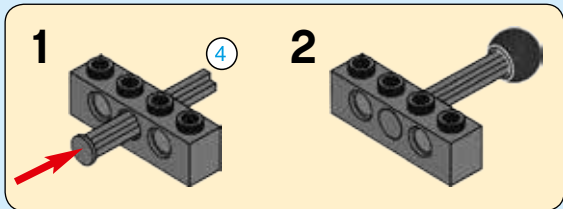
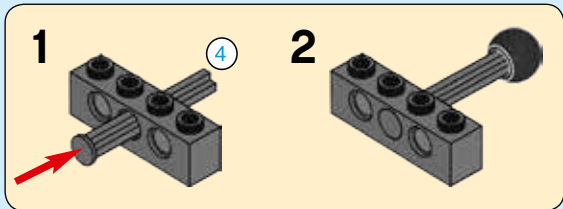

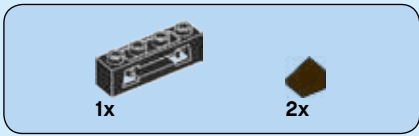

71

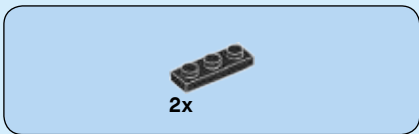
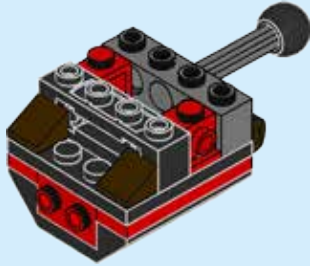

72

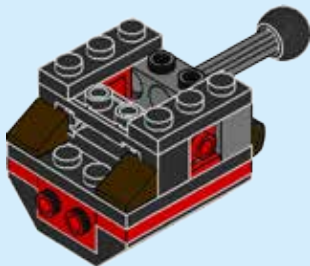

73

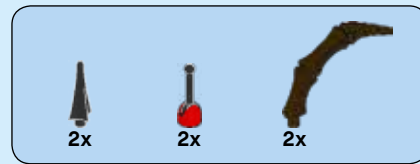
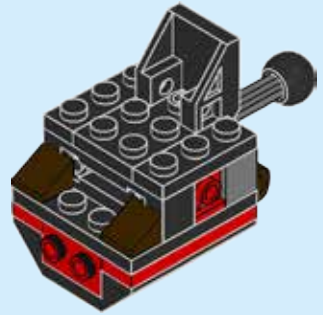

74

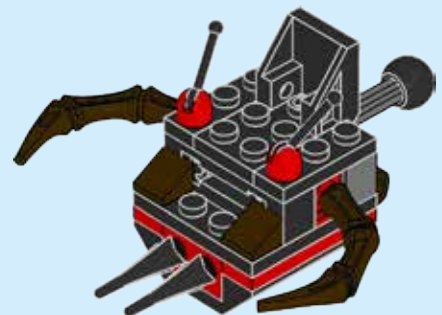

75

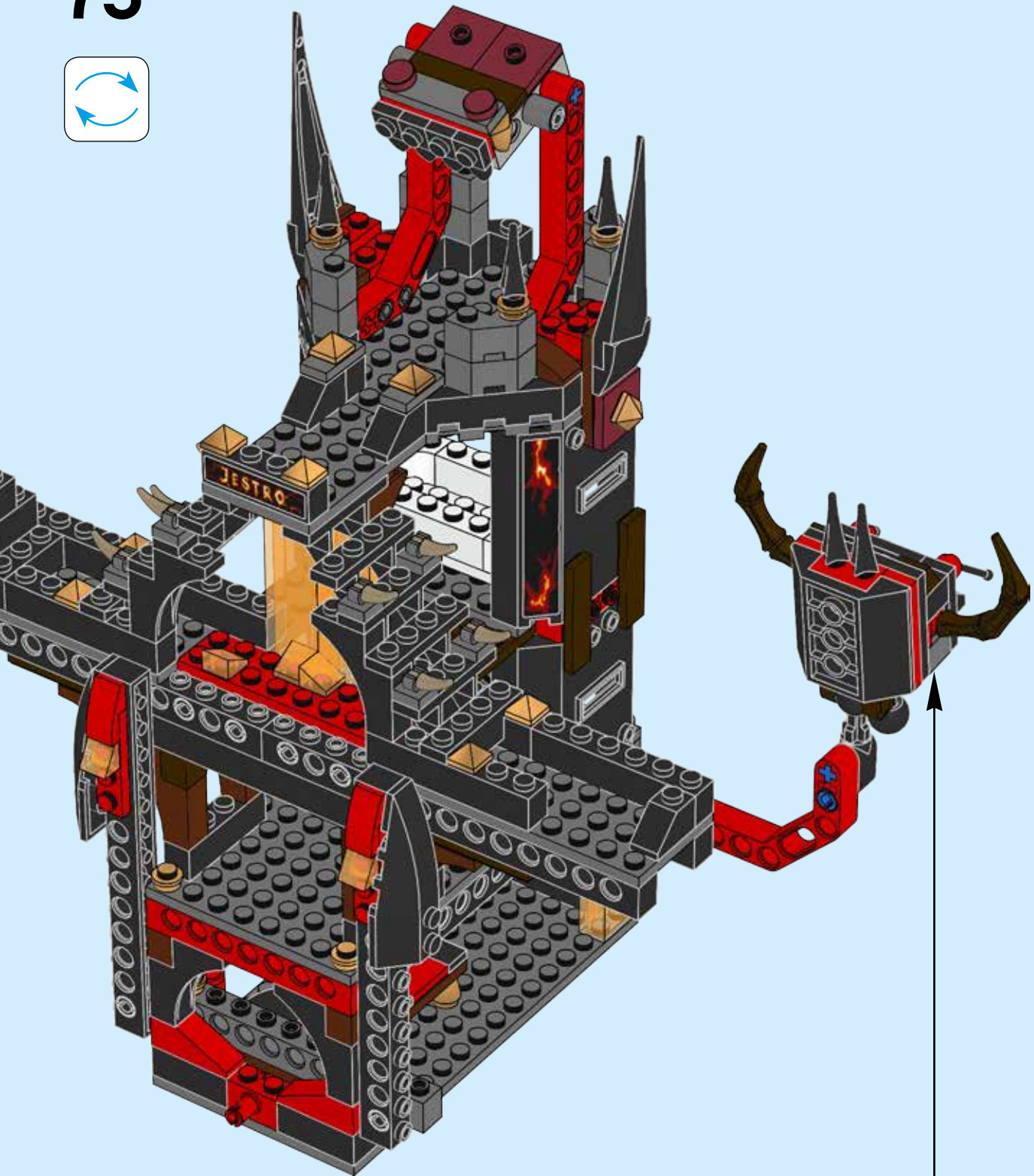
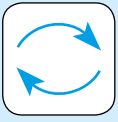

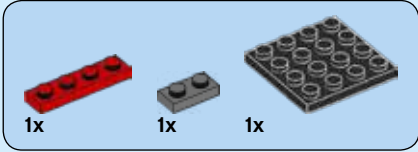
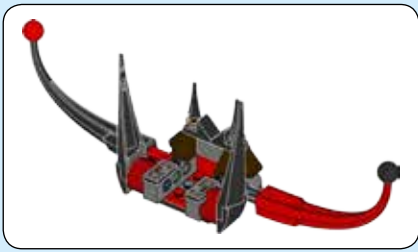

76

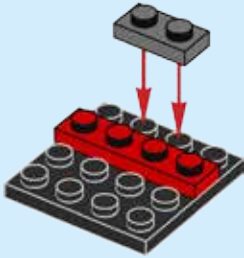

77

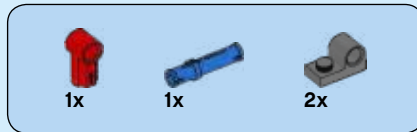

78

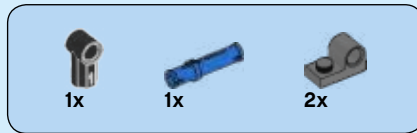
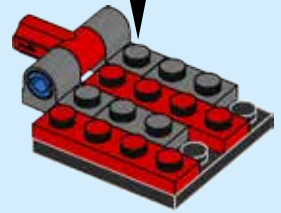
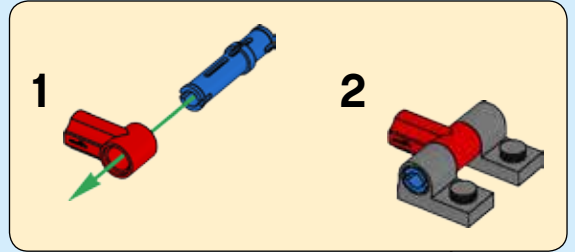

79

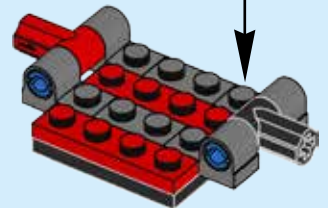
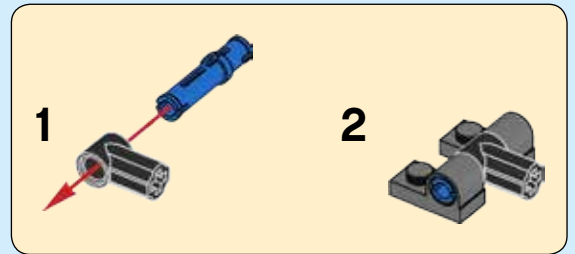



80

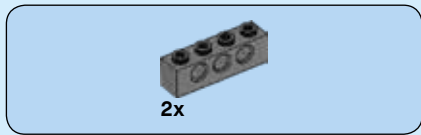
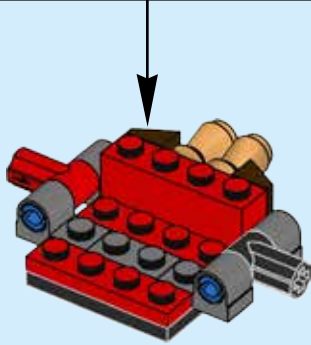
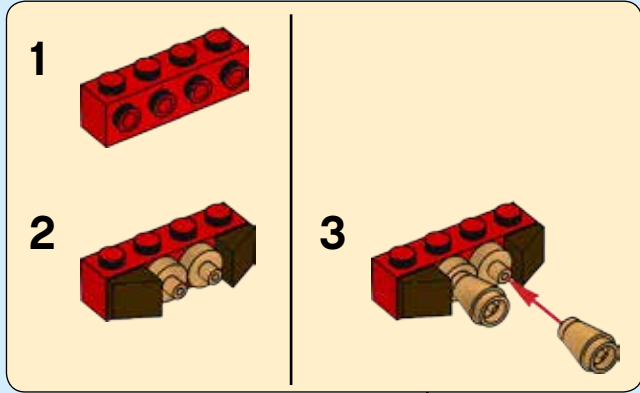

81



82

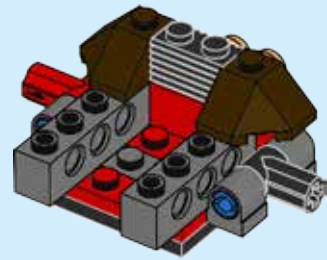

83

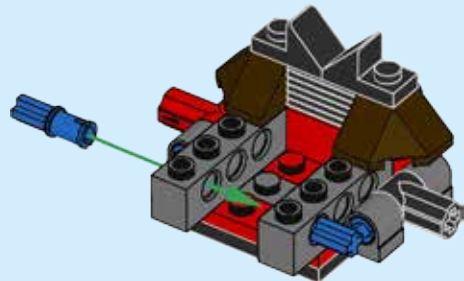

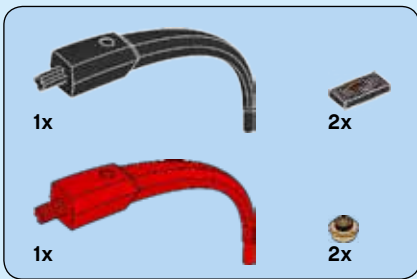

84

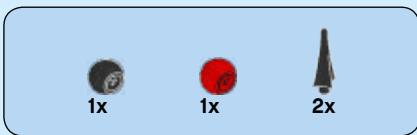
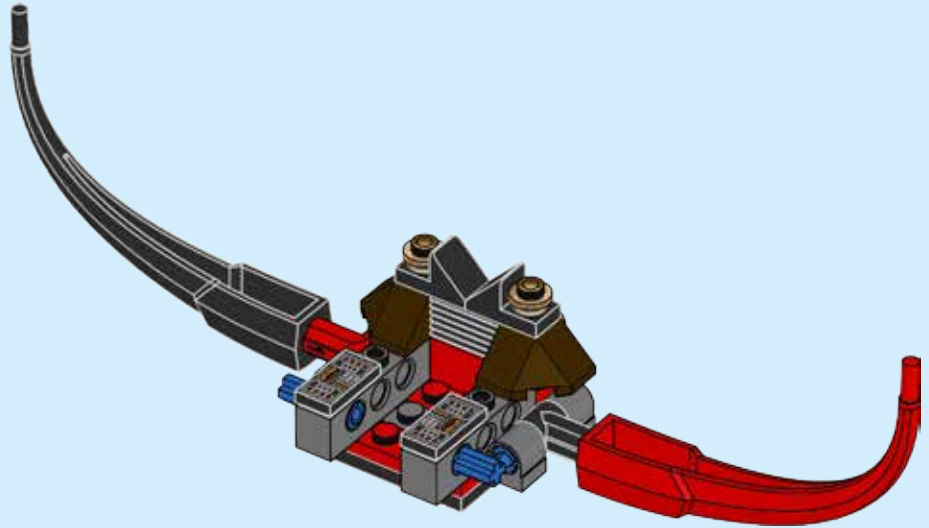

85

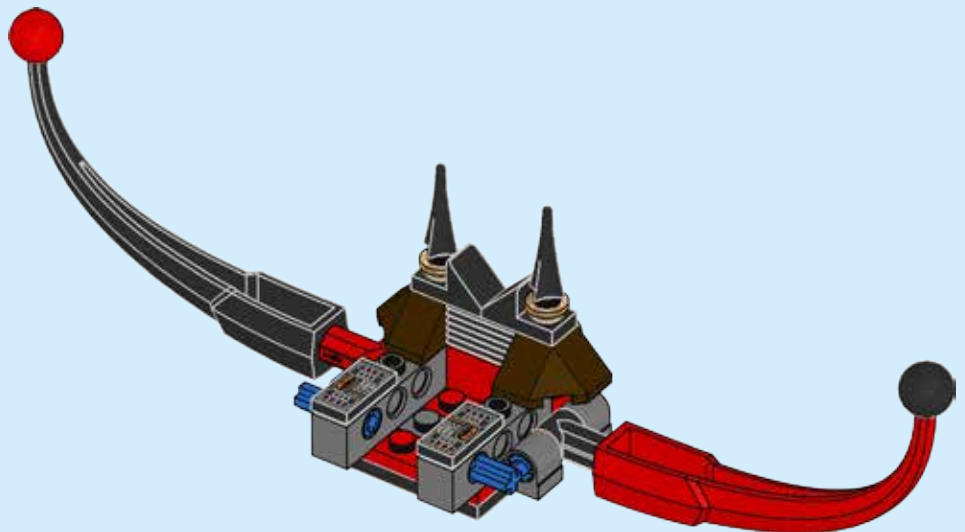



86

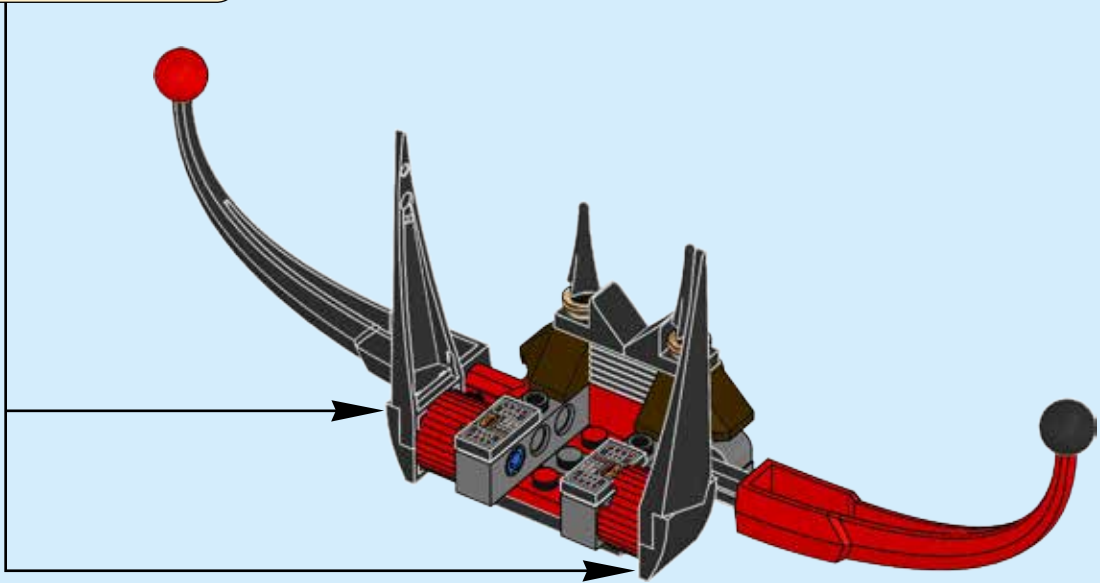
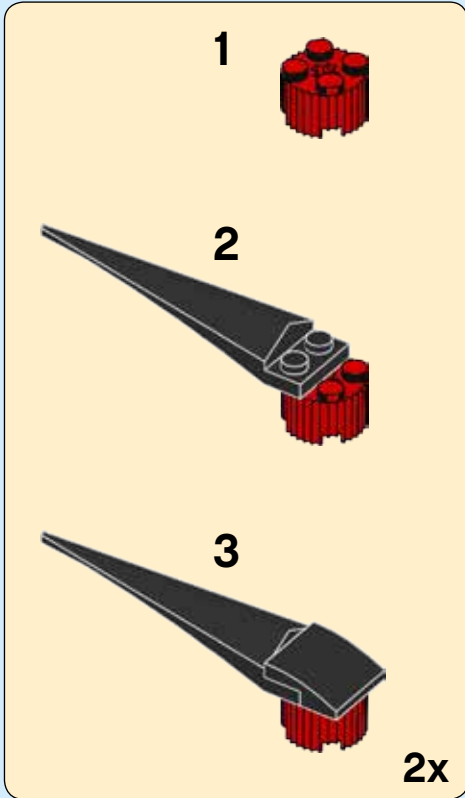

87

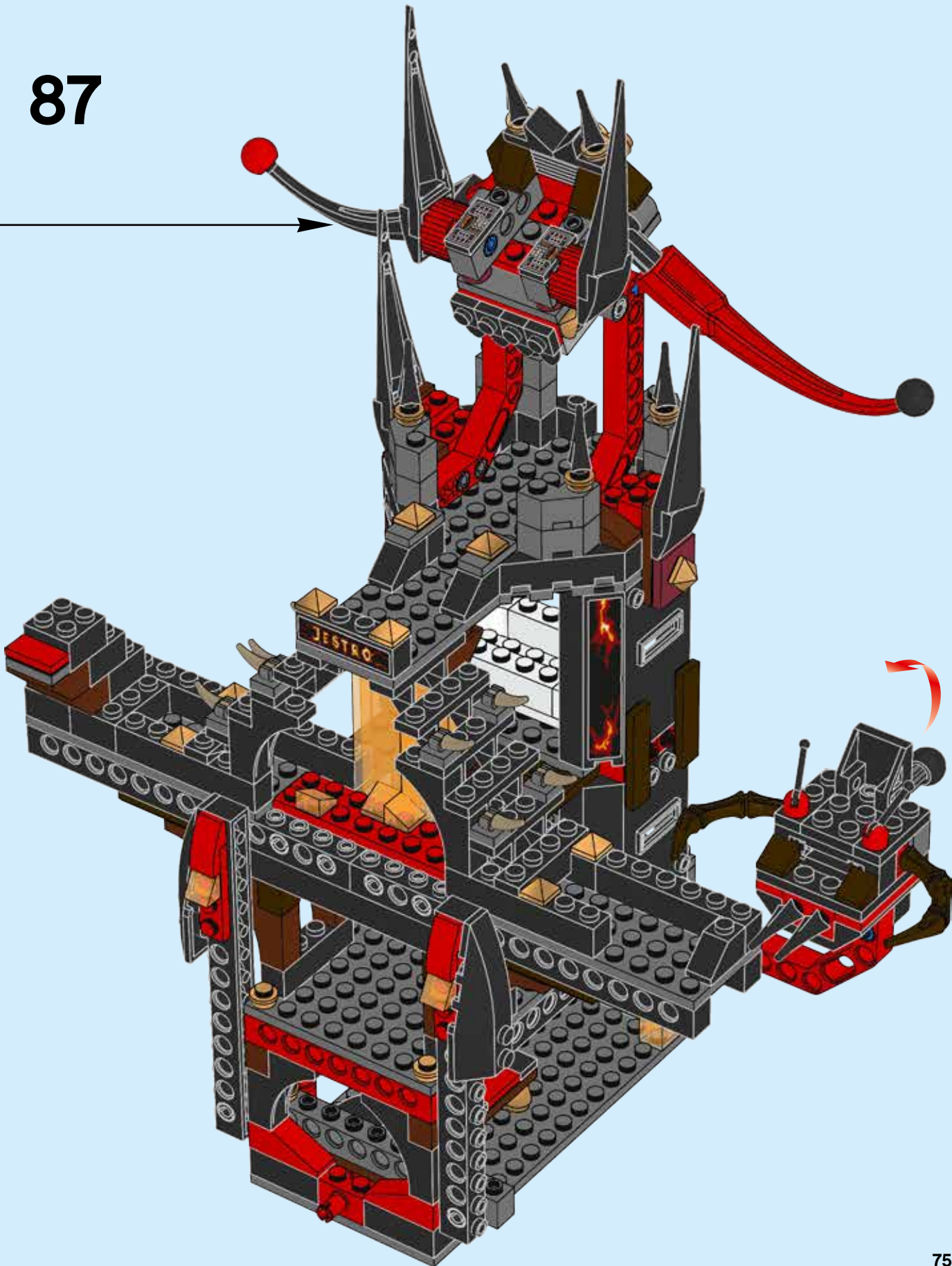



88

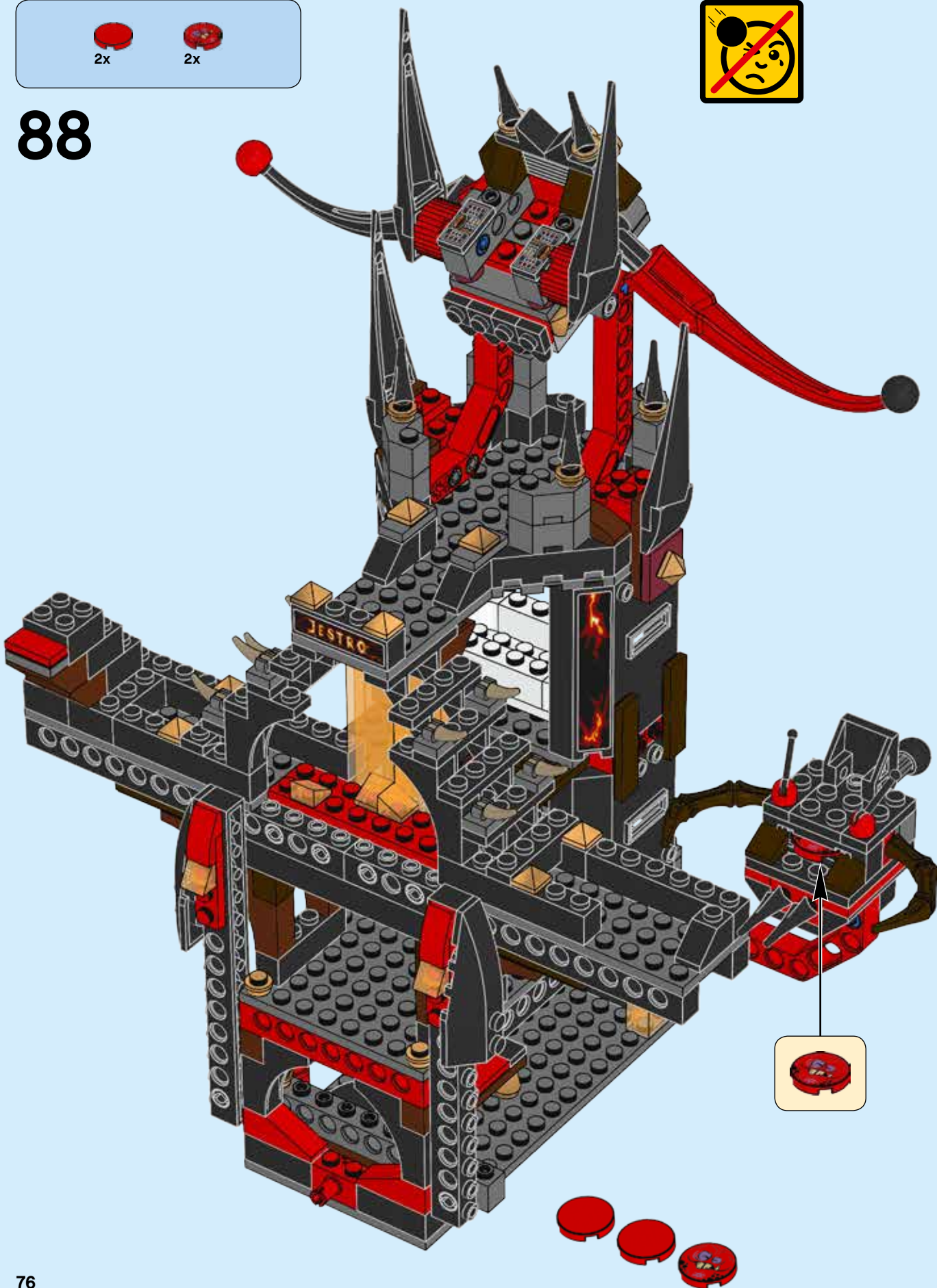

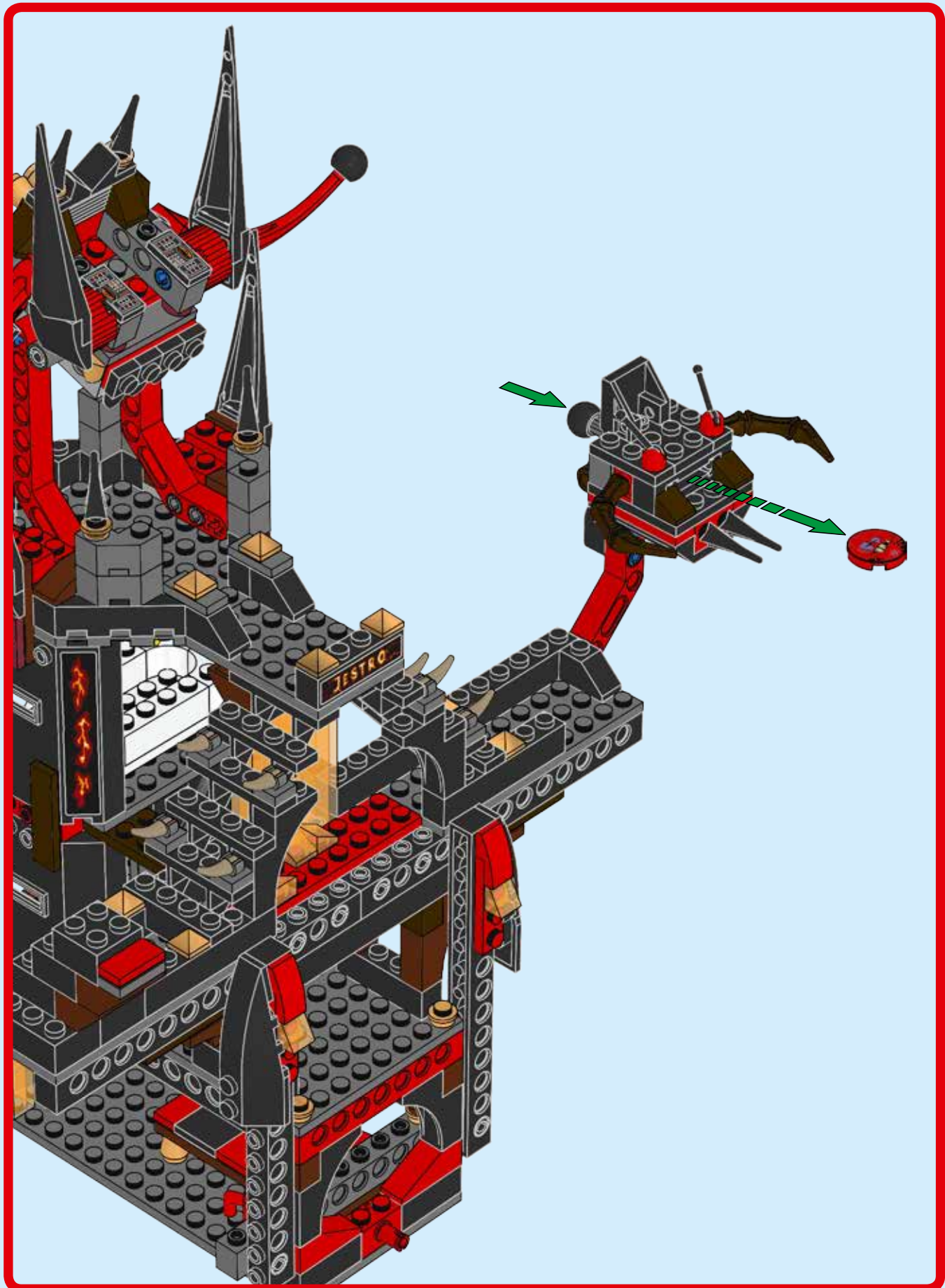

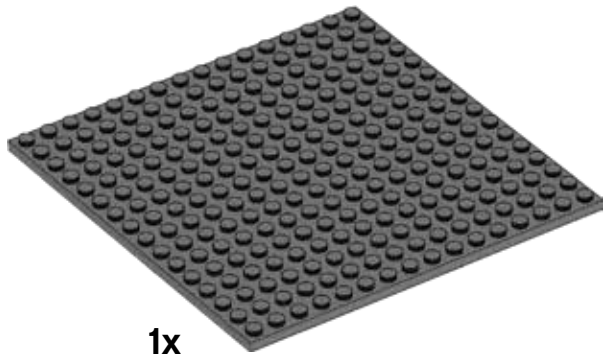

1x

+



5

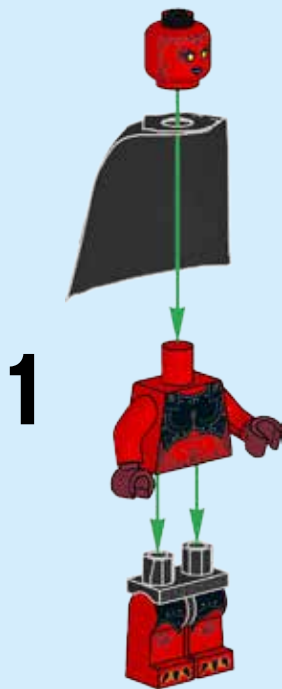
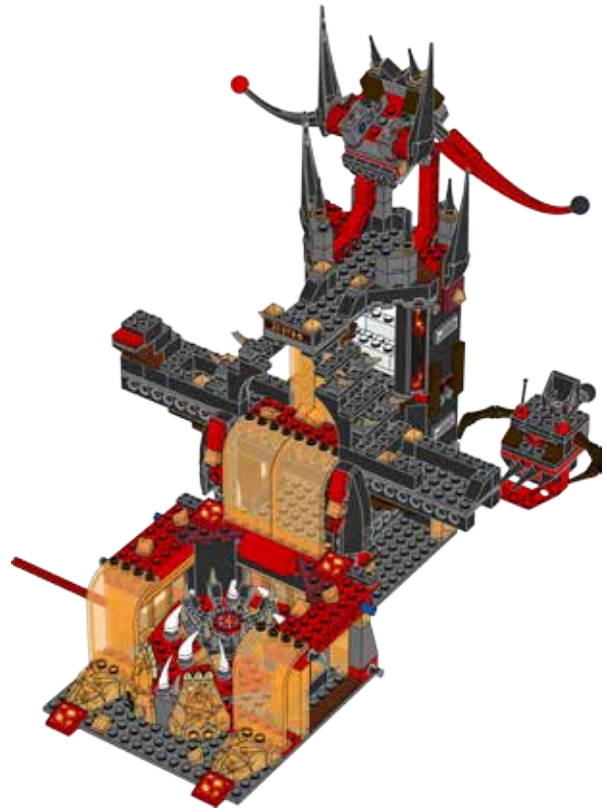

1

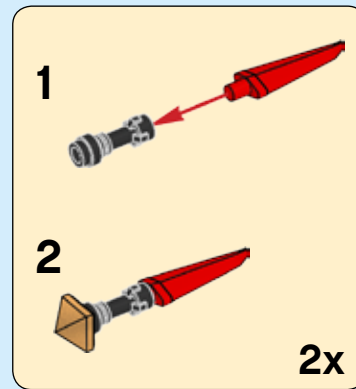

1

2

2x

2



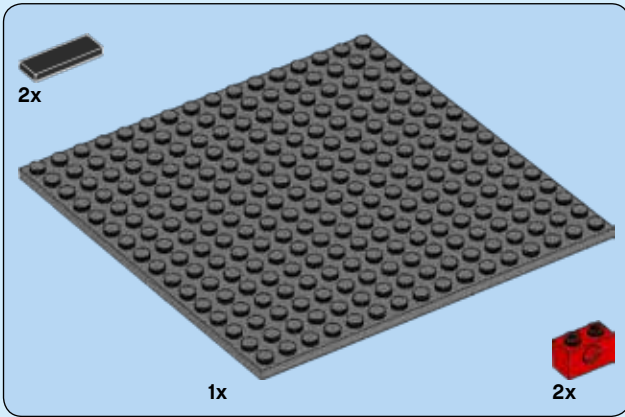
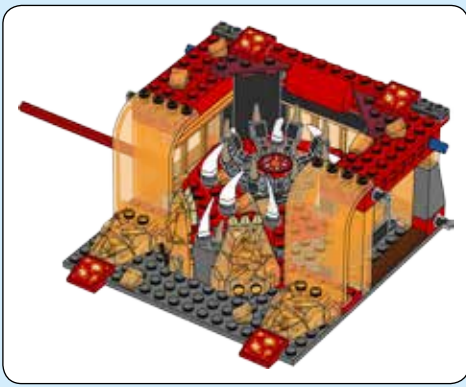

89

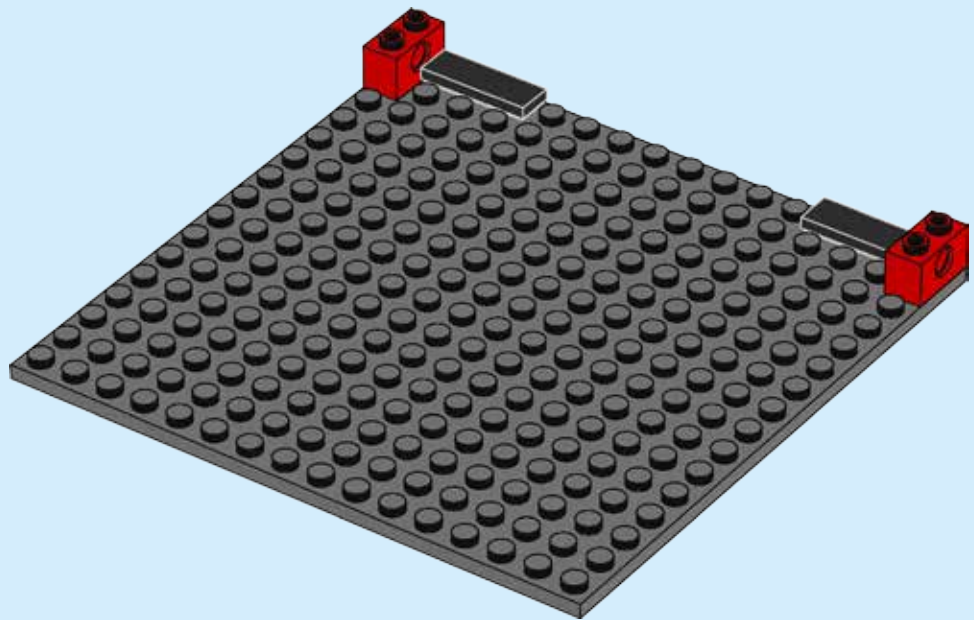

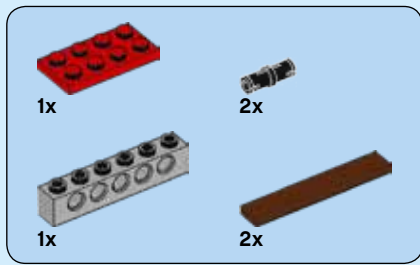

90

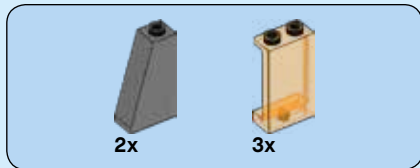
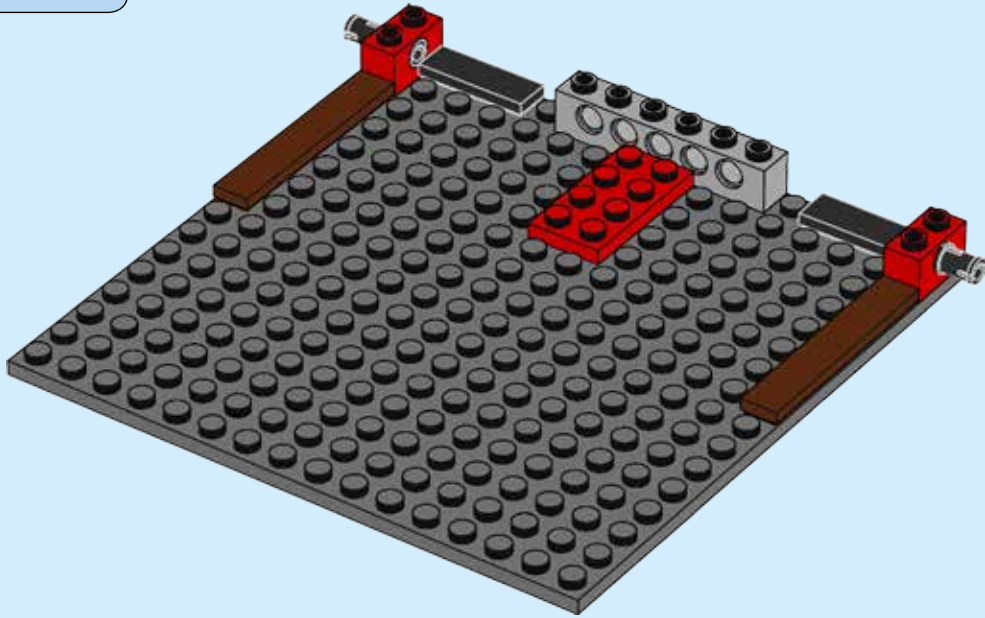

91

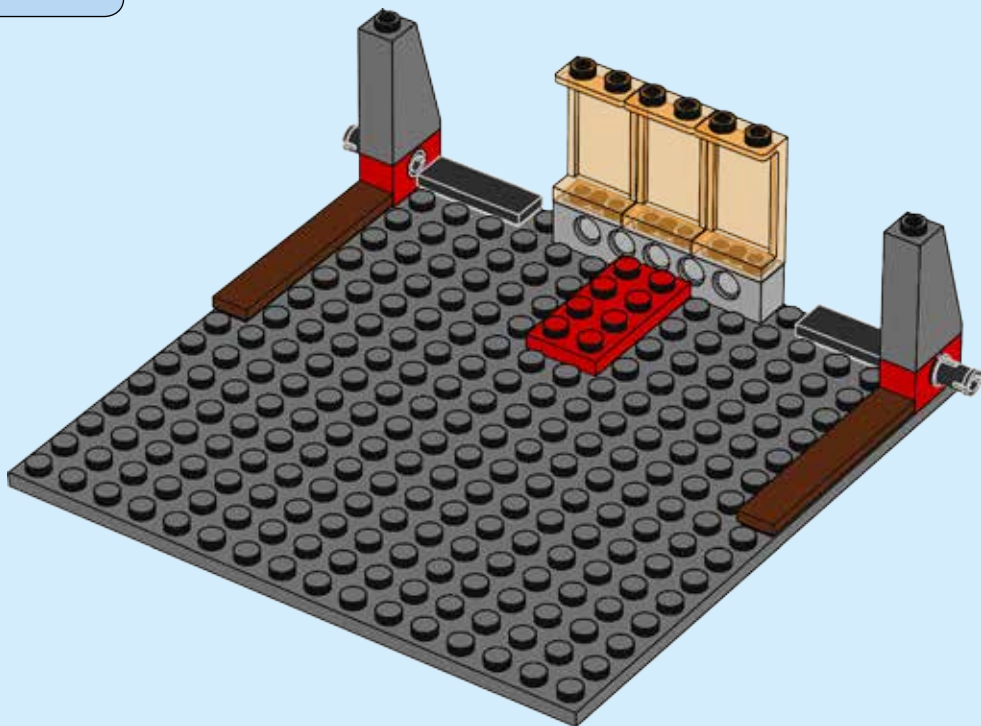

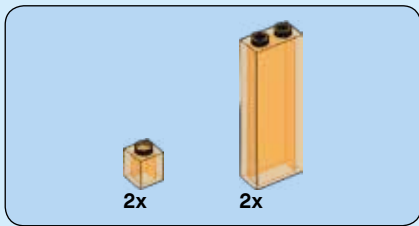

92

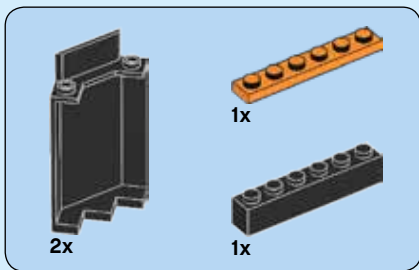
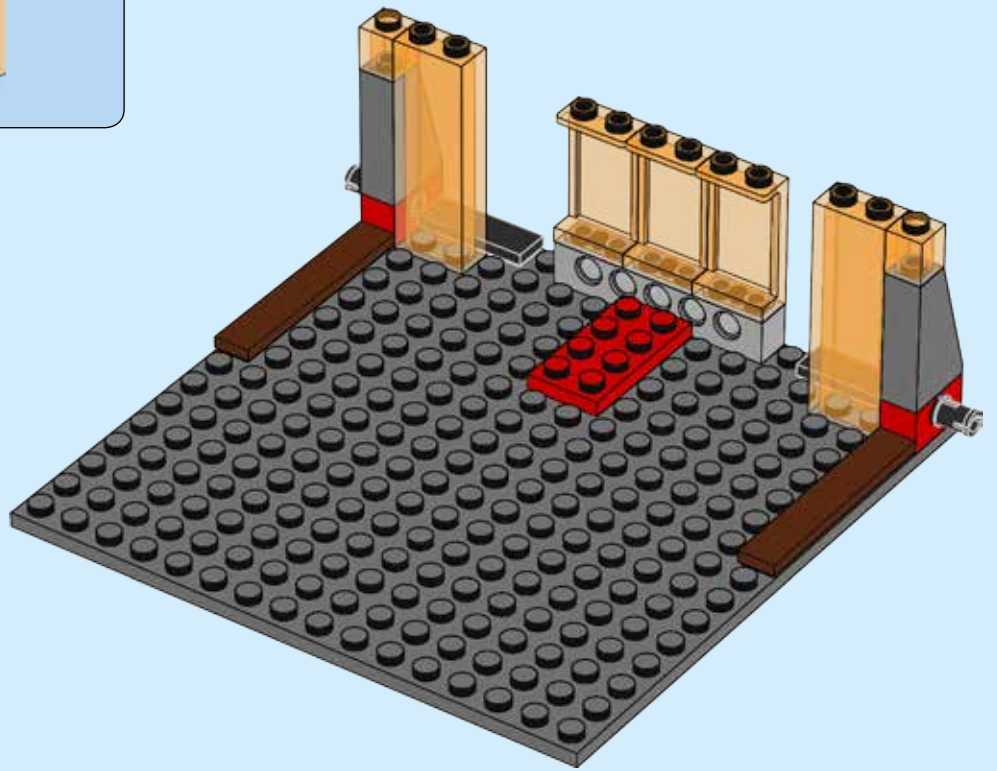

93

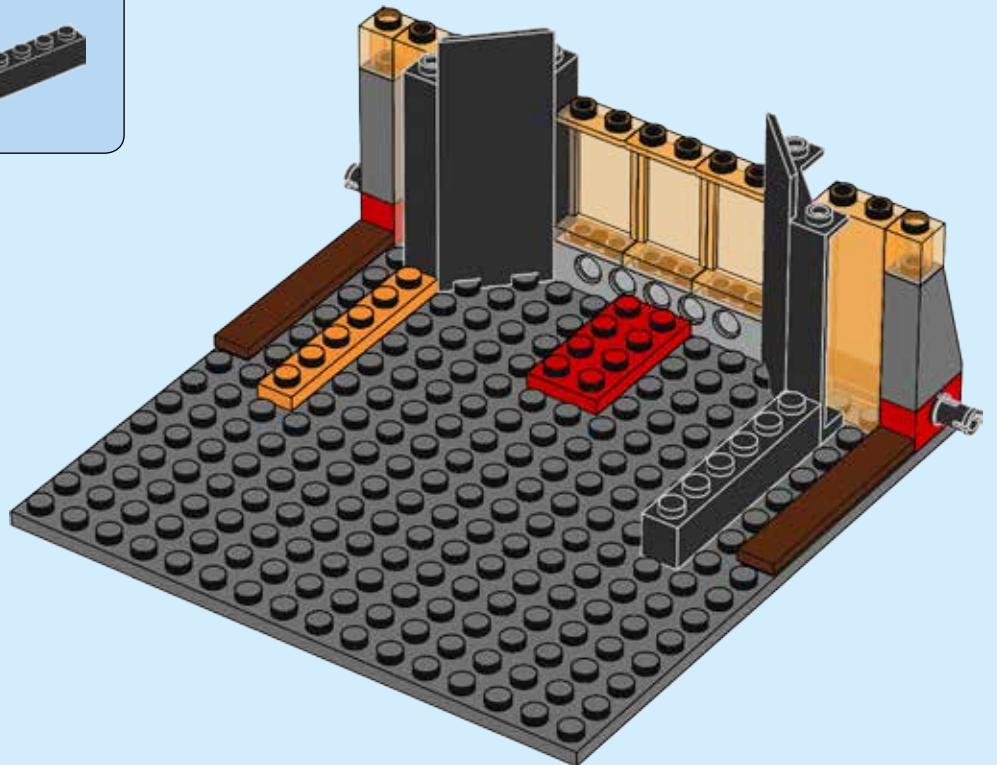

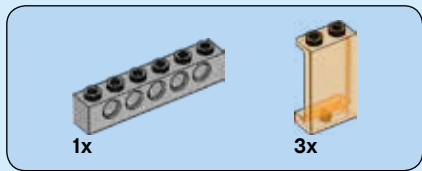

94

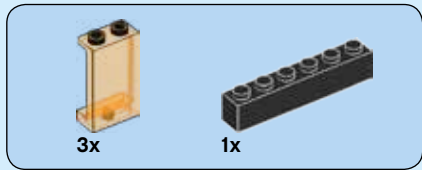
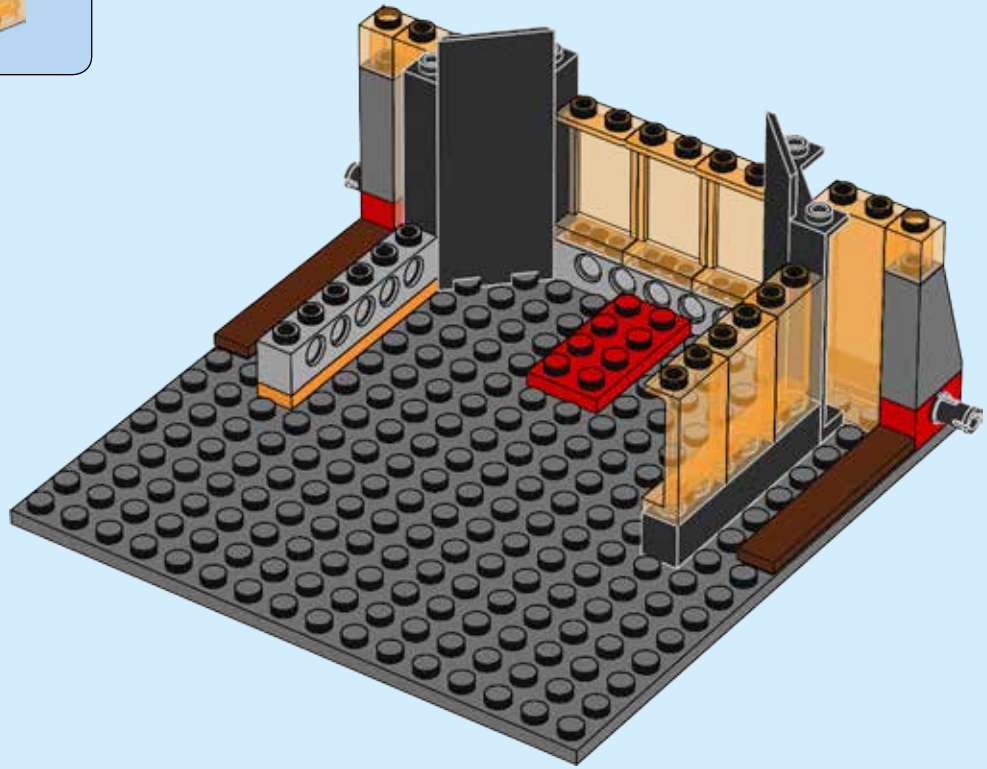

95

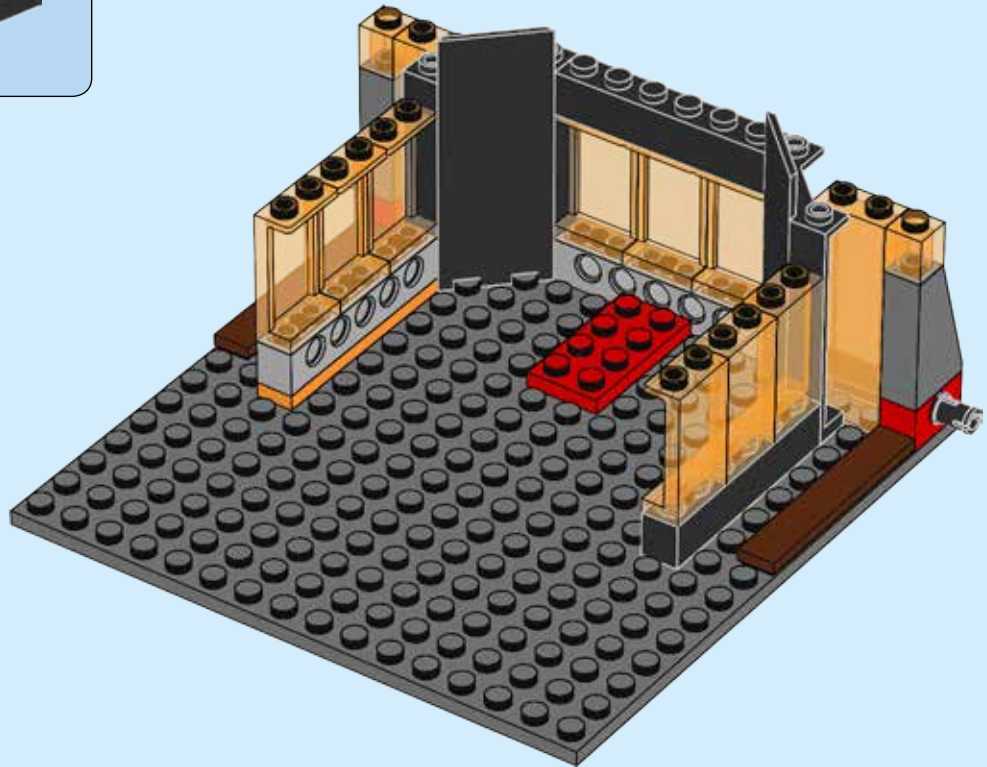

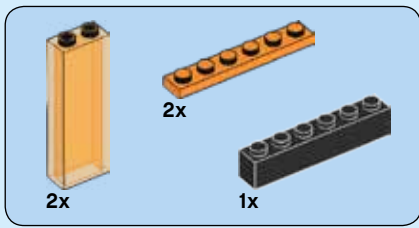

96

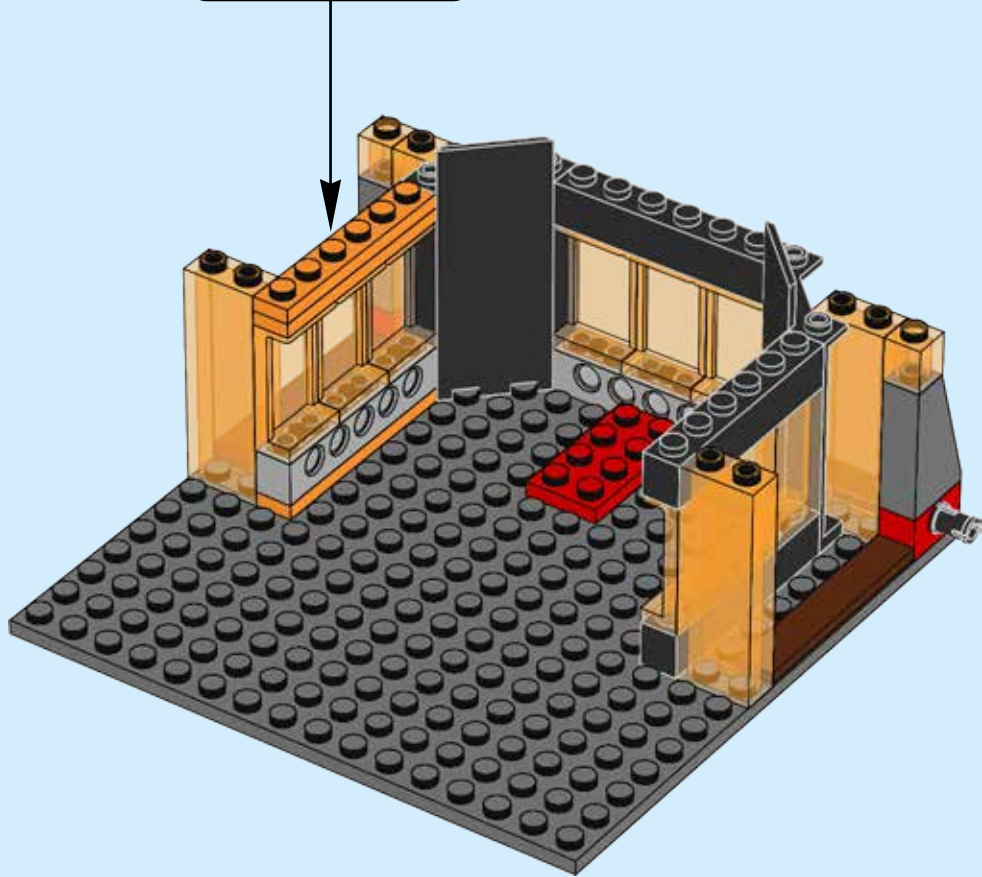
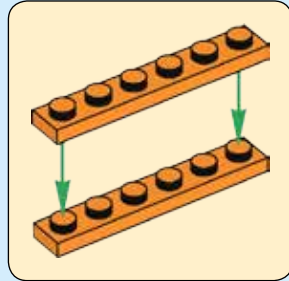

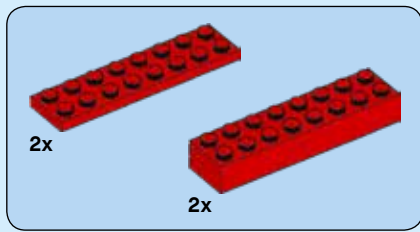

97

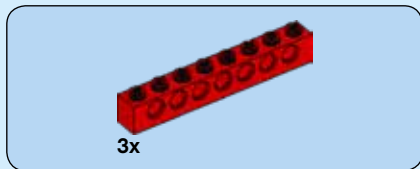

98





99

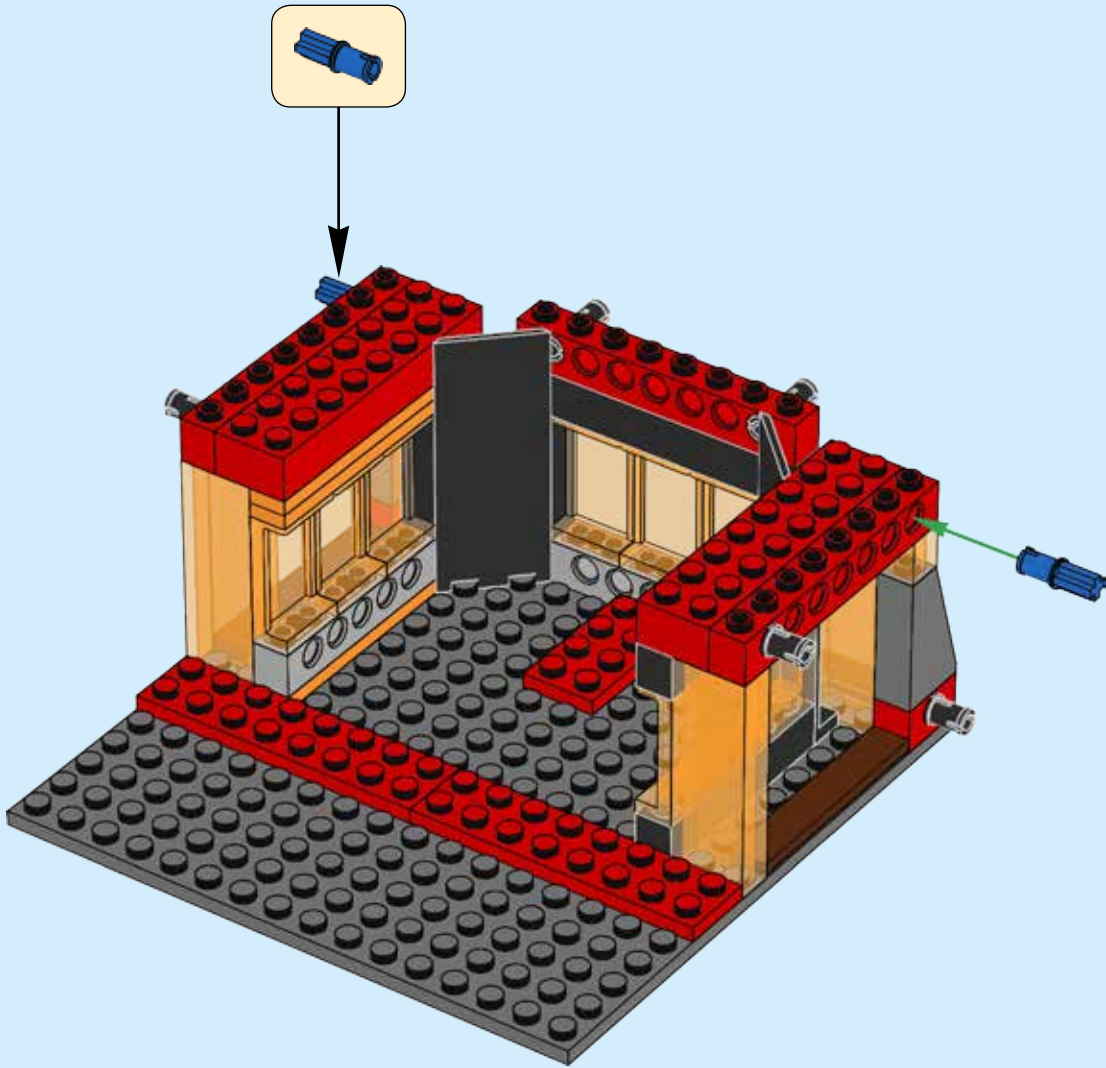



2x

100

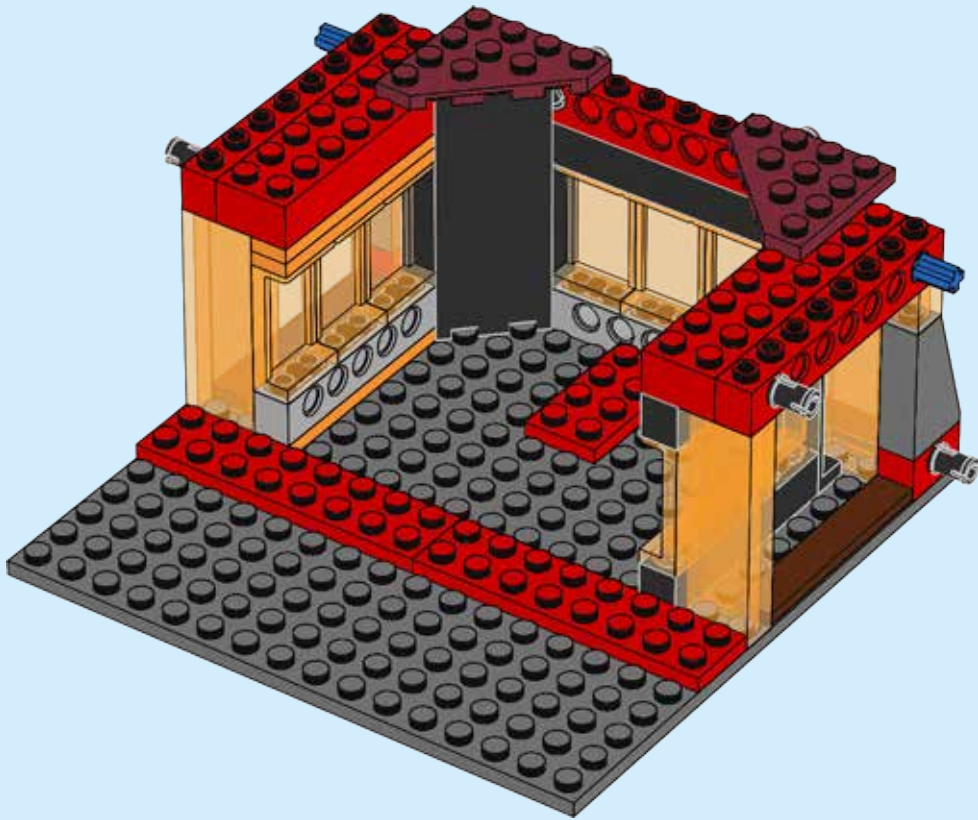

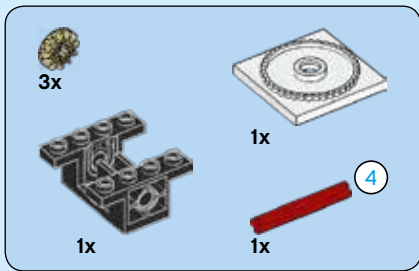

101

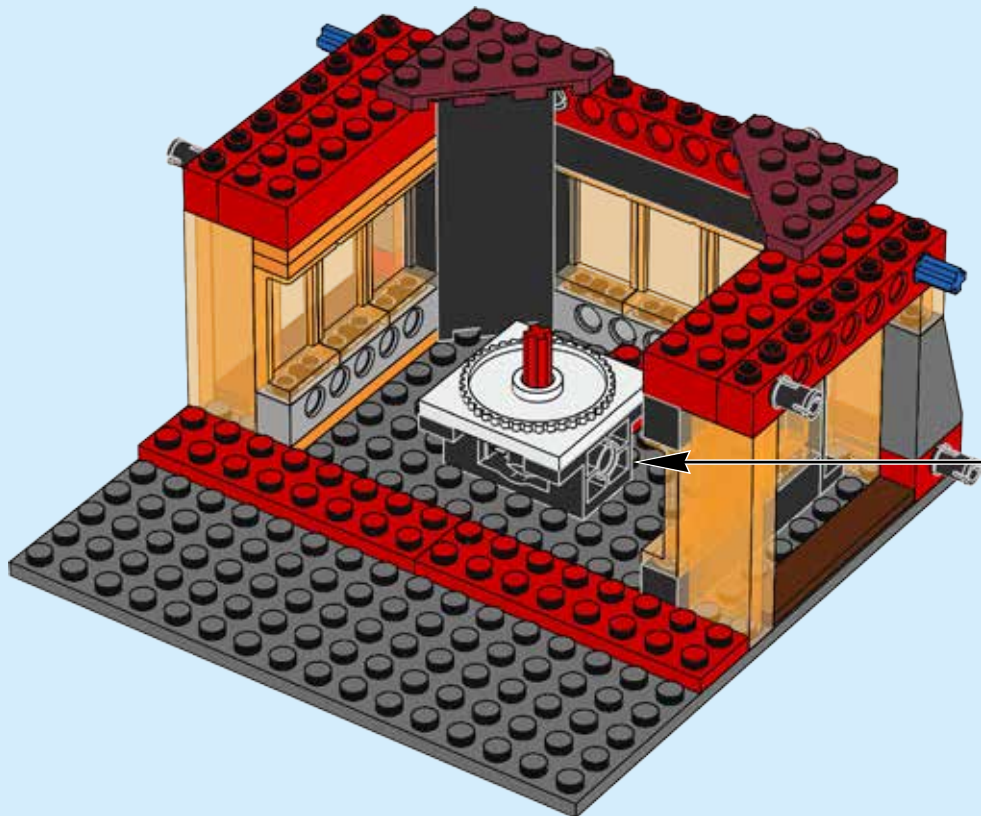
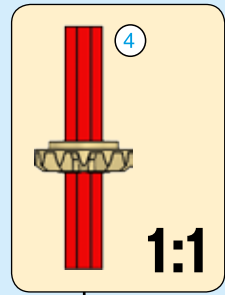
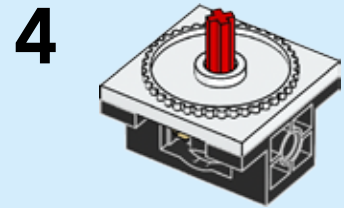
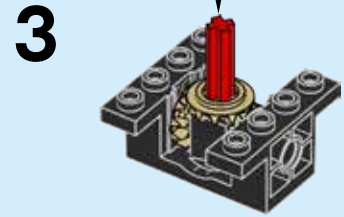
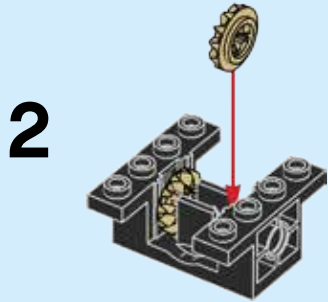
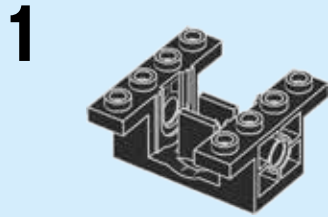

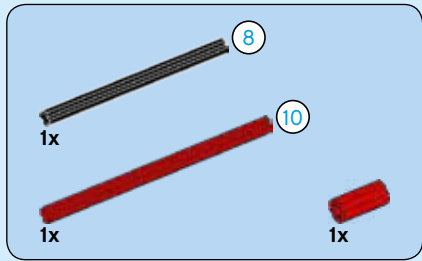

102

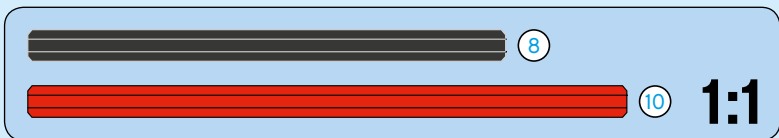
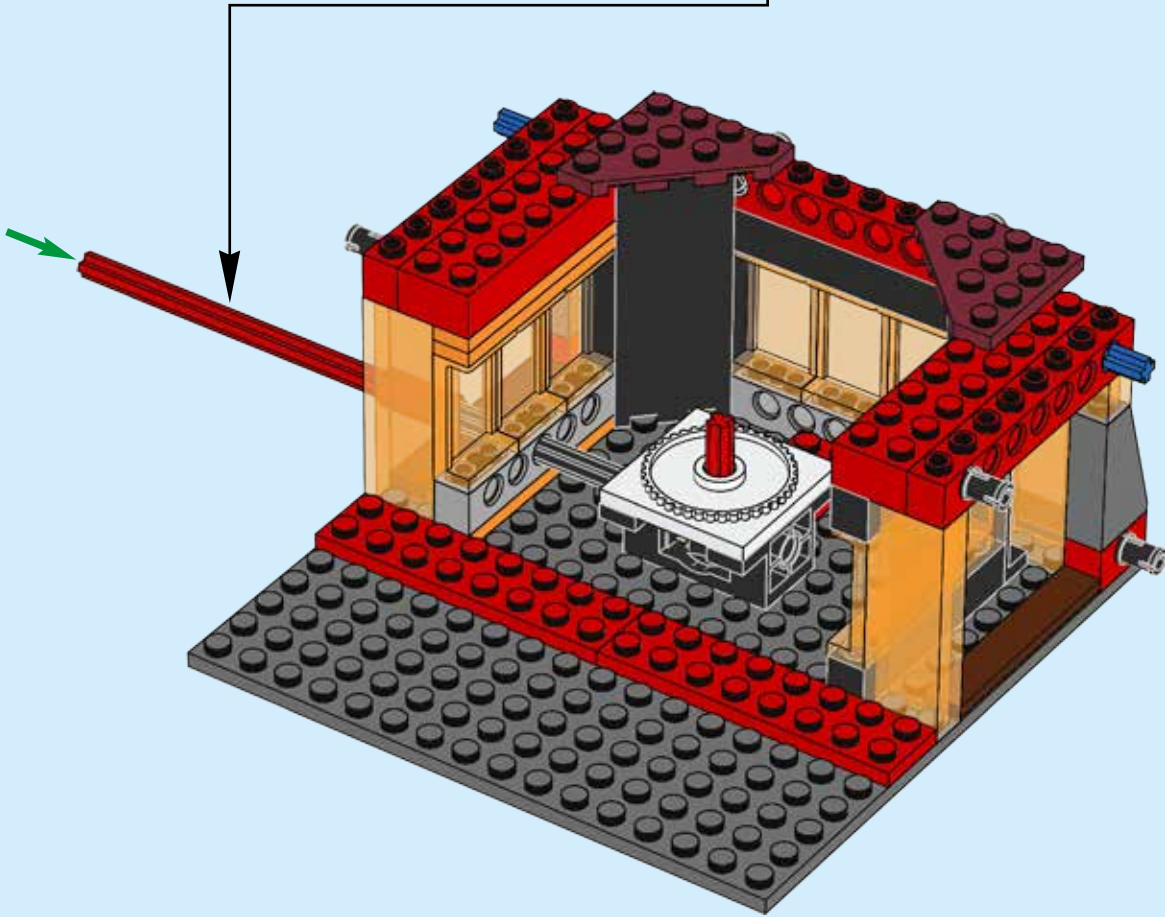
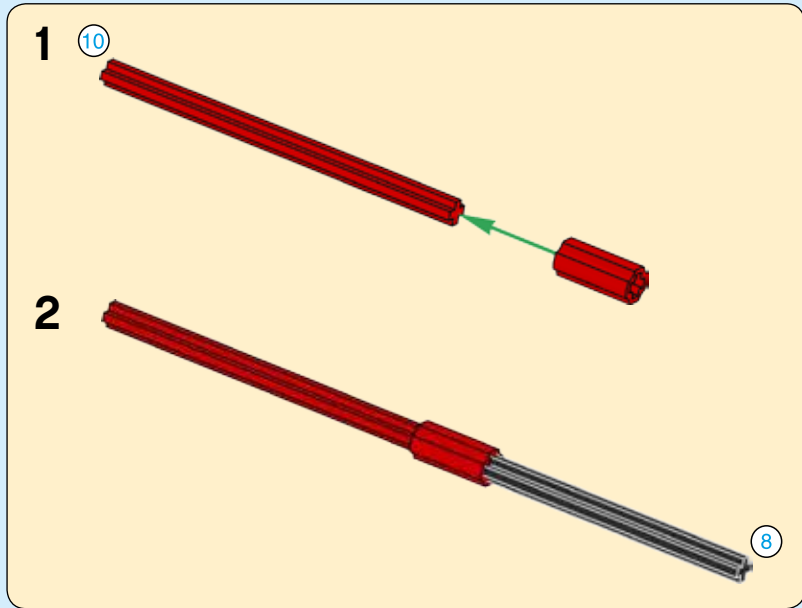

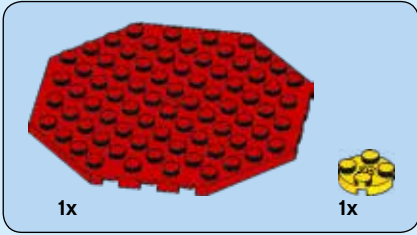

103

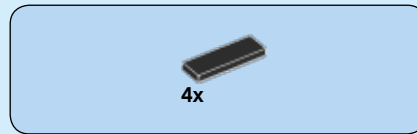
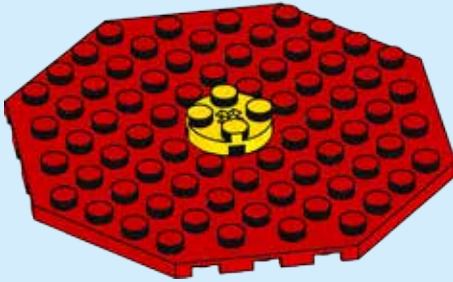

104



105

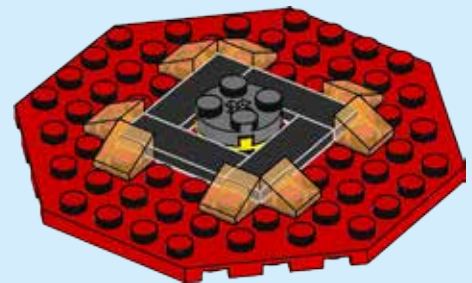

8x

106



8x

107



1x 8x 1x 8x

108

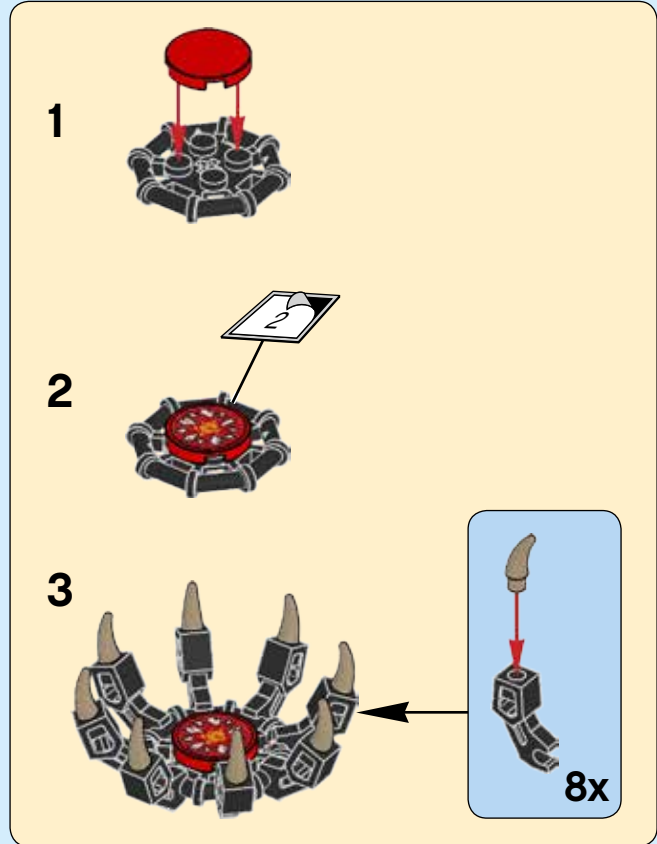

109

咔嗒

CLICK

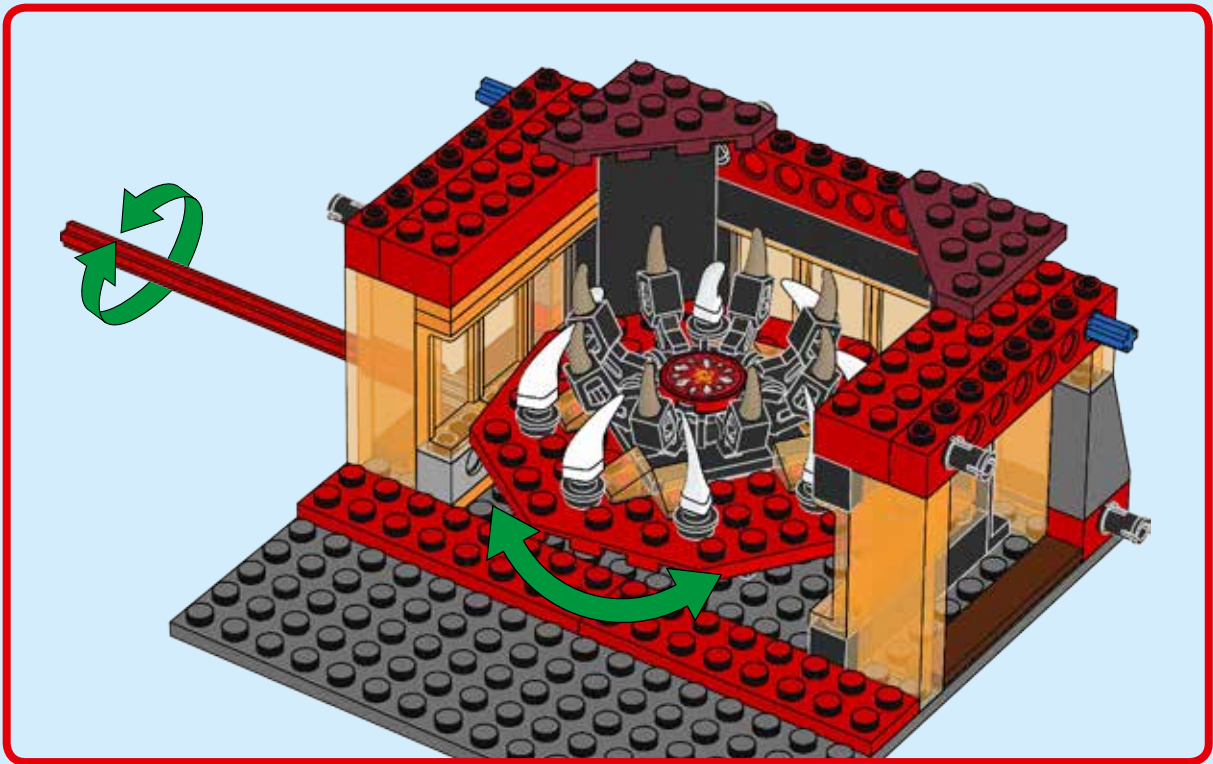
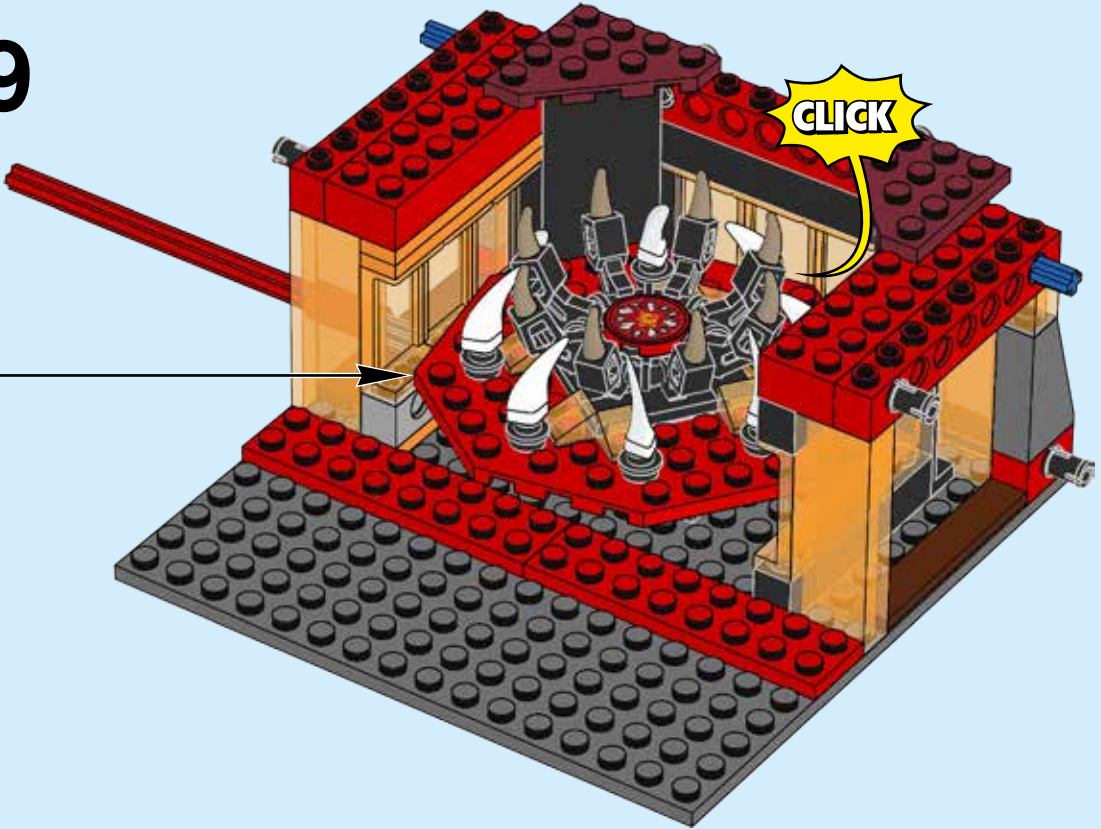

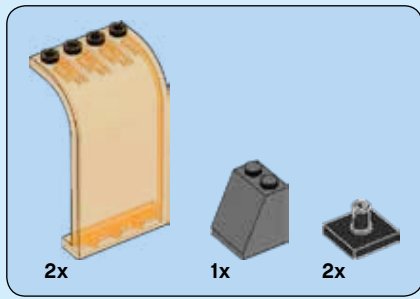

110

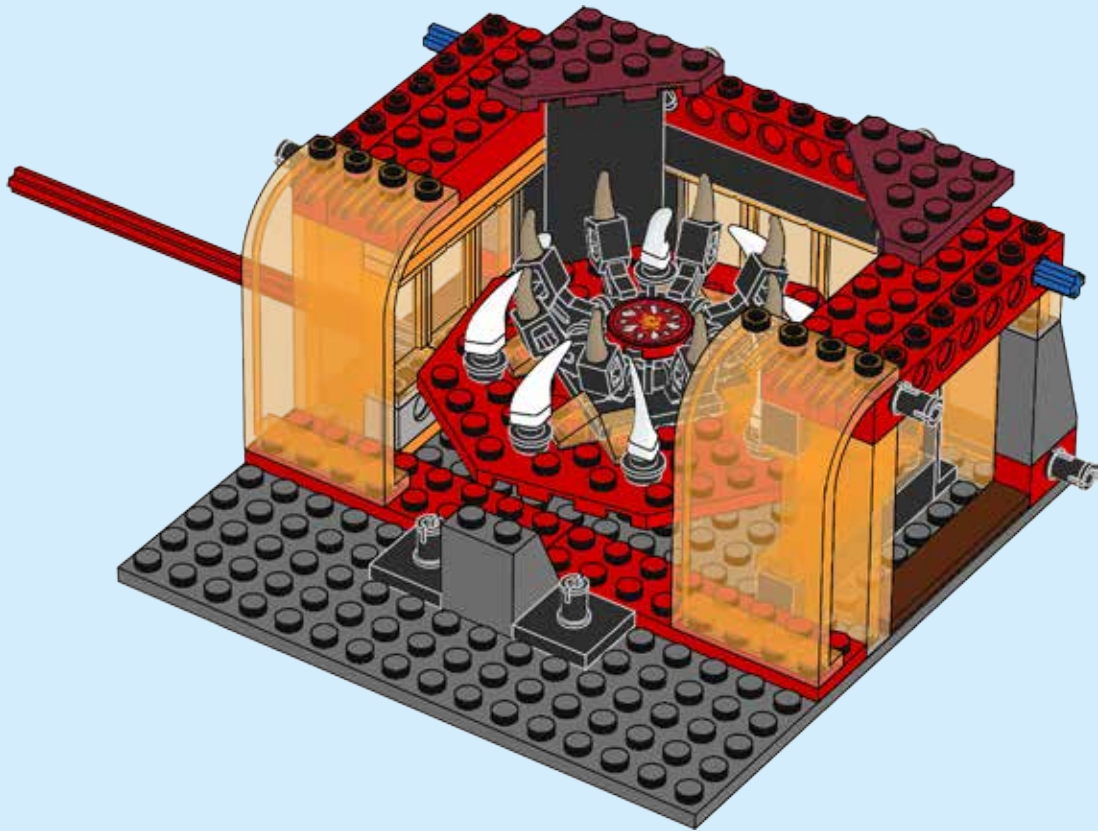

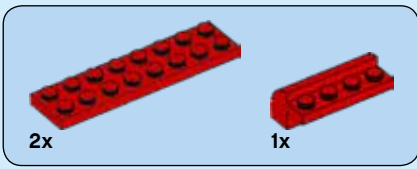

111

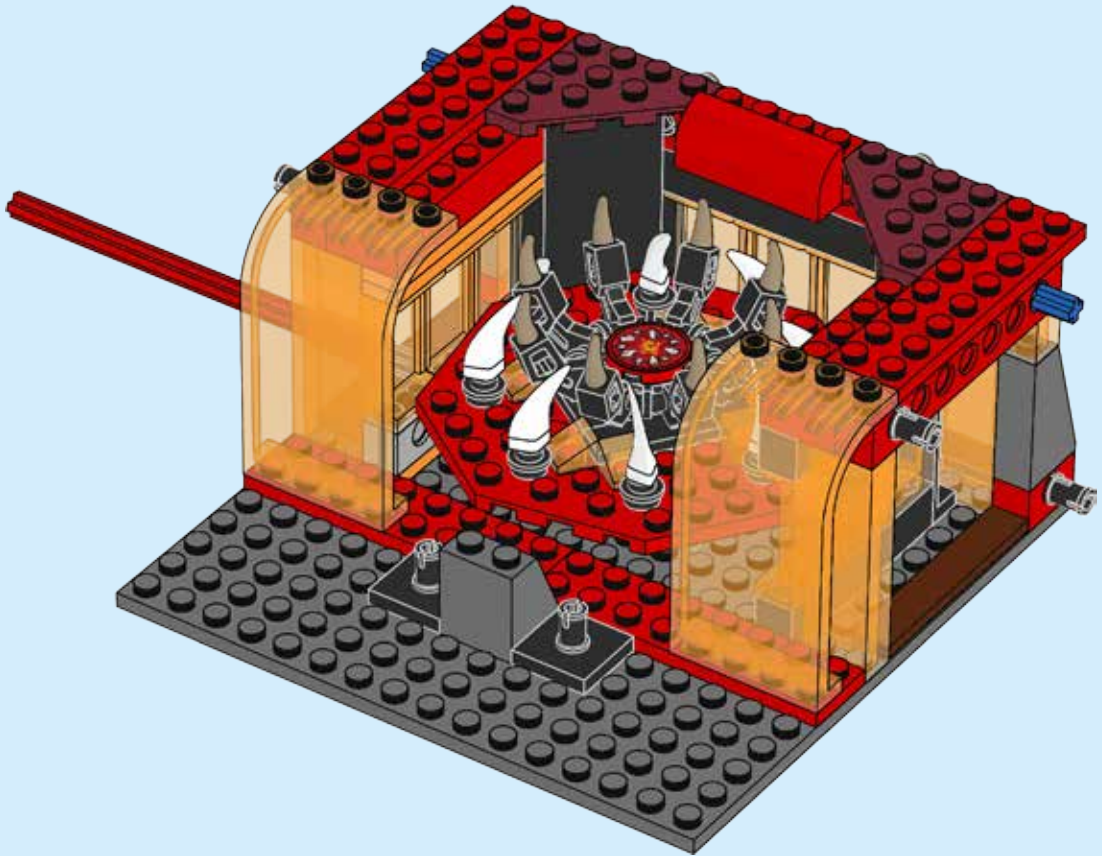

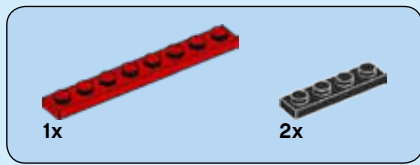

112

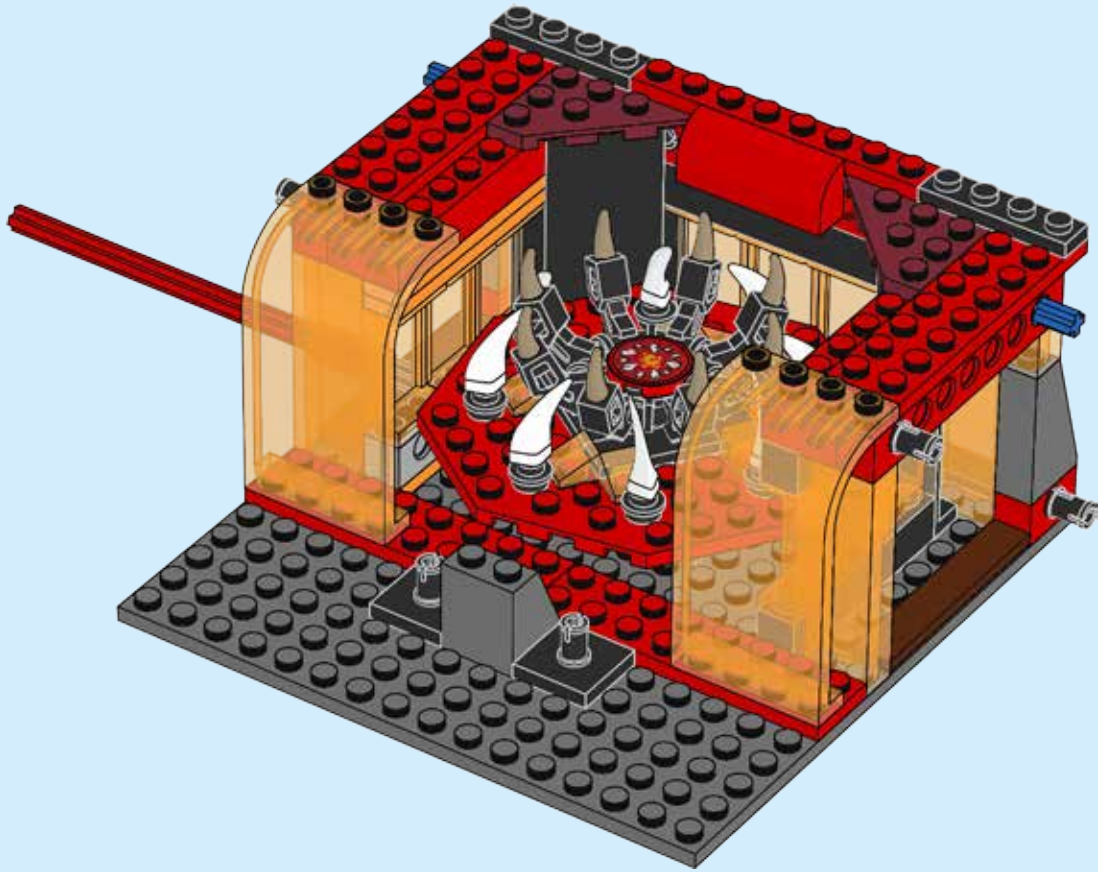

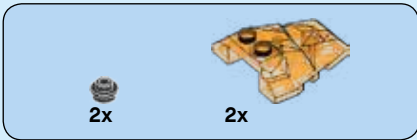

113

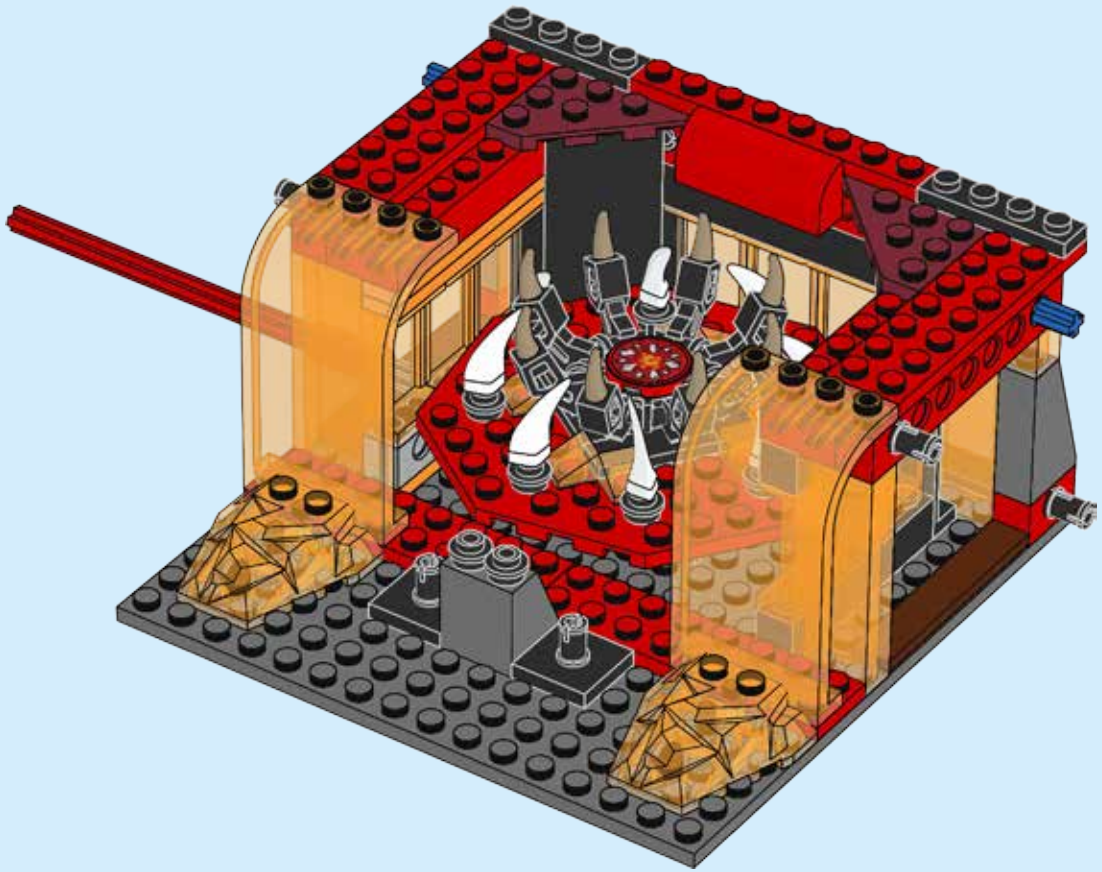

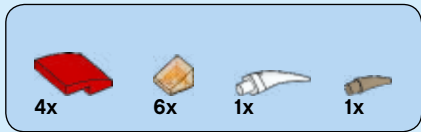

114

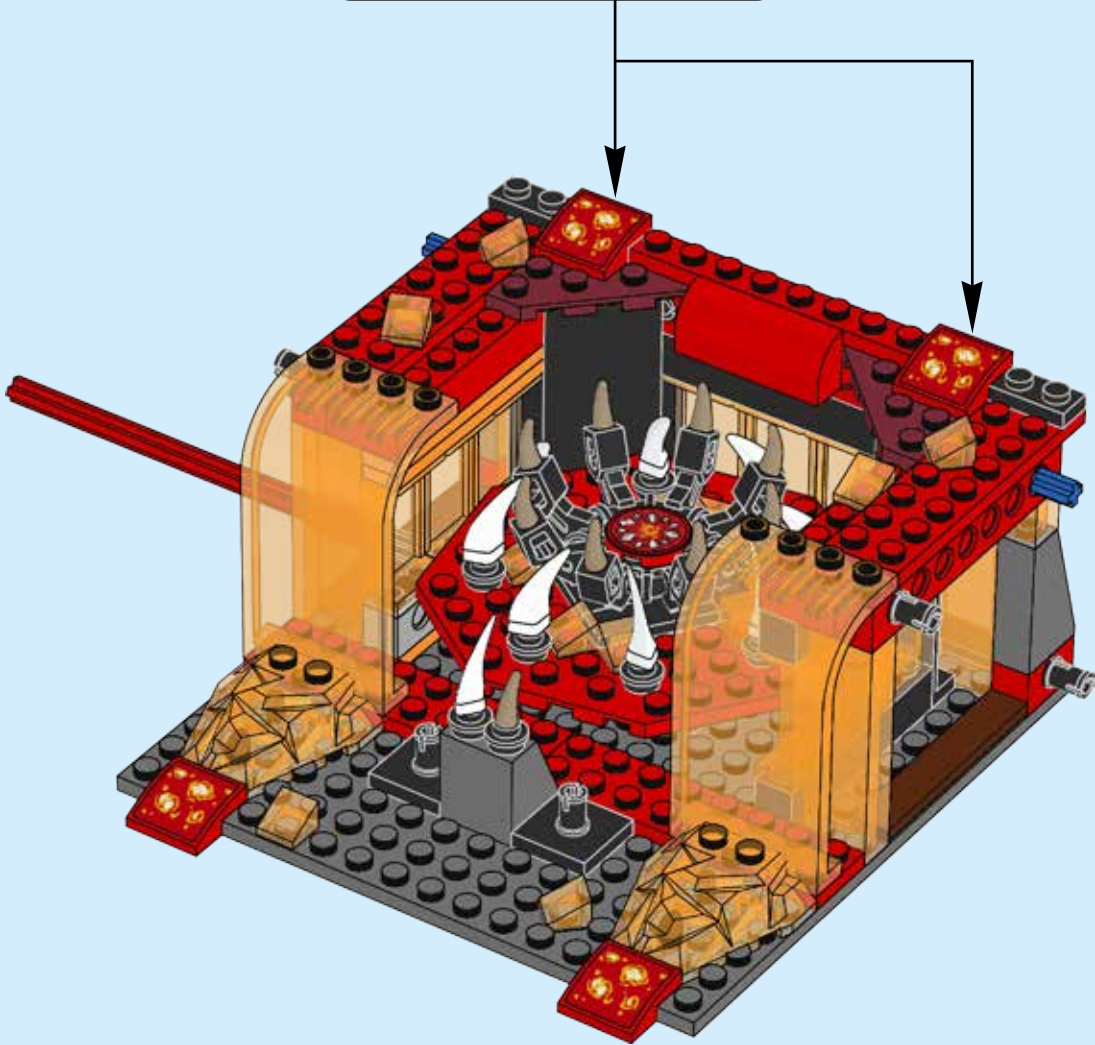
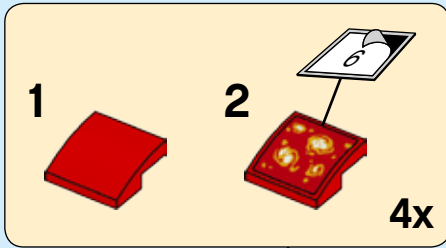



115

1		3	
2		4	

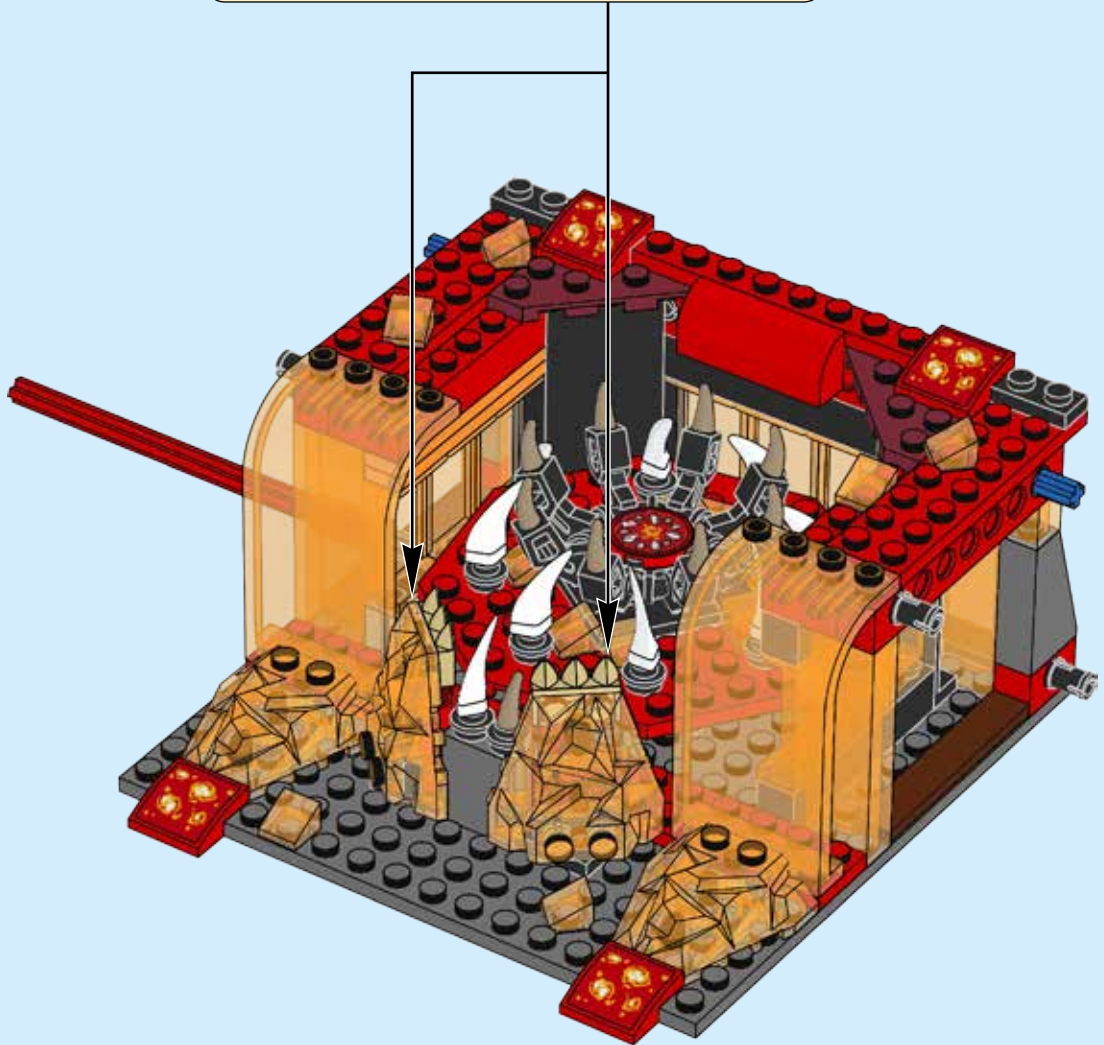

116

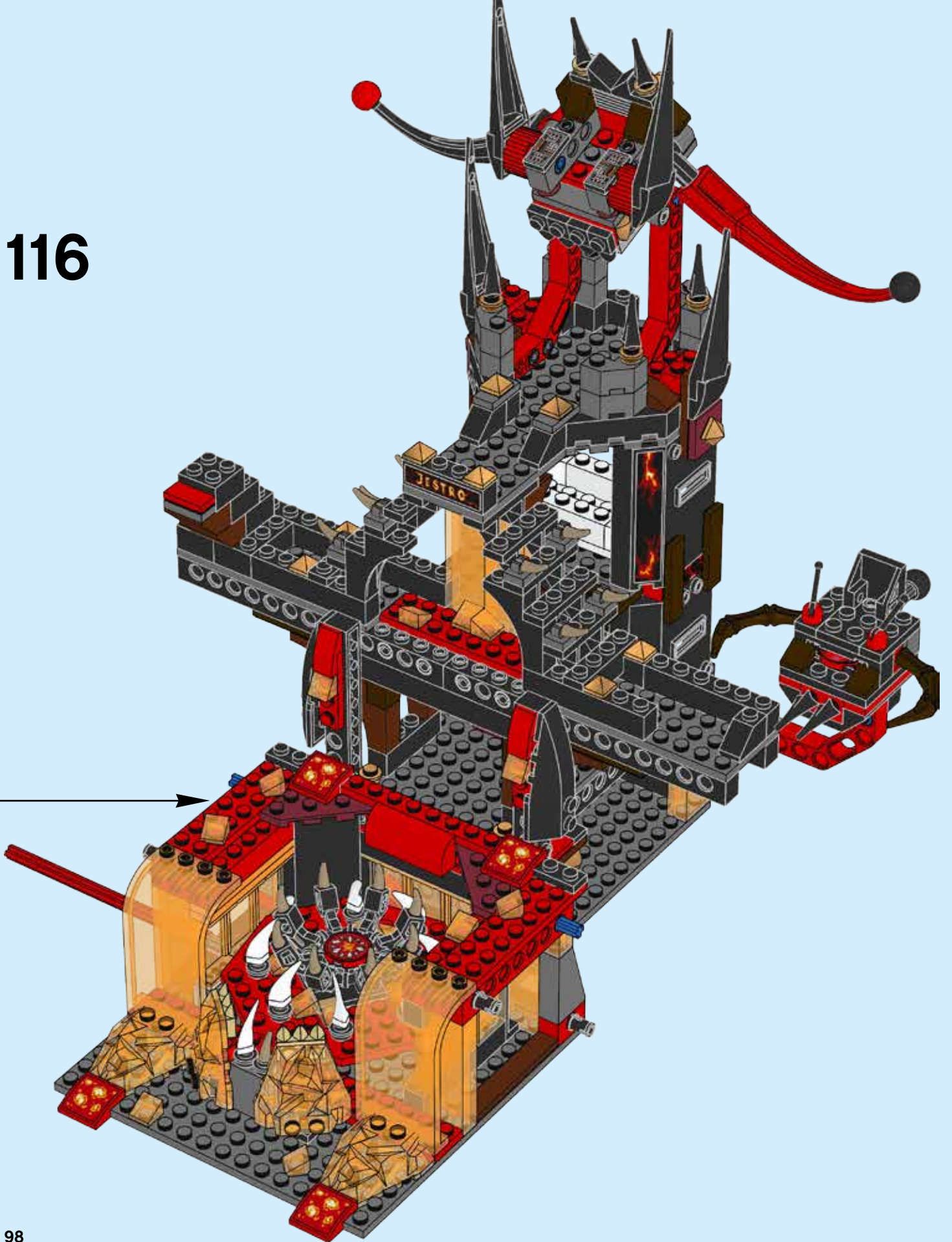

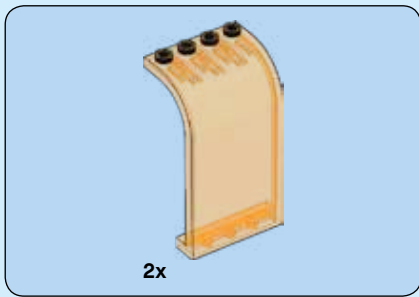

117

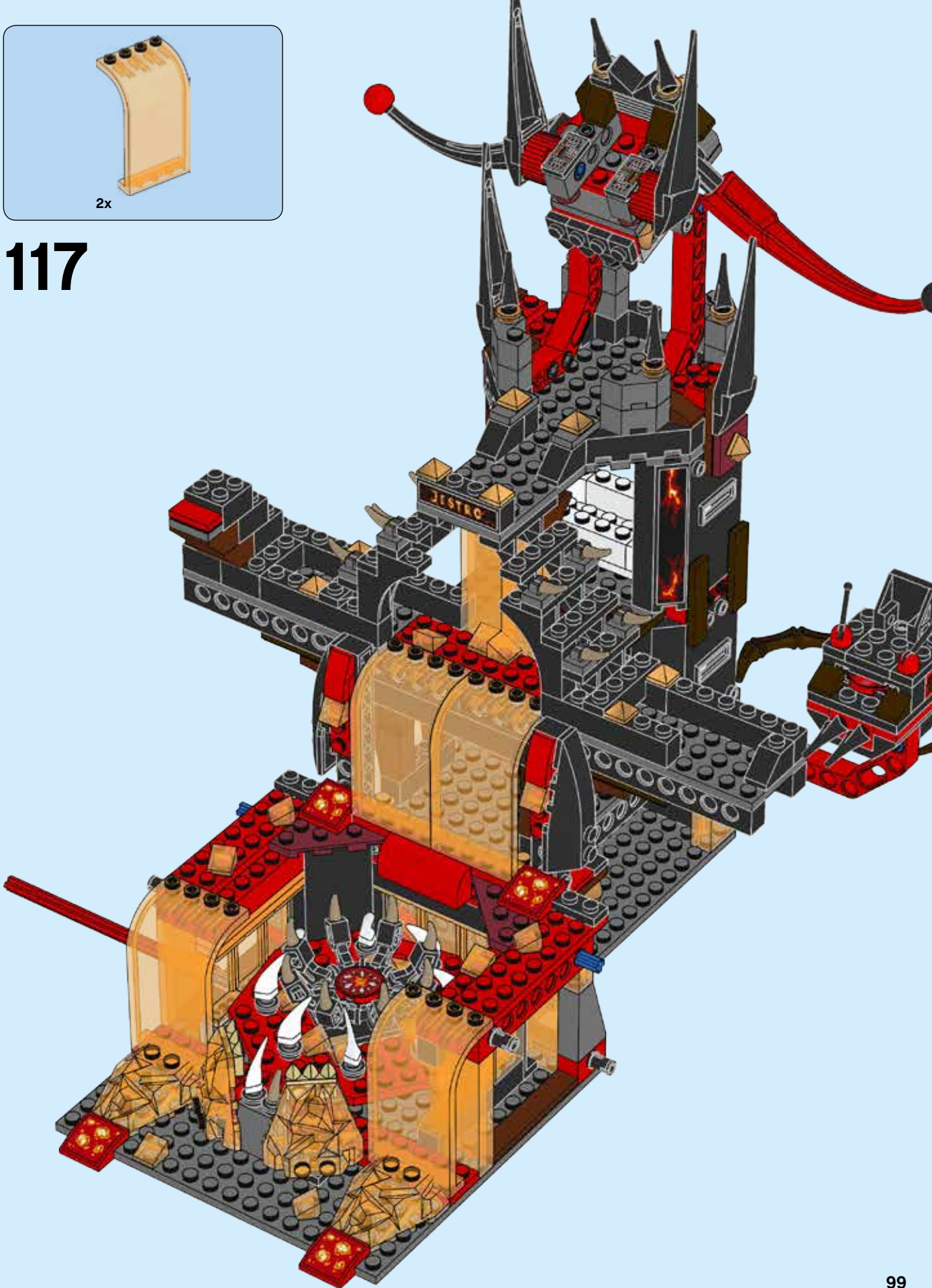



1x

+



6

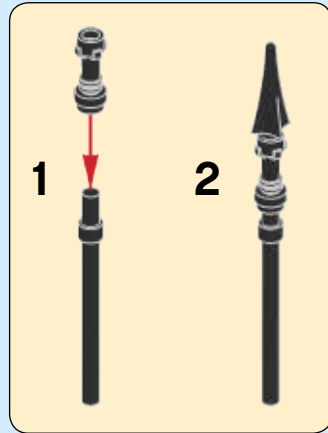
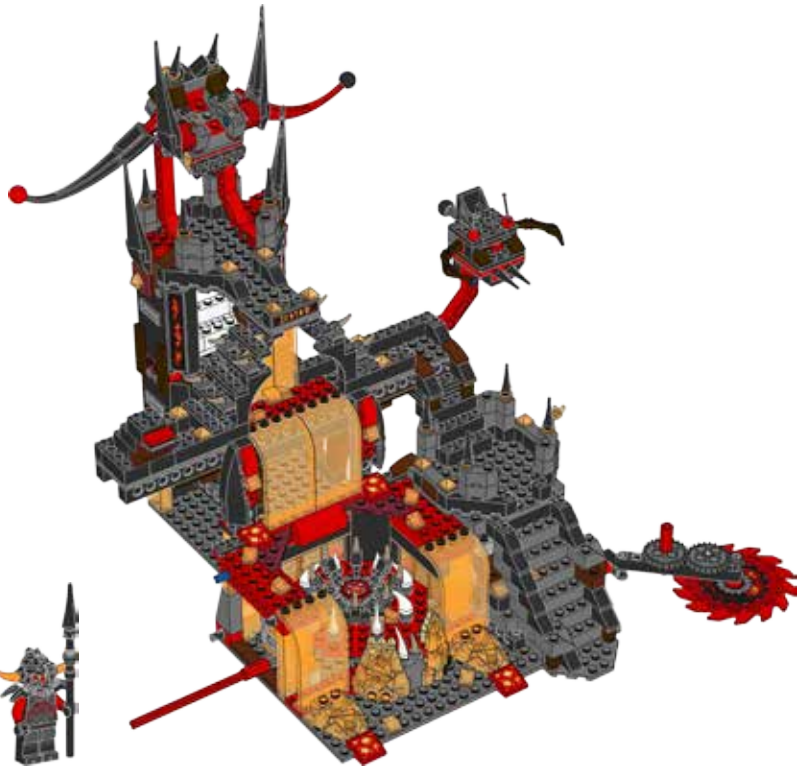

1

2

1



2

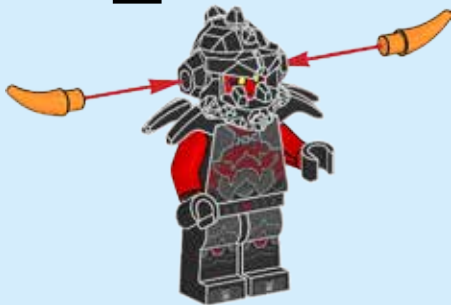

3



2x

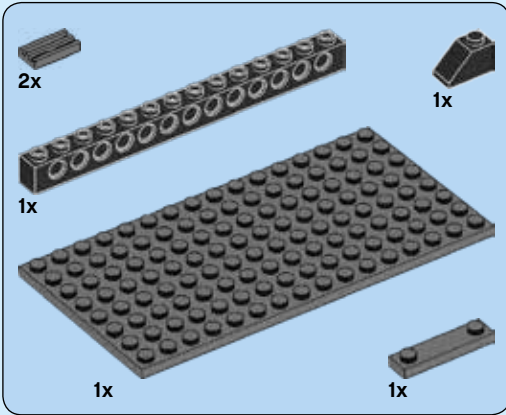

118

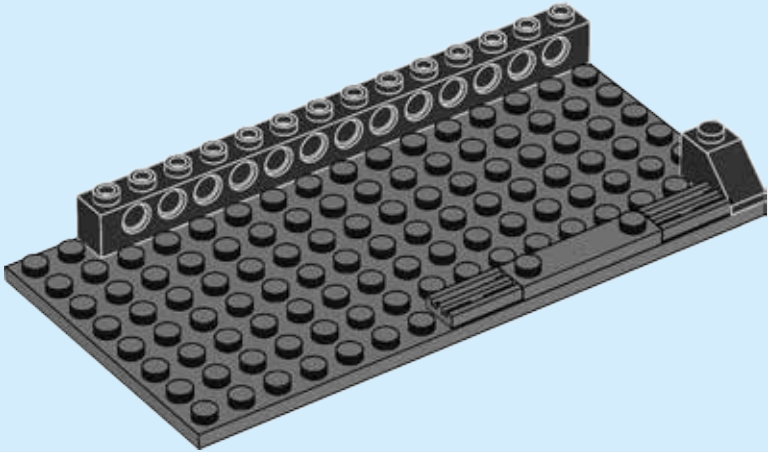

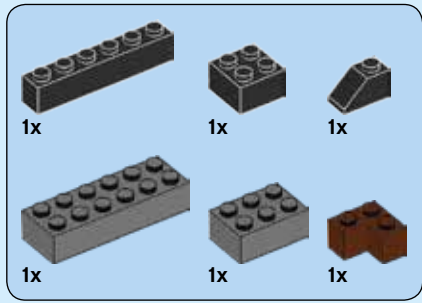

119

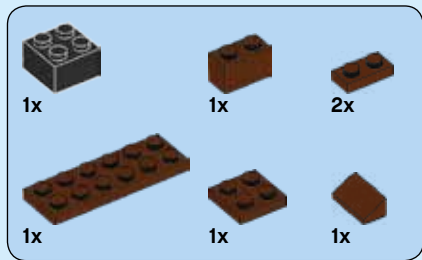
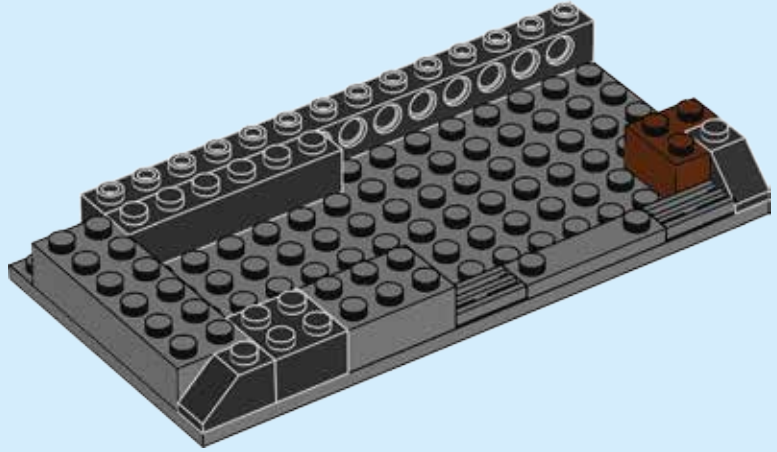

120

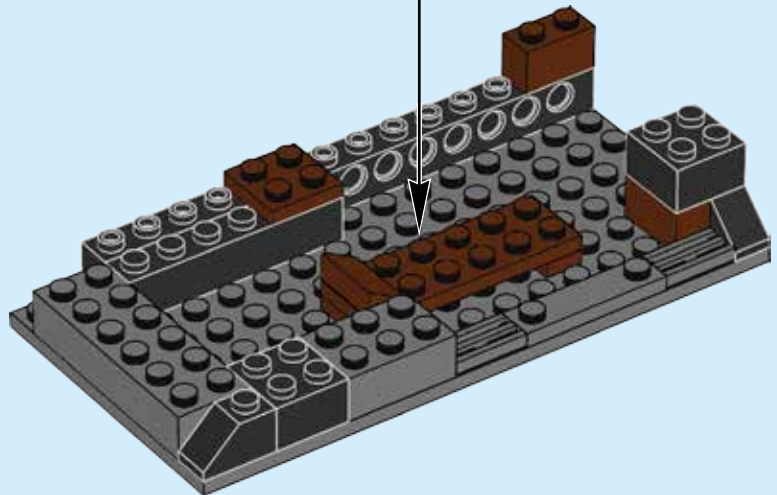
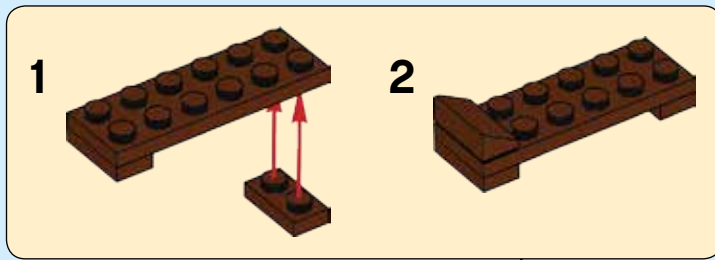

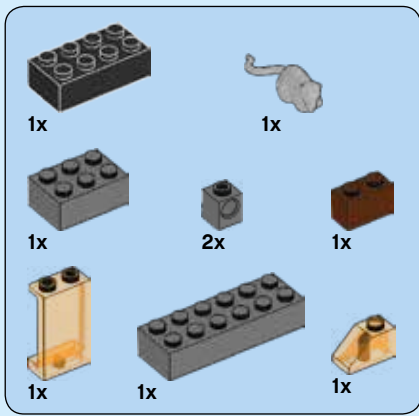

121

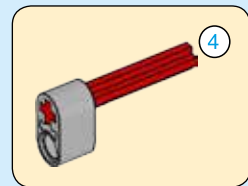
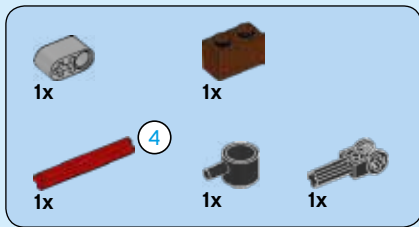
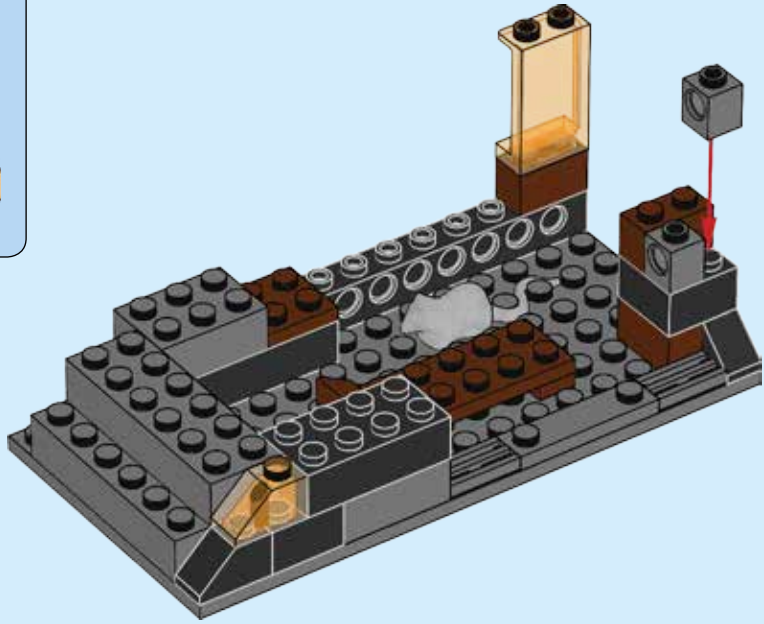

122

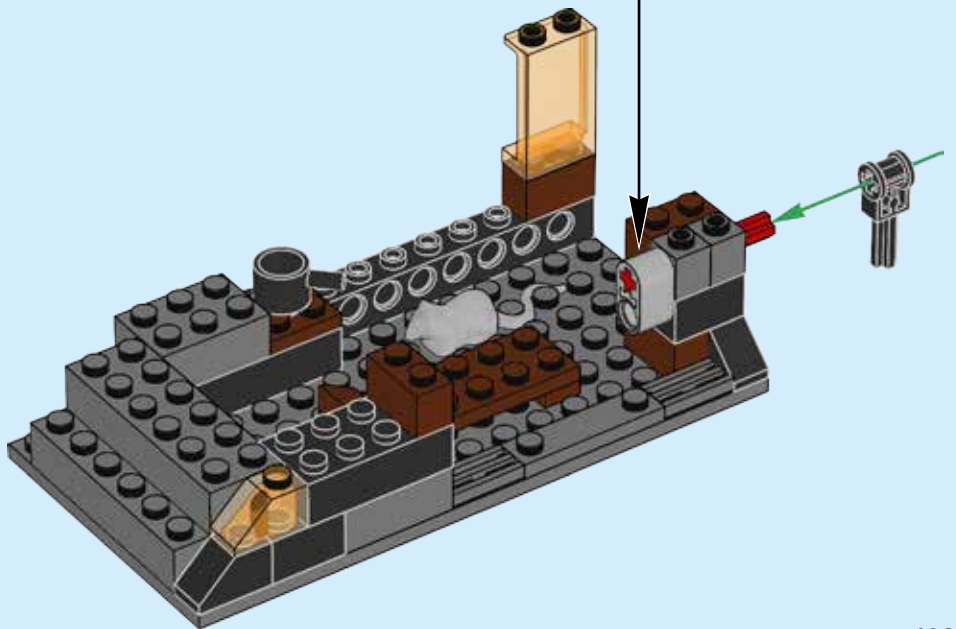

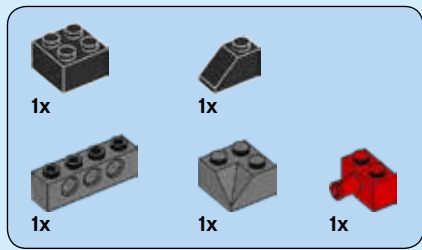

123

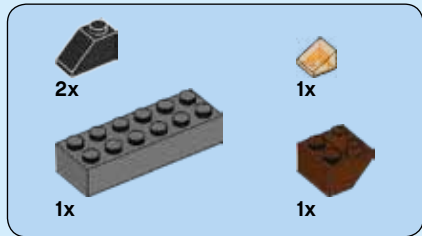
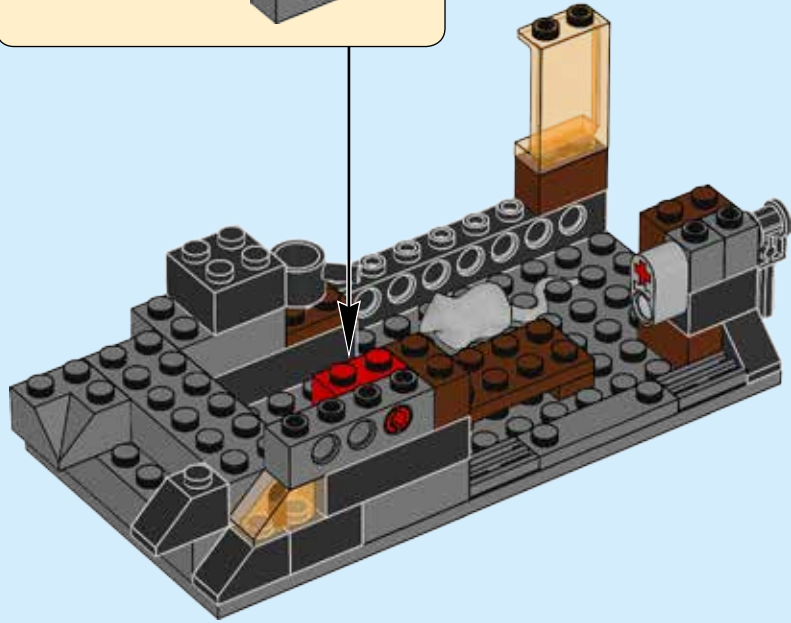
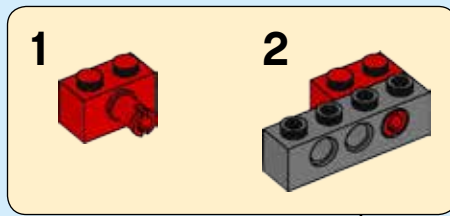

124

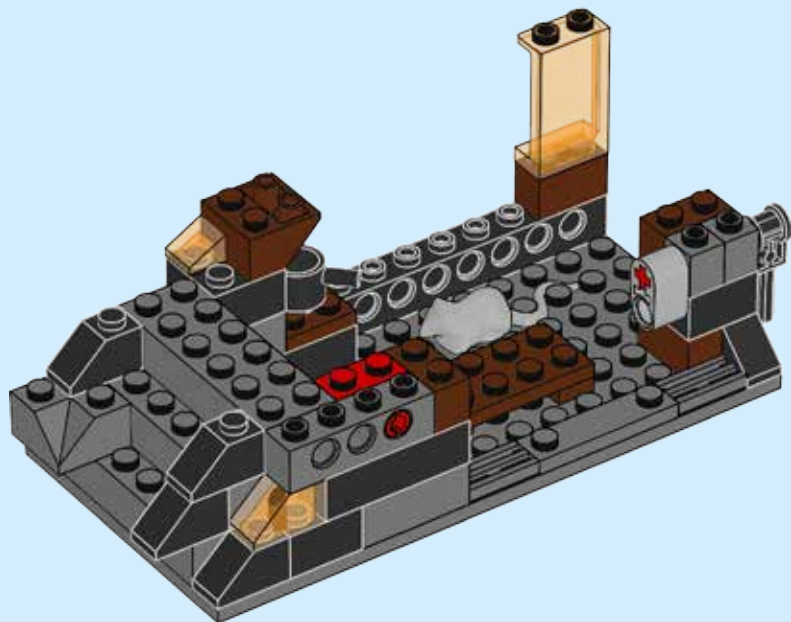

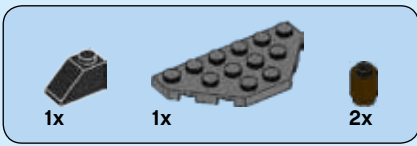

125

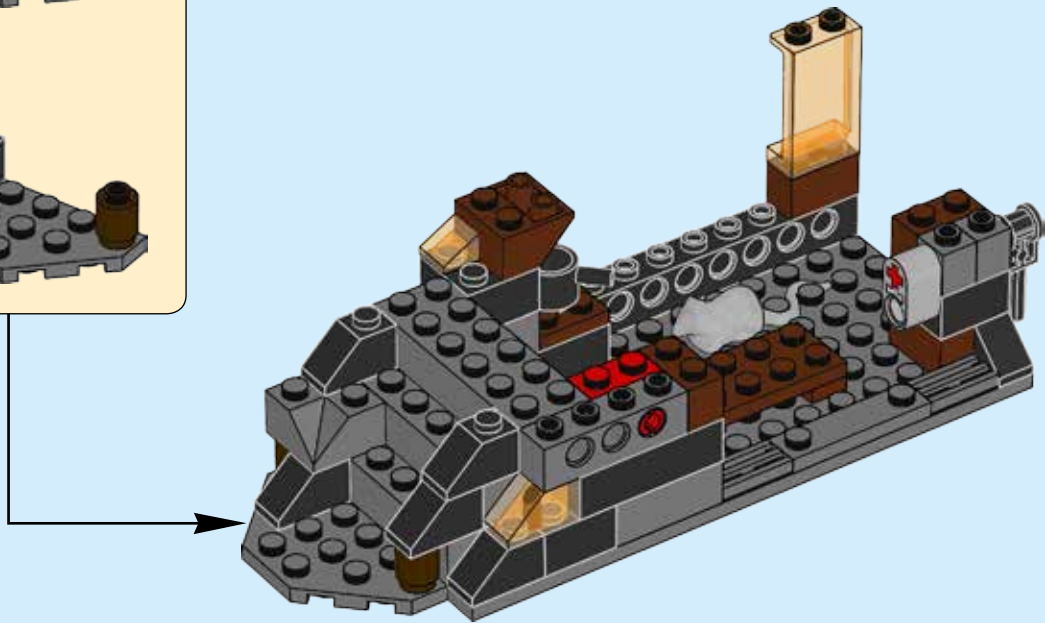
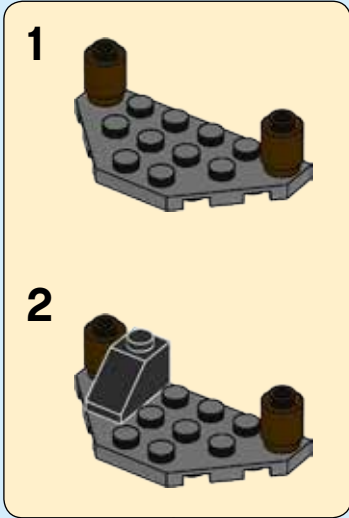

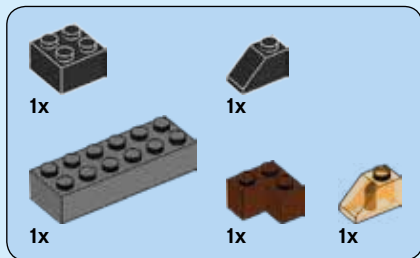

126

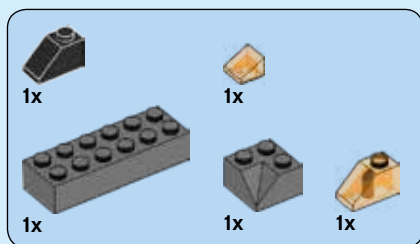
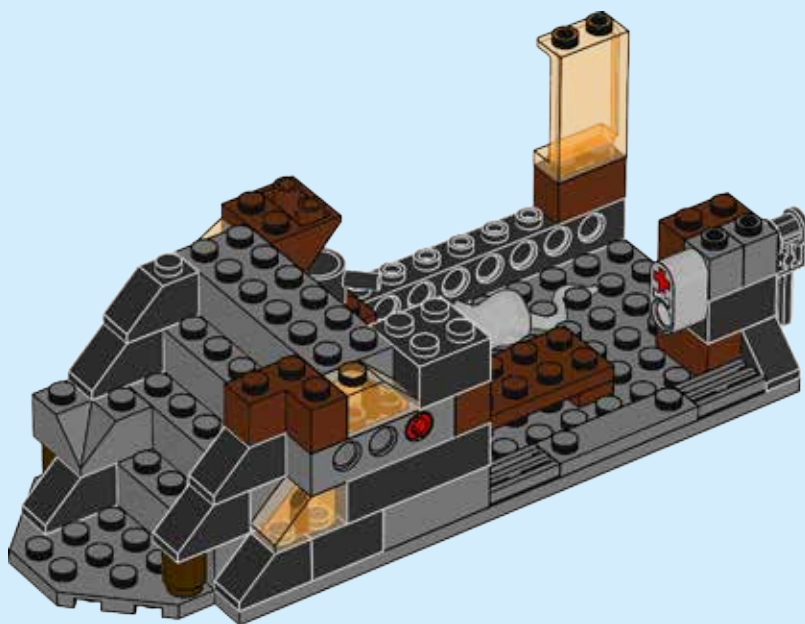

127

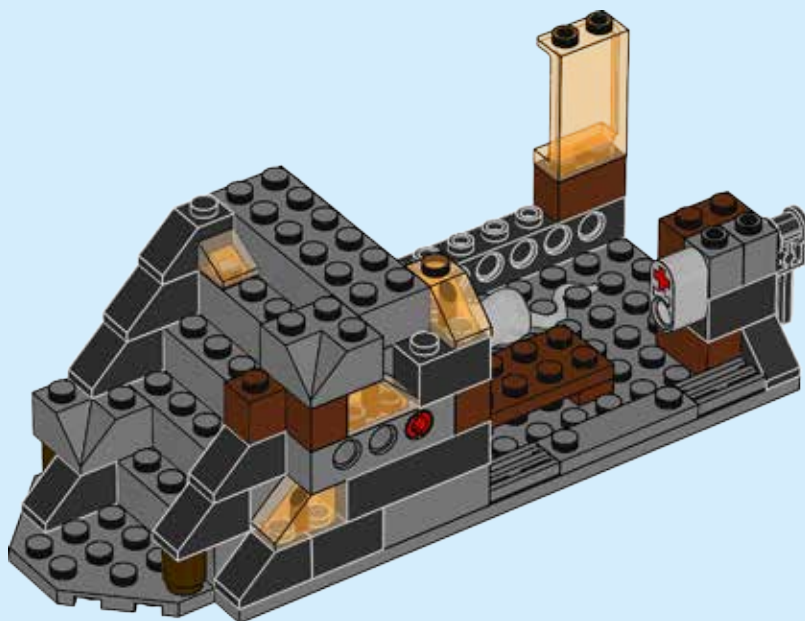

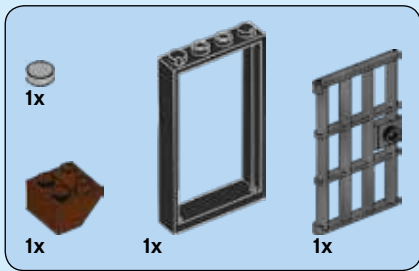

128

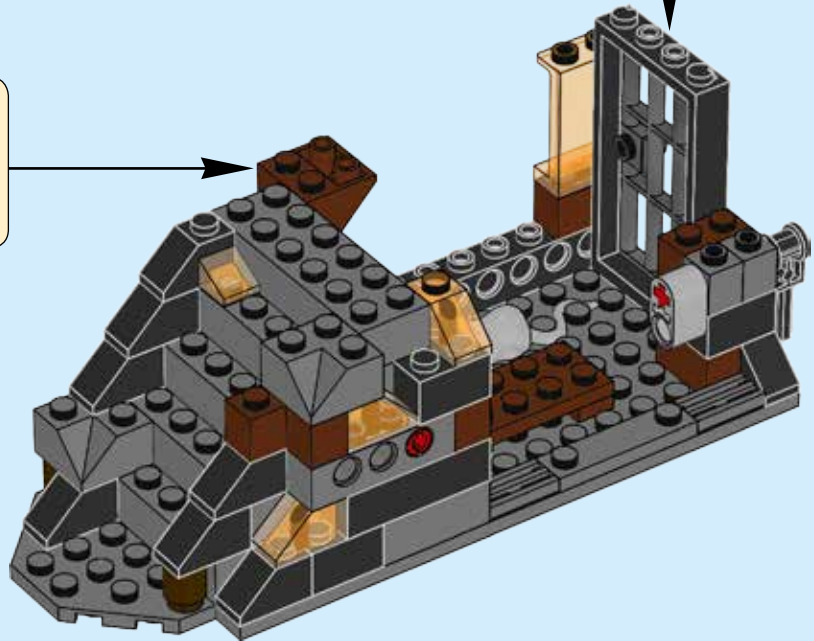
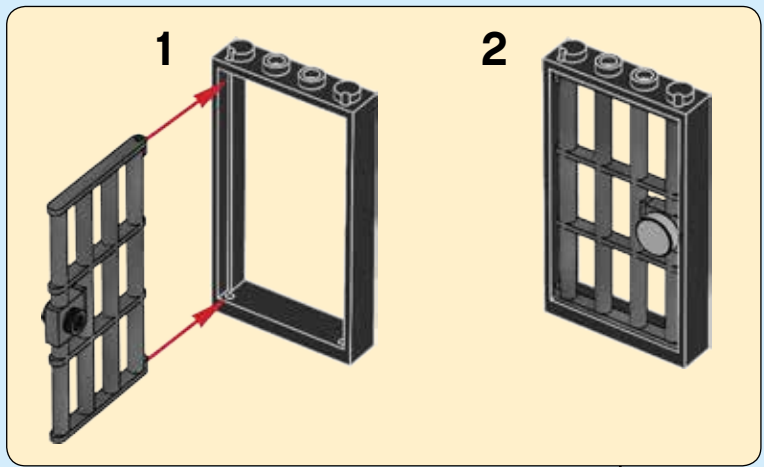

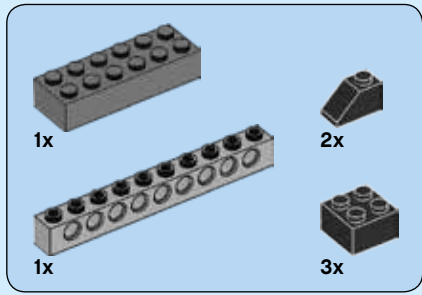

129

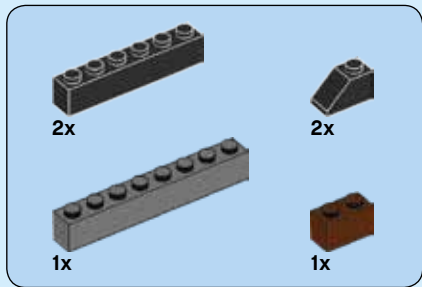
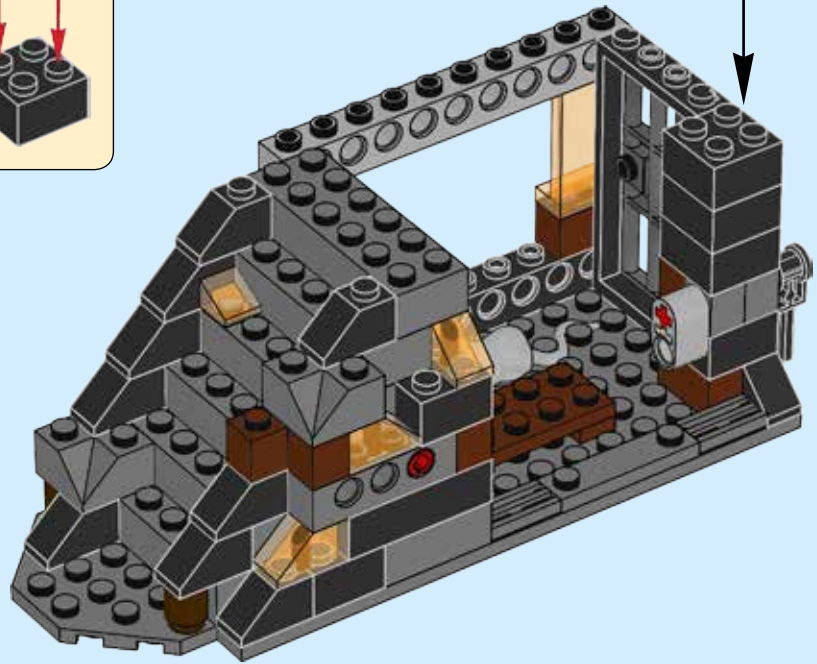
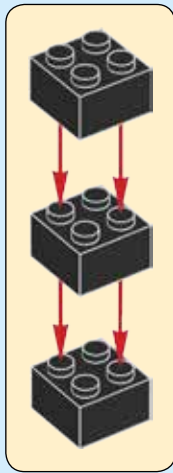

130



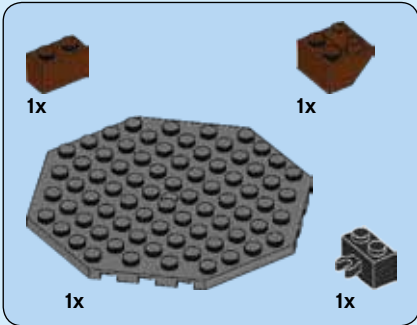

131

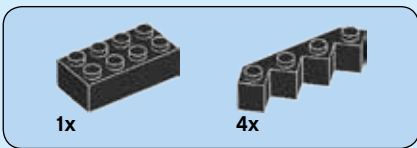
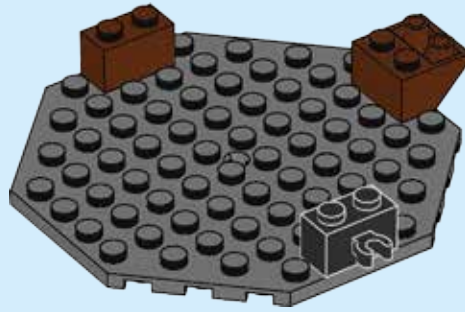

132

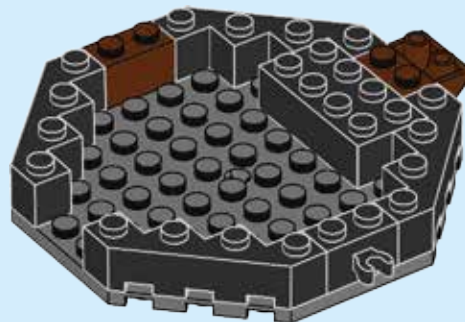

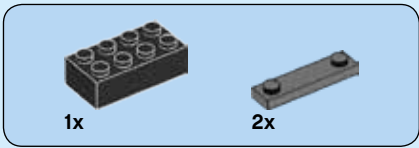

133

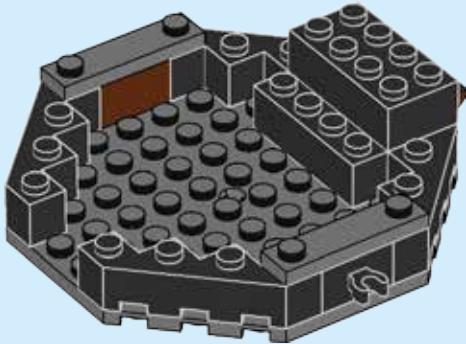

134

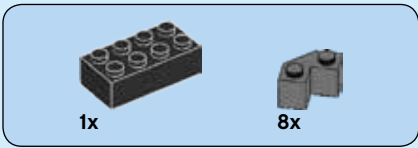
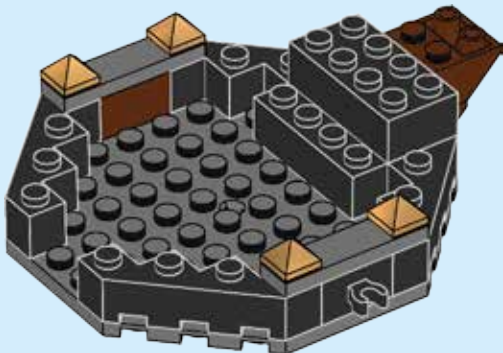

135

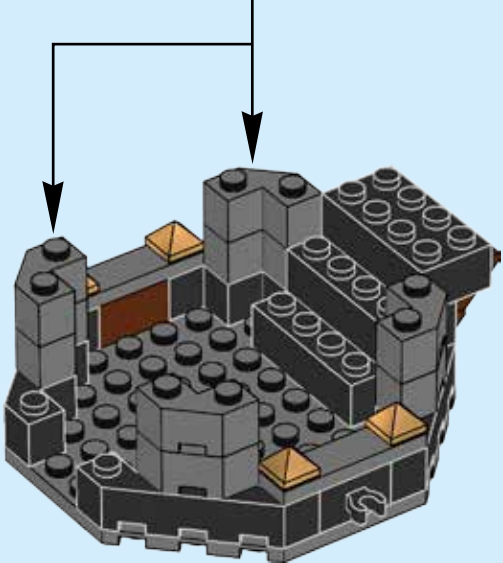
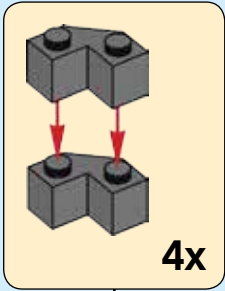



136

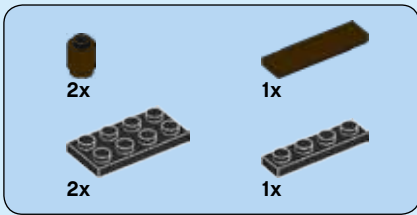
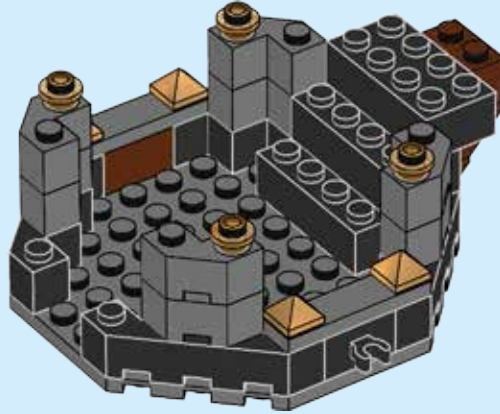

137

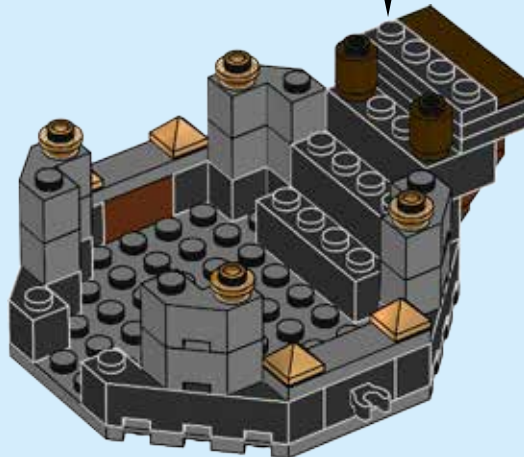
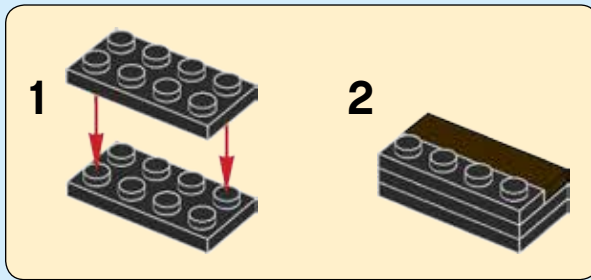



2x

138

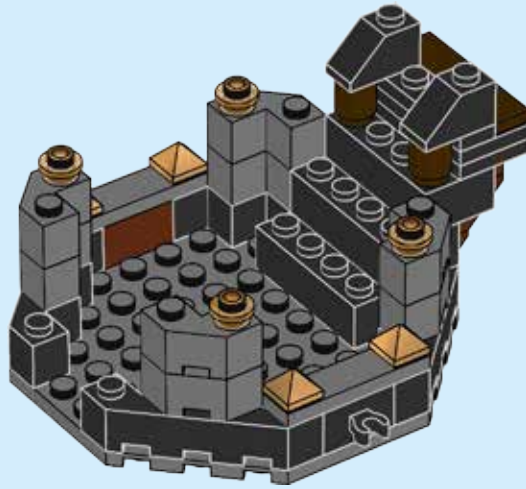

139

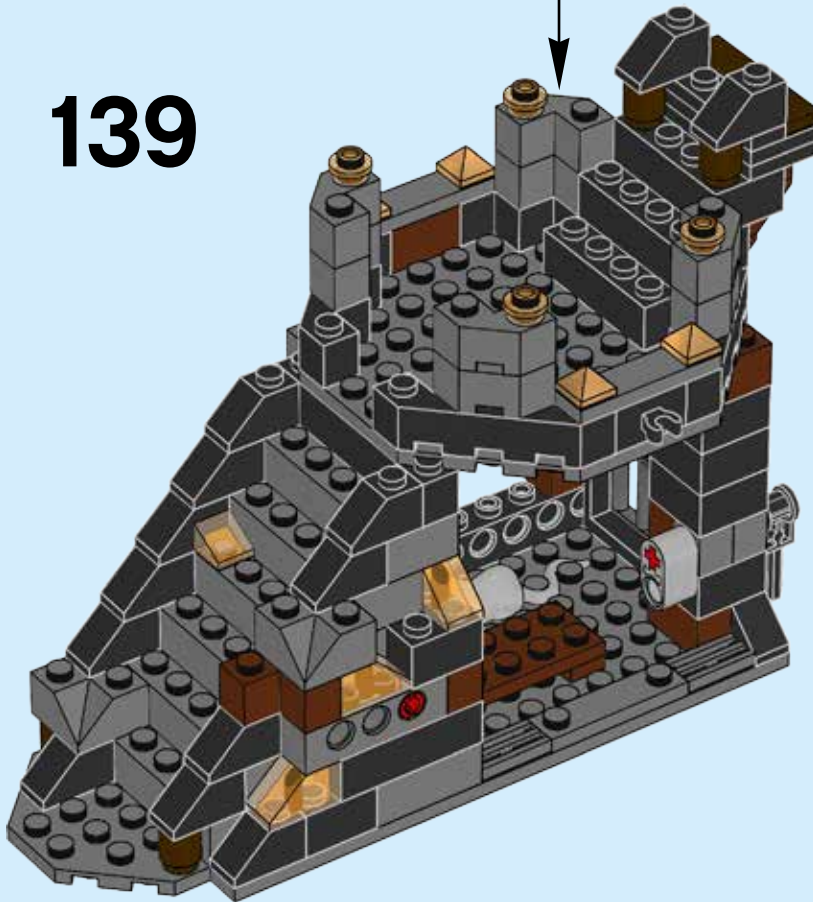



140

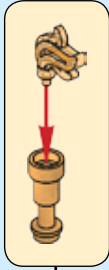
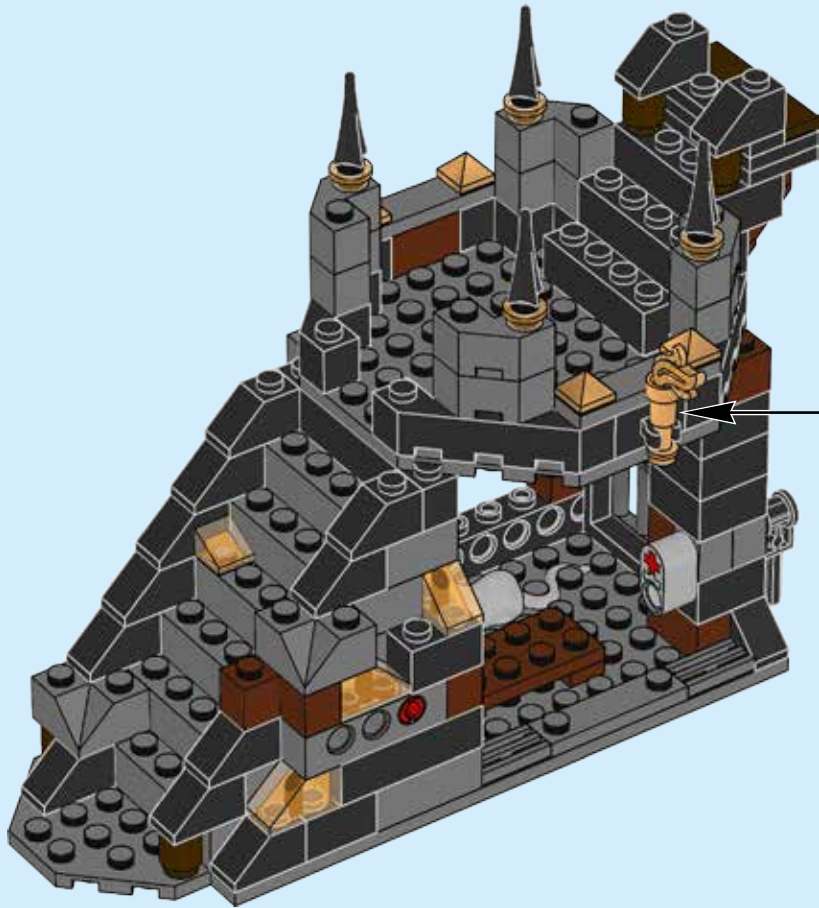

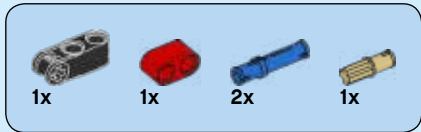

141

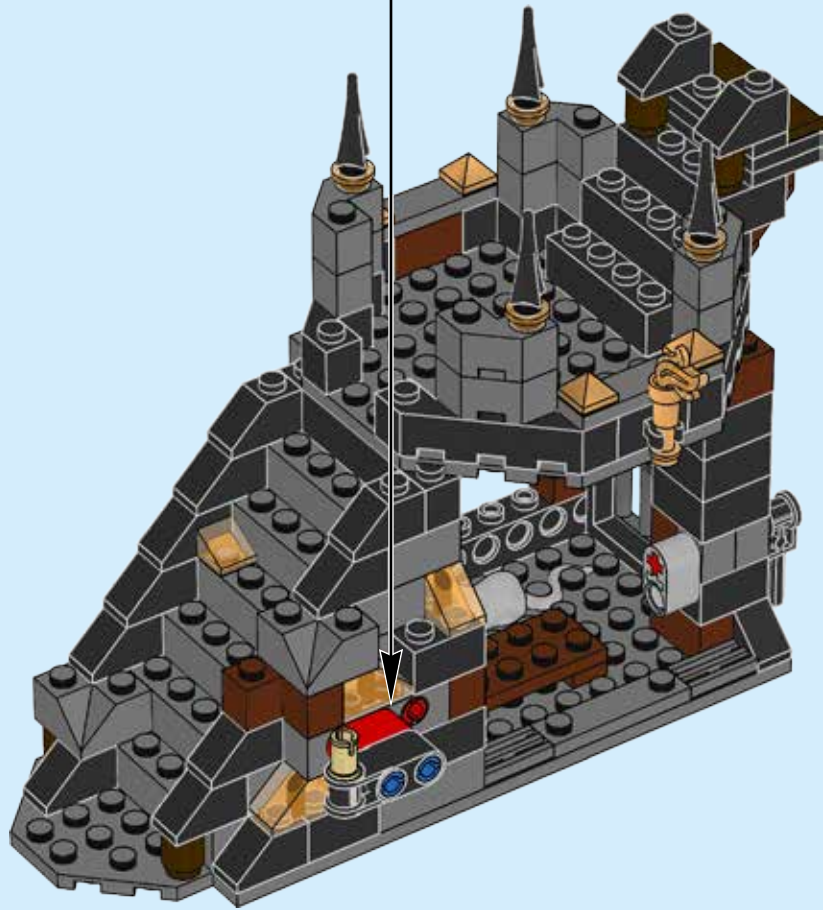
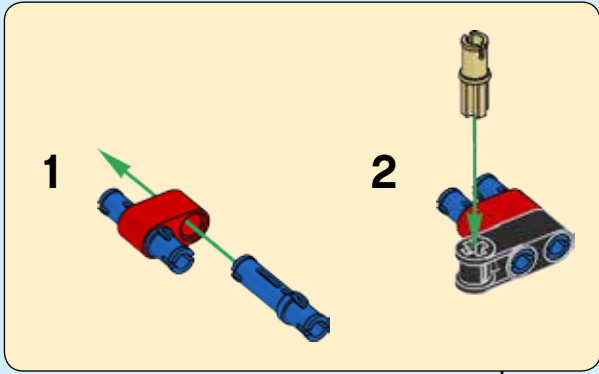

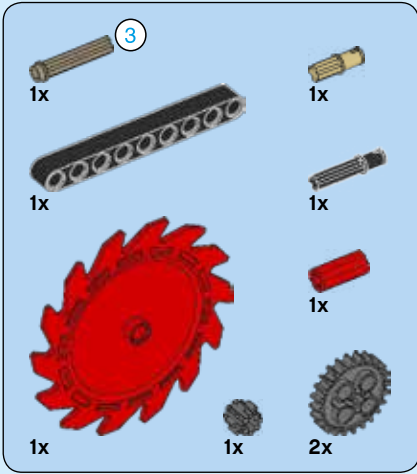
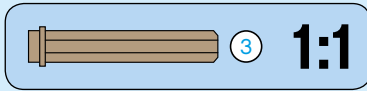

142

1

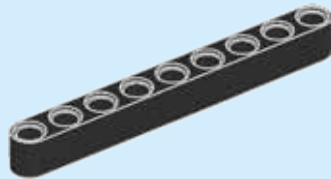

2

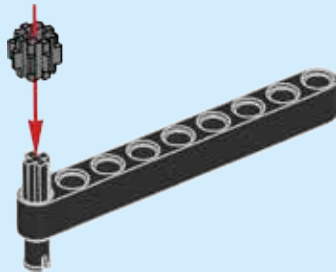

3

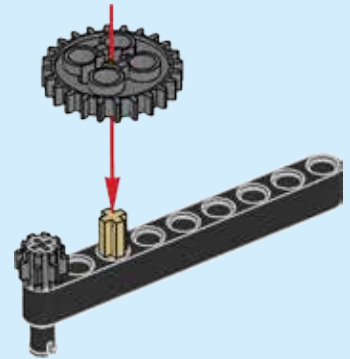

4

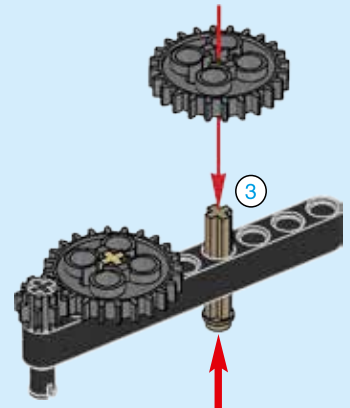

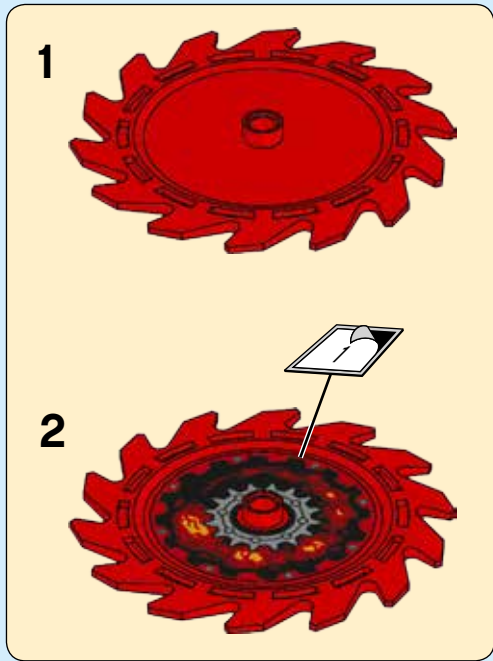

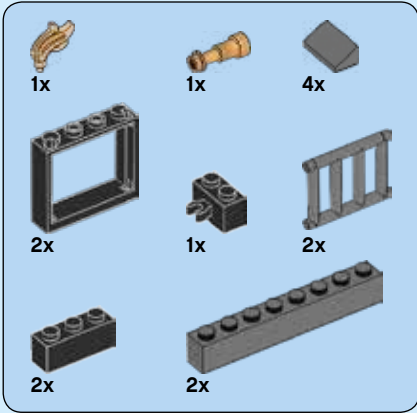

143

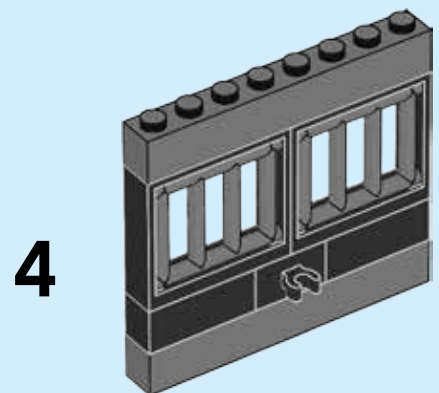
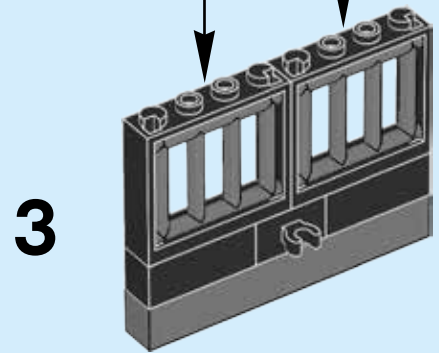
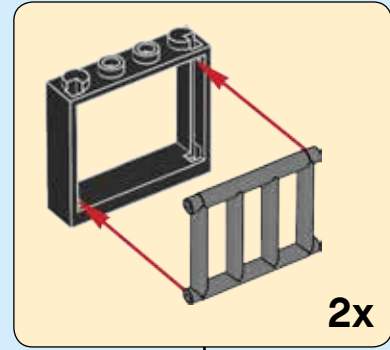
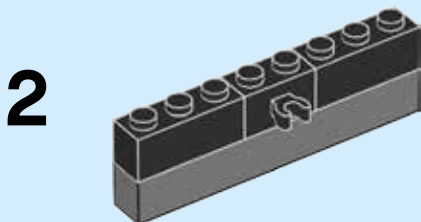
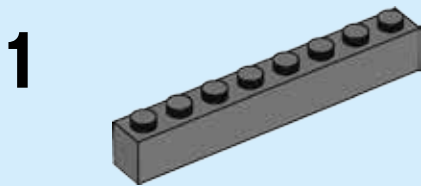

5

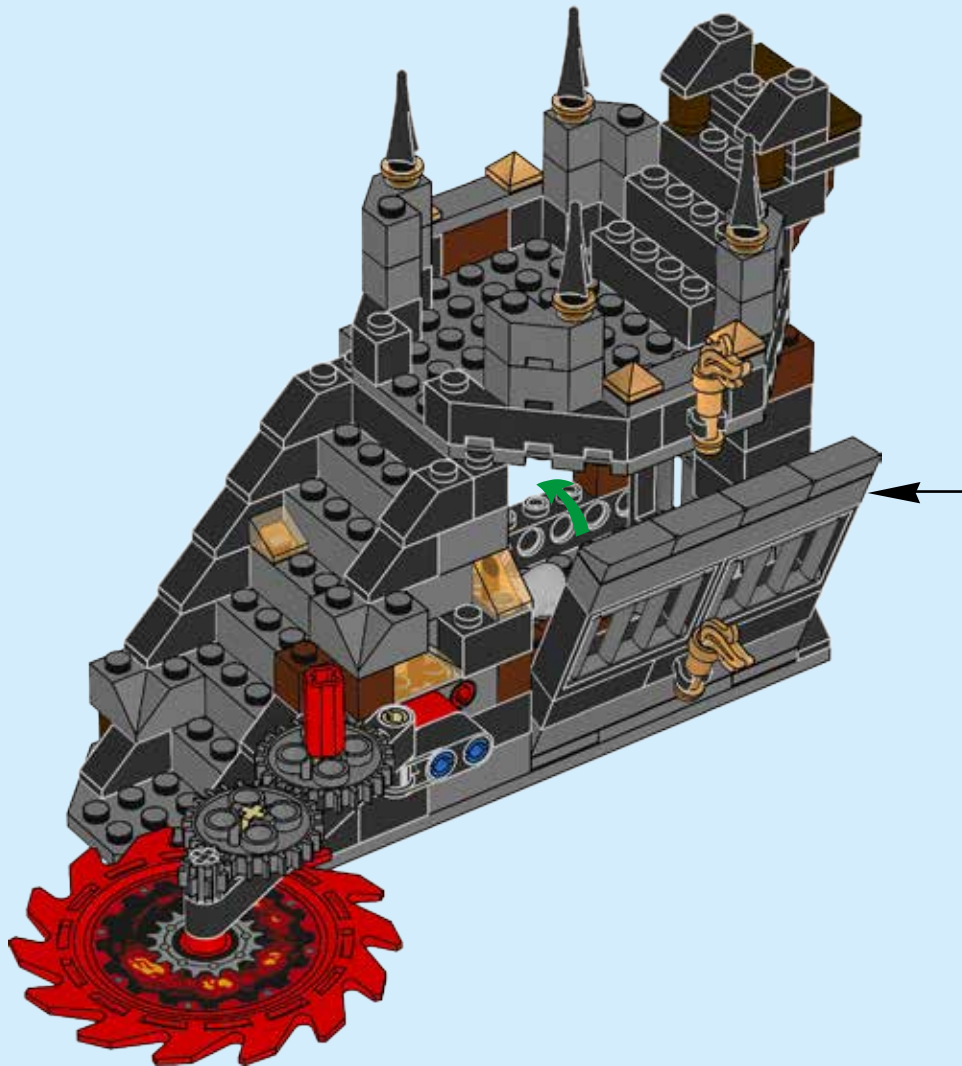
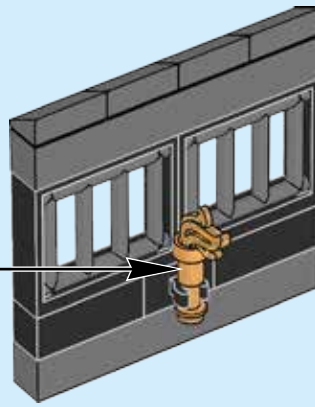
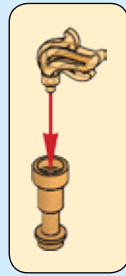

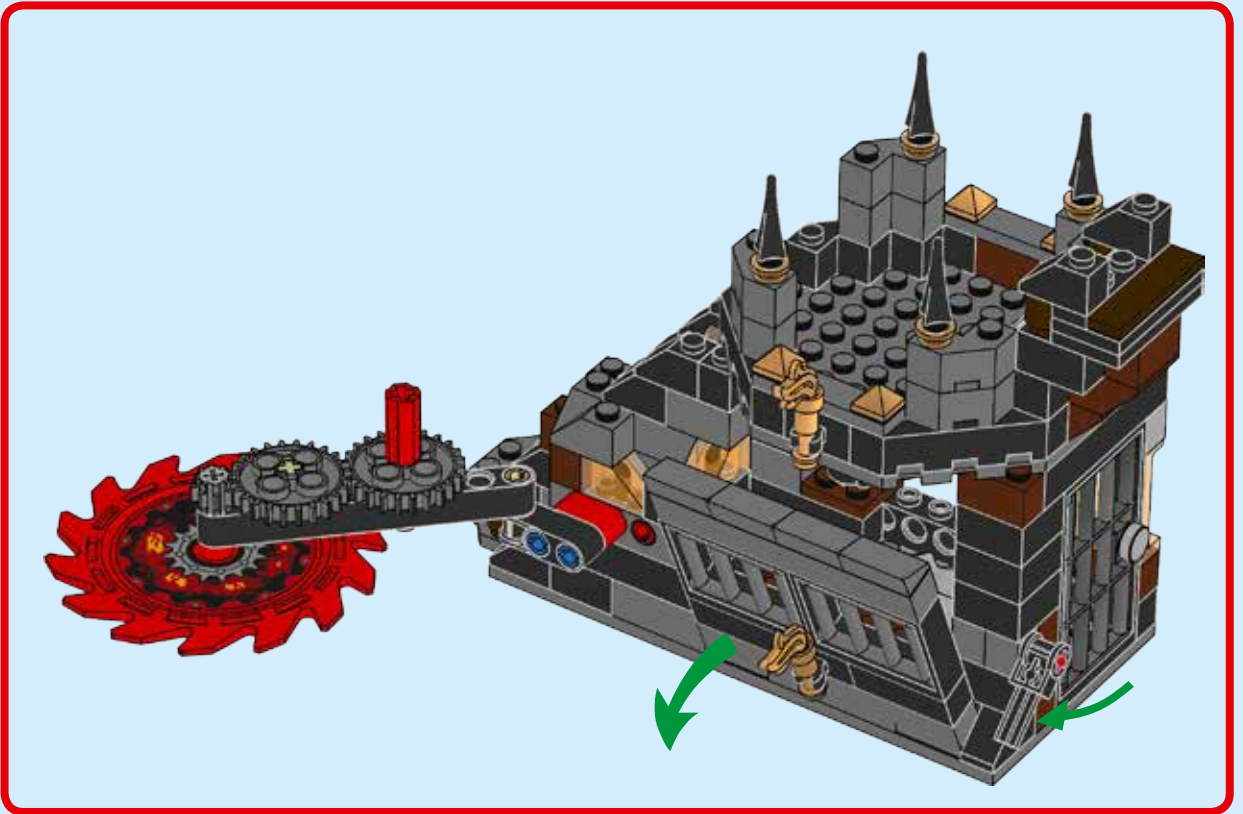
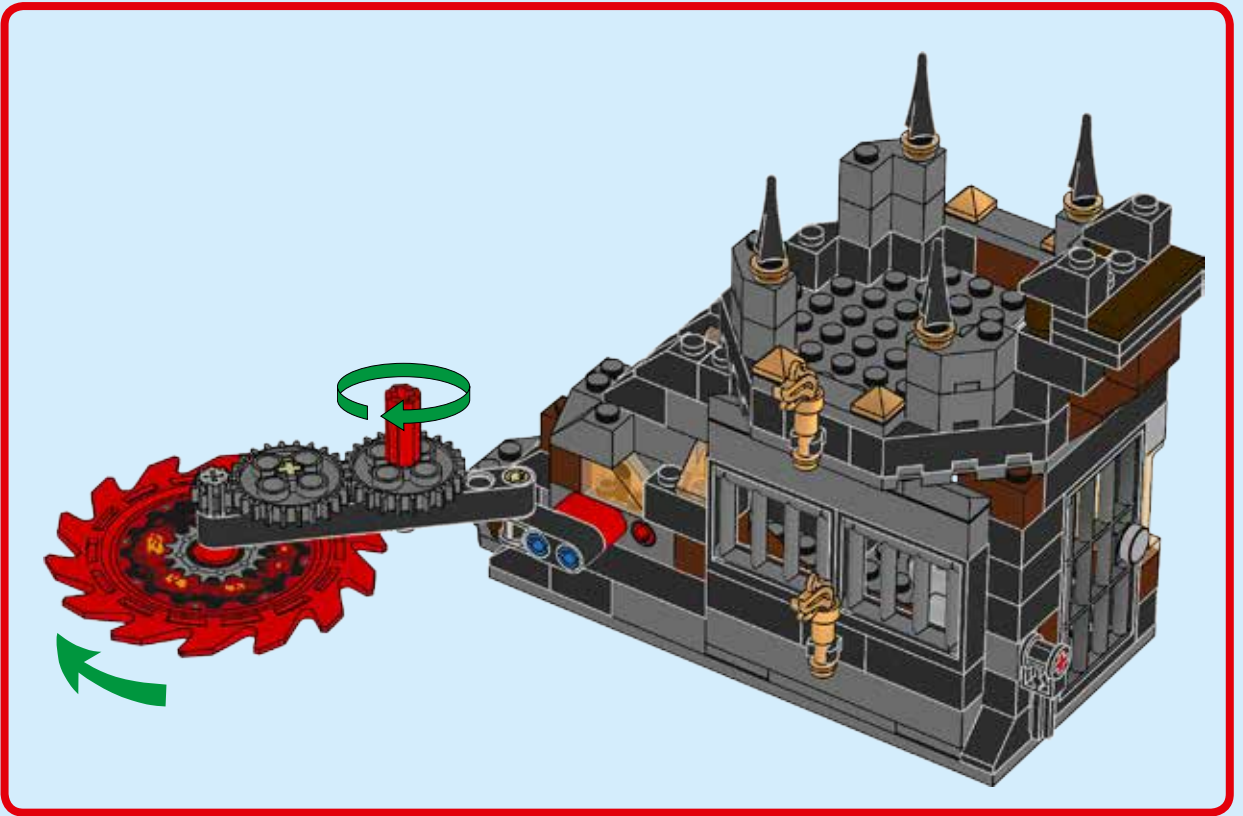

144

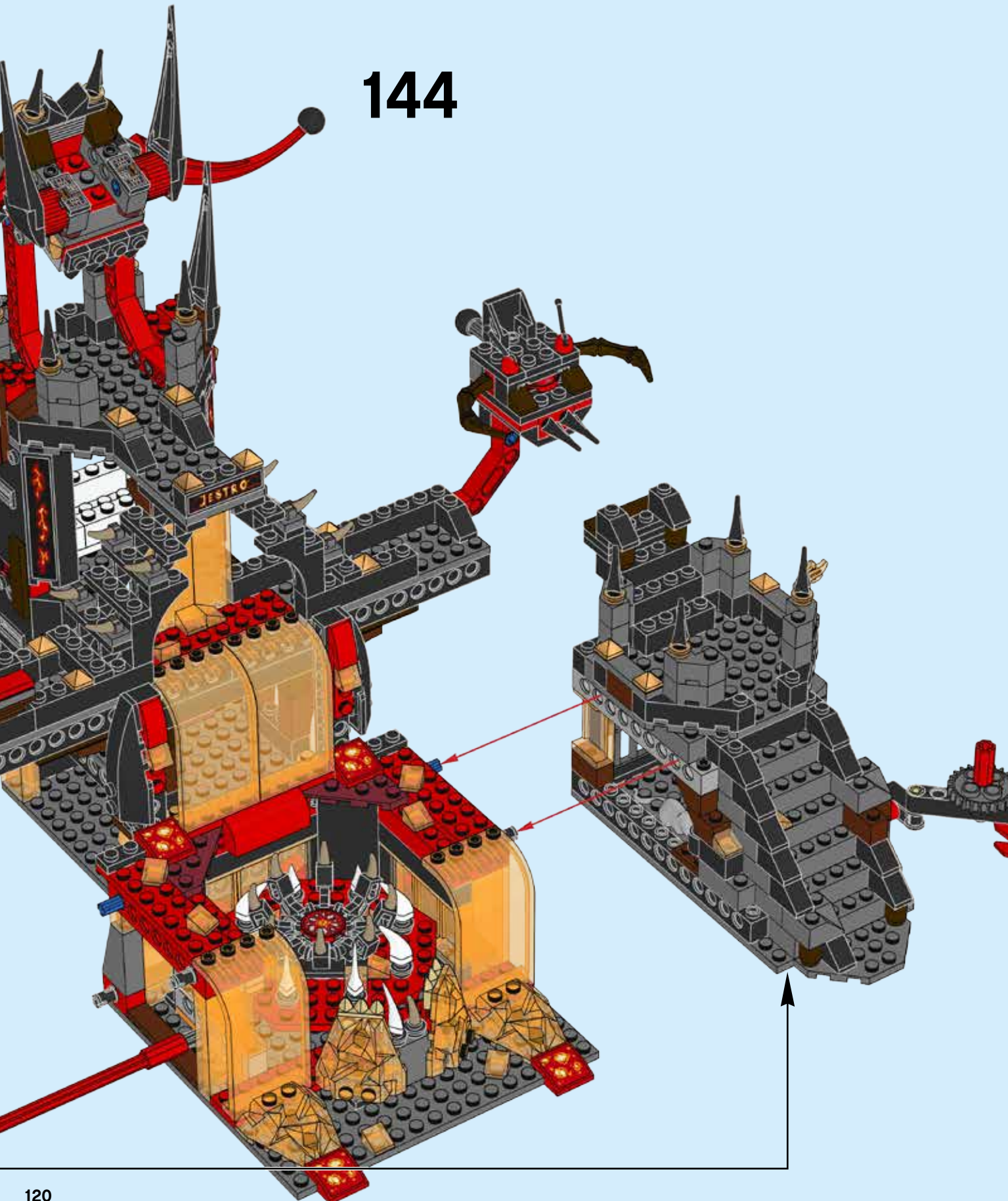

1x  3x 

145

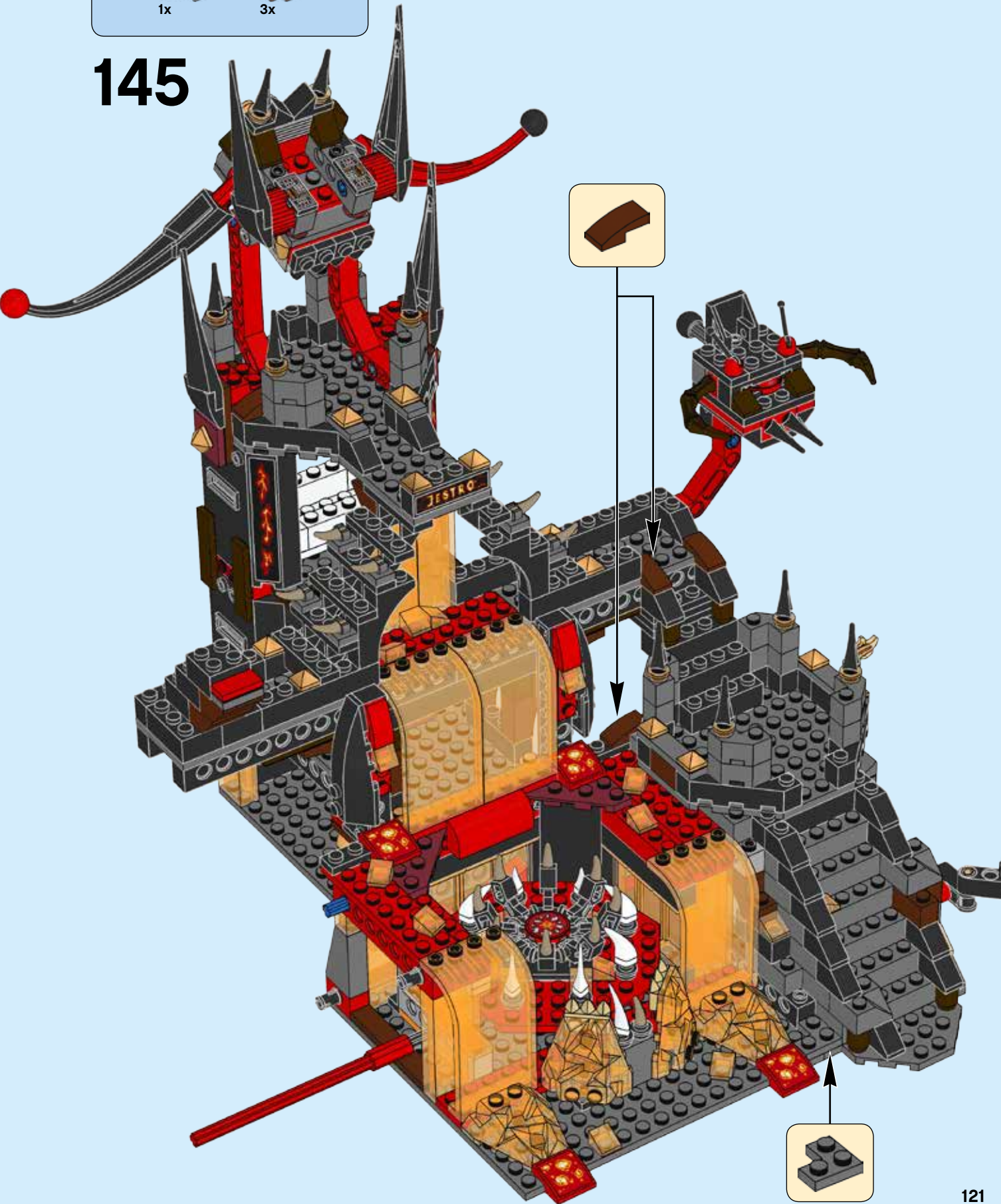

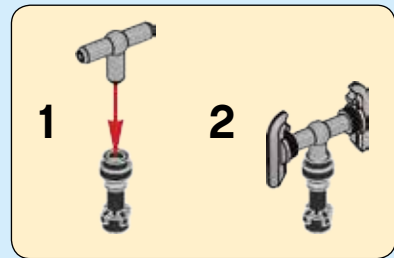
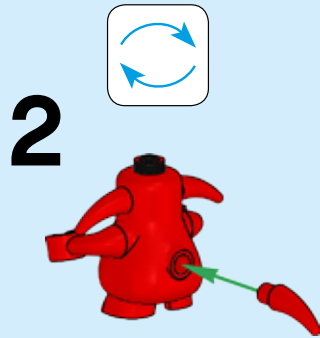
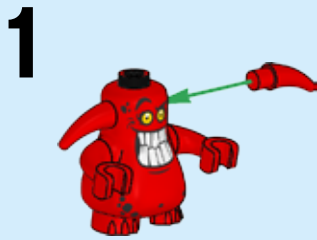

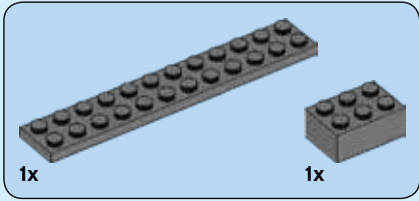

146

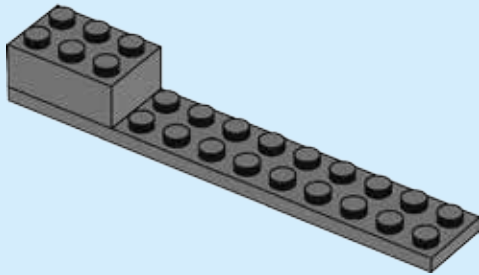

147

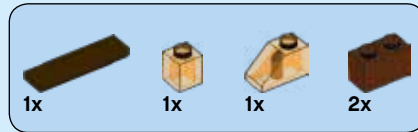
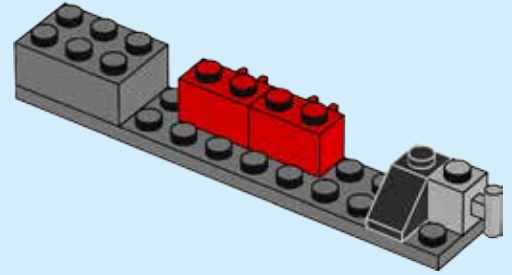

148

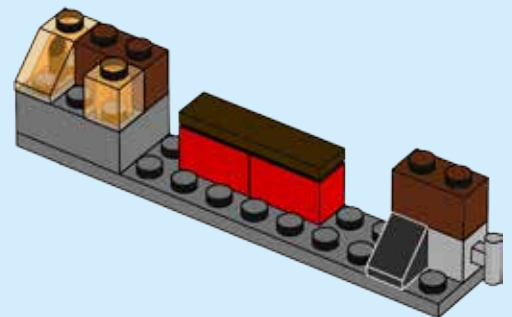



149

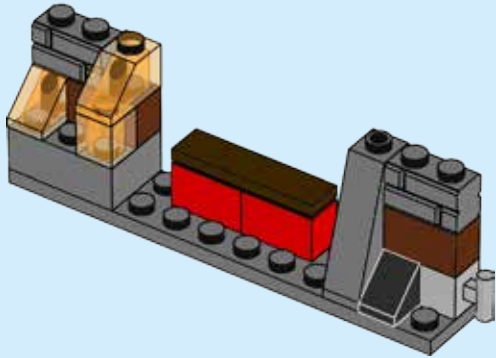

150

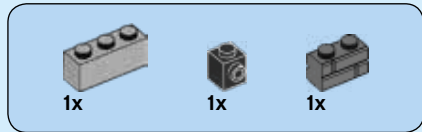
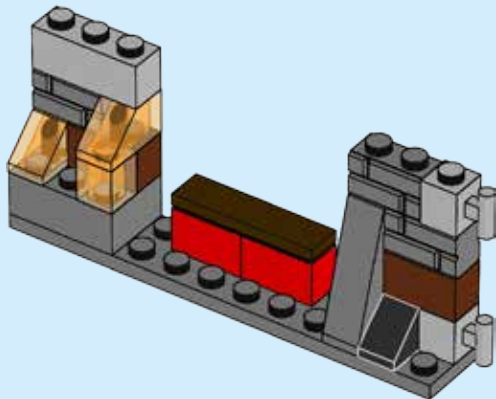

151

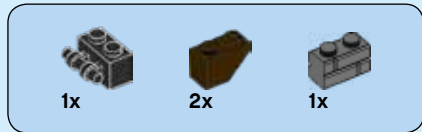
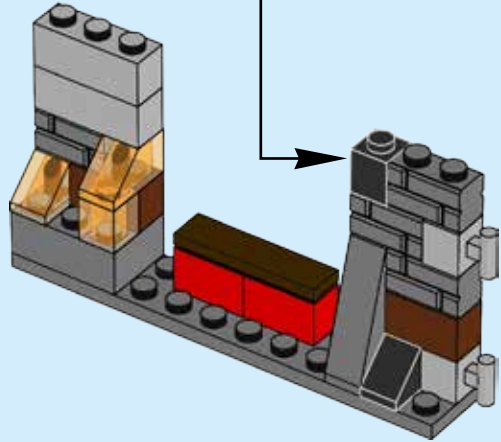
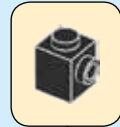

152

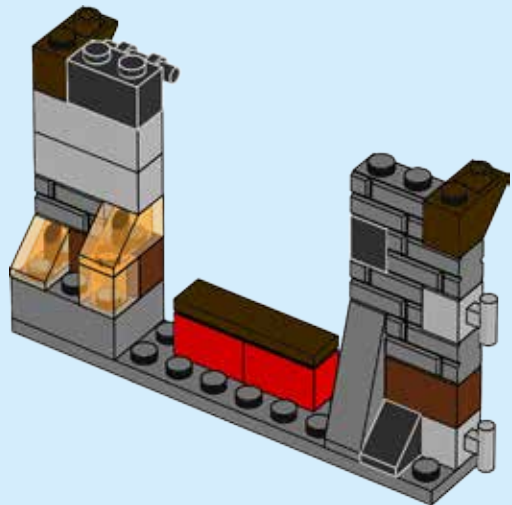

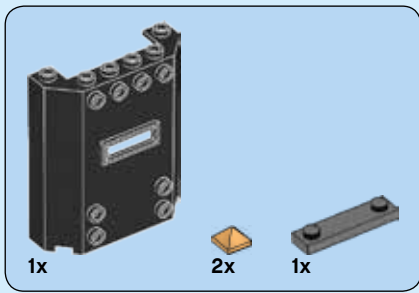

153

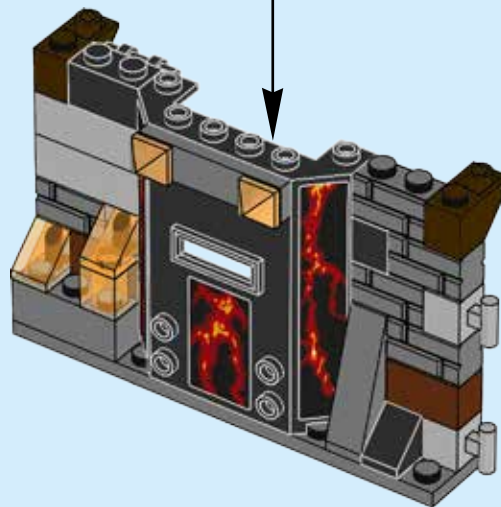
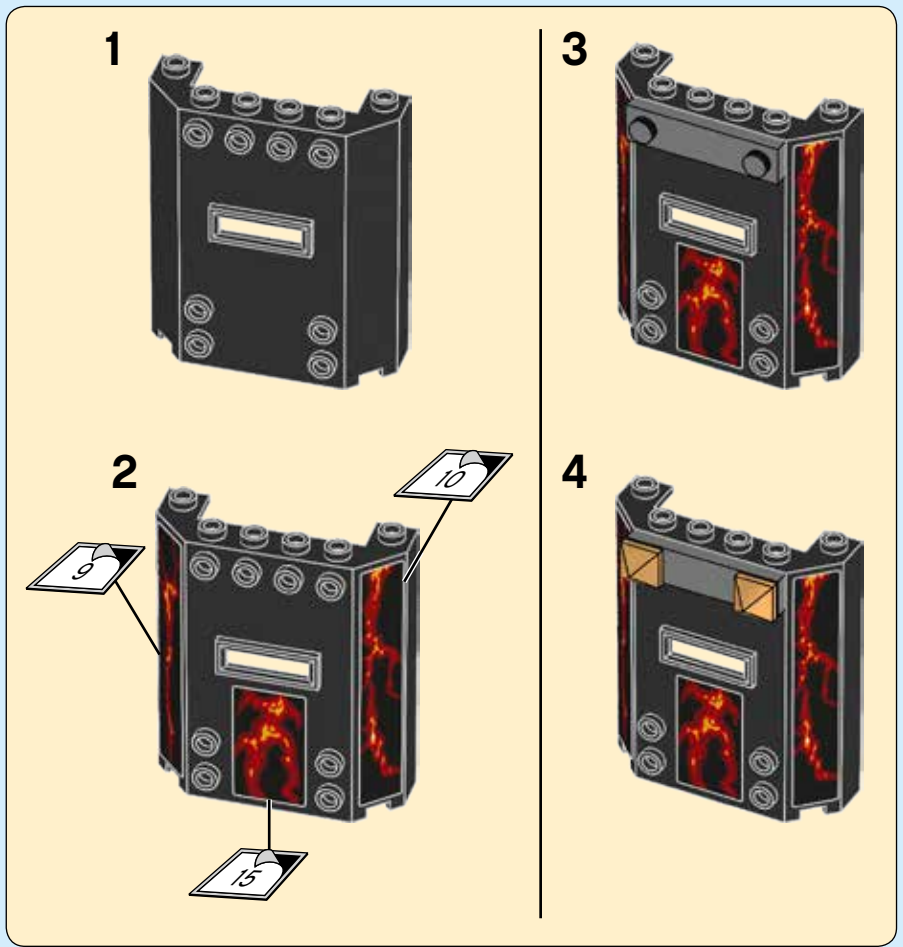

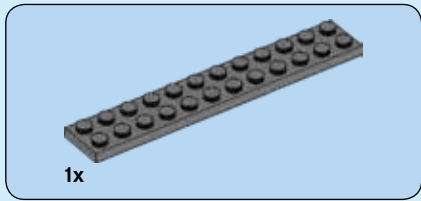

154

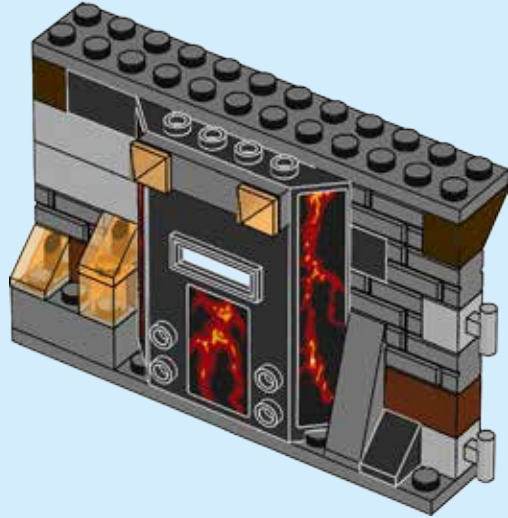

155

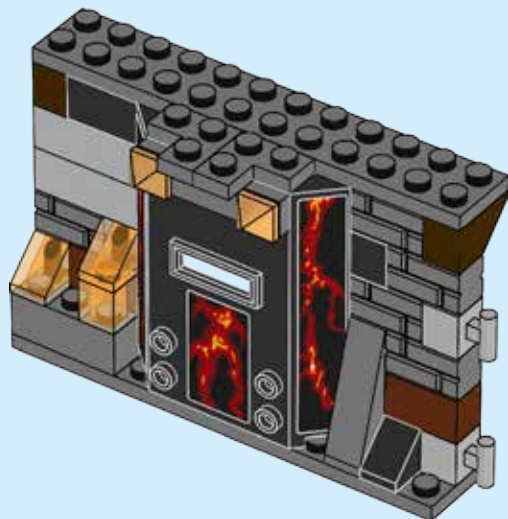

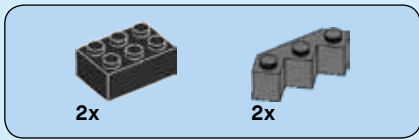

156

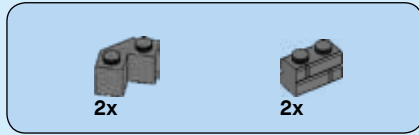
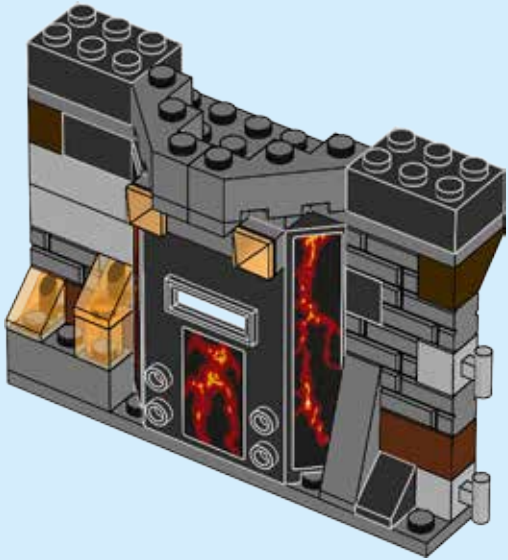

157

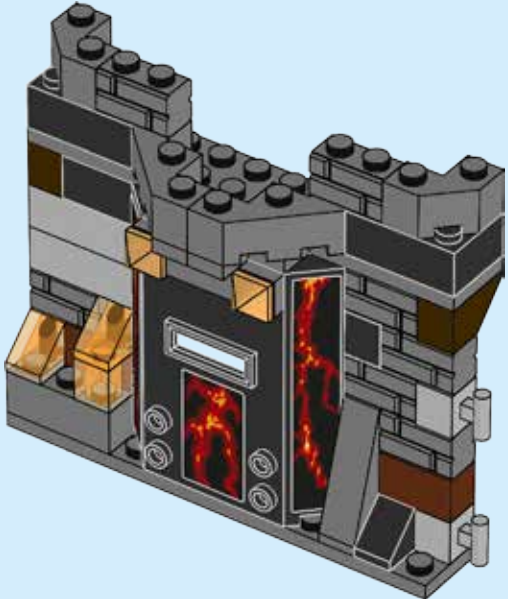



2x



2x

158

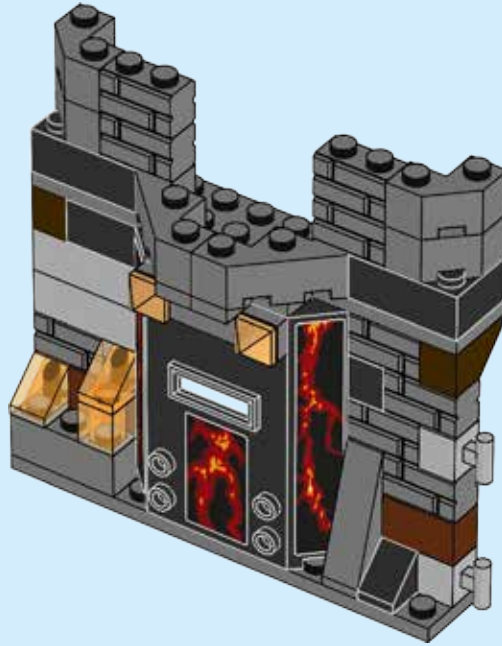

2x



2x



2x

159

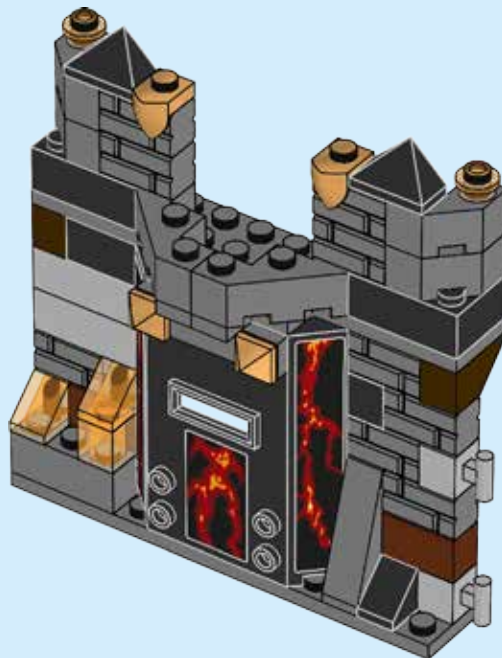

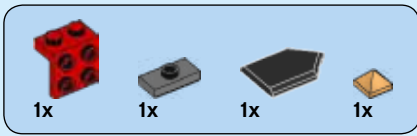

160

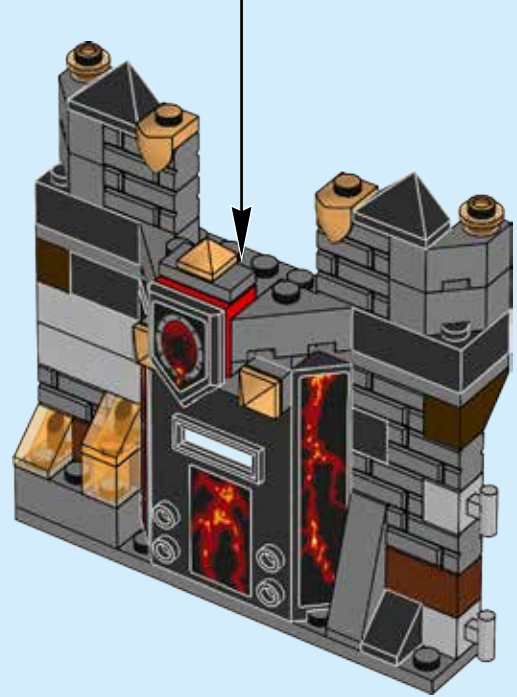

161

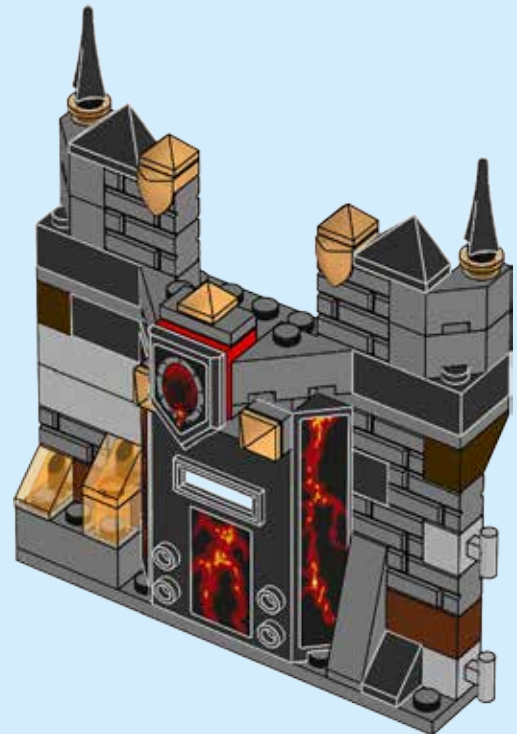

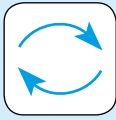
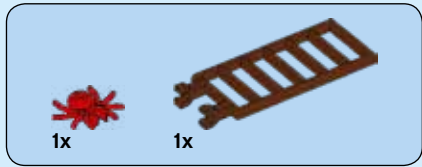

162

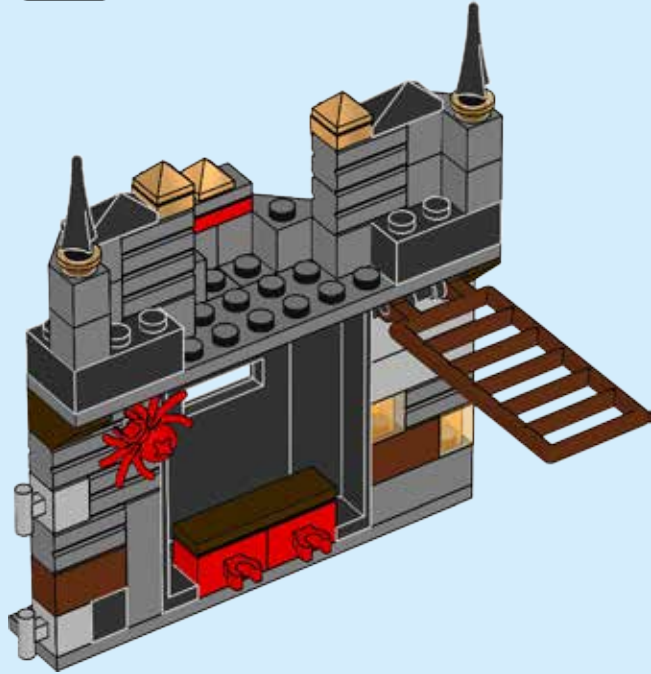

163

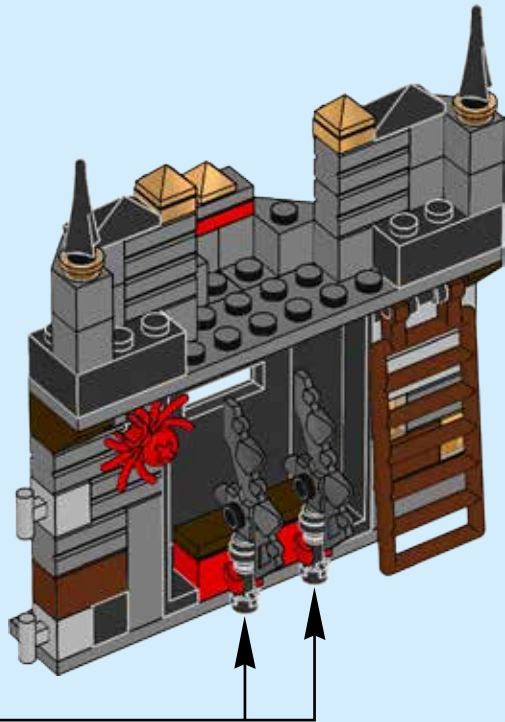
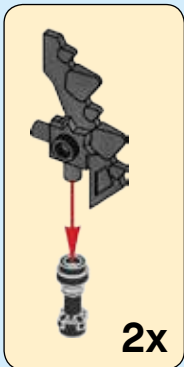

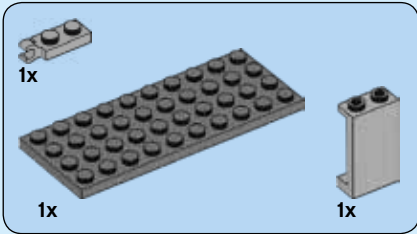
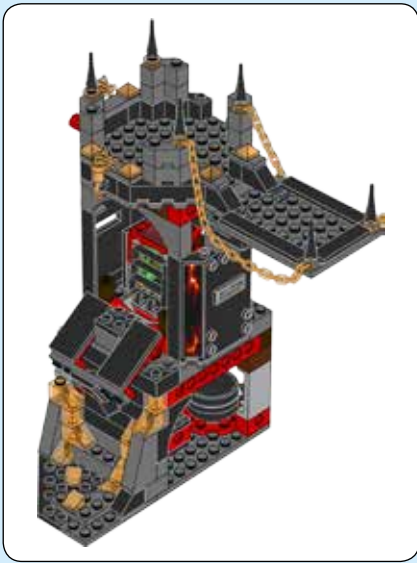

164

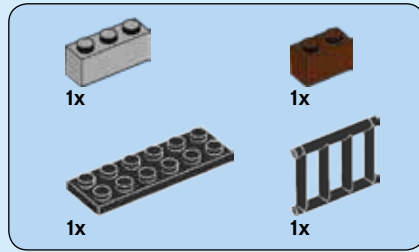
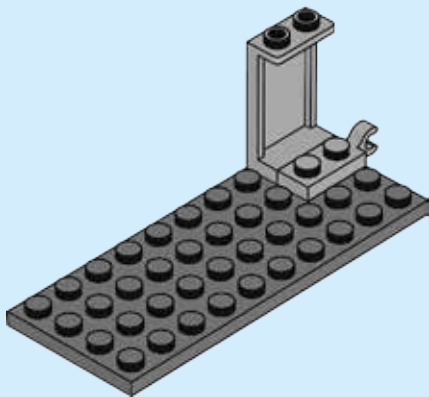

165

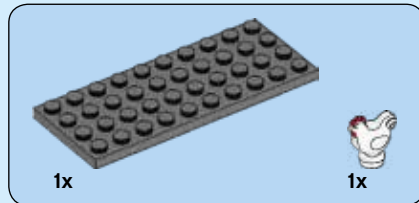
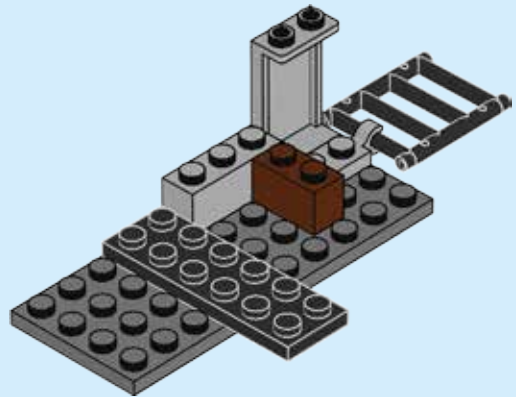

166

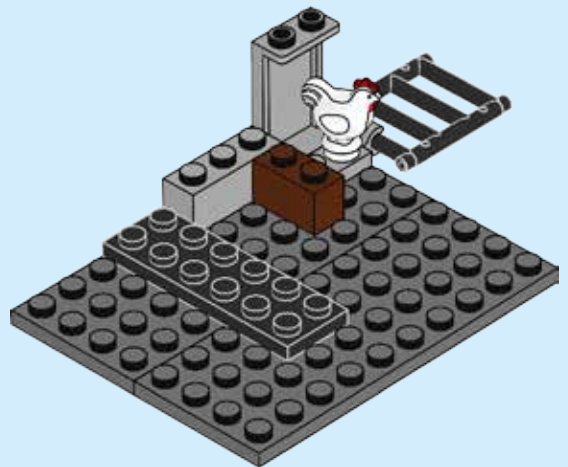



167

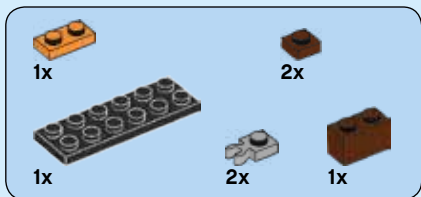
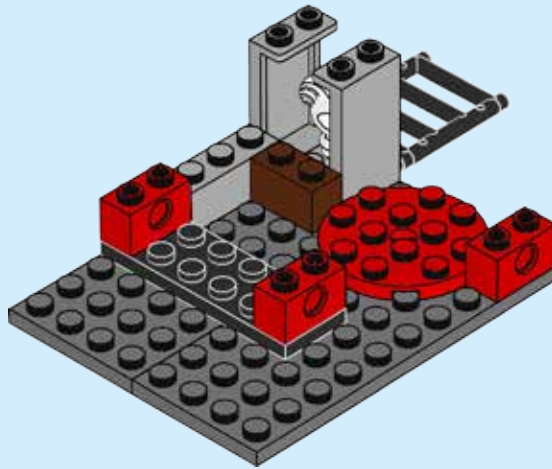

168

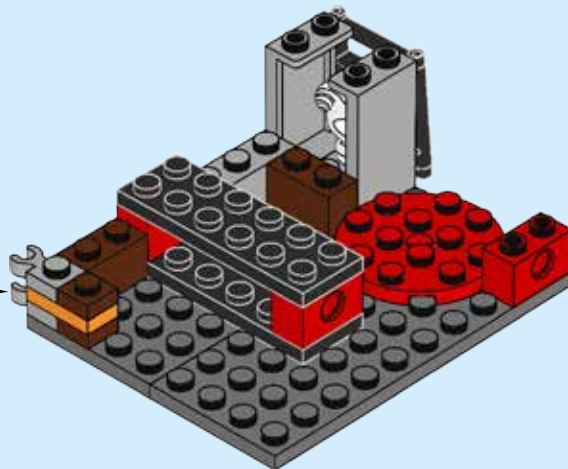
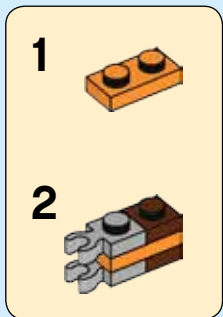

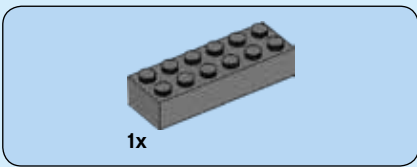

169

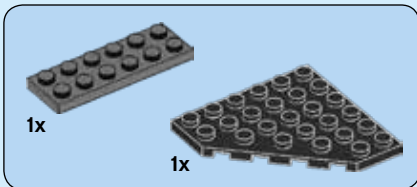
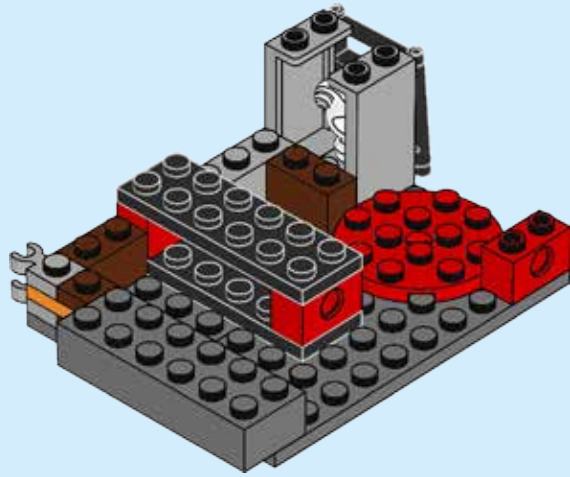

170

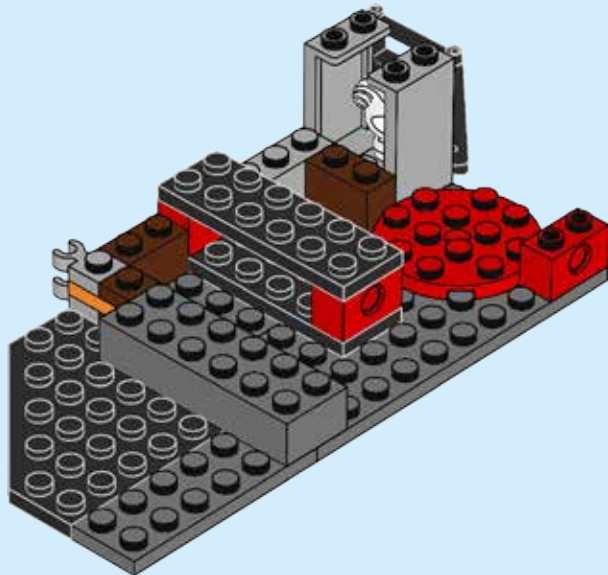



171

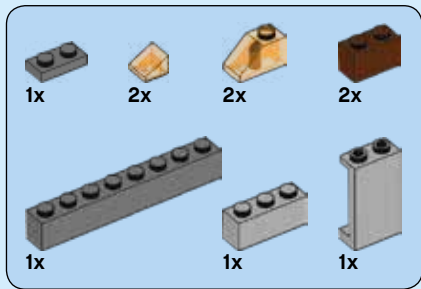
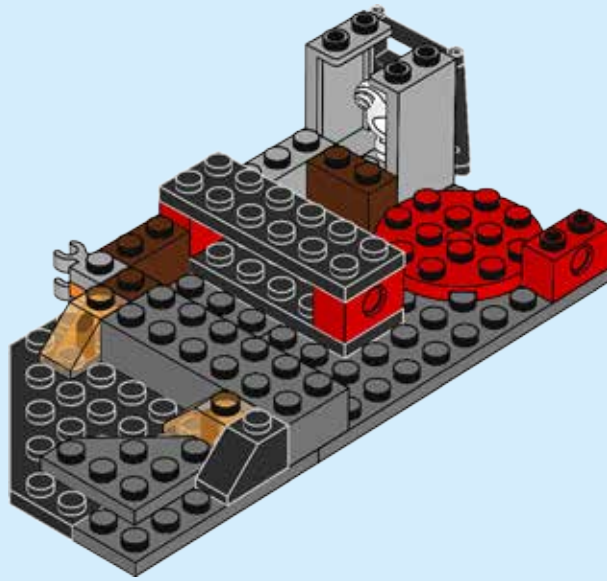

172

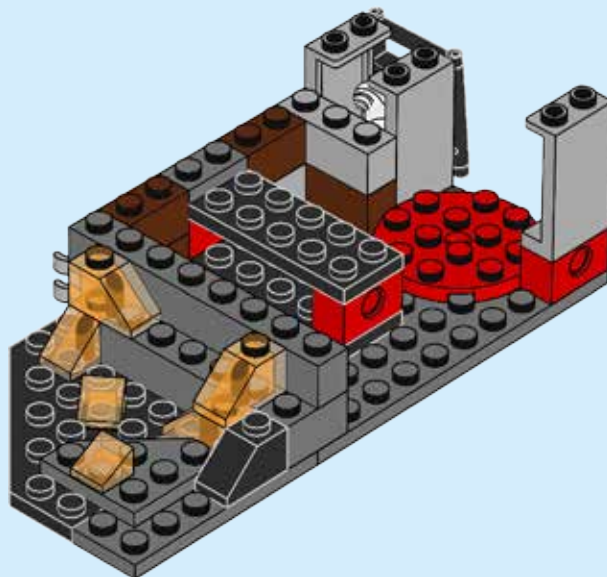

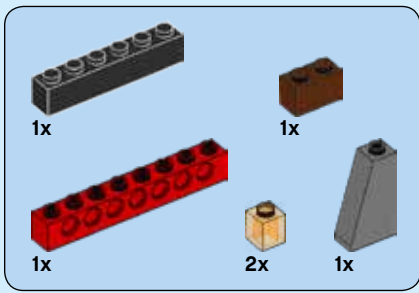

173

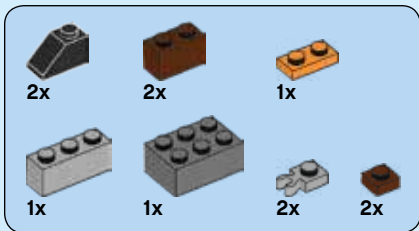
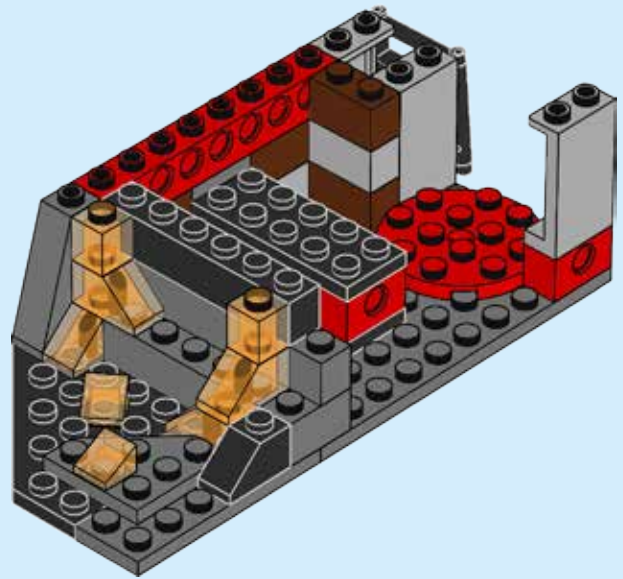

174

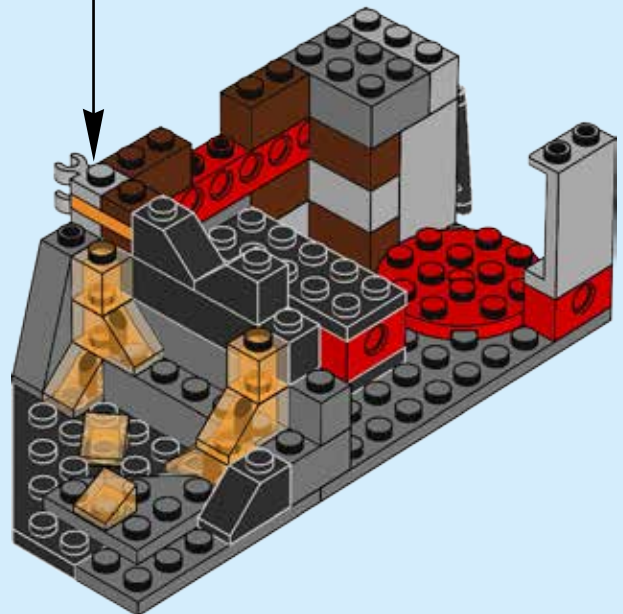



175

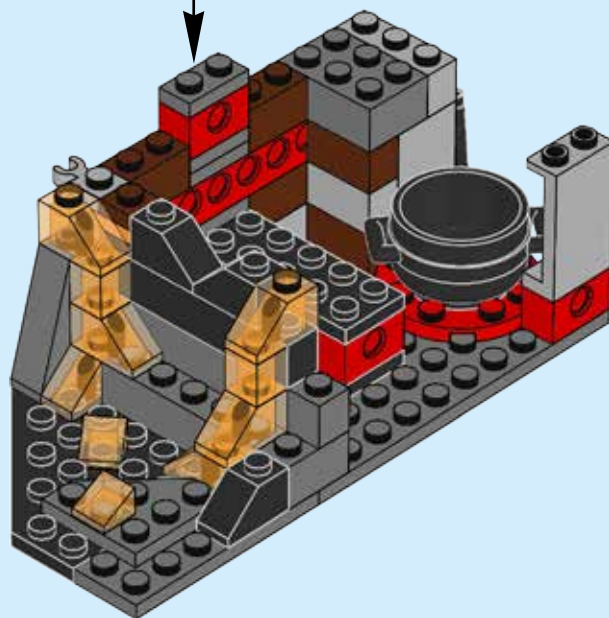
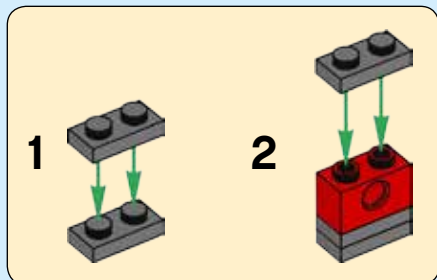

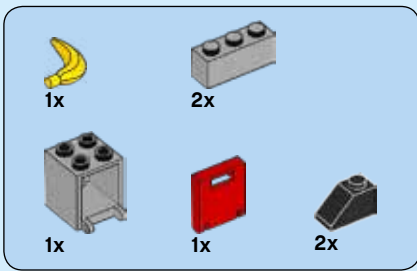

176

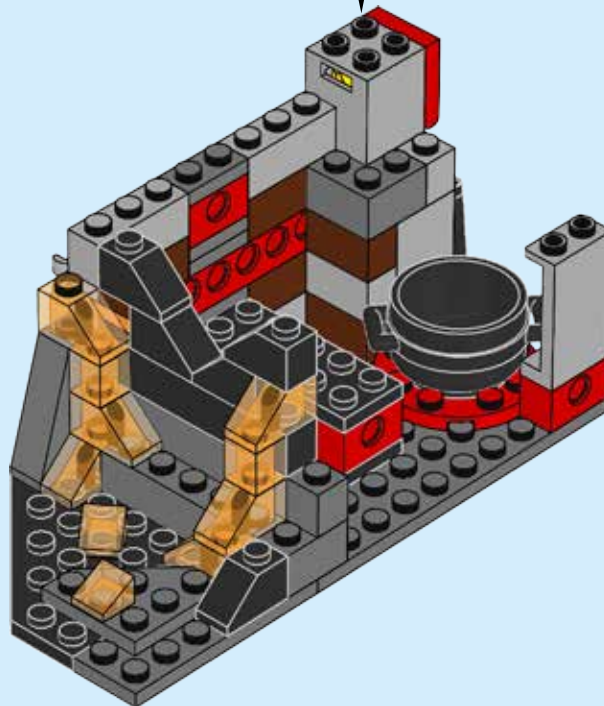
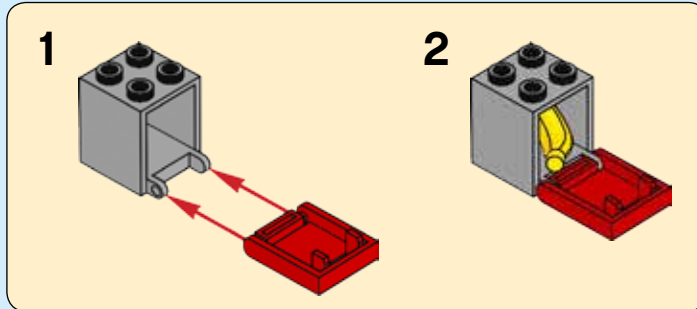

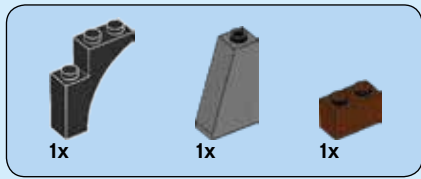

177

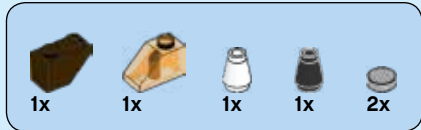
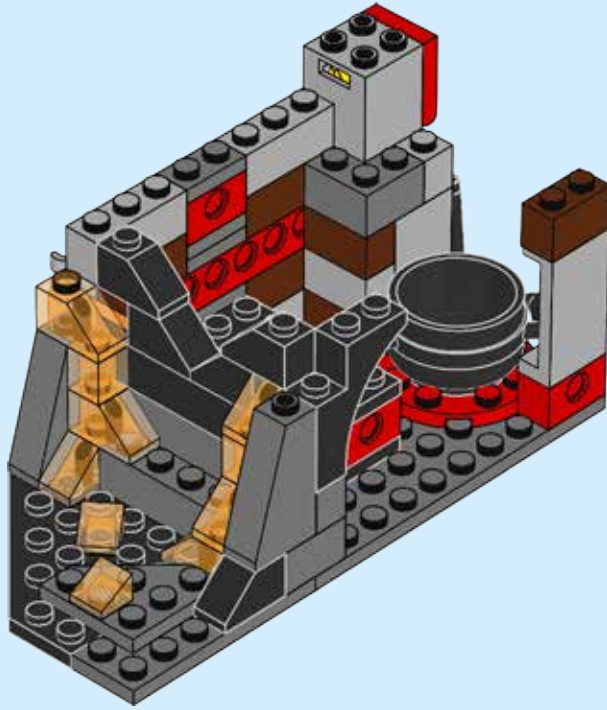

178

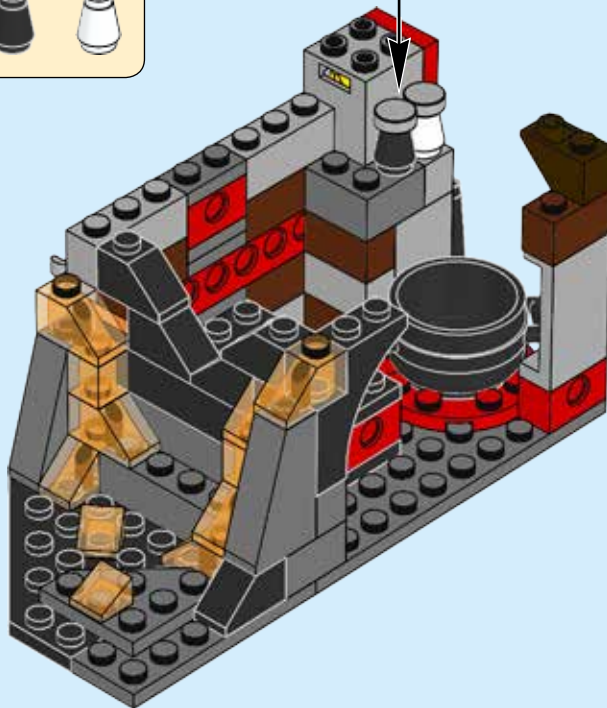
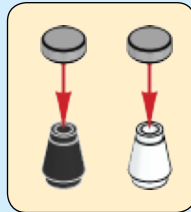

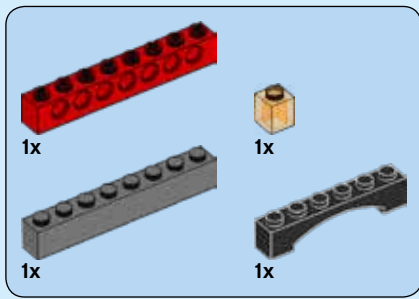

179

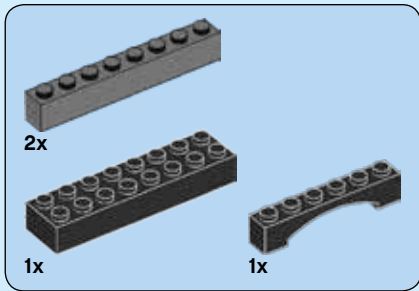
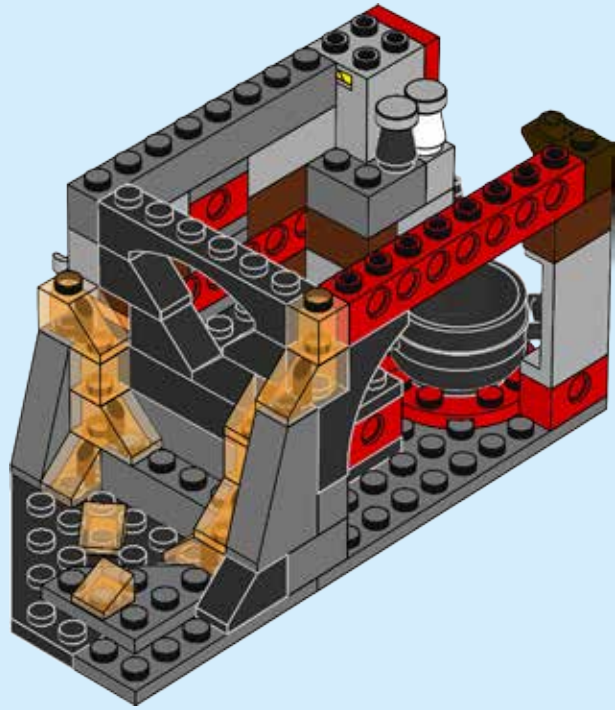

180

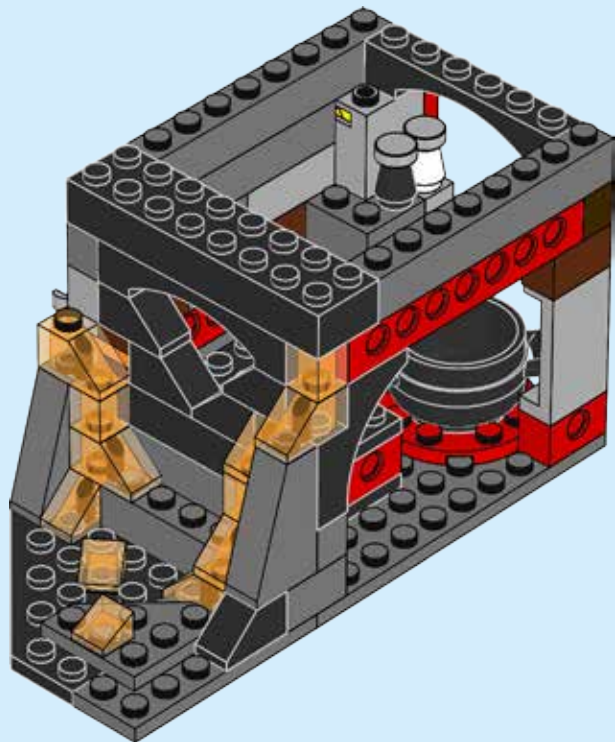



2x

181

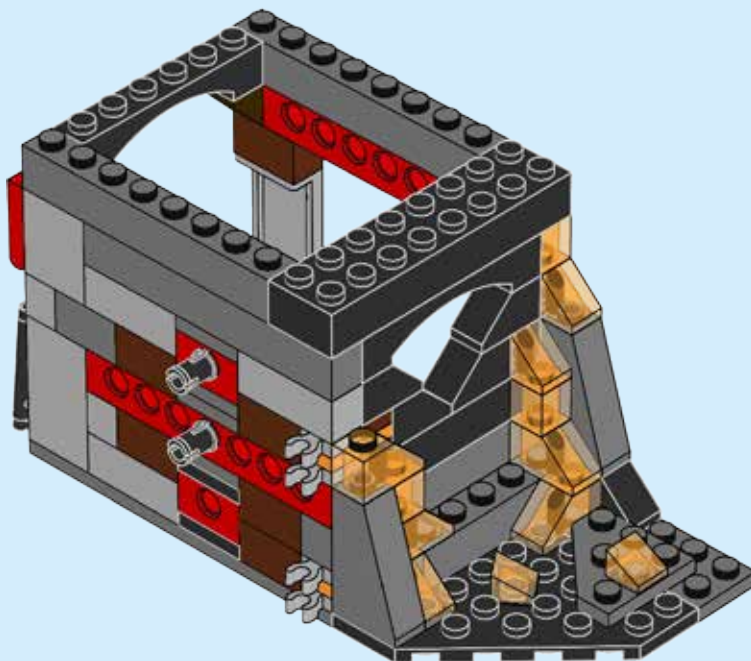
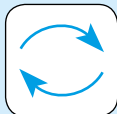

1x

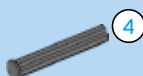

1x

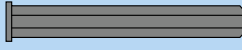

4

1:1

182

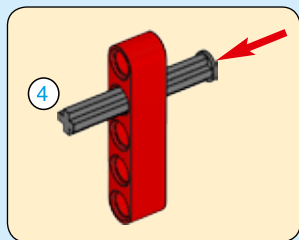
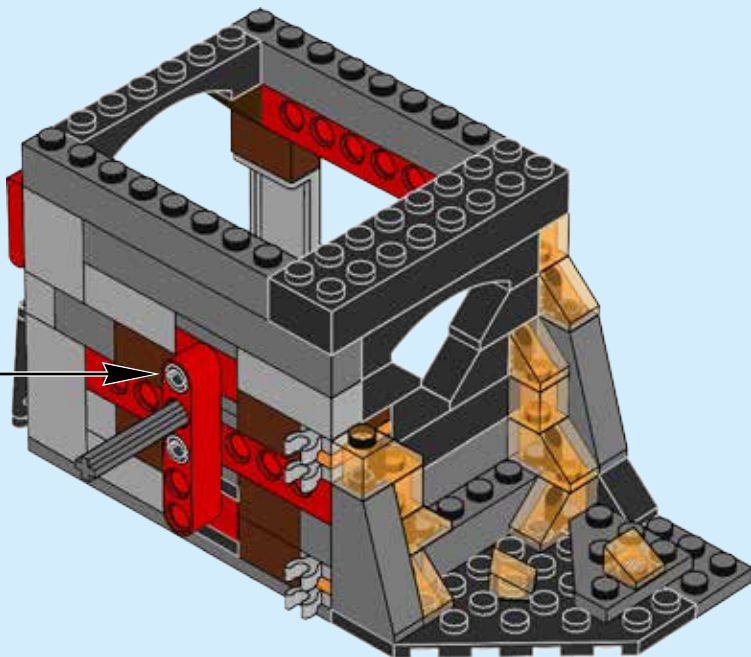

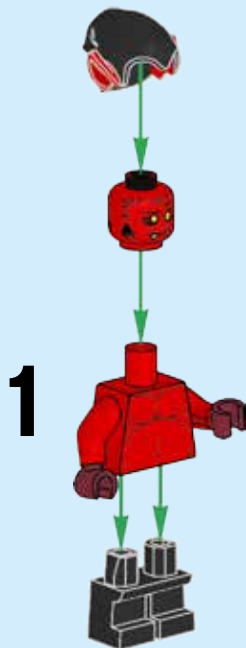

1

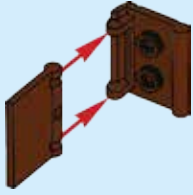

2



3



1

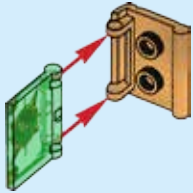

2

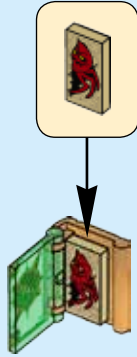

3



1

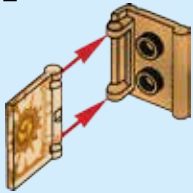

2

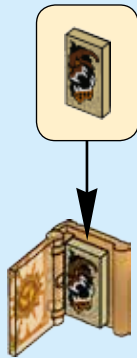

3



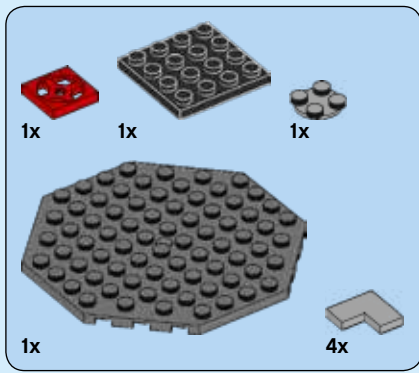

183

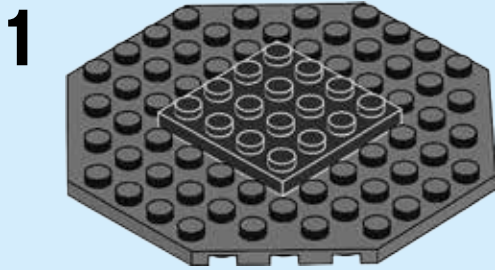

2

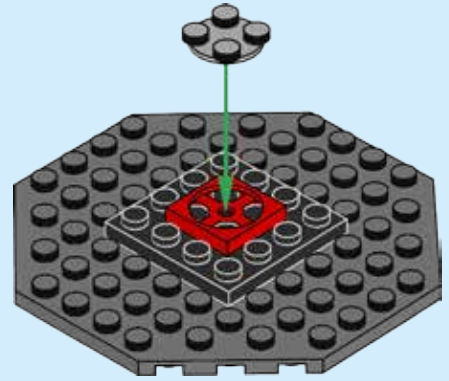

3

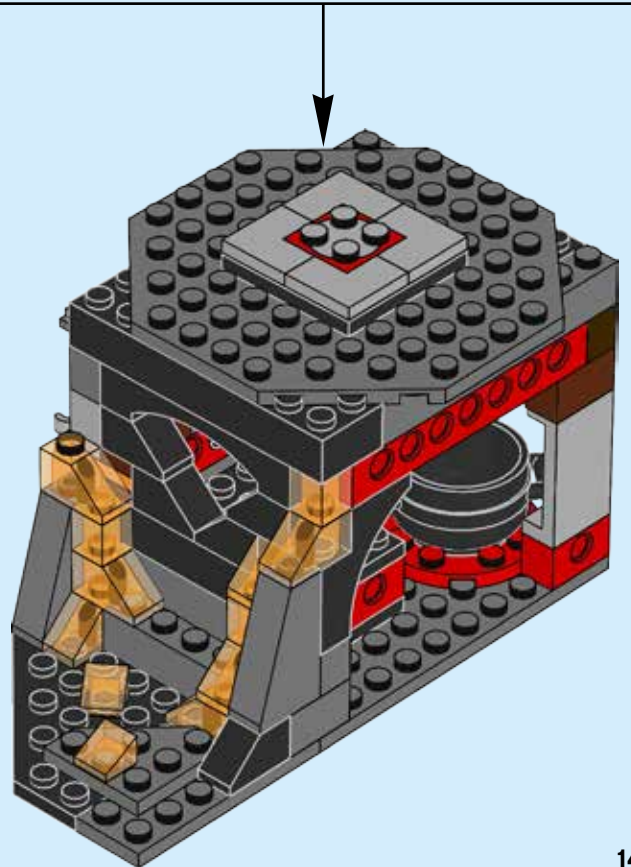
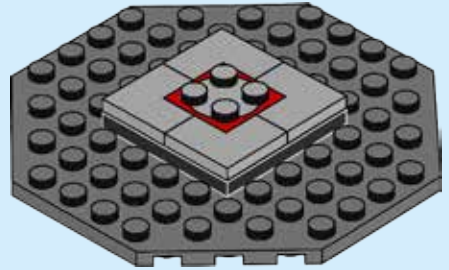



2x

184

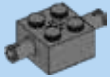
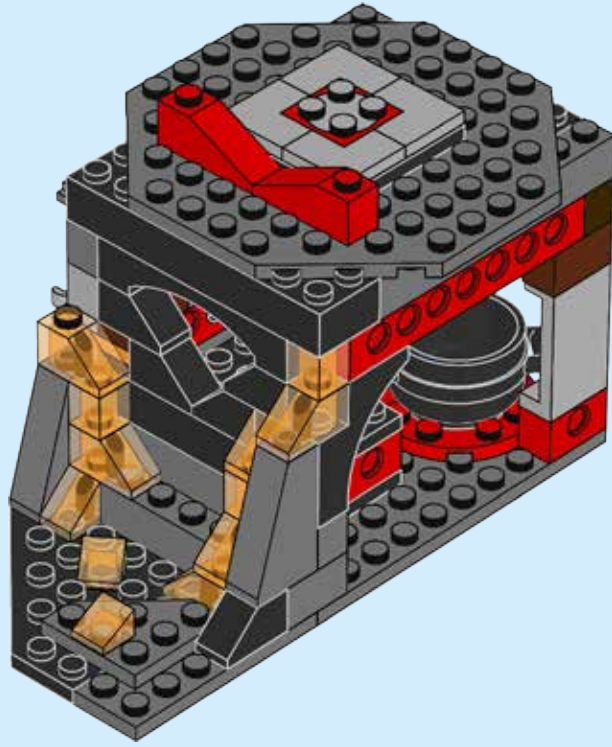

1x



2x

185

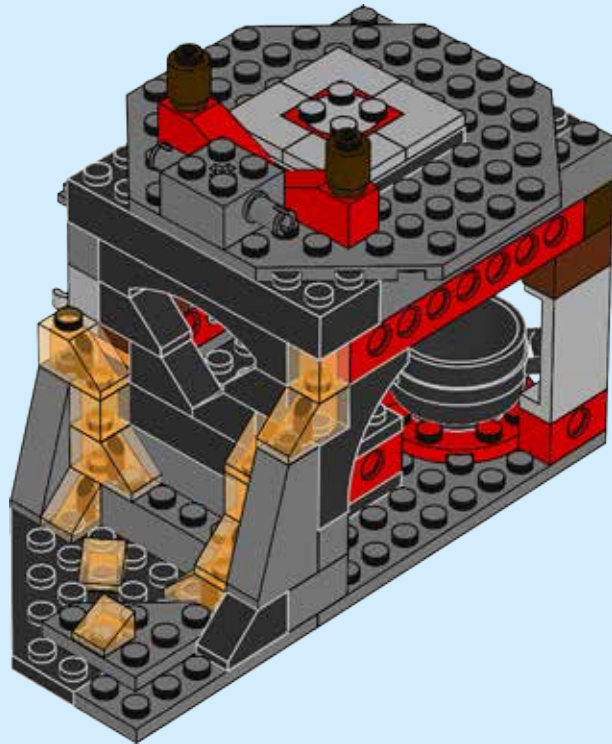

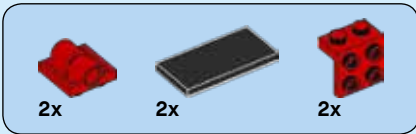

186

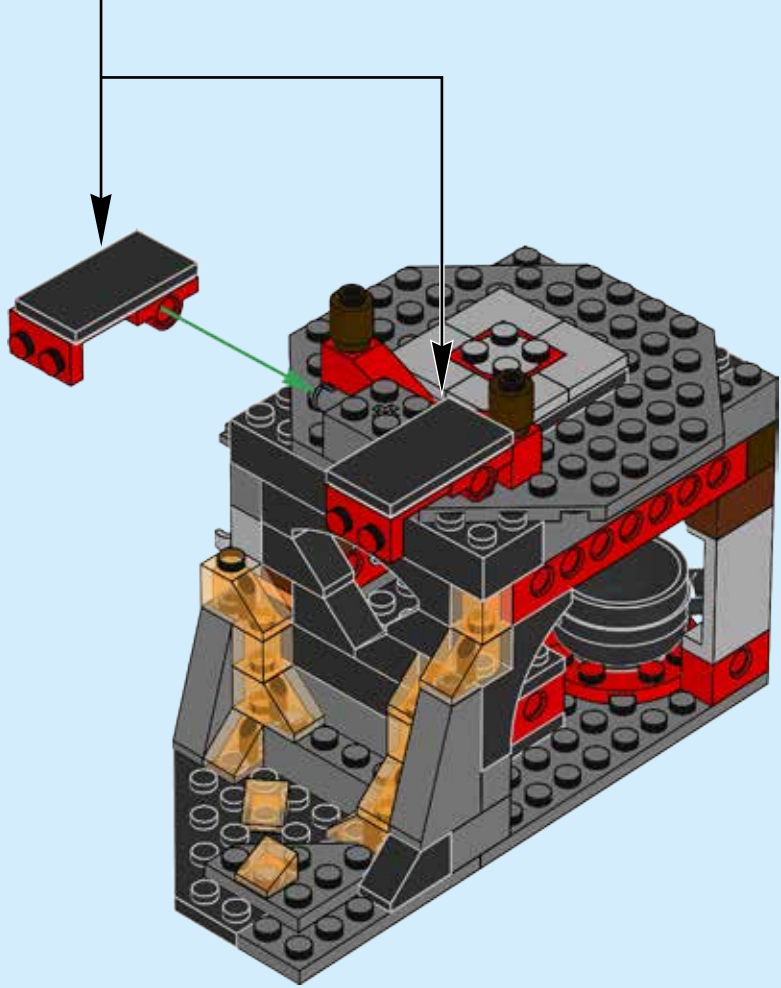
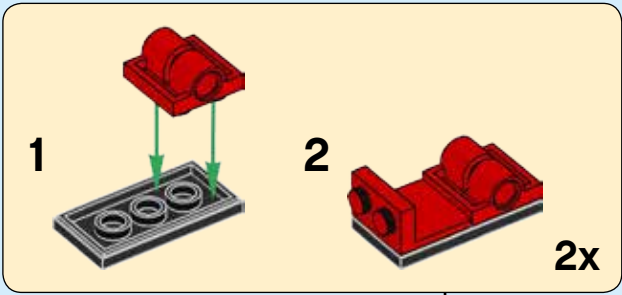

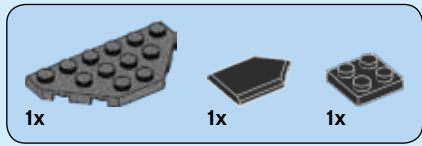

187

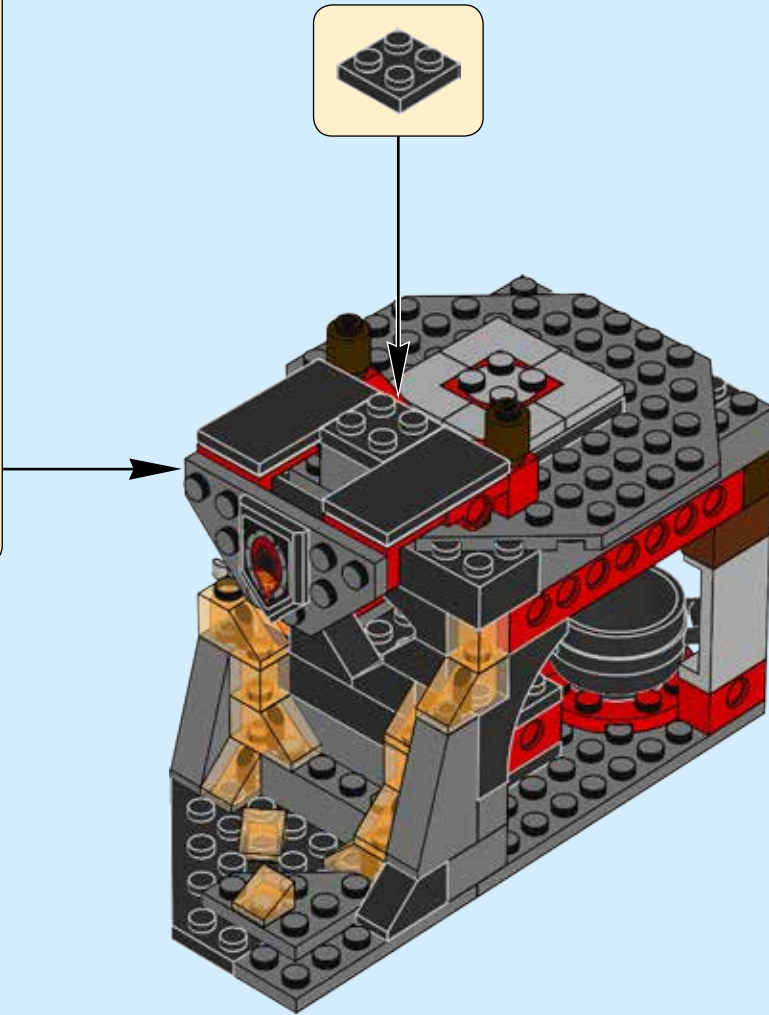
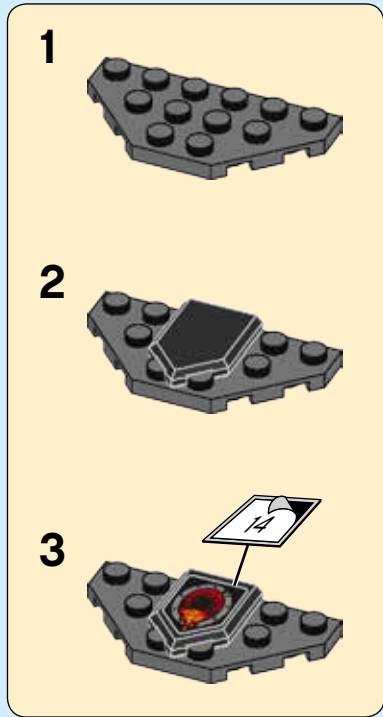

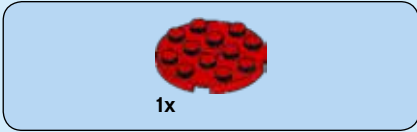

1x

188



2x

2x

189



2x

190

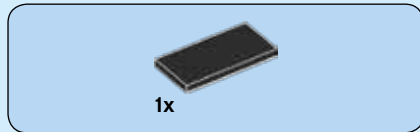
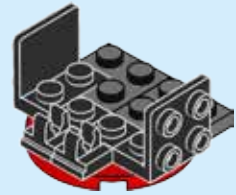

1x

191

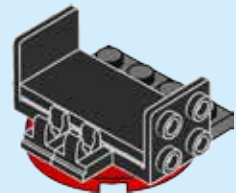



2x

192

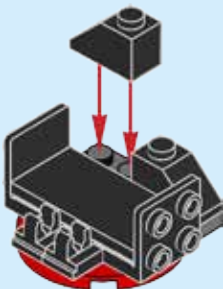

1x



1x

193

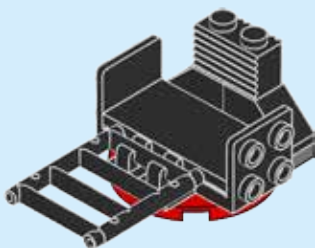

2x

194

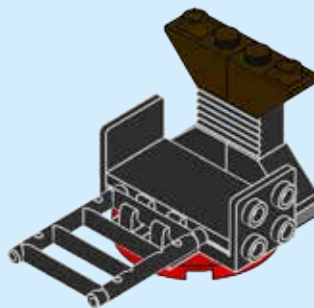

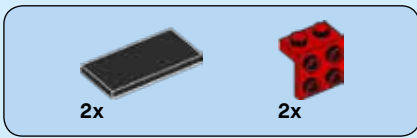

195

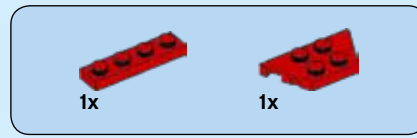
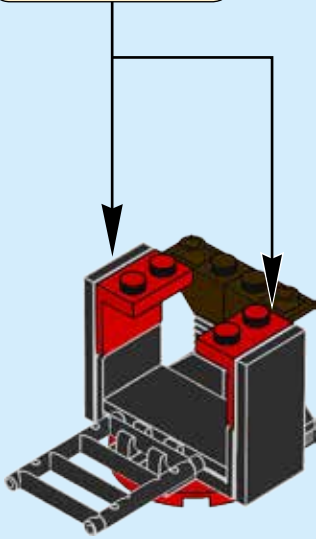
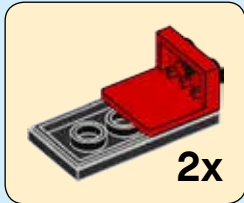

196

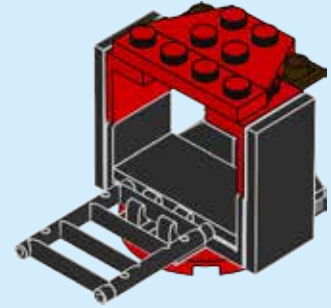

197

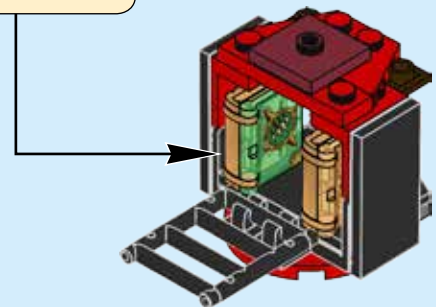



1x

198

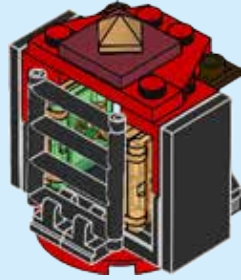

199

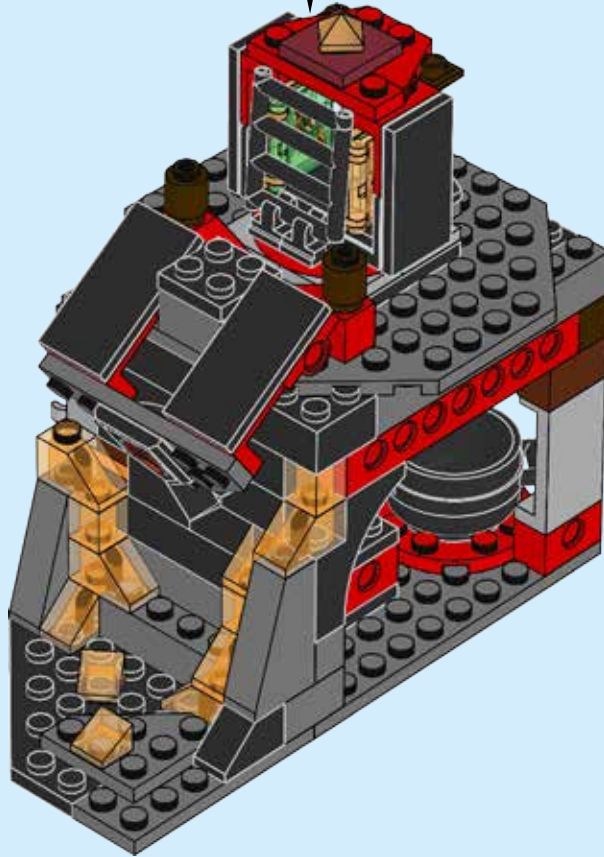

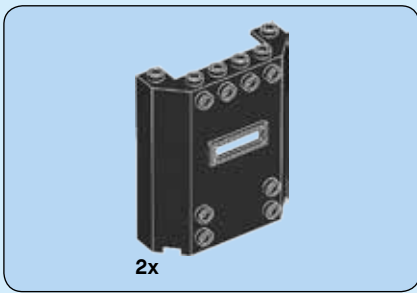

200

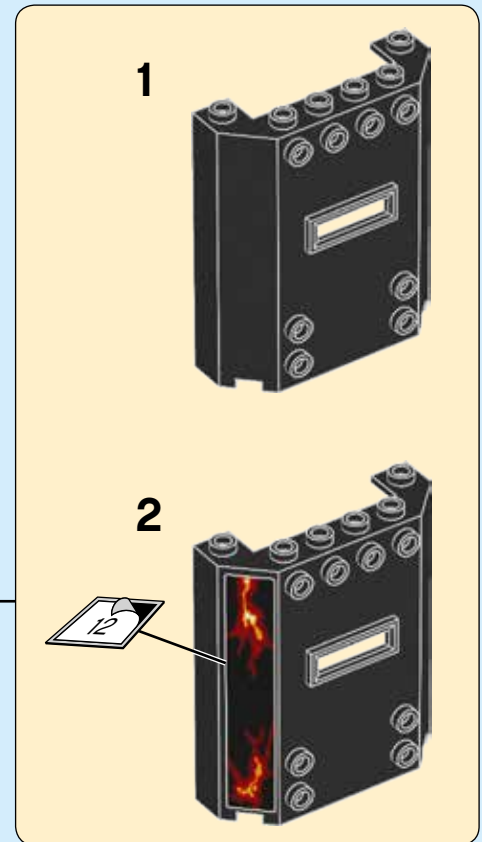
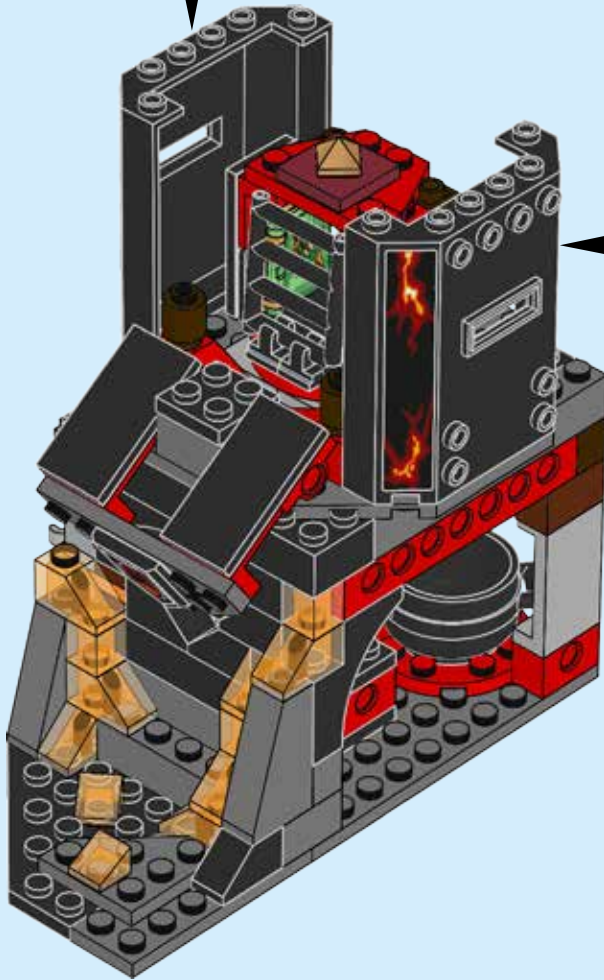
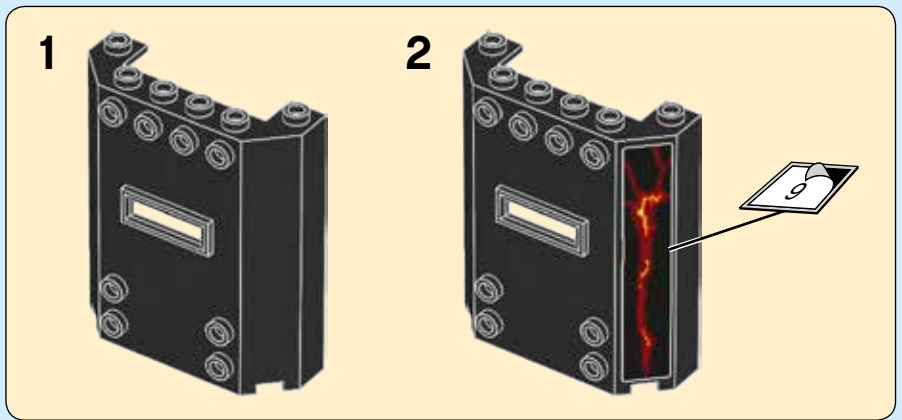

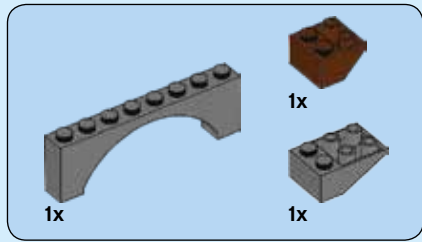

201

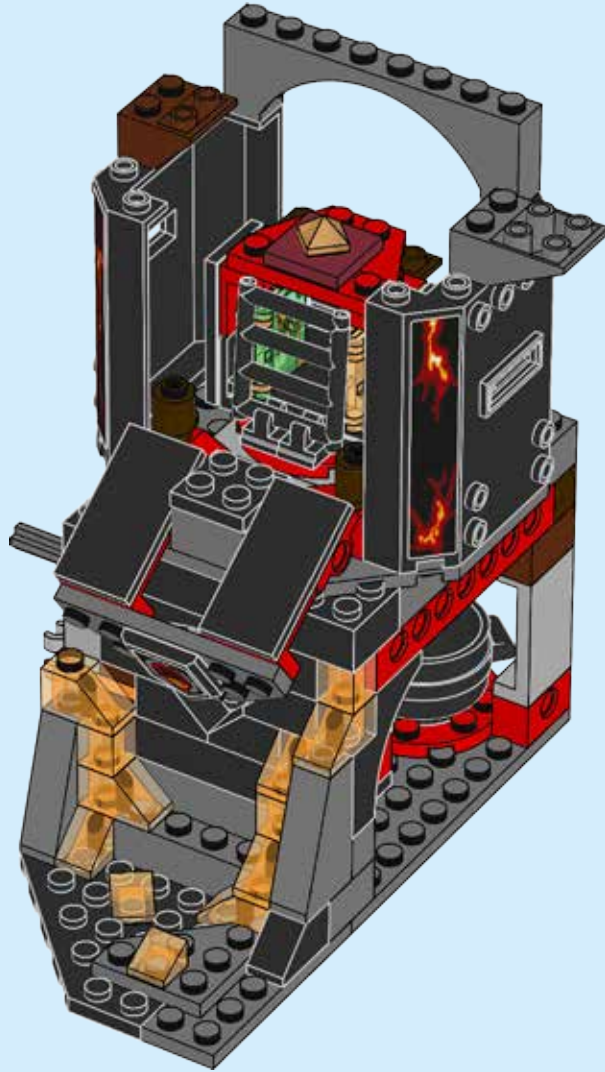

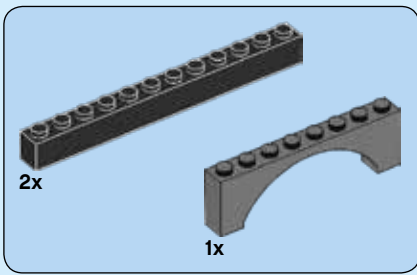

202

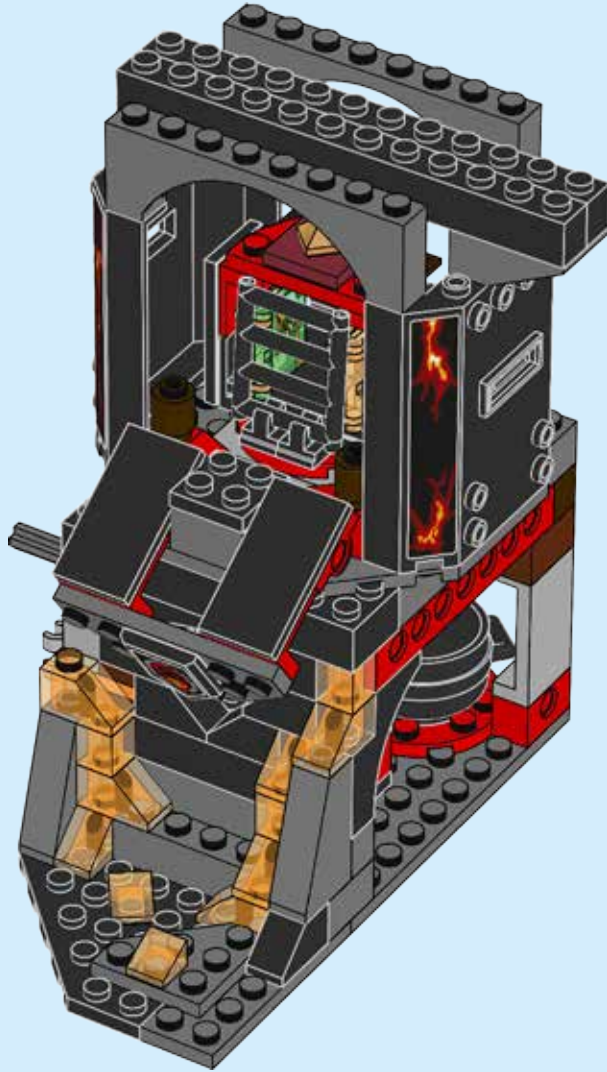

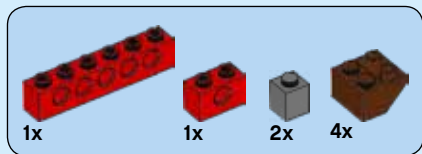

203

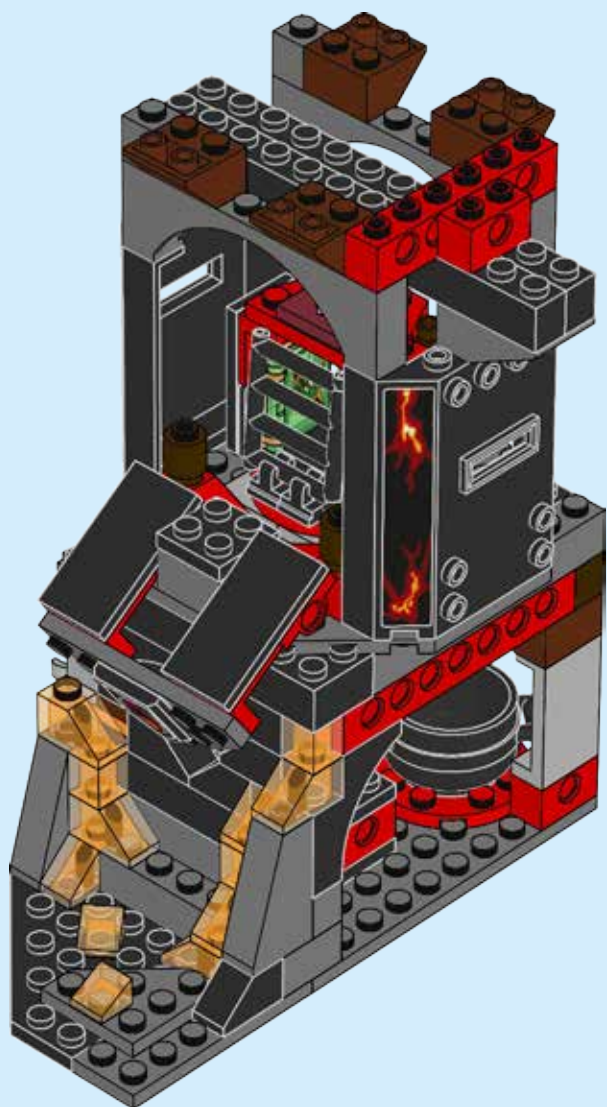

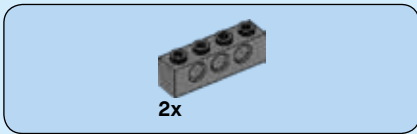

204

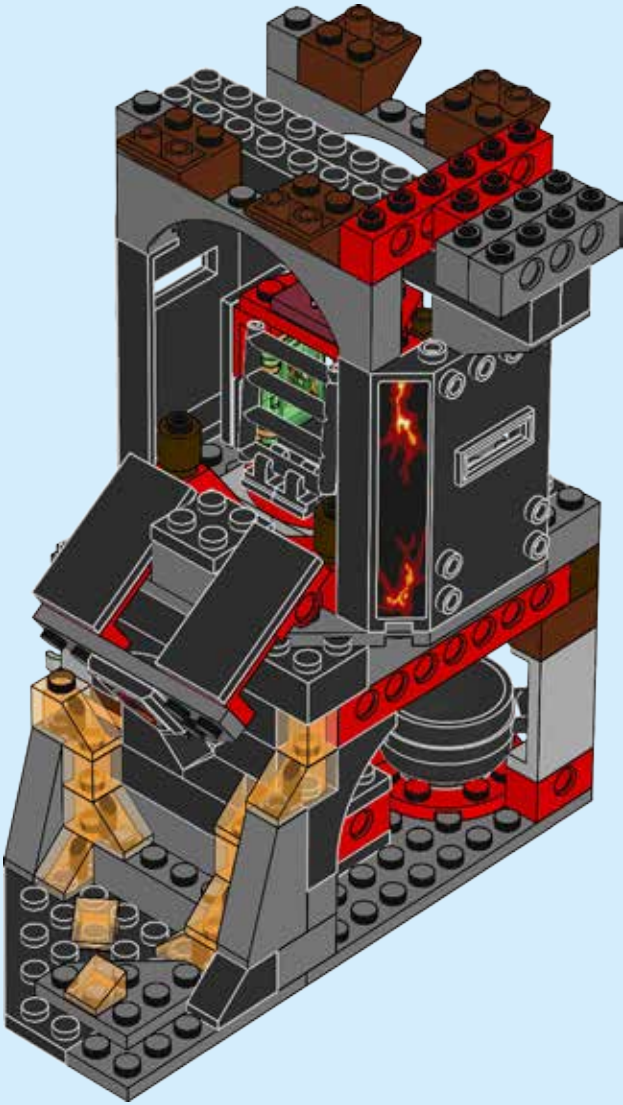

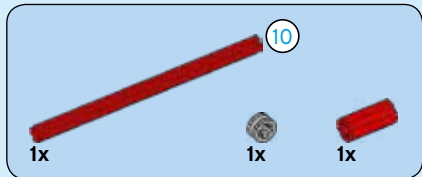

205

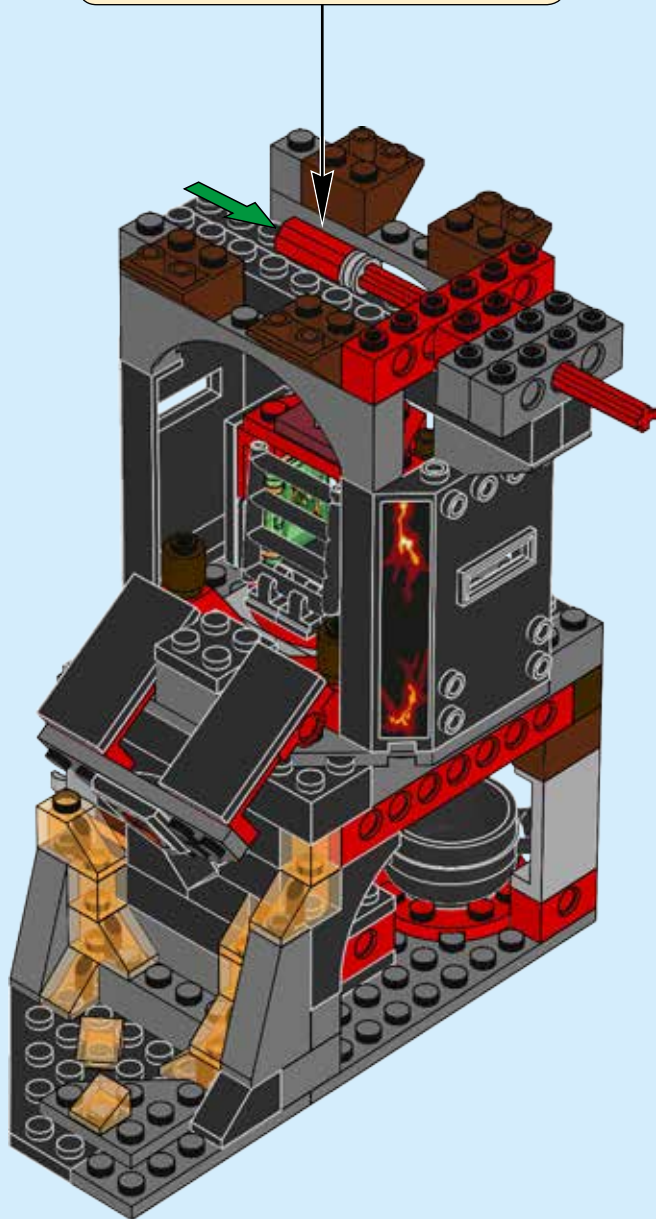
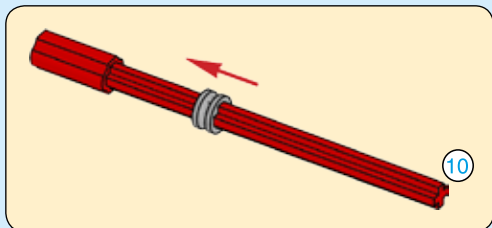

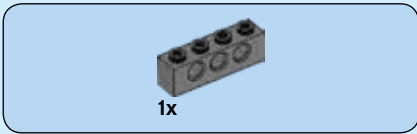

206

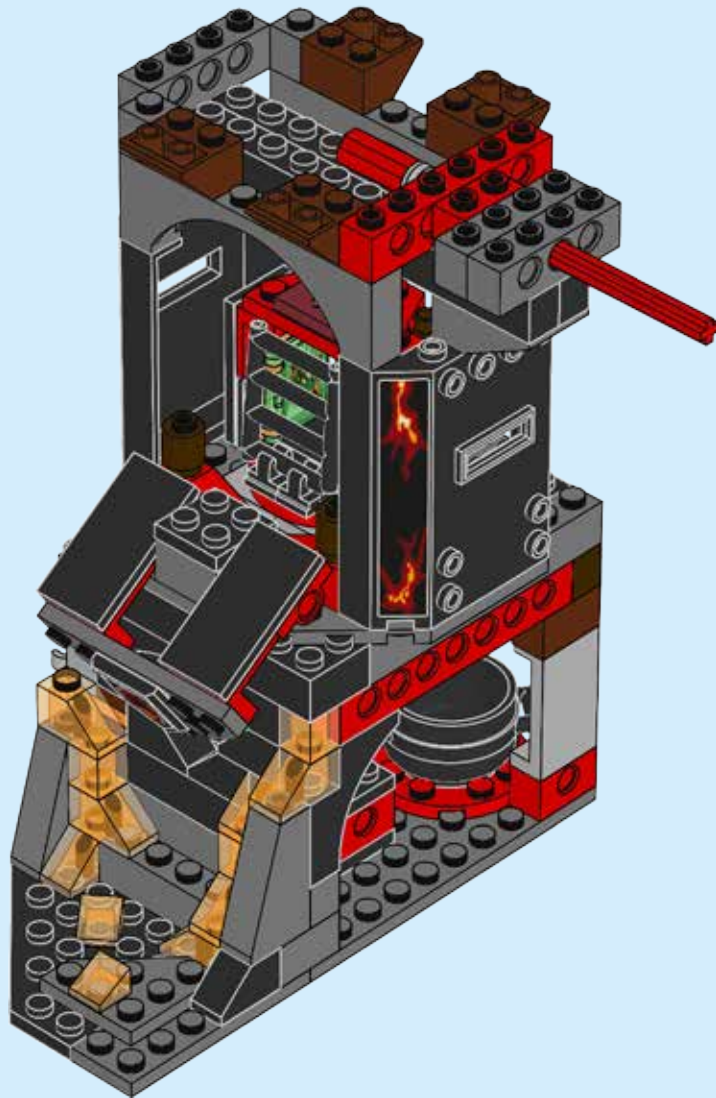

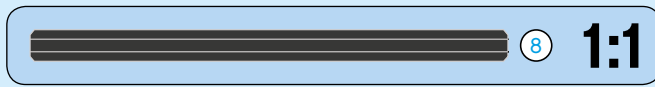
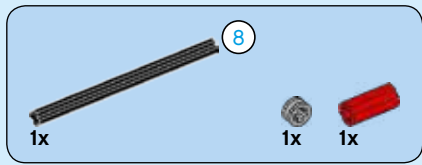

207

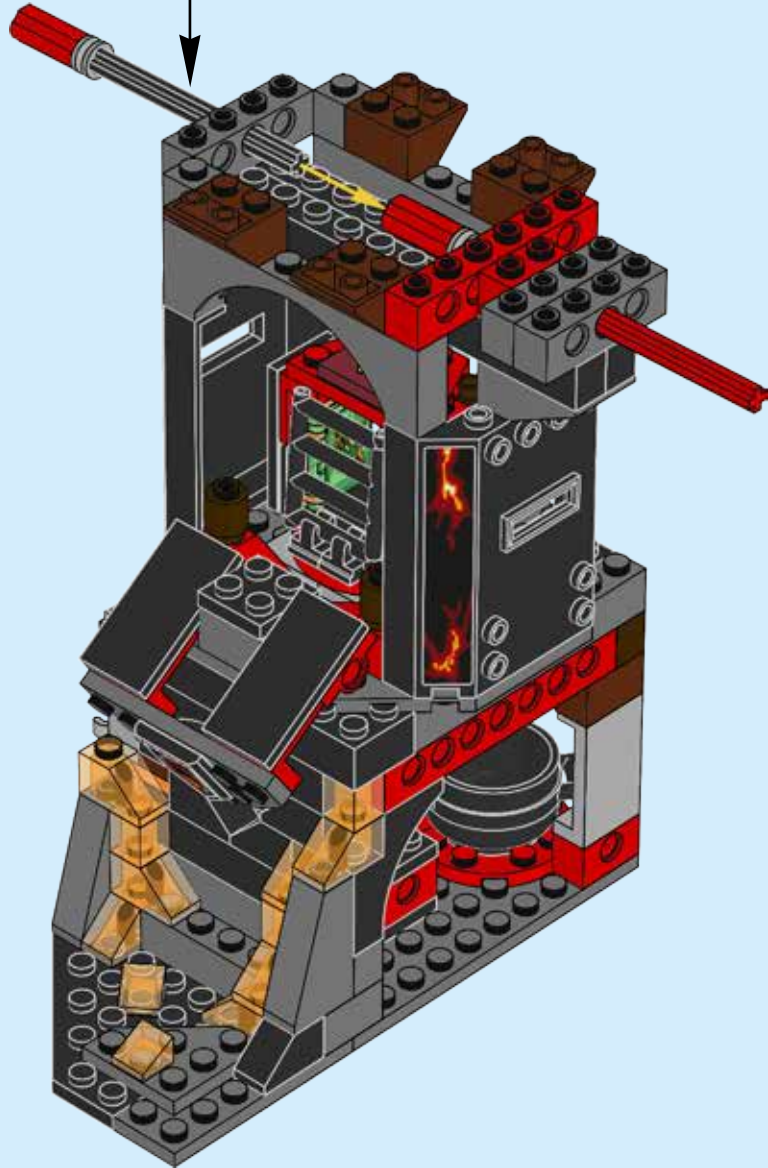
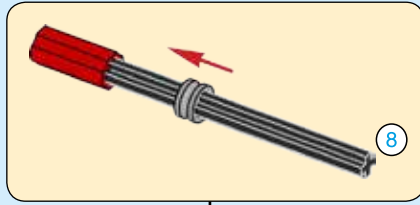

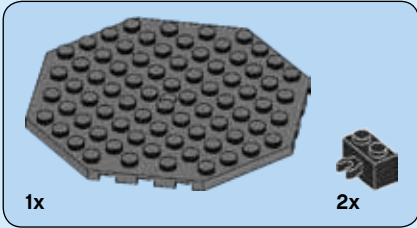

208

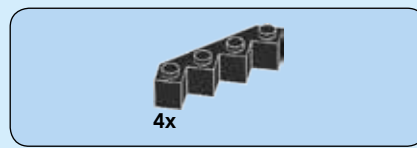
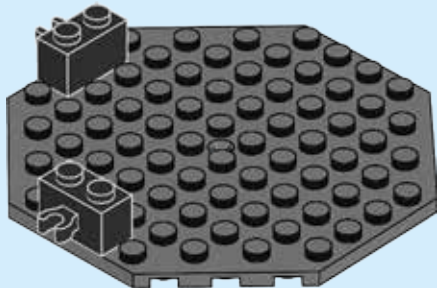

209

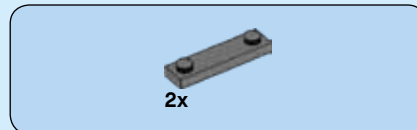
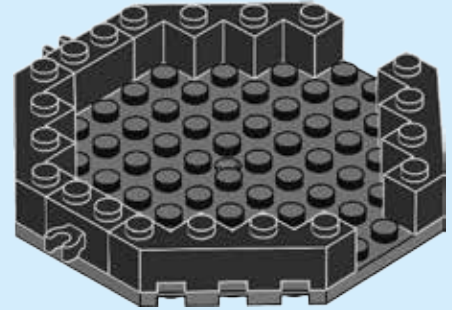

210

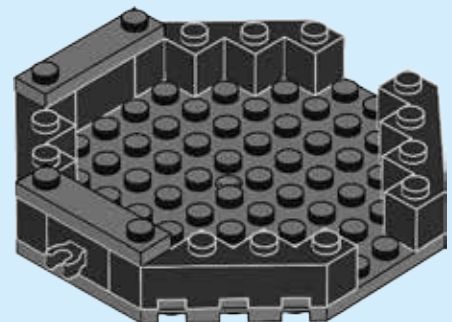



4x

211

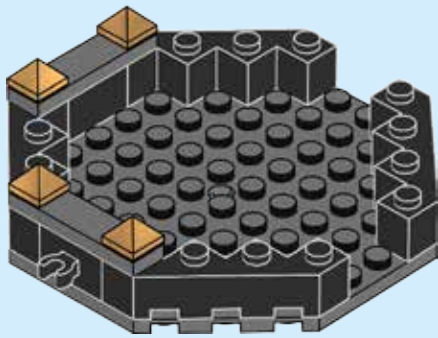

8x

213

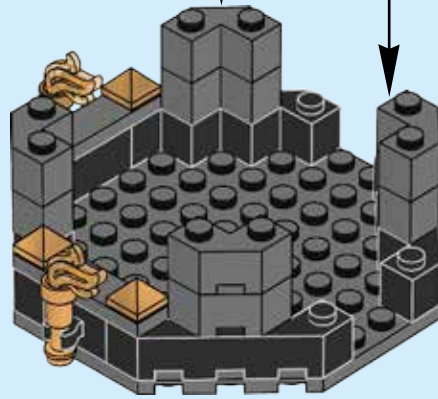
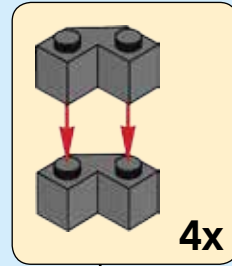

2x



2x

212

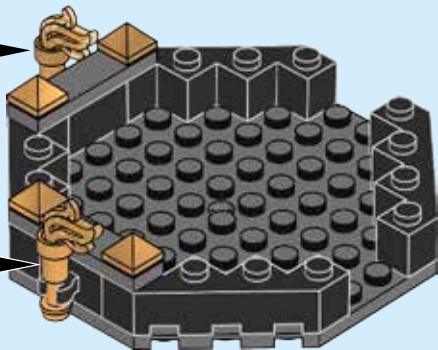
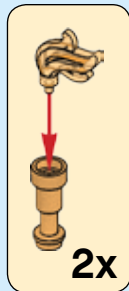

2x

214

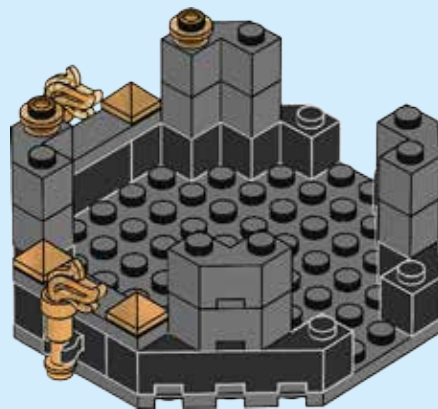

215

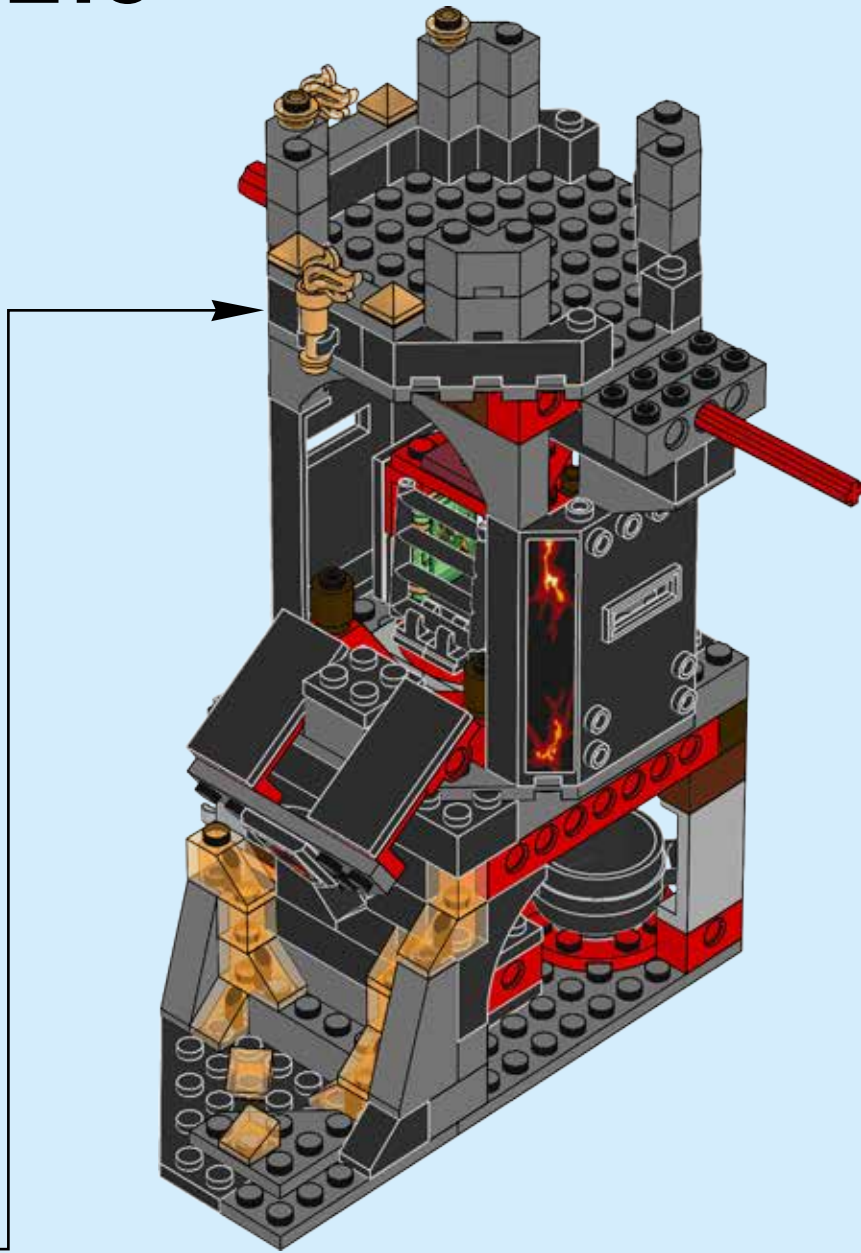



1x

216

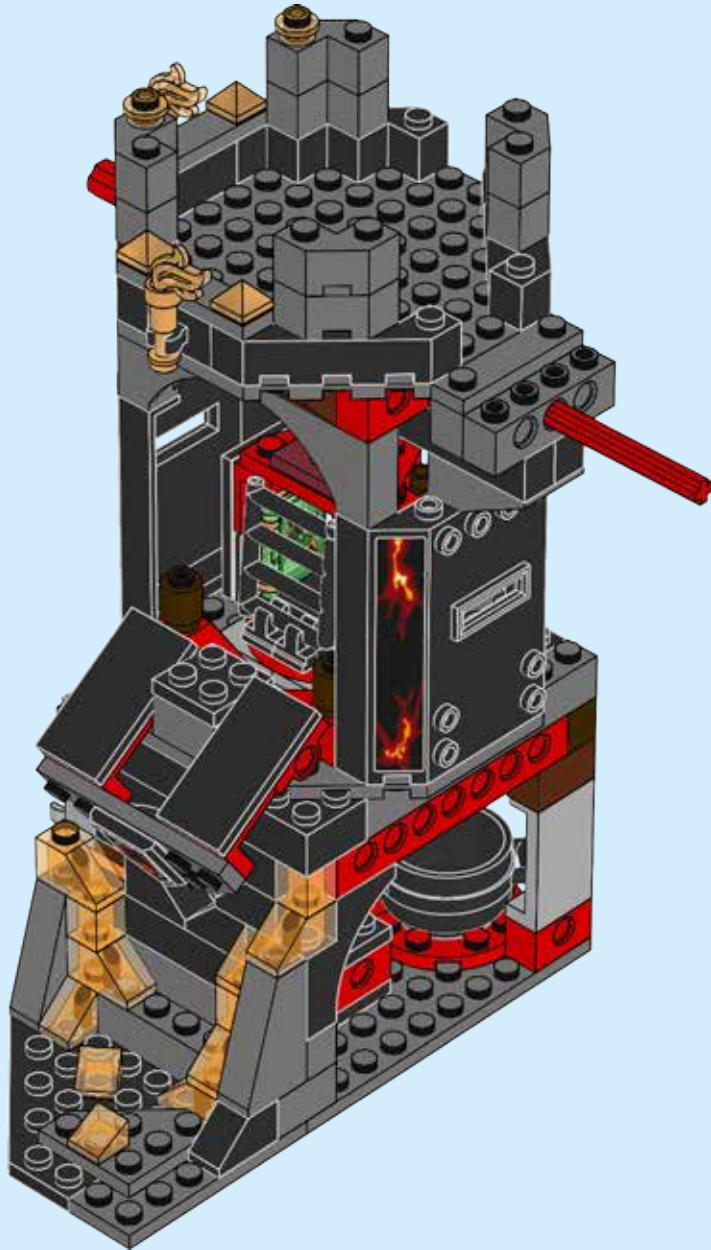

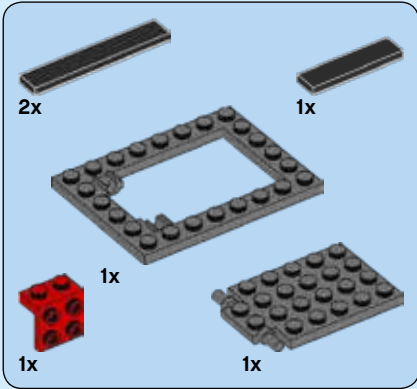

217

1

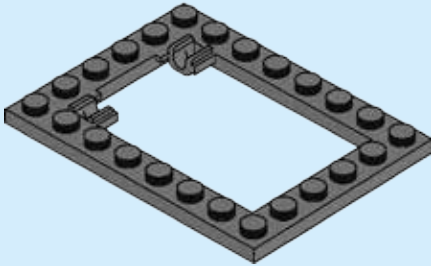

2

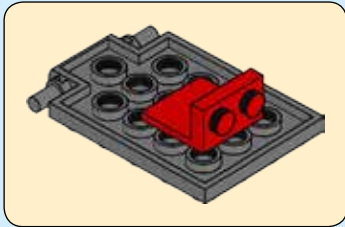
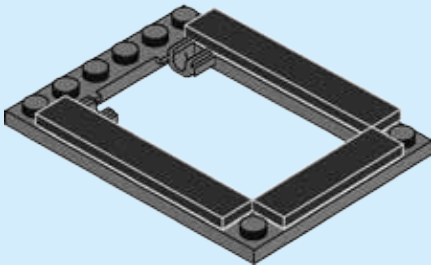

3

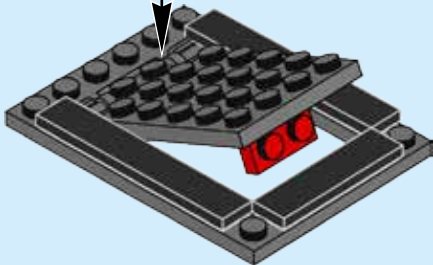

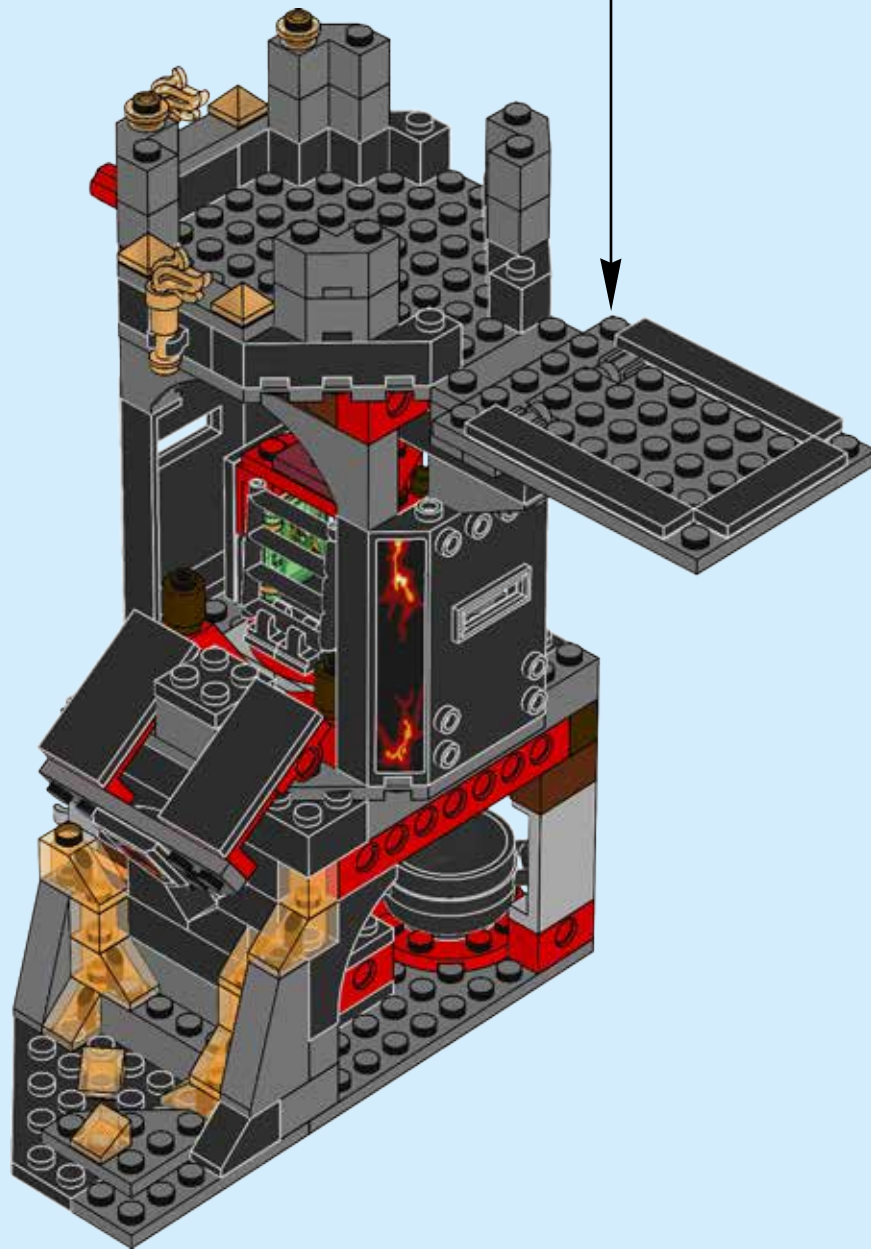



218

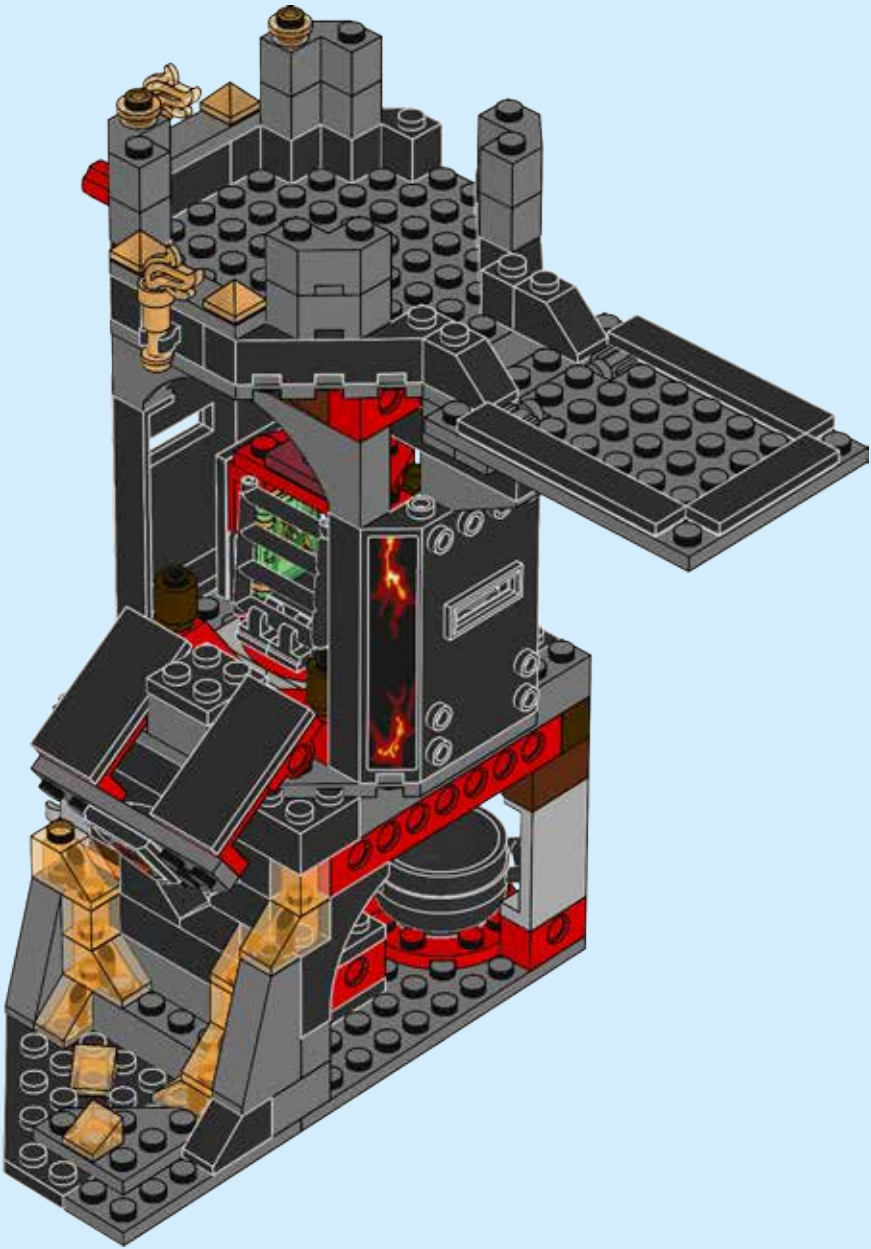



219

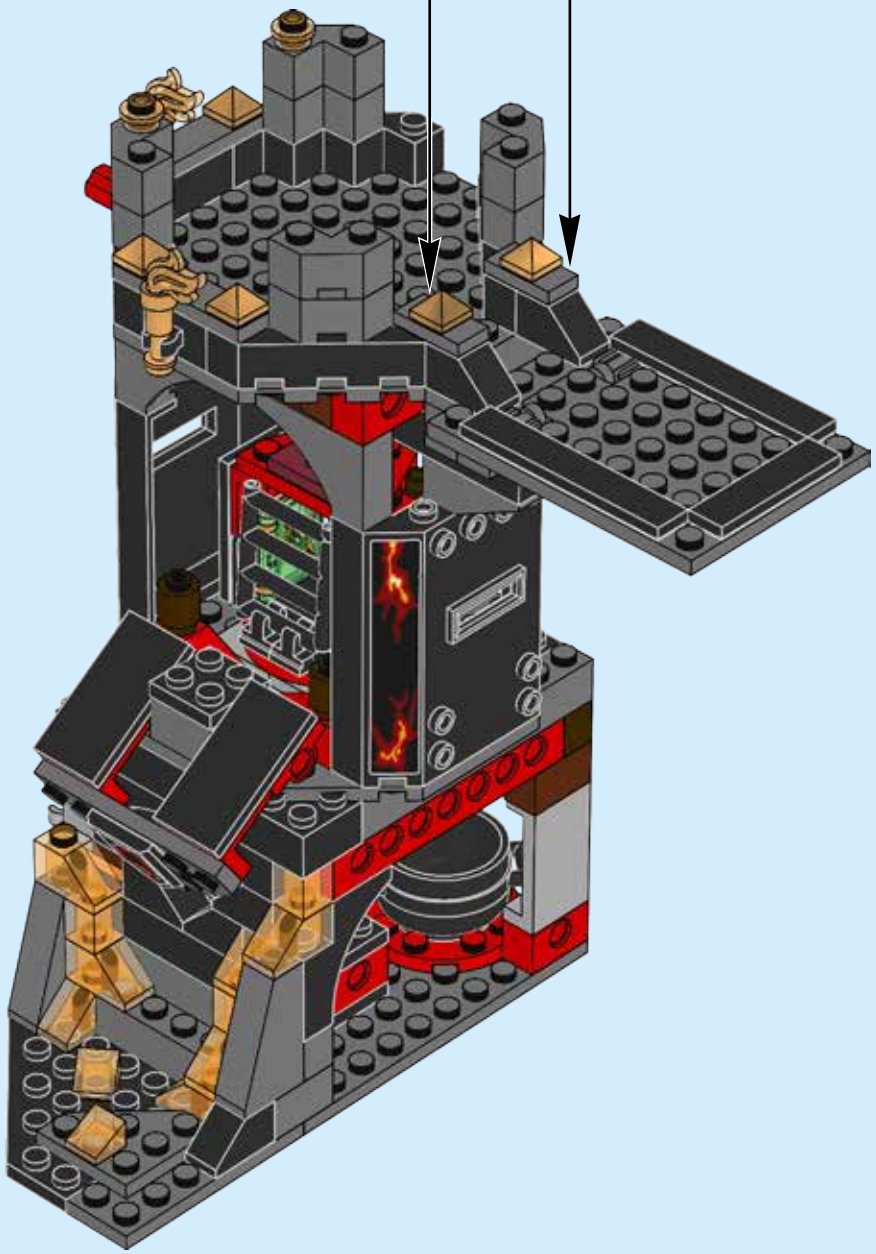
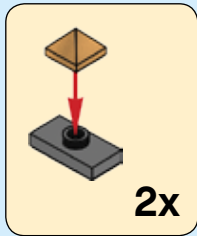

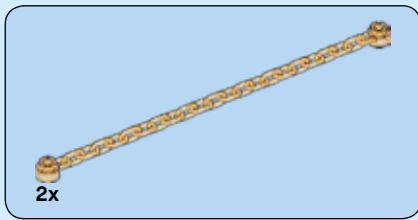

220

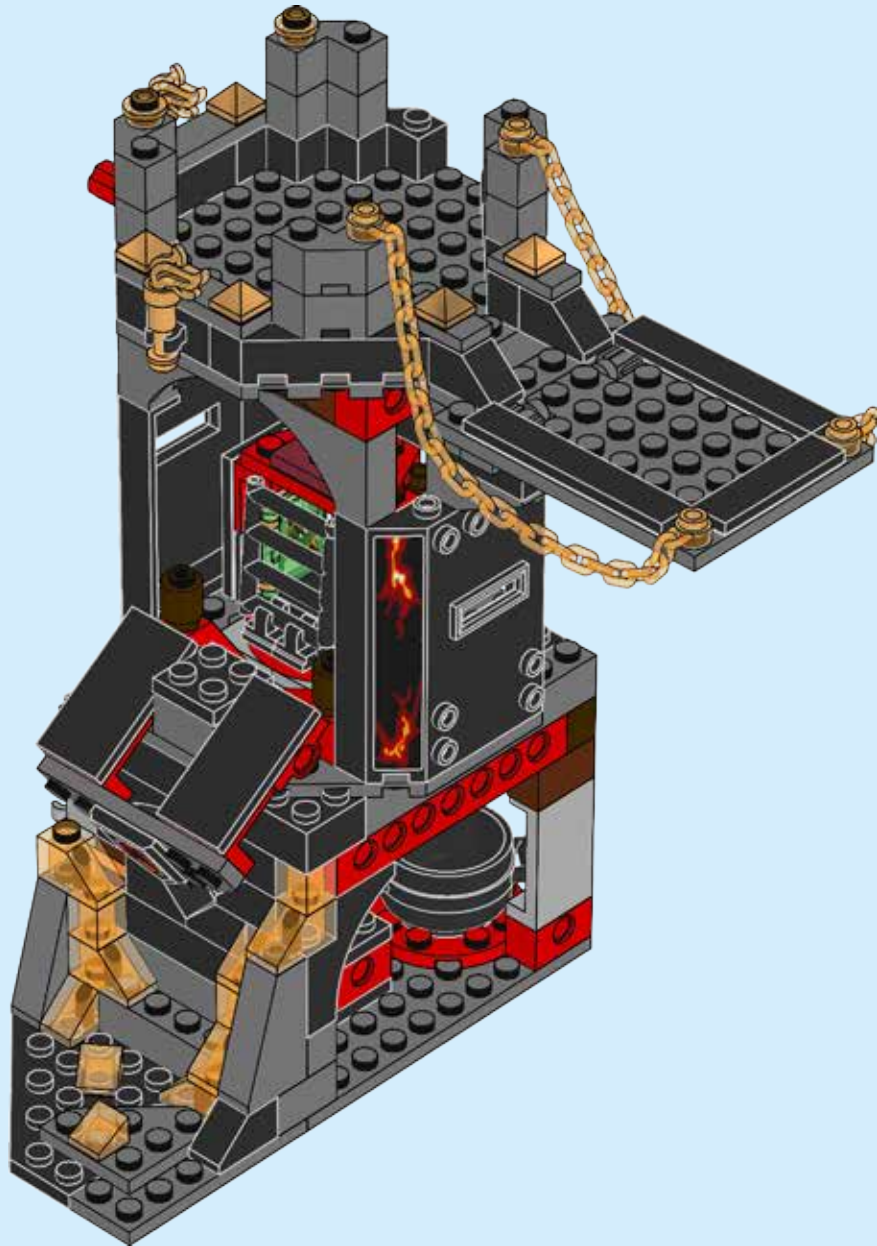



6x

221

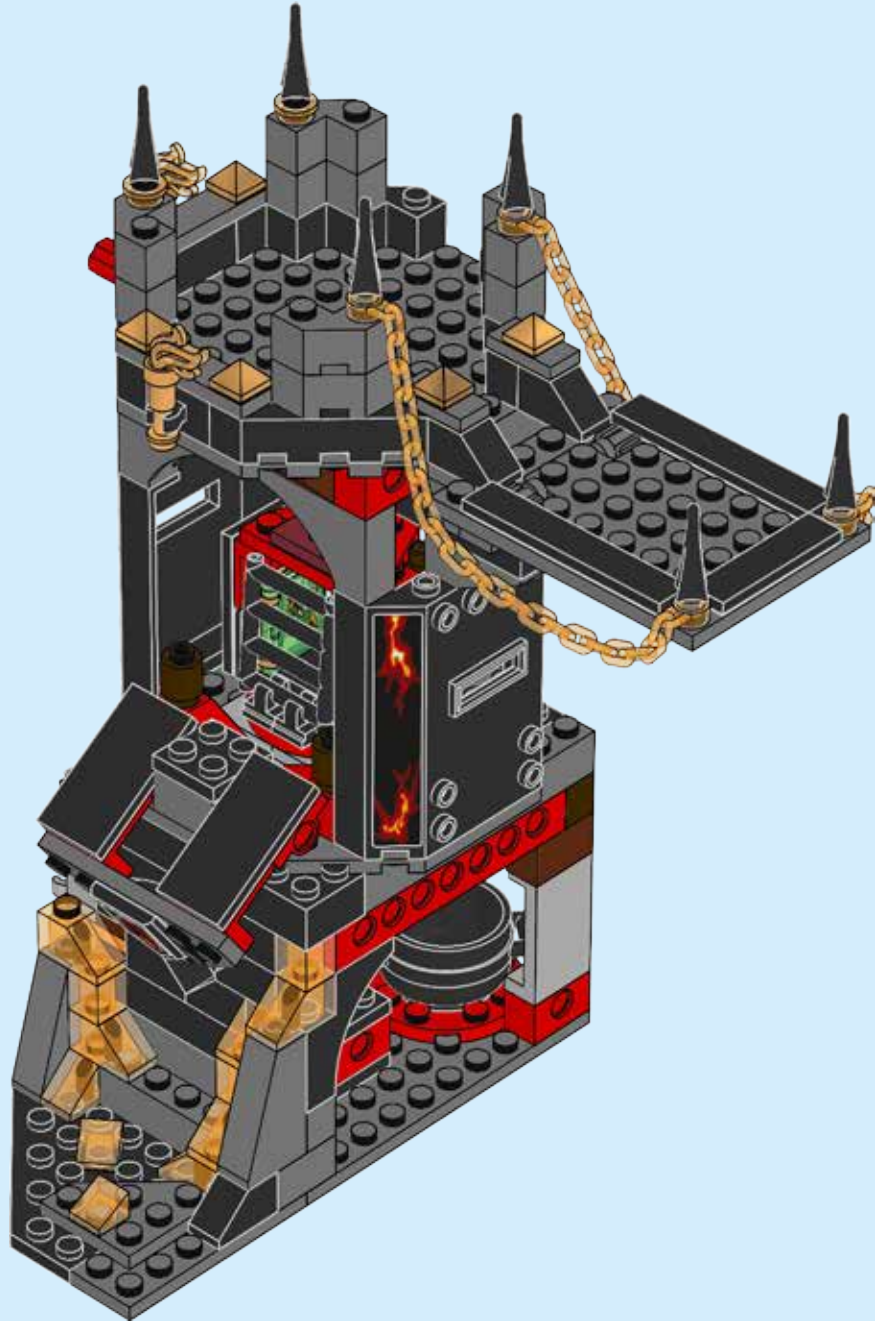

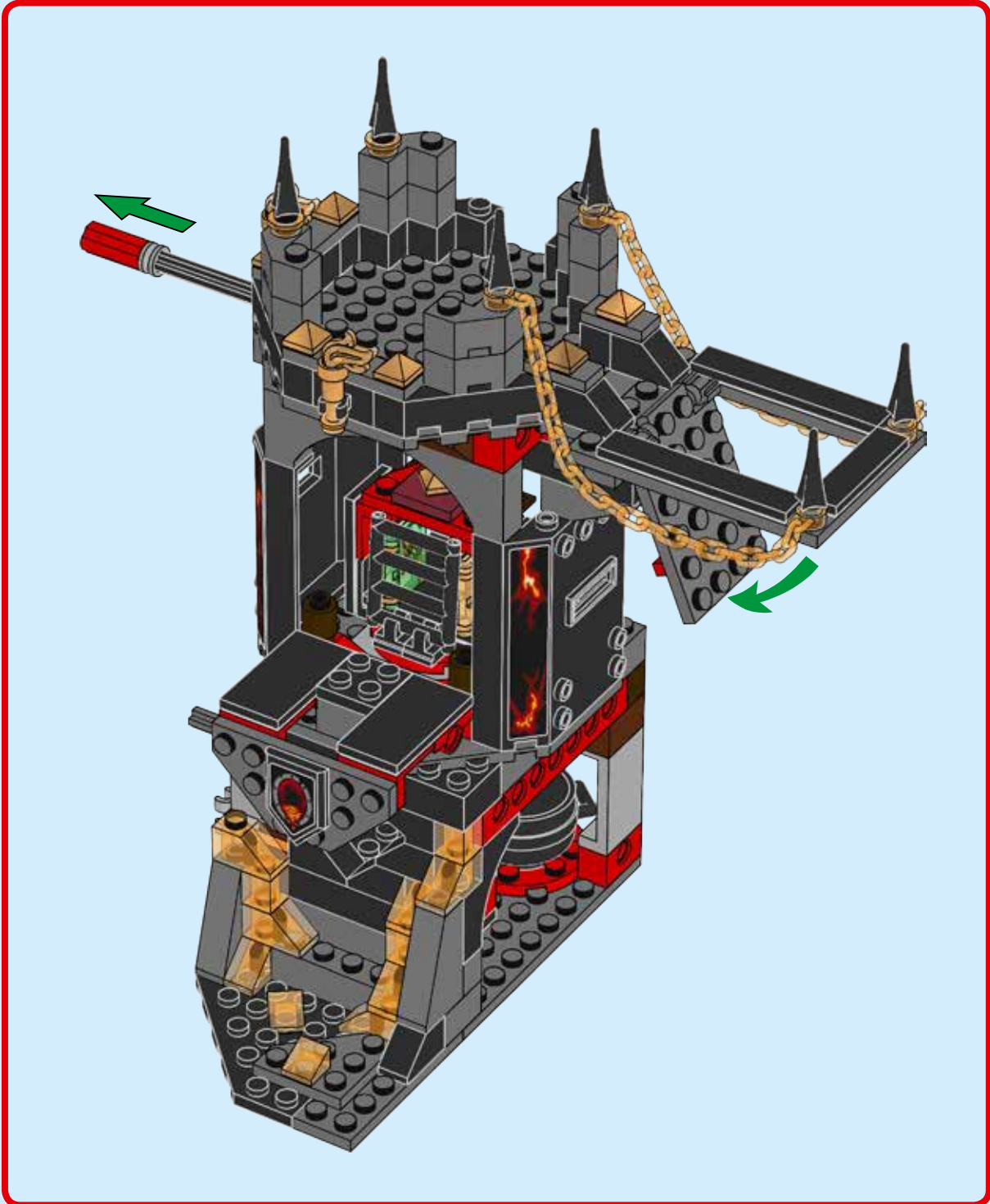

222

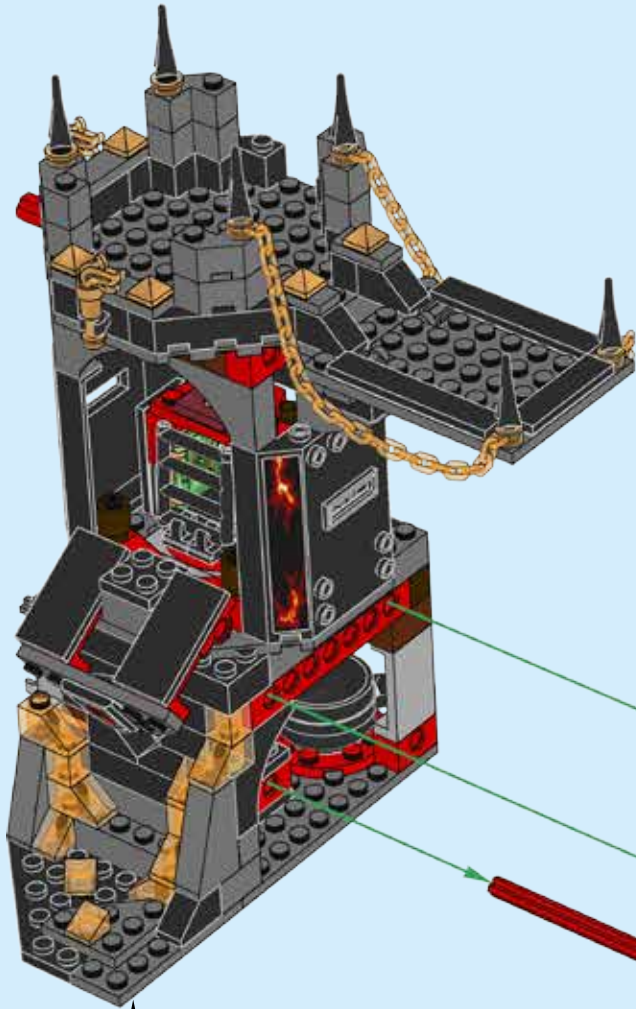
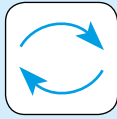



1x



1x



1x

223

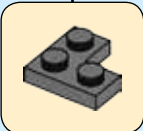
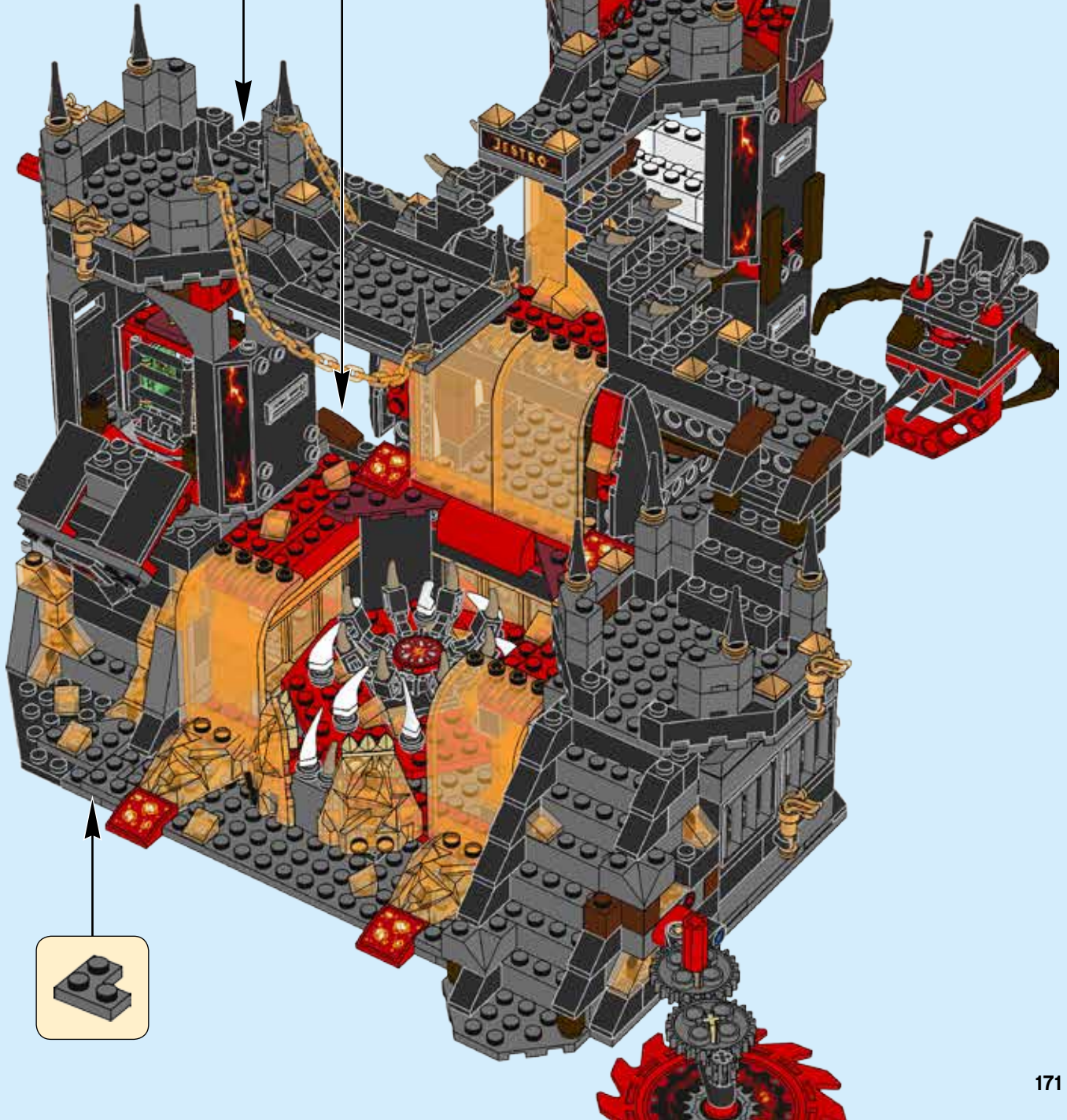

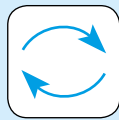

224

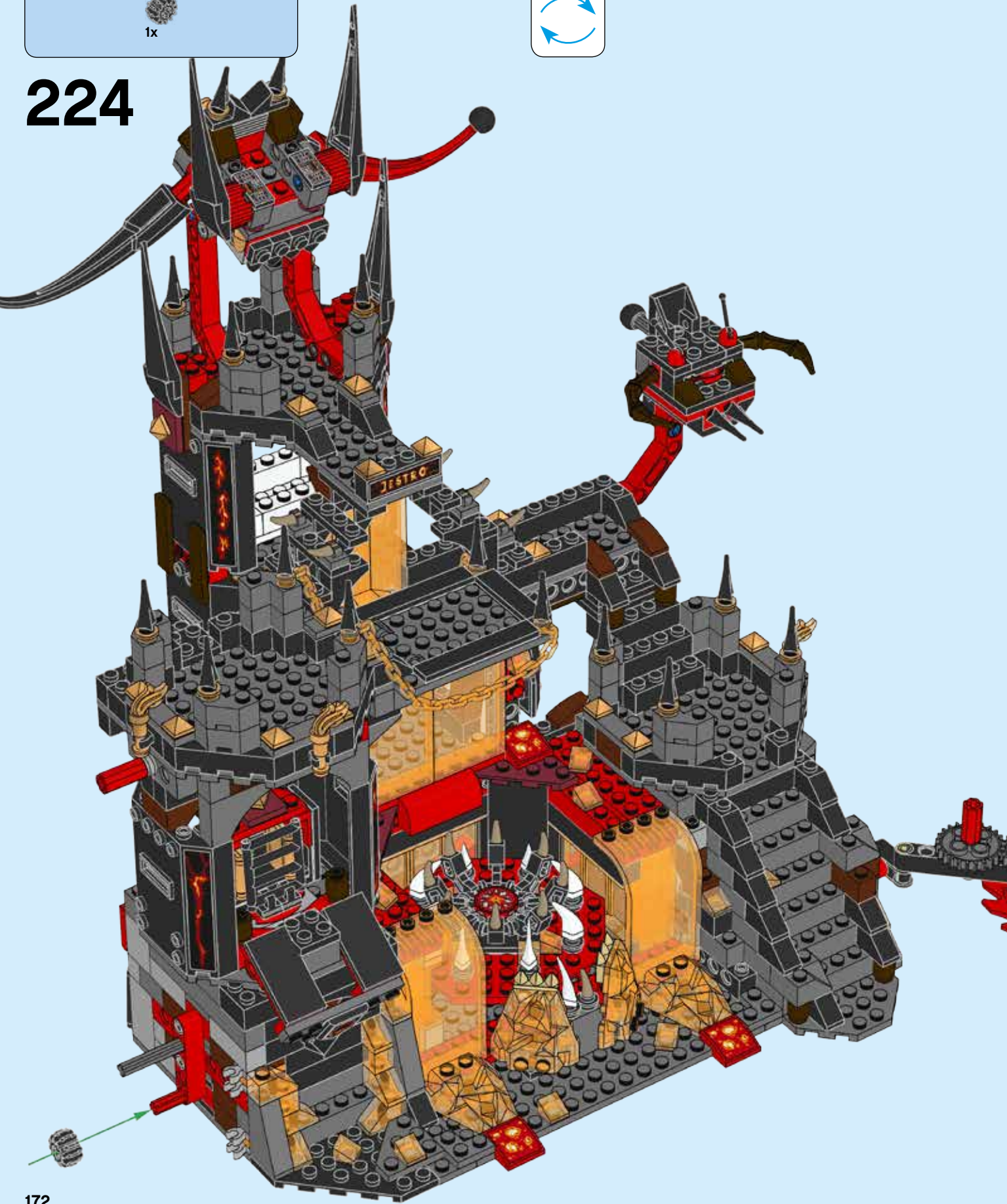

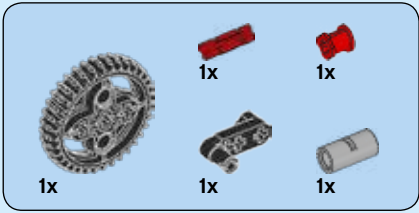

225

1



2



3



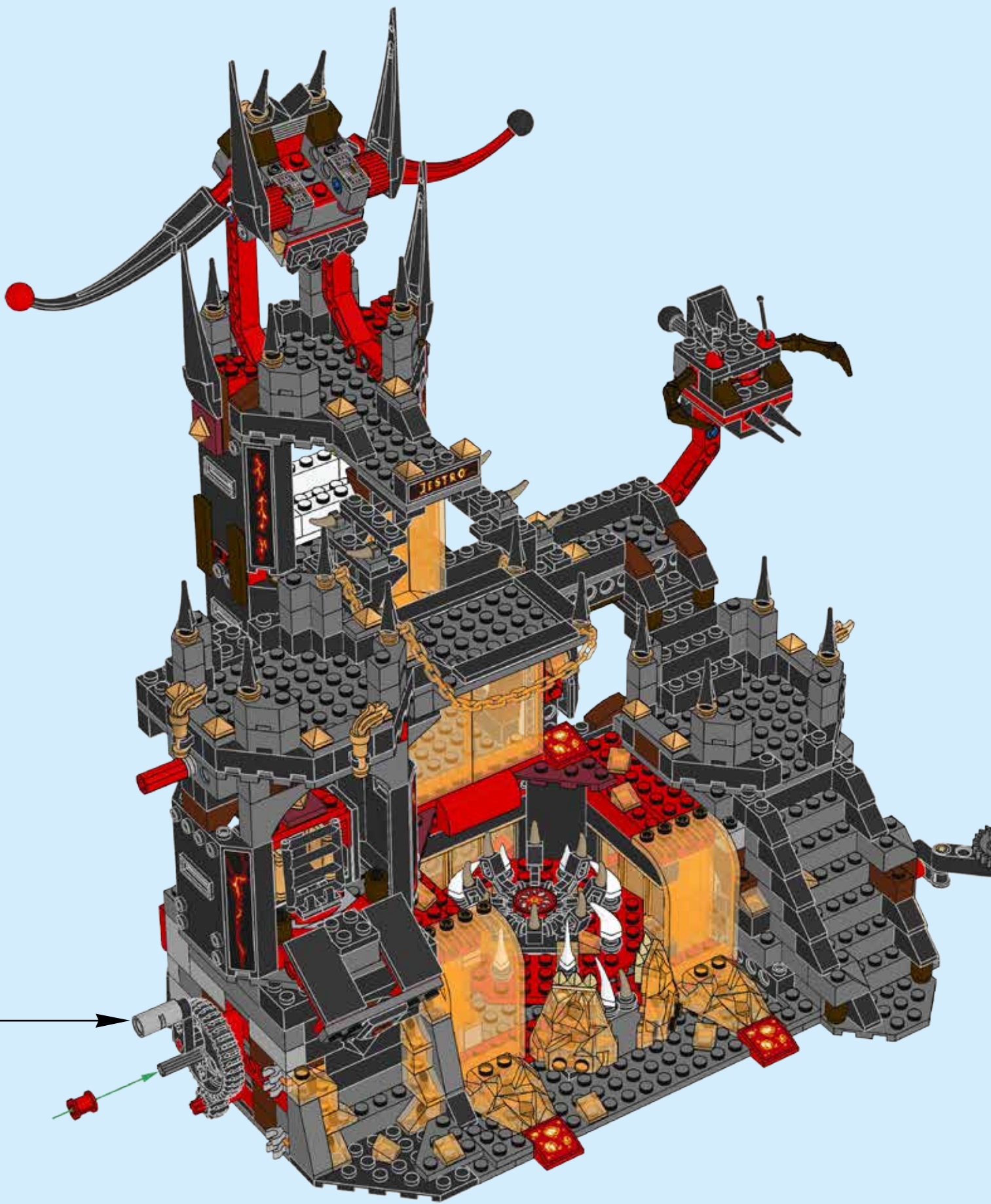

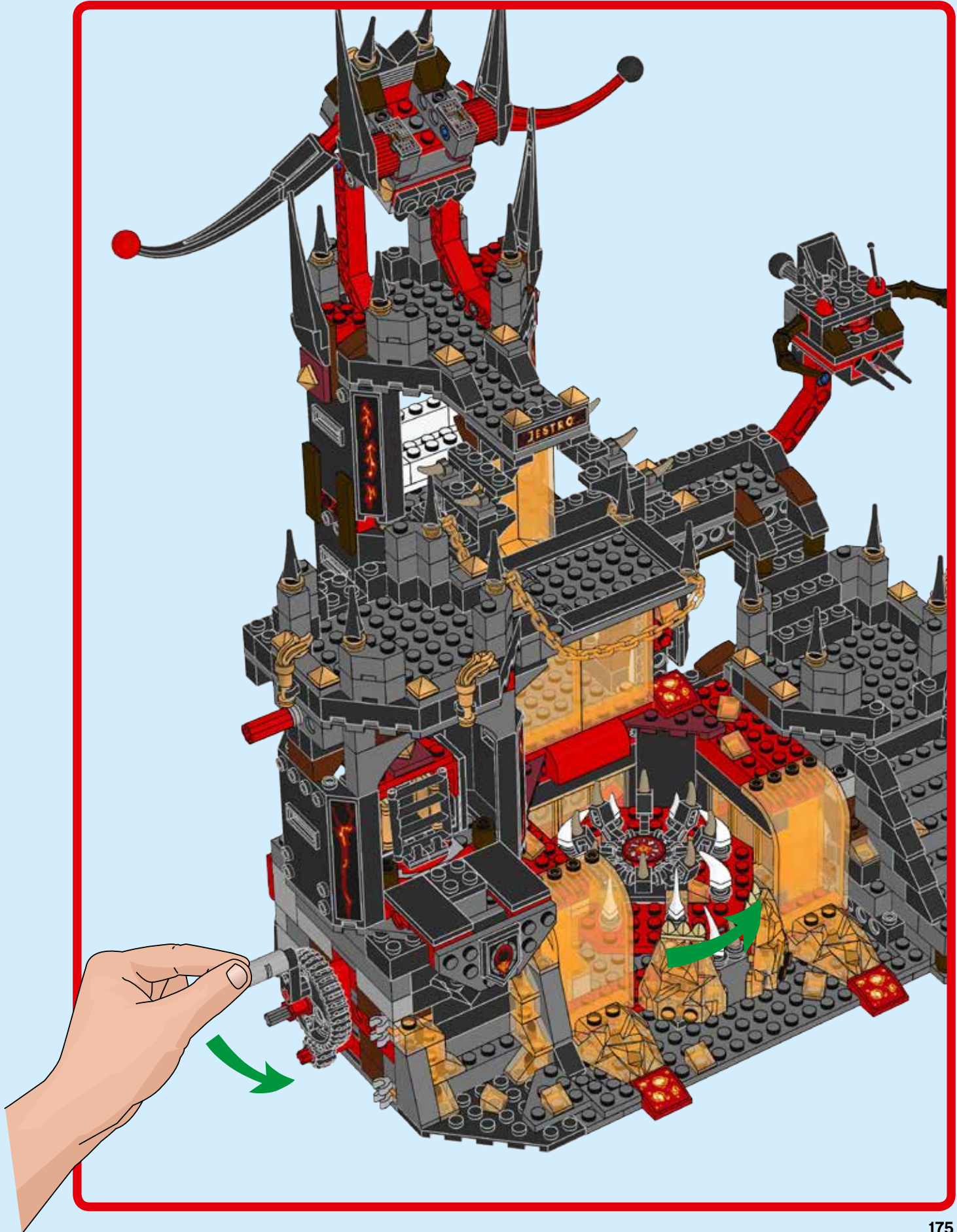

226

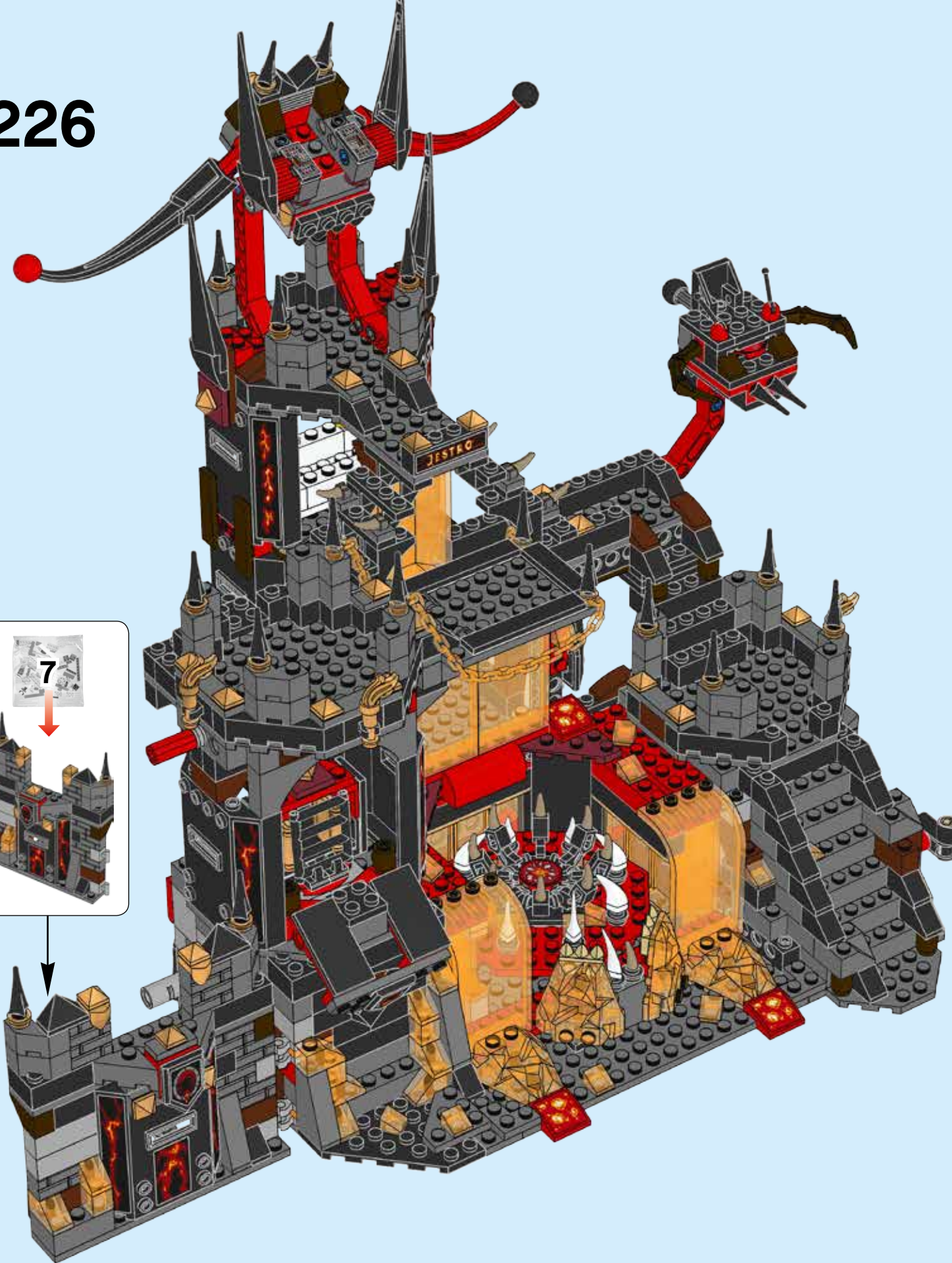
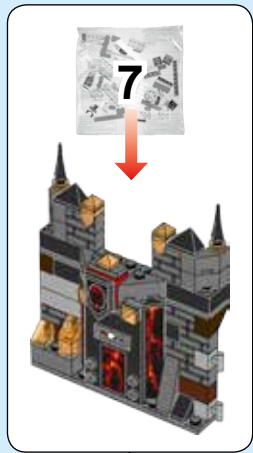

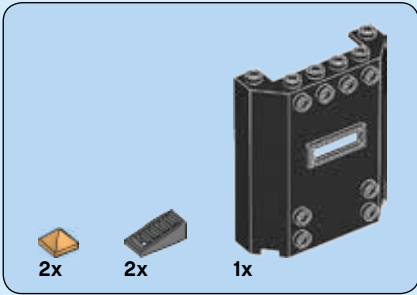

227

1

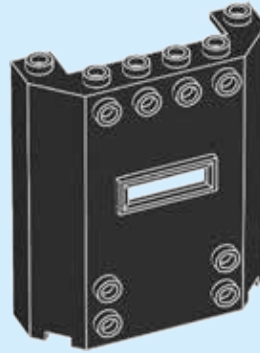

2

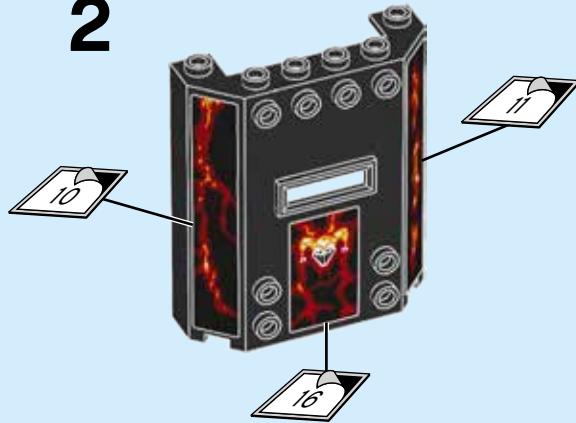

3









1x
6040333

1x
6136388

1x
4518400

1x
6126981

1x
4298609

1x
6063275

9x
4566256

4x
4567449

2x
301001

1x
395701

1x
4611927

1x
303201

3x
4565452

2x
4666579

1x
6134987

1x
6139020

1x
6134687

2x
6046907

1x
6126984

1x
6127066

1x
4290714

1x
6125677

1x
6141627

2x
6125678

3x
4254606

4x
407021

2x
4227155

1x
389921

5x
4568388

1x
4298617

1x
4521851

1x
4142865

3x
6066342

2x
6138043

2x
4650646

2x
4545430

1x
6125715

4x
4513174

1x
4185664

4x
6127728

3x
6019155

7x
370021

2x
306921

2x
6029946

6x
6117974

1x
245821

1x
4593768

2x
4226876

1x
368021

2x
306821

4x
281721

5x
6105976

6x
6061711

1x
6126979

2x
4616842

4x
428621

2x
614121

1x
6129612

1x
623221

1x
6089576

1x
6023770

2x
6129995

2x
74335

1x
6131821

1x
6125688

1x
4116617

2x
4515348

1x
4142132

1x
389421

1x
346021

6x
370221

2x
6130005

1x
6153225

5x
303421

2x
6036408

1x
6132159

3x
4268653

1x
6126960

1x
4157223

10x
371021

1x
302021

2x
6009460

4x
4143005

1x
4520946

1x
4508613

9x
4206482

2x
6069163

6x
6132158

2x
4597338

2x
486523

1x
4140586

3x
4568990

2x
6035354

5x
4514553

2x
6133519

1x
366623

1x
379523

1x
4296152

1x
6124848

1x
4593780

1x
4114584

1x
403224

2x
4632569

1x
6117938

1x
4535740

1x
6116606

1x
6130010

1x
6124964

1x
6124911

7x
4598897

22x
6135009

1x
4529236

1x
614126

10x
6100627

2x
4290713

1x
4107085

1x
4558954

4x
4273590

2x
4568385

1x
4177431

4

10

9

- 3x 6093525
- 2x 4258354
- 2x 306826
- 1x 4173970
- 5x 6053077
- 10x 300326
- 2x 302226
- 2x 6089119
- 1x 4107765
- 2x 6128992
- 5x 6038531
- 2x 362226
- 2x 362326
- 6x 4558170
- 2x 6125693
- 2x 4521681
- 4x 6147259
- 1x 6131924
- 2x 6129249
- 8x 6006739
- 1x 6131136
- 2x 6051508
- 2x 403226
- 25x 4121715
- 1x 452926
- 2x 6129250
- 1x 4596914
- 4x 6092876
- 2x 6125717
- 2x 287726
- 1x 306926
- 2x 302326
- 2x 4598528
- 2x 6069000
- 27x 4121966
- 2x 6021512
- 1x 6016279
- 6x 6000650
- 1x 4288212
- 1x 4563044
- 2x 6045914
- 6x 300226
- 1x 4560108
- 1x 6018805
- 1x 243126
- 3x 371026
- 1x 6133717
- 3x 301026
- 2x 4530589
- 1x 4535834
- 1x 6021678
- 1x 4255563
- 1x 4525078
- 5x 4560182
- 2x 302026
- 4x 300126
- 12x 6039347
- 2x 6081988
- 1x 370626
- 1x 366626
- 2x 663626
- 14x 300926
- 2x 4620763
- 8x 6129374
- 3x 4243819
- 1x 4160108
- 1x 4658977
- 1x 4500902
- 1x 6106296
- 1x 4160130
- 2x 379526
- 2x 370726
- 2x 4279270
- 1x 6037390
- 1x 4645732
- 1x 6047510
- 1x 4106977
- 2x 611126
- 2x 611226
- 9x 4107558
- 1x 4654448
- 7x 6096683
- 2x 4177932
- 3x 4173332
- 4x 6124858
- 11x 3005747
- 4x 6131726
- 5x 6127035
- 1x 6128870
- 1x 6133154
- 1x 6133133
- 1x 6133150
- 1x 6125676
- 1x 6129592
- 1x 6138915
- 1x 4107106
- 2x 6028132
- 1x 6134219
- 7x 4613761
- 1x 6134289
- 2x 4539070
- 1x 6109312
- 17x 6022717
- 1x 6031821
- 1x 6055631

1x
4565320

1x
4540280

4x
4502089

2x
6129858

1x
6018481

12x
6022650

4x
6120910

4x
6126958

14x
6134722

23x
4244369

6x
4262655

4x
4649066

1x
6138486

10x
6126967

8x
6108173

2x
6132438

1x
302328

1x
4646864

1x
4183544

3x
6023173

1x
6122117

1x
6099728

4x
4211183

4x
4221744

1x
6134672

1x
6134707

1x
6035291

6x
6069984

20x
4211149

2x
4211150

3x
4216695

2x
4211200

13x
4211221

2x
4211186

4x
6044725

1x
4211185

3x
4211204

1x
4211247

1x
6030812

1x
4211207

1x
4539481

5x
4650260

2x
4211573

1x
4211511

1x
4211758

2x
4225532

1x
4211508

4x
4594238

2x
4514195

1x
4540203

1x
4211491

1x
4512743

1x
6124926

1x
6124929

2x
6004888

1x
4526985

3x
4585429

2x
4654582

2x
4211644

2x
4556157

1x
4535738

4x
4211353

1x
4211815

2x
4211865

2x
4520320

2x
6039505

7x
4211428

1x
4211640

2x
4211466

2x
4211442

1x
4211374

1x
4211408

3x
4490127

4x
6065824

2x
6034676

2x
6100030

1x
6012451

2x
4211098

8x
6071226

2x
4210639

1x
6020189

1x
4211042

4x
4567887

1x
6129718

1x
6124855

1x
6124972

1x
6124857

1x
4540386

7x
4211063

28x
4624186

4x
4211087

2x
4210697

3x
4211094

6x
4210635

1x
4234534

1x
4520307

2x
4210702

2x
6133119

1x
4547958

2x
4521886

2x
4582257

4x
6019987

5x
6092572

9x
6000311

2x
4210631

3



1x
4595708

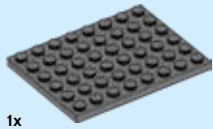

1x
4210794



1x
4210963



4x
4583688

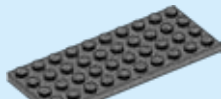

4x
4211122



2x
4211067

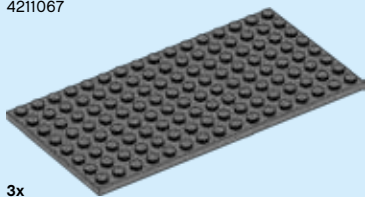

3x
4654613

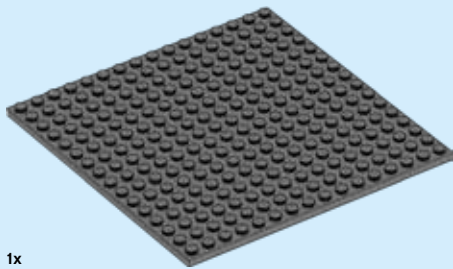

1x
6004927



5x
4221745



7x
4213607



8x
4598769



1x
4210897



2x
4210984



2x
4211100



7x
4210875



1x
4211002



1x
4595710



8x
4211099



2x
6079721

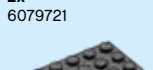

1x
4211115



4x
4211105



1x
4211064



1x
4211024



2x
6083620



1x
6044591



4x
4538126



6x
6022105



4x
6033014



5x
4654915



2x
6034202



2x
4623775



11x
4536989



2x
6051523



1x
6046942



3x
4518687



1x
6133304



3x
6127036



2x
6088641



1x
6123838



2x
6008483



1x
6128617



1x
6127153



3x
6129534



1x
6128615



1x
6134601



1x
6134602



2x
6129662



3x
6129453



1x
6125675



1x
6131743



1x
6093534



1x
6037634



2x
6133843



2x
6021670



1x
6133248



1x
6133662



3x
4640843



14x
4523159



4x
4529247



2x
6126113



32x
6129416



4x
6083975



2x
6138666



Customer Service

Kundenservice

Service Consommateurs

Servicio Al Consumidor

LEGO.com/service or dial



00800 5346 5555 :

1-800-422-5346 :





NEXO KNIGHTS



DOWNLOAD THE FREE APP



LEGO® NEXO KNIGHTS™: MERLOK 2.0



DOWNLOAD THE FREE APP/KOSTENLOSE APP HERUNTERLADEN/TÉLÉCHARGE L'APPLI GRATUITE
 DESCARGA LA APP GRATIS/DESCARREGA A APP GRÁTIS/TÖLTSD LE AZ INGYENES APPOT!/ 下载免費 APP
 DEVICE CHECK;/GERÁT PRÜFEN;/VERIFICATION DE COMPATIBILITÉ :
 COMPRUEBA TU DISPOSITIVO;/VERIFICAÇÃO DO DISPOSITIVO;/ESZKÖZELLENŐRZÉS;/设备检查:

LEGO.com/devicecheck



NEXO KNIGHTS



SCANNING TIPS

Scanning Tips / Tipps zum Scannen / Conseils de scannage /
Consejos para escanear / Dicas para o scan / Beolvasási tippek / 扫描秘诀





NEXO KNIGHTS™



LEGOLAND



DOWNLOAD THE FREE APP:
 KOSTENLOSE APP HERUNTERLADEN:
 TÉLÉCHARGE L'APPLI GRATUITE :
 DESCARGA LA APP GRATIS:
 DESCARREGA A APP GRÁTIS:
 TÖLTSD LE AZ INGYENES APPOT!
 下載免費APP:

LEGO® NEXO KNIGHTS™: MERLOK 2.0

ALL MATERIALS MIGHT NOT BE AVAILABLE IN ALL MARKETS.
 MÖGLICHERWEISE IST NICHT DAS GANZE MATERIAL IN ALLEN MÄRKTEN VERFÜGBAR./CERTAINS PRODUITS PEUVENT NE PAS ÊTRE DISPONIBLES SUR CERTAINS MARCHÉS./CIERTOS MATERIALES PODRIAN NO ESTAR DISPONIBLES EN TODOS LOS MERCADOS./OS MATERIAIS PODERÃO NÃO ESTAR TODOS DISPONÍVEIS EM TODOS OS MERCADOS./ELKÉPZELHETŐ, HOGY BIZONYOS KIEGÉSZÍTŐK A TE ORSZÁGODBAN NEM ELÉRHETŐEK./部分内容可能不适用于某些国家/地区

LEGO.COM/NEXOKNIGHTS



NEXO KNIGHTS







NEXO KNIGHTS



SCURRIER
70323



SCURRIER
70323



BOOKKEEPER
70323



ULTIMATE GENERAL MAGMAR
70338



BURNZIE
70322



BOOK OF MONSTERS
70323



JESTRO
70323



FLAMA
70321



GENERAL MAGMAR
70321



CRUST SMASHER
70319



ASH ATTACKER
* 70320 / 70322 / 70323



FLAME THROWER
70318



LAVARIA
70323

* Weapons and decorations vary by set/Zubehör und Dekoration variieren je nach Set/
As armas e decorações variam consoante o conjunto/



ULTIMATE FLAMA
70339



ULTIMATE LANCE
70337



ULTIMATE AXL
70336



AARON
70320



LANCE
70323



CLAY
70321



AXL
* 70322 / 70323



MACY
* 70319 / 70323



AXL BOT
70322



MACY BOT
70319



AARON BOT
70320



ROYAL GUARD
70318



Les armes et les décorations varient selon les boîtes / Las armas y accesorios varían según el set /
A fegyverek és dekorációk készletenként változnak. / 套裝不同，武器和裝飾各有不同

NEW



NEU LEGO® NEXO KNIGHTS™ 4D-Film

**NOUVEAU LEGO® NEXO KNIGHTS™
Film 4D**

**NUEVO LEGO® NEXO KNIGHTS™
Película 4D**

NOVO LEGO® NEXO KNIGHTS™ 4D filme



**LEGO® NEXO KNIGHTS™
4D Movie**



ÚJ LEGO® NEXO KNIGHTS™ 4D film

全新LEGO® NEXO KNIGHTS™4D电影

NY LEGO® NEXO KNIGHTS™ 4D film

**新しいLEGO® NEXO KNIGHTS™
の4D映画!**

Yeni LEGO® NEXO KNIGHTS™ 4D film!



NEXO KNIGHTS





NEXO KNIGHTS



LEGO.COM/NEXOKNIGHTS



club™



1

2

3



WIN

GO TO WWW.LEGO.COM/PRODUCTFEEDBACK
AND GIVE US YOUR SHORT **FEEDBACK**
ABOUT THIS LEGO® SET FOR A CHANCE
TO WIN A COOL LEGO PRIZE.

Terms & Conditions apply



LEGO.com/productfeedback

GEWINNE

Erzähle uns auf
www.LEGO.com/productfeedback

etwas über die Erfahrungen, die du mit
diesem LEGO® Set gemacht hast, und
sichere dir die Chance auf einen coolen
LEGO Preis!

Es gelten die Teilnahmebedingungen

GAGNE

Rends-toi sur
www.LEGO.com/productfeedback

et donne-nous quelques commentaires
sur ce produit LEGO® pour avoir une
chance de gagner un prix LEGO !

Voir Conditions Générales

GANAN

Visita
www.LEGO.com/productfeedback

y envíanos tu opinión acerca de este
set LEGO®. ¡Participarás en el sorteo
de un premio LEGO!

Términos y Condiciones aplicables

获取奖品

登录
www.LEGO.com/productfeedback

给出关于此乐高®套装的简短反馈，
就有机会获得炫酷乐高奖品

《条款及条件》适用

경품 당첨 기회

www.LEGO.com/productfeedback

페이지로 이동하여 이 레고® 세트에 대한
간략한 피드백을 보내 주시고 멋진 레고
경품을 탈 수 있는 기회도 잡으십시오

약관 적용

ЗАПОЛНИ АНКЕТУ И ПОЛУЧИ ПРИЗ

Перейди по ссылке
www.LEGO.com/productfeedback

ответь всего на несколько вопросов
об этом наборе LEGO®, и у тебя появ-
ится шанс выиграть замечательный
приз от компании LEGO.

Применяются Условия и правила
участия