



BBC

# DOCTOR WHO

21304



- Booklet available in English on
- Heft in deutscher Sprache erhältlich auf
- Livret disponible en français sur
- Folleto disponible en español en
- Folheto disponível em português em
- A füzet magyarul ezen a honlapon olvasható
- Libretto disponibile in Italiano su
- 如需中文版手册，请访问 [www.LEGO.com/ideas](http://www.LEGO.com/ideas)

[LEGO.com/ideas](http://LEGO.com/ideas)

# Doctor Who

The Doctor is a Time Lord who travels through time and space solving problems and battling injustice across the universe. His old and occasionally unreliable time machine, the TARDIS, looks like a small British police box on the outside, but is much, much larger on the inside. As a Time Lord, the Doctor cannot die; instead he “regenerates” into a new body and takes on a new personality each time.

The cult BBC science fiction series, *Doctor Who*, first made its appearance in 1963 and is still immensely popular more than 50 years later, after 800 episodes and 12 different Doctors.





## The Eleventh Doctor



Fascinated by both the largest and tiniest of things, the Eleventh Doctor has a powerful sense of what is right and wrong. His dress sense might be a bit odd, but he knows that bow ties are cool!

The Eleventh Doctor had grown old on Trenzalore and as the Dalek armies gathered to see him finally defeated, Clara persuaded the Time Lords to grant him a new regeneration cycle.

After destroying his old enemies he reached the TARDIS, phoned the future and completed his regeneration. The era of the fierce, fiery Twelfth Doctor was beginning...

## The Twelfth Doctor



Sharp, impatient and with a lightning-fast thought process, the Twelfth Doctor may not be big on hugs, but he is drawn to danger and is incredibly brave.

## The Daleks



Created by the evil scientist Davros, the Daleks were born without any compassion or pity and have a strong belief that they are the superior creatures in the Universe.

## Clara Oswald



Clara is the Doctor's extraordinary companion. Kind, cheeky and optimistic, she travels with the Doctor and is always in the middle of his most exciting adventures.

## Weeping Angel



The Weeping Angels have the ability to send other beings into the past. They then feed on the potential time energy of what would have been the rest of their victim's lives.



# The TARDIS



When the Doctor first touched the TARDIS console he said the ship was the most beautiful thing he'd ever known. Then he took off, crashing through the cosmos, saving people and planets, and being taken where he needed to go by his magnificent time machine.

1



2

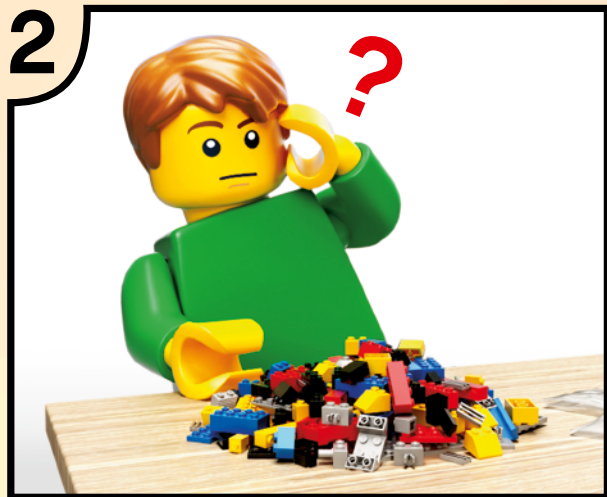

3



4





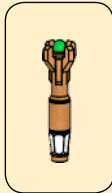
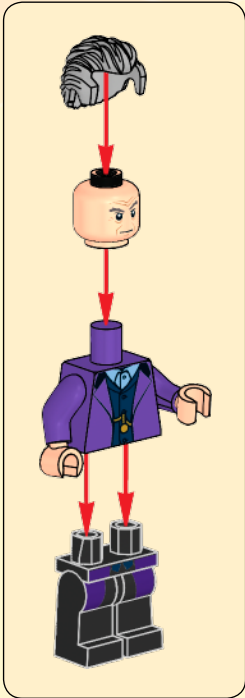
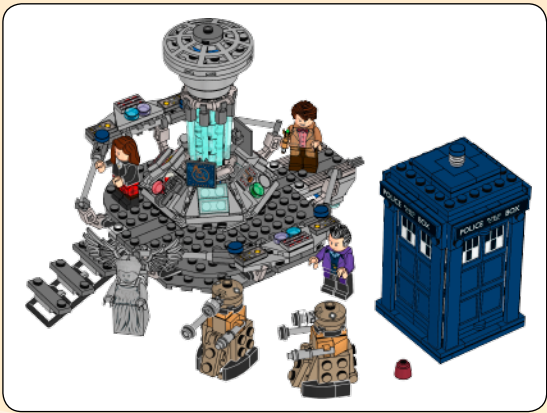

1

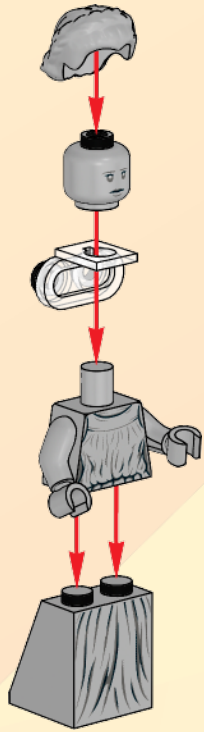

2

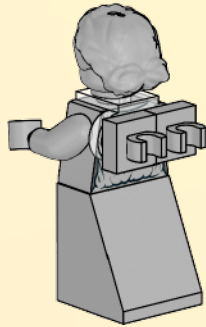
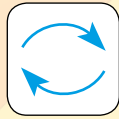

3

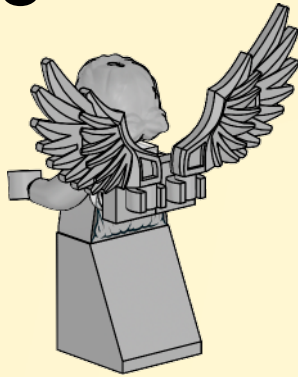

4

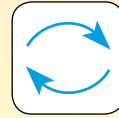



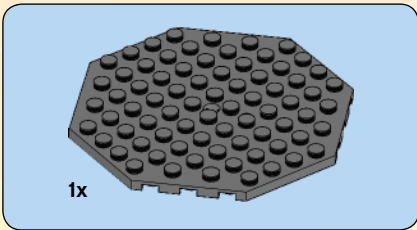
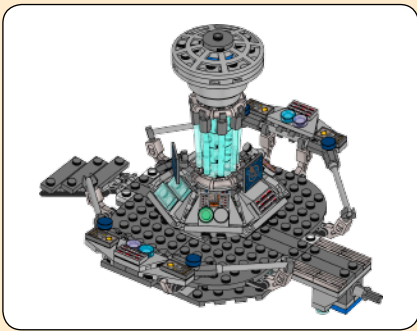

**1**

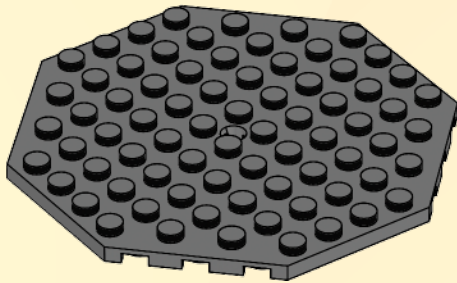

**2**

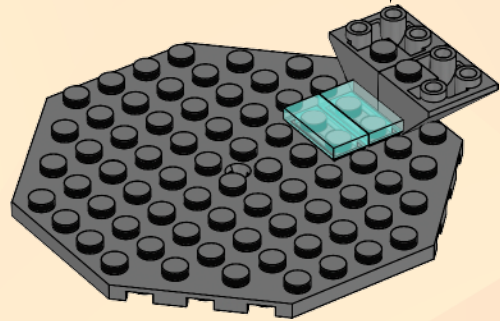
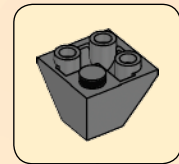



4x

3

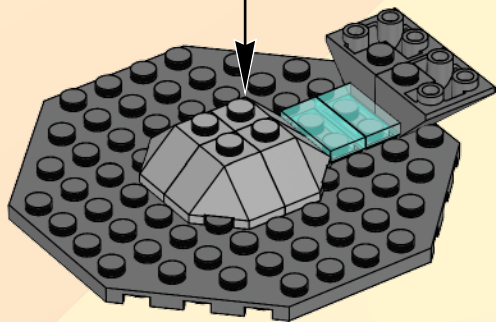
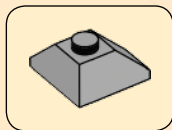

6x

4

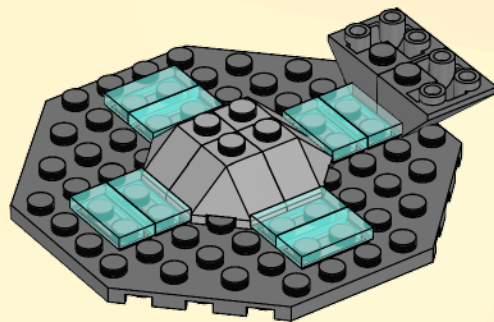



8x

5

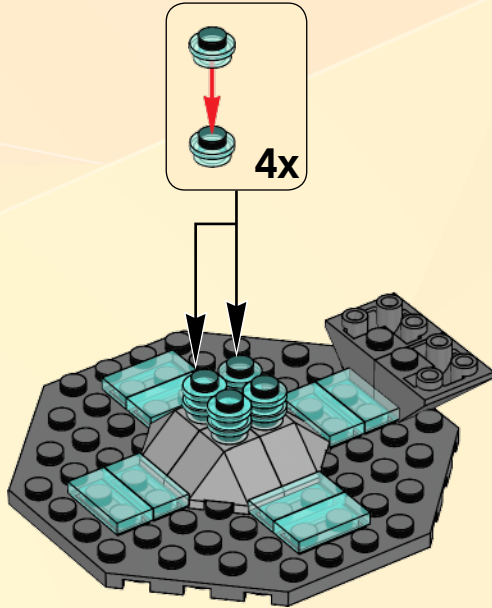

6

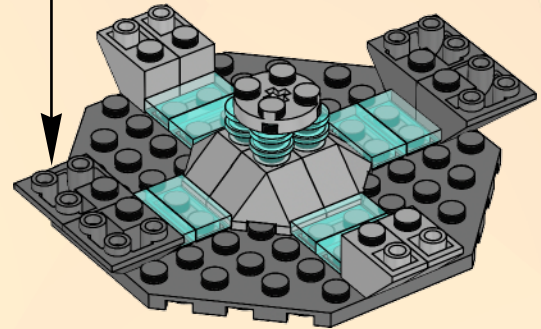
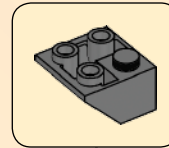

*The Doctor never travels without his sonic screwdriver; the multi-purpose tool that can unlock doors, scan bodies and track alien life.*





2x

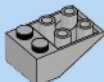

4x

# 7

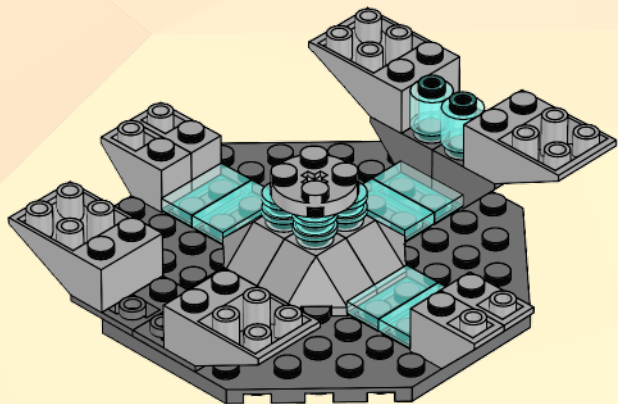

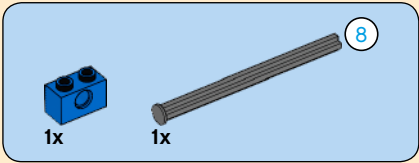
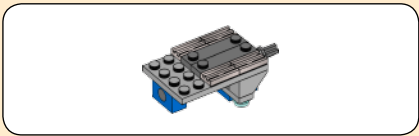

1

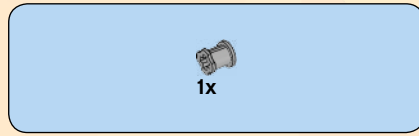
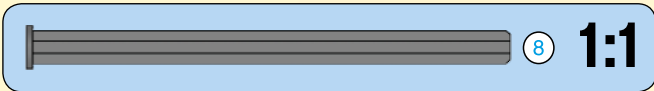
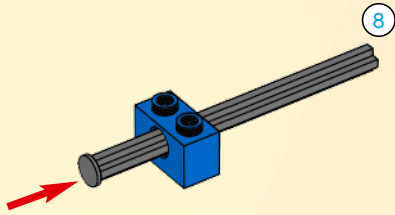

2

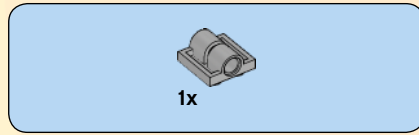
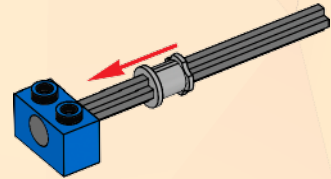

3

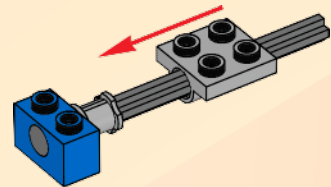





2x

4

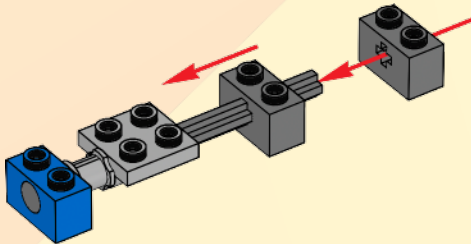
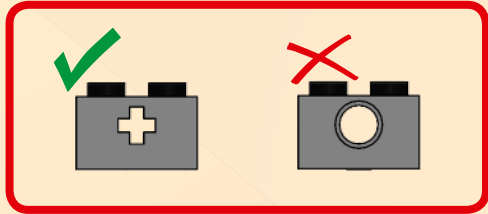

1x

5

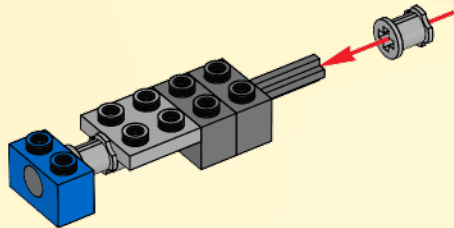

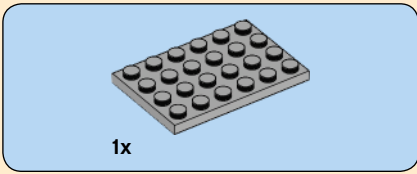

6

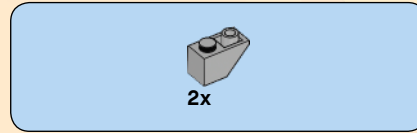
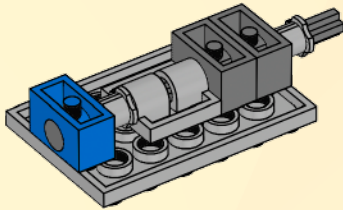
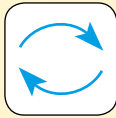

7

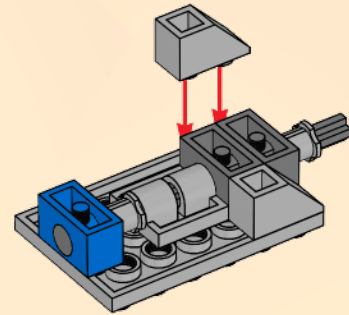



2x

8

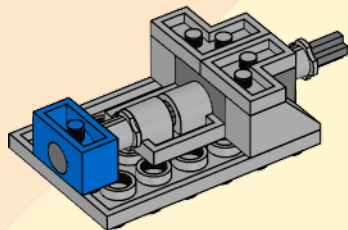

1x



2x

9

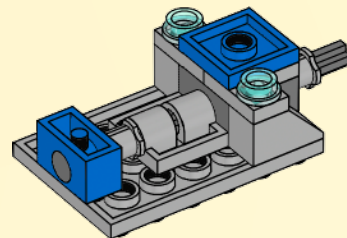

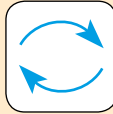
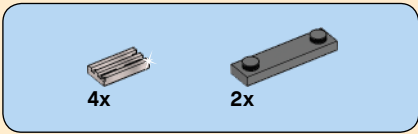

10

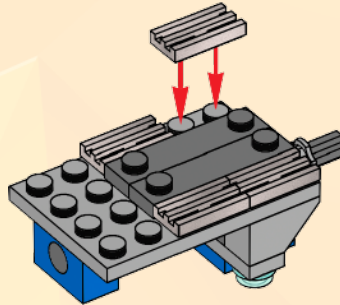

8

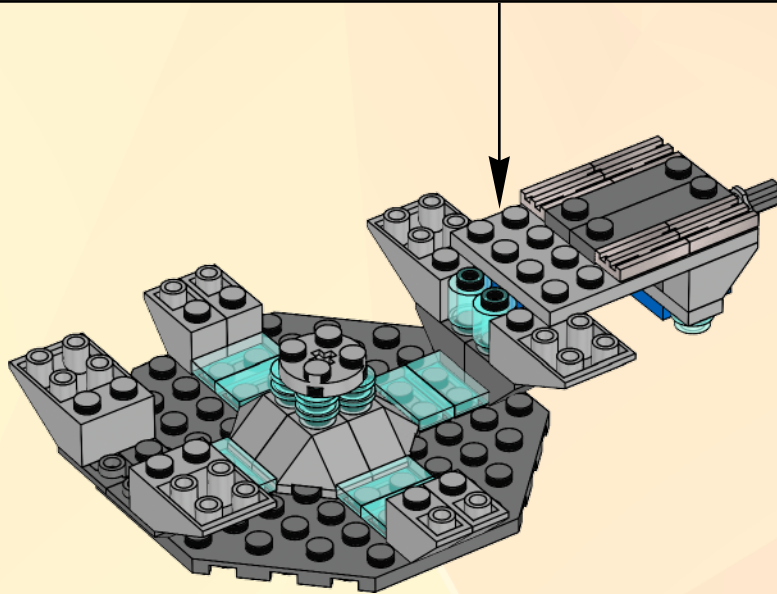



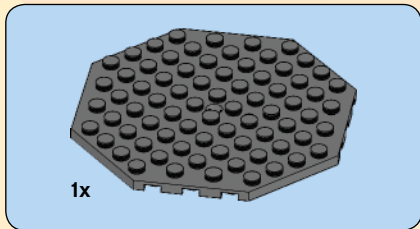

1

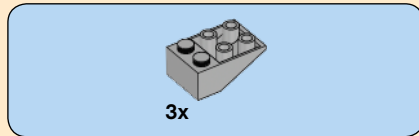
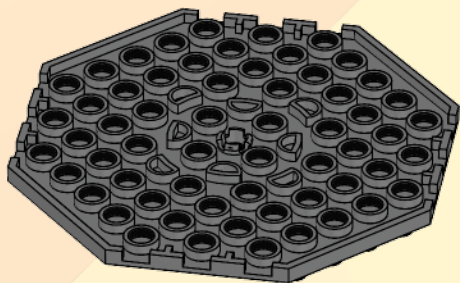

2

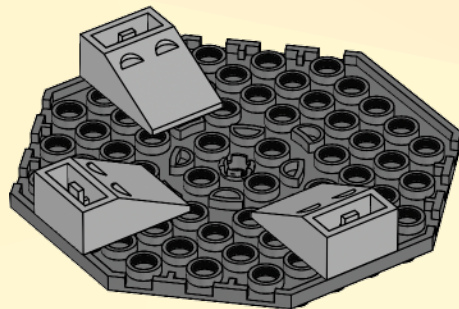

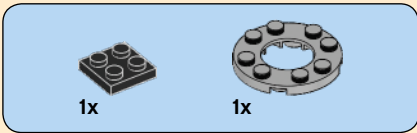

3

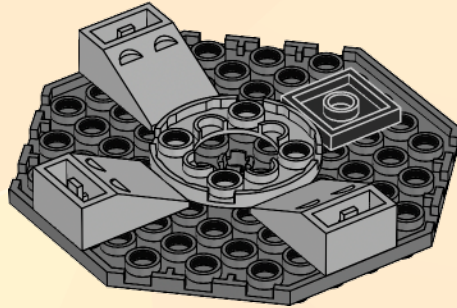

9

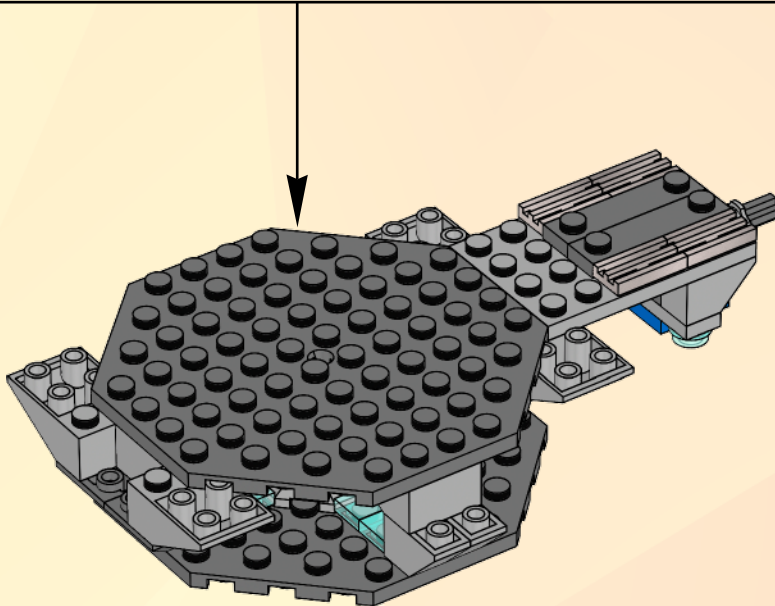



1x



4x

# 10

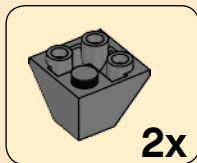

2x

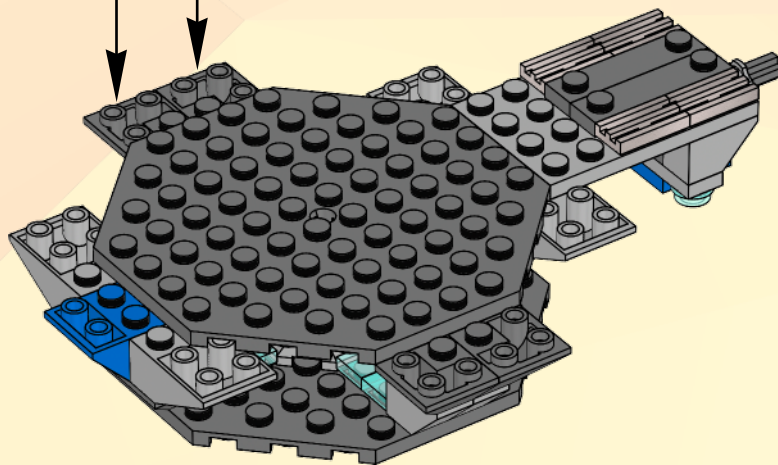

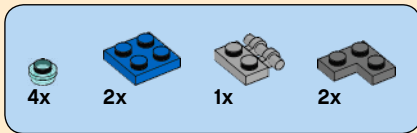

11

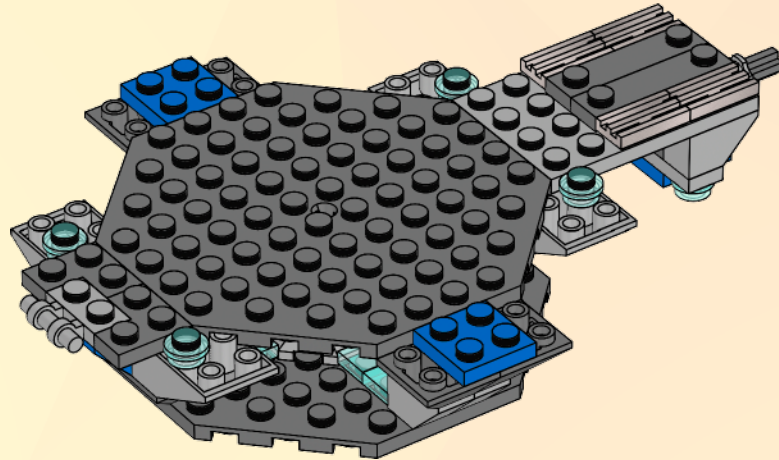





8x

# 12

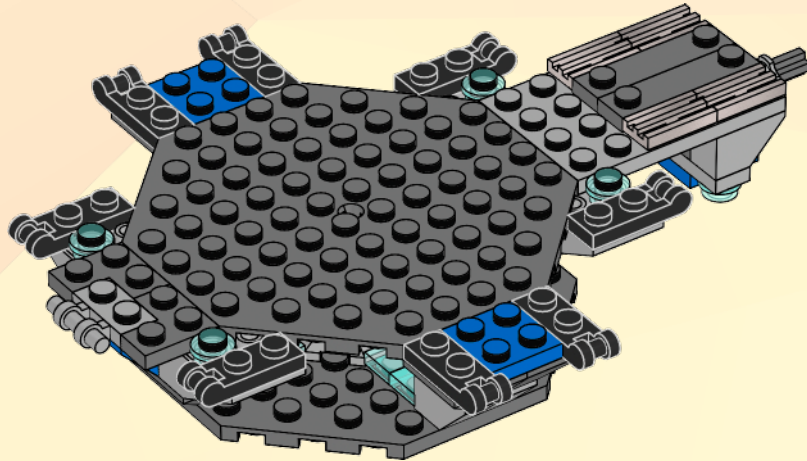

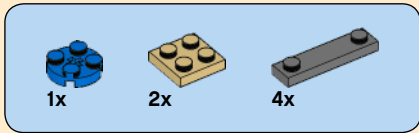

# 13

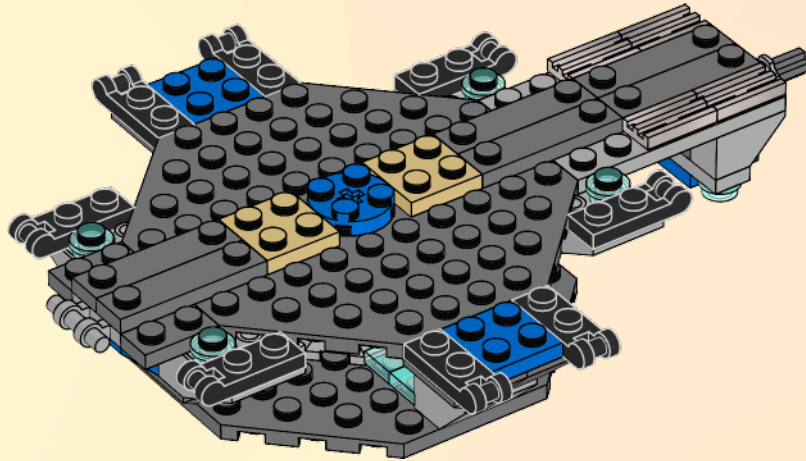

*The Weeping Angels only move when no one is looking at them. When observed, they instantly turn into stone.*

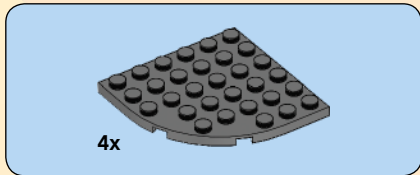

14

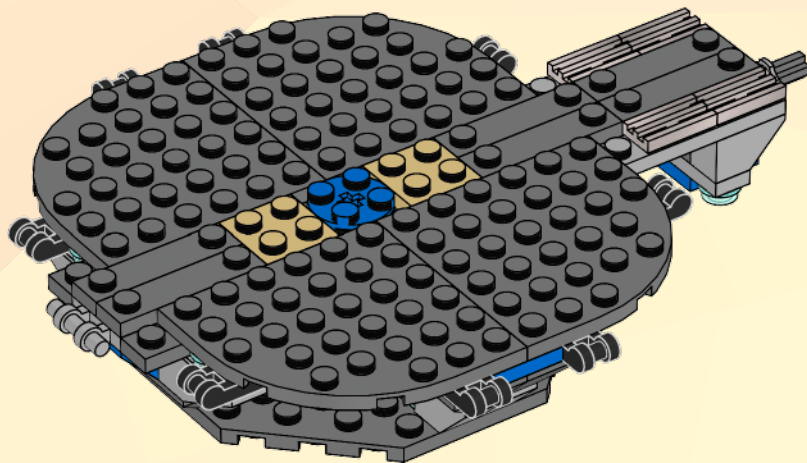





4x

# 15

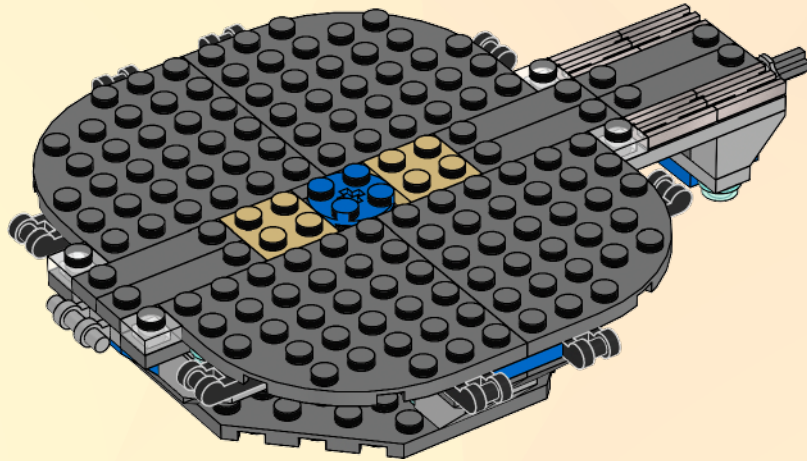



1x

# 16

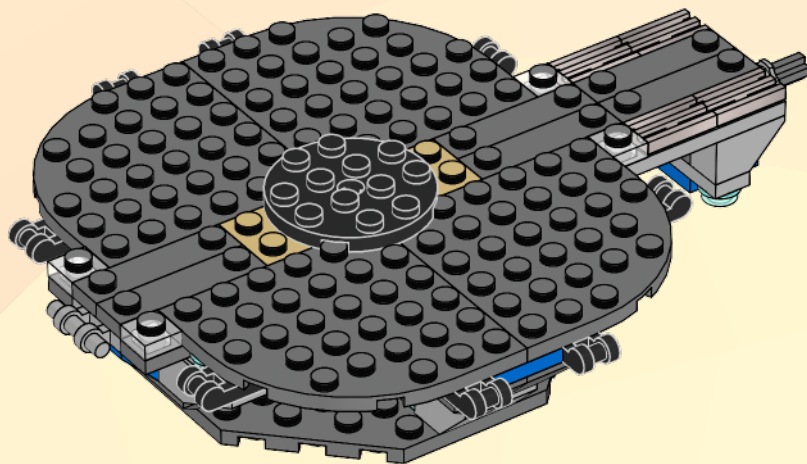

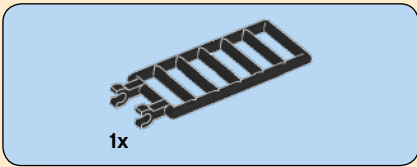

17

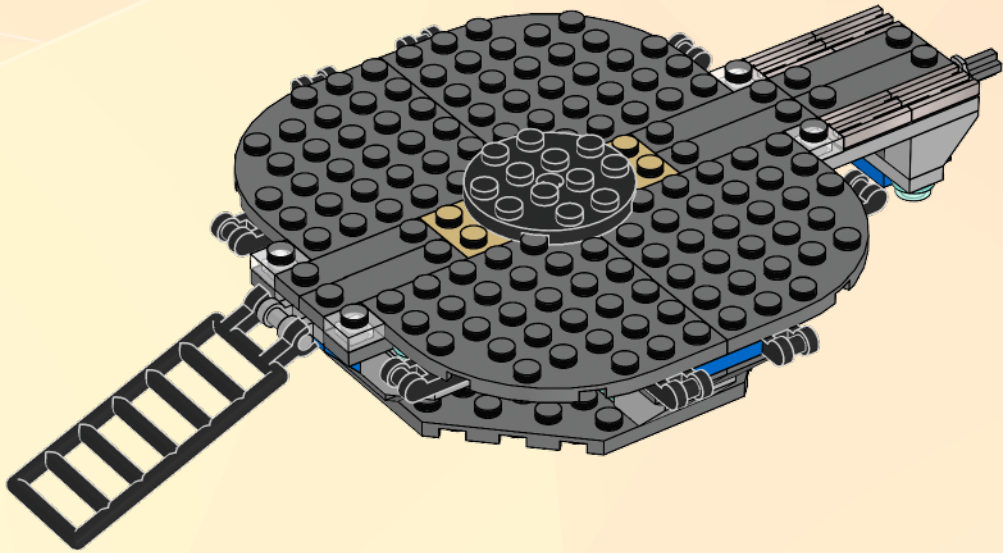

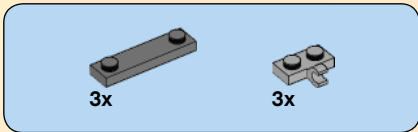

# 18

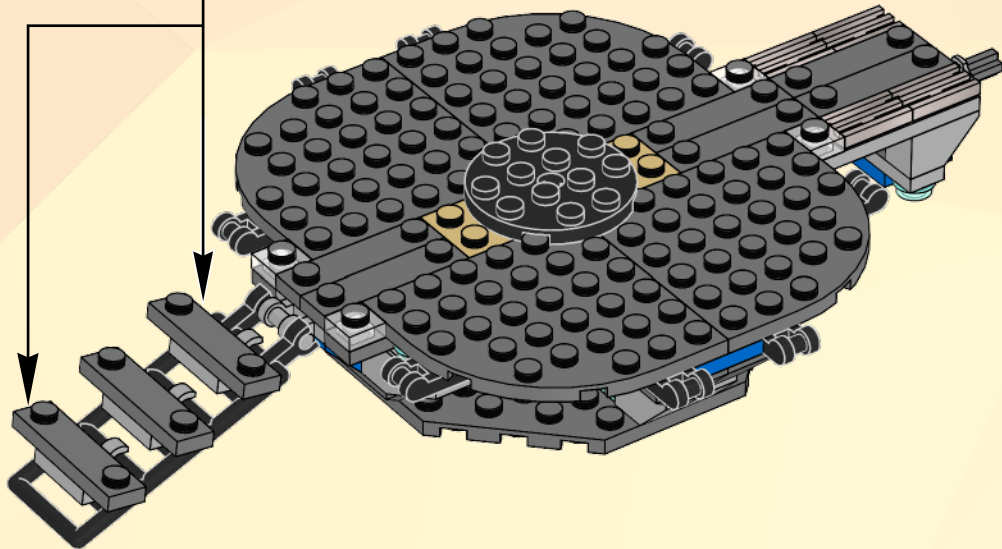
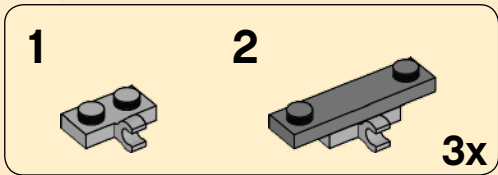





4x

# 19

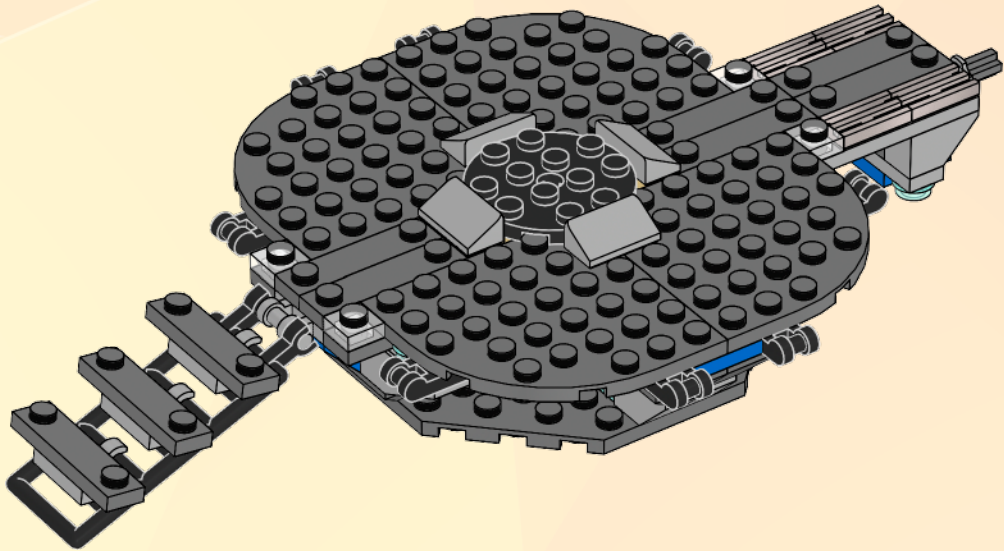



8x



8x

# 20



8x

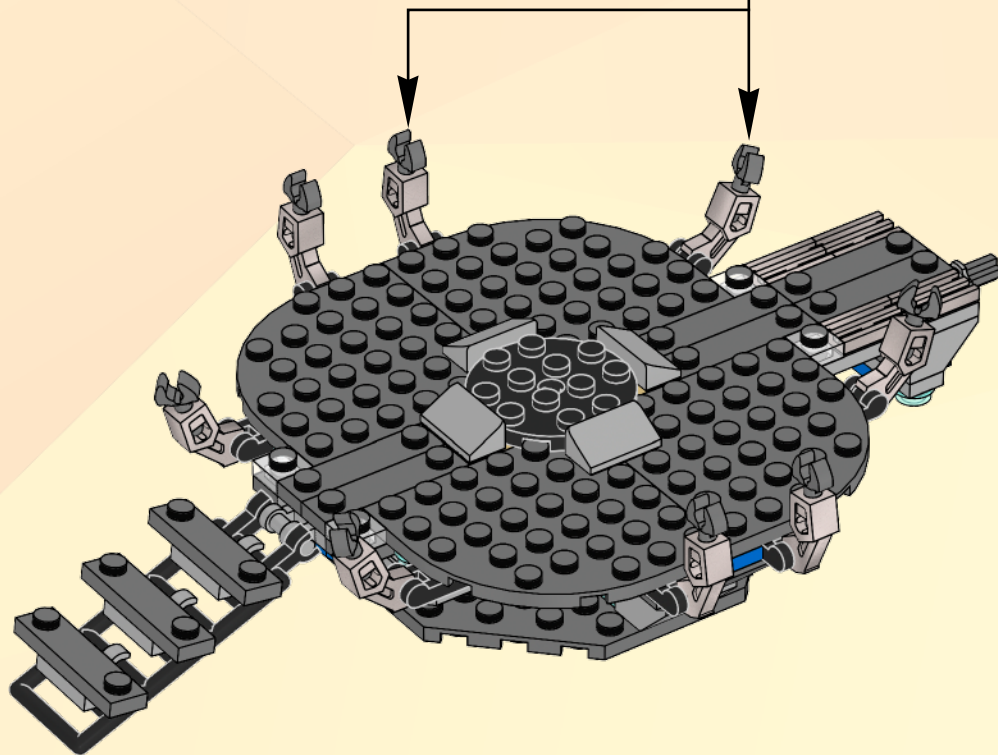

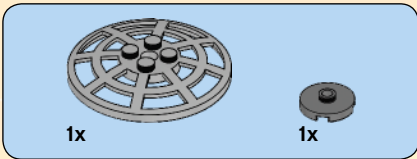
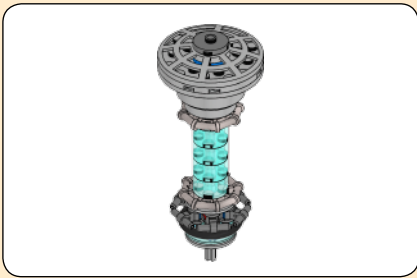

1

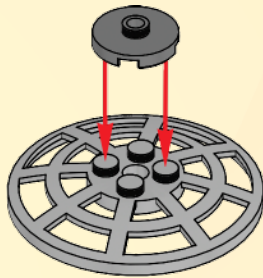

2

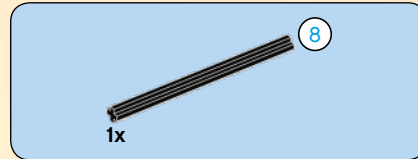
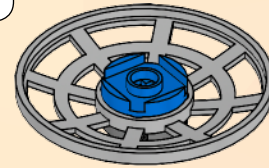
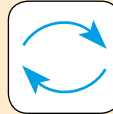

3

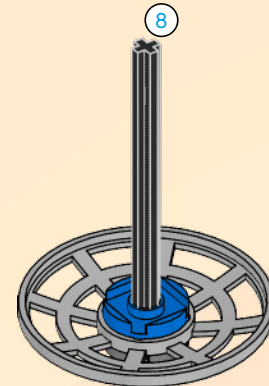

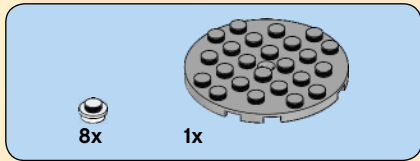

4

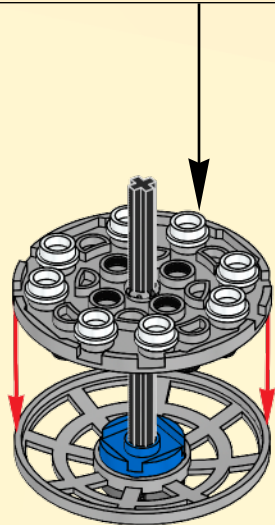
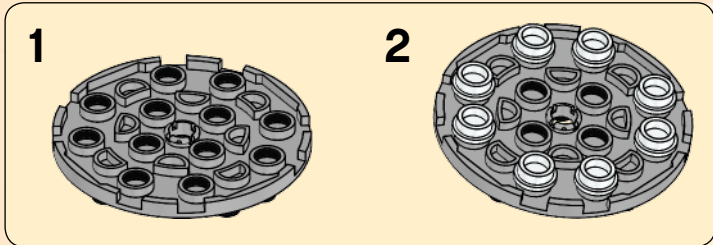

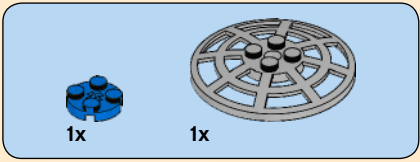

5

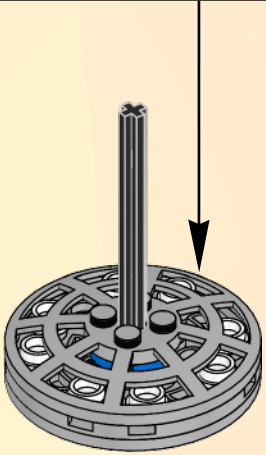
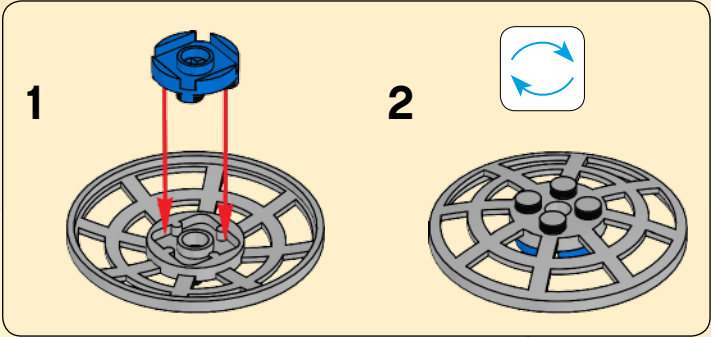





1x



1x

6

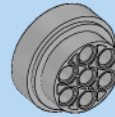
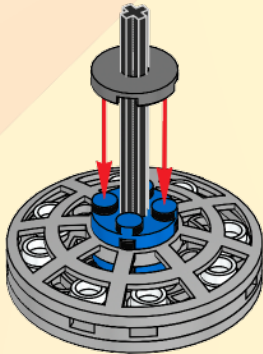

1x

7

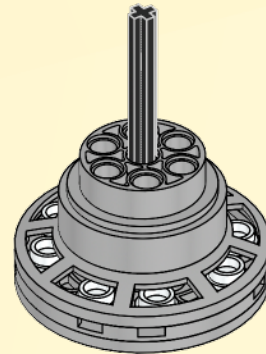

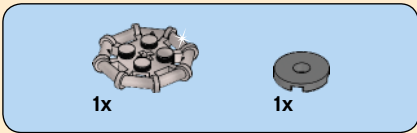

8

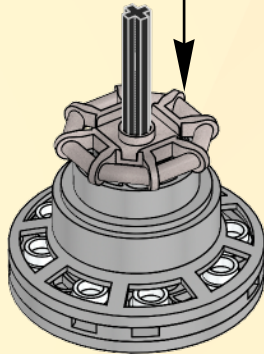
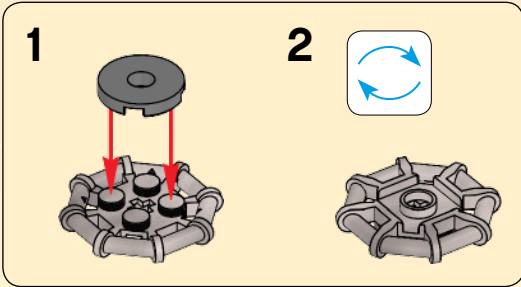

9

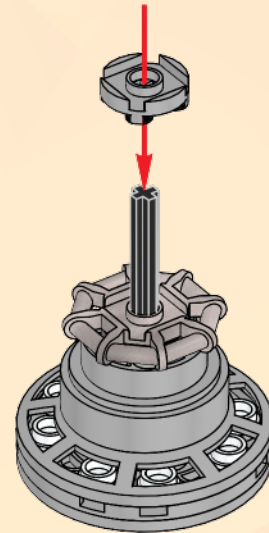



2x

10

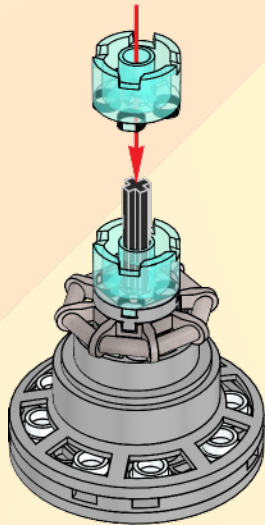

2x

11

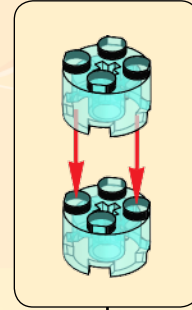

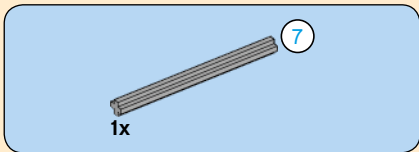

12

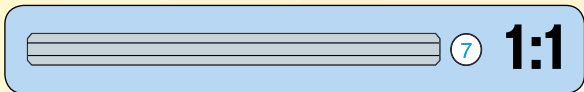
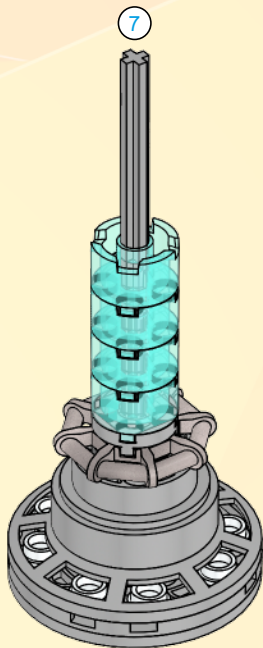

13

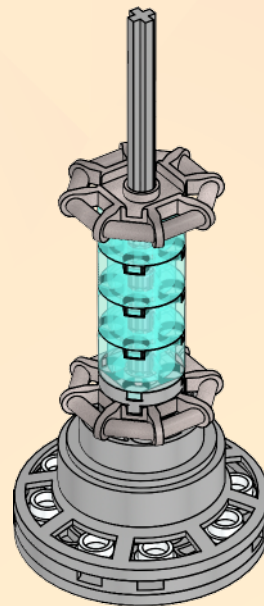



1x

14

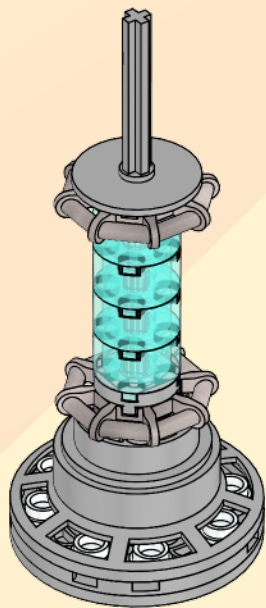

1x

15





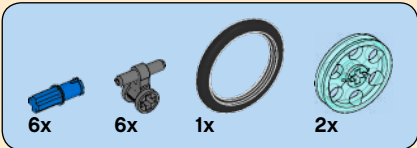

# 16

1

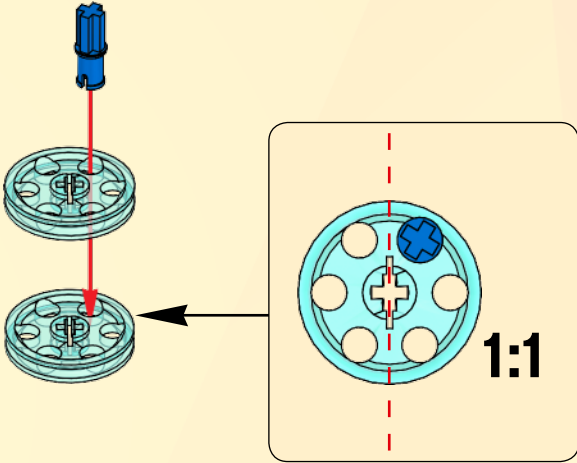

2



3



4

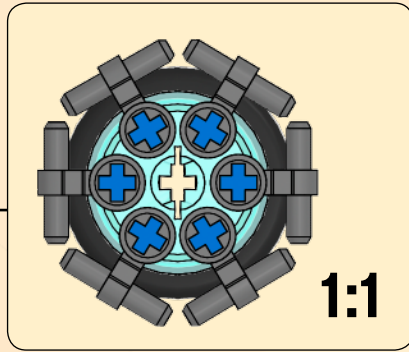

5

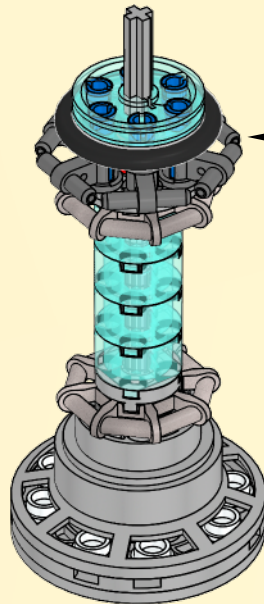
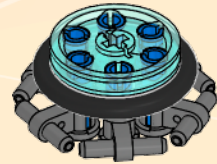
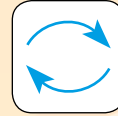

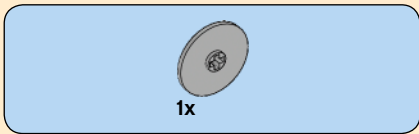

17

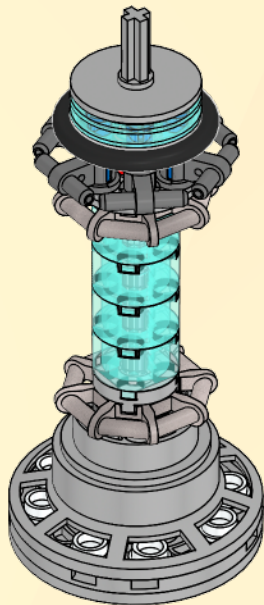

18

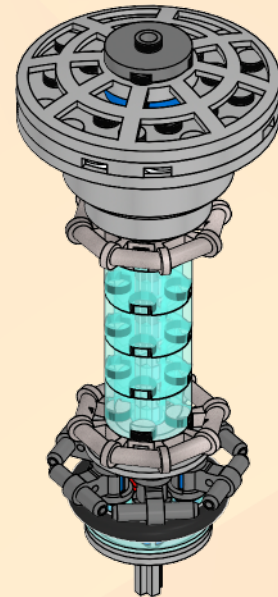
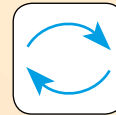

21

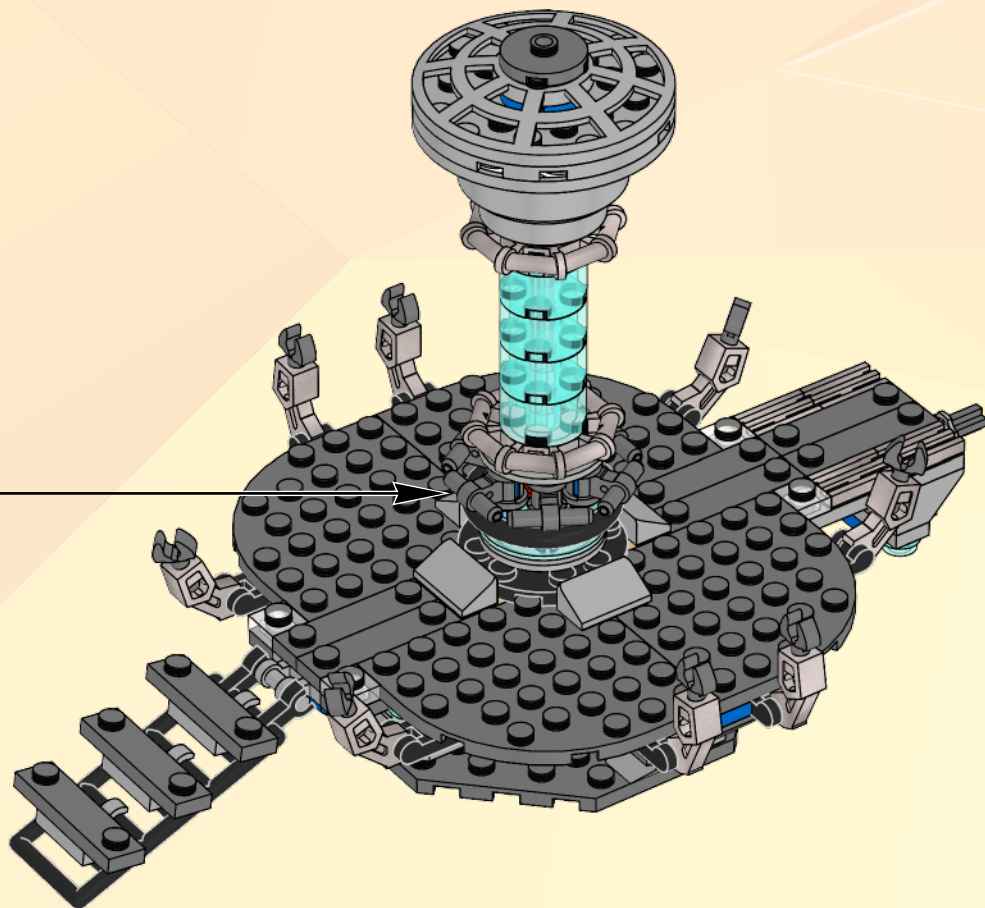

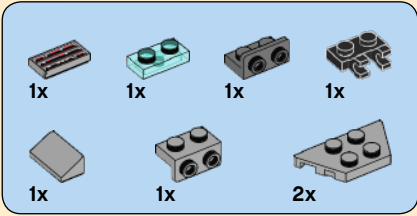

22

1

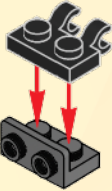

2



3

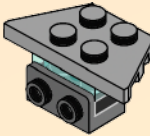



4

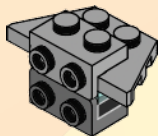

5

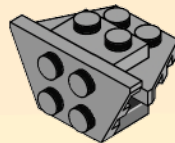

6

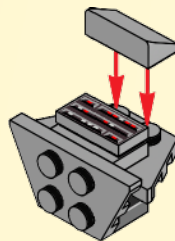

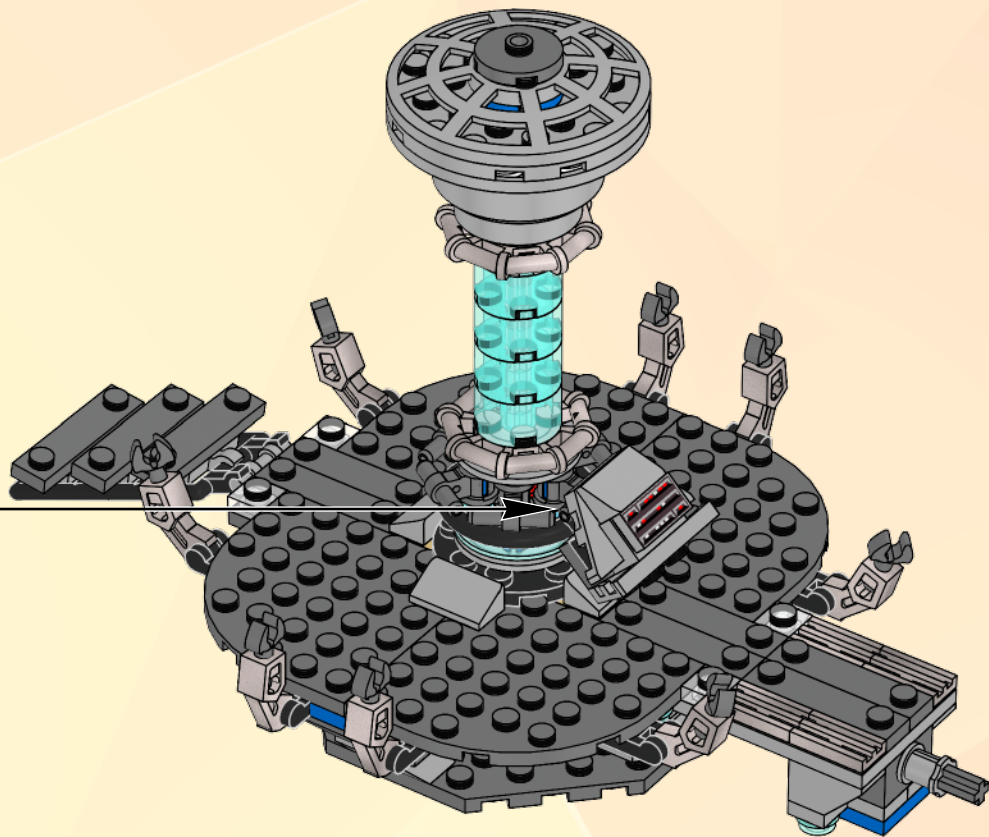

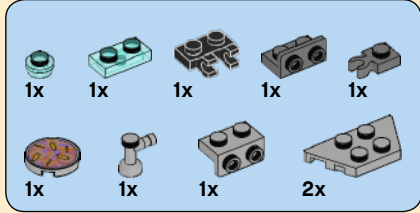

23

1

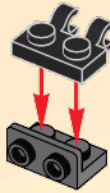

2

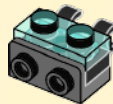

3

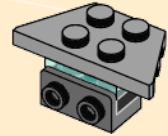

4

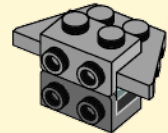

5

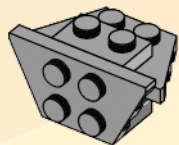

7

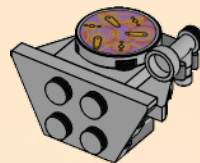

6

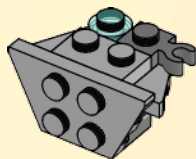

8

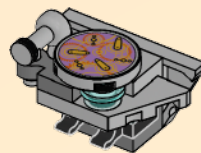
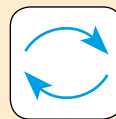

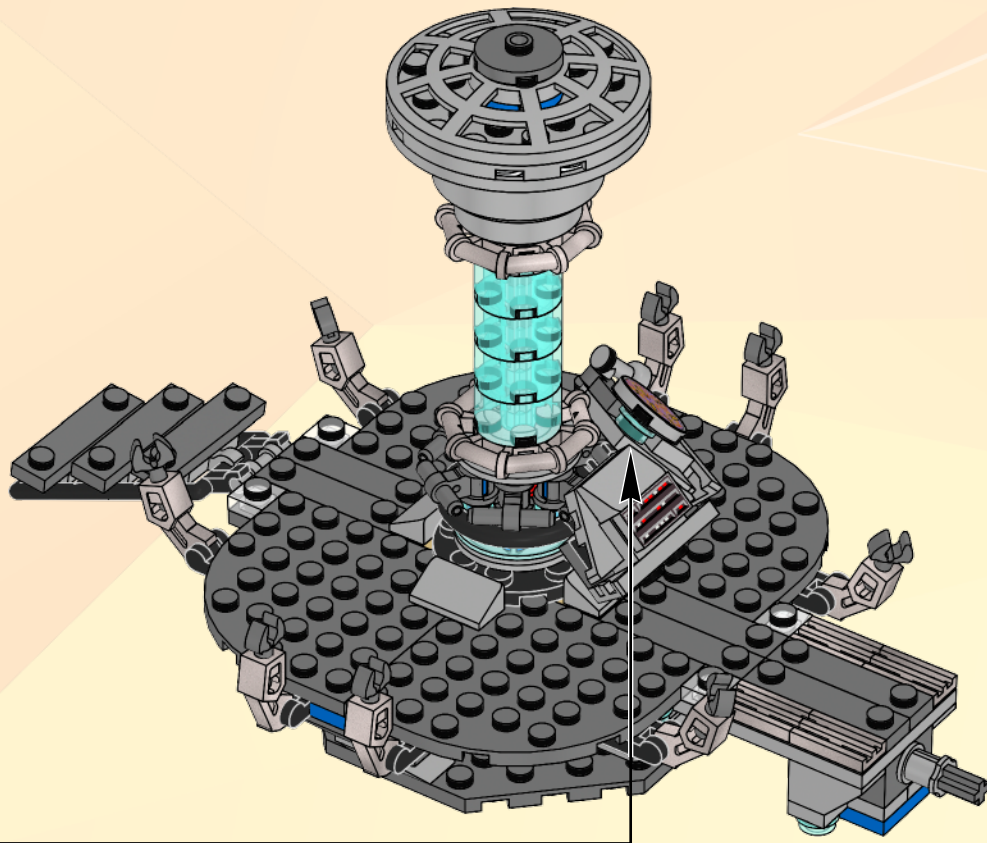



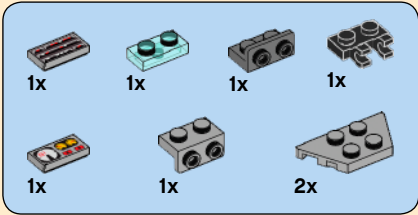

24

1

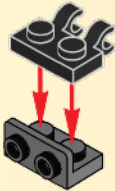

2



3

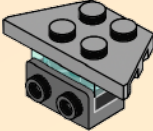

4

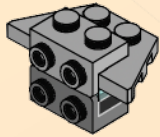

5

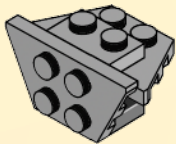

6

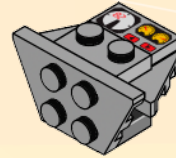

7

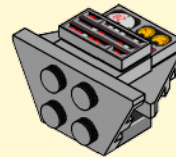

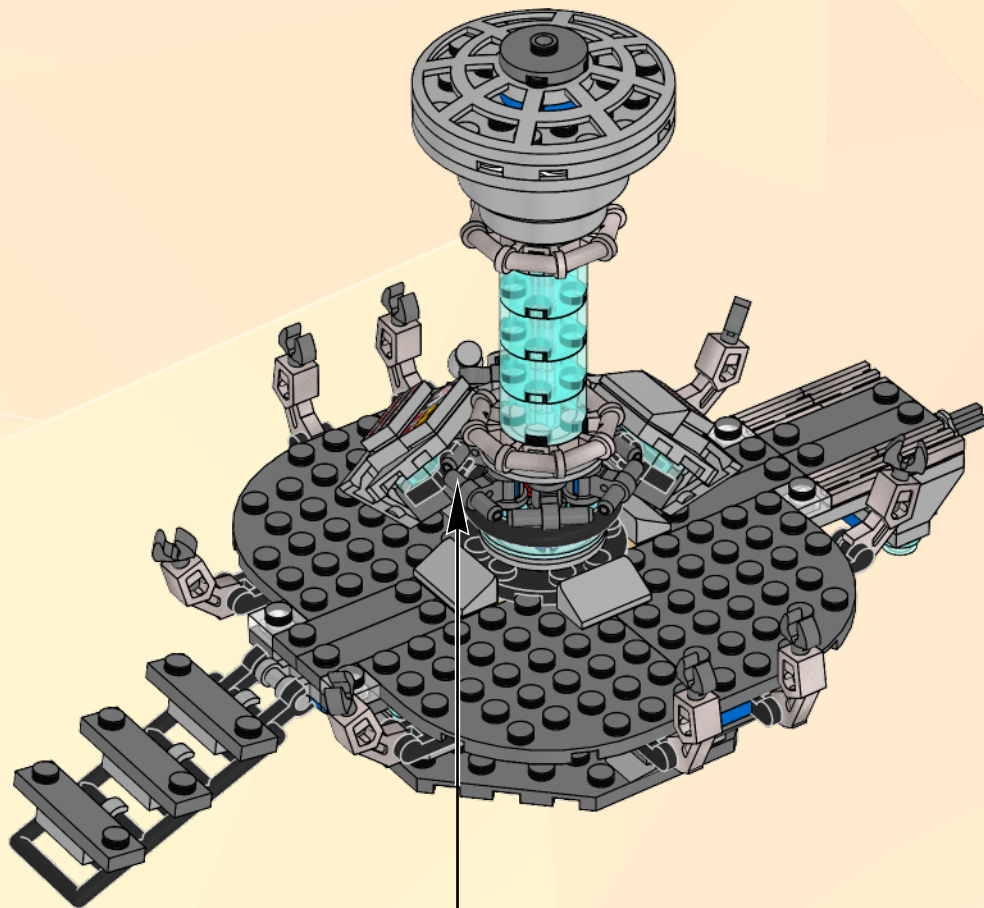

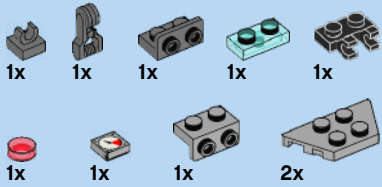

25

1

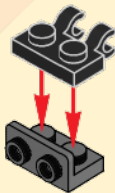

2

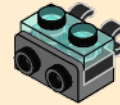

3

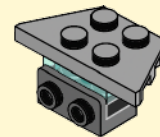

4

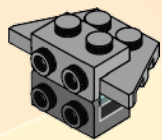

5

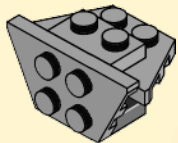

6

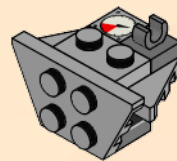

7

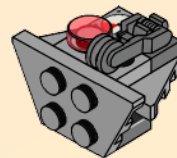

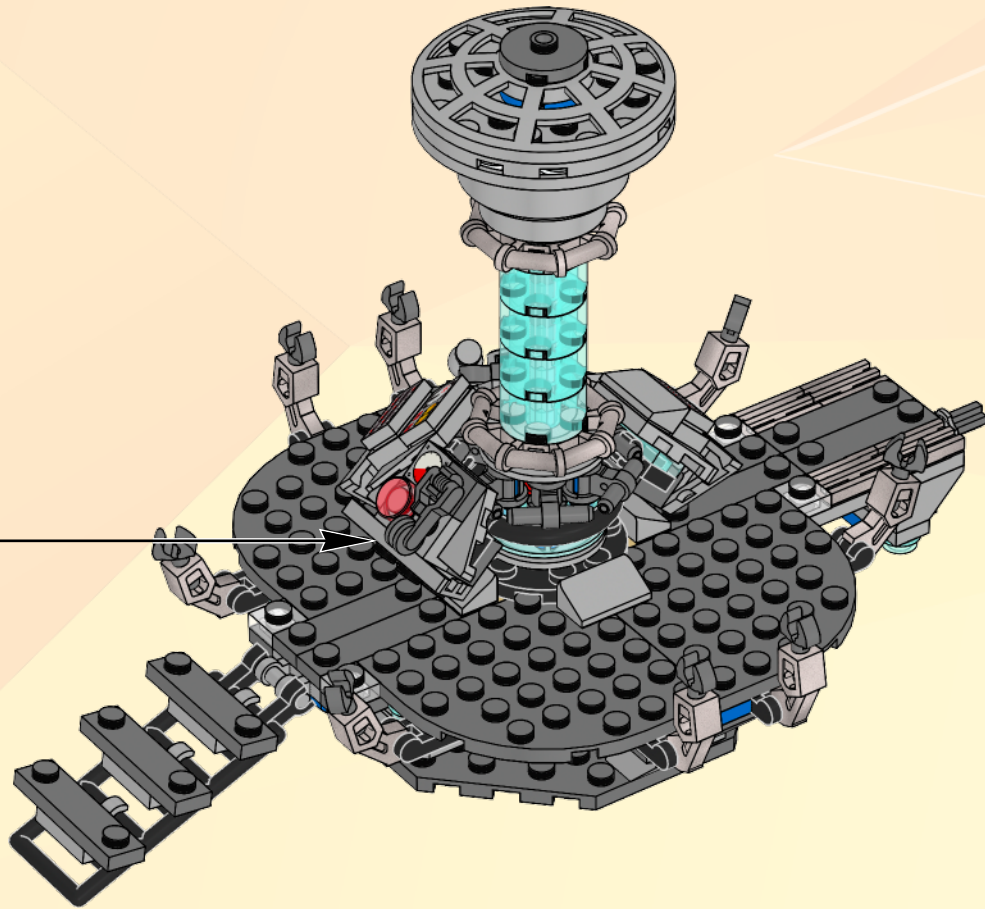



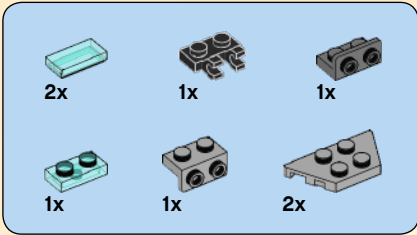

26

1

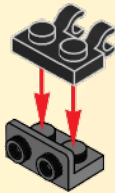

2



3

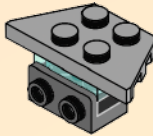

4

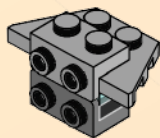

6

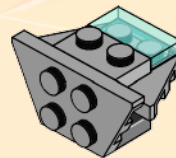

5

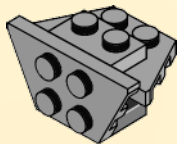

7

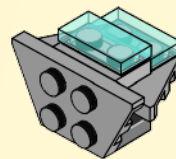

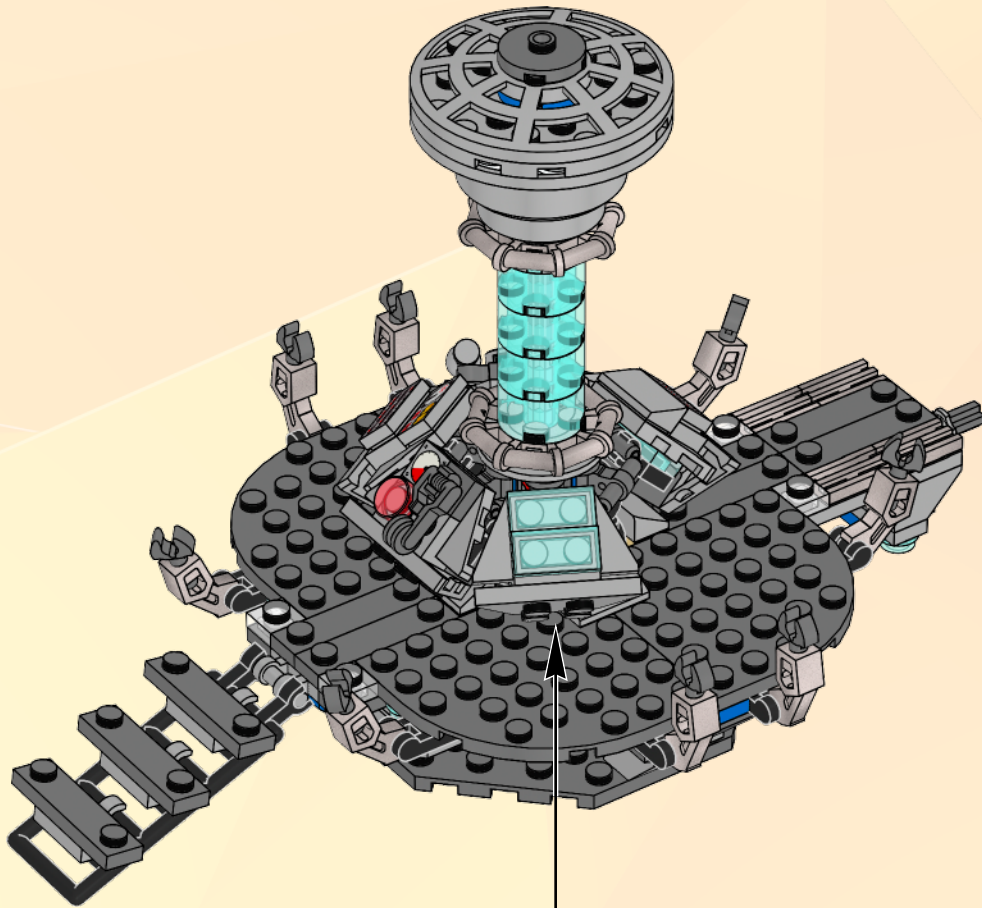



1x



1x



1x



1x

1x



1x



1x

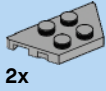

2x

# 27

## 1

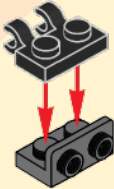

## 2



## 3

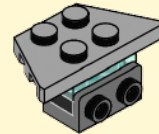

4

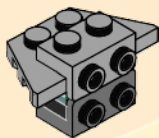

5

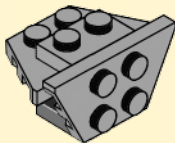

6

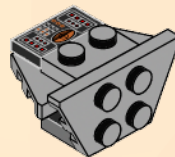

7

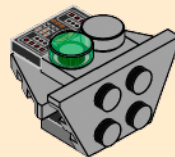

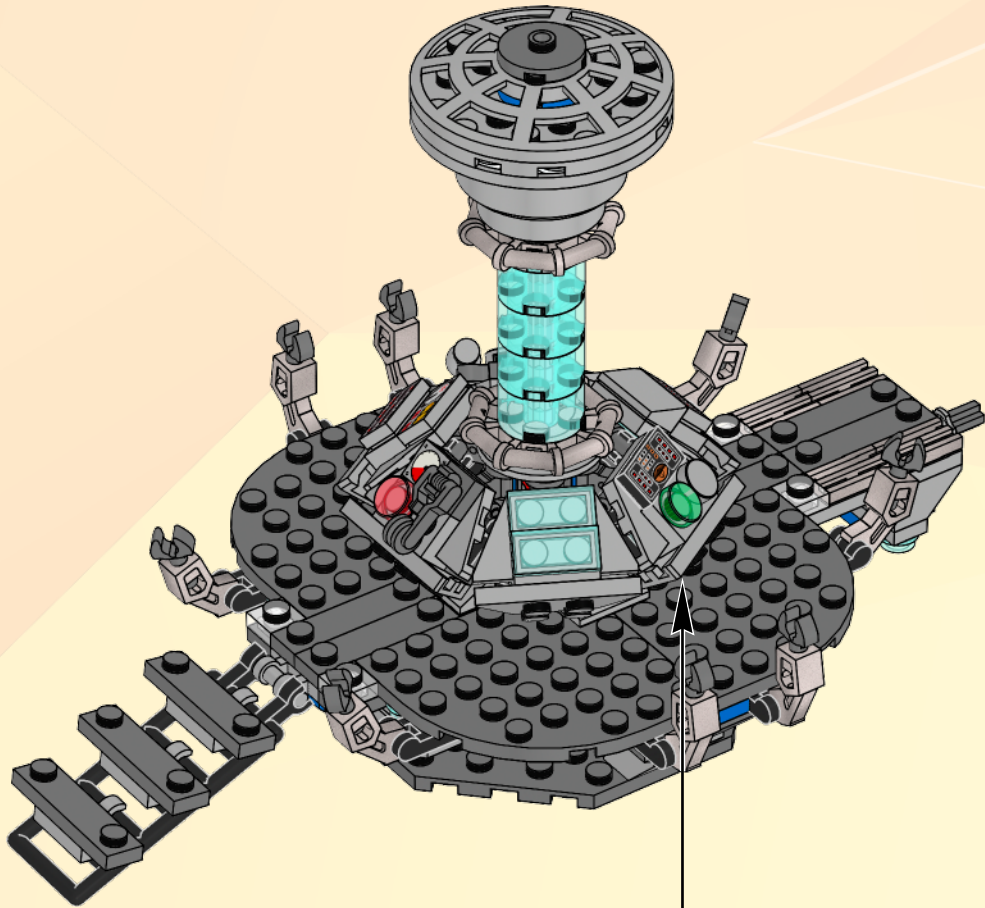



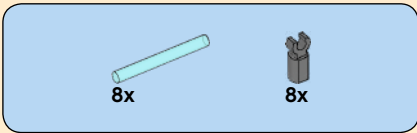

28

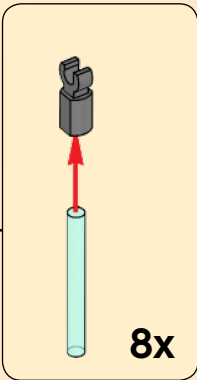
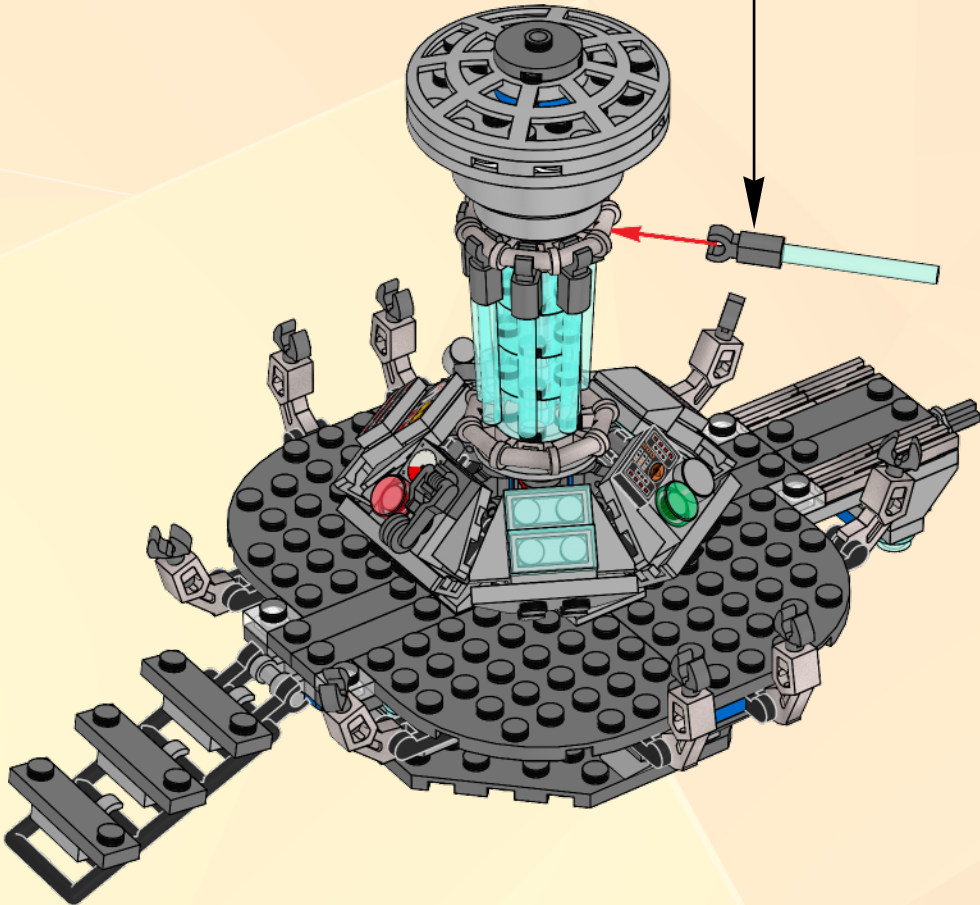

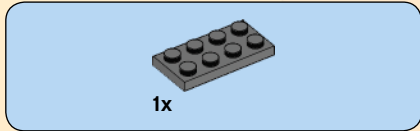
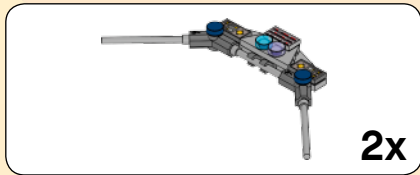

1

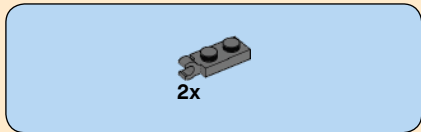
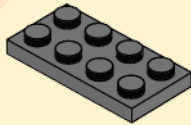

2

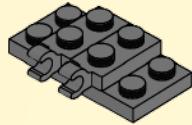

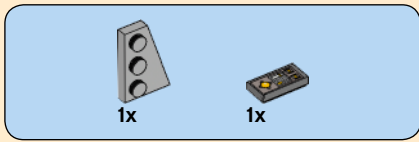

3

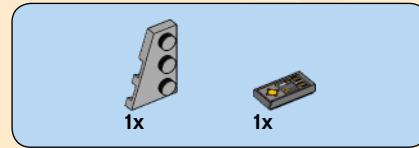
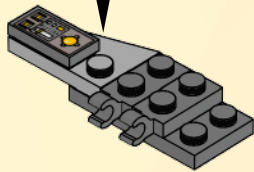
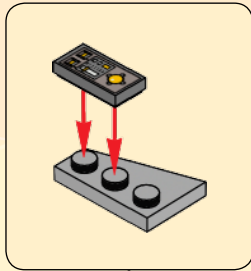

4

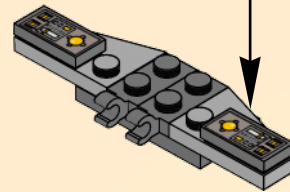
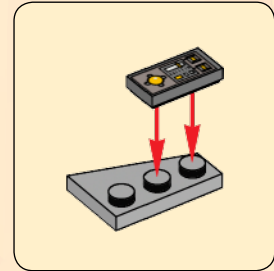



1x

5

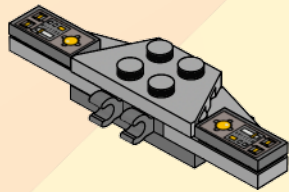

1x



1x



1x

6

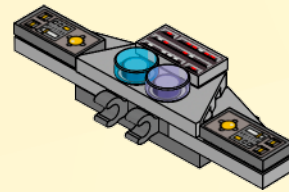

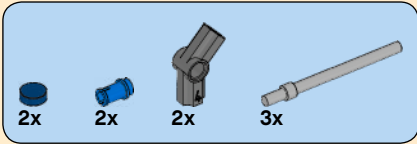
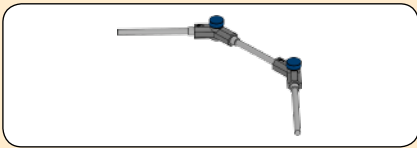

7

1

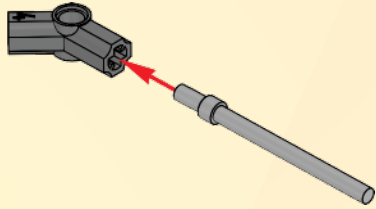

2

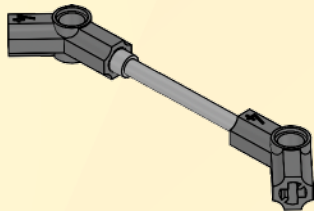

3

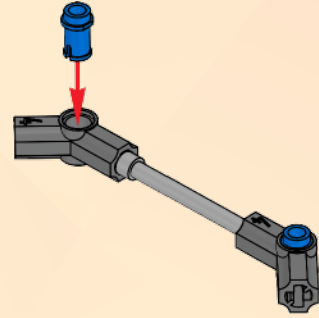

4

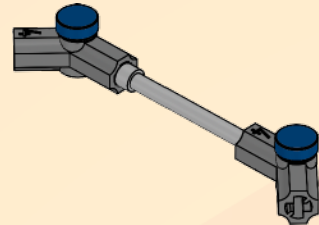

5

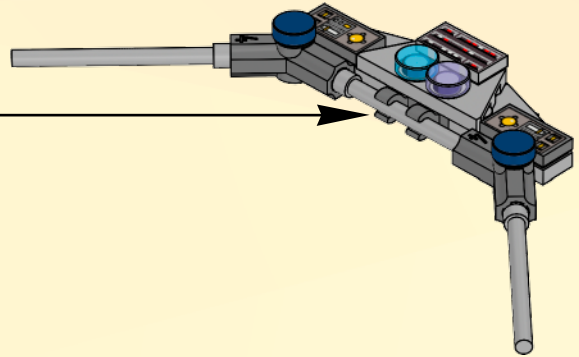
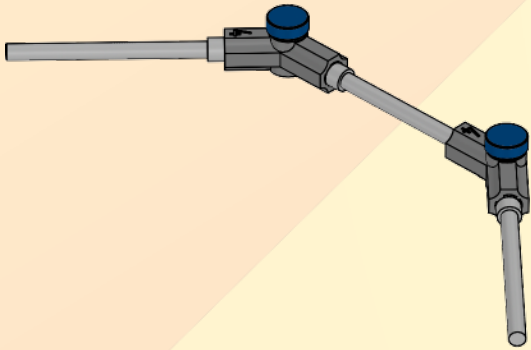

2x



29

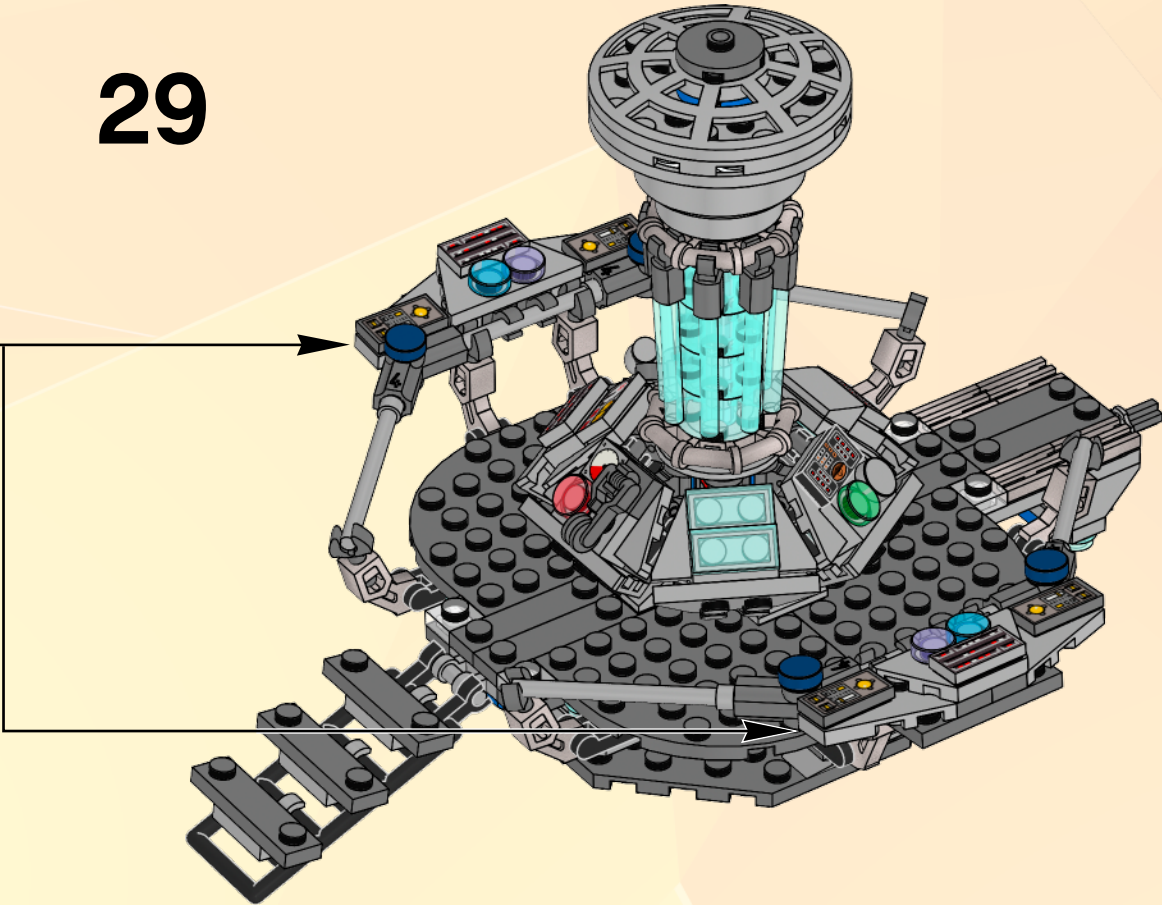



2x



2x

# 30

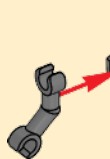

2x

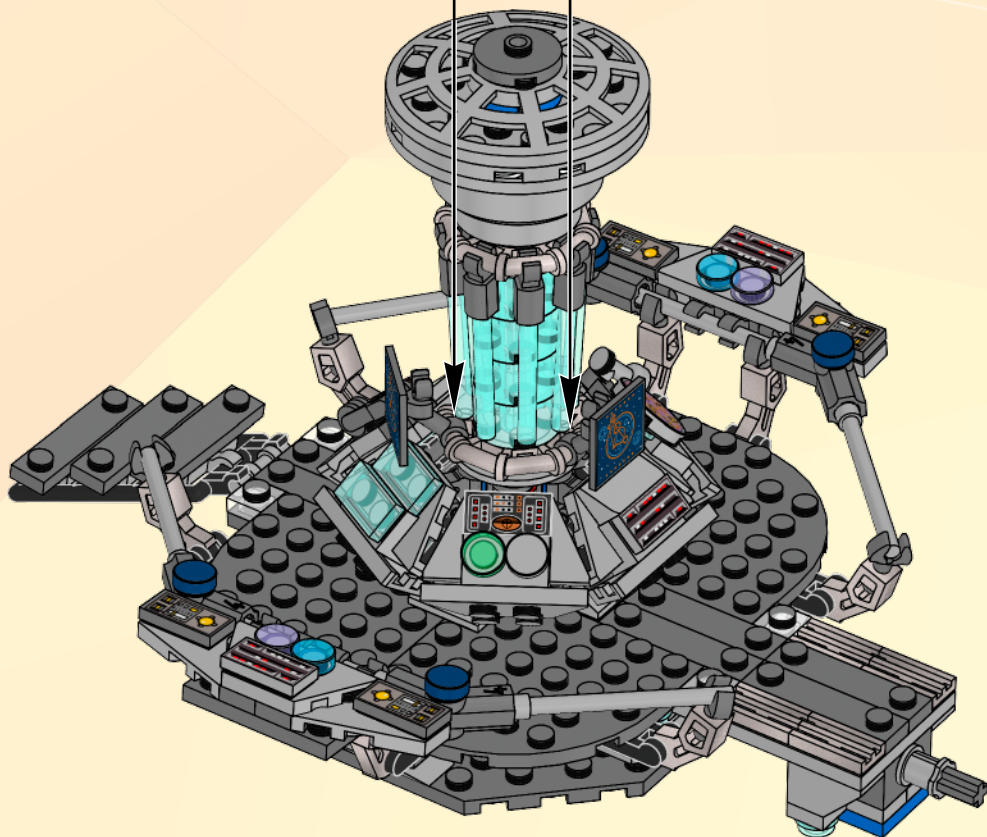

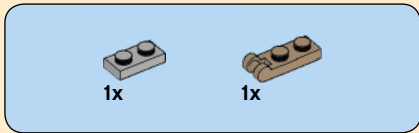

1

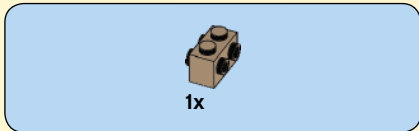
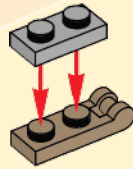

2

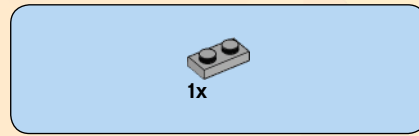
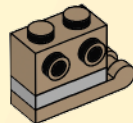

3

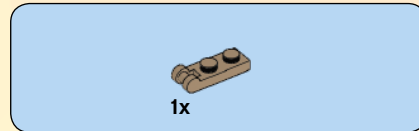
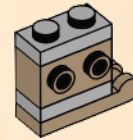

4

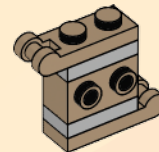



1x

5

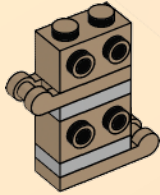

1x

6

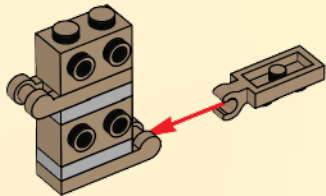

1x



1x

7

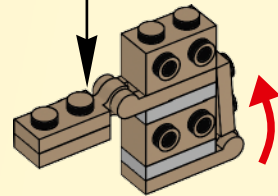
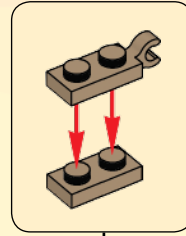

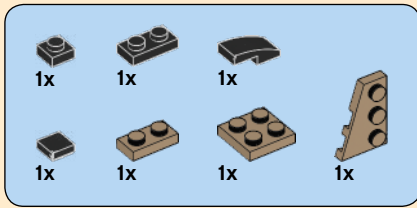

8

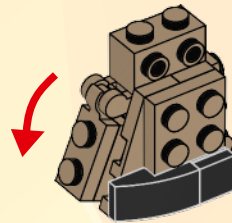
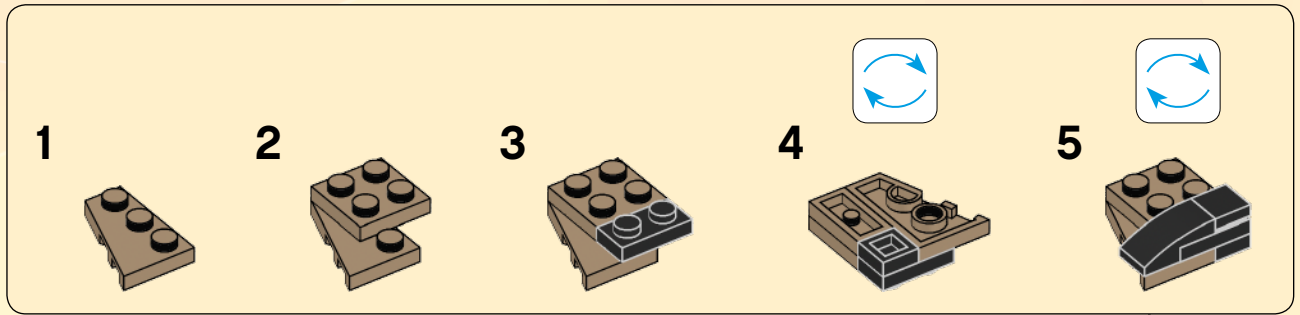



1x



1x

# 9

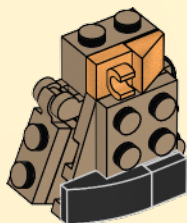

1x



1x

# 10

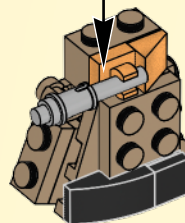
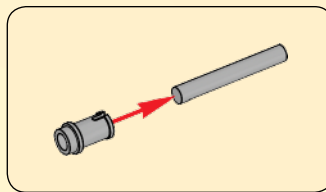

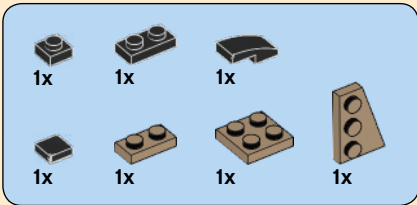

# 11

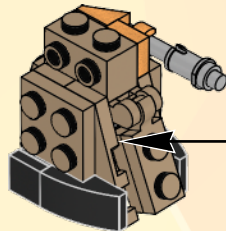
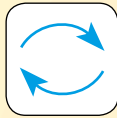
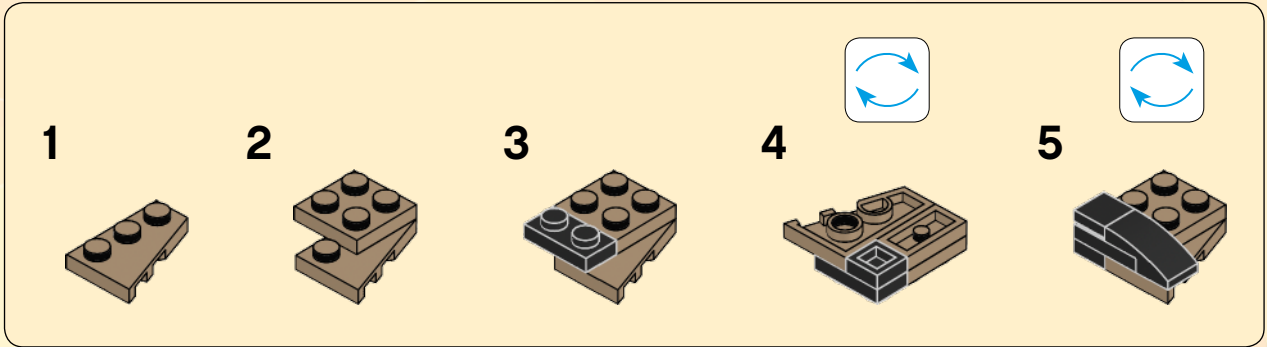





1x



1x



1x

# 12

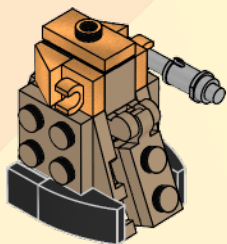

1x



1x

# 13

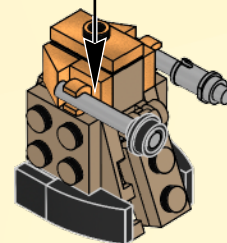
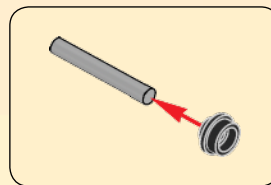



1x

14

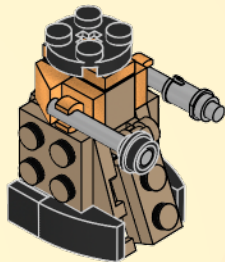

1x

15

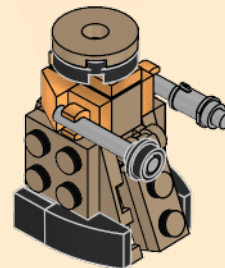



1x



1x



1x

# 16

1

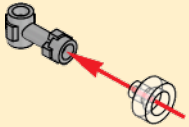

2

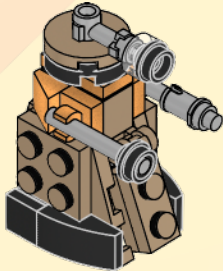
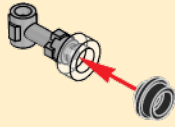

1x

# 17

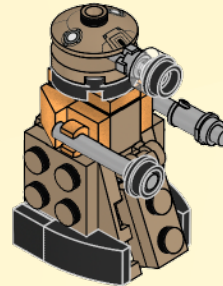

# 2x

31

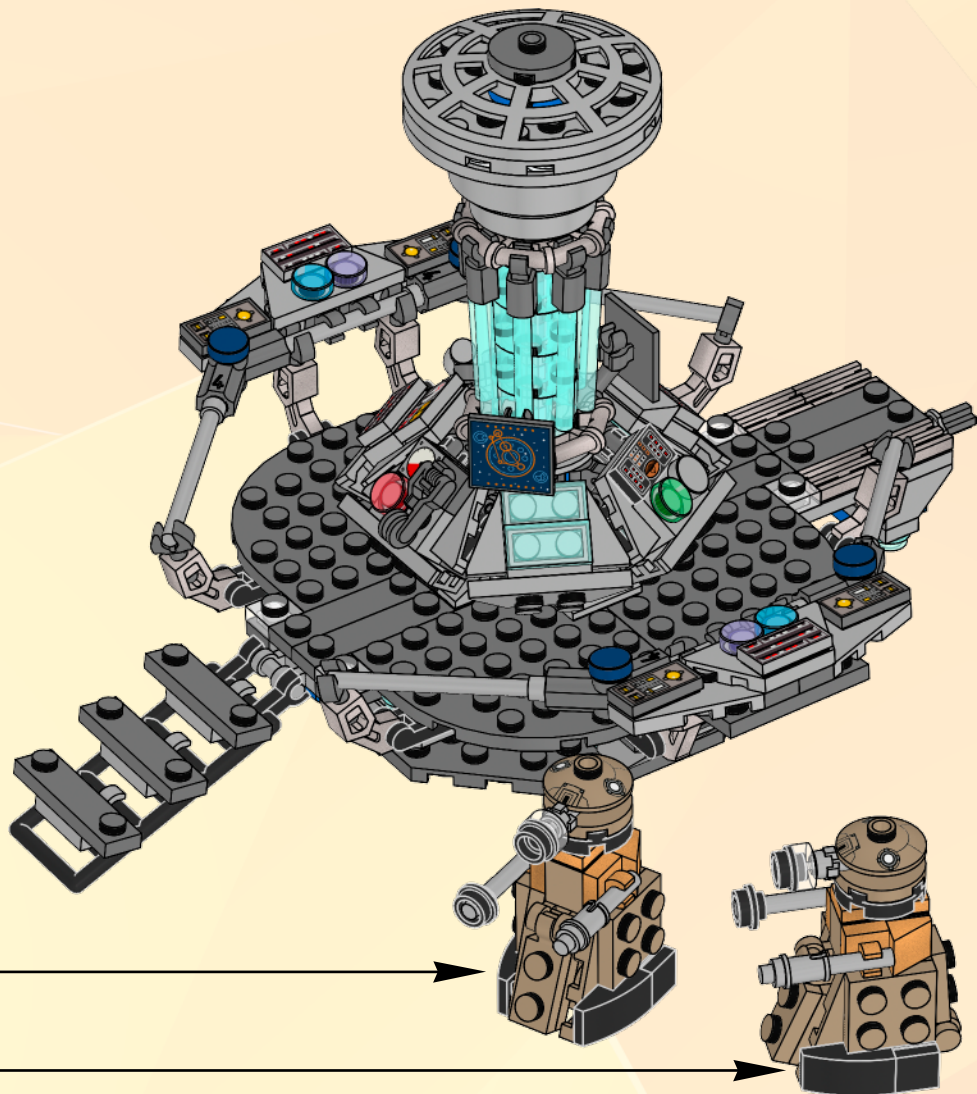

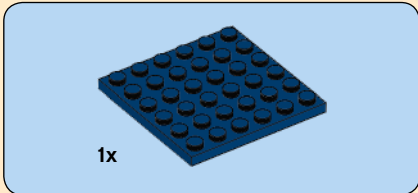

1x

1

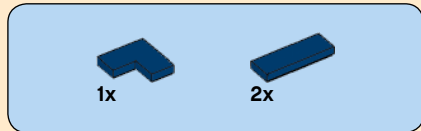
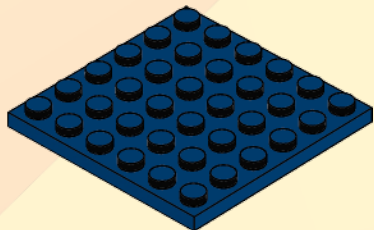

2

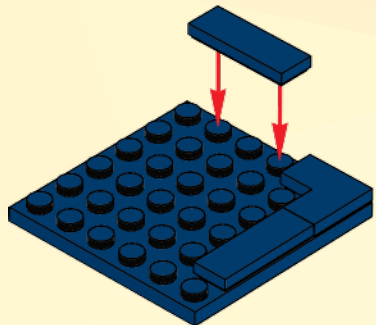

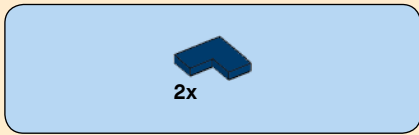

3

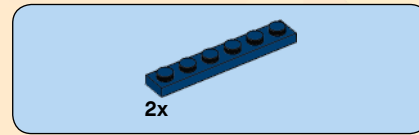
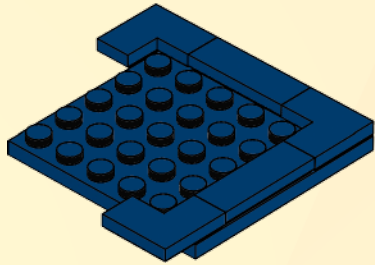

4

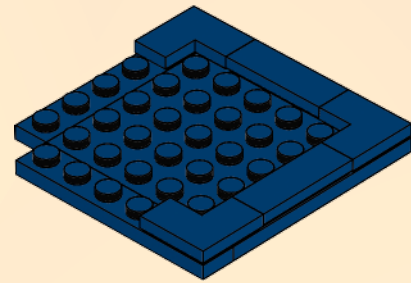

*TARDIS stands for Time and Relative Dimension in Space and is a Type 40 model.*



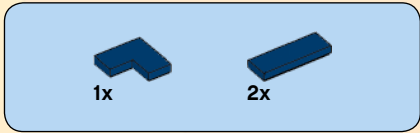

5

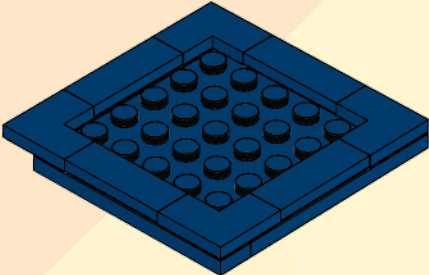

6

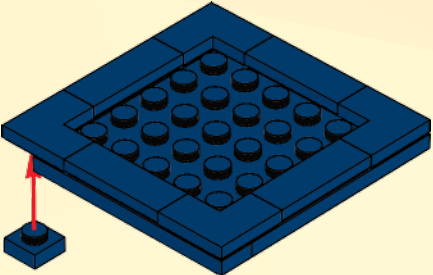



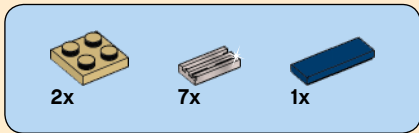

7

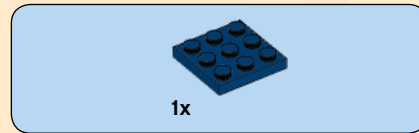
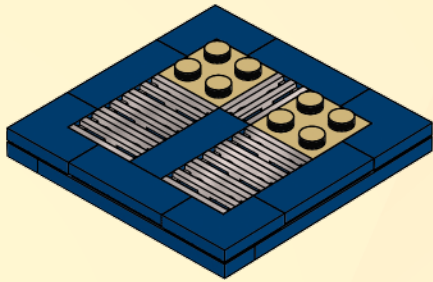

8

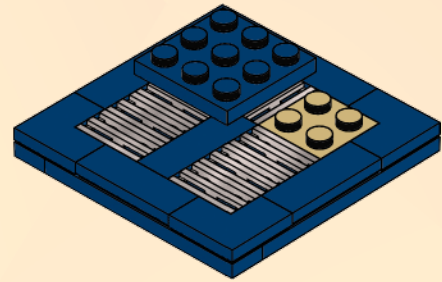

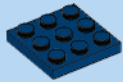

1x

# 9

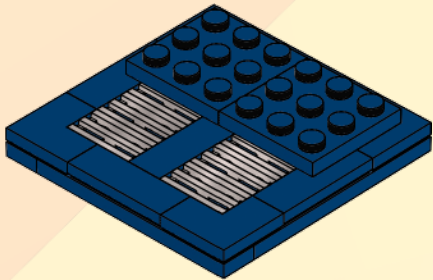

1x



1x

# 10

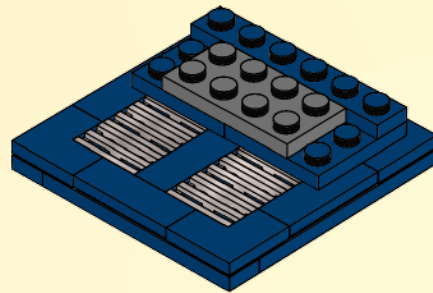

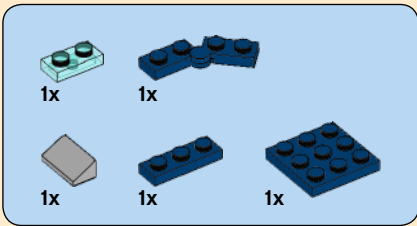

# 11

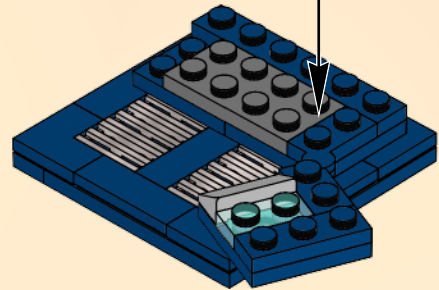
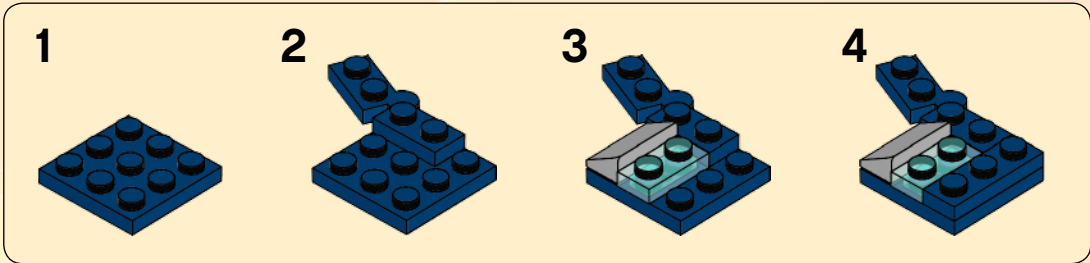

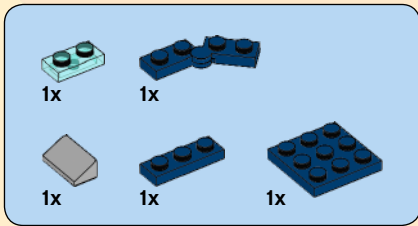

# 12

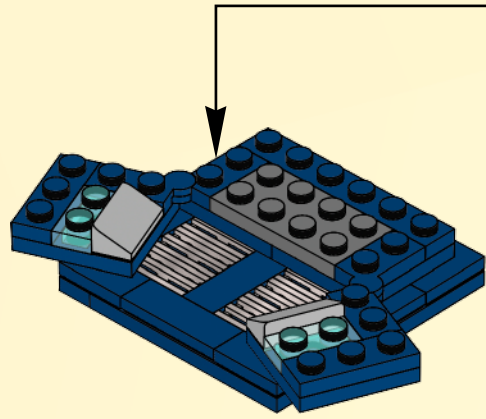
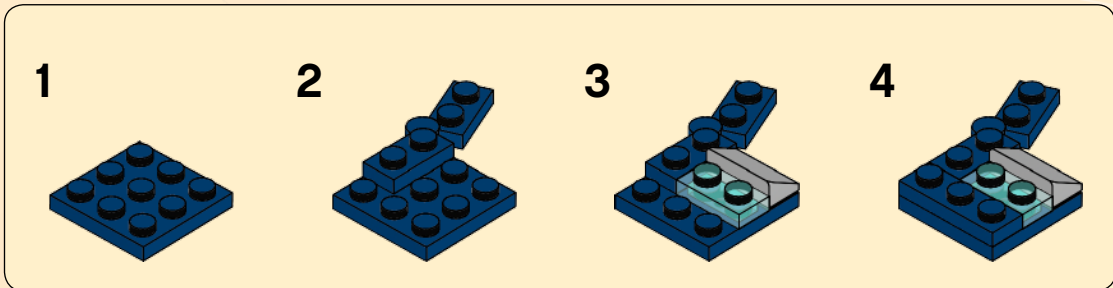

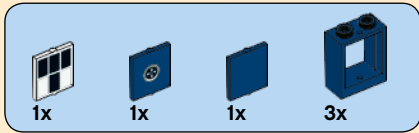

# 13

1

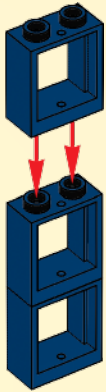

2

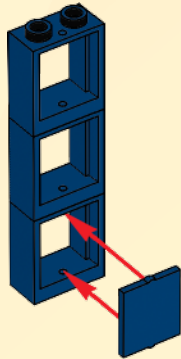

3

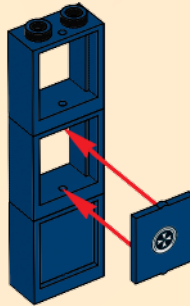

4

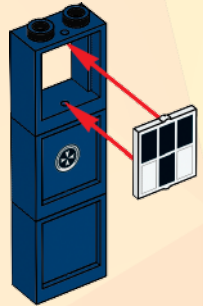

5

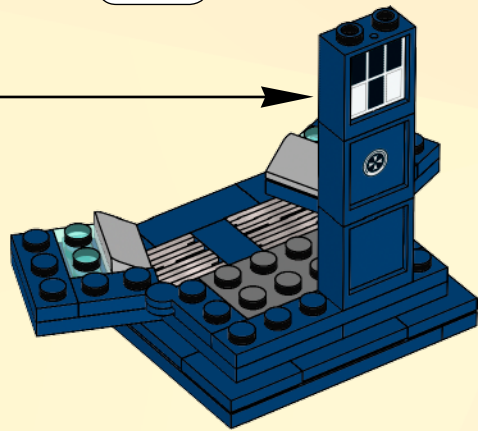
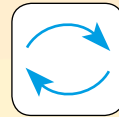

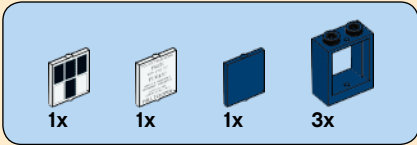

# 14

1

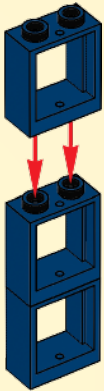

2

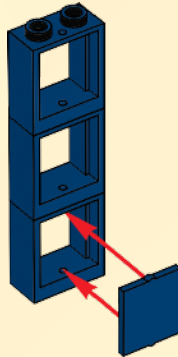

3

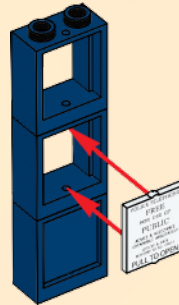

4

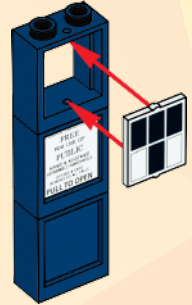



5

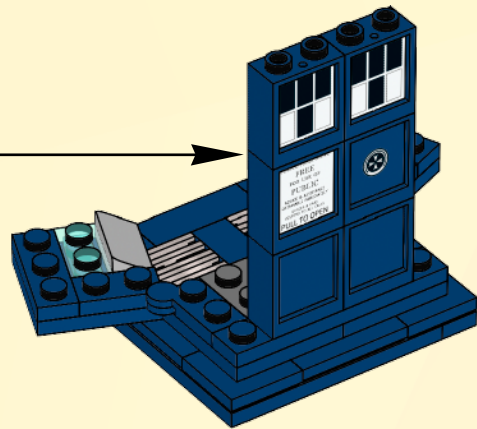



4x



2x

# 15

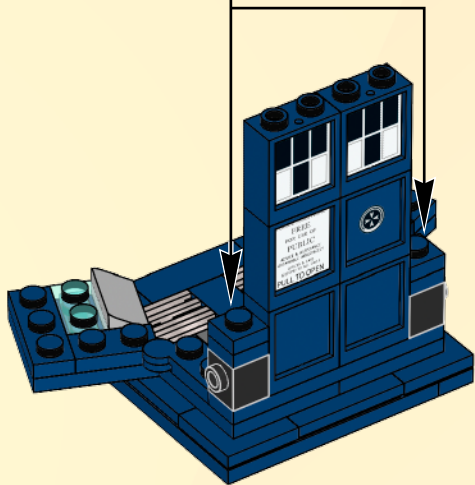
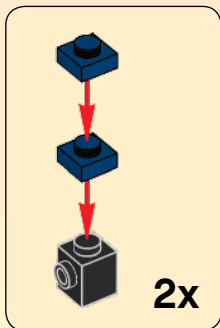

4x



2x

# 16

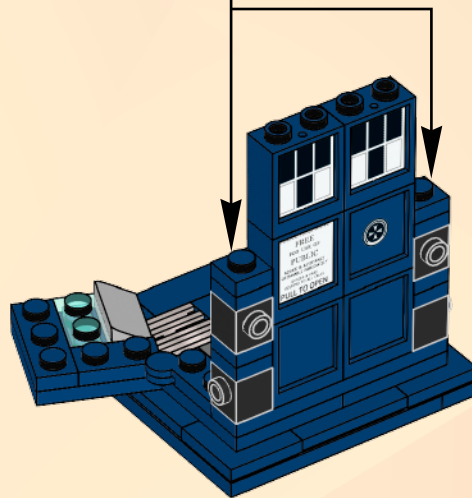
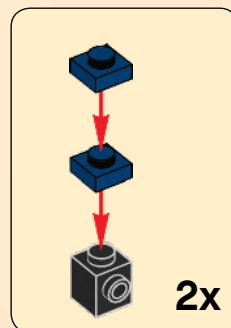



4x



2x

# 17

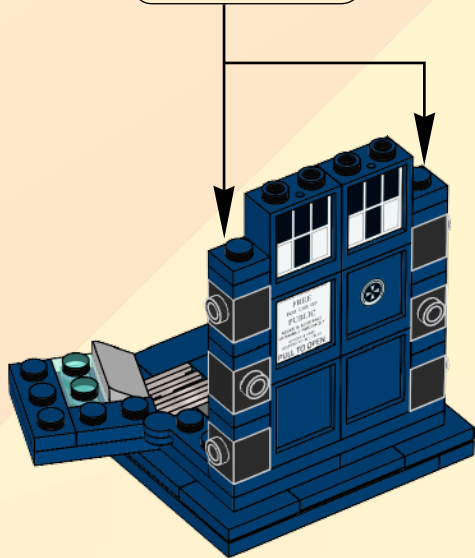
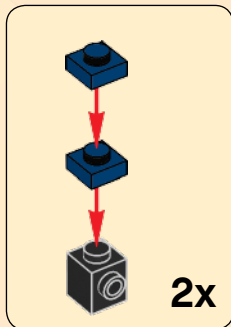

2x

# 18

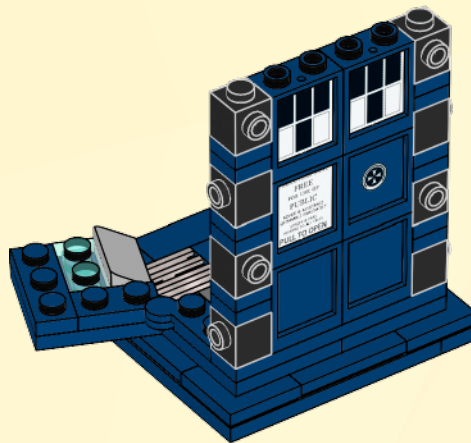

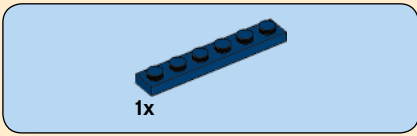

19

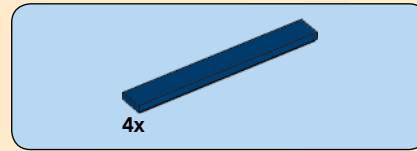
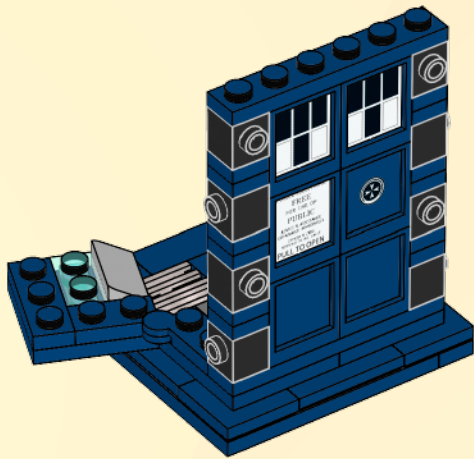

20

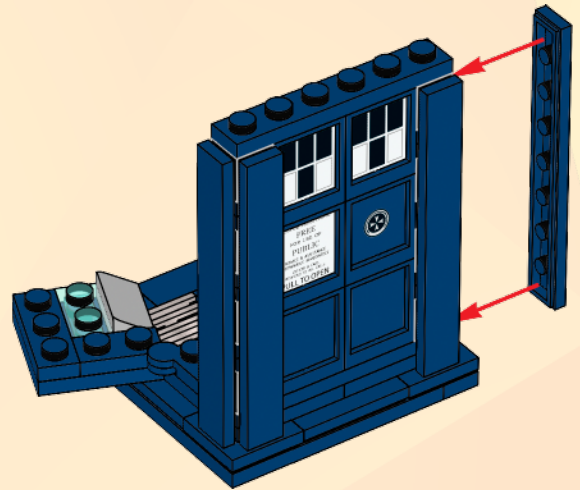

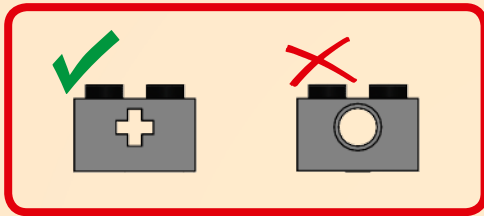
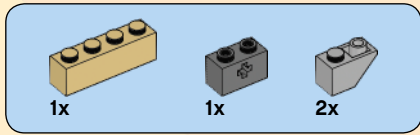

21

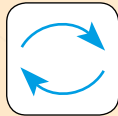



2x

# 22

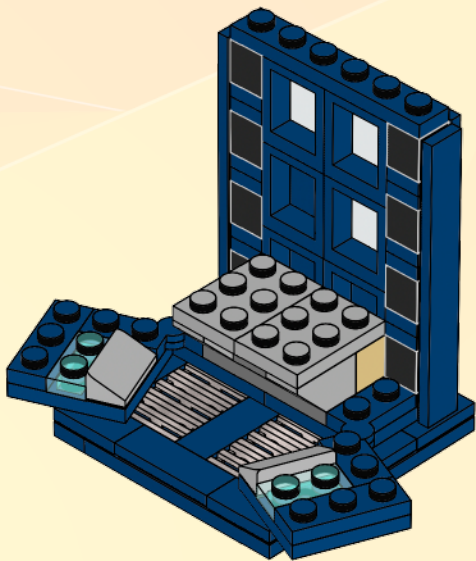

2x



2x

# 23

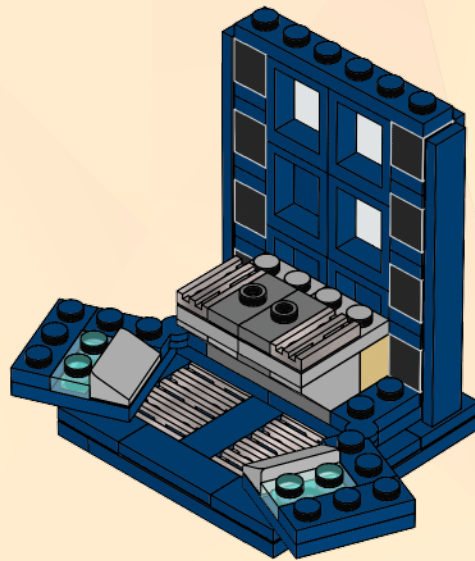



2x



2x



4x



6x

# 24

1

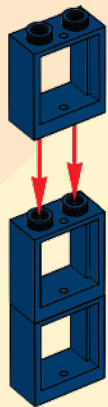

2

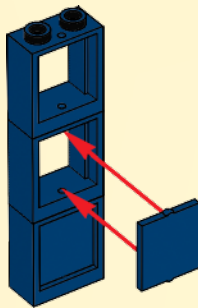

3

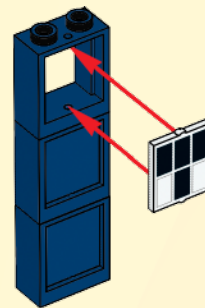



4



2x

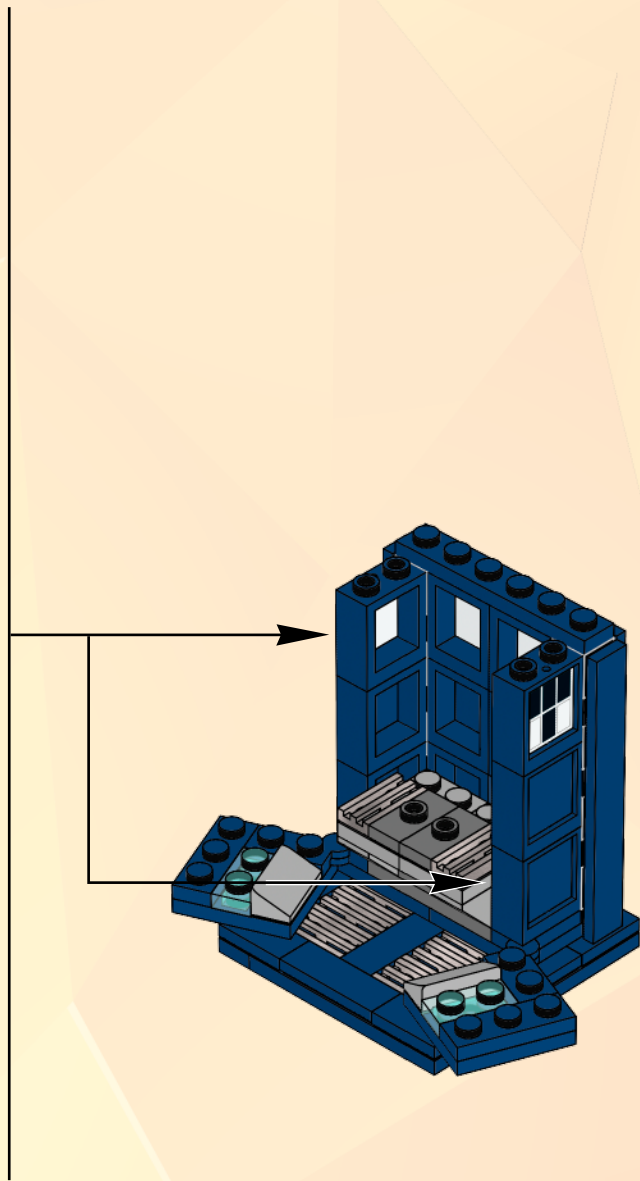



2x



2x



4x



6x

# 25

1

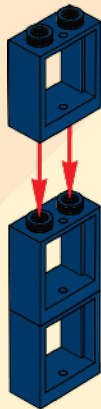

2

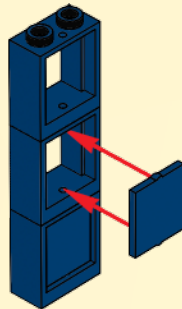

3

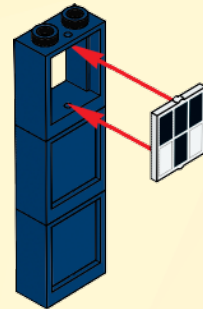

4



2x

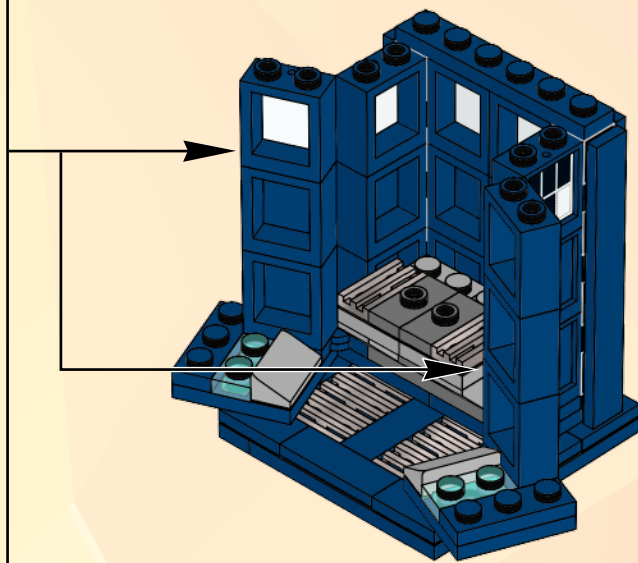



2x

# 26

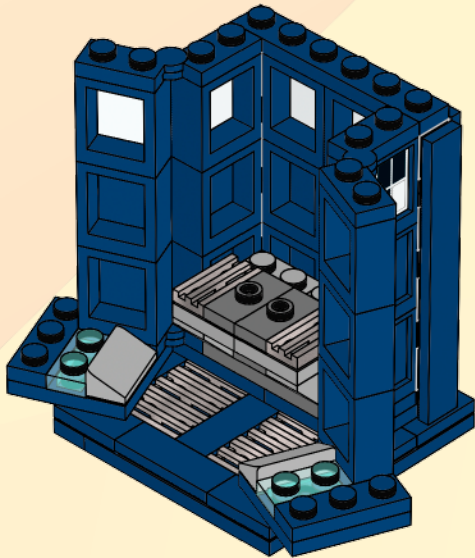

2x



2x



2x

# 27

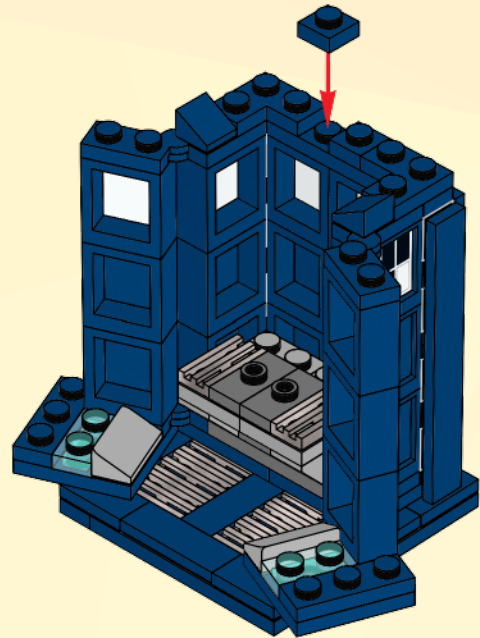



28

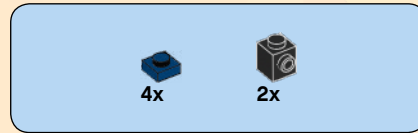
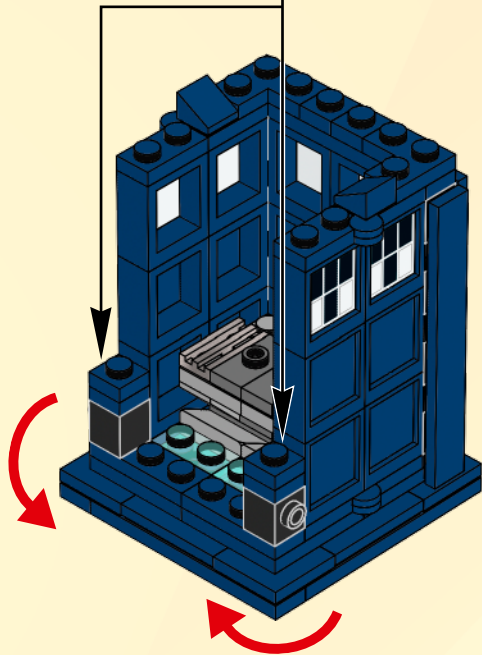
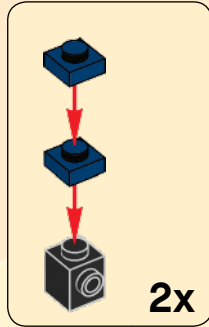

29

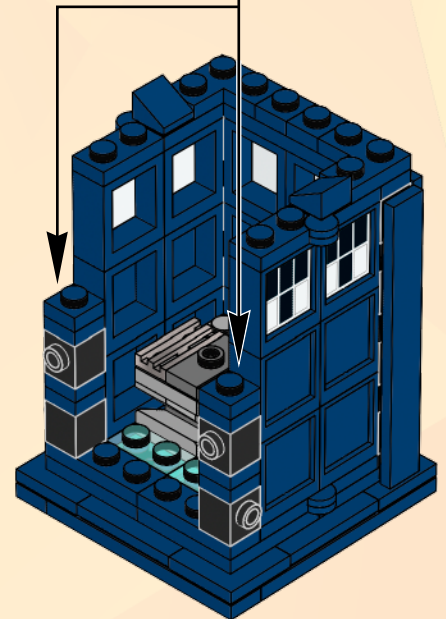
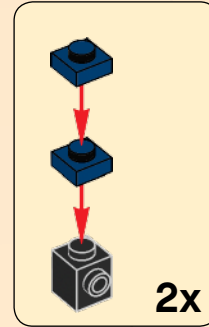



4x



2x

# 30

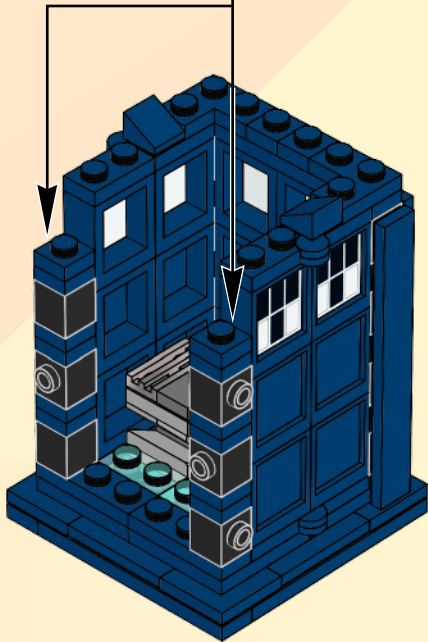
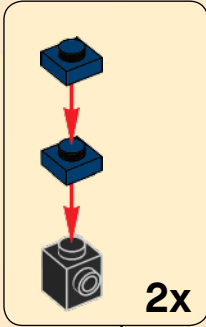

2x

# 31

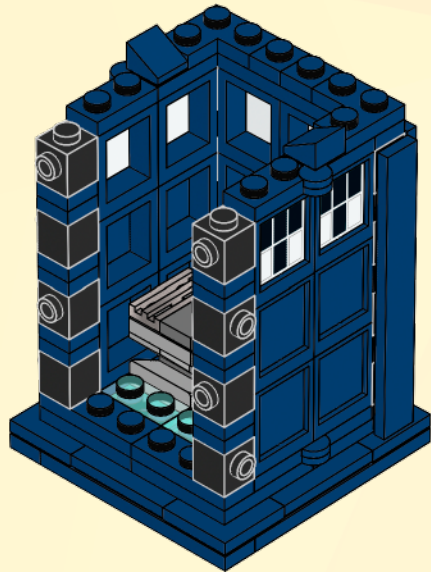

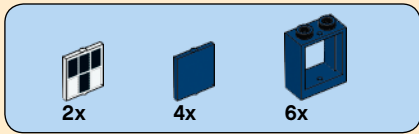
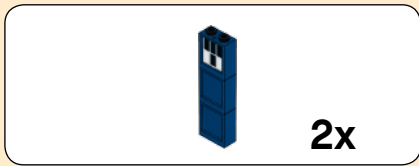

# 32

1

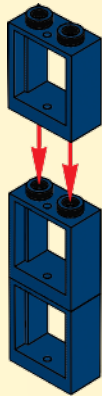

2

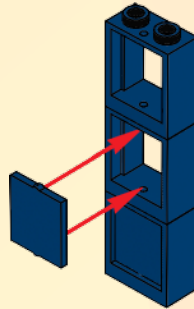

3

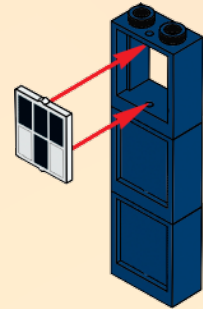



4



2x

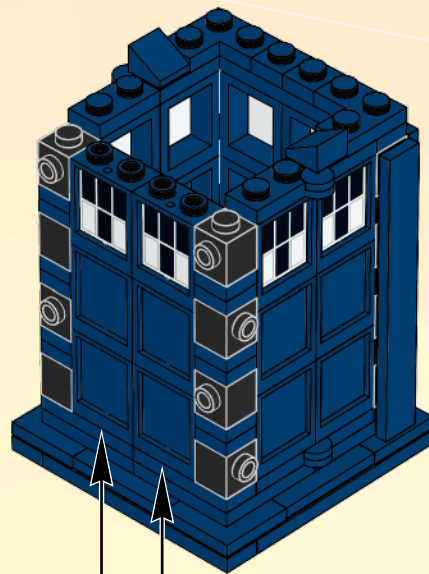

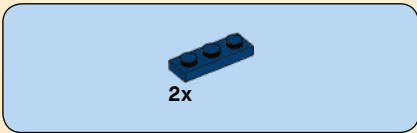

33

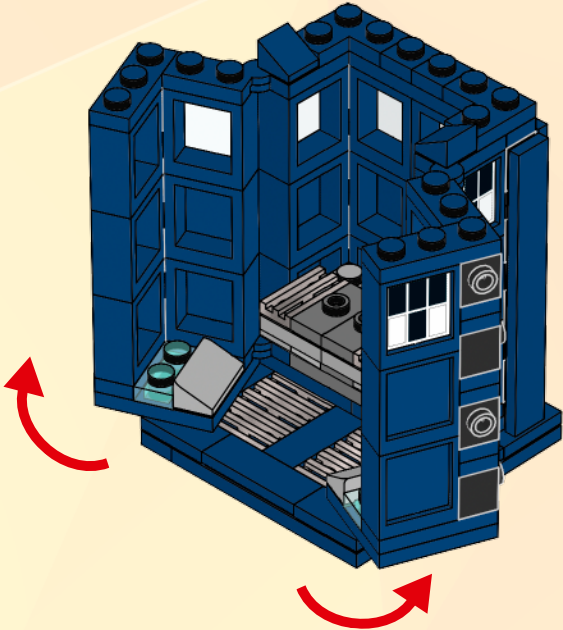

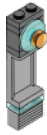

2x

2x

2x

6x

2x

2x

2x

2x

2x

# 34

## 1

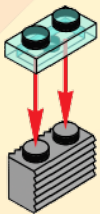

## 2

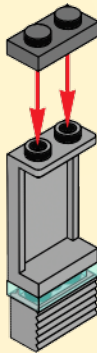

## 3

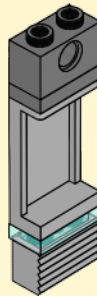

## 4

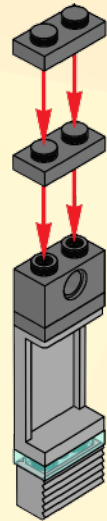

5

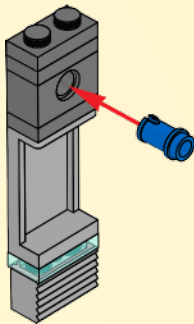

6

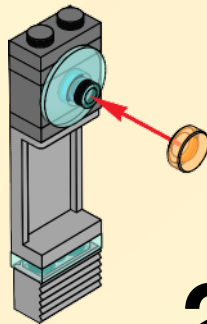

2x

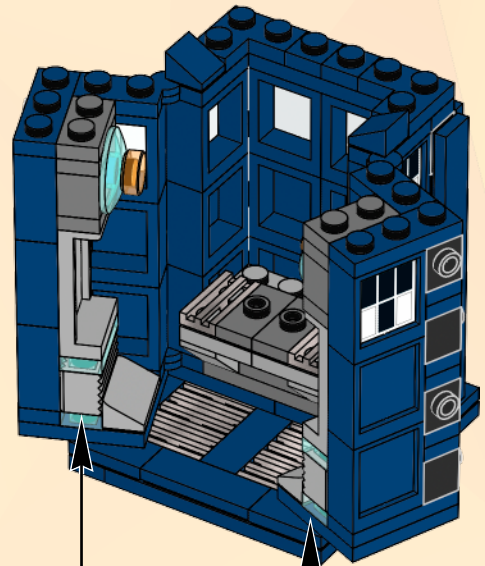



2x

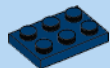

2x

# 35

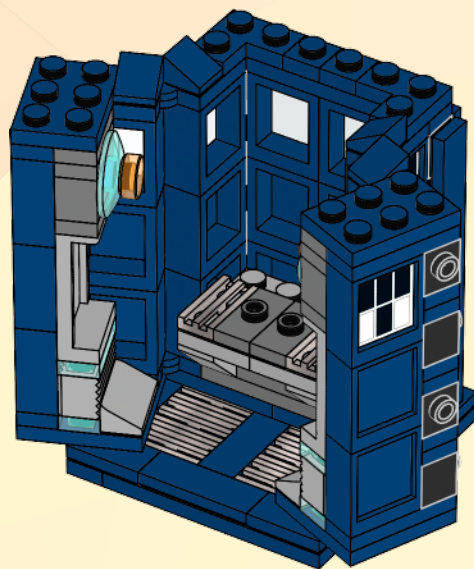

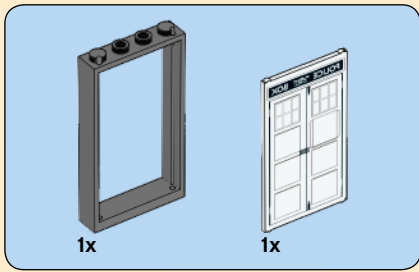

36

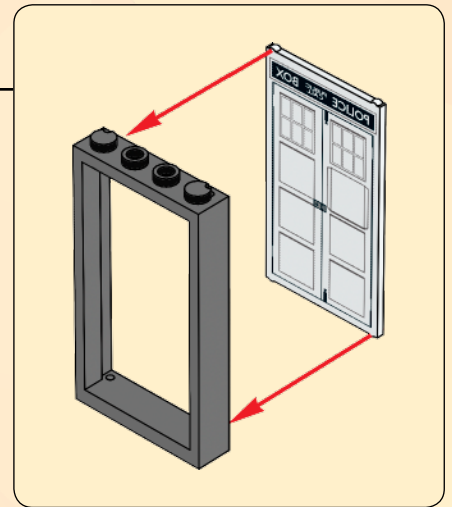
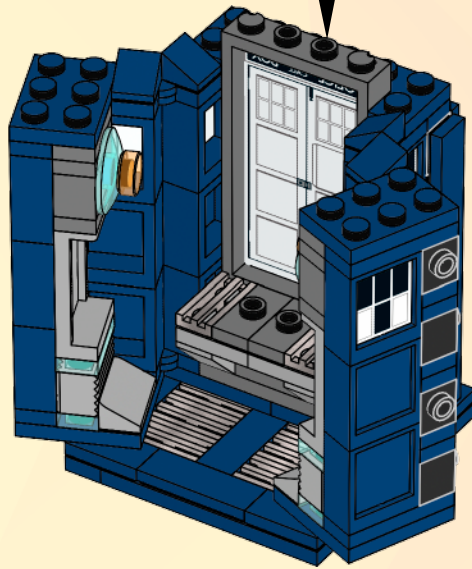

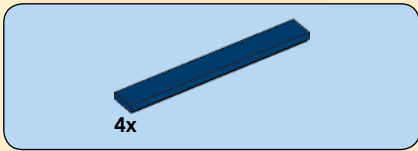

# 37

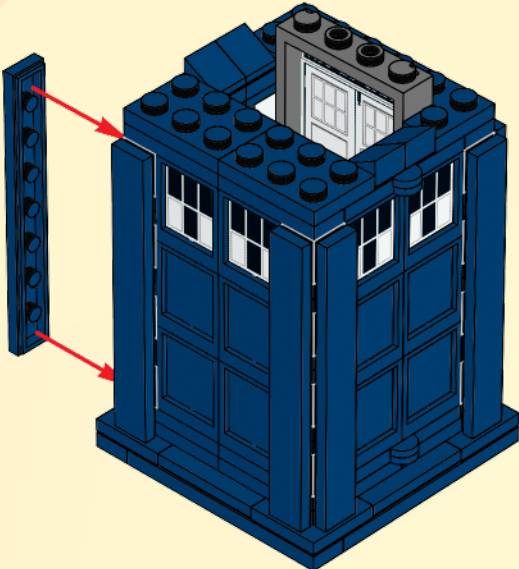



# 38

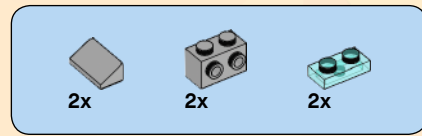
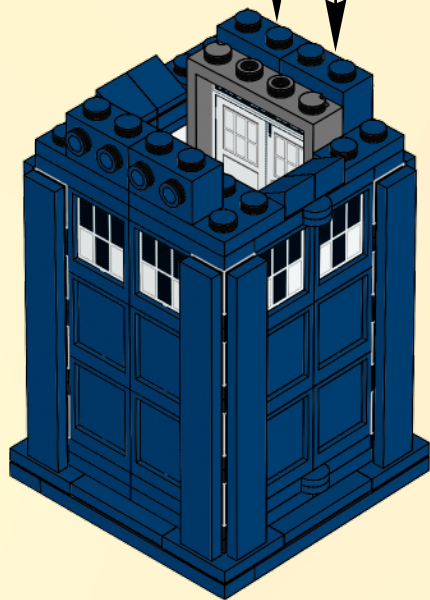
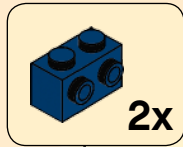

# 39

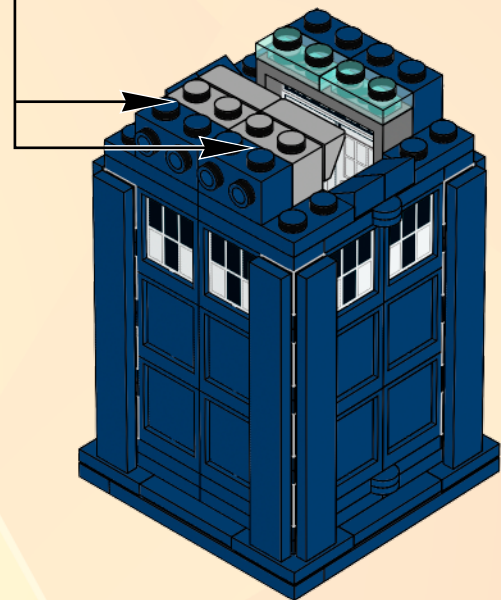
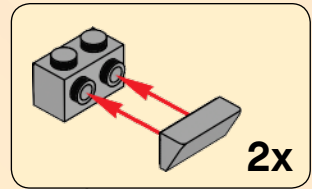





4x



4x

# 40

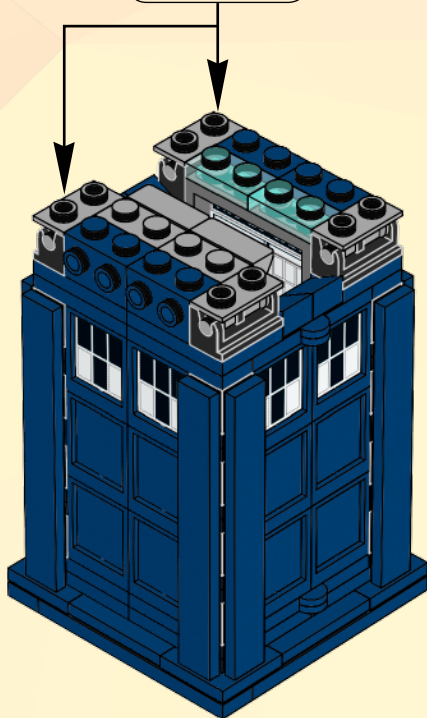
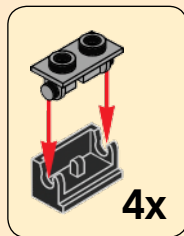



41

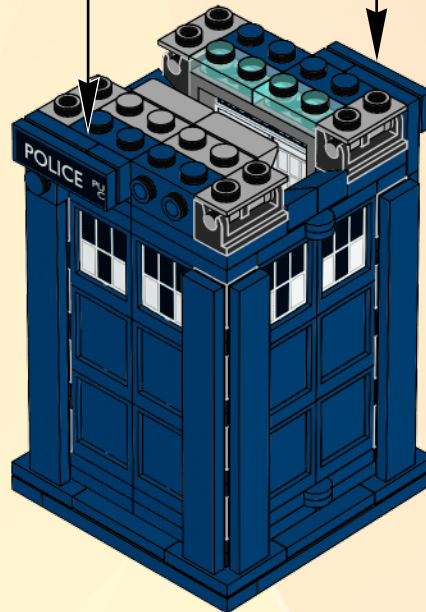
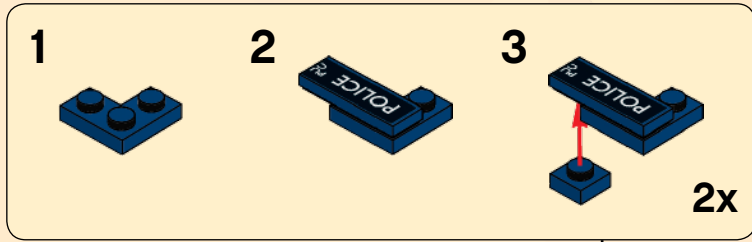



42

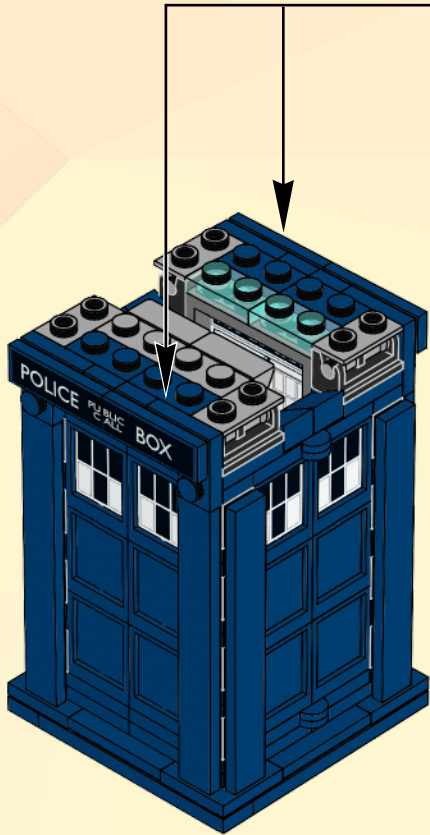
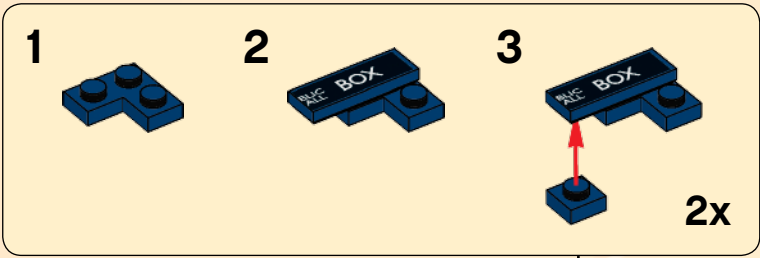

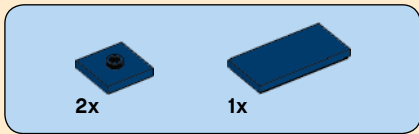

43

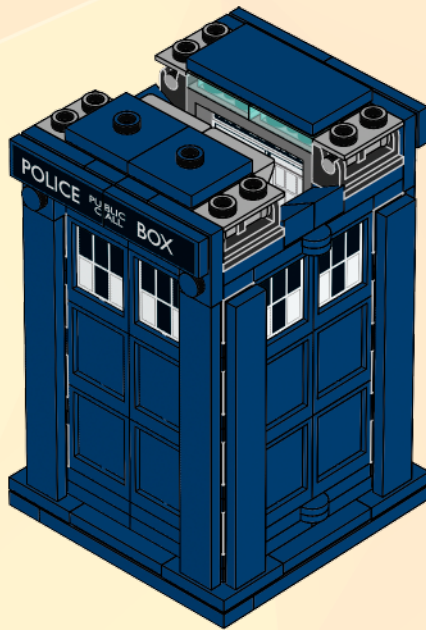



44

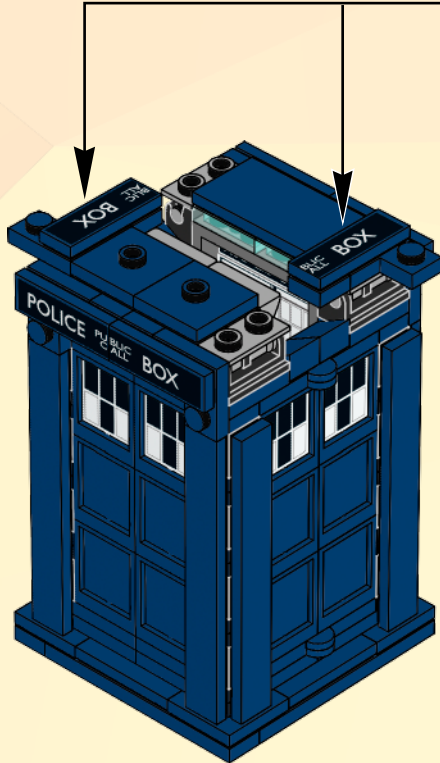
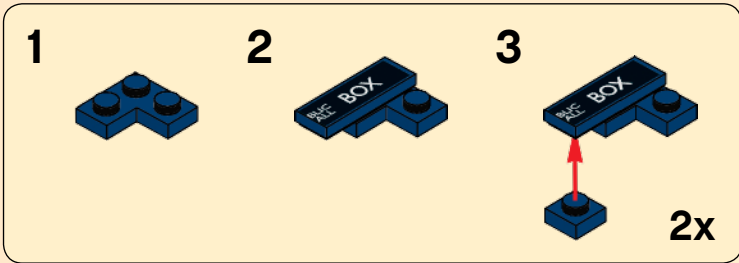



45

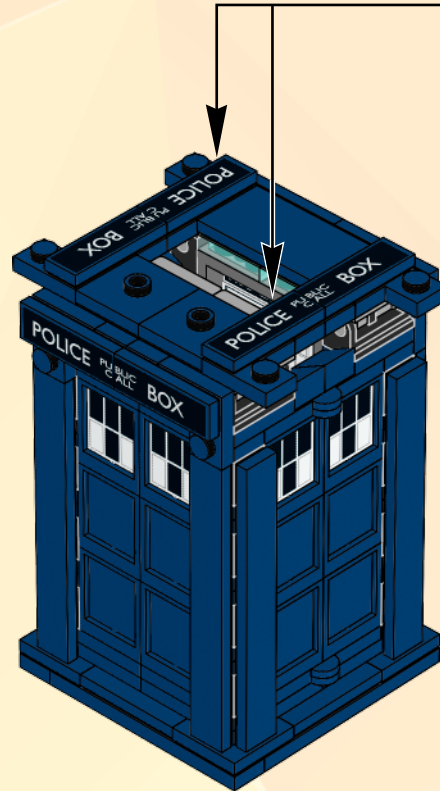
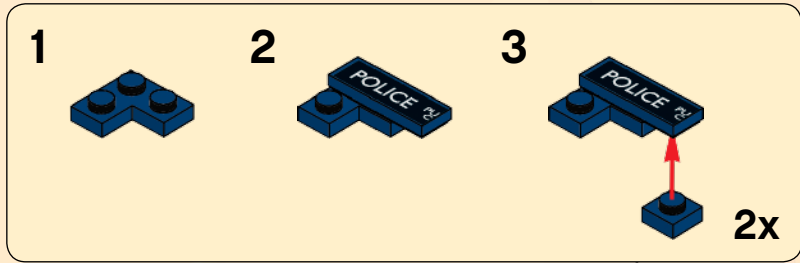

46

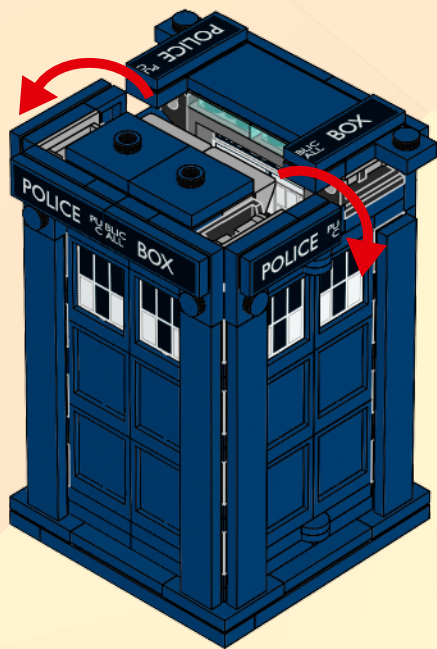

47

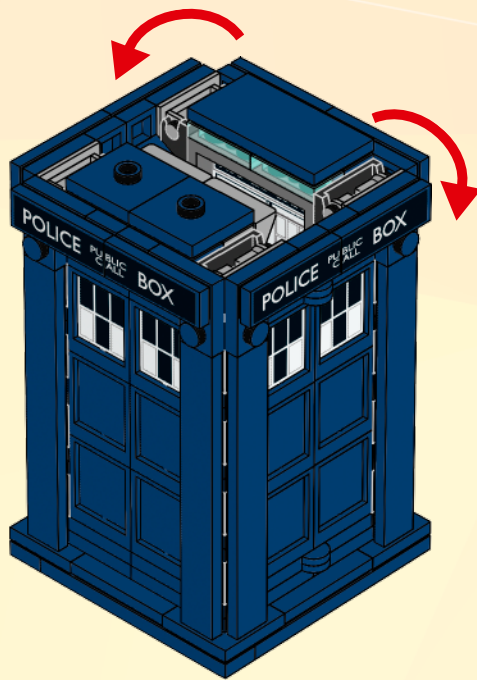

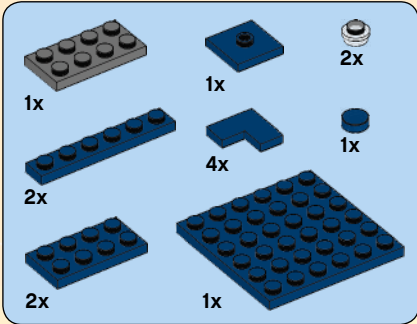
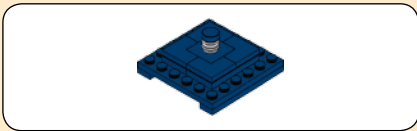

48

1

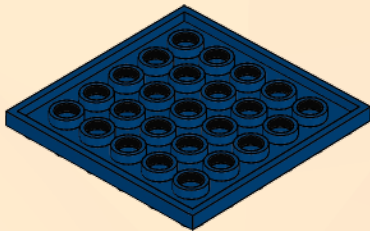

2

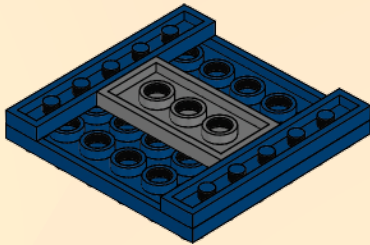



3

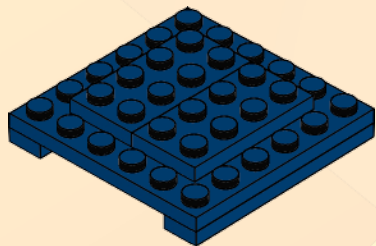
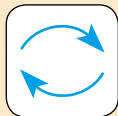

4

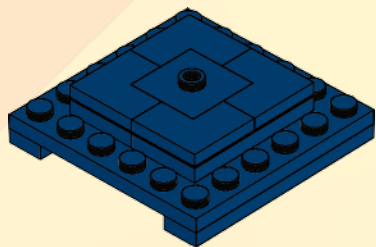

5

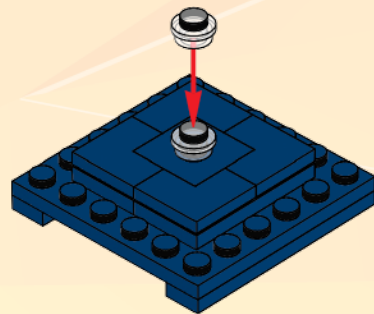

6

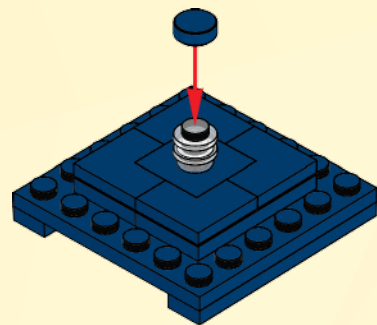

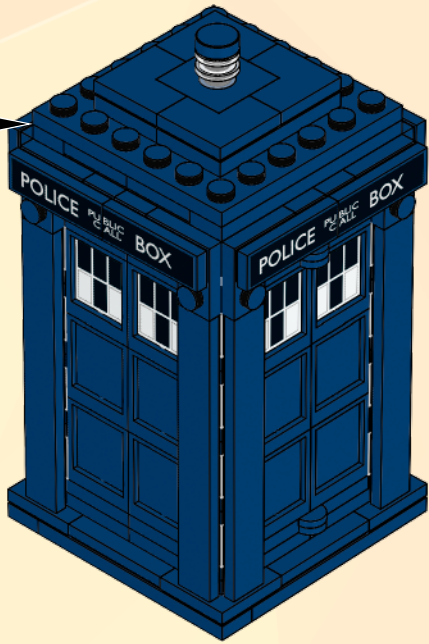

*The exterior of the TARDIS should change to match its environment, but its "Chameleon Circuit" developed a fault.*



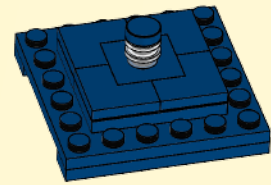
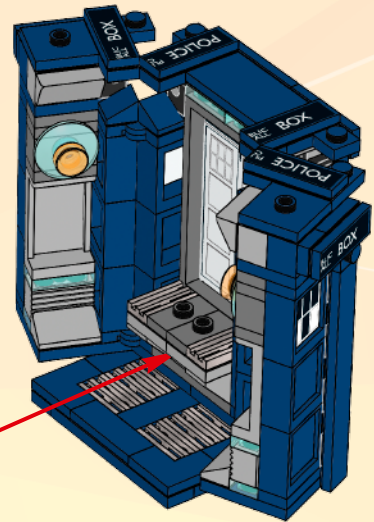
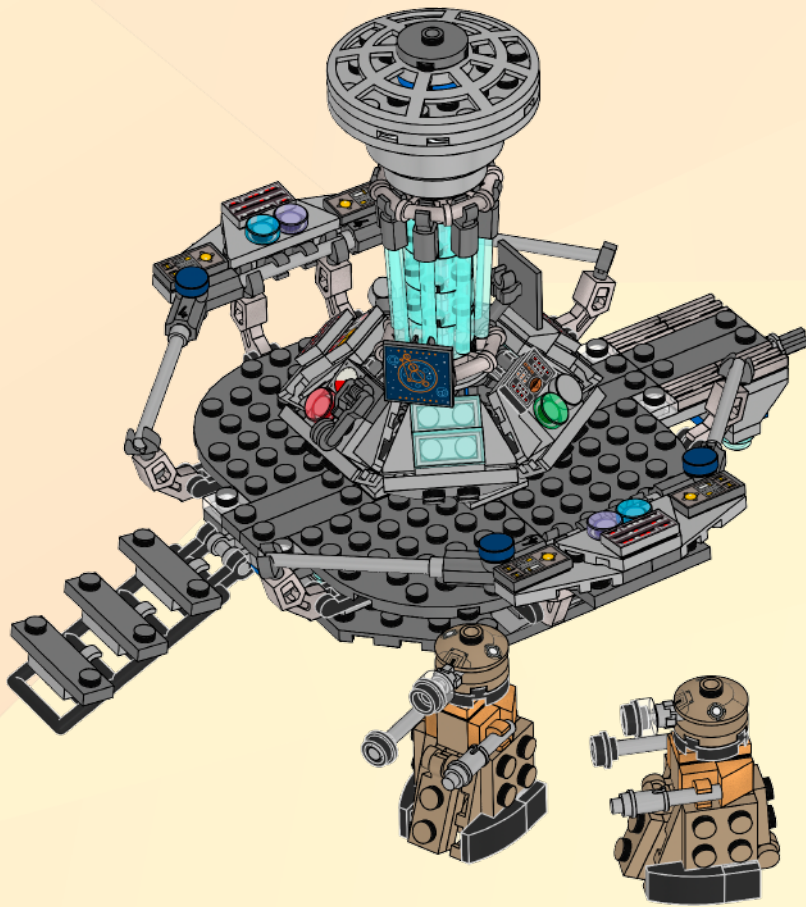





This product started out with a great project idea submitted by Andrew Clark and was transformed into a true LEGO® model by LEGO Product Designer Samuel Johnson and LEGO Graphic Designer Adam Corbally.



## Andrew Clark

“I work as a Senior Artist on digital games, and I wanted to try something else that was creative. I looked to my childhood, and the fun I had with LEGO bricks. I looked at all the amazing things people were now doing with LEGO models and felt inspired!

I joined LEGO forums, and heard about LEGO Cuusoo, now LEGO Ideas. To be able to submit my own designs that could become an official LEGO set was compelling! I immediately set out to create my own designs, I had to try!

When LEGO Ideas announced they would accept projects based on *Doctor Who* I was excited. I immediately started a design, and through constant iteration, it was refined. Getting the best LEGO representation of the TARDIS was crucial, as was emulating its “bigger on the inside” feature.

Working with LEGO Product Designer Sam Johnson was a great experience; he managed to better incorporate the opened TARDIS into the interior, and console. He made other improvements, and I felt lucky to have him working on it.

Now my mind is thinking of future LEGO Ideas projects!”







“Growing up, my uncle (Paul McGann) was cast as the Eighth Doctor which was an extremely exciting time. And as soon as I saw this project, I wanted to be the designer soooo bad!

It was fun to work on the prototype from Andrew, making it more stable and even possible to pick up the entire set, so it can be moved around. I even built in the feature that allows the Doctor to be placed inside the TARDIS.”

### Samuel Johnson

Product Designer, The LEGO Group

“I’m a big fan of the rebooted *Doctor Who* series, so I was thrilled to have the chance to work on the graphics for the model. We managed to include some really awesome details, like the Eleventh Doctor’s cool bow tie, but my favorite would be the alternative face for the terrifying, Weeping Angel! I hope all you Whovians like it... Geronimo!”

### Adam Corbally

Graphic Designer, The LEGO Group





8



2x  
4211396



1x  
4650260



2x  
6071229



6x  
4654582



1x  
4211632



1x  
4211376

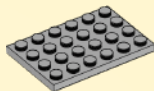

1x  
4211404



14x  
4507056



1x  
6028015



2x  
4211487



1x  
6015349



2x  
4211791



2x  
4211794



2x  
4211475



2x  
4585429



4x  
6093527



6x  
6081975



1x  
6129009



1x  
6123037



1x  
6134394



2x  
4640844



2x  
6074698



1x  
4511007



1x  
4211503



4x  
4211470



2x  
4211483



2x  
4211622

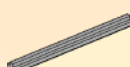

1x  
4211805



2x  
4667578



1x  
6132558



1x  
6134401



1x  
6129598



3x  
4210935



8x  
4210862



2x  
6092572



4x  
4221879



6x  
4211063



2x  
4210635



9x  
4598769



4x  
4211065



1x  
6071226



1x  
4587212



6x  
6000606



4x  
4581225



2x  
6055313



1x  
6115080



4x  
4500517



2x  
4583688

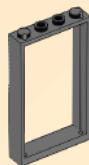

1x  
4535833



2x  
6132560



2x  
6037872



1x  
4211081



8x  
6015890



8x  
4289542



4x  
4210688



1x  
4499858



6x  
6020189



2x  
4211111



1x  
6134664



2x  
6092594



4x  
6071259



1x  
6122423



4x  
4587002



13x  
4619636



2x  
6020990



8x  
6008483



1x  
6134652



1x  
4523794



1x  
6134650



1x  
4550736



1x  
6127019



1x  
6134644



1x  
6123876

Customer Service

Kundenservice

Service Consommateurs

Servicio Al Consumidor

LEGO.com/service or dial



: 00800 5346 5555

: 1-800-422-5346



# TRAVEL WITH THE DOCTOR INTO ANOTHER DIMENSION

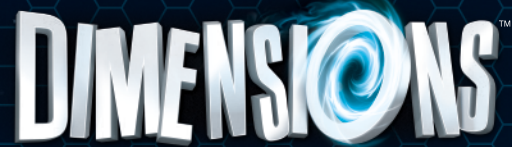

LEGO DIMENSIONS Videogame software © 2015 TT Games Ltd. Produced by TT Games under license from the LEGO Group. LEGO, the LEGO logo, the Brick and Knob configurations and the Minifigure are trademarks and/or copyrights of the LEGO Group. ©2015 The LEGO Group. BBC logo © BBC 1996. Doctor Who logo © BBC 2009. Dalek image © BBC/Terry Nation 1963. Cyberman image © BBC/Kit Pedler/Gerry Davis 1966. K-9 Image © BBC/Bob Baker/Dave Martin 1977. Licensed by BBC Worldwide Limited. All other trademarks and copyrights are the property of their respective owners. All rights reserved.



# IDEAS

## A WHOLE UNIVERSE OF INNOVATIVE LEGO® IDEAS

Do you have an exciting idea for a LEGO® model? Then why not make it into a LEGO Ideas project? You can share your product concept on ideas.LEGO.com and see what other people think about it.

If your project gains 10,000 supporters, it will automatically qualify for the quarterly LEGO Review. This is where we take an in-depth look at the most popular projects and carefully evaluate them to discover the idea with the most potential. If your project makes it through the review, it will become an official LEGO product.

There are tens of thousands of active members, and thousands of product ideas on LEGO Ideas – several of which have become hit LEGO sets! So take a look, sign up, and support your favorite ideas, or even better: upload your own!

## LEGO.COM/IDEAS

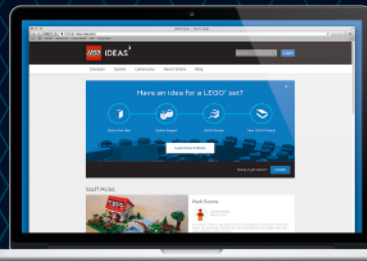



# WIN

GO TO [WWW.LEGO.COM/PRODUCTFEEDBACK](http://WWW.LEGO.COM/PRODUCTFEEDBACK) AND  
GIVE US YOUR SHORT **FEEDBACK** ABOUT THIS  
LEGO® SET FOR A CHANCE TO WIN  
A COOL LEGO PRIZE.



## [LEGO.com/productfeedback](http://LEGO.com/productfeedback)

### GEWINNE



Erzähle uns auf  
[www.LEGO.com/productfeedback](http://www.LEGO.com/productfeedback)

etwas über die Erfahrungen, die du mit  
diesem LEGO® Set gemacht hast, und  
sichere dir die Chance auf einen coolen  
LEGO Preis!

### GAGNE



Rends-toi sur  
[www.LEGO.com/productfeedback](http://www.LEGO.com/productfeedback)

et donne-nous quelques commentaires  
sur ce produit LEGO® pour avoir une  
chance de gagner un prix LEGO !

### GANAN



Visita  
[www.LEGO.com/productfeedback](http://www.LEGO.com/productfeedback)

y envíanos tu opinión acerca de este set  
LEGO®. ¡Participarás en el sorteo de un  
premio LEGO!

### 获取奖品



登录  
[www.LEGO.com/productfeedback](http://www.LEGO.com/productfeedback)

给出关于此乐高®套装的简短反馈，  
就有机会获得炫酷乐高奖品

LEGO and the LEGO logo are trademarks of the LEGO Group. ©2015 The LEGO Group.



BBC, DOCTOR WHO (word marks, logos and devices), TARDIS, DALEKS, CYBERMAN and K-9 (word marks and devices) are trademarks of the British Broadcasting Corporation and are used under license. BBC logo © BBC 1996. Doctor Who logo © BBC 2009. Dalek image © BBC/Terry Nation 1963. Cyberman image © BBC/Kit Pedler/Gerry Davis 1966. K-9 image © BBC/Bob Baker/Dave Martin 1977.

6177607