



BACK TO THE FUTURE



TRAVELLING THROUGH TIME

WITH BACK TO THE FUTURE

Back to the Future is a trilogy of timeless movies that follows the adventures of skateboarding teenager Marty McFly (Michael J. Fox) and his scientist friend “Doc” Emmett L. Brown (Christopher Lloyd). In the first film (1985), Marty finds himself the unwitting driver of Doc’s heavily modified plutonium-powered DeLorean time machine, and is accidentally sent back in time to the year 1955.

In a fast-paced race against time, Marty must first ensure that his future parents fall in love, and then must harness a new source of energy – a 1.21 “jigowatts” lightning strike – to power the time machine and propel him back to the future.

With its perfect mixture of comedy, action and science fiction, *Back to the Future* was the most successful film of 1985, and remains one of Universal Studios’ biggest blockbusters ever. Two sequels appeared in 1989 and 1990 with the DeLorean Time Machine again playing a central role in both adventures.



© 2013 Universal



The *Back to the Future* films have remained immensely popular since their release, so much so that in 2007, the US Library of Congress added the original movie to its National Film Register as one of 25 elite films deemed to have enduring importance to popular American culture, to be preserved for all time.



Marty McFly: Wait a minute, Doc. Ah... Are you telling me that you built a time machine... out of a DeLorean?

Doc Brown: The way I see it, if you're gonna build a time machine into a car, why not do it with some style?

THIS TIME MACHINE

WILL TRANSPORT YOU BACK TO THE FUTURE

The DeLorean Time Machine is without a doubt one of the most important stars in the *Back to the Future* trilogy. In the story, we learn that it has taken Doc Brown nearly 30 years to create his 'Flux Capacitor,' which makes time travel possible. Doc selected the DeLorean DMC-12 as his vehicle of choice because its stainless steel construction allows for the optimal level of flux dispersal. This ensures that the vehicle and its passengers can experience a smooth passage through the space-time continuum.



© 2013 Universal
An original car used in filming has been restored and is on display at the Studio Tour, Universal Studios Hollywood.

In reality, the filmmakers chose the sleek and stylish DMC-12 because its characteristic gullwing doors gave it a unique, futuristic look. Five actual DeLorean vehicles were used in the filming of the movies, while one more was specially modified for interior shots. Aircraft parts, blinking lights and other components were added for effect, while carbon dioxide extinguishers were

hidden inside the car to simulate the exhaust system output. Liquid nitrogen was poured onto the car for scenes after it had traveled through time to give the impression that it was cold.



HIGHLIGHTS

TEMPORAL DISPLACEMENT MODIFICATIONS & EQUIPMENT

- Flux Capacitor
- Mr. Fusion Home Energy Reactor
(2015 version)
- TFC Drive Circuits Switch
- Time Circuits
- Display Monitor
- Input Keypad
- Light Water "Street Legal"
Nuclear Reactor Core
- Digital Speedometer
- Overhead Console
- Cabin Oxygen Tank
- Liquid Oxygen Chambers



THE MICHAEL J. FOX FOUNDATION FOR PARKINSON'S RESEARCH

As the world's largest private funder of Parkinson's research, The Michael J. Fox Foundation is dedicated to accelerating a cure for Parkinson's disease and improved therapies for those living with the condition today. The Foundation pursues its goals through an aggressively funded, highly targeted research program coupled with active global engagement of scientists, Parkinson's patients, business leaders, clinical trial participants, donors and volunteers. In addition to funding more than \$300 million in research to date, the Foundation has fundamentally altered the trajectory of progress toward

a cure. Operating at the hub of worldwide Parkinson's research, the Foundation forges groundbreaking collaborations with industry leaders, academic scientists and government research funders; increases the flow of participants into Parkinson's disease clinical trials with its online tool, Fox Trial Finder; promotes Parkinson's awareness through high-profile advocacy, events and outreach; and coordinates the grassroots involvement of thousands of Team Fox members around the world.

www.michaeljfox.org

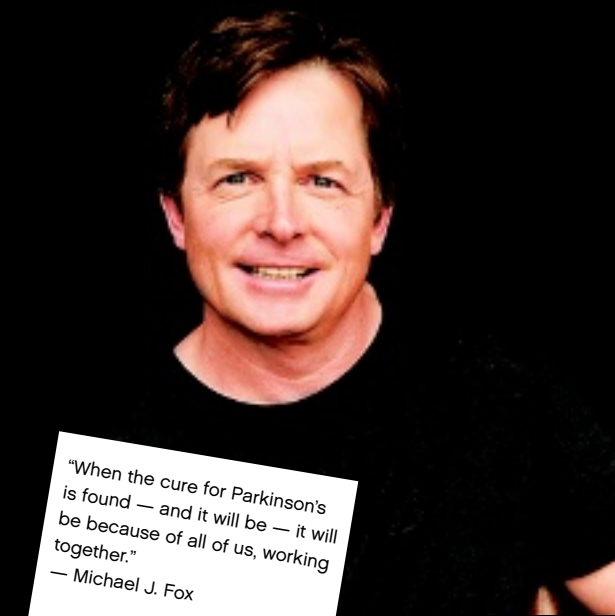
A portrait of Michael J. Fox, smiling, wearing a black t-shirt, against a black background. A white rectangular box is overlaid on the bottom left of the image, containing a quote and attribution.

"When the cure for Parkinson's
is found — and it will be — it will
be because of all of us, working
together."

— Michael J. Fox

©2013 The Michael J. Fox Foundation
for Parkinson's Research
(credit: Mark Seliger)

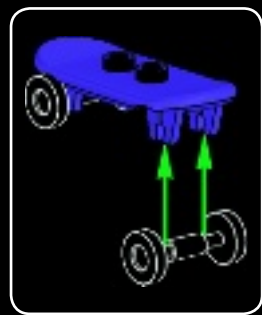
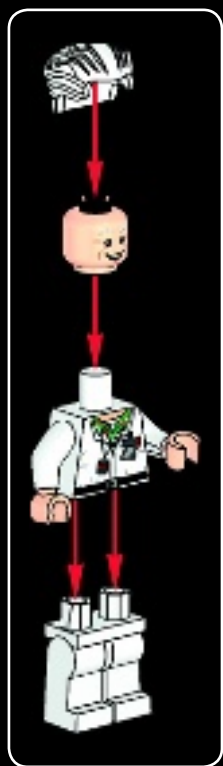

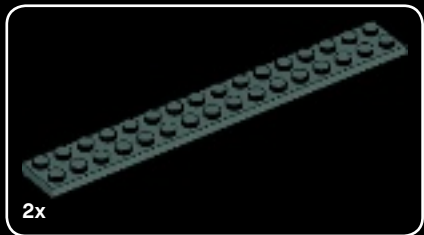
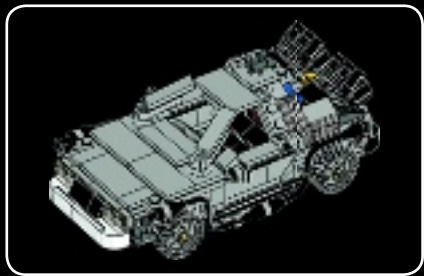

1

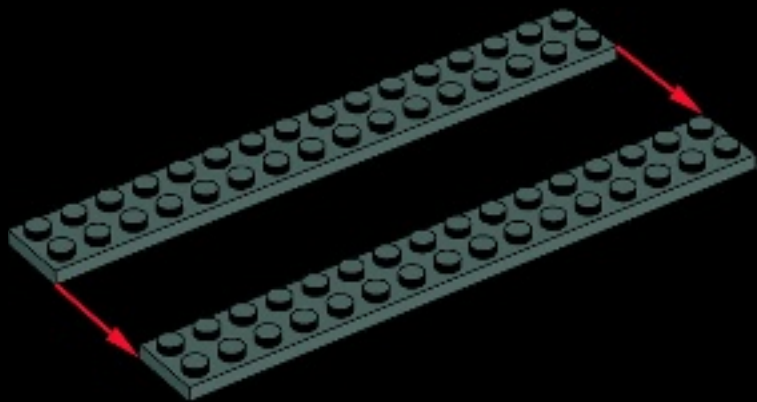



2x



2x



2x

2

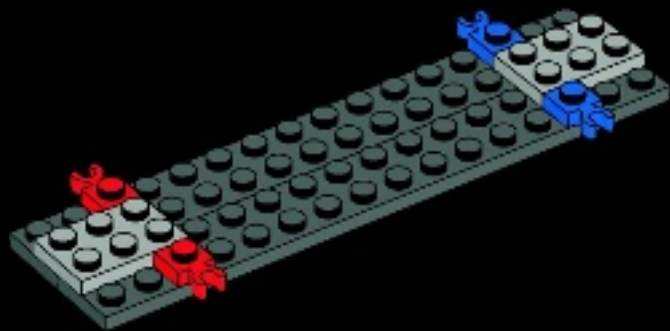

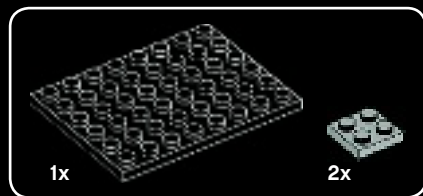

3

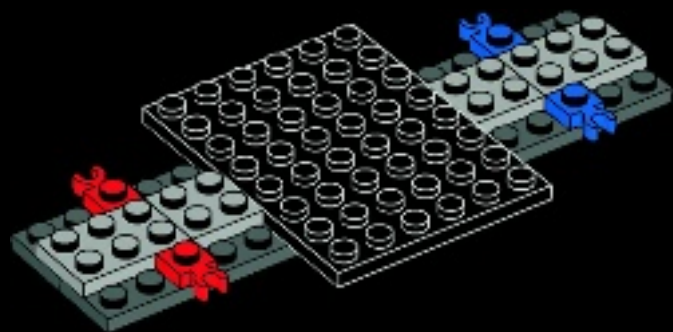



2x

4

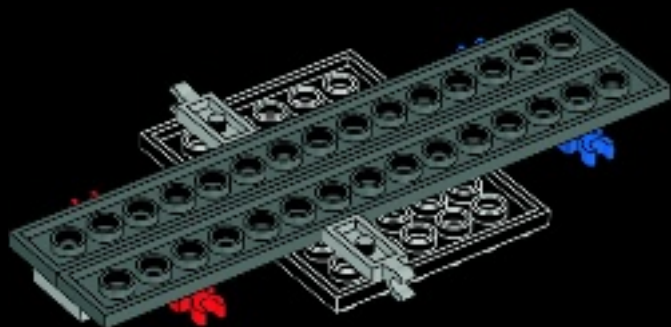



2x



2x

5

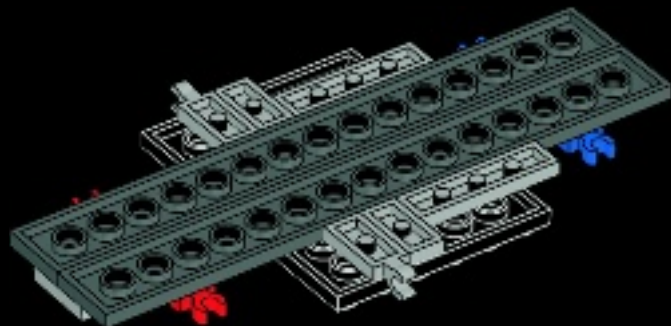



2x

6

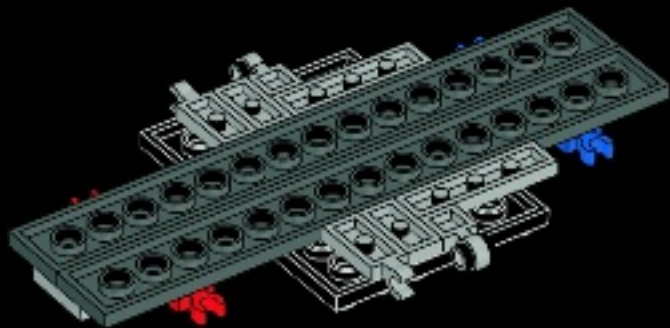

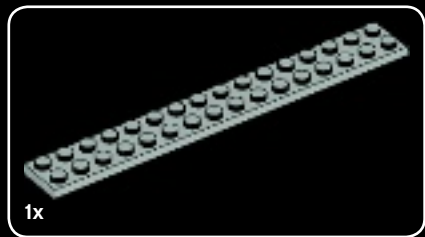

7

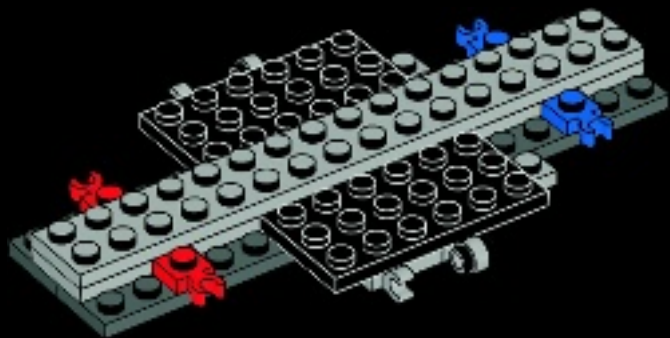



2x



2x

8

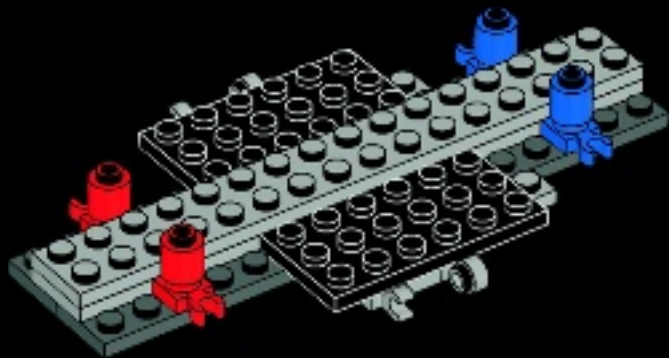



2x



2x

9





2x



2x



2x

10

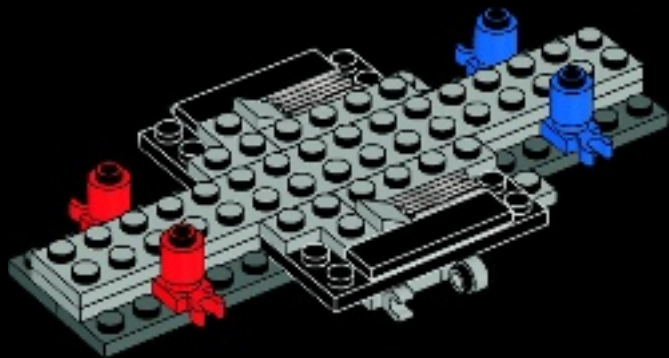



11

1



2



3



4

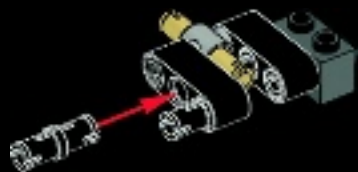

5



4x

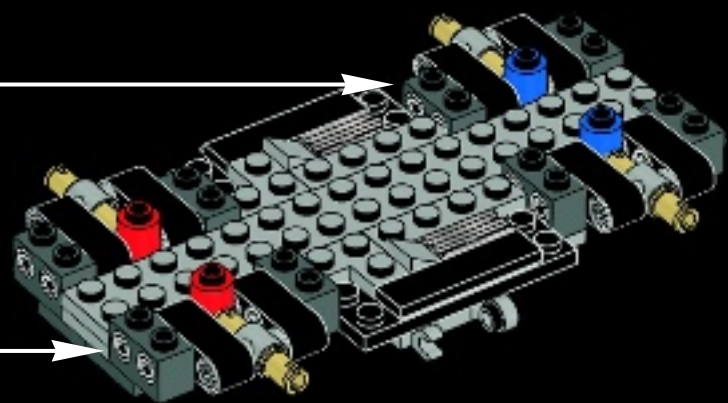



4x

12

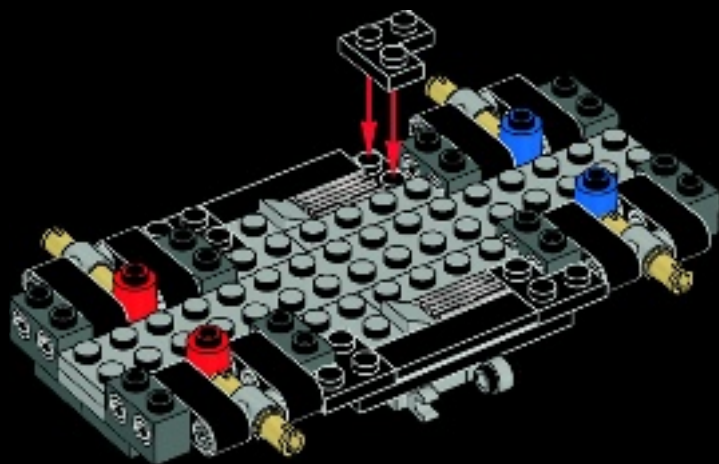



2x



1x



2x

13

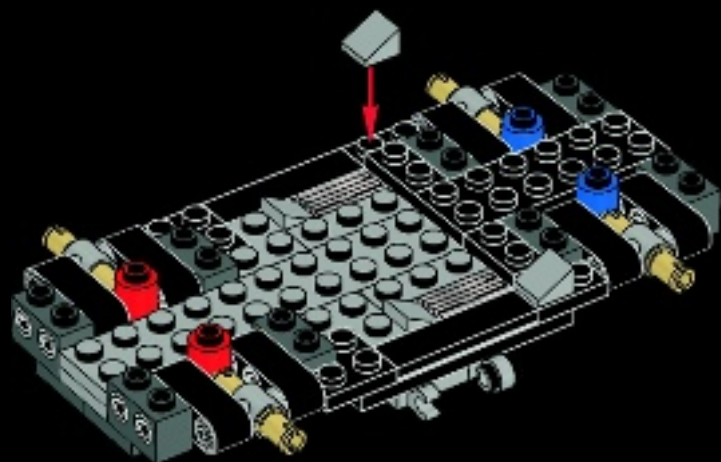

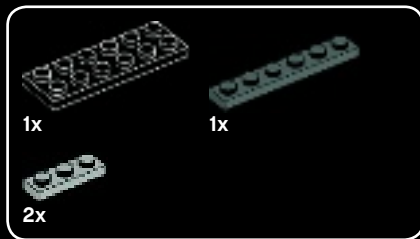

14





2x



1x

15

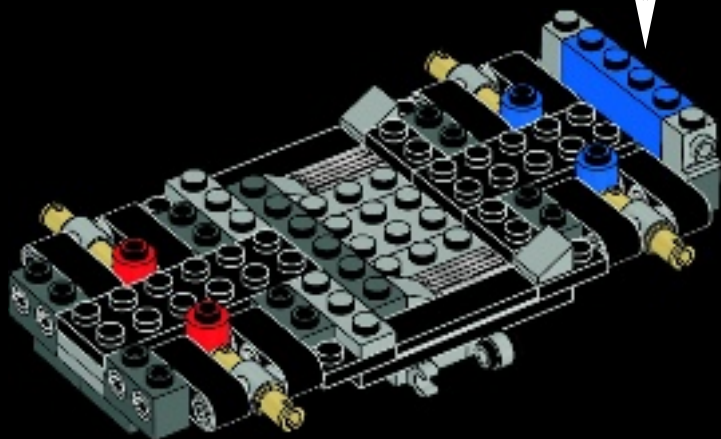
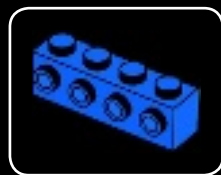

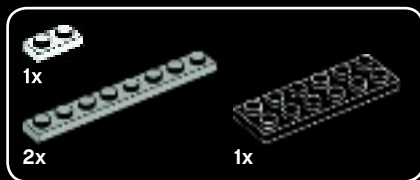

16

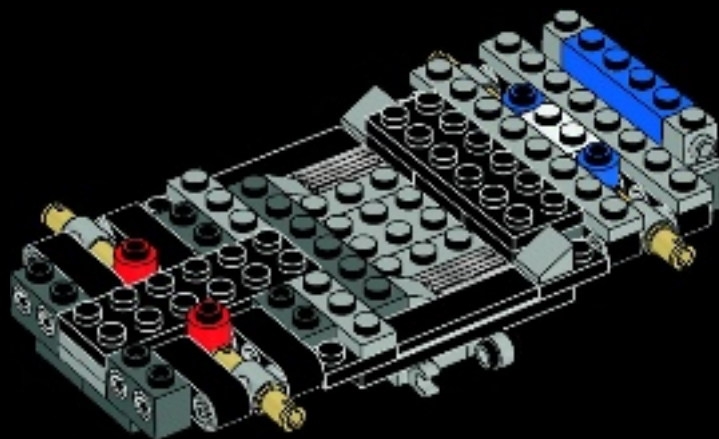

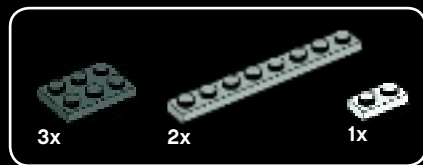

17

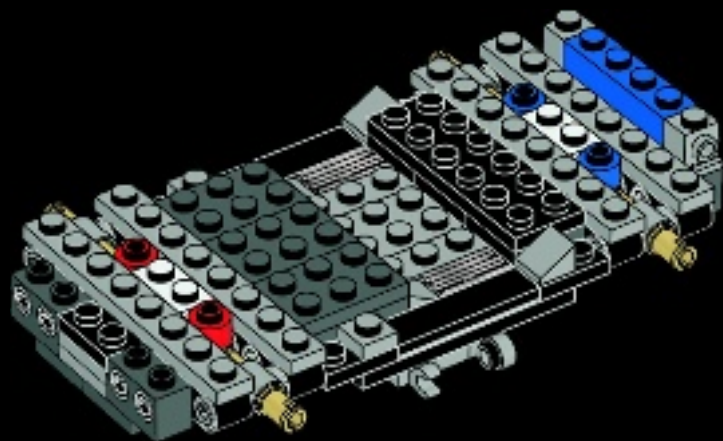



2x



2x



1x

18

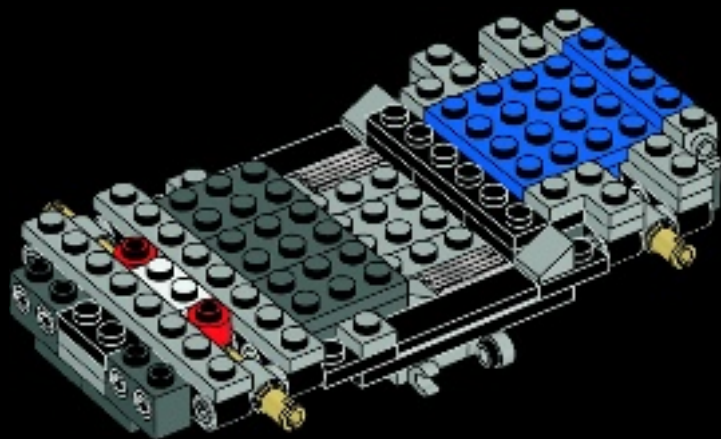



2x



2x



1x

19

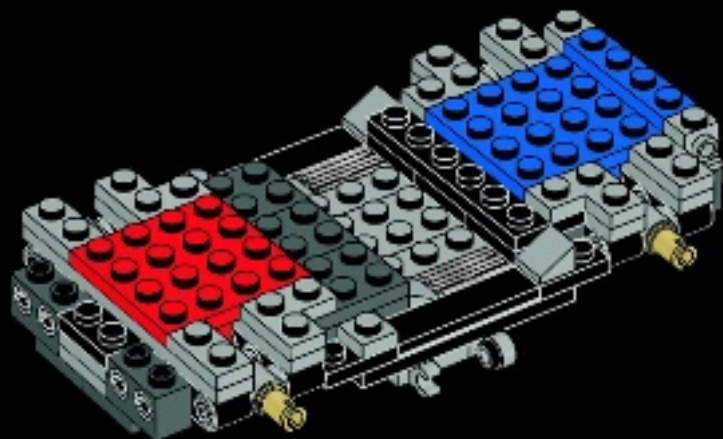

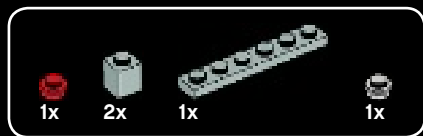

20

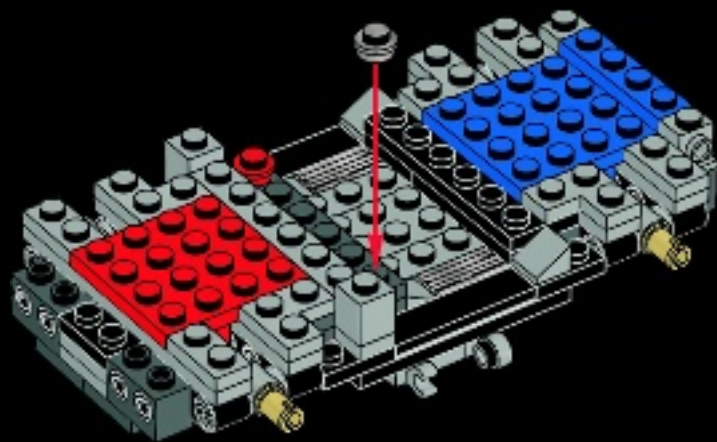



4x

21



2x

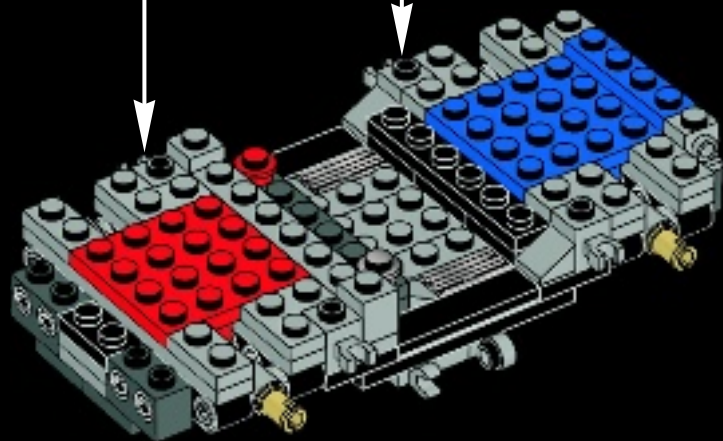

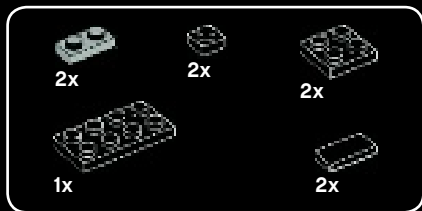

22

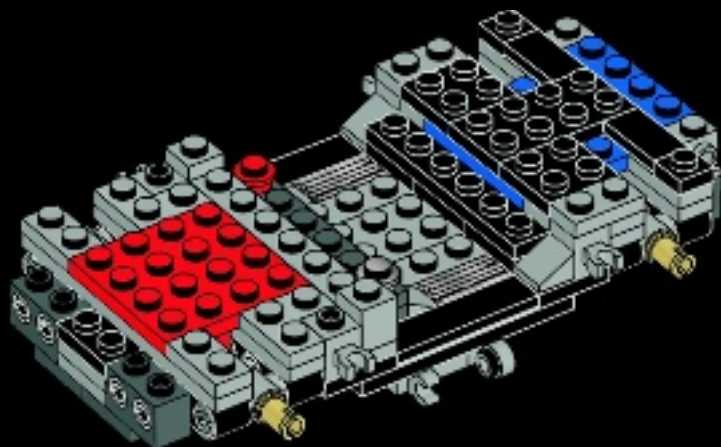



2x



4x

23

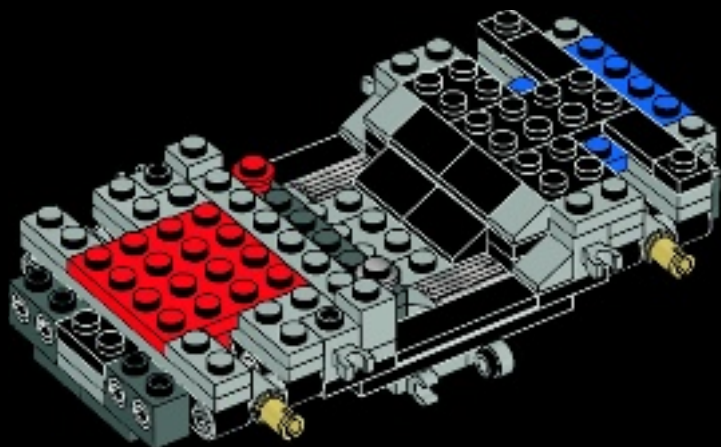



3x



1x



1x



1x



1x

24

1



2



3



4



5

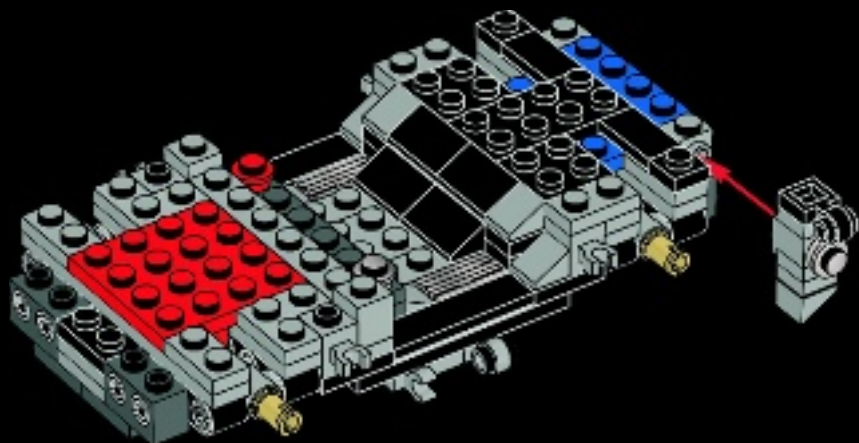

3x

1x

1x

1x

1x

25

1



2



3



4



5

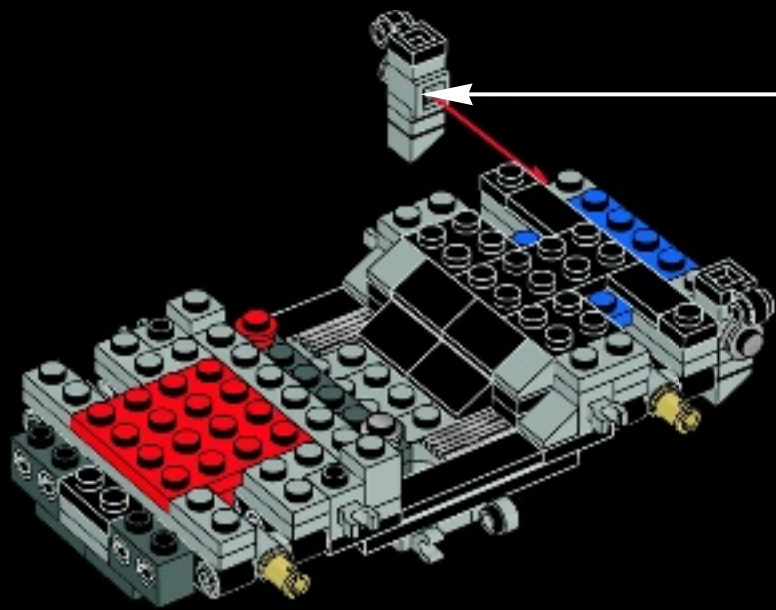



2x



2x



4x

26

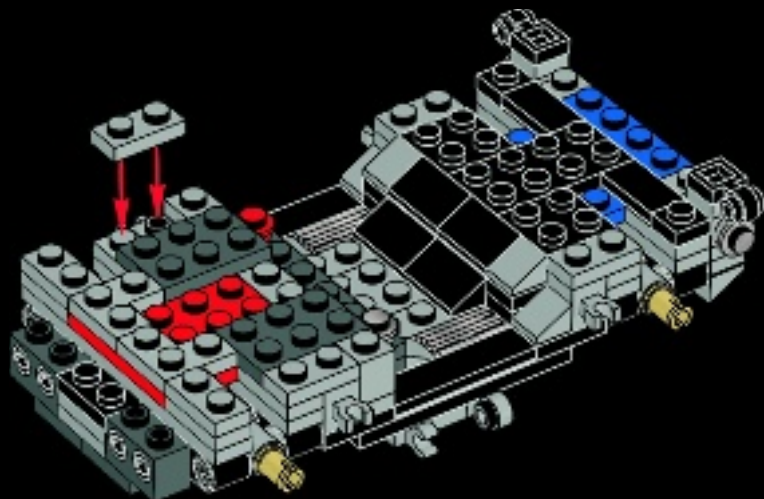



1x



2x

27

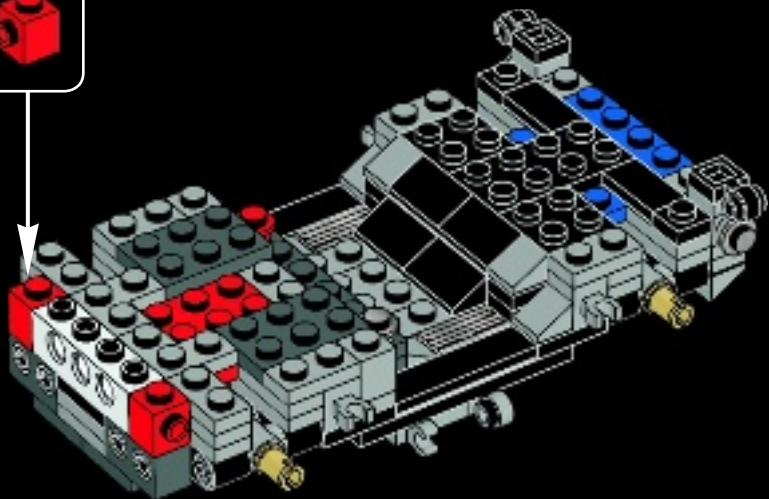



3x

28

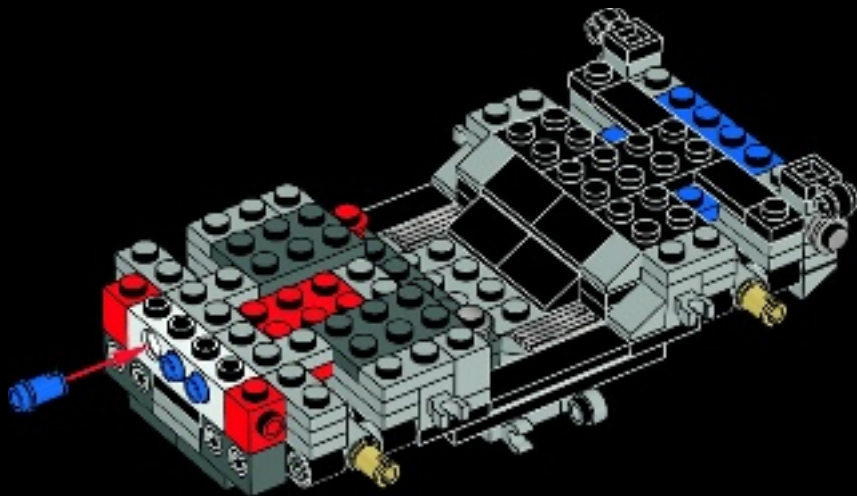



2x

29

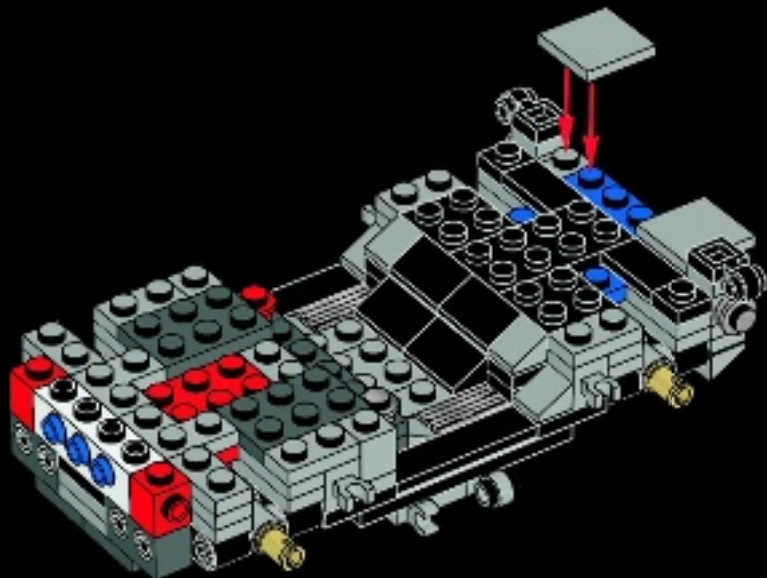



1x



1x



1x

30

1



2

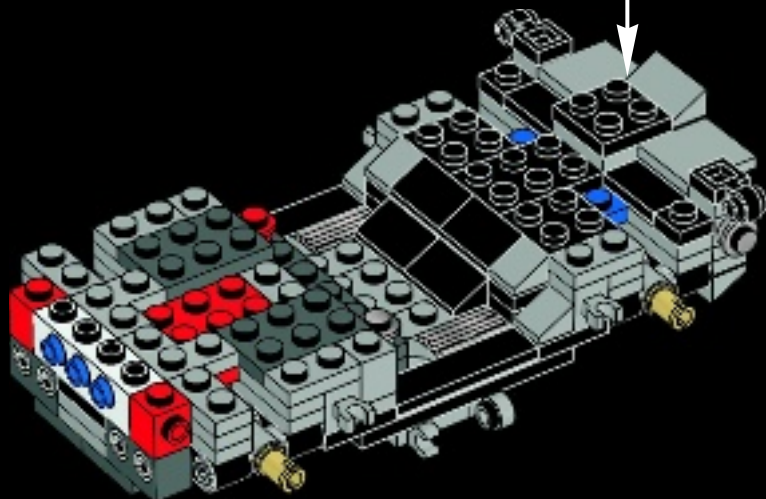



2x



2x

31

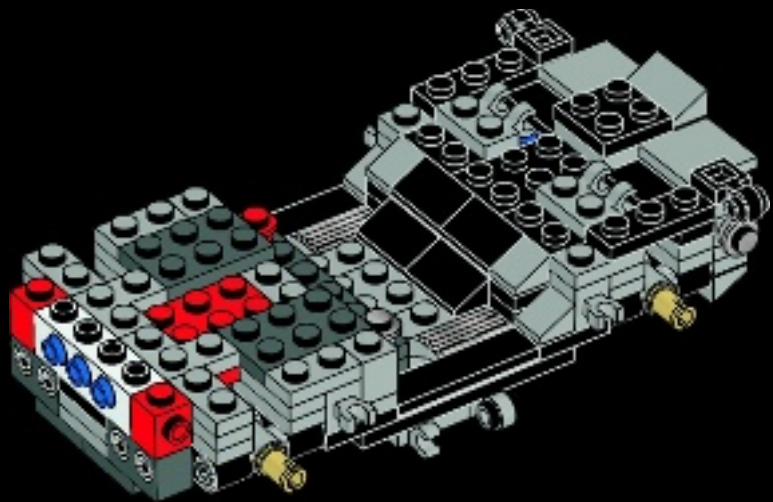



2x

32

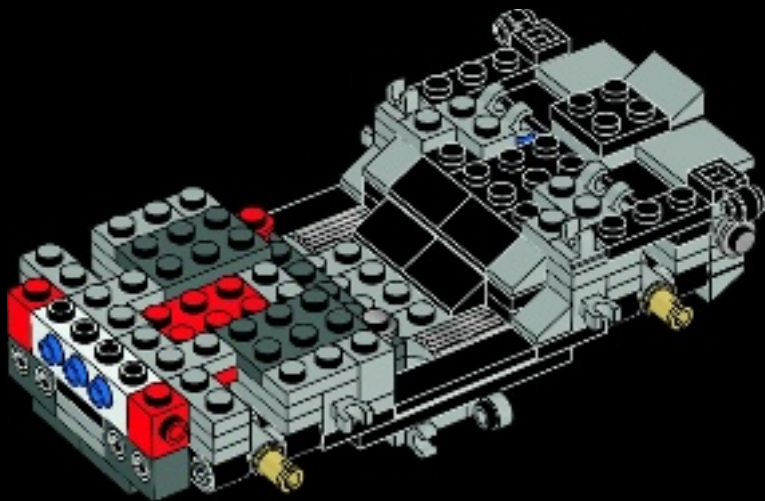



2x



1x

33

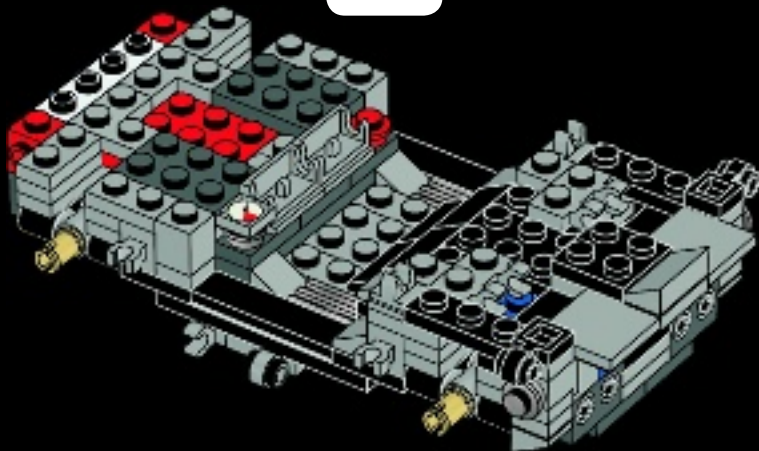
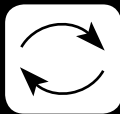

After entering a target date, the operator accelerates the car to 88 miles per hour (141.6 km/h), which activates the Time Travel Circuitry.





2x

34



2x

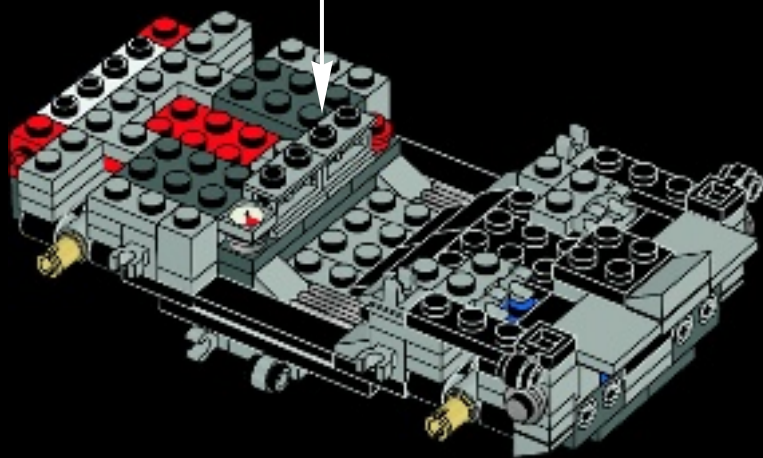



1x



1x



1x

35

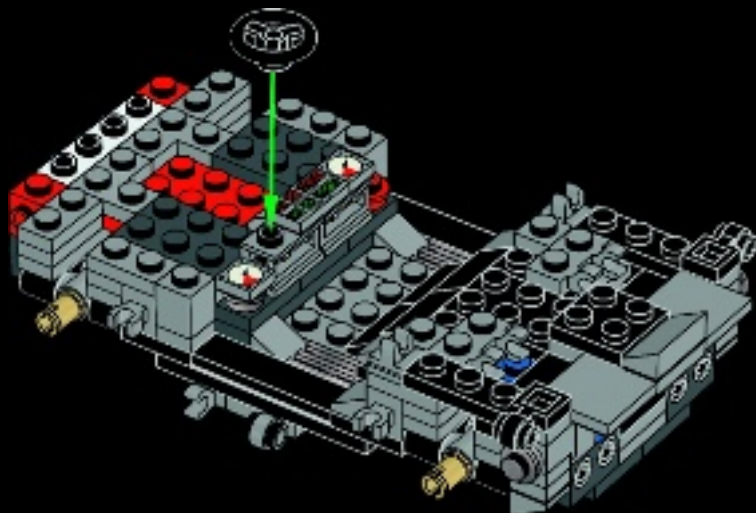

LEGO® "time display" shows the target and current dates. In this model, the target date is 28. 01. 1958, the date when the first LEGO brick was patented.



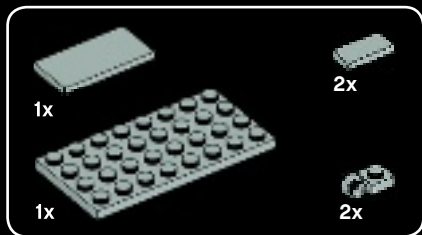

36

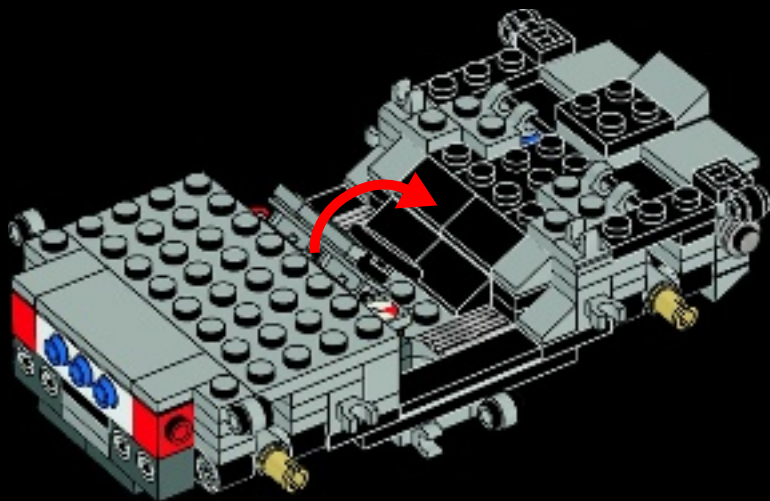

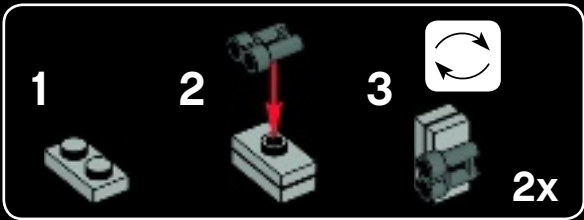

37

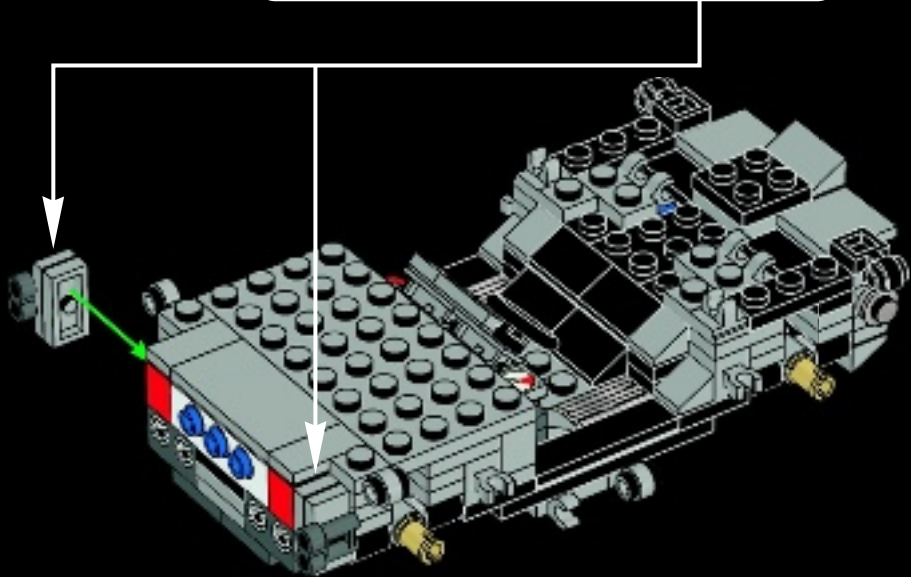



1x



2x



1x

38

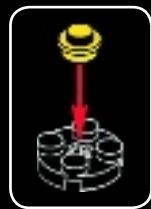
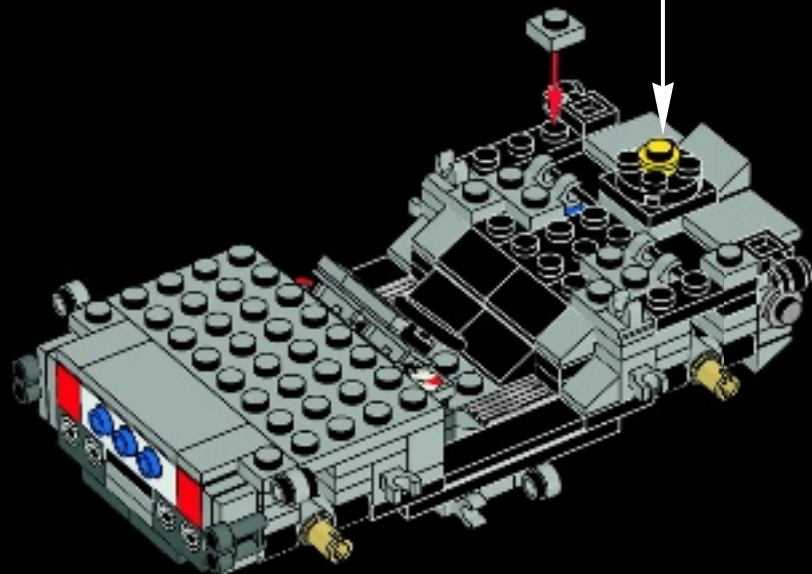



2x

39

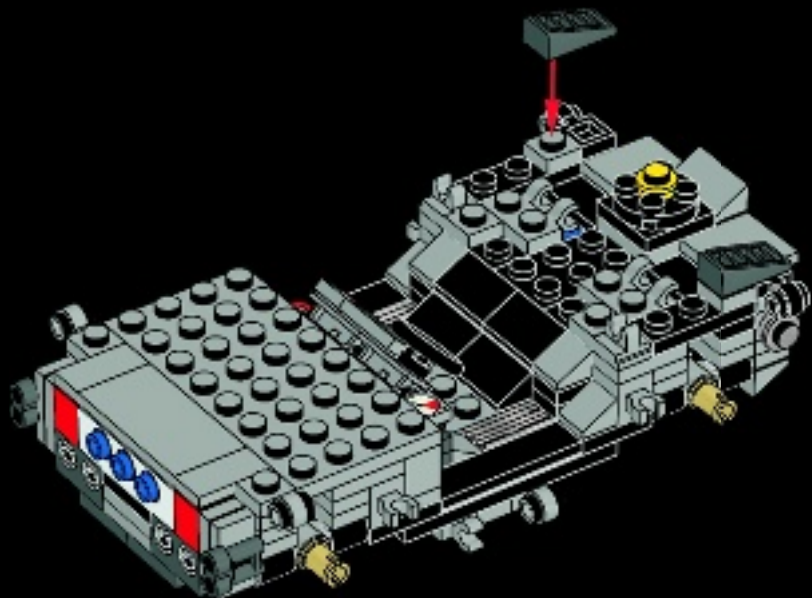



2x

40



2x

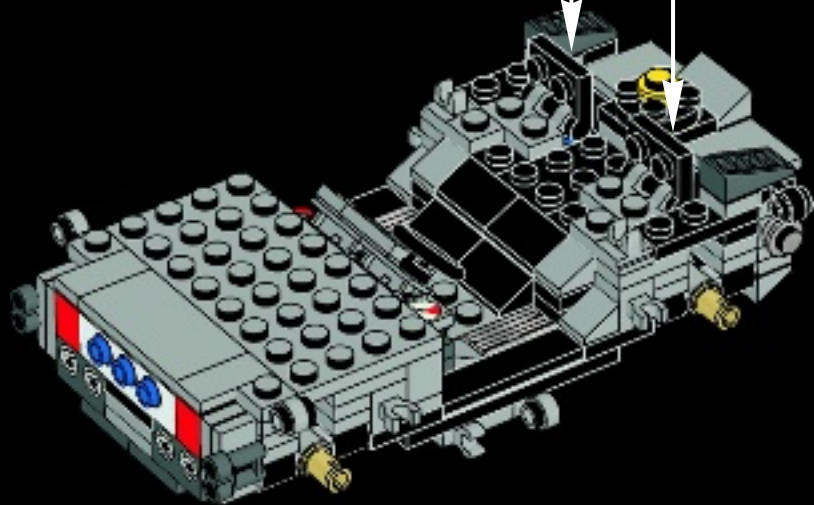



2x



2x

41

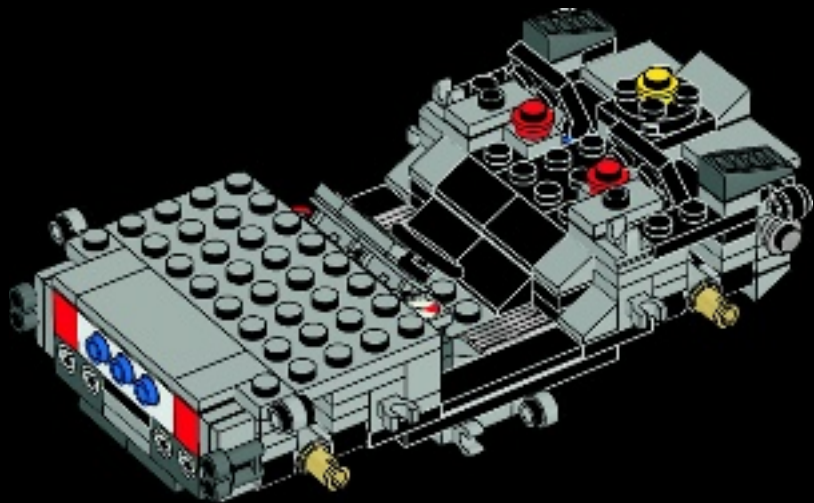



2x



8x



4x



4x



4x



2x

42

1

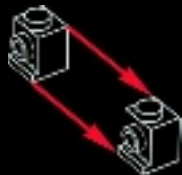

2



3



4



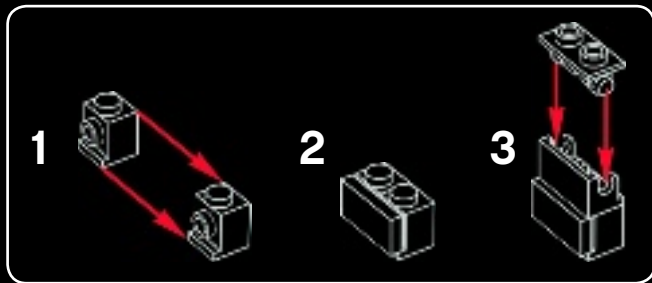

5

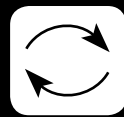

6



2x

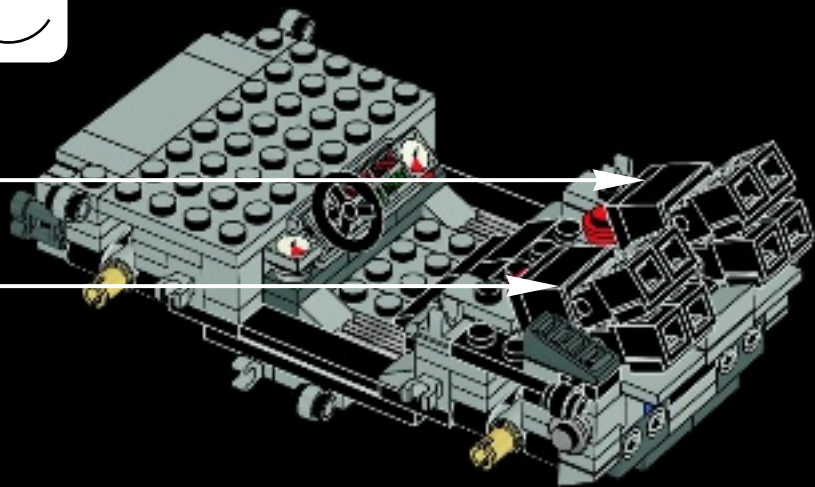



43

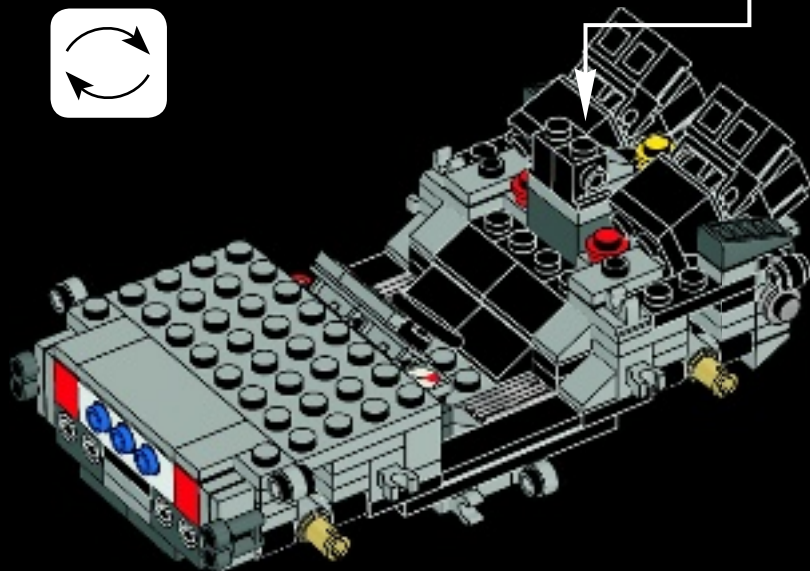
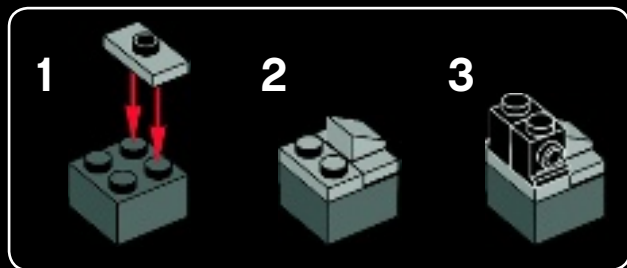



2x



2x

44

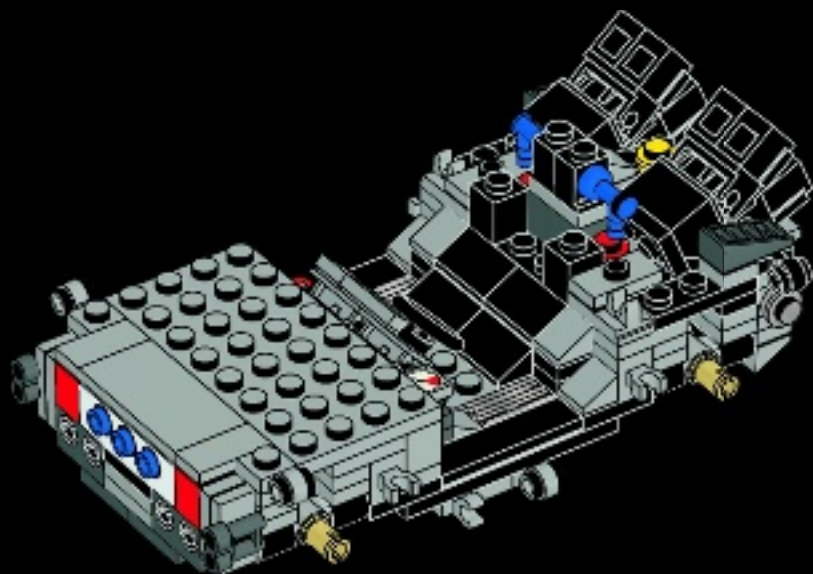



4x



2x



2x

45

1



2

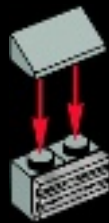

2x

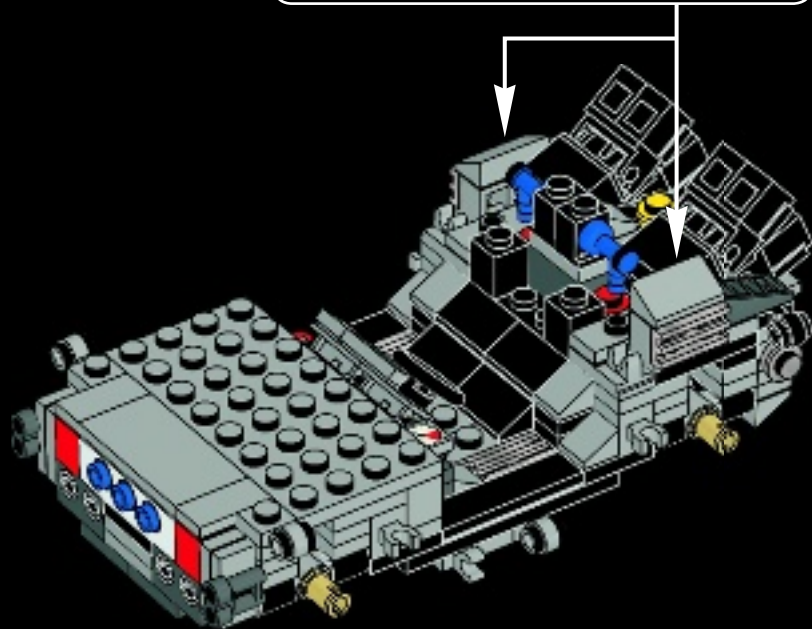



1x



2x

46

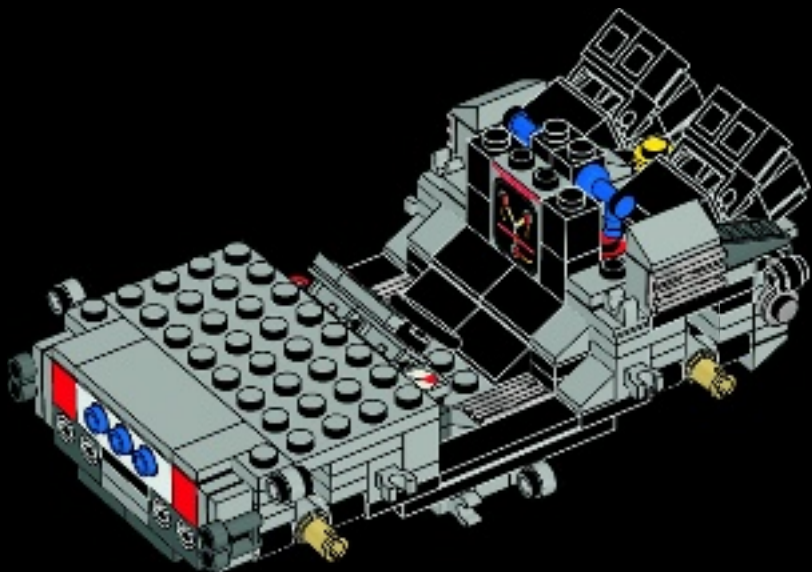



2x



1x



2x

47

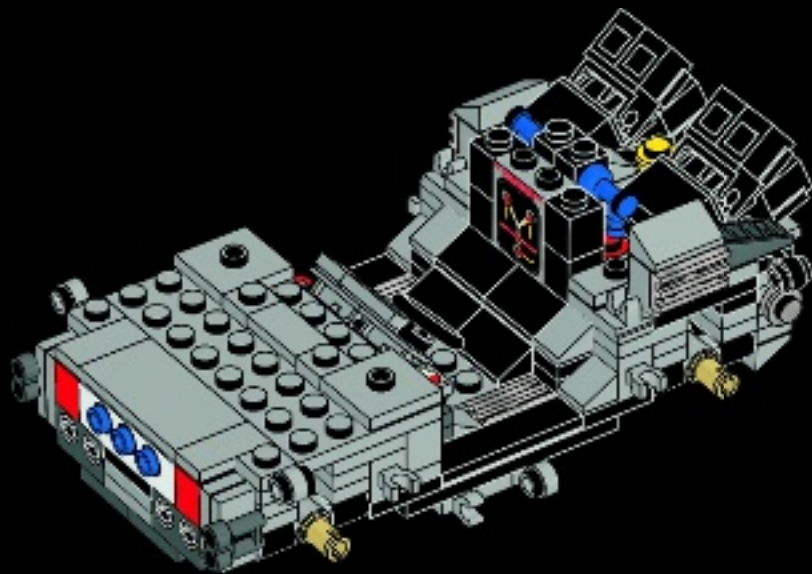



2x



2x

48



2x

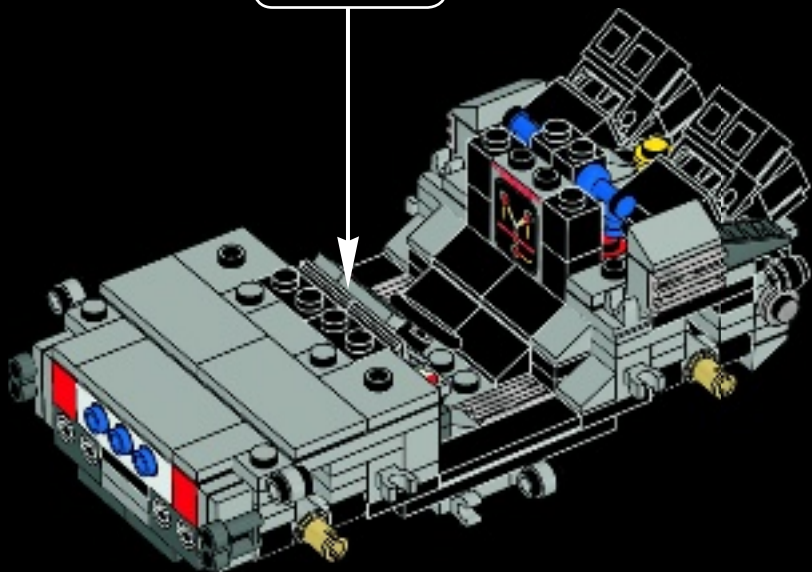



1

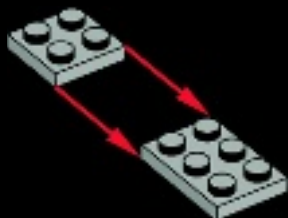

2

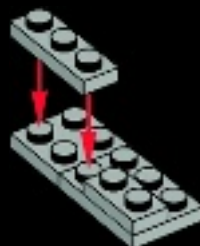



1x



1x

3

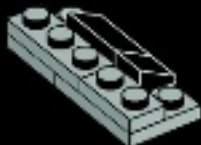

64



2x



2x

4

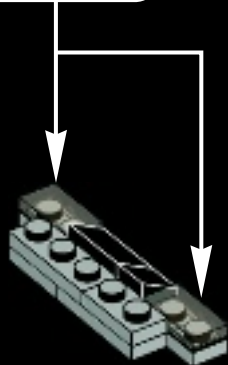
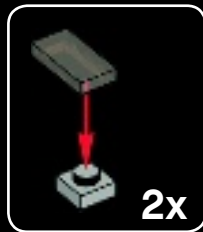



1x



2x

5

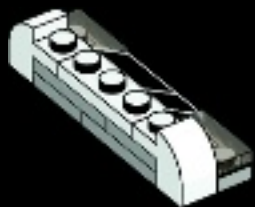

1x



1x

6

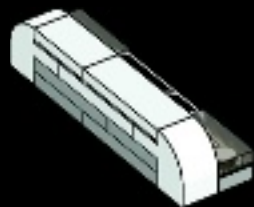

7



49

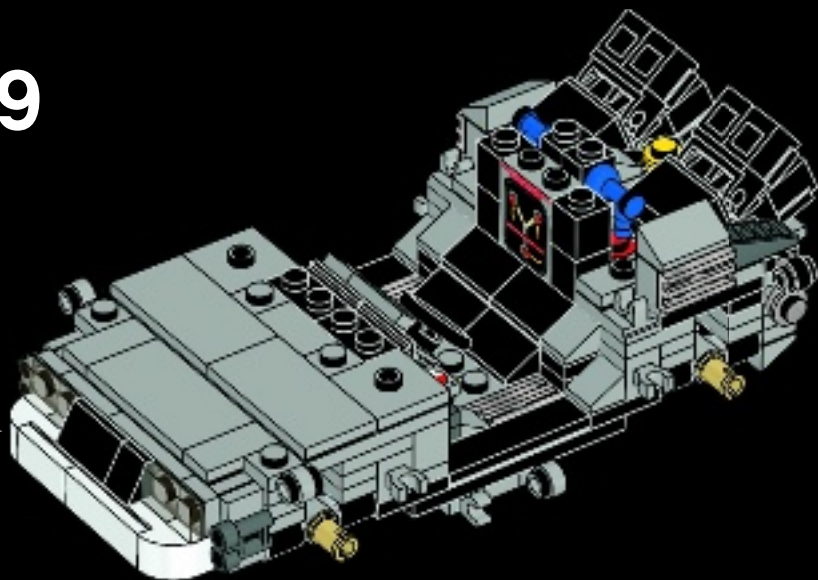



2x

50

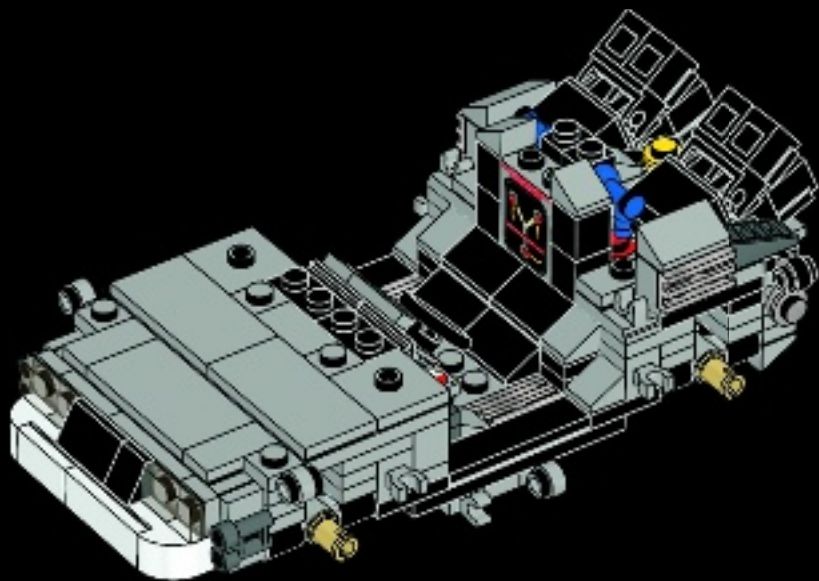



2x



2x

51

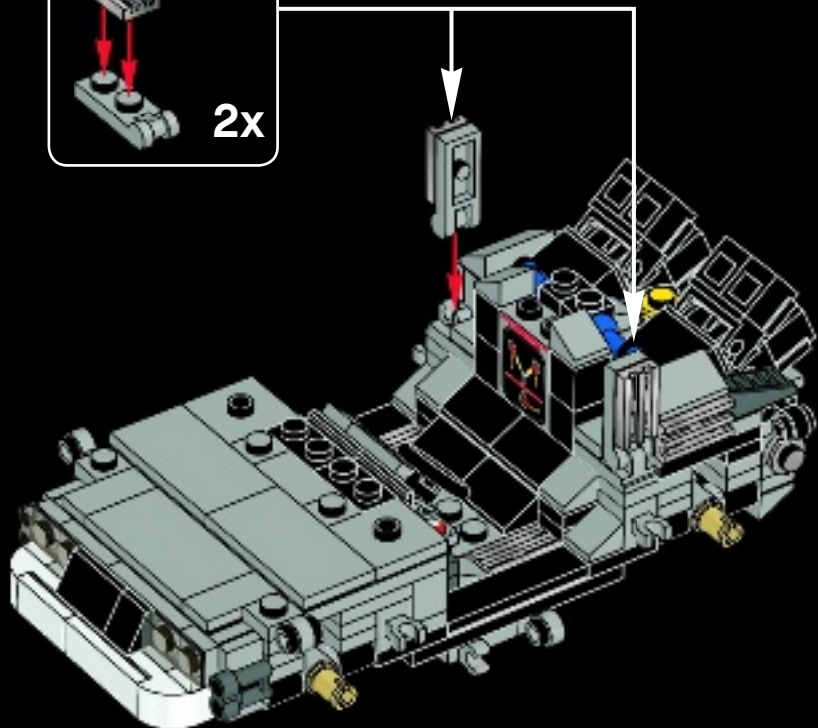
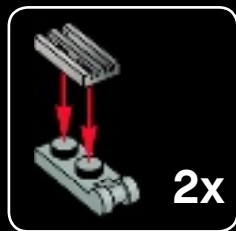



52

1



2



3

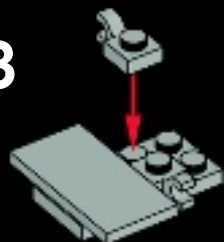

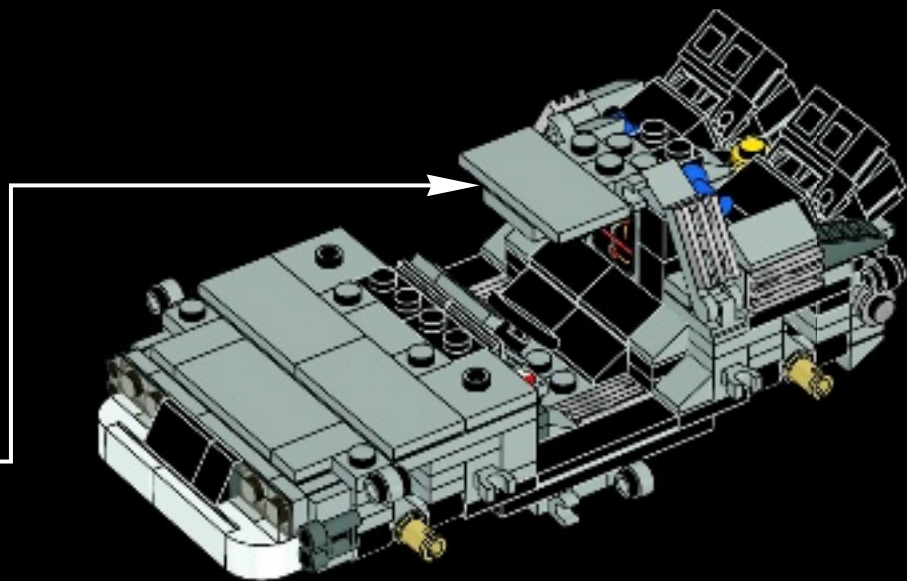



1x

53

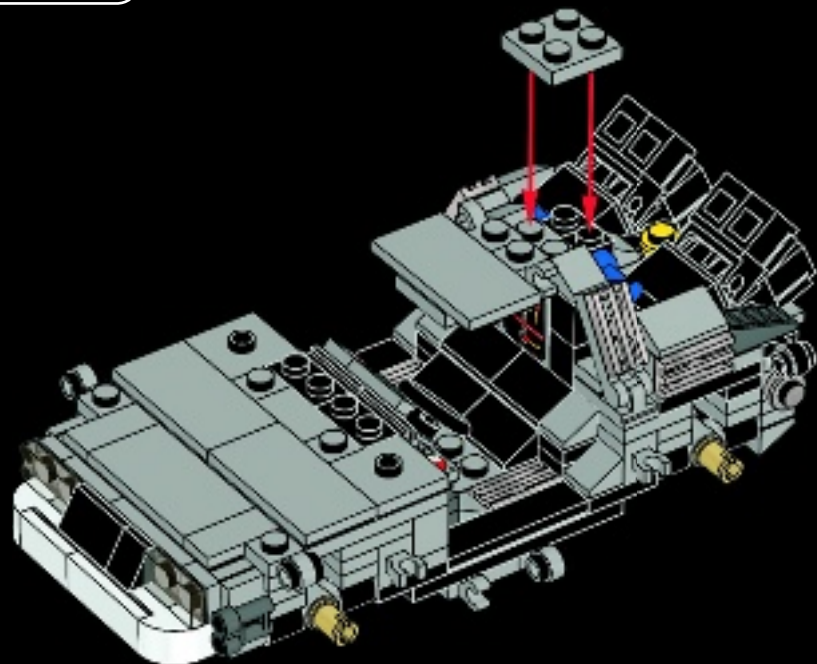



1x



1x



1x

54

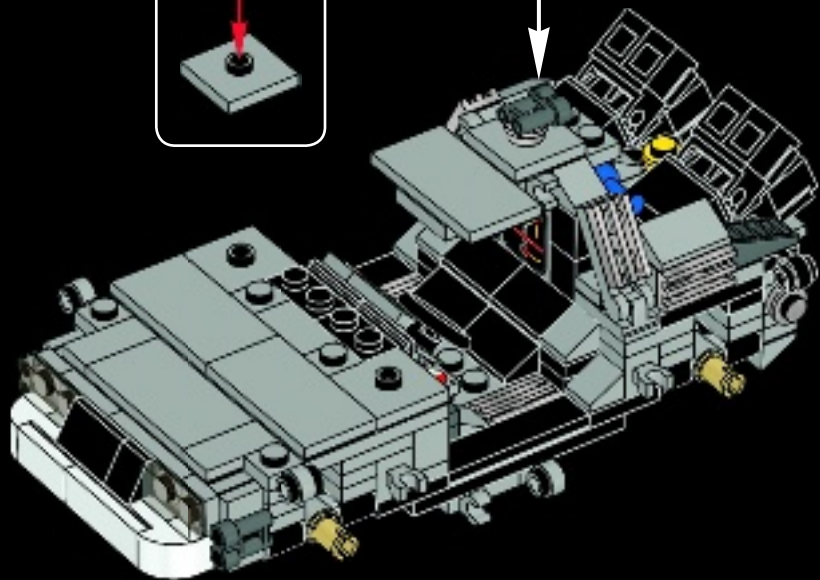
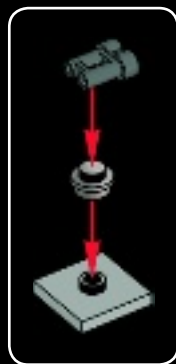



1x

1



1x



1x

2

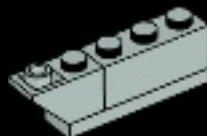



1x



1x

3

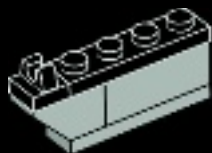

1x



1x



1x



1x

4

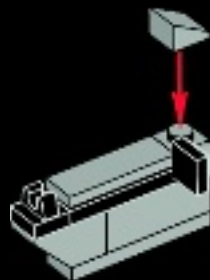

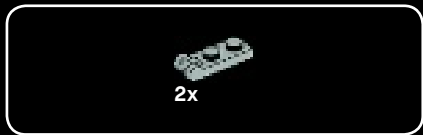

5

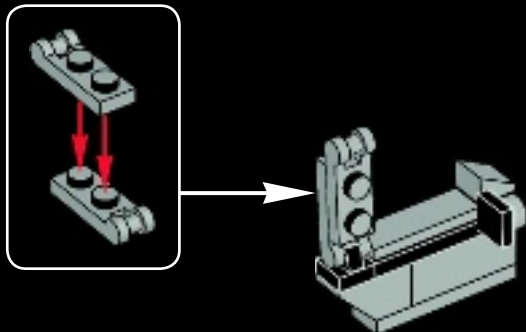

6

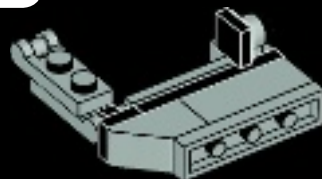

55

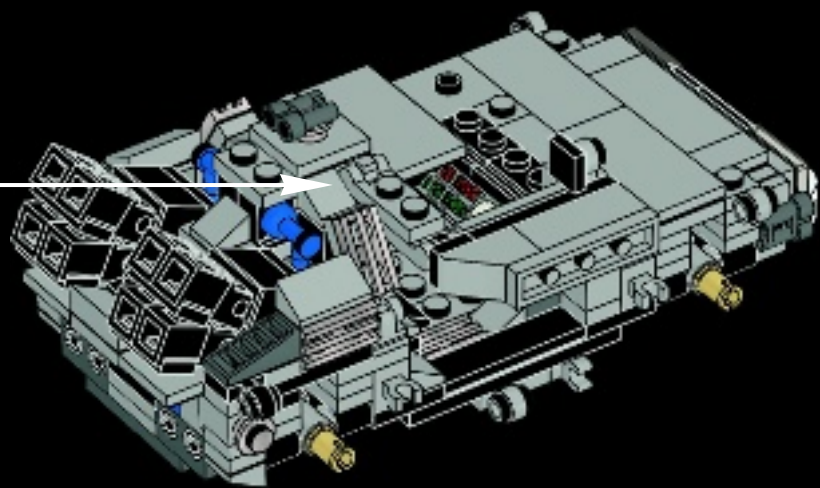

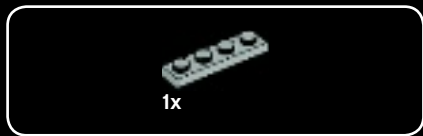

1x

1



1x

1x

2

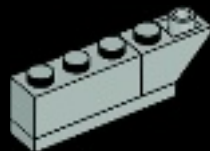



1x



1x

3

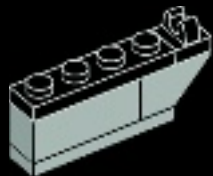

1x



1x



1x



1x

4

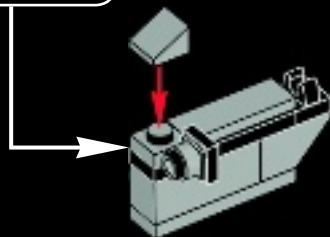
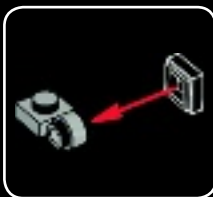

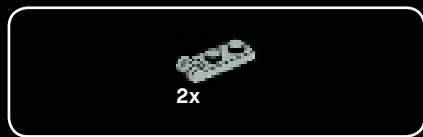

5

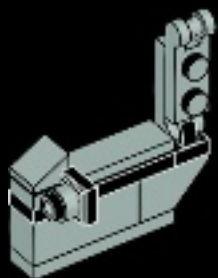
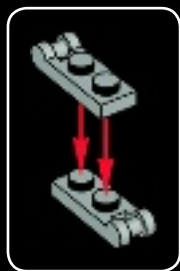

6





56

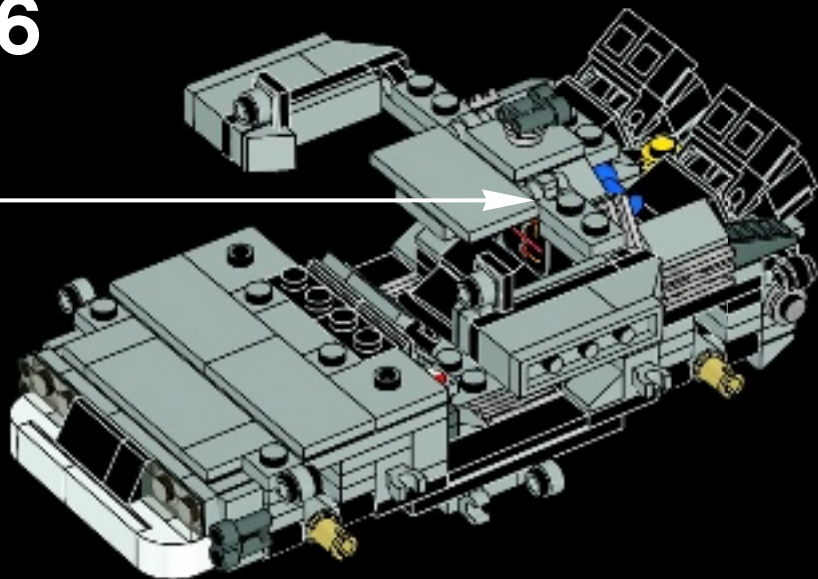



2x



2x

57

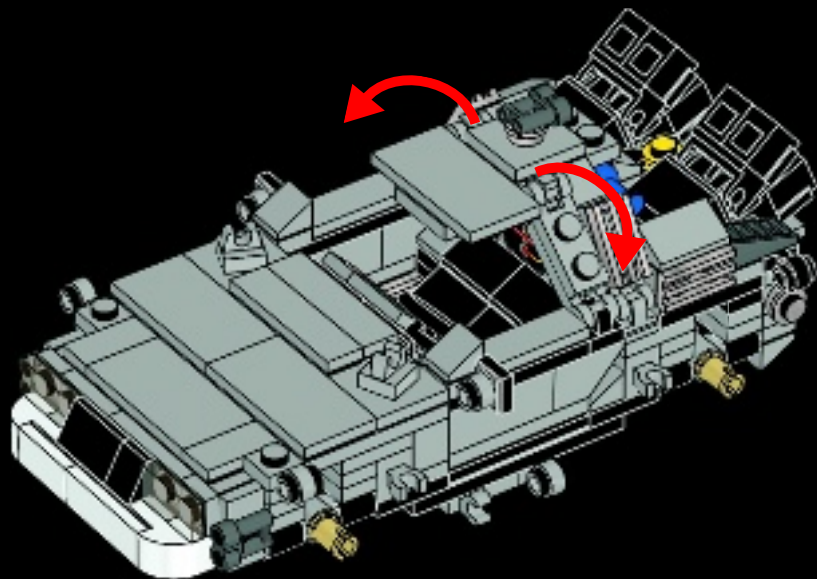



2x



2x

58

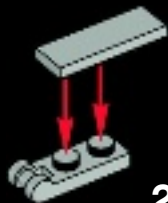
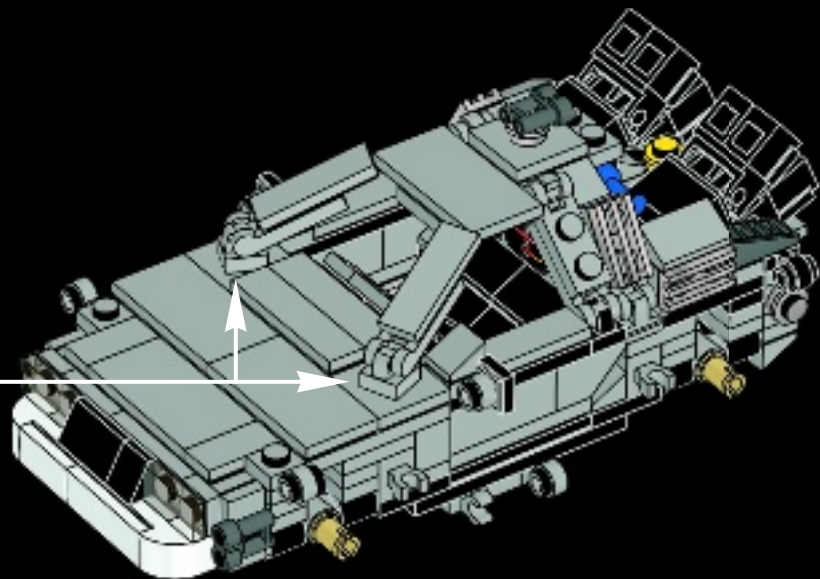

2x



4x



4x

59

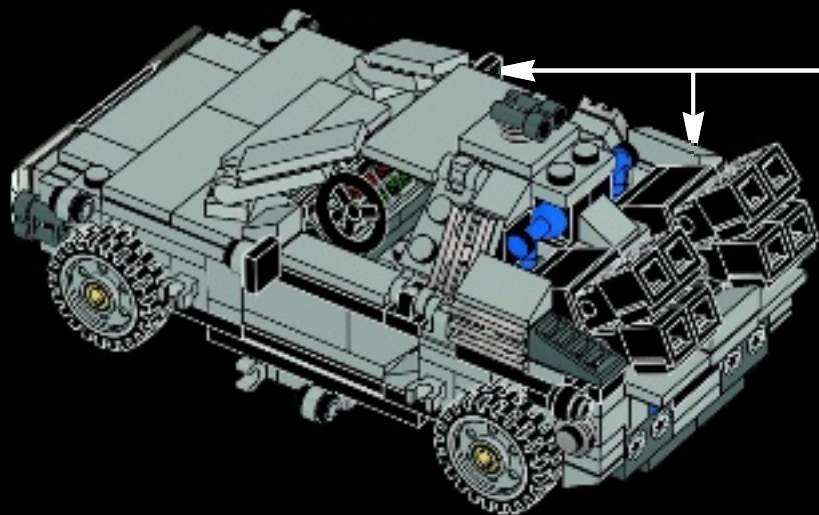

4x



1x

2x

1

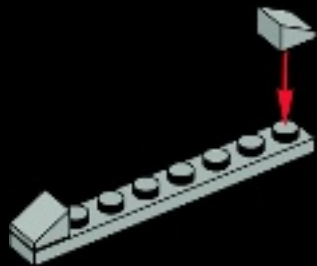

2x

2





3

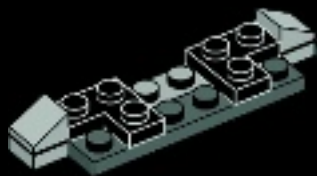

4

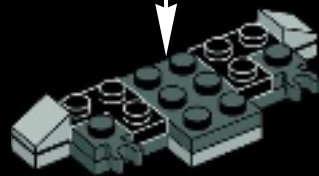
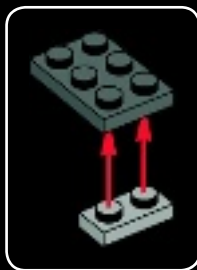



2x



2x



1x

5



1x



2x

6



In the first movie, the California license plate read 'OUTATIME.' When Doc returned from 2015, the license plate had become a barcode.



© 2013 Universal

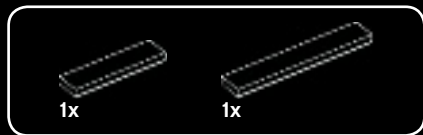

7

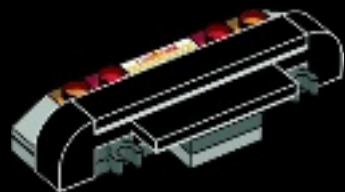

8



9



60

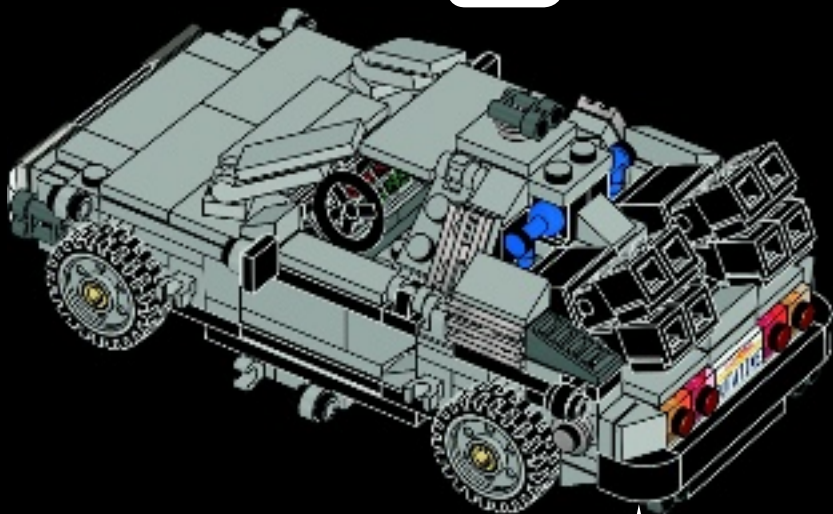



1x

2x

61

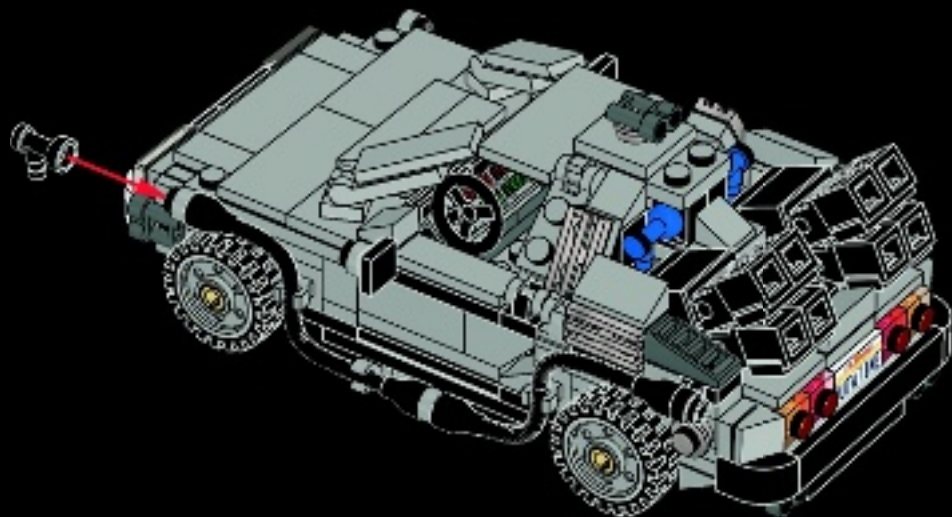



1x



2x

62

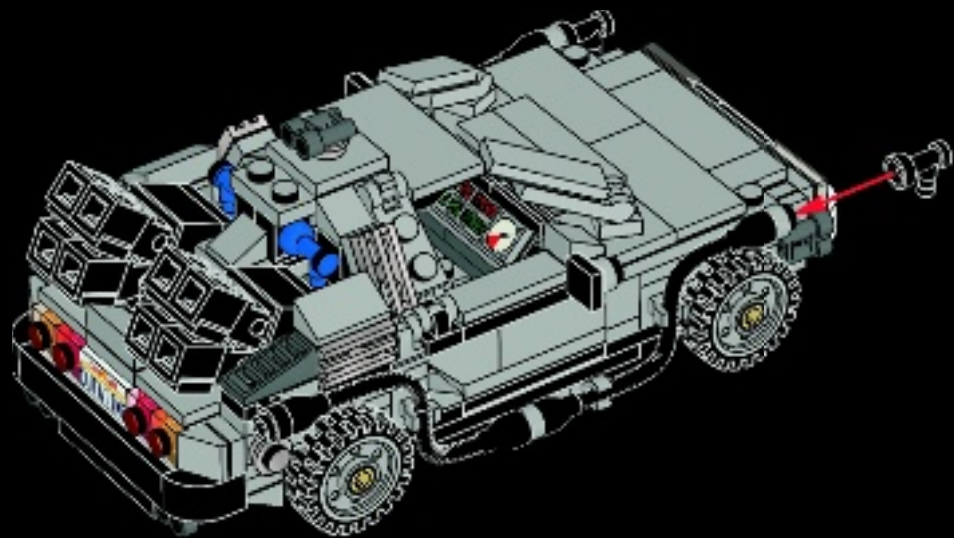

63



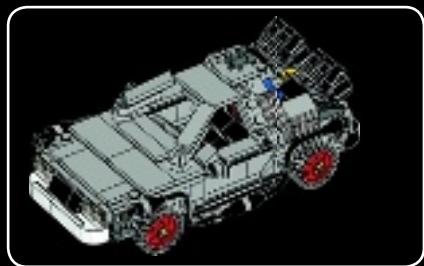

1

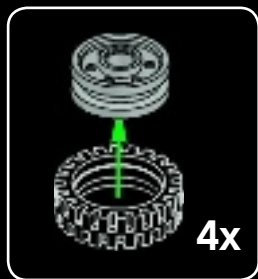
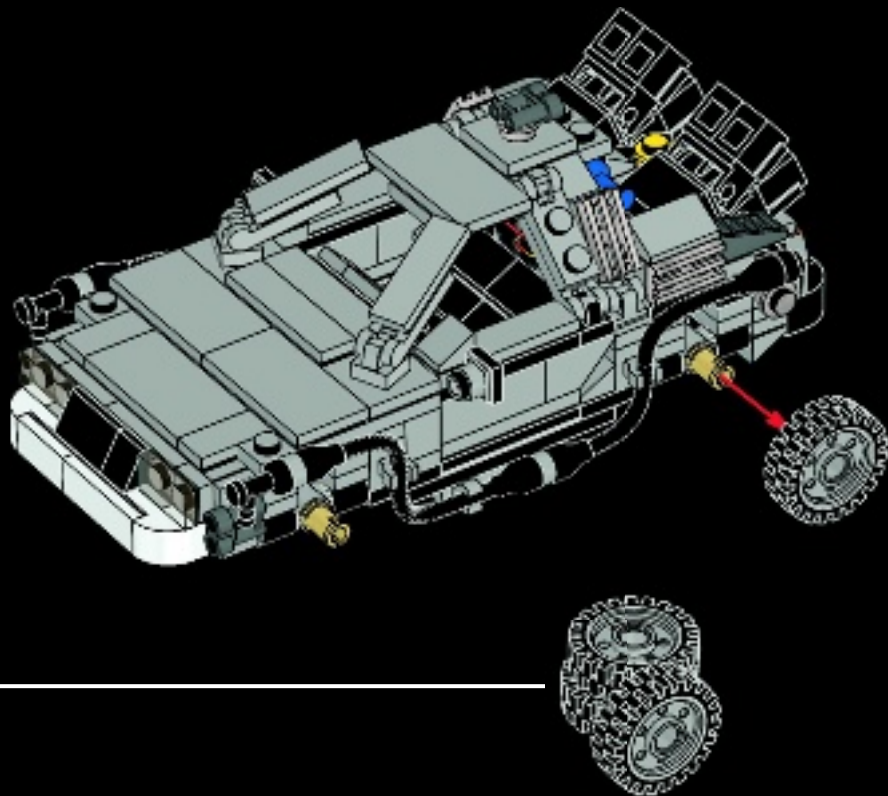



4x

2

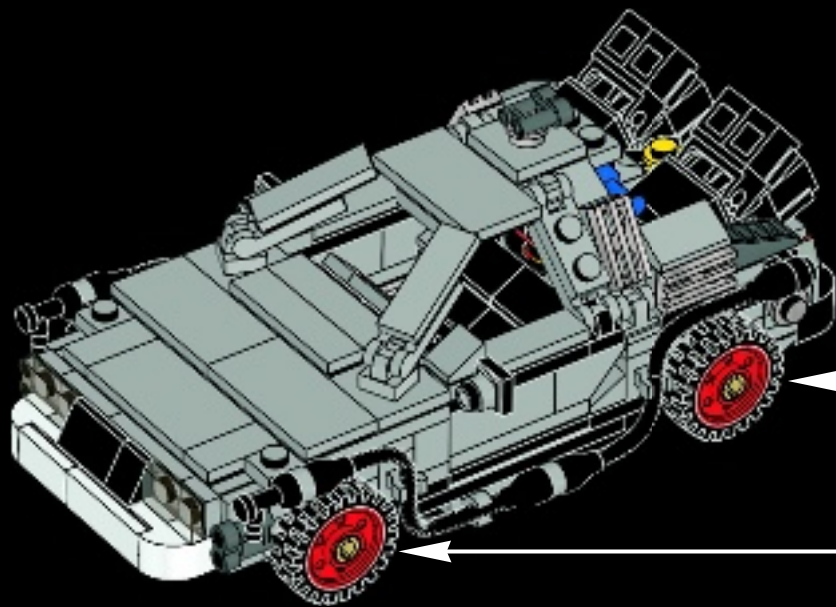

4x

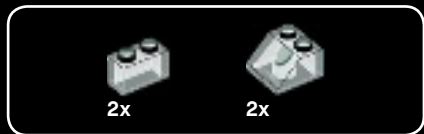
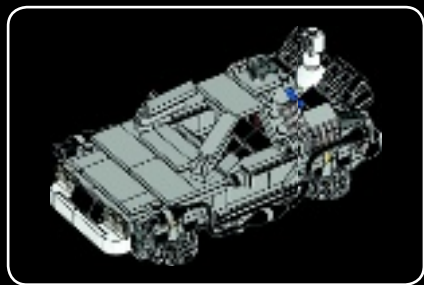

1

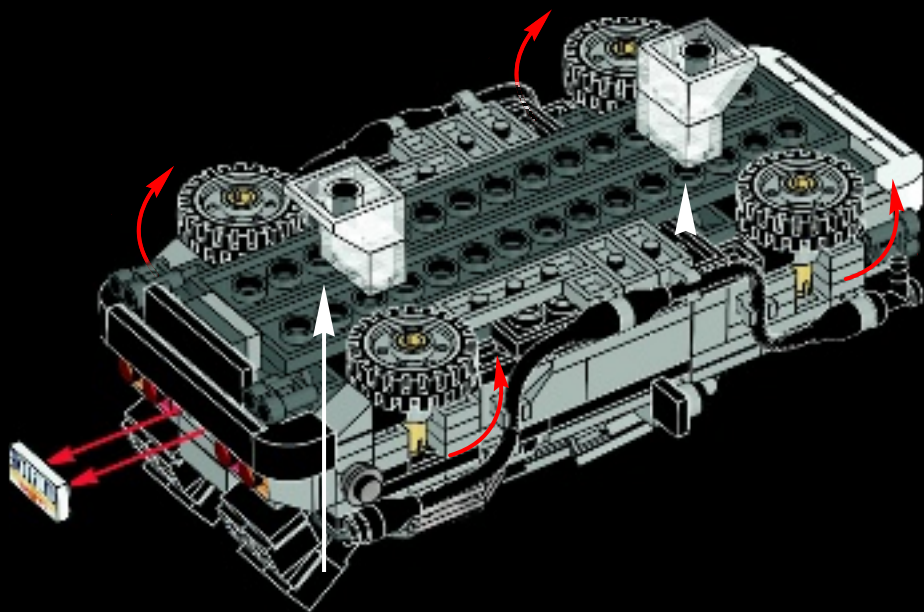
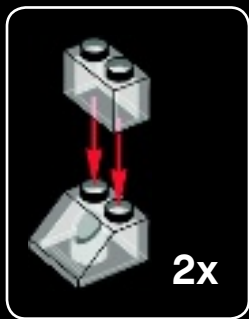



1x



2

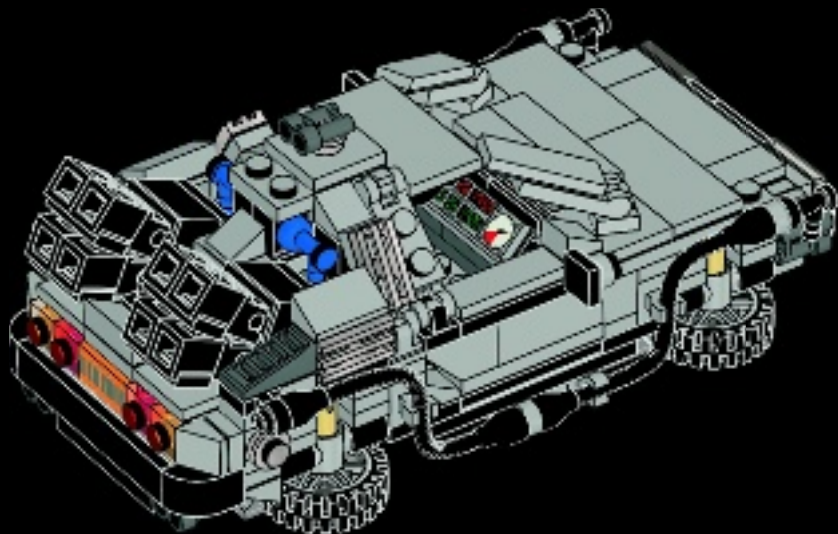



1x



1x



1x



1x



3

1



2

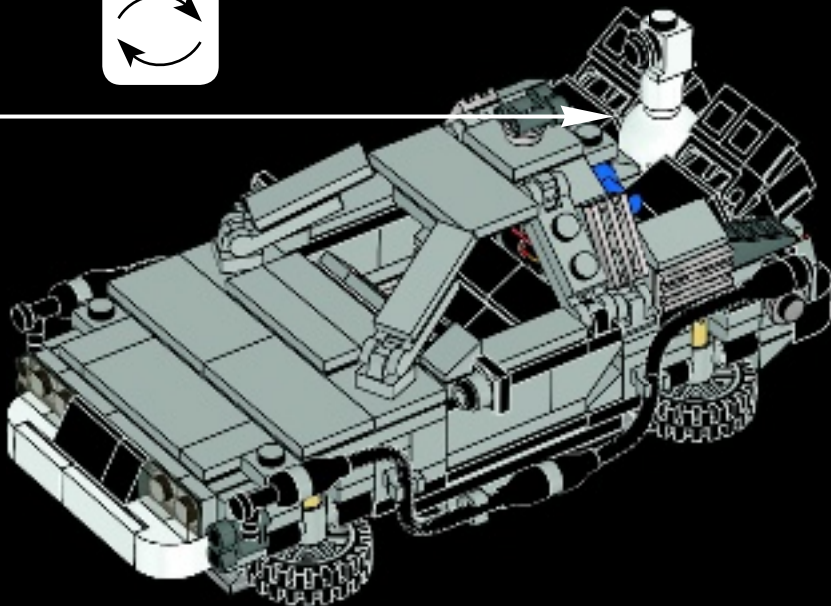
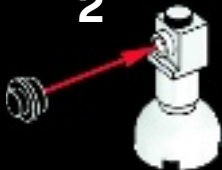

The "Mr. Fusion Home Energy Reactor" converts household waste into electrical power and is the key energy source for the 2015 version of the time machine.



© 2013 Universal

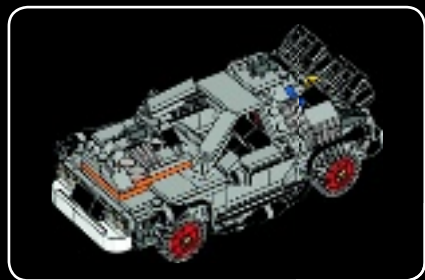

1

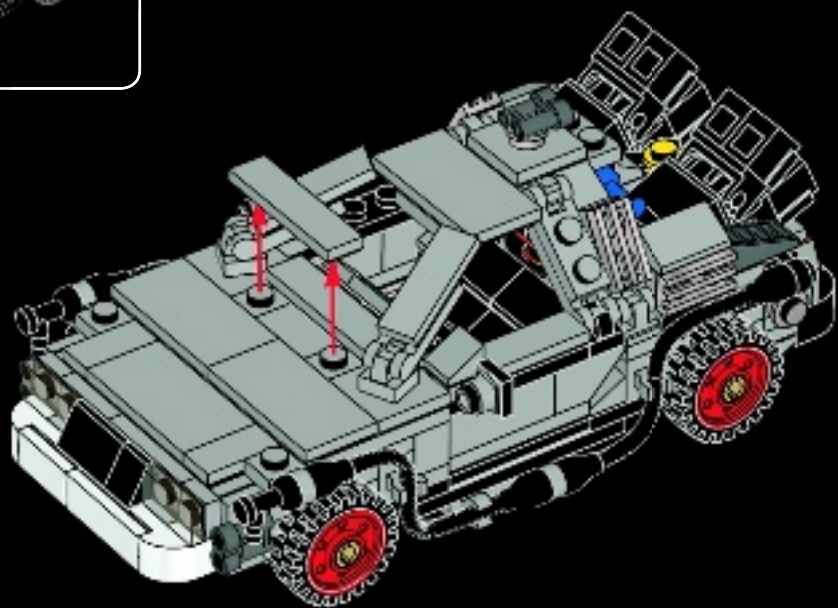



1



2





3



4





1x



1x



1x

5



2x



2x



1x

6





7



8

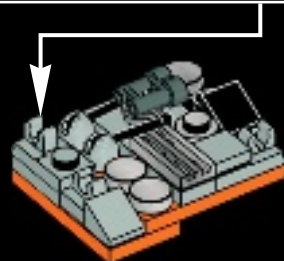
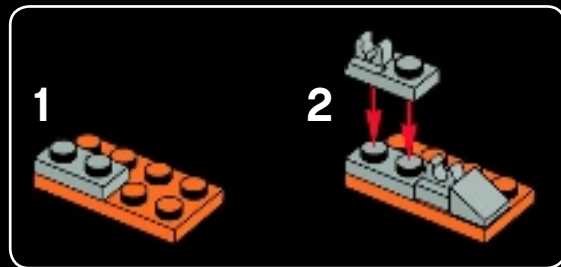

2

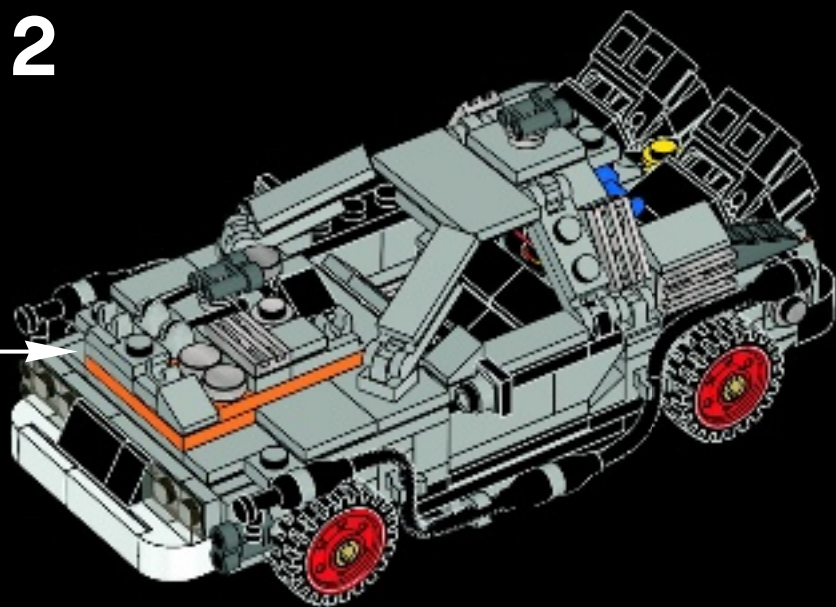

“IF YOU PUT YOUR MIND TO IT,

YOU CAN ACCOMPLISH ANYTHING”

Since I was a child, I have always felt that the time machine from Back to the Future, with its ability to let people travel through time, would be perfectly suited to the world of LEGO® building. As a child I often attempted to build the time machine, but back then I didn't have the right bricks or building skills.

Many years later I met Sakuretsu, a mini-figure builder from Japan. In the summer of 2011, we teamed up to submit the “BTTF Time Machine” to the LEGO Cusoo website. The road to gathering the required 10,000 supporters was long and hard. But thanks to Sakuretsu's enthusiasm and

Togami & Sakuretsu



the encouragement from various media sites and supporters, I was able to see my dream become an official LEGO product. Thinking about my life until now, I realize that I have always been led by the sayings in the Back to the Future movie:

“If you put your mind to it, you can accomplish anything. Your future is whatever you make it.”

*Masashi Togami
Founder of Team BTTF*

IT'S ABOUT COMING AS CLOSE TO THE REAL
THING AS POSSIBLE

Steen Sig Andersen has been a LEGO® model designer for over 30 years. It was his task to transform Togami & Sakuretsu's model into a true LEGO construction set. For Steen it was an enjoyable project, but also a challenging one:

“The original model was a great starting point and many of the ideas and details could be used directly in the final construction. One of the biggest challenges were the wheels: the model has both a “drive” and a “hover” mode, plus the construction also has to be robust enough so a minifigure can be placed in the vehicle. After some initial frustration, I eventually solved



Steen Sig Andersen

the problem by combining a system part with a relatively new Technic element (part 87082 Double bush 3M Ø4.9).”

“All in all, it was an exciting process and I'm glad to have had the chance to be a part of this Cuusoo project.”



LEGO.CUUSOO.COM A PLAYGROUND FOR

INNOVATIVE LEGO IDEAS

Do you have an exciting LEGO® idea? Then why not make it into a LEGO Cusoo project. You can share your product concept on lego.cusoo.com and see what other people think about it.

If your project gains 10.000 supporters, it will automatically qualify for the quarterly LEGO Review. This is where we take an in-depth look at the most popular projects and carefully evaluate them to discover the idea with the most potential. If your project makes it through the review, then it will become an official LEGO product.

There's already over 250.000 active users and 15.000 projects on the Cusoo website, and three LEGO Cusoo products have already been launched. So take a look, sign-up and support your favorite ideas, or even better: upload your own project!



1x
6051249
1x
407001
1x
306201
1x
4216652
1x
370101
2x
609101
2x
302301
1x
362301
1x
306901
1x
4558168

106

1x
9327
1x
6047095
1x
6047103
1x
4535553
1x
4212411
2x
306223
1x
4243815
2x
4613257
2x
459923
3x
4143005

1x
6030185
2x
4558886
2x
306221
1x
4243814
2x
4588003
3x
614121
1x
6047102
4x
6048859
1x
614124
2x
3000841

2x
307026
2x
6030718
2x
4632571
4x
300526
10x
407026
2x
4504382
5x
4548180
2x
303926
2x
609126
2x
302426
3x
302326

3x
302226
6x
242026
2x
362326
3x
371026
1x
302026
3x
379526
1x
614126
4x
4558850
1x
663626
1x
303626

2x
459926
8x
4142822
16x
4121715
1x
4153044
6x
306926
2x
4107761
2x
4225201
3x
243126
4x
393726
2x
249626
1x
403226

4x
4541455
4x
393826
2x
306540
2x
622740
4x
4514554
3x
4158355
1x
6055829
1x
4654448
1x
6047054
1x
6047052

6x
4211043



2x
4211056



1x
4211060



8x
4210762



2x
4587212



6x
4211051



2x
4540386



2x
4210796



1x
4211486



1x
4211407

1x
4211415



4x
4533772



16x
4521921



3x
4568637



2x
4211437



12x
4211399



2x
4255629



19x
4211398



5x
4211451



4x
4565393



8x
4211353



4x
4211397

3x
6030711



2x
4541978



6x
4632575



3x
4211414



4x
4598526



2x
4556157



2x
4255738



2x
4211413



8x
4515369



4x
4558169



5x
4211425

2x
4211389



8x
4211476



2x
4221775



4x
6044729



2x
4211469



2x
4211470



4x
4560175



1x
6051245



1x
6047090



2x
4211428

3x
4211429



4x
4211396



2x
4211356



4x
4560183



6x
4211445



1x
4211395



1x
4211438

1x
6047056



8x
4249039



3x
4655241



7x
4249040



2x
4542673



2x
4529685

Customer Service
Kundenservice
Service Consommateurs
Servicio Al Consumidor

LEGO.com/service or dial



: 00800 5346 5555

: 1-800-422-5346



**BACK
TO
THE FUTURE**

LEGO and the LEGO logo are trademarks of the LEGO Group. ©2013 The LEGO Group.

Back to the Future Films are trademarks and copyrights of Universal Studios and U-Drive Joint Venture.
Licensed by Universal Studios Licensing LLC. All Rights Reserved.



6096231