



CREATOR

5770



1

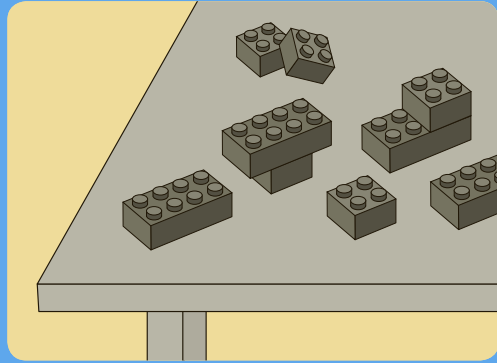
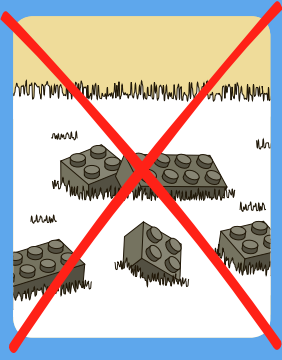

2



1:1
2X LR 41 1.5V

EN

Important information about batteries

Never use different types of batteries together, or a combination of old and new batteries. Always remove the batteries if the product is not to be used for a long time or if the batteries have run down. Never use damaged batteries. Only use batteries of the type recommended, or a corresponding type. Insert the batteries so that the poles are correctly positioned. Rechargeable batteries must be recharged using the correct battery charger under the supervision of an adult. You cannot recharge batteries while they are still in the product, and you must never try to do so. Never attempt to recharge non-rechargeable batteries. Never short-circuit the battery holder.

DE

Wichtige Information zu Batterien

Benutzen Sie niemals unterschiedliche Arten von Batterien oder alte und neue gleichzeitig. Nehmen Sie stets die Batterien heraus, wenn mit dem Modell längere Zeit nicht gespielt wird oder wenn die Batterien leer sind. Verwenden Sie niemals beschädigte Batterien. Verwenden Sie ausschließlich empfohlene bzw. geeignete Batterien. Achten Sie beim Einsetzen der Batterien auf die richtige Polung. Wiederaufladbare Batterien sollten mit einem geeigneten Ladegerät aufgeladen werden – unter der Aufsicht eines Erwachsenen. Batterien können und sollten niemals aufgeladen werden, während sie sich im Modell befinden. Versuchen Sie unter keinen Umständen, „normale“ Batterien wiederzuladen. Schließen Sie das Batteriefach niemals kurz.

FR

Informations importantes concernant les piles

Ne jamais utiliser un mélange de différents types de piles, ou de piles neuves et de piles anciennes ou déjà utilisées. Toujours retirer les piles si le produit n'est pas utilisé durant une période prolongée ou si les piles sont vides. Ne jamais utiliser de piles endommagées. Utiliser uniquement des piles du type recommandé ou d'un type équivalent. En insérant les piles, respecter scrupuleusement le sens d'orientation des pôles (+/-). Les piles rechargeables doivent être rechargées en utilisant un chargeur de piles adéquat et sous la surveillance d'un adulte. Il est impossible de recharger les piles quand elles sont installées dans le produit. Ne jamais tenter de le faire. Ne jamais essayer de recharger des piles non-rechargeables. Ne jamais court-circuiter le compartiment des piles.

IT

Importanti informazioni sulle batterie

Non usare mai contemporaneamente batterie di tipo diverso o batterie nuove e usate insieme. Rimuovere sempre le batterie qualora il prodotto non venga utilizzato per periodi prolungati, oppure se le batterie sono esauste. Non utilizzare mai batterie danneggiate. Usare esclusivamente batterie del tipo raccomandato o un equivalente. Inserire le batterie avendo cura che la loro polarità sia corretta. Le batterie ricaricabili vanno ricaricate in un caricabatterie di tipo idoneo e con la supervisione di un adulto. Non è possibile e non bisogna mai tentare di ricaricare le batterie mentre queste sono inserite nel prodotto. Non tentare mai di ricaricare le batterie non ricaricabili. Non cortocircuitare mai il portabatterie.

NL

Belangrijke informatie over batterijen

Gebruik nooit verschillende soorten of nieuwe en oude batterijen tegelijkertijd. Verwijder de batterijen altijd als je het product lange tijd niet wilt gebruiken of als de batterijen leeg zijn. Nooit beschadigde batterijen gebruiken. Uitsluitend batterijen van het aanbevolen of overeenkomstige type gebruiken. Leg de batterijen met de polen in de juiste richting. Oplaadbare batterijen moeten in een voor dit doel bestemde oplader en onder toezicht van een volwassene opnieuw worden opgeladen. Oplaadbare batterijen kunnen niet in het product worden opgeladen en je mag dit ook niet proberen te doen. Probeer nooit niet-oplaadbare batterijen op te laden. Nooit de batterijhouder kortsluiten.

ES

Importante información sobre las baterías

No mezclar nunca diferentes tipos de baterías, ni utilizar baterías antiguas y nuevas a la vez. Sacar siempre las baterías, si el producto no se utiliza por un largo periodo de tiempo o si las baterías están desgastadas. No utilizar nunca baterías dañadas. Utilizar solo el tipo de baterías recomendado o uno correspondiente. Colocar las baterías de manera que los polos están en su posición correcta. Las baterías recargables deben cargarse con un cargador adecuado bajo la supervisión de un adulto. Las baterías no pueden, ni deben recargarse mientras permanecen en el producto. No intentar nunca recargar baterías no recargables. Asegurarse que no se produzca un cortocircuito en el porta baterías.

DA

Vigtig information om batterier

Brug aldrig forskellige typer batterier sammen, eller nye og gamle batterier samtidig. Tag altid batterierne ud, hvis du ikke skal bruge produktet i længere tid, eller hvis batterierne er brugt op. Anvend aldrig beskadigede batterier. Der må kun anvendes batterier af samme eller tilsvarende type som anbefalet. Batterierne skal vende rigtigt når de i sættes. Genopladelige batterier skal oplades i en dertil beregnet oplader under opsyn af en voksen. Genopladelige batterier kan og må ikke forsøges opladet i produktet. Forsøg aldrig at genoplade ikke-genopladelige batterier. Kortslut aldrig batterikassens kontaktklæder.

FI

Tärkeää tietoa paristoista

Älä koskaan käytä erityyppisiä paristoja yhdessä. Älä myöskään käytä samassa laitteessa sekä vanhoja että uusia paristoja. Poista paristot tuotteesta aina, kun se on pitemmän aikaa käytettämättä, tai kun paristot ovat tyhjentyneet. Älä koskaan käytä viallisia paristoja. Käytä vain tuotteessa suositeltuja tai vastaavatyypisiä paristoja. Aseta paristot siten, että navat osoittavat oikeaan suuntaan. Ladattavat paristot on ladattava oikeanlaisella laaturilla aikuisen valvonnassa. Ne on poistettava tuotteesta lataamisen ajaksi. Älä koskaan yritä ladata paristoja, joita ei ole tarkoitettu ladattaviksi. Älä koskaan aiheuta oikosulkua pariston kosketintien välillä.

SV

Viktig information om batterier

Använd aldrig olika sorters batterier samtidigt, och inte heller en kombination av gamla och nya batterier. Ta alltid ur batterierna om produkten under en längre tid inte ska användas eller om batterierna är slut. Använd aldrig skadade batterier. Använd bara batterier av den typ som rekommenderas, eller av en motsvarande utv. Sätt i batterierna så att polerna hamnar i rätt läge. Laddningsbara batterier måste laddas med rätt slags batteriladdare och under en vuxens överinnsyn. Du kan inte ladda batterierna medan de fortfarande sitter i produkten, och du får heller aldrig försöka göra det. Försök aldrig ladda icke-laddningsbara batterier. Kortslut aldrig batteriutrymmets kontaktytor.

PT

Informações importantes acerca das pilhas

Nunca use tipos diferentes de pilhas em conjunto, nem uma combinação de pilhas velhas e novas. Retire sempre as pilhas se o produto não vai ser utilizado durante muito tempo ou se as pilhas se tiverem gasto. Nunca use pilhas danificadas. Use apenas pilhas do tipo recomendado ou de um tipo correspondente. Introduza as pilhas de forma a que os seus pólos fiquem correctamente posicionados. Pilhas recarregáveis deverão ser recarregadas utilizando o recarregador de pilhas correcto sob a supervisão de um adulto. Não é possível recarregar pilhas recarregáveis enquanto elas ainda se encontram dentro do produto, e nunca devem ser feitas tentativas nesse sentido. Nunca tente recarregar pilhas não recarregáveis. Nunca faça curto-circuito do compartimento das pilhas.

EL

Σημαντικές πληροφορίες για τις μπαταρίες

Μη χρησιμοποιείτε ποτέ διαφορετικούς τύπους μπαταριών, ή παλιές και καινούριες μπαταρίες μαζί. Βγάζετε πάντα τις μπαταρίες αν δεν χρησιμοποιήσετε το προϊόν για αρκετό καιρό ή αν οι μπαταρίες έχουν αδειάσει. Ποτέ μη χρησιμοποιείτε χαλασμένες μπαταρίες. Χρησιμοποιείτε μόνο μπαταρίες του συνιστώμενου τύπου, ή αντίστοιχου τύπου. Βάλτε τις μπαταρίες με την σωστή πολικότητα. Θα πρέπει να φορτίσετε τις επαναφορτιζόμενες μπαταρίες χρησιμοποιώντας τον κατάλληλο φορτιστή μπαταριών υπό την επίβλεψη ενός ενήλικου. Δεν μπορείτε να επαναφορτίσετε τις μπαταρίες όταν αυτές βρίσκονται μέσα στο προϊόν, και ποτέ μη επιχειρήσετε να κάνετε κάτι τέτοιο. Μη επιχειρήσετε ποτέ να επαναφορτίσετε μη επαναφορτιζόμενες μπαταρίες. Ποτέ μη βραχυκυκλώνετε τη θήκη των μπαταριών.

JA

電池の取り扱いに関する注意

異なるタイプの電池や、古い電池と新しい電池を混ぜて使用しないで下さい。長時間商品を使用しない時や電池が切れた時は、必ず電池を取り外してください。電池は推奨されている種類か、もしくは対応する種類のみを使用してください。電極を損傷して正しい方向に電池を入れてください。充電電圧を使用する際は保護者の監督の下、正しく充電をして使用してください。商品の型に入れたまま電池を充電することは絶対に避けてください。充電電圧のない電池を充電したり、電極をショートさせたりしないでください。

ZH

電池使用須知

切勿將不同種類的電池一起使用，亦不要把舊電池與新電池混合使用。如有一段長時間不會使用本產品或電池已耗盡，請把電池拆除。切勿使用已損壞之電池。只可使用建議中之電池型號，或其他兼容式型號。請根據指示安裝電池。

你可以使用充電的循環電池，但必須採用適當的充電器，並在成年人的指導下才可進行充電。電池仍在產品內是不能充電的，請勿強行嘗試。切勿試圖為非循環電池充電。亦切勿自行接駁電池箱的兩極，以免產生短路。

KO

간전지 사용시 주의 사항

다른 전지(과), 또는 새 전지와 구 전지를 혼용해서 사용하지 마십시오. 전기간 제품을 작동하지 않을 경우에는 전지를 제품에서부터 제거해 주십시오. 재생가능전지(rechargeable battery)는 어떤 용제 하여 충전이 이루어져야 합니다. 또한 재생가능전지(rechargeable battery)는 제품 안에서 충전을 할 수 없으므로, 정대로 충전해서만 충전됩니다. 그리고, 재생가능전지(rechargeable battery)가 아닌 전지들 충전에서는 안됩니다.

RU

Необходимая информация об элементах питания

Ни в коем случае не используйте одновременно элементы питания различных типов, а также элементы питания с разным сроком годности. В обязательном порядке вынимайте элементы питания из терминалов в случае, если вы не пользуетесь прибором в течение долгого времени либо в случае, если в элементах питания закончился заряд. Ни в коем случае не используйте поврежденные элементы питания. Используйте только рекомендуемые элементы питания, либо элементы питания соответствующего типа. Установите элементы питания, соблюдая указанную полярность. Аккумуляторные элементы питания должны подзаряжаться в соответствующем зарядном устройстве под наблюдением взрослого. Ни в коем случае не пытайтесь подзарядить элементы питания, находящиеся в приборе. Ни в коем случае не пытайтесь подзарядить неперезаряжаемые элементы питания. Ни в коем случае не пытайтесь замкнуть полюса в устройстве для элементов питания.

PL

Ważne informacje dotyczące baterii

Nigdy nie należy stosować razem różnych rodzajów baterii ani stosować równocześnie starych i nowych baterii. Jeżeli produkt nie jest używany przez dłuższy czas lub jeżeli baterie się wyczerpały, należy wyjąć baterie. Nigdy nie należy stosować uszkodzonych baterii. Należy stosować wyłącznie zalecany rodzaj baterii lub rodzaj mu odpowiadający. Przy wkładaniu baterii należy zwrócić uwagę na właściwe położenie biegunów. Baterie akumulatorowe należy ładować w odpowiedniej ładowarce pod nadzorem osoby dorosłej. Nie można naładować baterii bez wyjścia ich z produktu i nigdy nie należy tego próbować. Nigdy nie należy próbować ładowania baterii jednorazowych. Nigdy nie należy doprowadzać do zwarcia w gnieździe baterii.

CZ

Důležitá informace o bateriích

Nikdy nepoužívejte najednou různé typy baterií nebo kombinaci starých a nových baterií. Nebudete-li výrobek delší dobu používat nebo jsou-li baterie vybité, vždy je vyjměte z výrobku. Nikdy nepoužívejte poškozené baterie. Používejte pouze doporučené nebo odpovídající typy baterií. Baterie instalujte se správnou orientací pólů. Nabíjecí baterie musí být nabity ve vhodné nabíjecí pod dohledem dospělé osoby. Nabíjecí baterie nelze nabíjet, jsou-li umístěny ve výrobku, a nesmíte se o to ani pokoušet. Nikdy se nesnažte nabíjet baterie, které nejsou nabíjecí. Nikdy nezkratujte kontakty v prostoru pro baterie.

SK

Dôležitá informácia o batériách

Nikdy nepoužívajte naraz odlišné typy batérií ani nekombinujte staré batérie s novými. Batérie vždy vyberte, ak sa výrobok nebude dlhšie používať, alebo ak sa batérie vybiti. Nikdy nepoužívajte poškodené batérie. Používajte len odporúčané alebo zodpovedajúce typy batérií. Batérie vkladajte so správnou orientáciou pólů. Dobíjateľné batérie sa musia nabíjať vo vhodnom nabíjači pod dozorom dospelého osoby. Dobíjateľné batérie sa nesmú nabíjať, ak sú umiestnené vo výrobku, a nesmiete sa o to ani pokúšať. Nikdy sa nesnažte nabíjať batérie, ktoré nie sú dobíjateľné. Nikdy neskratujte kontakty v priestore pre batérie.

HU

Fontos tudnivalók az elemekről

Soha ne használjunk különböző típusú elemeket, illetve ne használjunk új és használt elemet egyszerre. Mindig távolítsuk el az elemeket, ha a készüléket előre láthatóan hosszú ideig nem fogjuk használni, vagy ha az elemek lemerültek. Soha ne használjunk megromlódott elemet. Csak az ajánlott típusú, vagy annak megfelelő elemet használjunk. Az elemeket a polaritásuknak megfelelő módon helyezzük be. Az akkumulátorokat csak a megfelelő akkumulátortöltővel szabad feltölteni, egy felnőtt segítségével felügyelet mellett. Az akkumulátorokat nem tölthetjük fel úgy, hogy azok a termékben vannak, ezt meg sem szabad próbálnunk. Soha ne próbáljuk meg feltölteni a nem tölthető elemet. Soha ne hozzunk létre rövidzárlatot az elemartó kivételezei között.

UA

Необхідна інформація про батареї

Ніколи не використовуйте одночасно батареї різних типів або батареї з різним строком зживання. Обов'язково виймайте батареї з прибору якщо довгочасно не користуєте їм, або якщо в батареї вже скінчився заряд. Ніколи не використовуйте пошкоджені батареї. Використовуйте батареї лише рекомендованого або відповідного типу. Вставляйте батареї, враховуючи задану полярність. Акумуляторні батареї повинні заряджатися у відповідному зарядному приладі під наглядом дорослого. В будь-якому випадку не намагайтеся підзарядити батареї, що знаходяться в приборі. В будь-якому випадку не намагайтеся підзарядити батареї, що не підлягають підзарядці. В будь-якому випадку не намагайтеся зроби коротке замикання в приладі для батарей.

HR

Važne informacije o baterijama

Nikada ne koristite različite vrste baterija zajedno, kao niti kombinaciju starih i novih baterija. Uvijek izvadite baterije ako uređaj neće biti korišten duže vrijeme ili ako su baterije prazne. Nikada ne koristite oštećene baterije. Upotreblijavajte samo preporučenu vrstu baterija ili njima ekvivalentni tip. Umetnite baterije tako da su im polovi ispravno orijentirani. Baterije koje se mogu puniti moraju biti punjene u odgovarajućem punjaču baterija pod nadzorom odrasle osobe. Ne možete puniti baterije dok su umetnute u uređaj i to nikada niti ne pokušavajte. Nikada ne pokušavajte napuniti baterije koje se ne mogu puniti. Nikada kratkim spojem ne spajajte polove baterija.

SR

Важне информације о батеријама

Nikada ne koristite različite tipove baterija zajedno, i ne kombinujte stare baterije sa novima. Uvek izvadite baterije ukoliko proizvod neћete koristiti duže vreme ili ako su se baterije ispraznile. Nikada ne upotrebljavajte oštećene baterije. Koristite isključivo tip baterija koji se preporučuje ili odgovarajuću zamenu. Prilikom stavljanja baterija pazite da polovi budu pravilno postavljeni. Baterije na punjeње se moraju puniti uz upotrebu određenog punjača i pod nadzorom odrasle osobe. Baterije se ne mogu puniti dok su u proizvodu, i to ne smete ni da pokušavate. Nikada ne pokušavajte da napunite baterije koje se ne pune. Nikada ne prespajate polove kućišta za baterije.

SL

Pomembna informacija o baterijskih vložkih

Nikoli ne uporabite različne vrste baterijskih vložkov skupaj ali pa nove vložke skupaj z rabljenimi. Če so baterijski vložki izpraznili ali če izdelka ne boste uporabljali dlje časa, morate vložke vedno odstraniti. Nikoli ne uporabite poškodovanih baterijskih vložkov. Uporabite samo priporočen tip baterijskih vložkov ali enakovredne vložke. Baterijske vložke vstavite tako, da sta pola plus in minus pravilno usmerjena. Baterijske vložke za ponovno polnjenje morajo otroci polniti z ustreznim polnilcem samo pod nadzorom odrasle osebe. Pred polnjenjem morate vložke vedno izvleči iz igrače. Nikoli ne smete polniti baterijskih vložkov, medtem ko so še vedno v igračih. Nikoli ne poskušate polniti baterijske vložke, ki niso namenjeni za ponovno polnjenje. V prostoru za baterijske vložke ne smete nikoli povzročiti kratkega stika.

RO

Informații importante cu privire la baterii

Nu folosiți niciodată împreună tipuri diferite de baterii și nici combinații de baterii noi și vechi. Îndepărtați întotdeauna bateriile dacă produsul nu este folosit timp îndelungat sau dacă bateriile s-au epuizat. Nu folosiți niciodată baterii deteriorate. Folosiți numai baterii de tipul recomandat, sau de un tip corespunzător. Introduceți bateriile astfel ca poli să fie în poziție corectă. Bateriile reîncărcabile trebuie reîncărcate utilizând un dispozitiv de încărcare adecvat, sub supravegherea unui adult. Bateriile nu pot fi reîncărcate cât timp sunt încă în produs, și nu încercați niciodată să le încărcați astfel. Nu încercați niciodată să reîncărcați baterii care nu sunt reîncărcabile. Nu scurtcircuitați niciodată bornele suportului bateriei.

BG

Важна информация за батерии

Не използвайте различни типове батерии едновременно, нито комбинация от стари и нови батерии. Винаги изваждайте батериите, ако izdelieto няма да се използва продължително време или ако батериите са се изтозили. Не използвайте повредени батерии. Използвайте само батерии от препоръчания тип или съответстващ на него тип. Поставете батериите така, че полюсите да са разположени правилно. Аккумуляторните батерии трябва да се зареждат с подходящо зареждащо устройство под надзора на възрастни. Батериите не могат да се зареждат, докато са поставени в izdelieto, така че не трябва да се опитвате да правите това. Не се опитвайте да зареждате батерии, които не са акумулаторни. Не свързвайте в късо съединение клемите на батериите.

LV

Svarīga informācija par barošanas elementiem

Nekad vienlaikus nelietojiet dažādu tipu, kā arī jaunas un vecas barošanas elementus. Arvien izņemiet barošanas elementus, ja tie izžādējušies vai to darbīnātais izstrādājums ilgāku laiku netiek lietots. Nekad nelietojiet bojātus barošanas elementus. Lietojiet tikai ieteicamā tipa barošanas elementus vai tiem atbilstošus analogus. Ievietojiet barošanas elementus, jāievēro pareiza to pievienojuma polaritāte (+/-). Uzšādējamu barošanas elementu lādēšanai jāizmanto atbilstošs barošanas elementu lādētājs, uzšādēšana jāveic pieaugušo uzraudzībā. Izstrādājumā ievietotus barošanas elementus uzšādēt nav iespējams, mēģinājumi to darīt nav pieļaujami. Nekad nemēģiniet uzšādēt neuzšādējamus barošanas elementus. Nekad nepieļaujiet īsslēgumu starp barošanas elementu tilpnes kontaktiem.

ET

Oluline teave patareide kohta

Mitte kunagi ära pane mänguasja sisse koos erinevat tüüpi patareisid, samuti vanu ja uusi patareid. Kui mänguasja ei kasutata pika aja jooksul, võta patareid sellest välja. Ka tühjaksaanud patareid tuleb mänguasjast välja võtta. Ära kasuta kahjustatud patareisid. Kasuta ainult ettenähtud tüüpi või neile samaväärsed patareisid. Pane patareid mänguasja sisse nii, et plus- ja miinuslelmi asend oleks õige. Akusid tuleb laadida ainult nendele ettenähtud akulaadija abil täiskasvanu järelevalve all. Akusid ei saa laadida sel ajal, kui need on mänguasja sees. Ära kunagi püüa nii teha. Ära mitte kunagi proovi akulaadijaga laadida talvisi patareisid. Patareipesa klemmide vahel ei tohi tekkida lühisid.

LT

Svarbi informacija apie elementus

Nesinaudokite vienu metu skirtingų tipų elementais, taip pat su naujais elementais nenaudokite senų elementų. Išimkite elementus iš įdėklo, jeigu nesinaudosite gaminiu ilgą laiką arba jeigu elementai išsisekvojo. Nesinaudokite sugadintais elementais. Naudokitės tik rekomenduojamo arba atitinkamo tipo elementais. Įdėkite elementus taip, kad atitiktų teigiamai ir neigiamai poliai. Akumuliatorinius elementus galima įkrauti tik tinkamu elementų krovikliu, prižiūrint suaugusiems. Elementų negalima įkrauti, neišėmus jų iš dėklo, ir nebandykite to daryti. Nebandykite įkrauti neakumuliatorinio tipo elementų. Nedarykite trumpo jungimo elementų įdėkle.

TR

Piller hakkında önemli bilgiler

Hicbir zaman değişik tipte pilleri ya da eski pillerle yeni pilleri bir arada kullanmayın. Pili ürün uzun süre kullanılmayacaksa ya da piller bitmişse, pilleri çıkarın. Hicbir zaman zedelemiş piller kullanmayın. Yalnız önerilen tipte piller ya da bunların dengi olan piller kullanın. Pilleri kutupları doğru konumda olacak şekilde yerleştirin. Bitince yeniden doldurulabilen piller doğru pil doldurucuyu kullanarak, bir yetiştirici denetimli altında doldurulmalıdır. Doldurulabilir pilleri ürünü içindeyken dolduramazsınız; hiçbir zaman bunu yapmaya çalışmayın. Hicbir zaman, bitince doldurulamayan tip pilleri yeniden doldurmayla çalışmayın. Hicbir zaman pil kutusuna kısa devre yapurtmayın.



EN Protect the environment by not disposing of this product with your household waste (2002/96/EC). Check with your local authority for recycling advice and facilities.

DE Schützen Sie die Umwelt und entsorgen Sie dieses Produkt nicht mit Ihrem Hausmüll (2002/96/EC). Informationen zu Recycling-Möglichkeiten erhalten Sie bei den örtlichen Behörden.

FR Protégez l'environnement : ne jetez pas ce produit avec vos autres déchets ménagers (Directive européenne 2002/96/EC). Contactez les autorités locales pour obtenir des informations sur le recyclage et connaître les points de collecte.

IT Proteggi l'ambiente! Non smaltire questo prodotto con i rifiuti domestici (2002/96/EC). Per consulenza sul riciclaggio dei rifiuti e le strutture di riciclaggio, rivolgersi alle proprie autorità locali.

NL Bescherm het milieu: gooi dit product niet samen met het andere huisvuil weg (2002/96/EC). Raadpleeg de plaatselijke instanties voor locaties van milieustations en advies over hergebruik.

ES Proteja el medio ambiente no deshaciéndose de este producto junto con sus residuos domésticos (2002/96/EC). Solicite a su autoridad local consejos e información sobre instalaciones de reciclado.

DA Beskyt miljøet! Smid ikke dette produkt ud sammen med husholdningsaffaldet (2002/96/EF). Få vejledning om genbrug og genbrugsstationer hos din kommune.

FI Tämä tuote on hävitettävä ympäristönsuojelun vuoksi asianmukaisesti talousjätteistä erillään (2002/96/EC). Tietoa kierrätyspisteiden sijainnista saa kunnan tai kaupungin teknisestä virastosta.

SV Skydda miljön genom att inte kasta denna produkt bland ditt hushållsavfall (2002/96/EC). Kontakta din kommun för frågor om återvinning och miljöstationer.

PT Proteja o ambiente não eliminando este produto com o seu lixo doméstico (2002/96/CE). Consulte as autoridades locais para informação sobre reciclagem e sistemas de recolha.



EL Προστατέψτε το περιβάλλον. Μην πετάτε αυτό το προϊόν μαζί με τα συνηθισμένα οικιακά απορρίμματα (2002/96/EC). Επικοινωνήστε με τις τοπικές αρχές σχετικά με συμβουλές και εγκαταστάσεις ανακύκλωσης.

PL Aby chronić środowisko naturalne, nie należy wyrzucać tego produktu wraz z odpadkami z gospodarstwa domowego (2002/96/WE). W celu uzyskania wskazówek dotyczących recyklingu oraz adresów zakładów należy skontaktować się z lokalnym urzędem.

CZ Nevyhazujte tento produkt do domácího odpadu, chraňte životní prostředí (2002/96/EC). Zjistěte si prosím u místních úřadů možnosti recyklace a dostupná zařízení.

SK Nevyhadzujte tento produkt do domáceho odpadu, chráňte životné prostredie (2002/96/EC). Zistite si prosím na miestnych úradoch možnosti recyklácie a dostupné zariadenia.

HU Környezetét óvja, ha ettől a terméktől nem a háztartási hulladékkal együtt válik meg (2002/96/EC). Érdeklődjék a lakóhelyéhez közel eső hatóságánál az újrahasznosítás módjáról és lehetőségéről.

SL Zaščitite okolje! Okolje varujte tako, da tega izdelka ne zavrzete skupaj z gospodinjstskimi odpadki (v skladu z direktivo 2002/96/ES). Pri krajevni upravi preverite, kakšne možnosti in kateri obrati za recikliranje obstajajo v vaši okolici.

LV Lai saudzētu vidi, neizmetiet šio izstrādājumu kopā ar sadzīves atkritumiem (2002/96/EC). Vērsieties vietējās varas iestādēs, lai noskaidrotu, kur un kā tas nododams pārstrādei.

ET Keskkonda saate kaitsta nii, et ei kõrvalda seda toodet koos olmejäätmetega (2002/96/EÜ). Nõuandeid toote taaskasutusse võtmise ja ümbertöötlemispunktide kohta saate asjaomasele kohalikult asutusele.

LT Saugokite aplinką – nemeskite šio produkto kartu su buitineis atliekomis (2002/96/EB). Atsižvelkite į savo vietos valdžios rekomendacijas dėl pakartotinio panaudojimo ir sąlygas.



Quick Build

Anfängermodelle
Construction Facile
Construcción rápida
Construção Rápida
Egyszerűen és gyorsan - kezdőknek



Experienced Build

Fortgeschrittenenmodelle
Construction
moyenne
Construcción
de nivel intermedio
Construção
Intermédia
Egyszerűen
és gyorsan - gyakorlóknak



Advanced Build

Profimodelle
Construction avancée
Construcción de nivel avanzado
Construção Avançada
Egyszerűen és gyorsan - tapasztalt építőknek



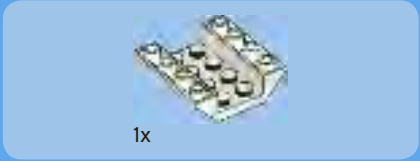

1

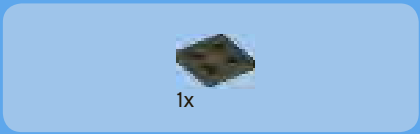

2

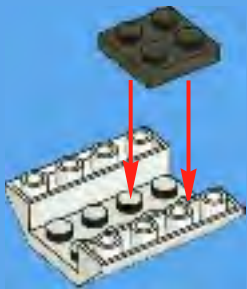



1x



1x

3



2x



1x



1x



1x

4



1x



1x



1x

5

1



2



3



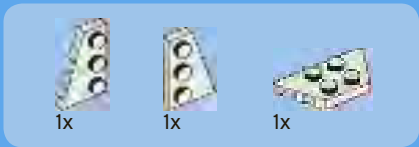

6



7

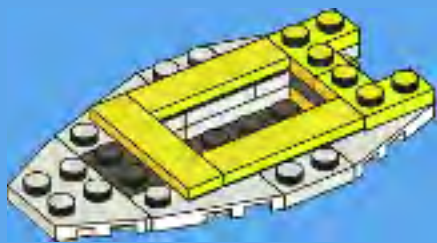

8

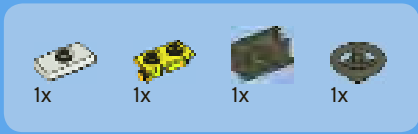

9

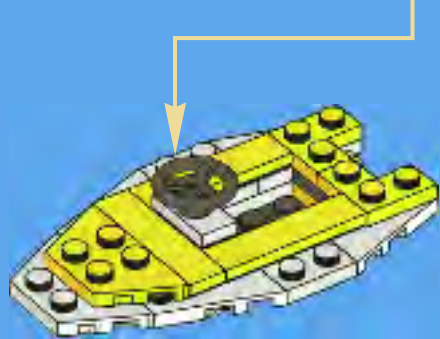



1x



2x

10



1x



1x



2x



1x



1x



1x



1x



1x

12

1



4



2



5

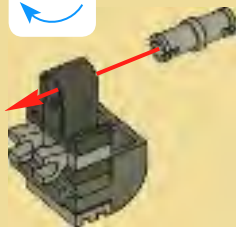

3



6



1x

11

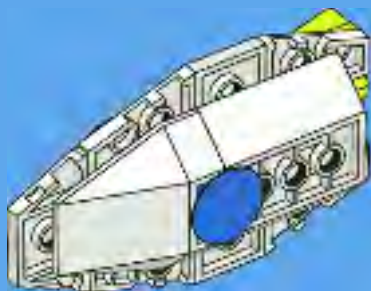



2x

1

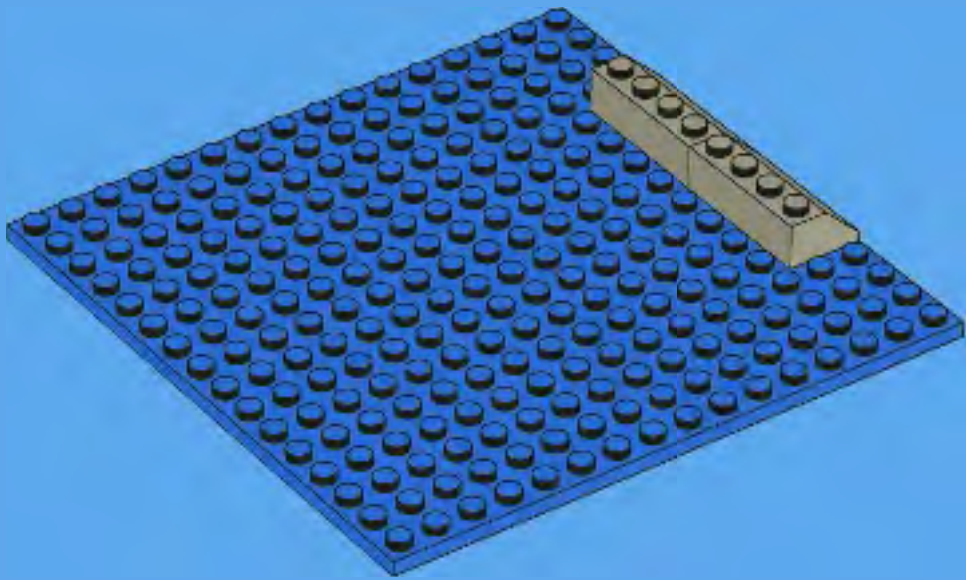



1x



2x

2

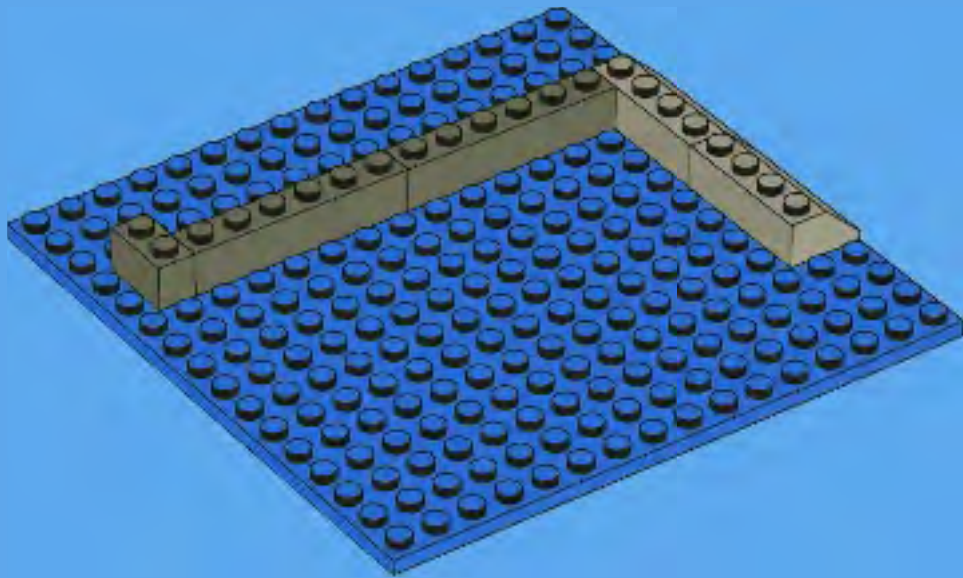

1x



2x



1x

3

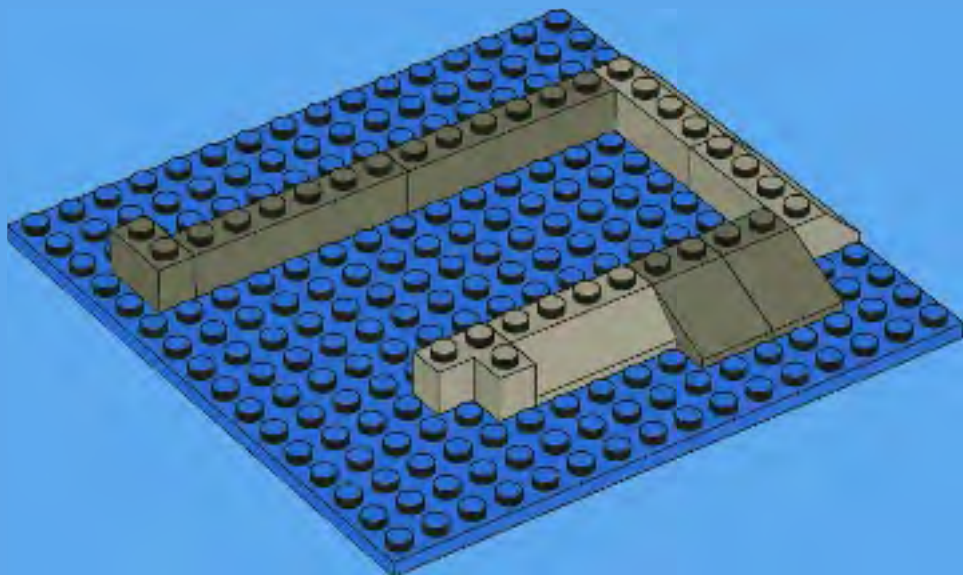

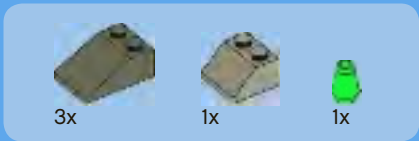

4

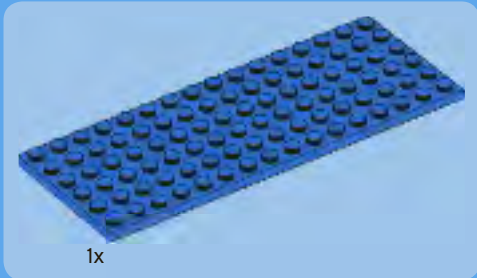
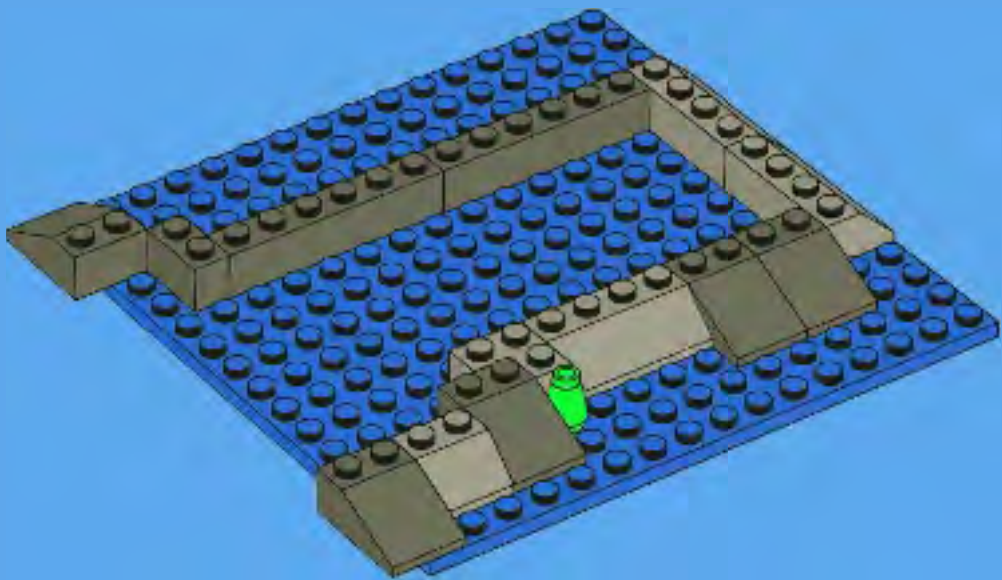

5



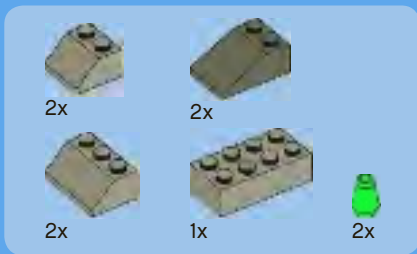

6

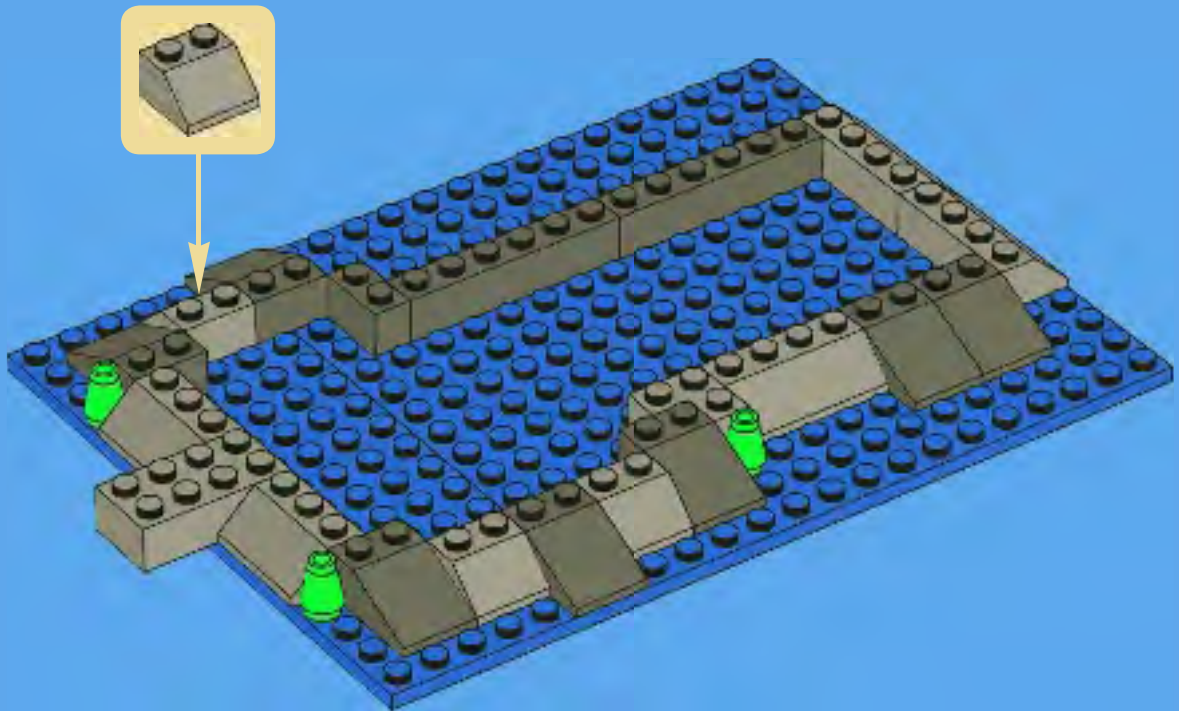



1x

7

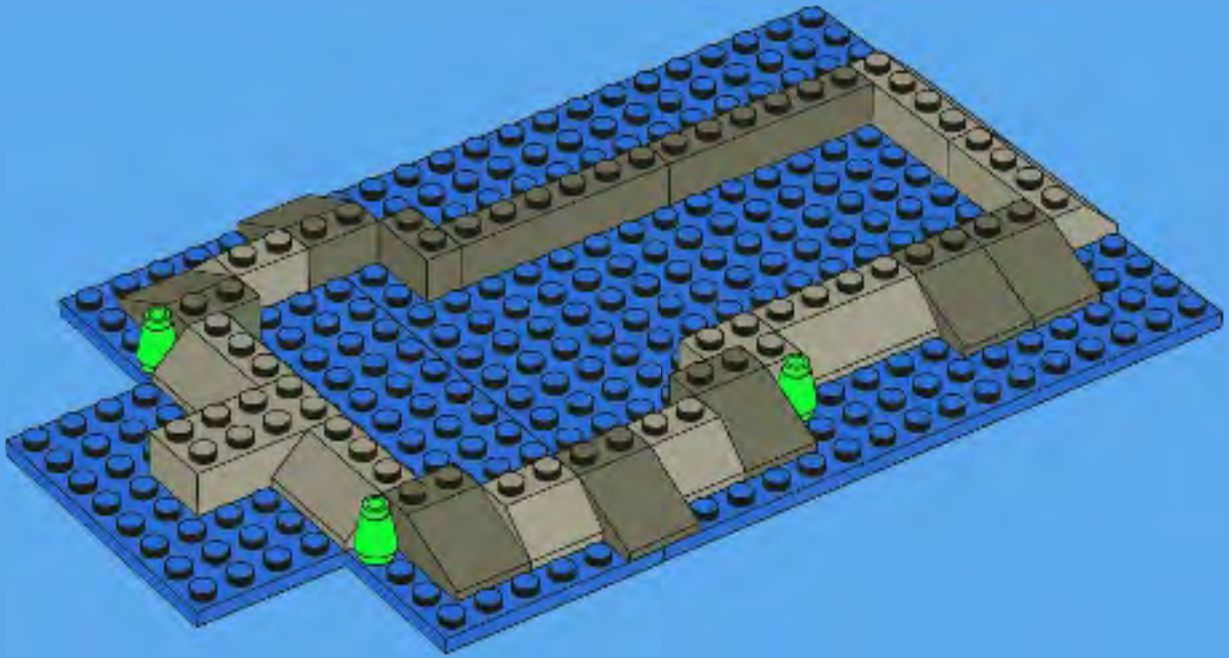

2x



1x



2x

8

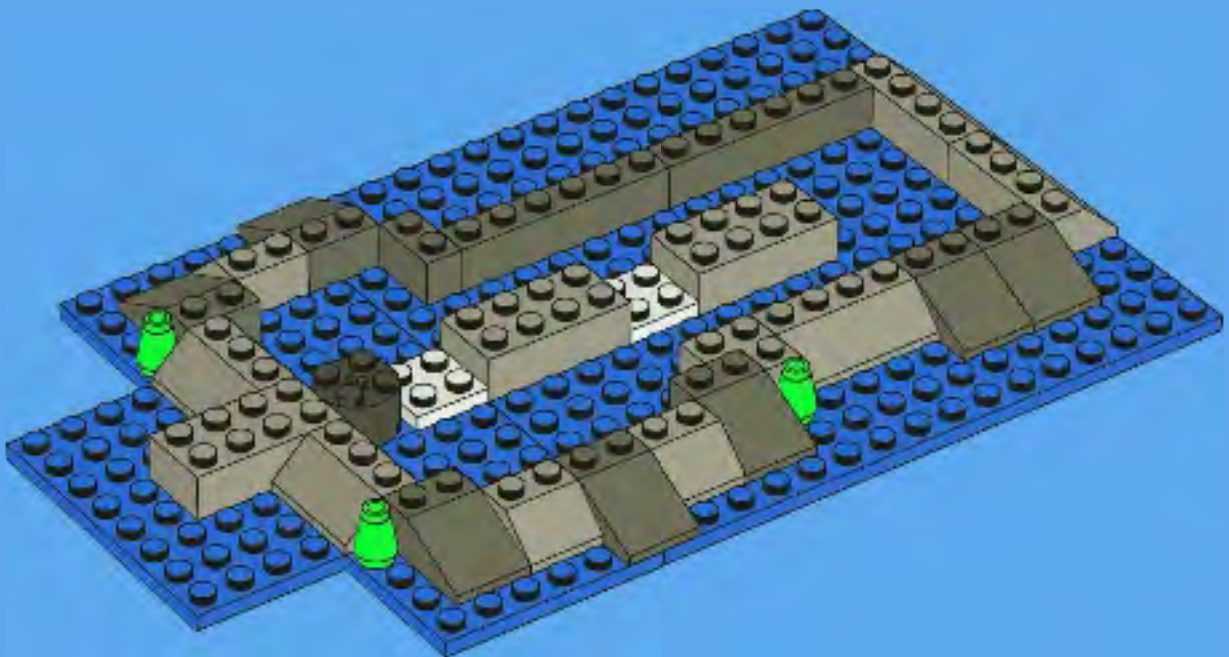

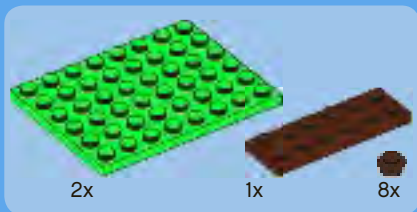

9

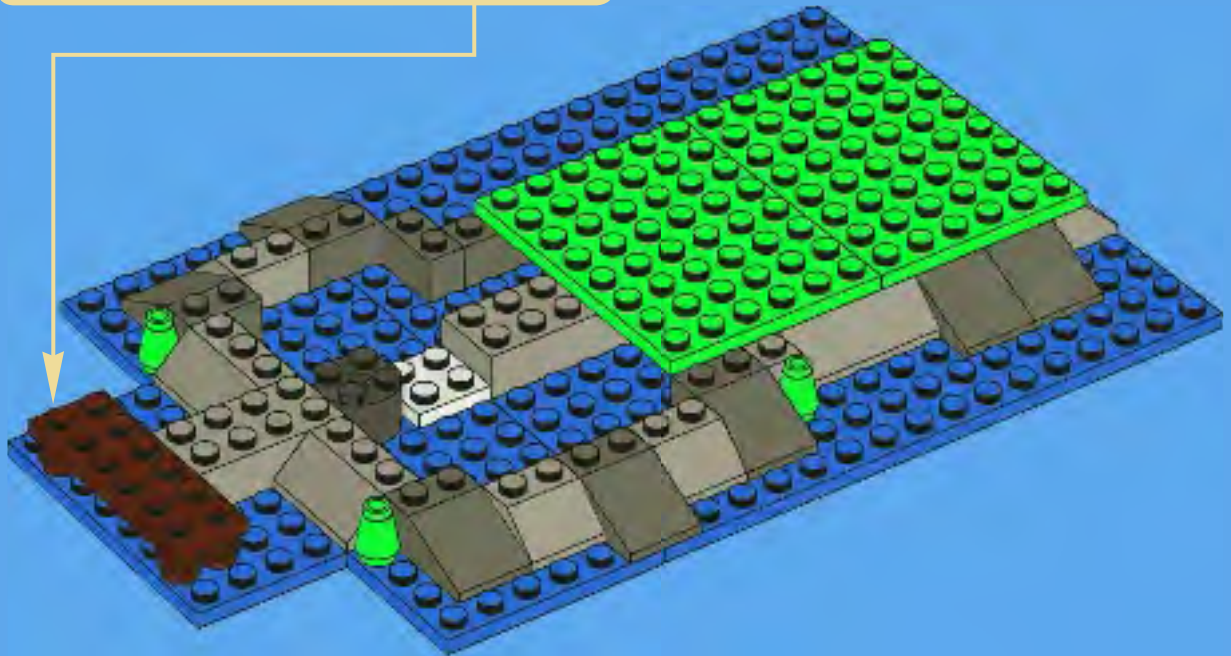
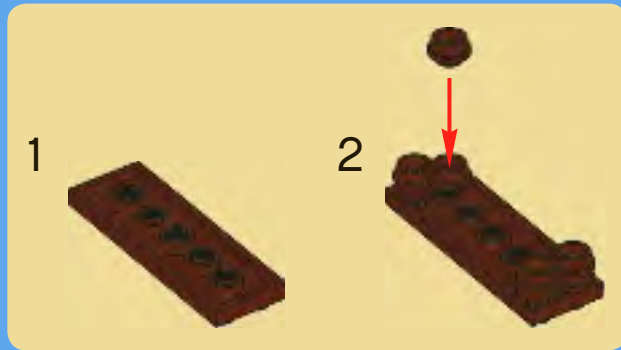

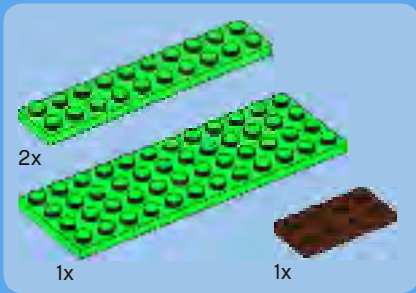

10

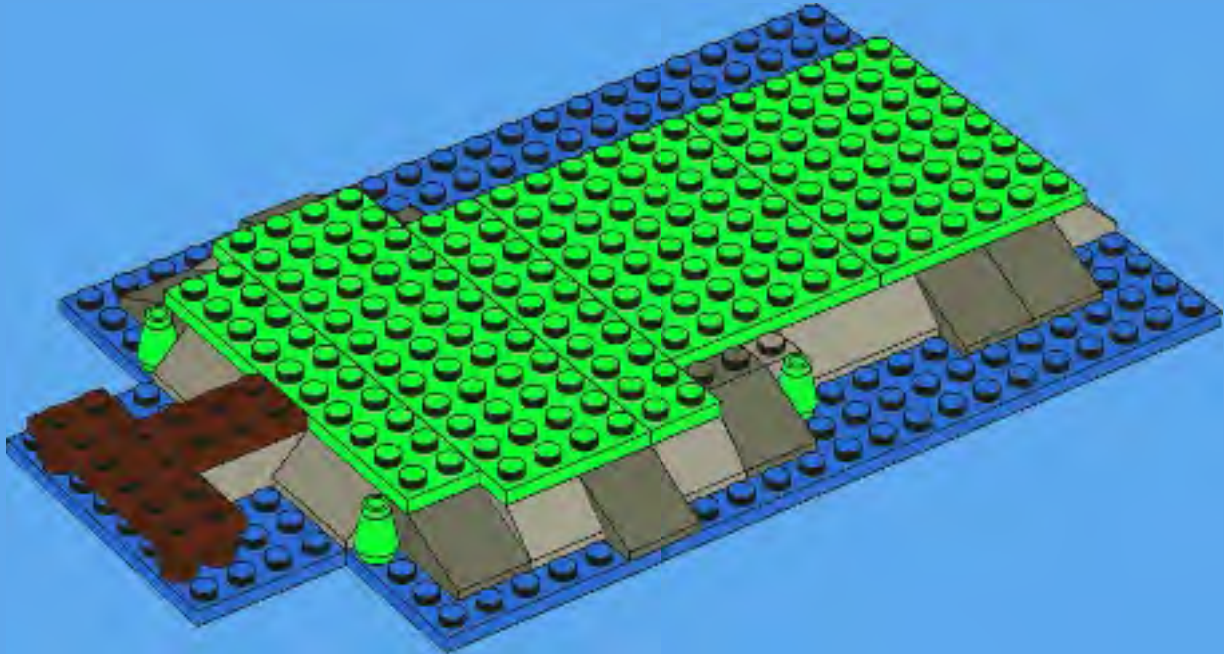

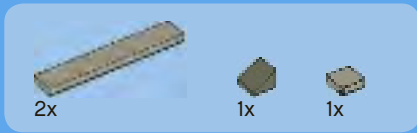

11

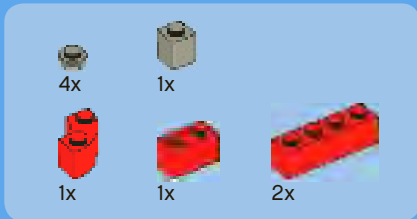
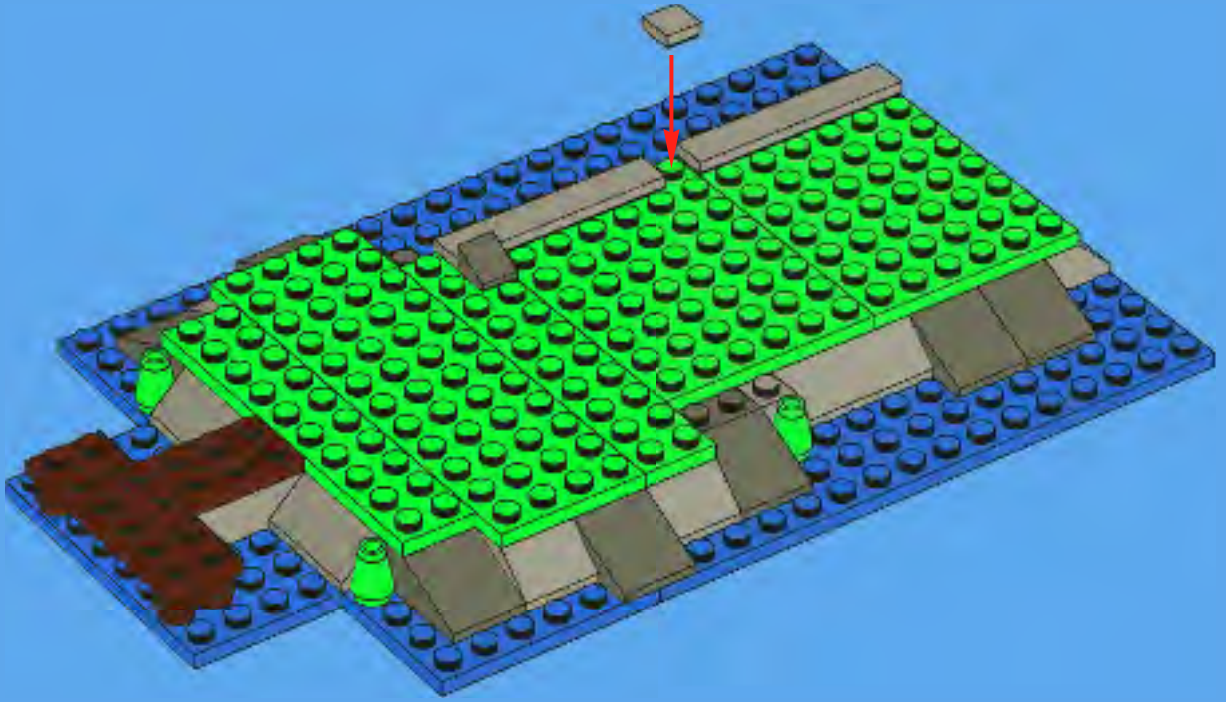

12

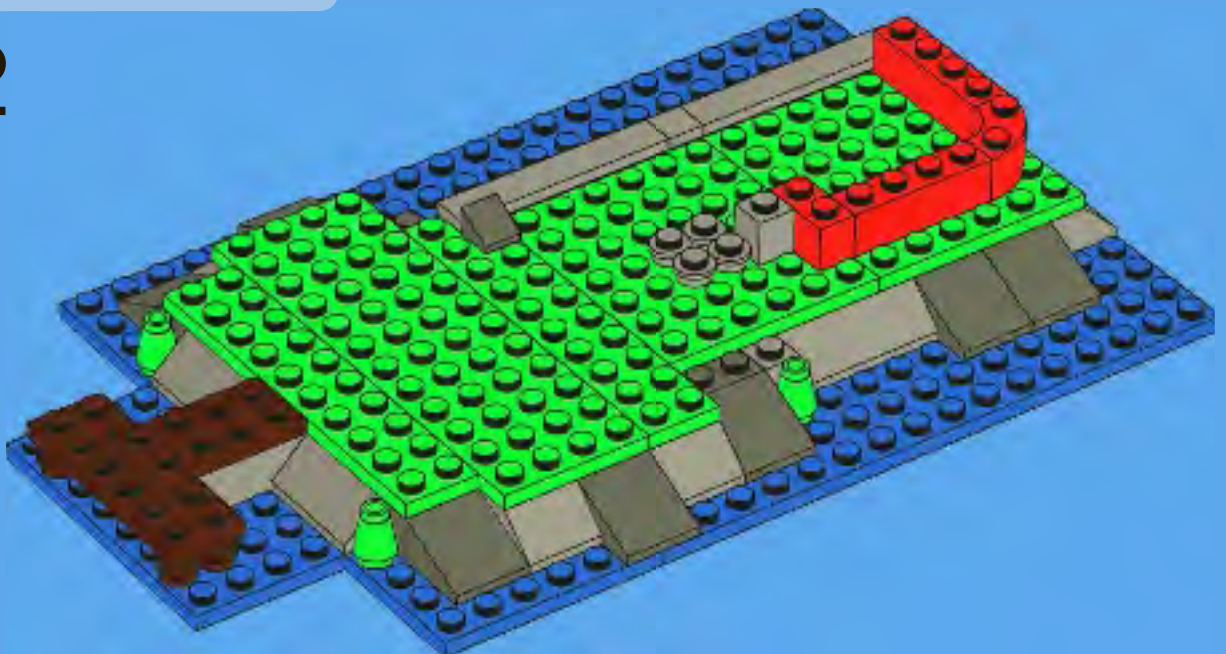



1x



1x



1x



1x



1x



13

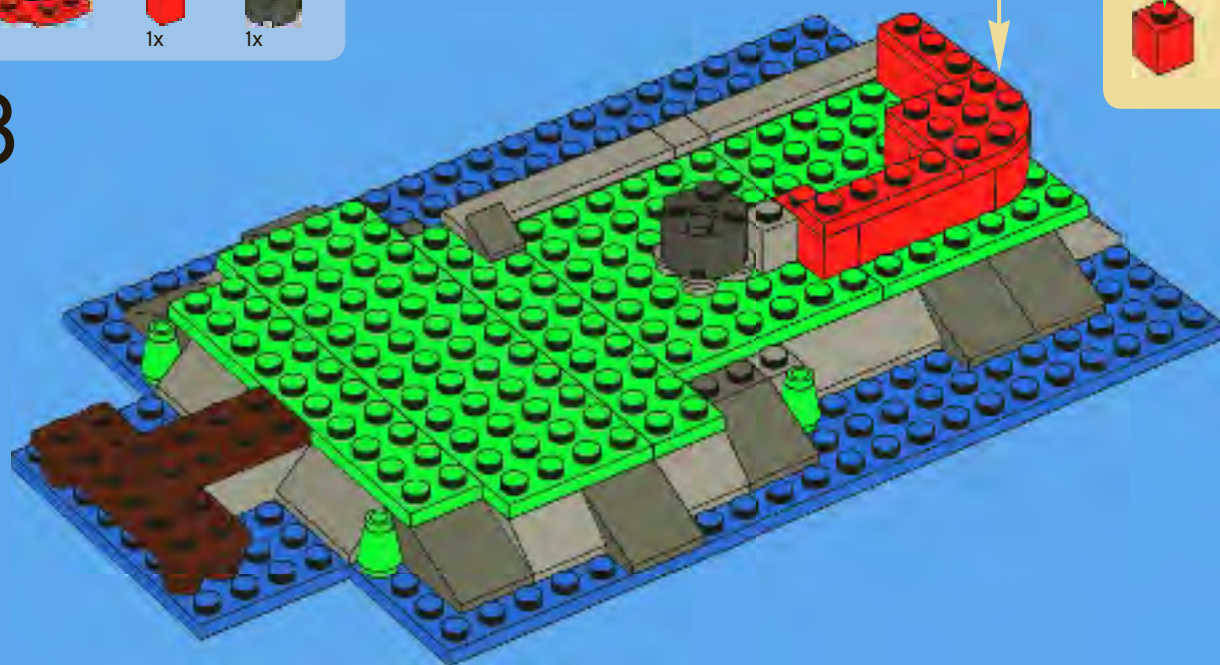

1x



2x



1x



2x

14

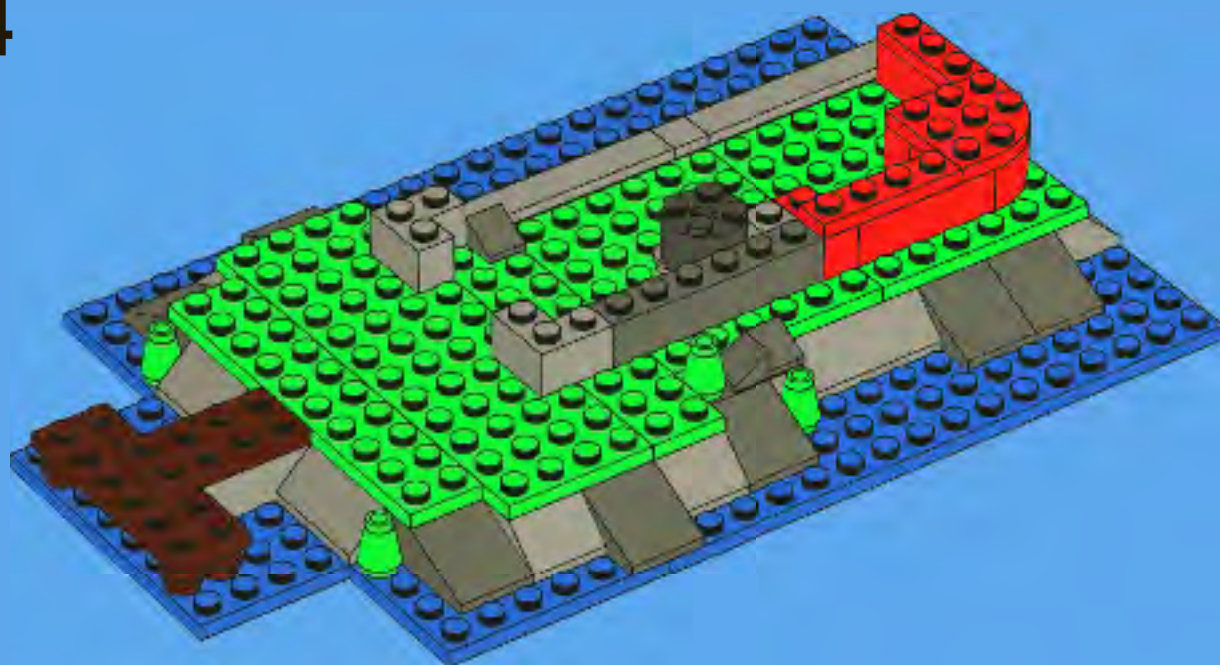

16

1



2



3

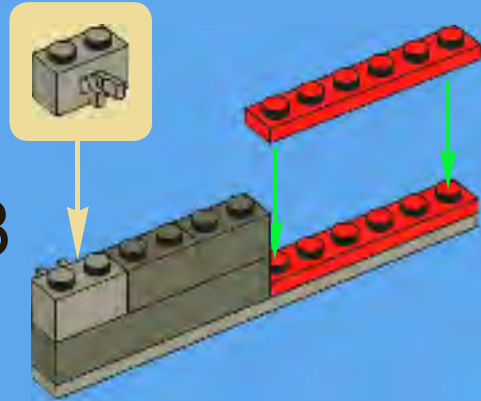

4

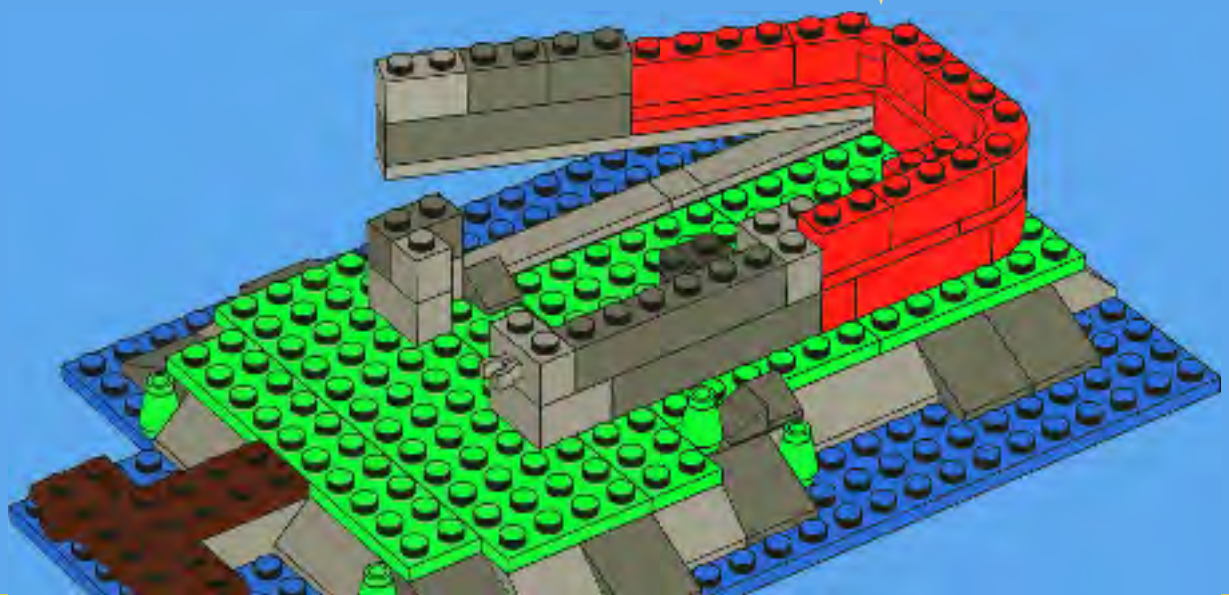
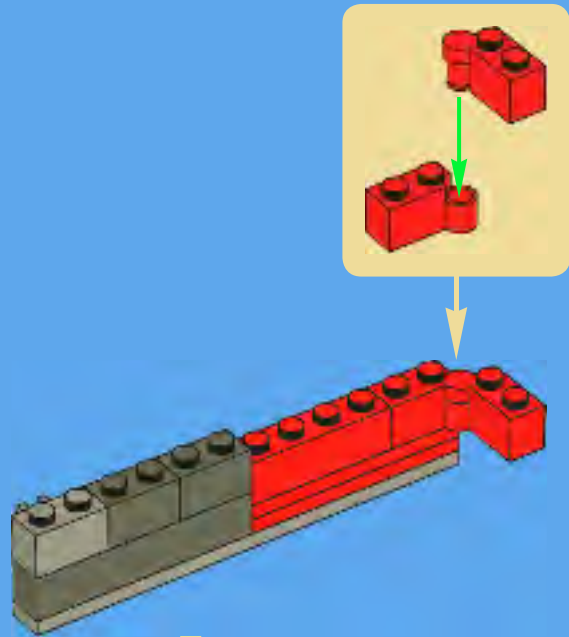

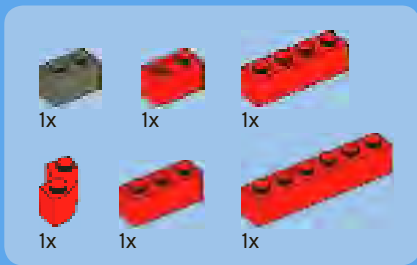

17

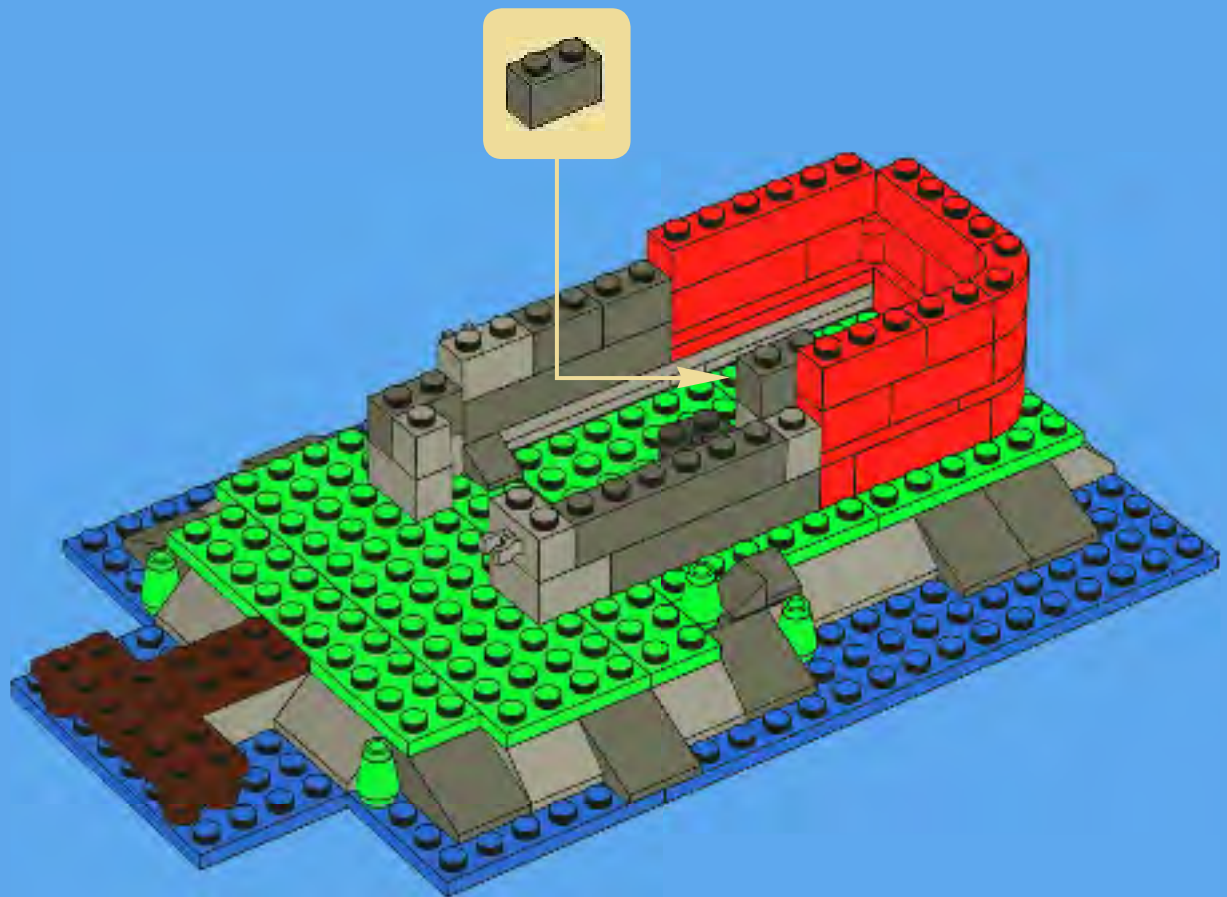



1x



1x



1x



1x



2x



1x

18

1



2

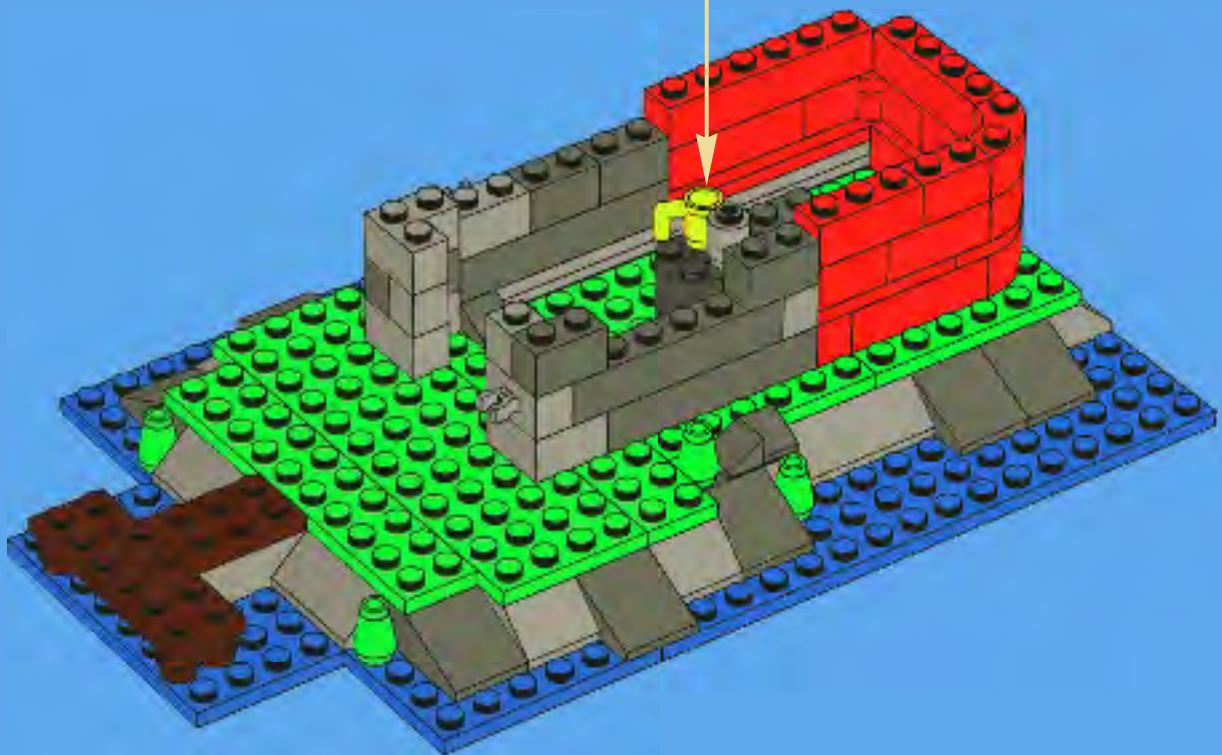

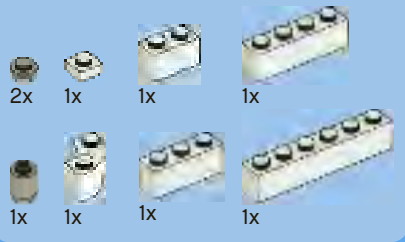

20

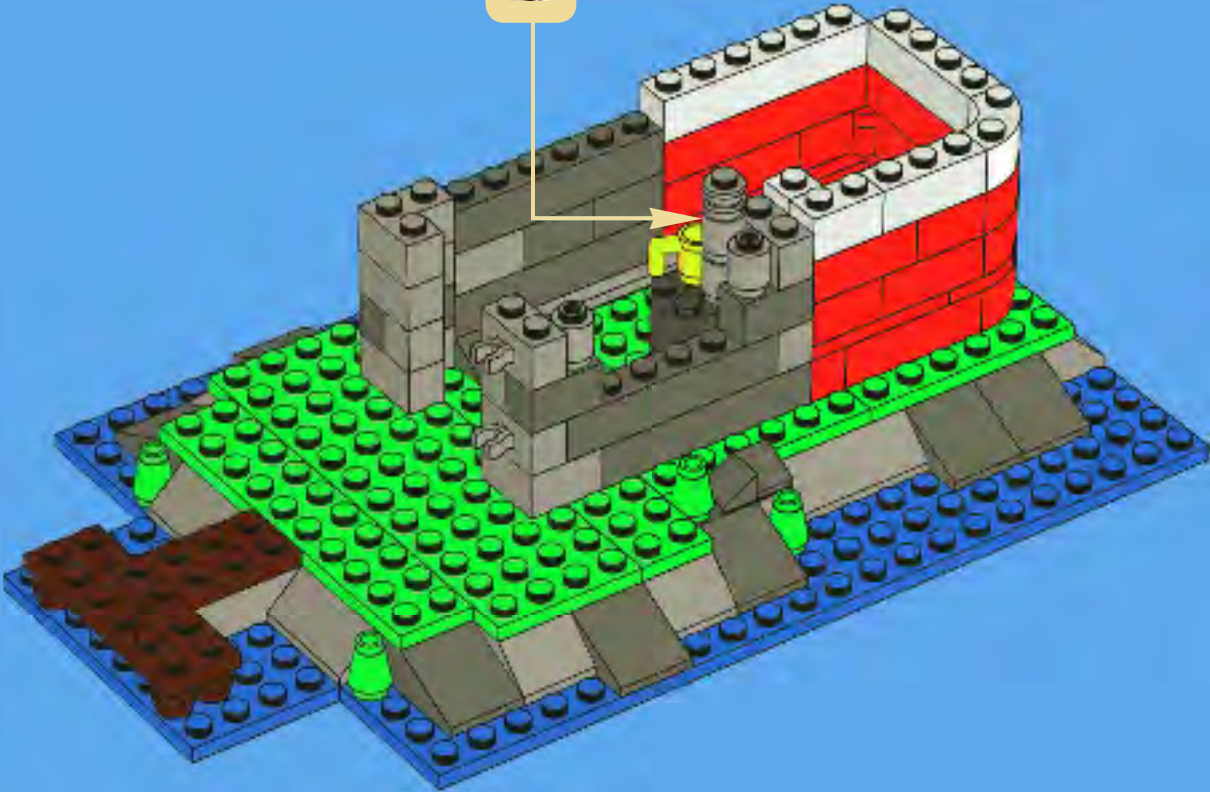

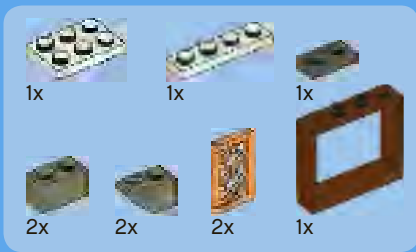

22

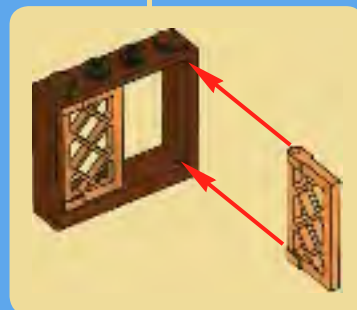



4x



1x



1x

23

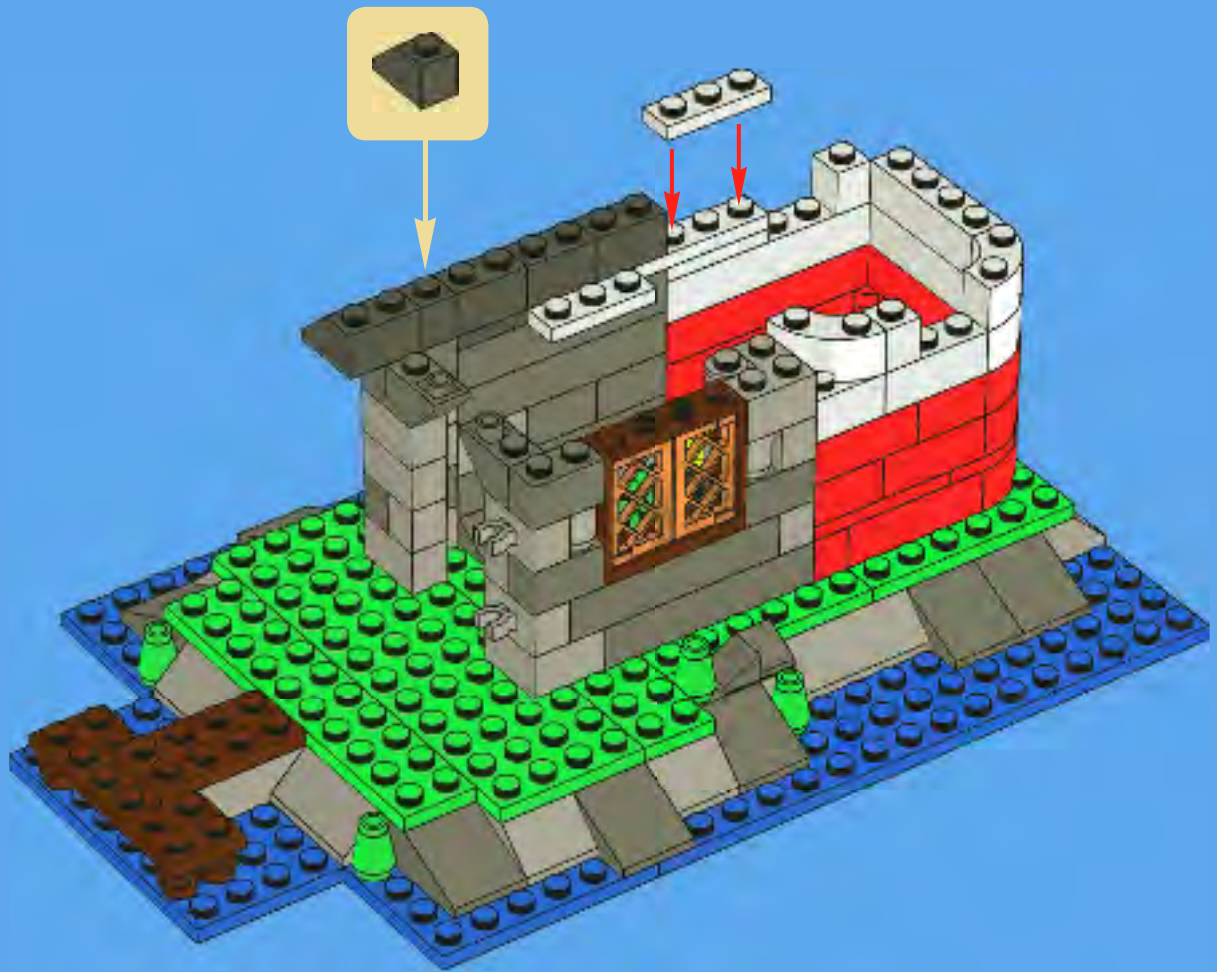

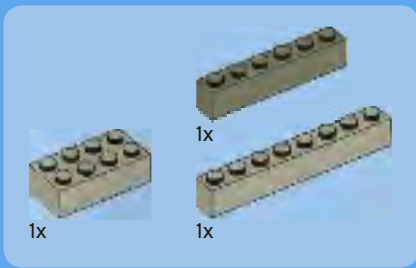

24

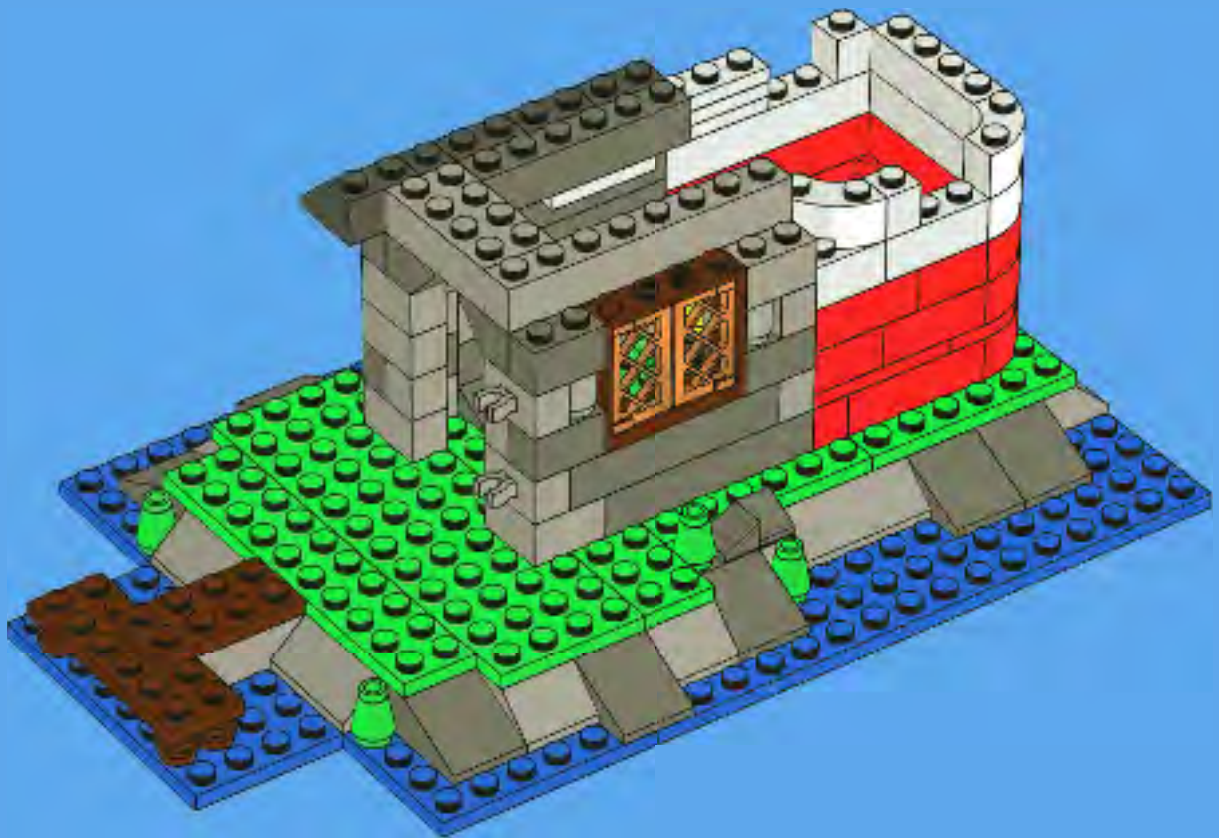



25

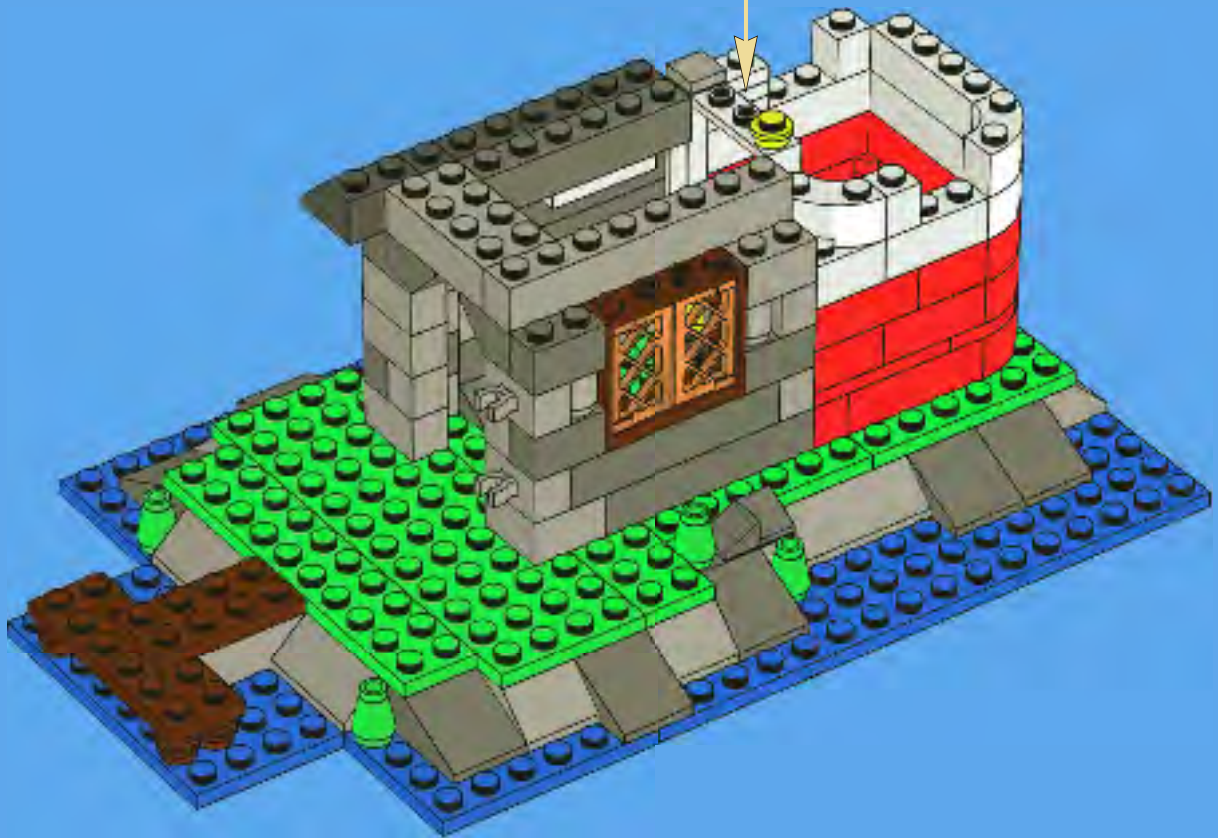
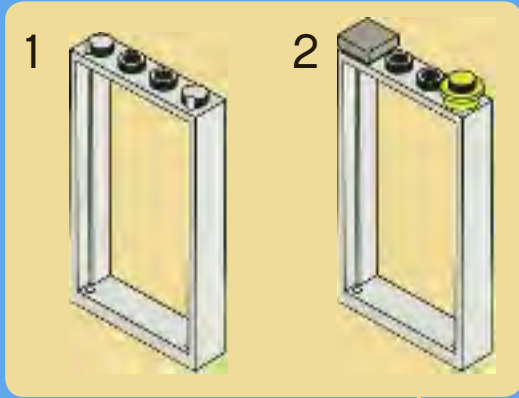

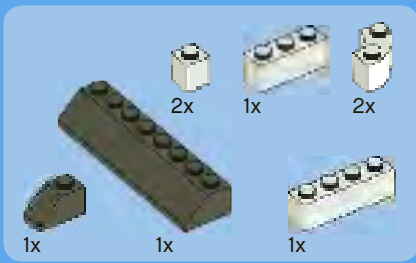

26

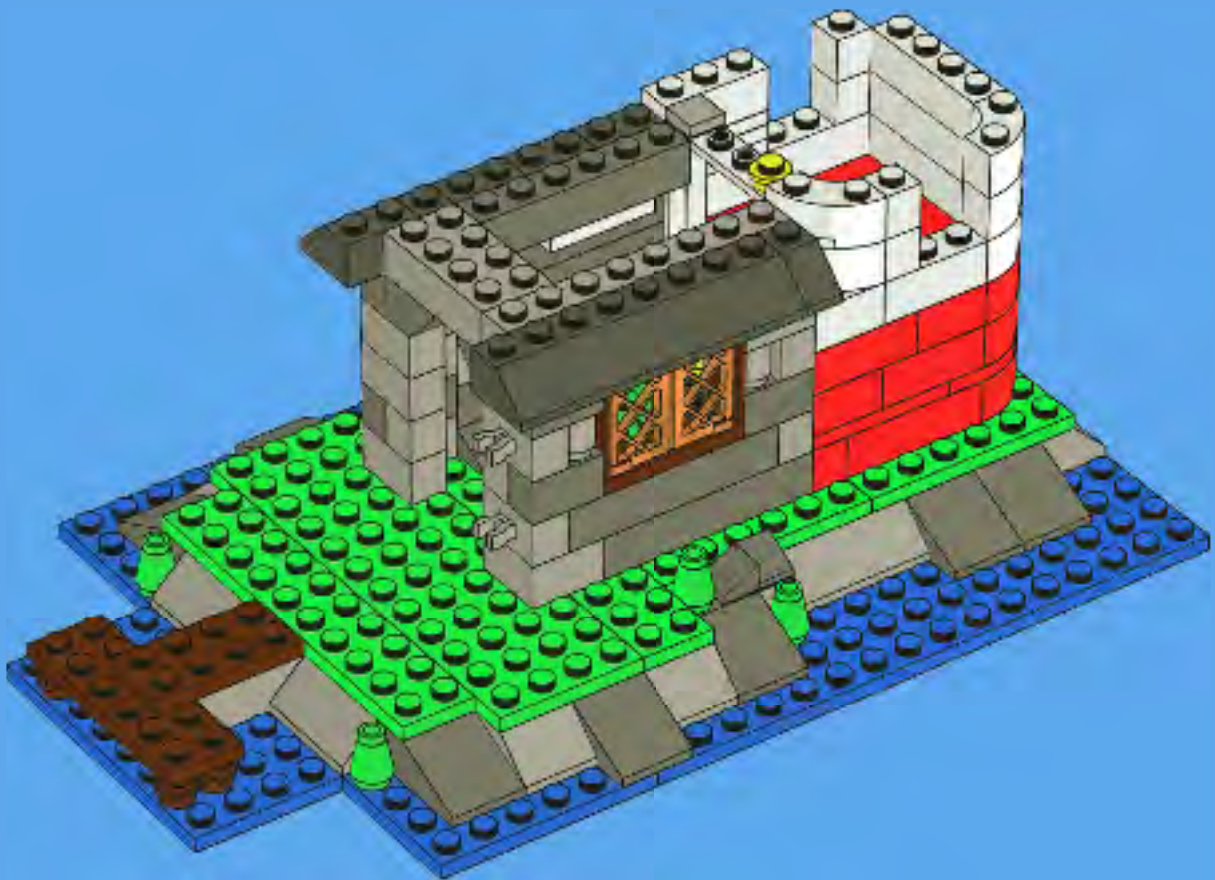

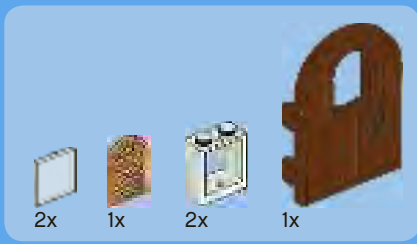

27

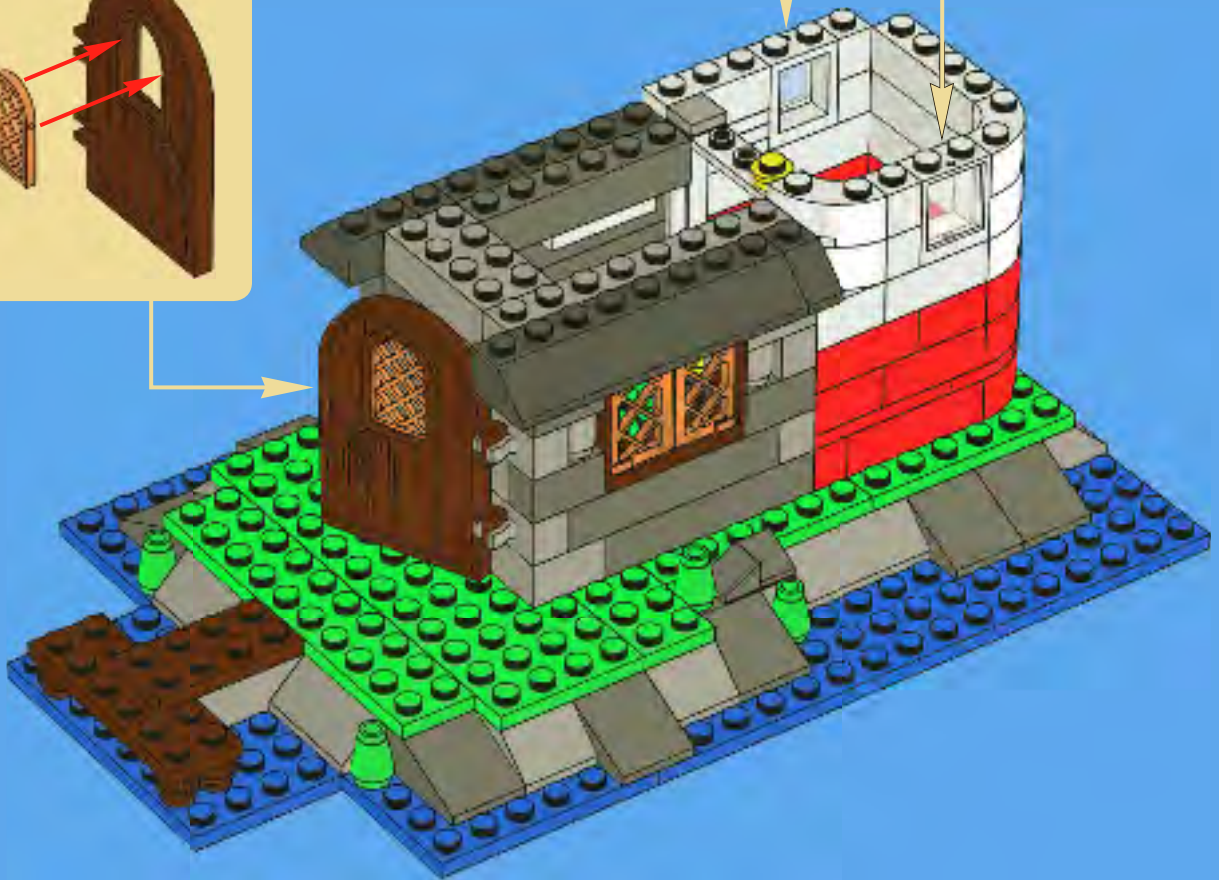
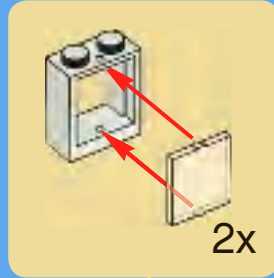



28

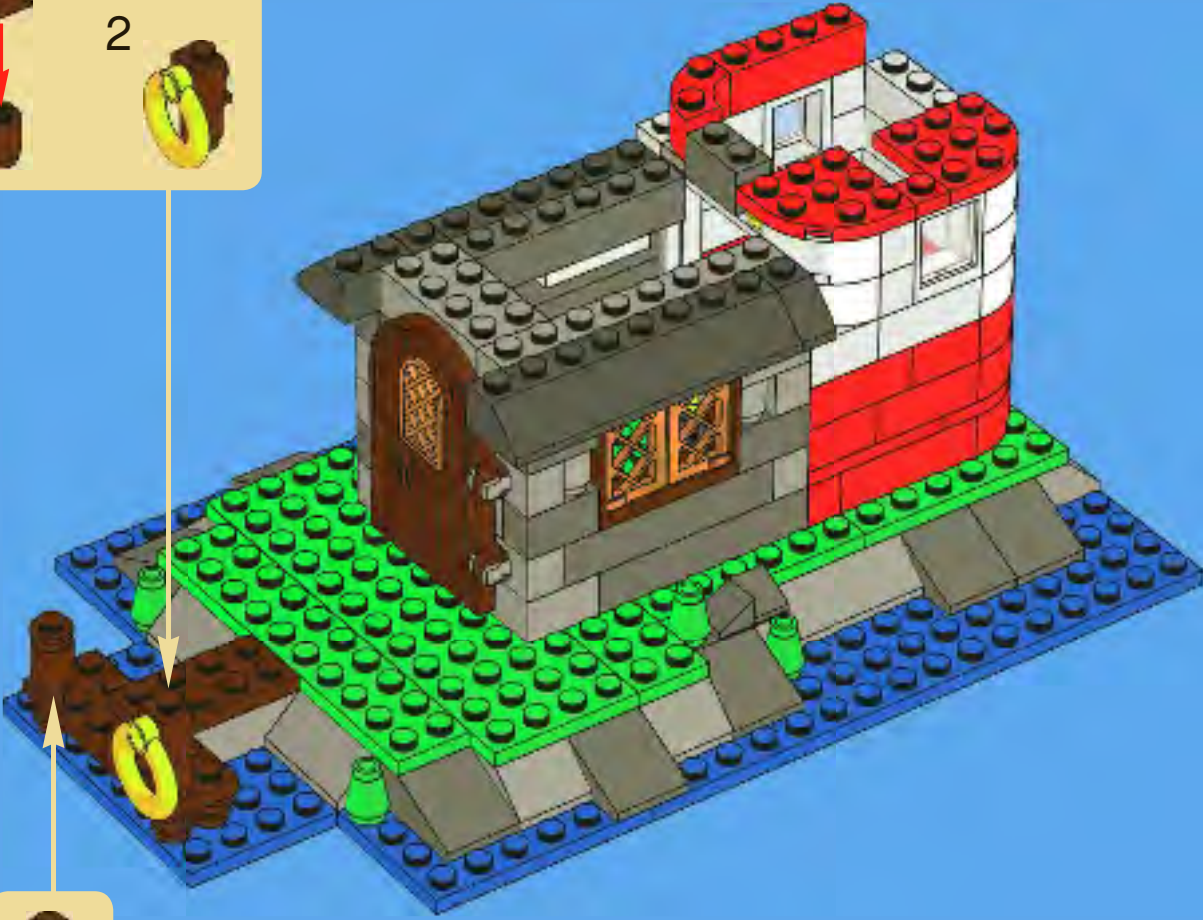
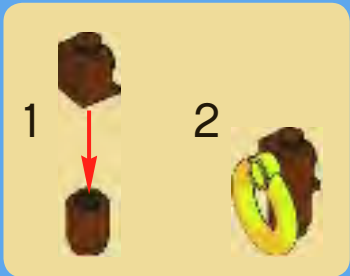

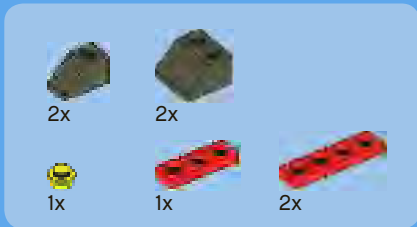

29

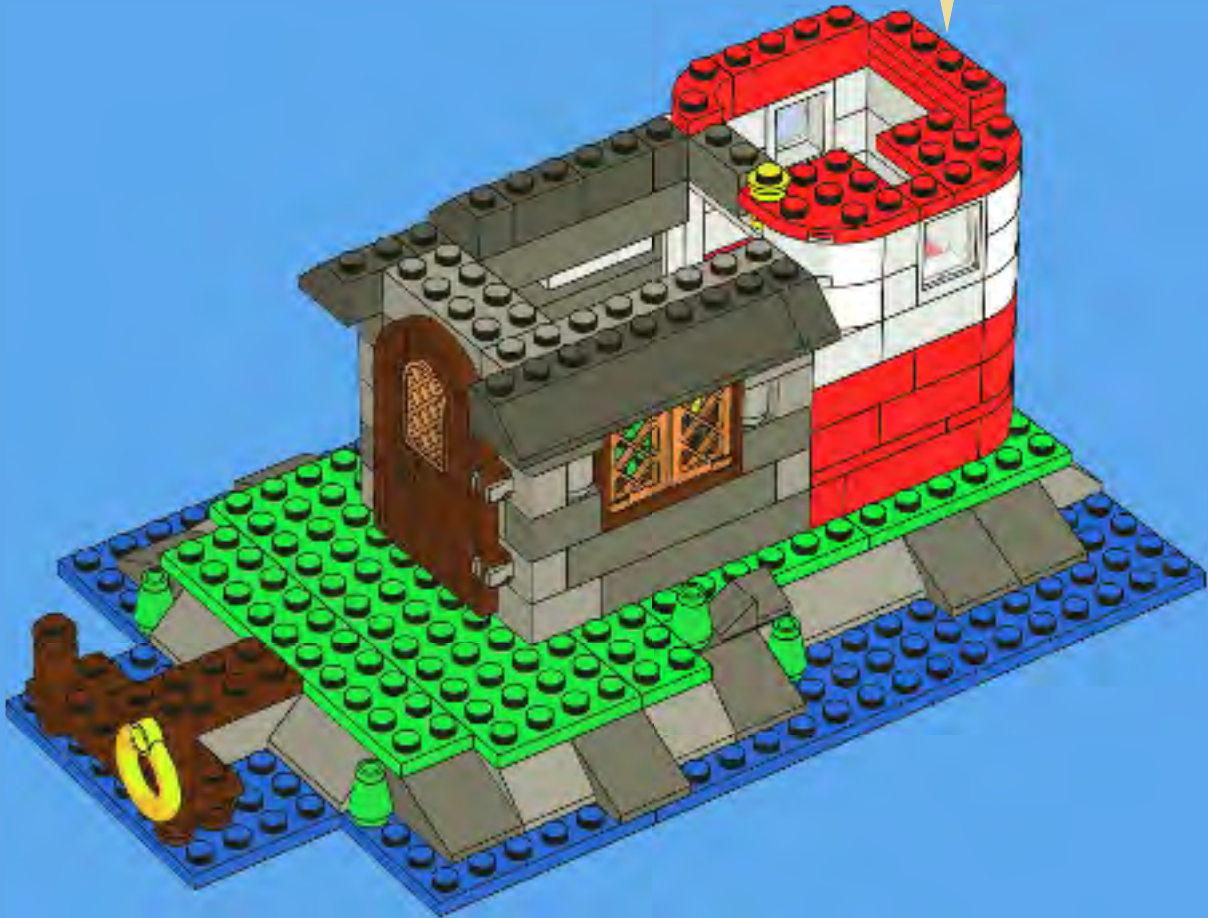
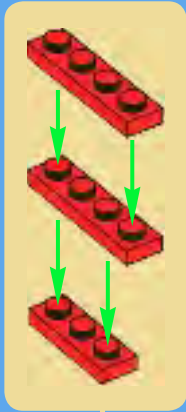

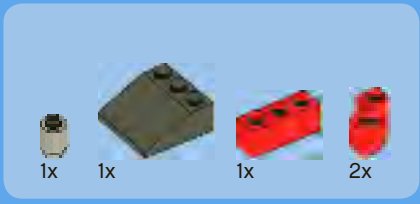

30

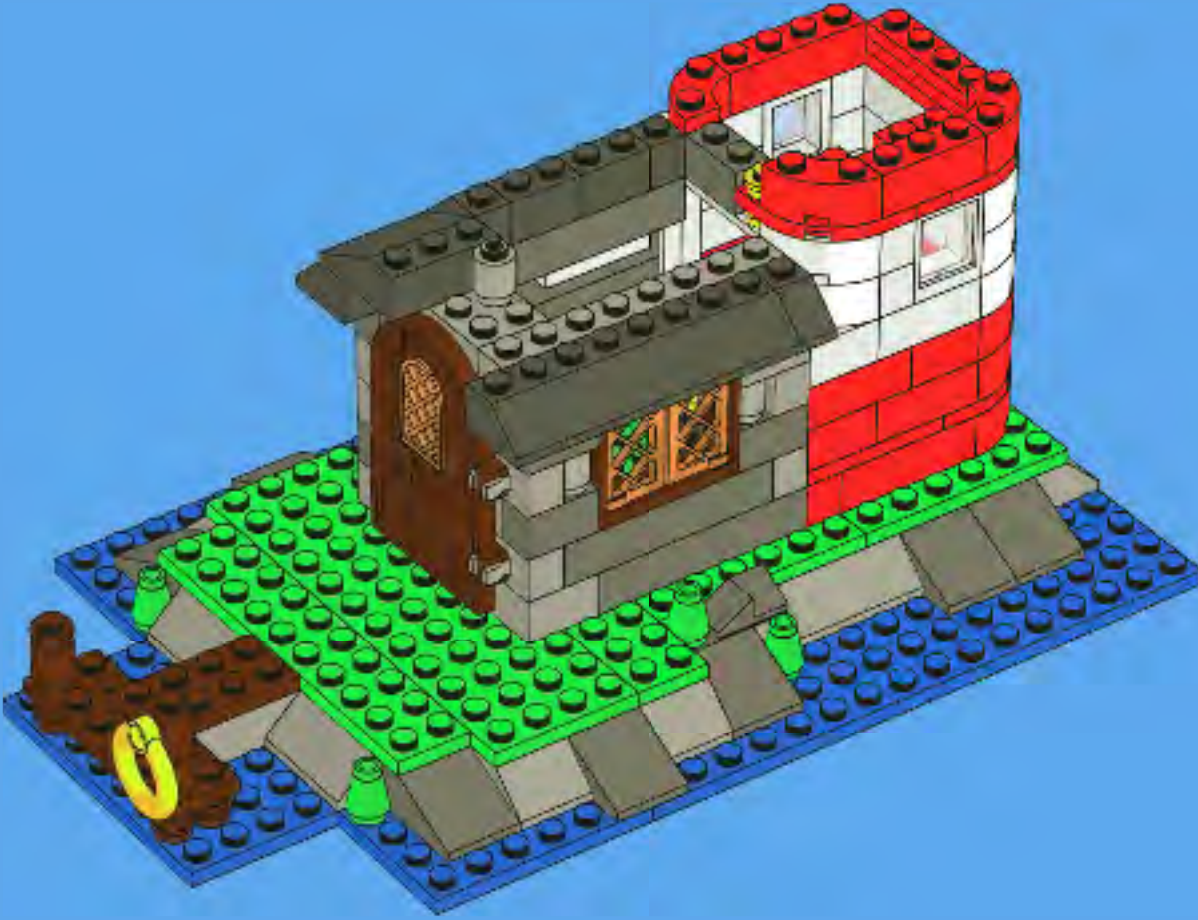

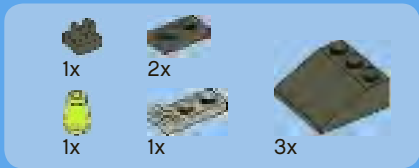

31

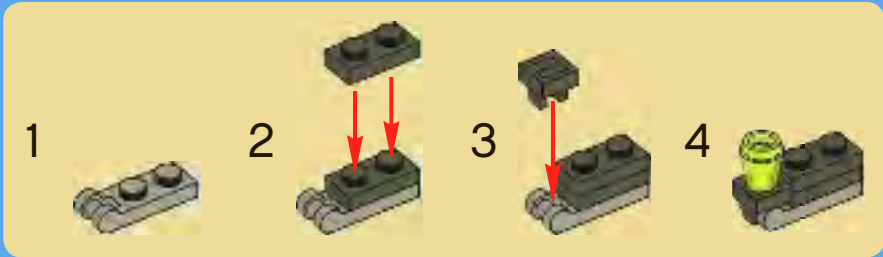

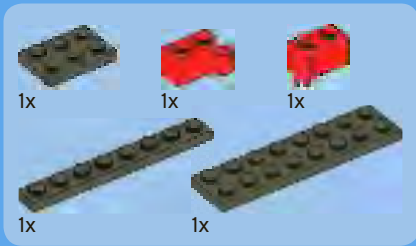

32

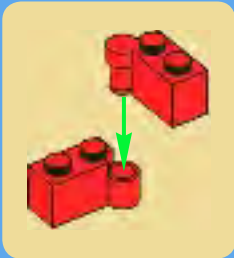



2x



2x



3x



1x

33

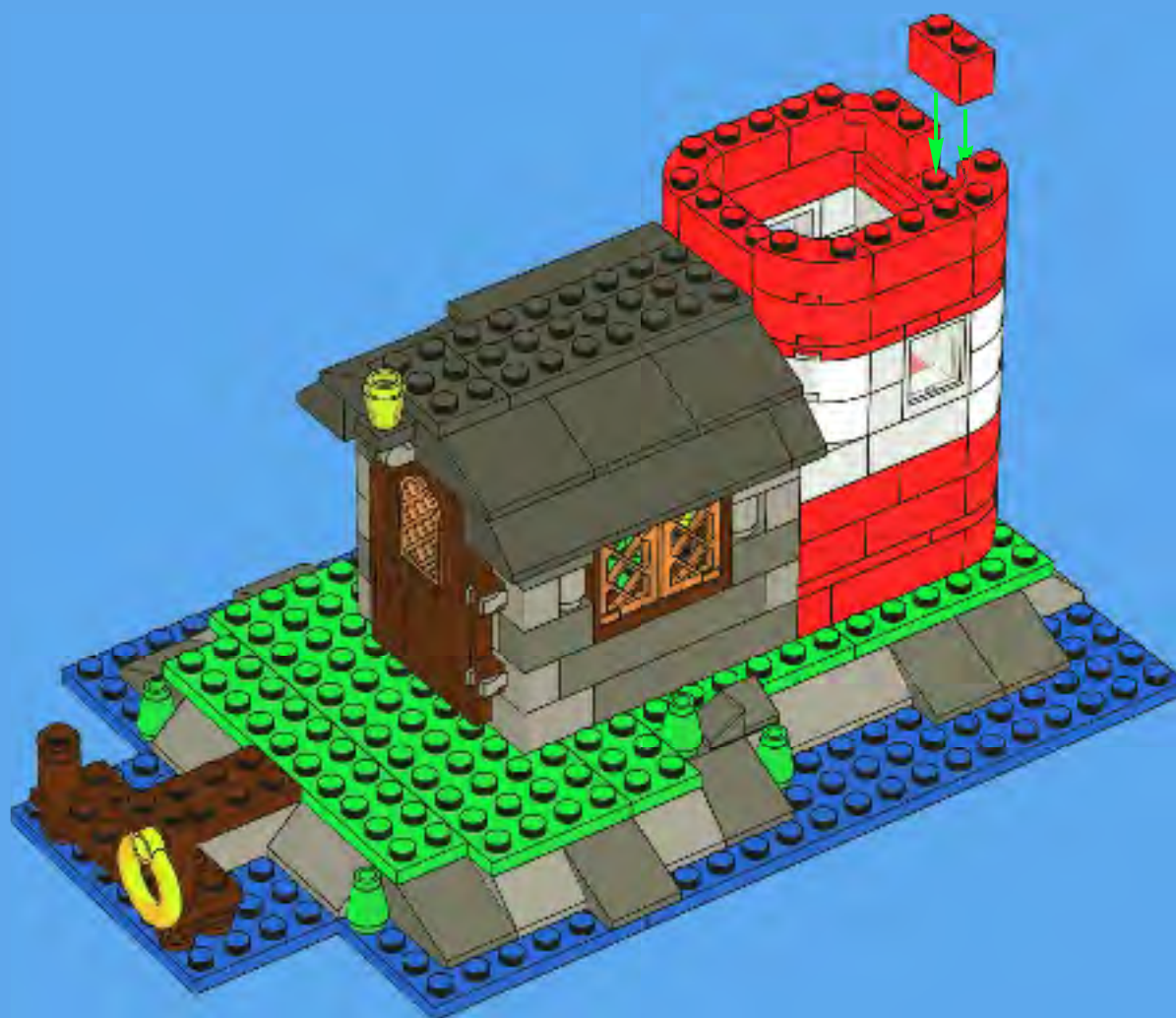

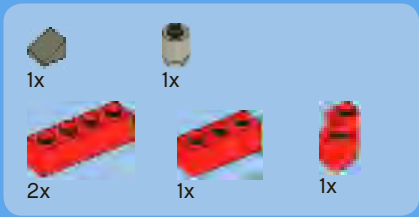

34



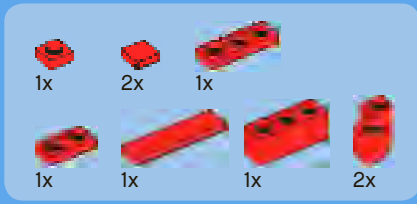

35



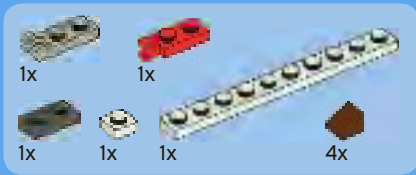

36

1



2



3



4

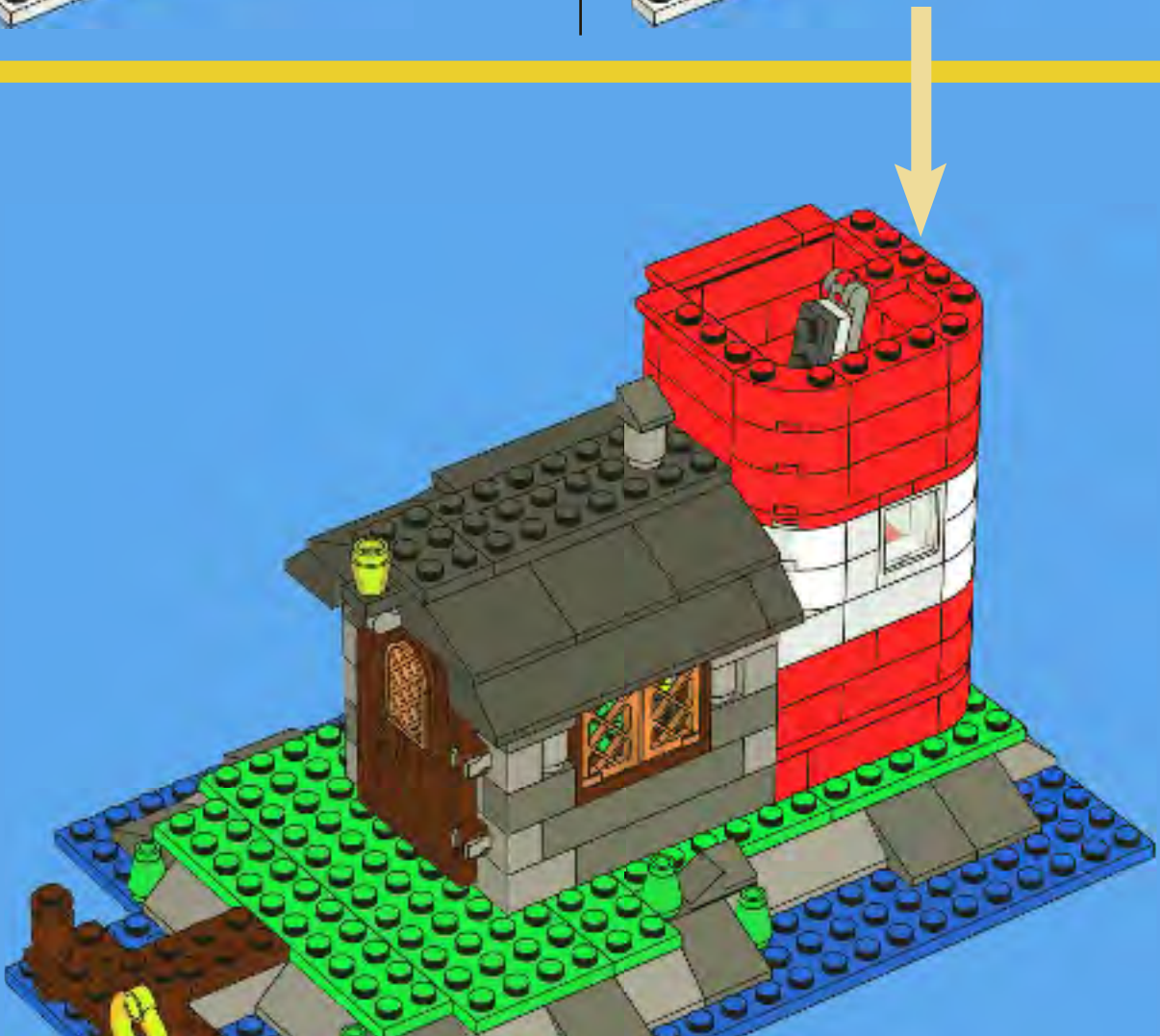



3x



4x

37





1x



4x



4x

38

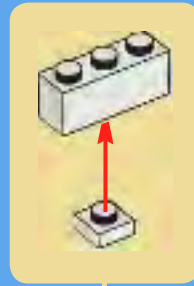



2x



1x



1x



4x

39



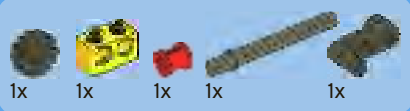

40

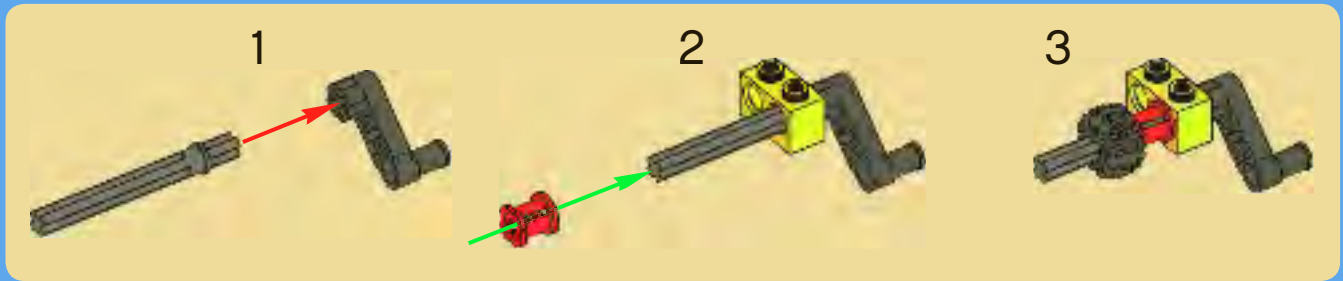

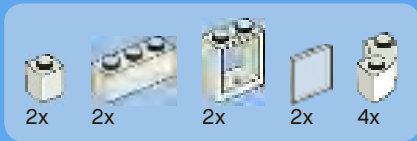

41

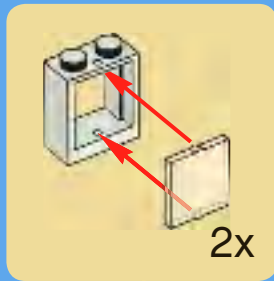



1x



2x

42





43

1



2



3

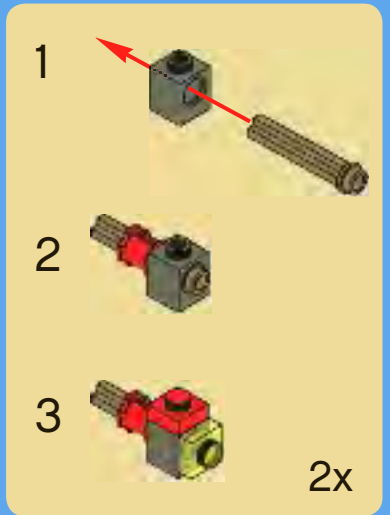

4

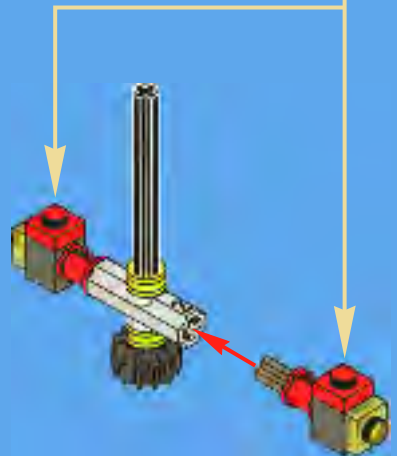

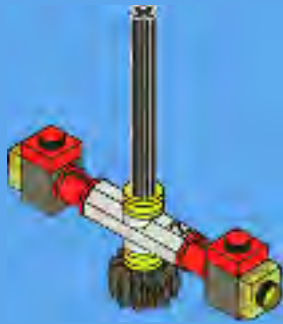



1x



2x

44





4x



2x



4x

45





4x



4x

46





47

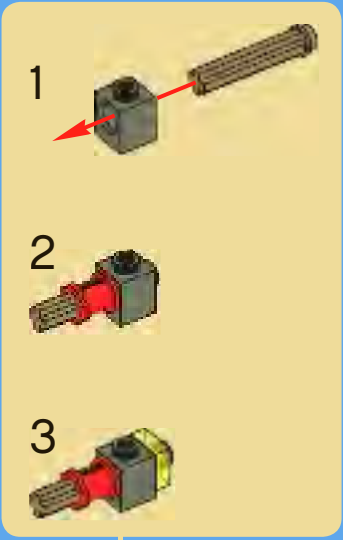

4





8x



2x



4x

48





4x

49





4x



4x

50





4x

51





4x



4x

52





1x



4x

53





1x



1x



1x

54

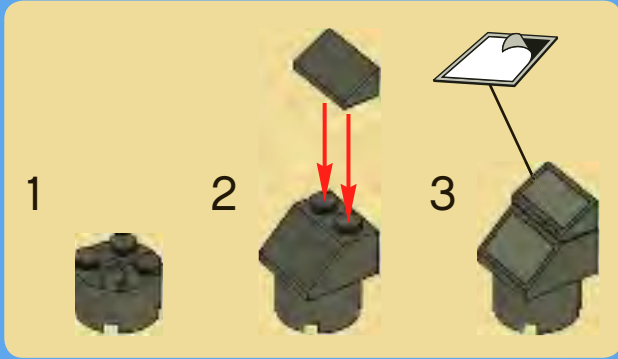



8x



8x



8x

55





4x



1x

56



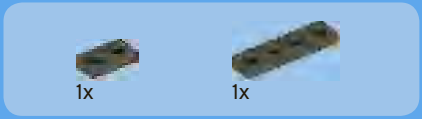

1

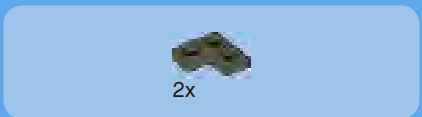
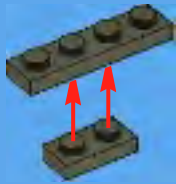

2

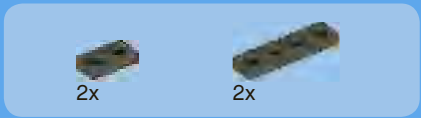
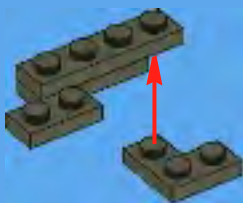

3

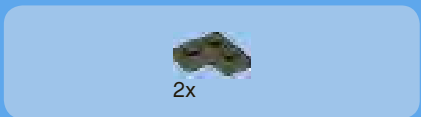
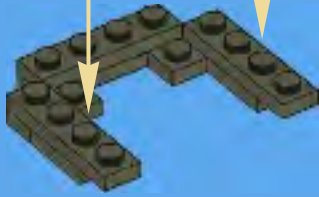
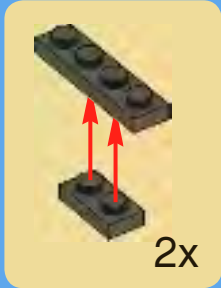

4



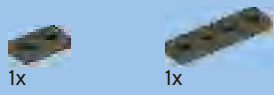

1x

1x

5

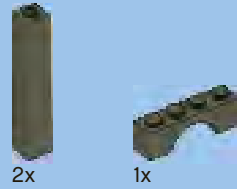
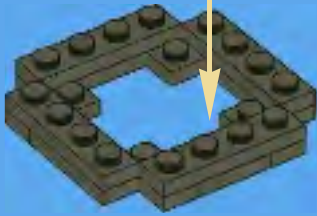
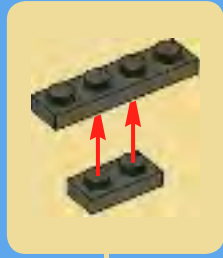

2x

1x

7

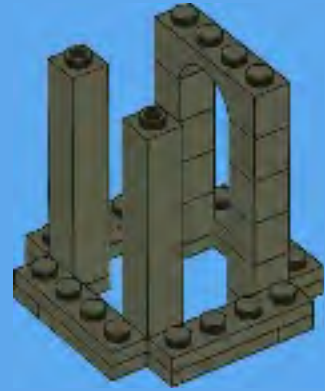

8x

6

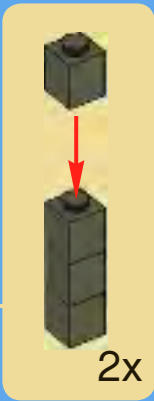

2x

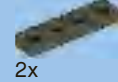
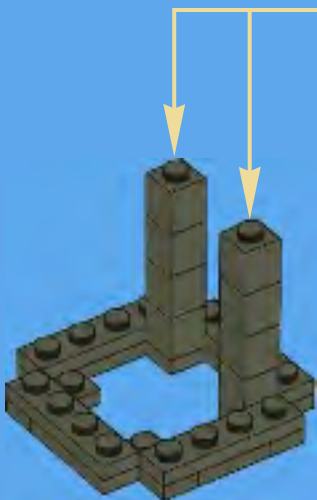

2x

8

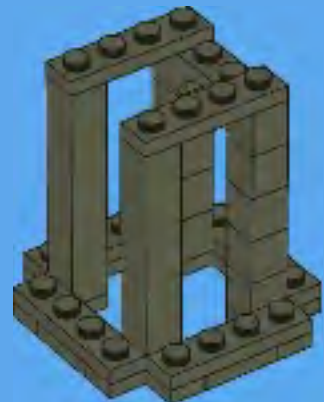



1x

13

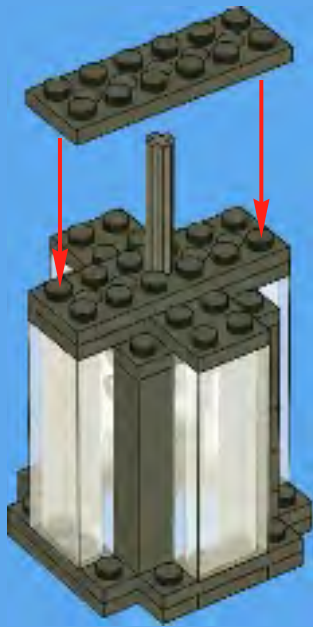

2x



2x

15



4x

14

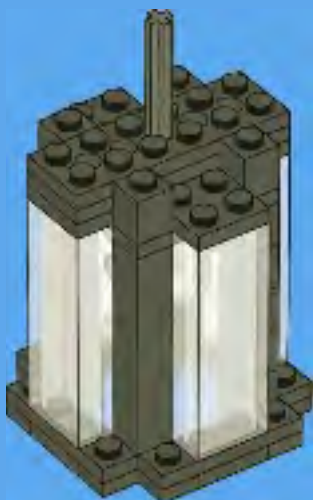

1x



1x

16

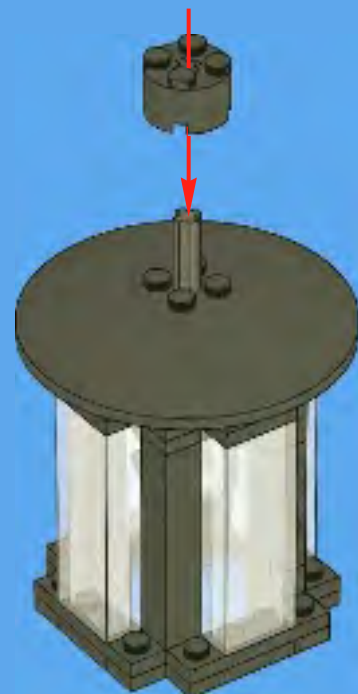



57



-  2x
-  1x
-  1x
-  2x
-  4x
-  2x
-  2x

58





2x



2x



2x



2x



4x



2x



2x

59

1



2



3

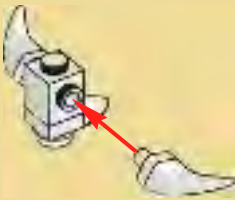

4

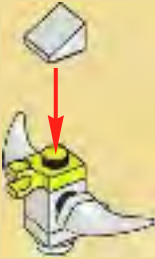

2x





CREATOR

5770



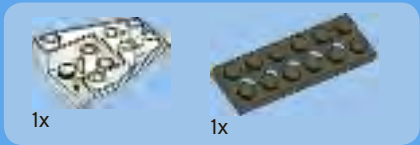
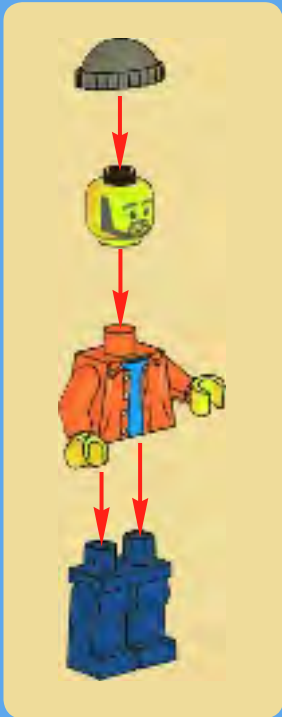

1

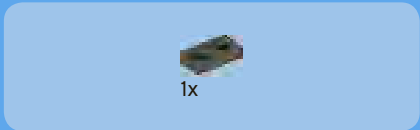
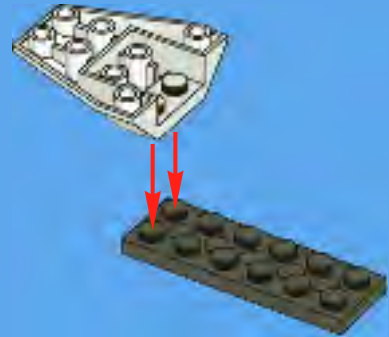

2

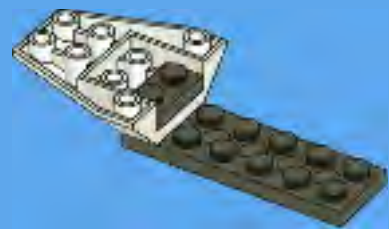



1x

3

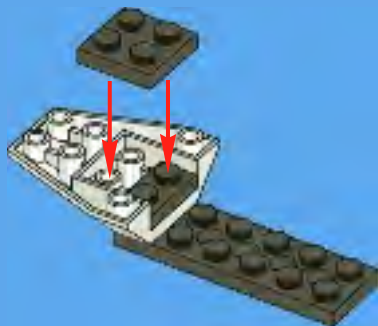

6x

4

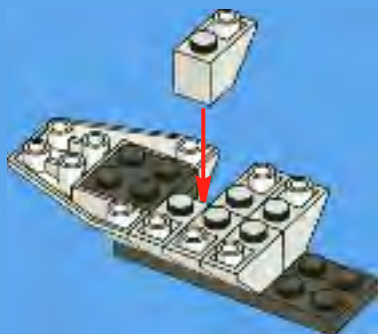

1x



1x



1x



1x



1x

5

1



2

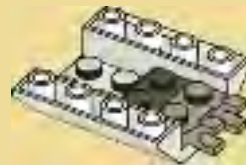

3





2x



2x

6

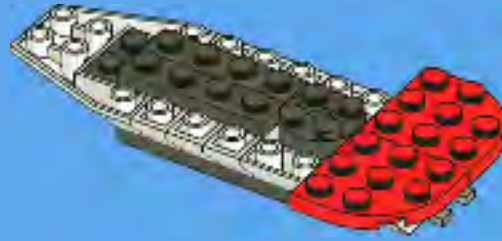

1x



2x

7



2x



1x



1x



1x

8

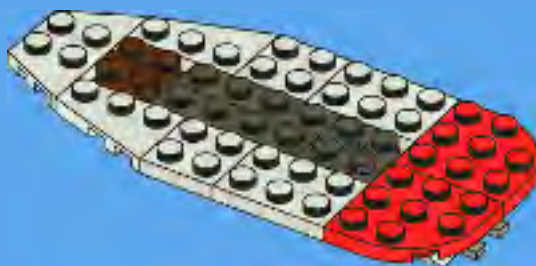



2x



2x

9

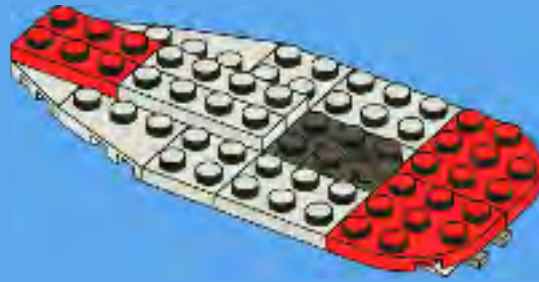

2x



2x



2x

10

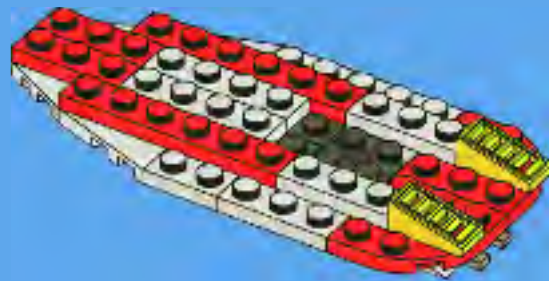

2x



2x

11





1x



2x

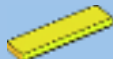

2x

12

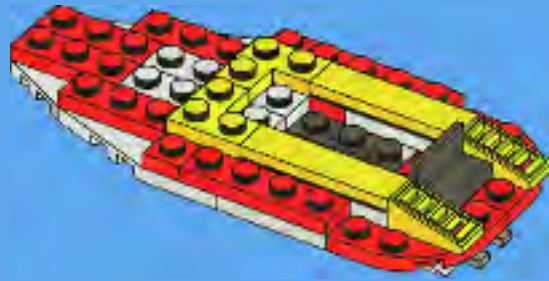

2x



2x



1x



1x



1x

13

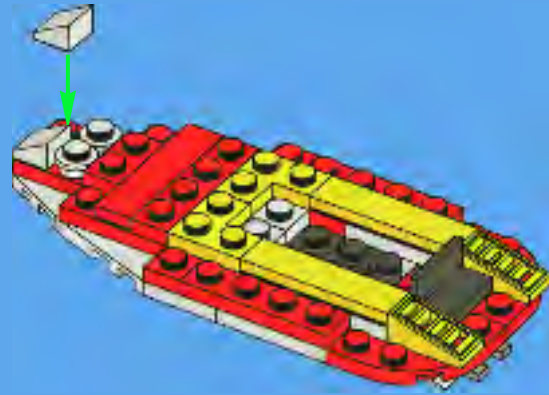

1x



2x



2x

14

1



2



3

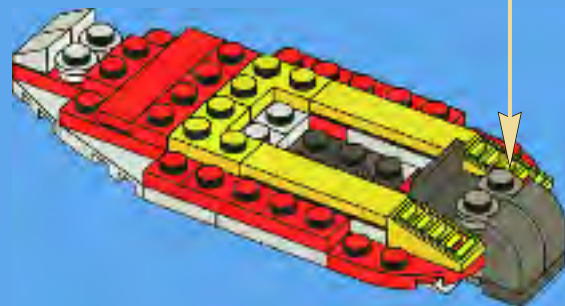



1x



2x



1x



1x

15

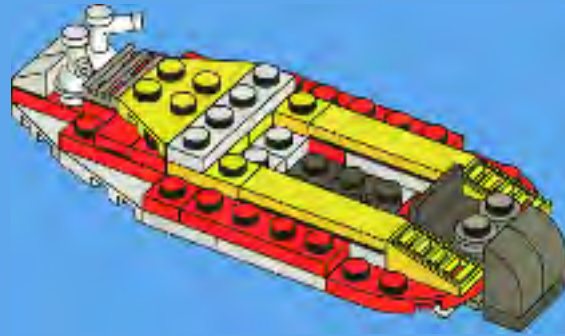

2x



4x

16

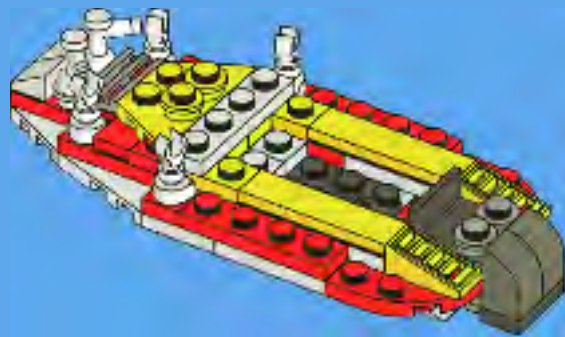

2x

17

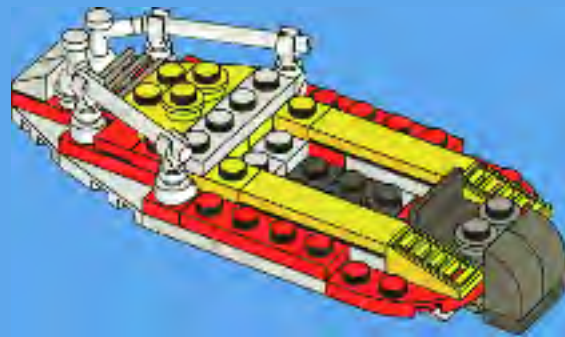



2x



2x

18

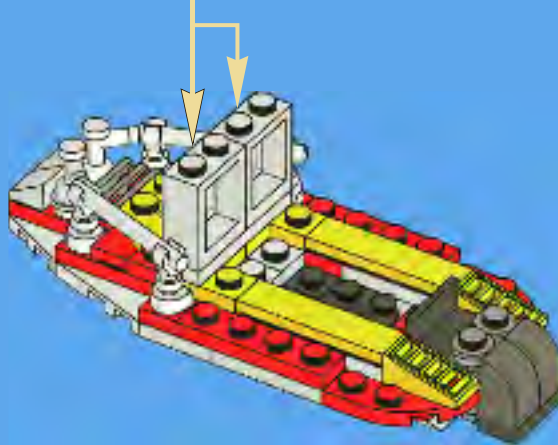
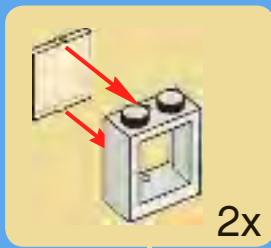

1x



1x



1x

19

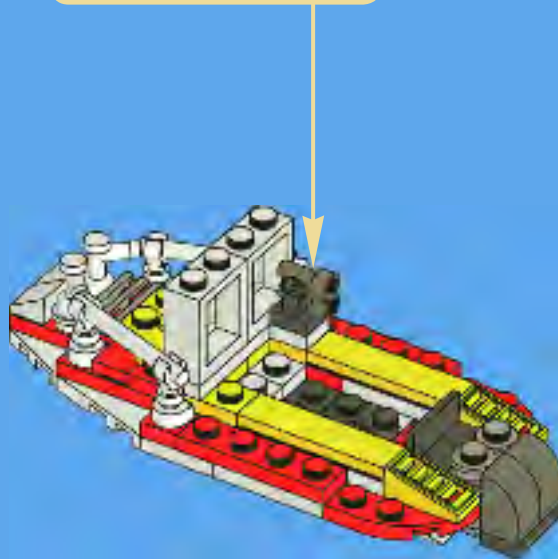
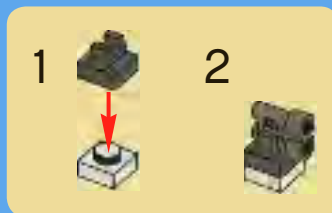



4x

20



1x



1x



1x



1x

21

1



2



3





2x



2x

22

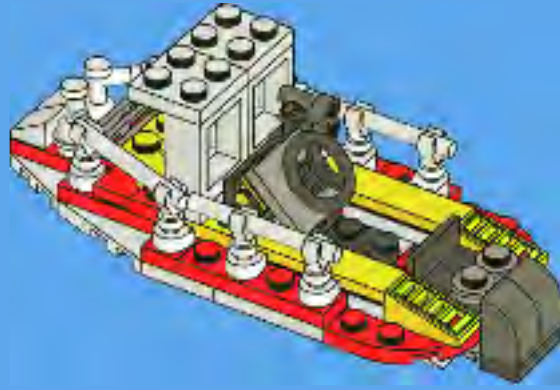

2x



2x



1x

23

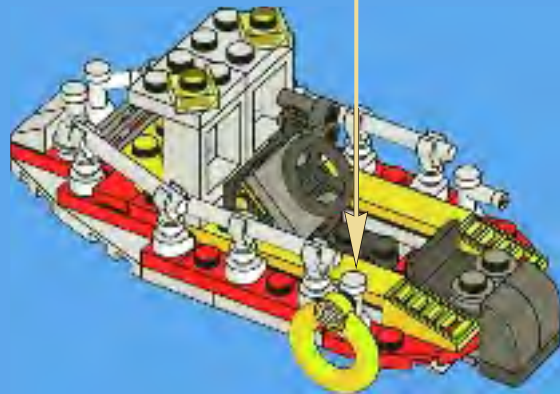



1x

24

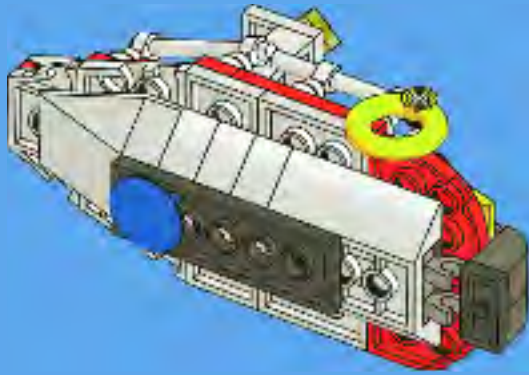

1x



1x

1





1x

2

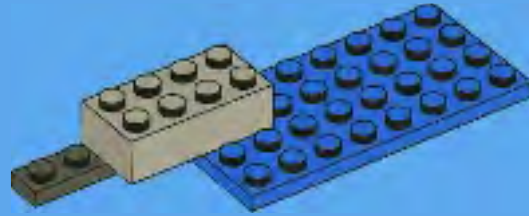

1x



1x



1x

1

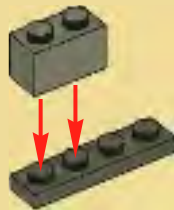

2

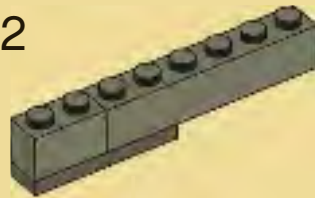

3

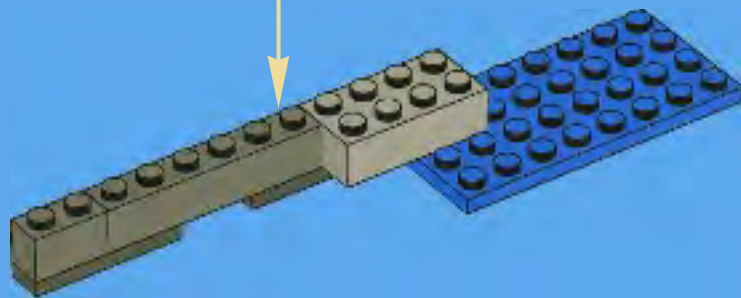



1x



1x

4

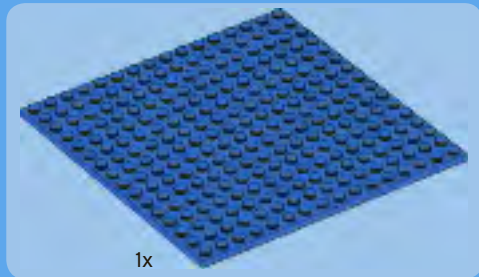
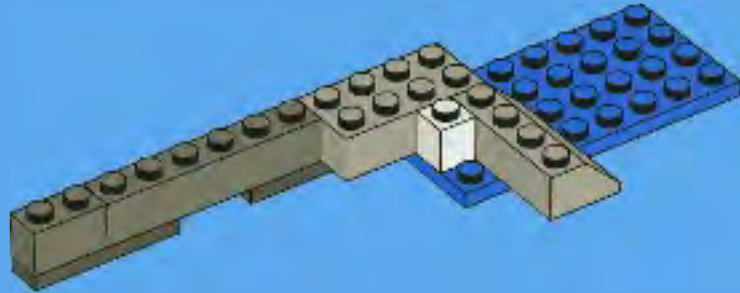

1x

5

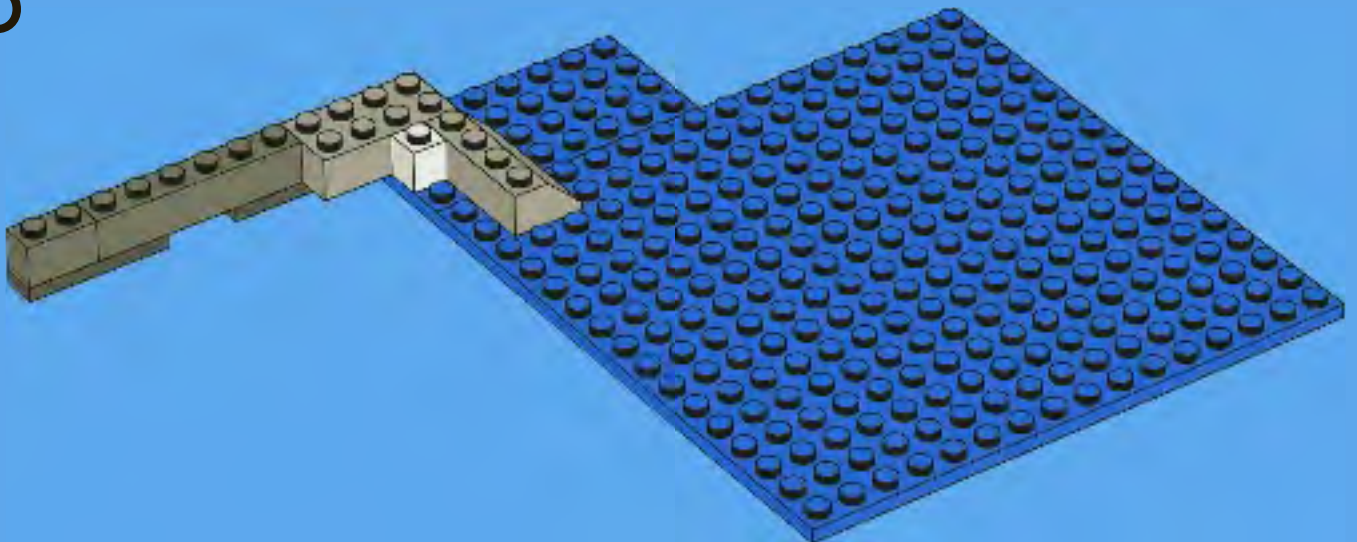

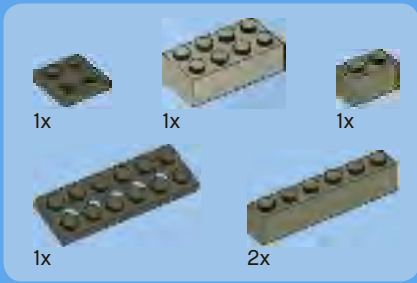

6

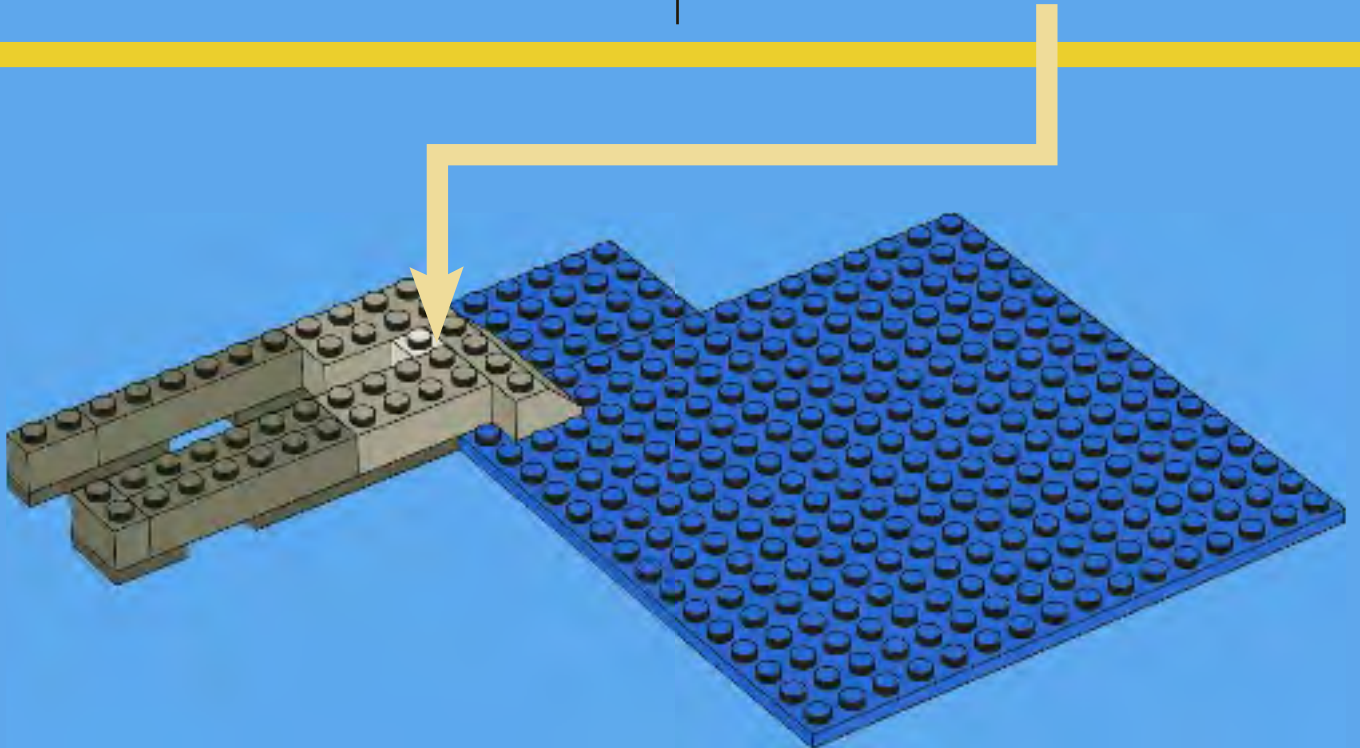
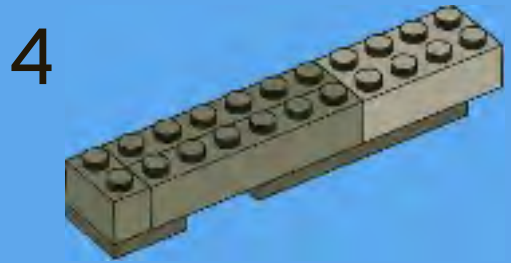
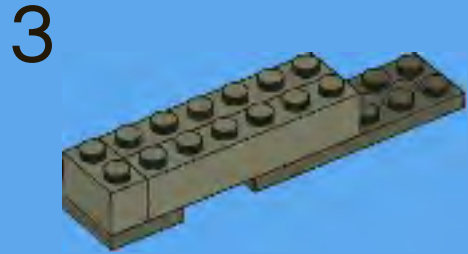
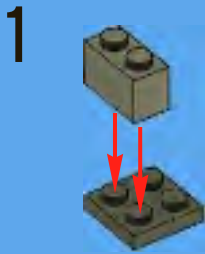



2x



2x



2x



1x

7

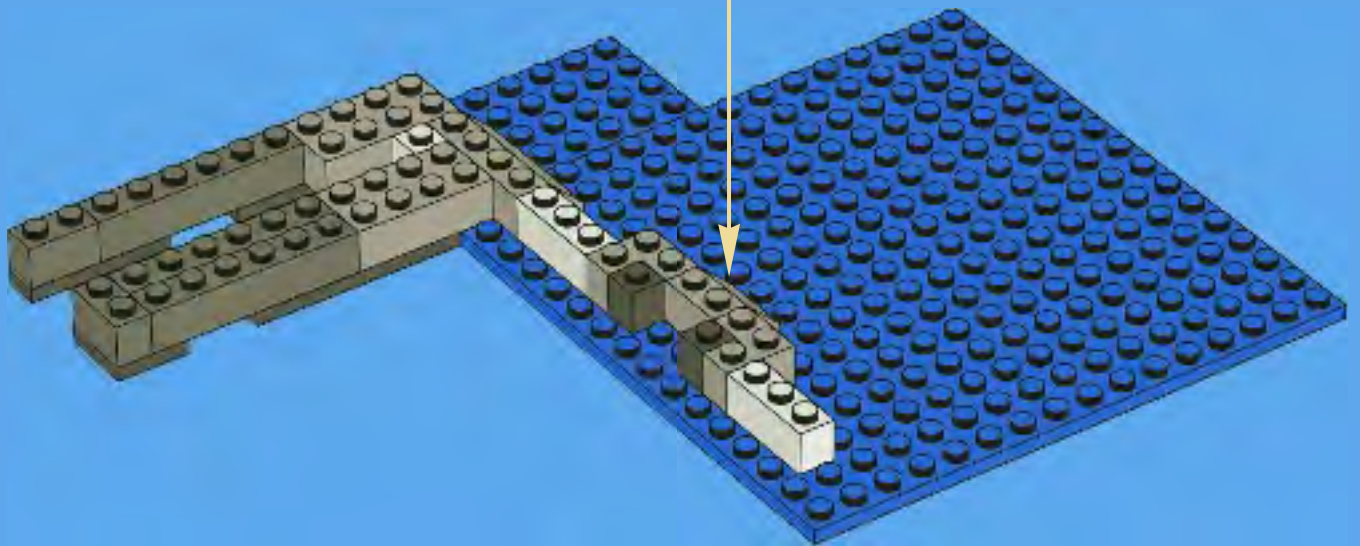
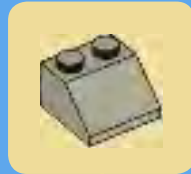

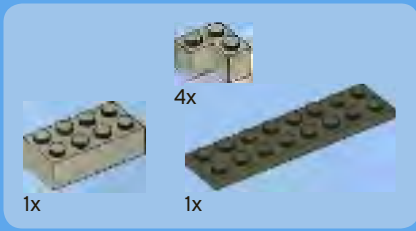

8

1



2

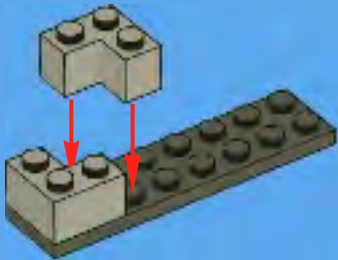

3

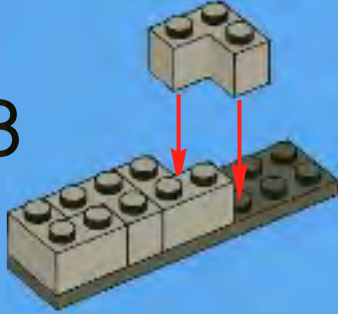

4

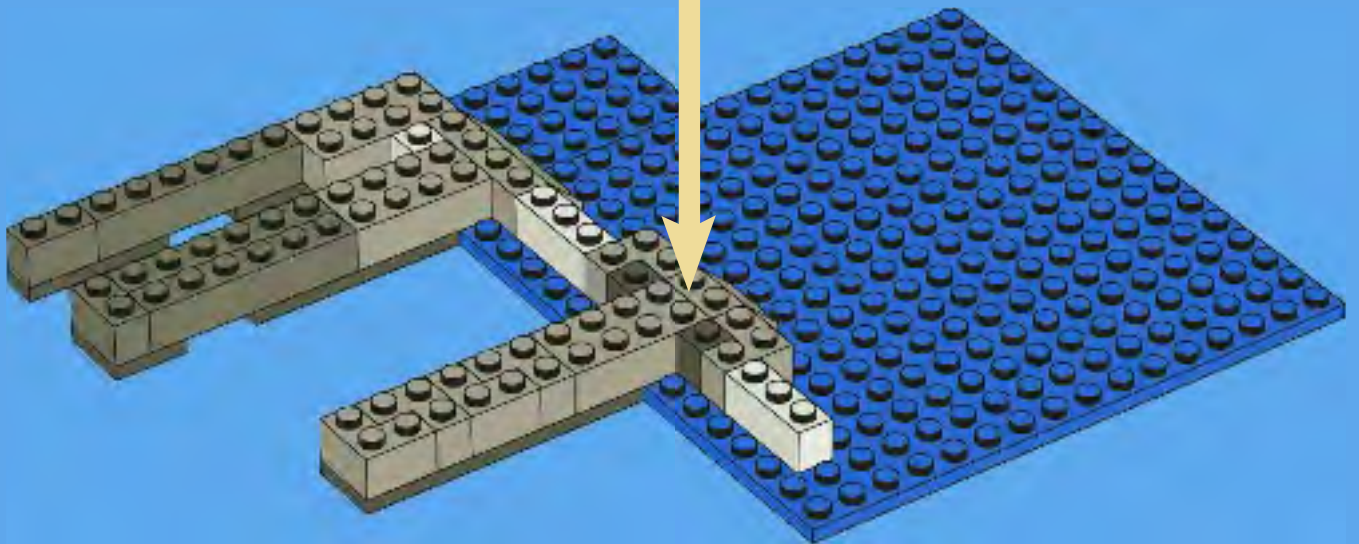
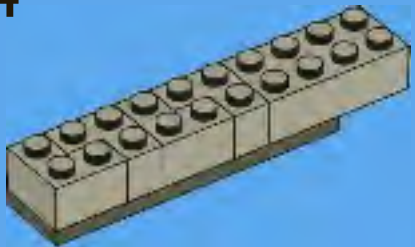

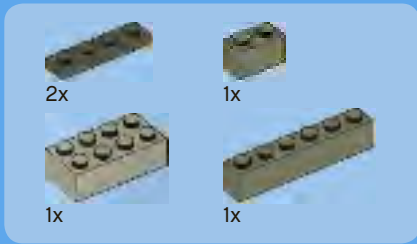

9

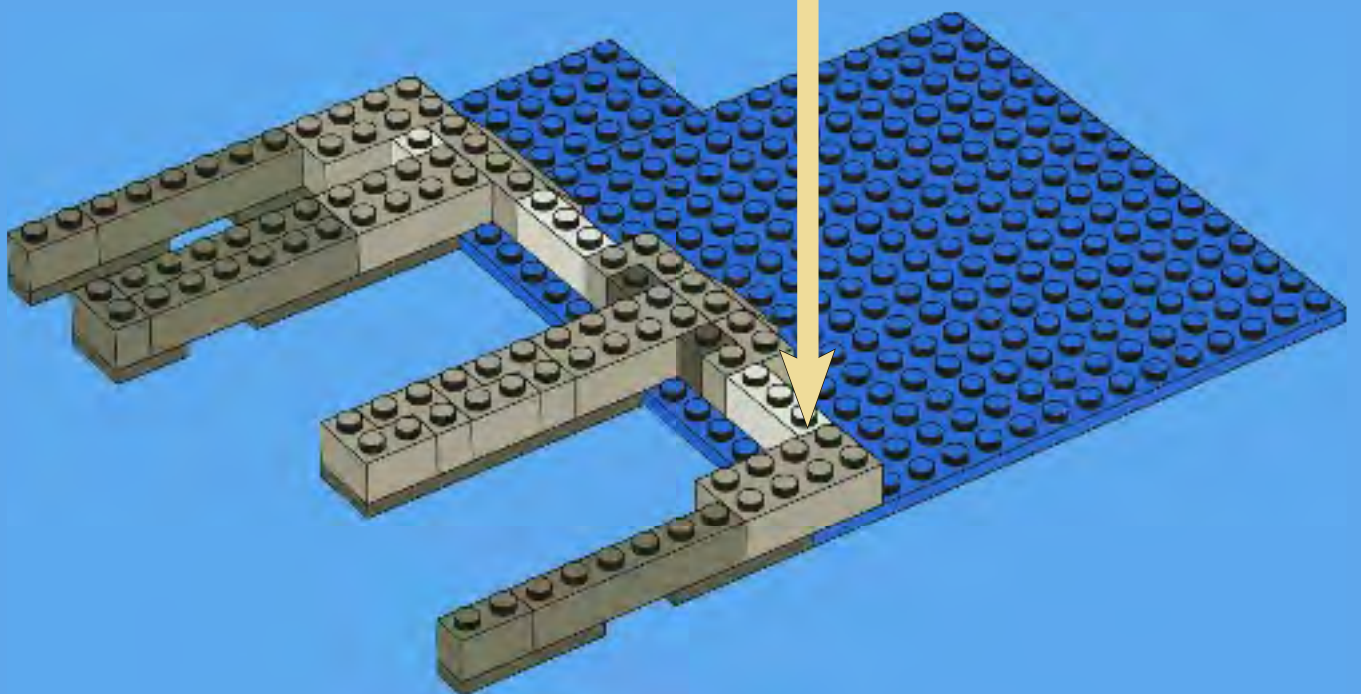
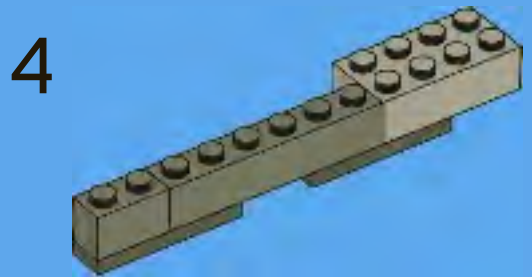
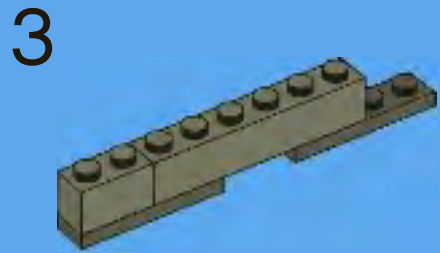
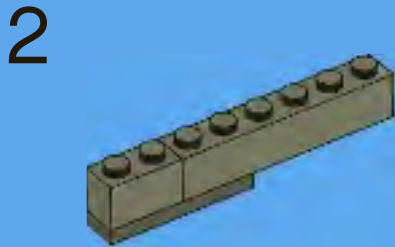
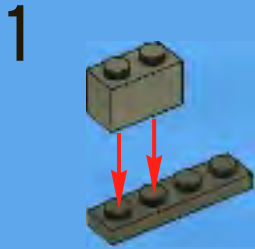



2x



2x

10

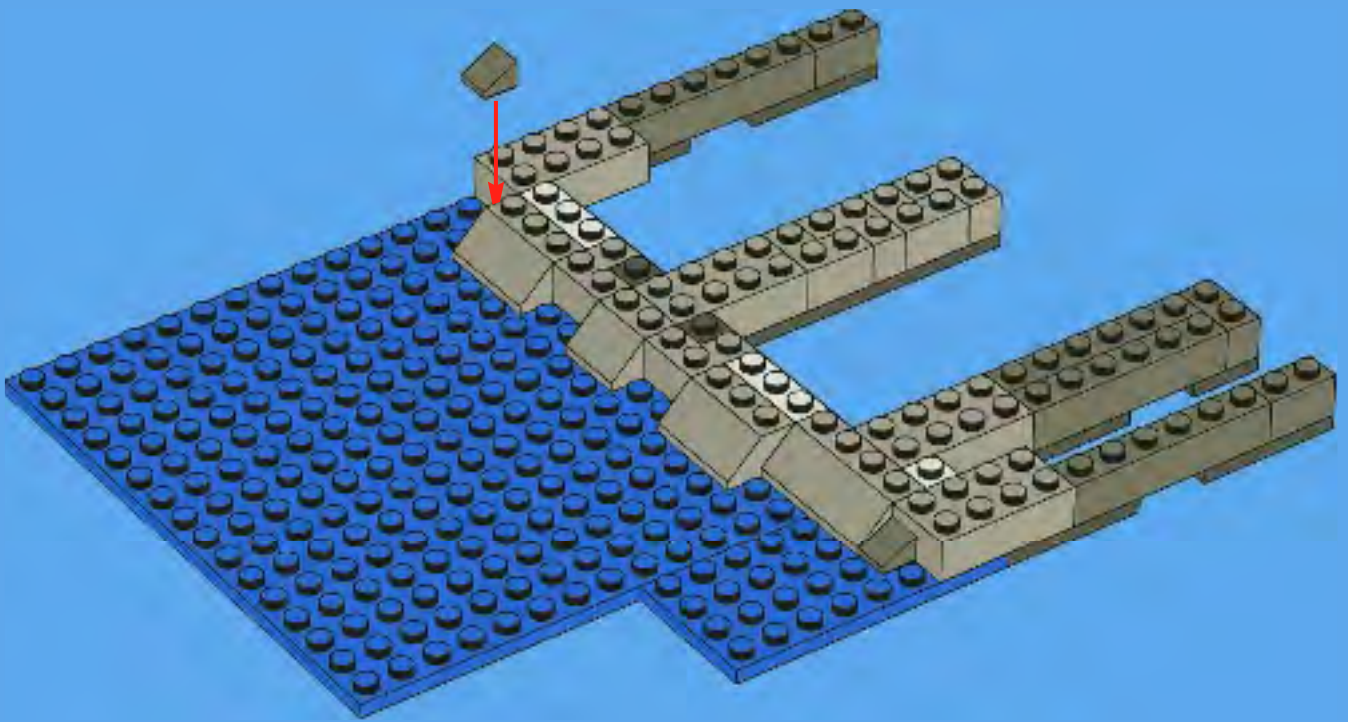



4x



2x

11

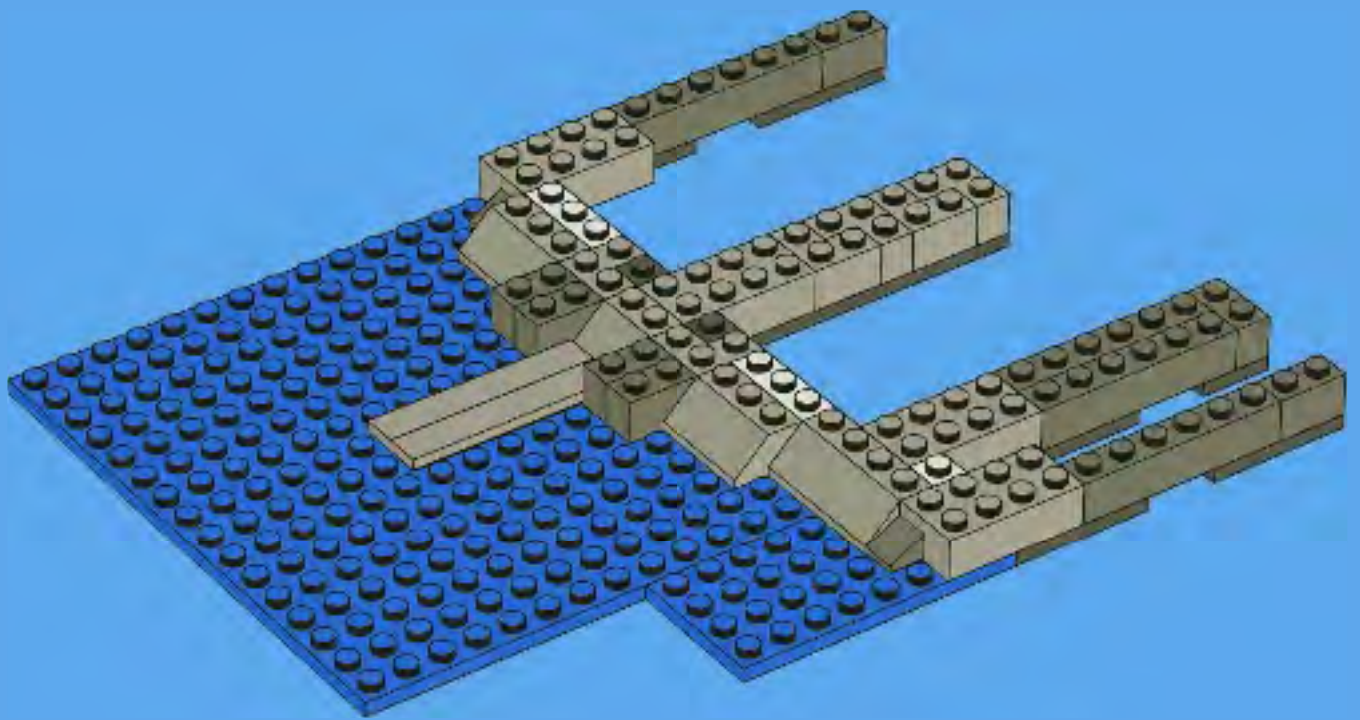

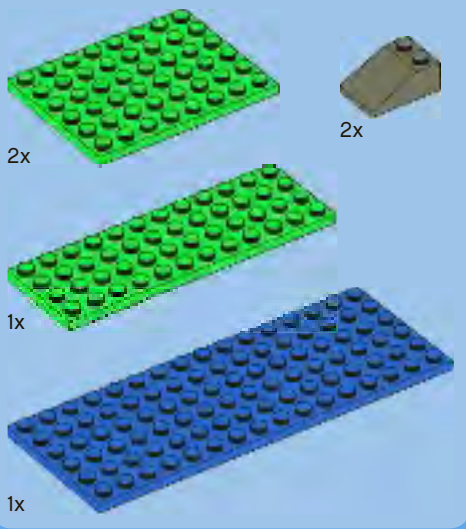

12

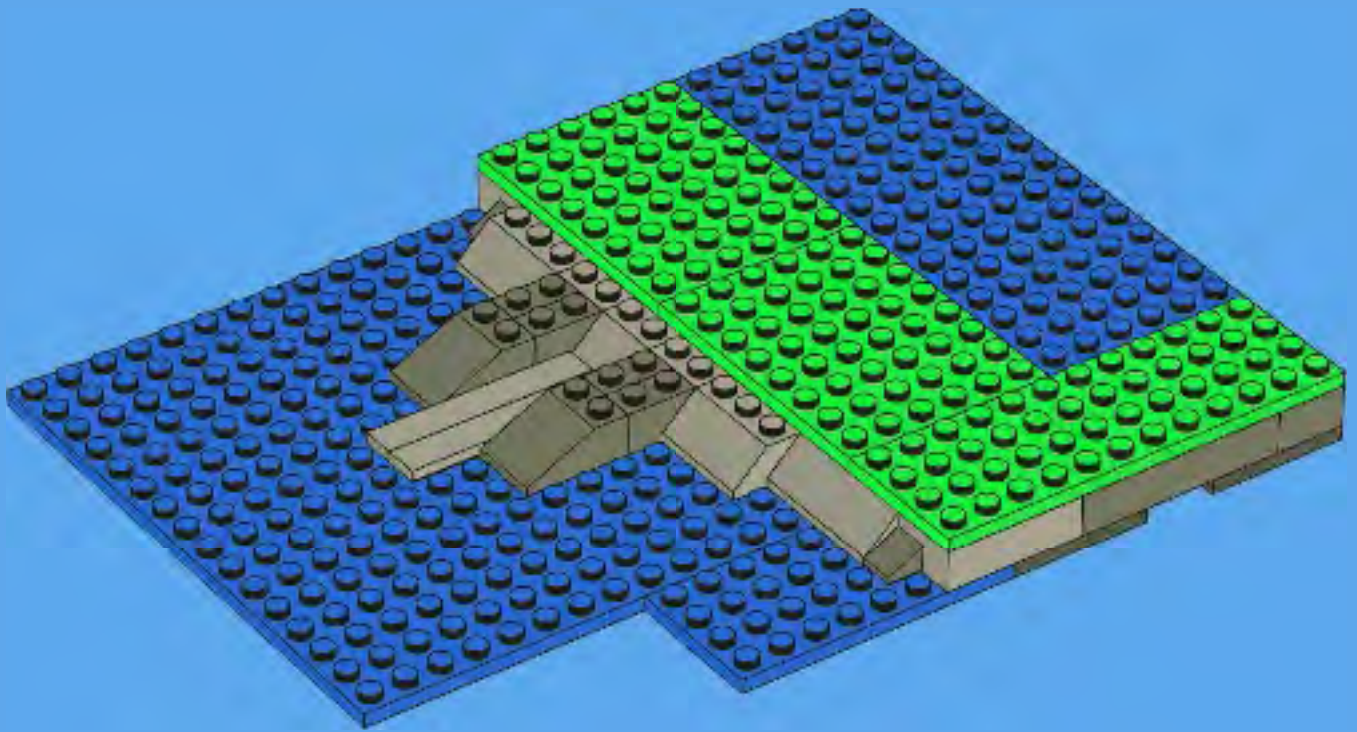



1x



1x

13

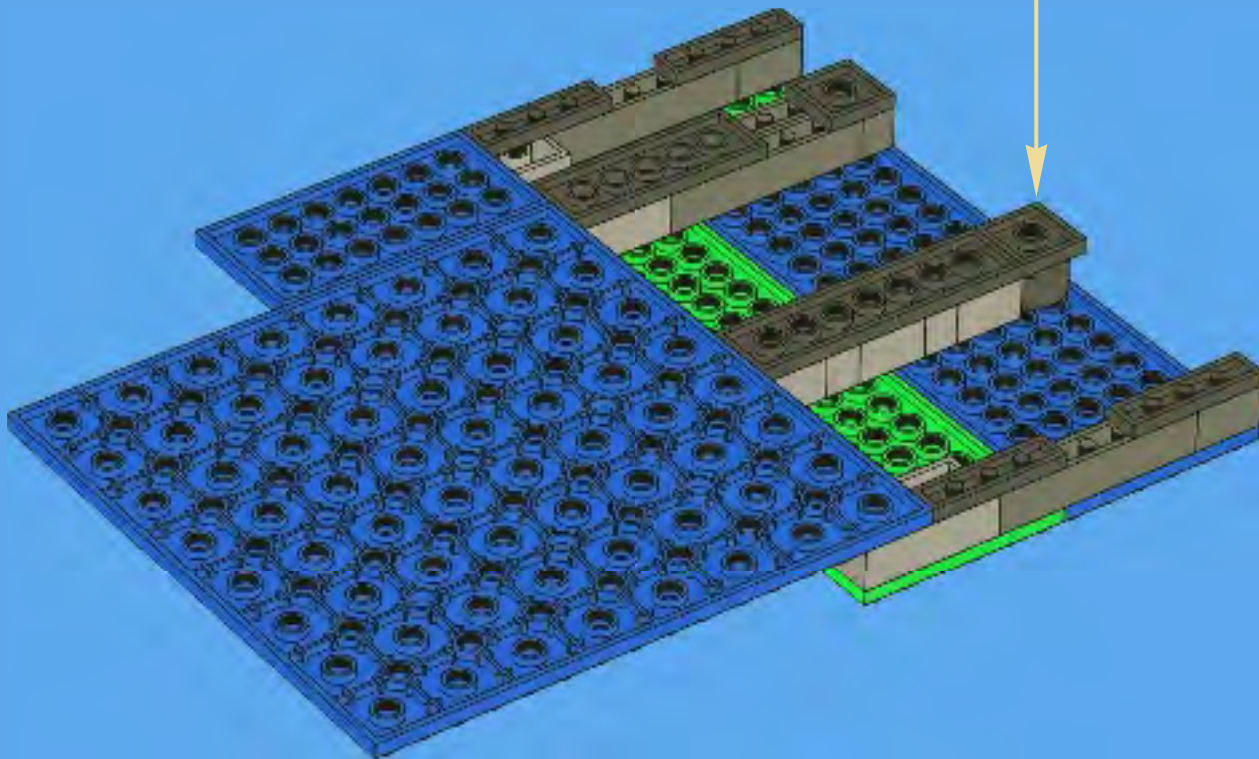



1x



1x



1x



2x



1x

14

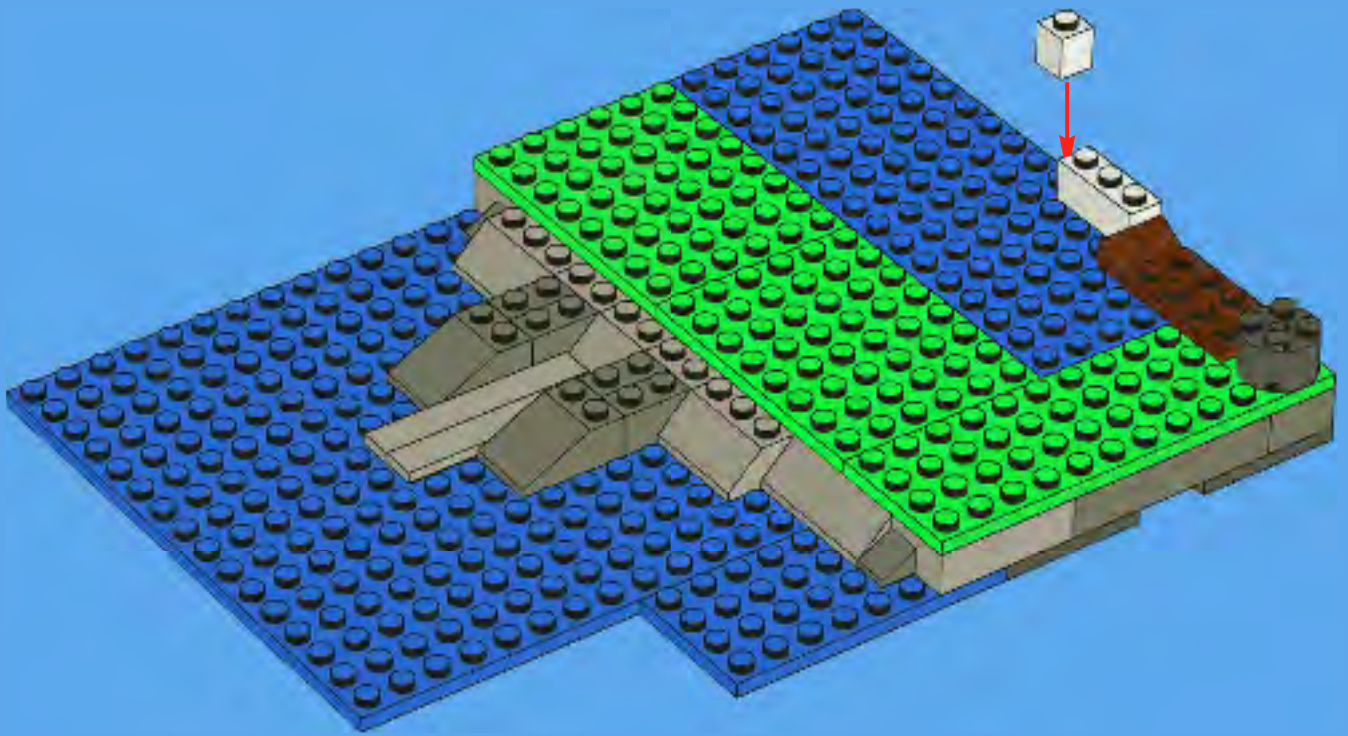



2x



1x



1x

16

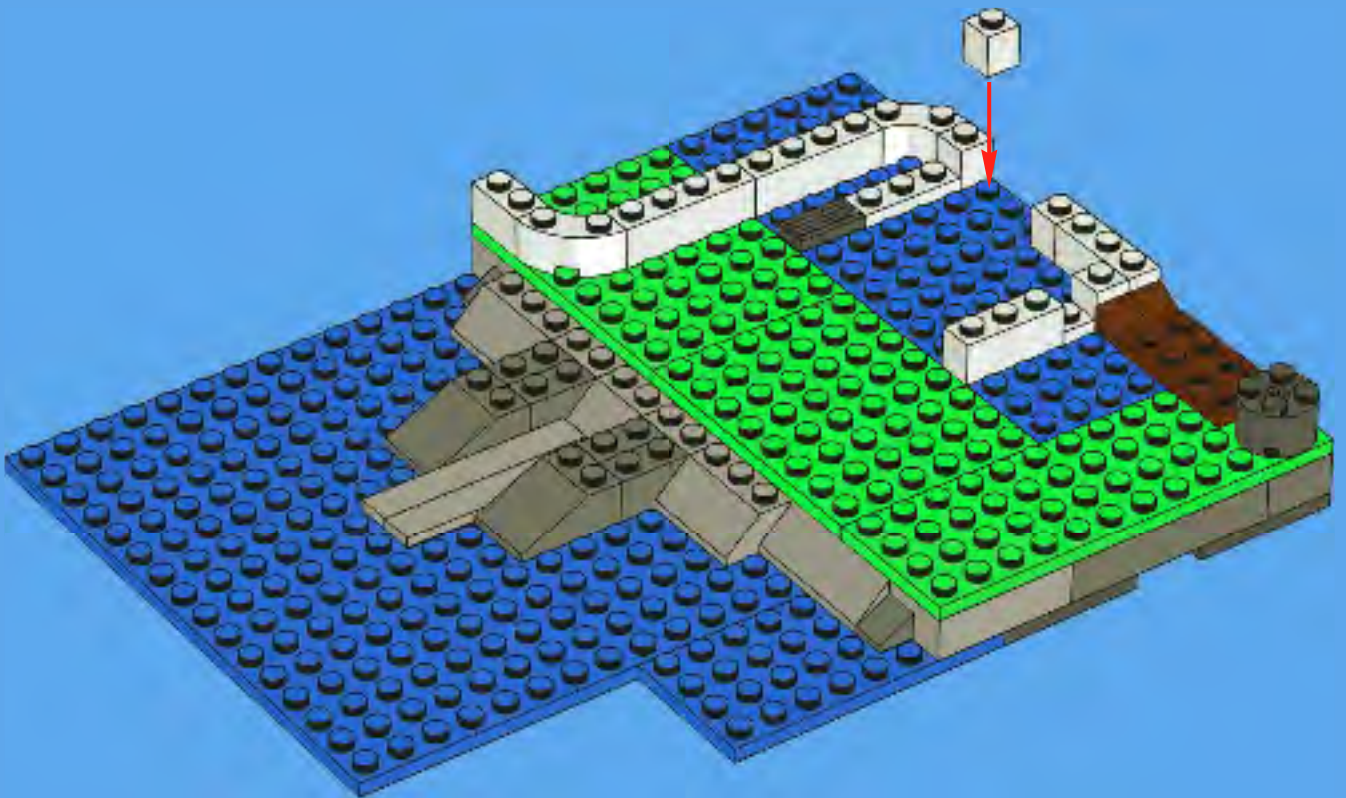

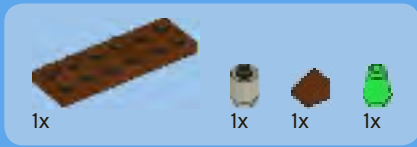

17

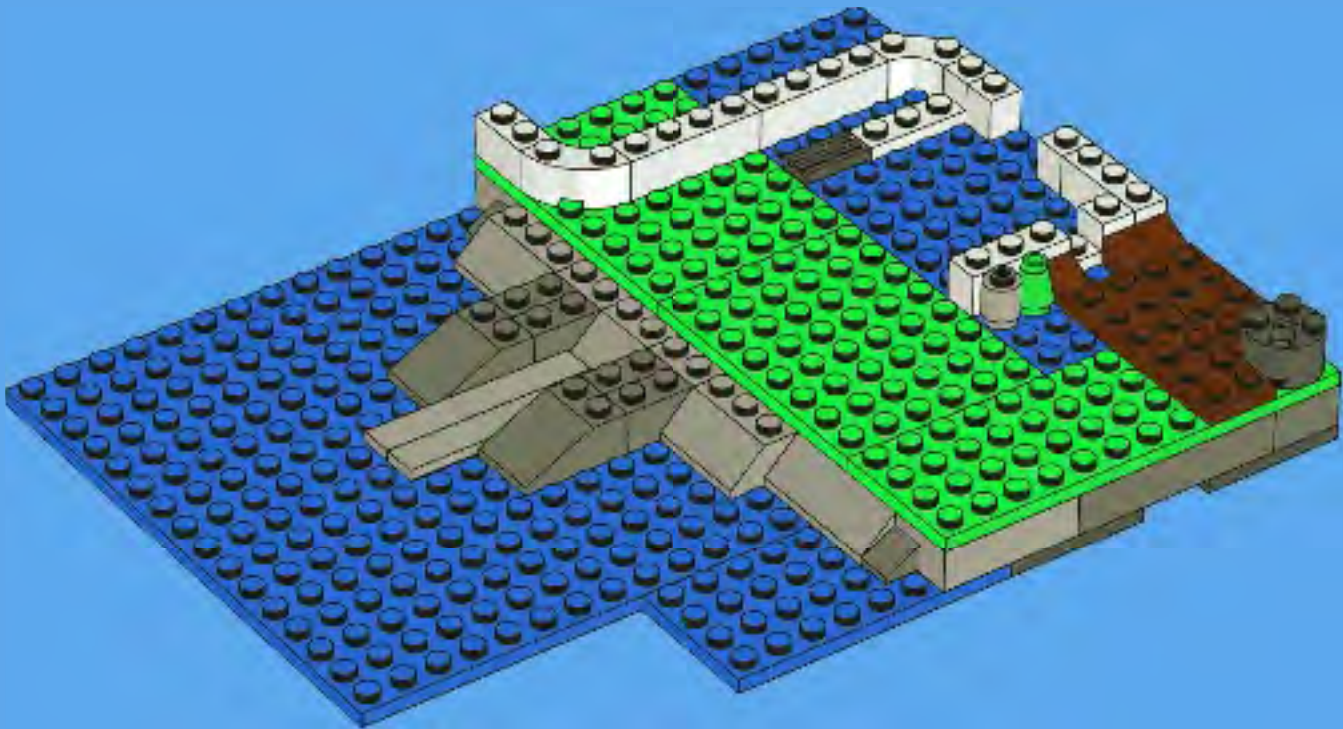



1x



1x

1



1x



1x

2



1x



1x

3



1x

4

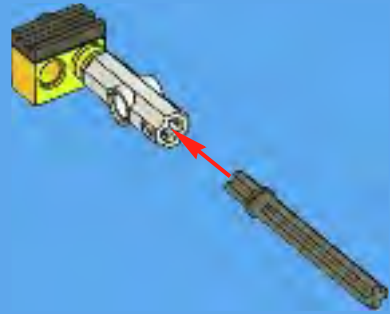

2x

5

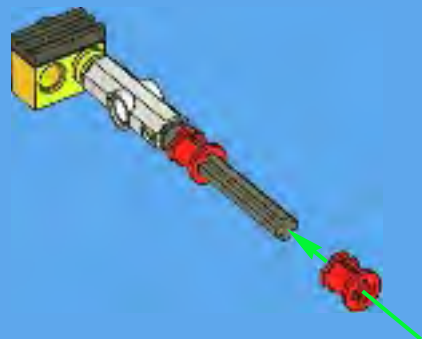



1x



1x

6

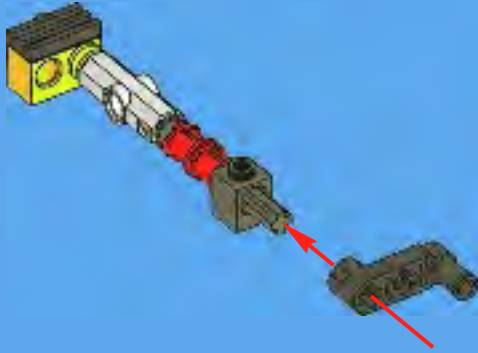

1x



1x

7

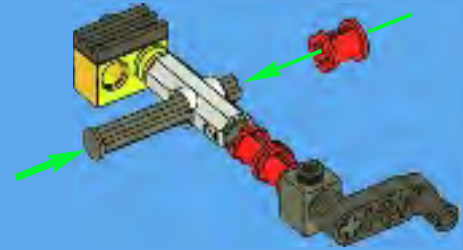

18

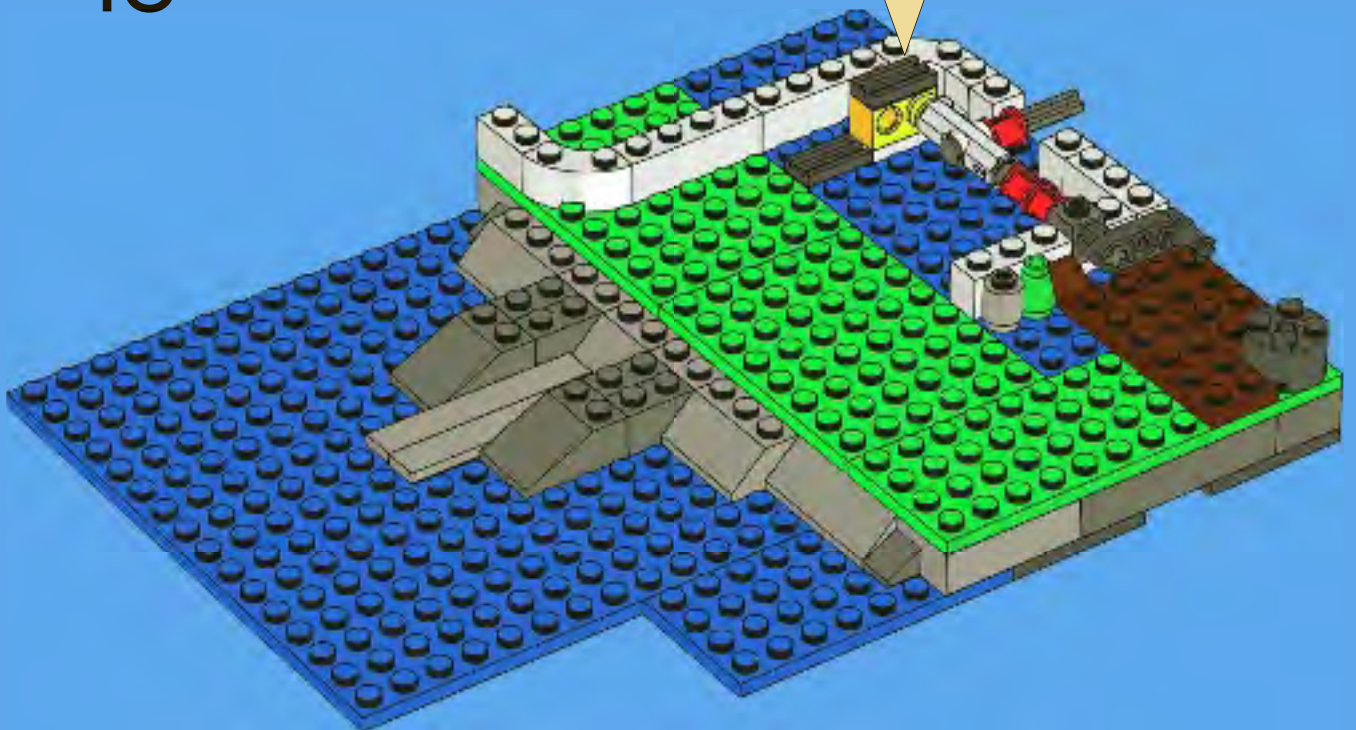

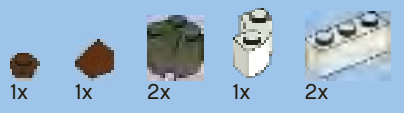

19

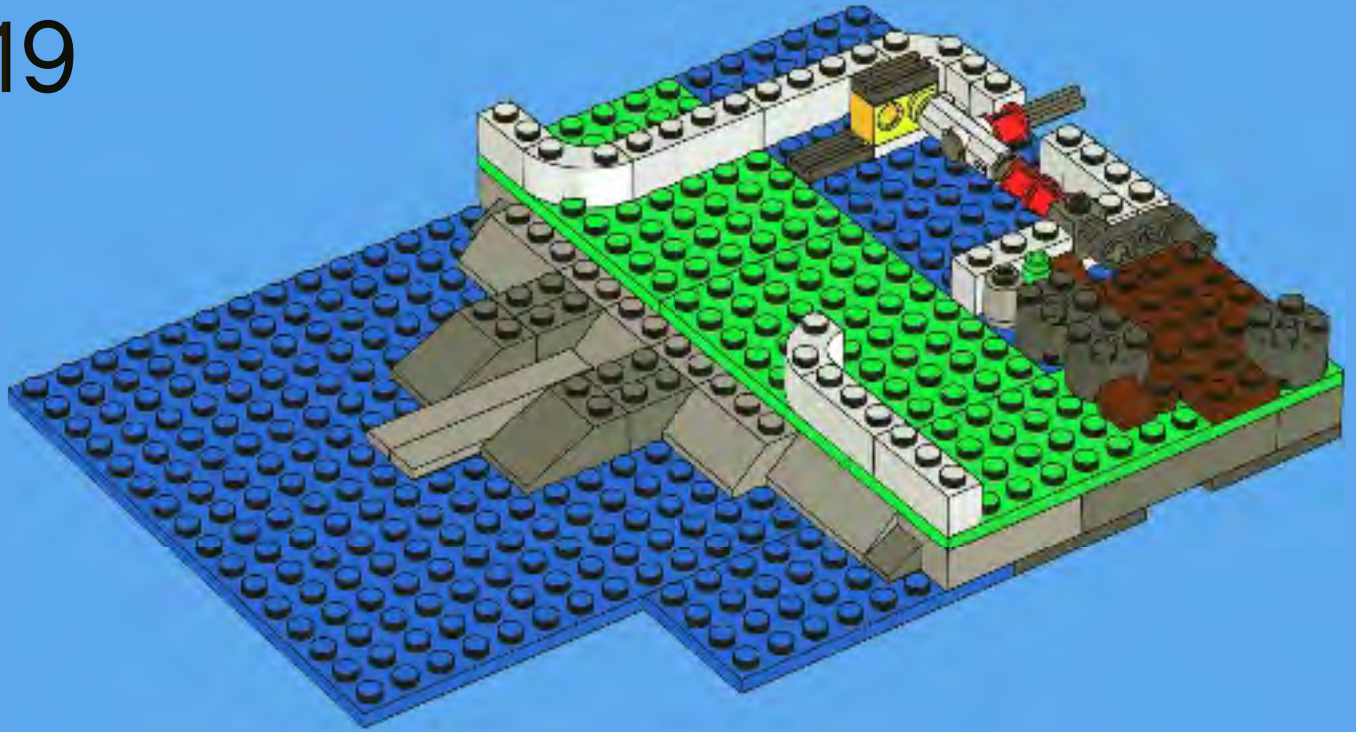

20

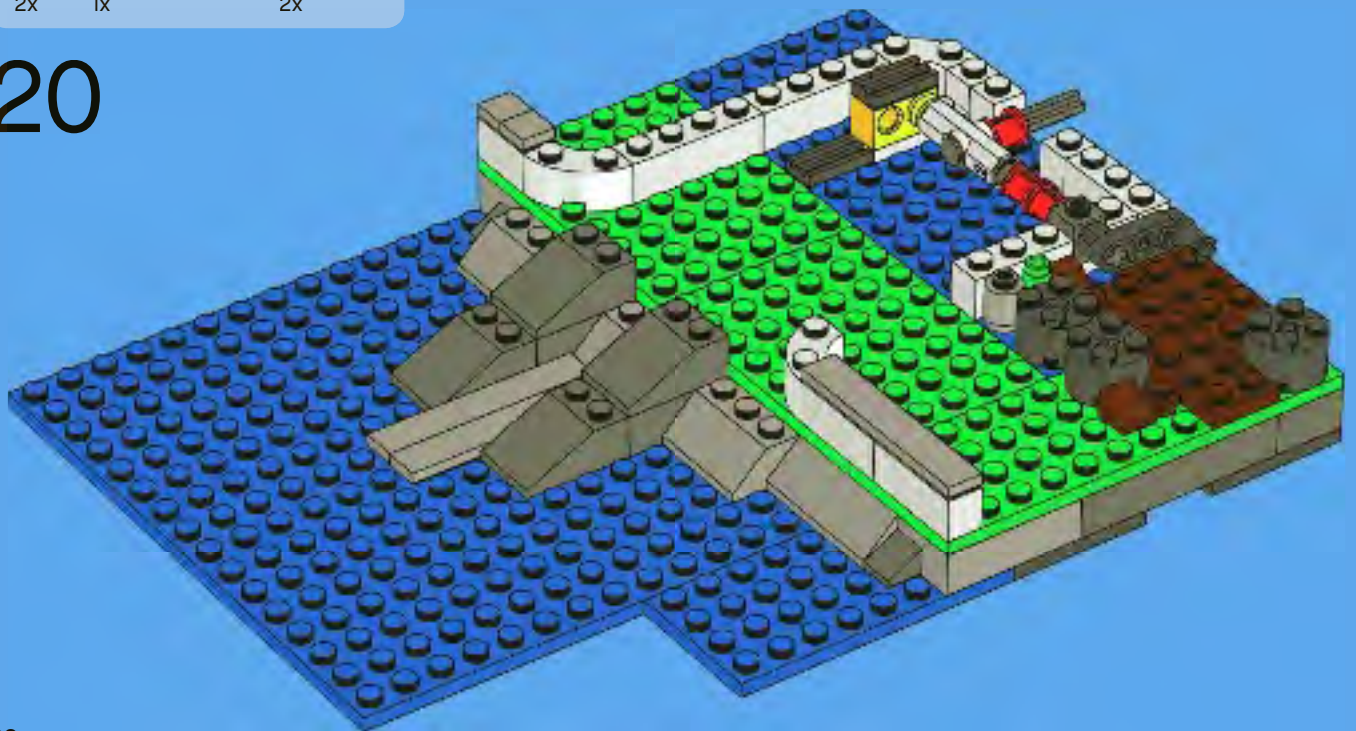



2x



4x

21

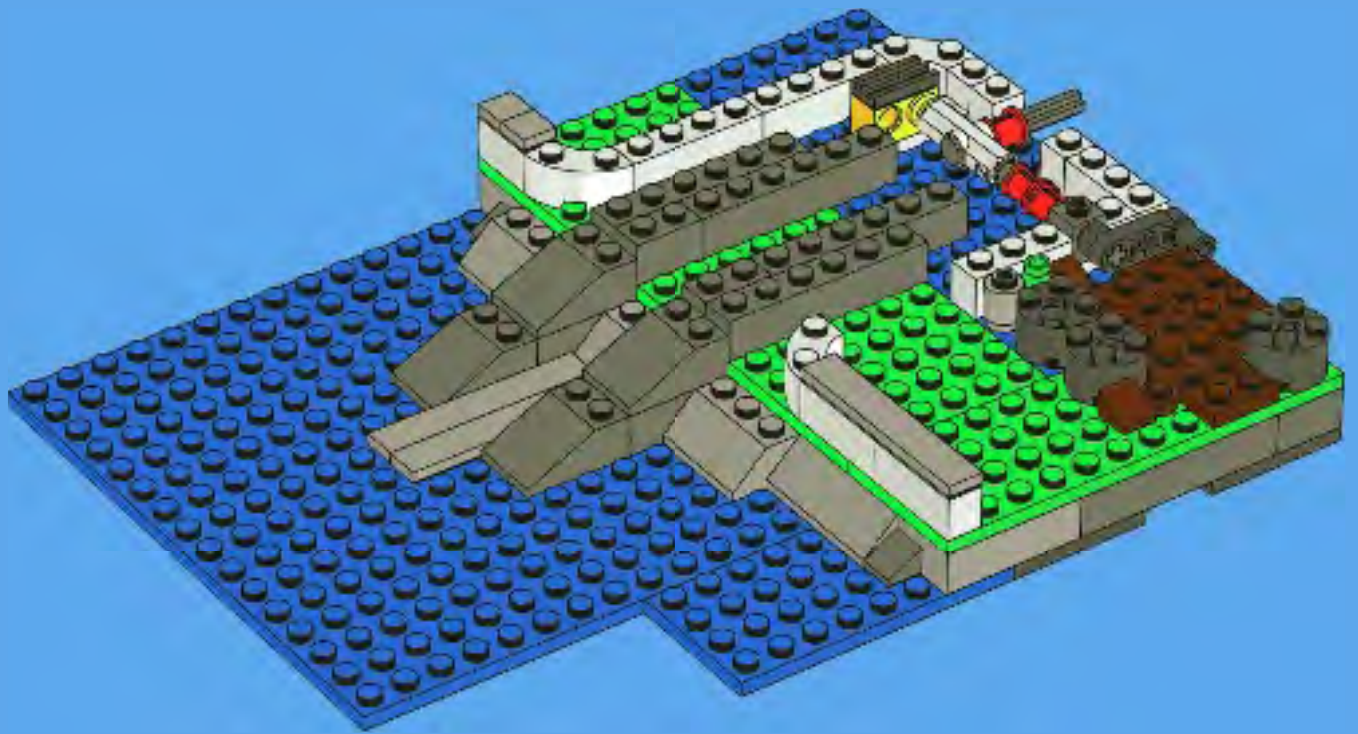



2x



2x



2x



1x

22

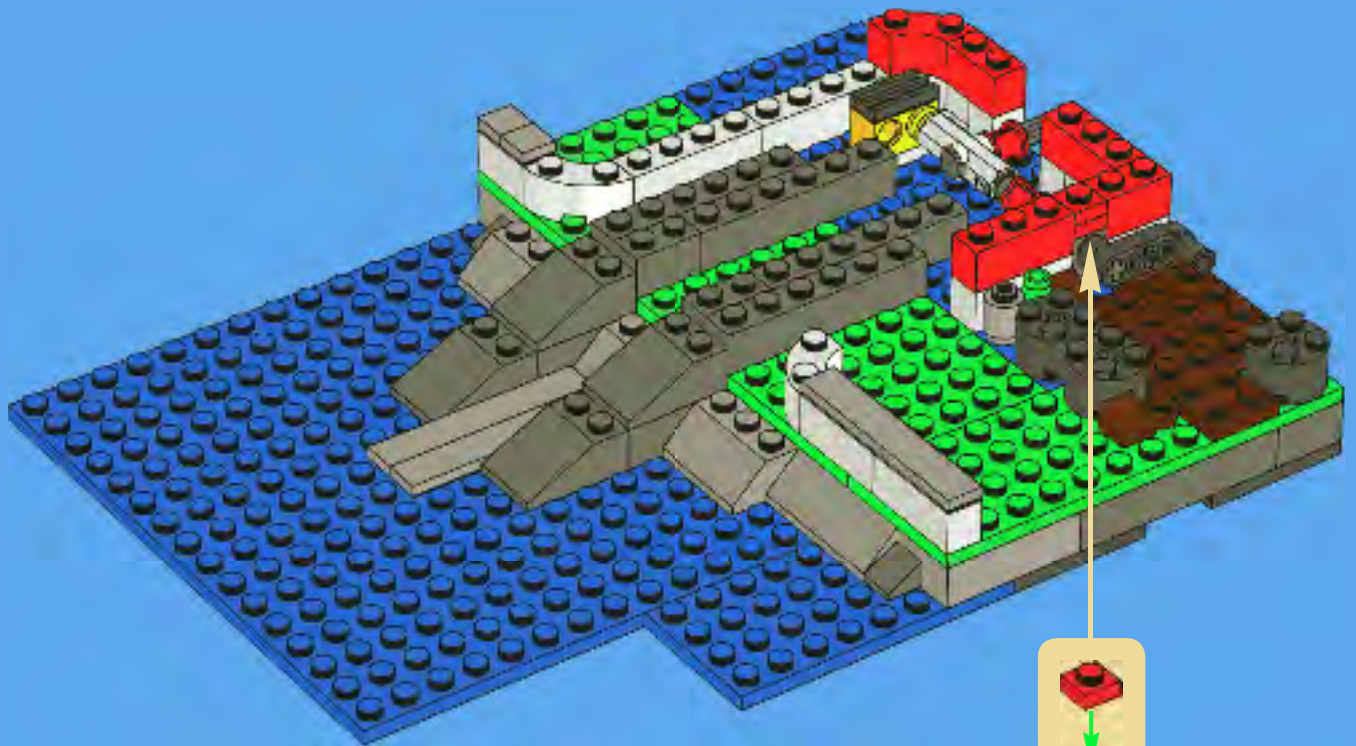



23

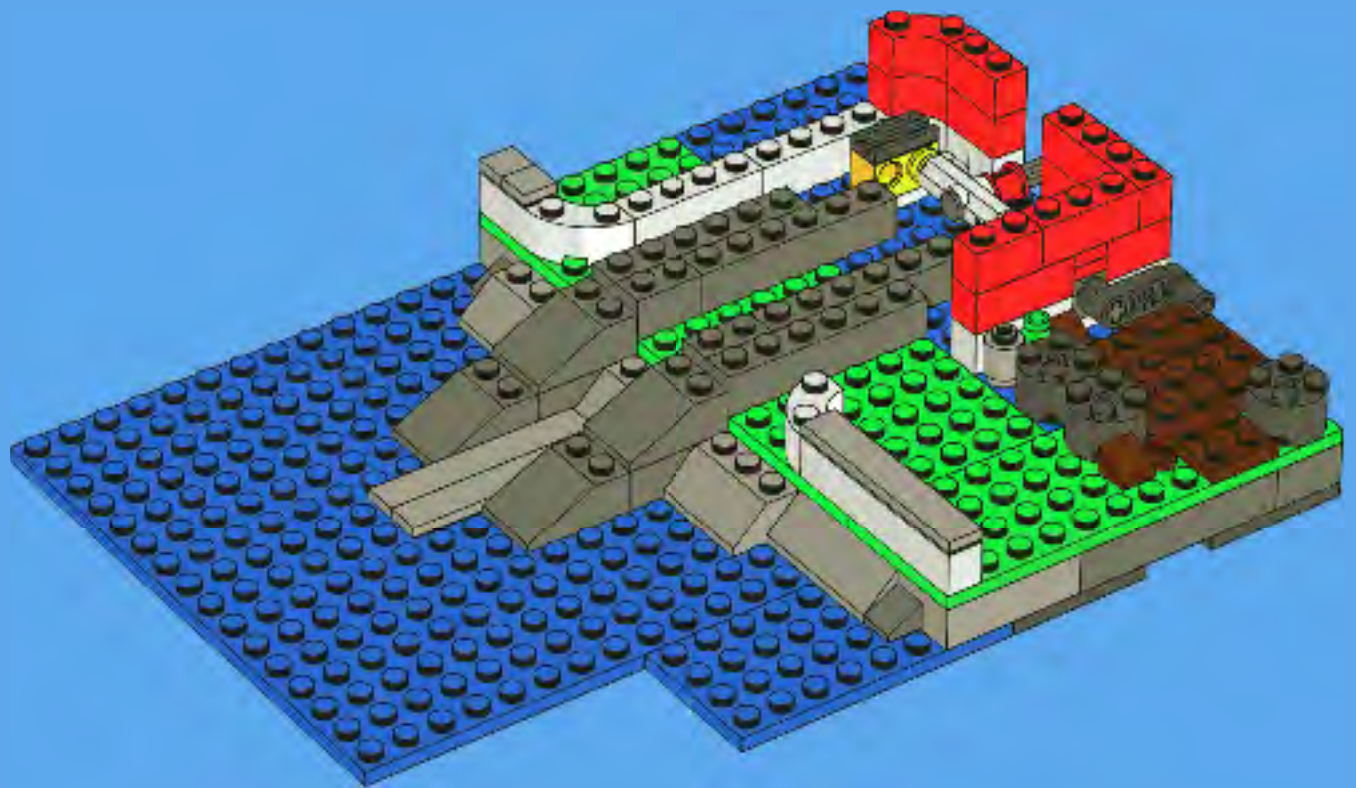



2x



1x



2x



2x



2x



1x



1x

24

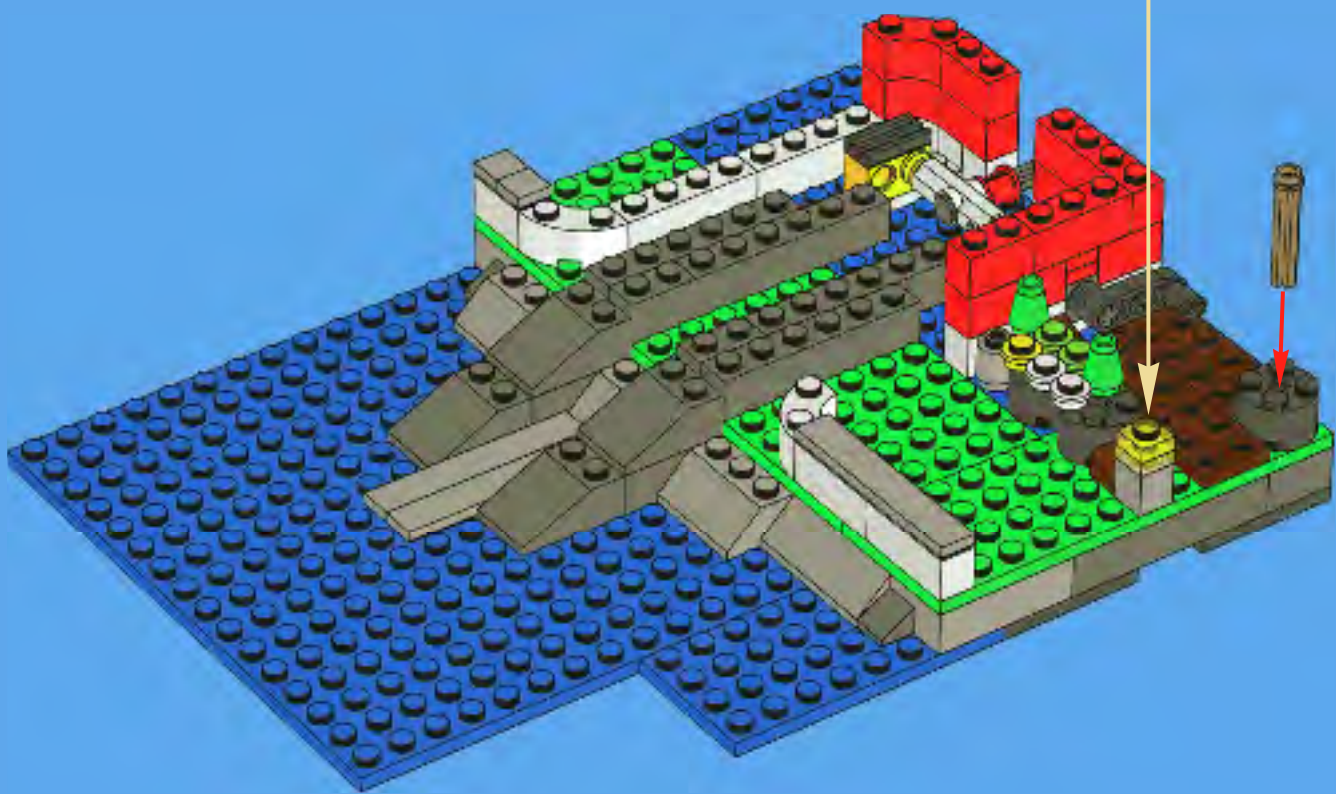



1x



1x



1x



1x



1x



1x

25

1

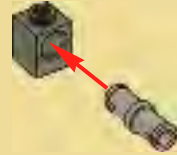

2

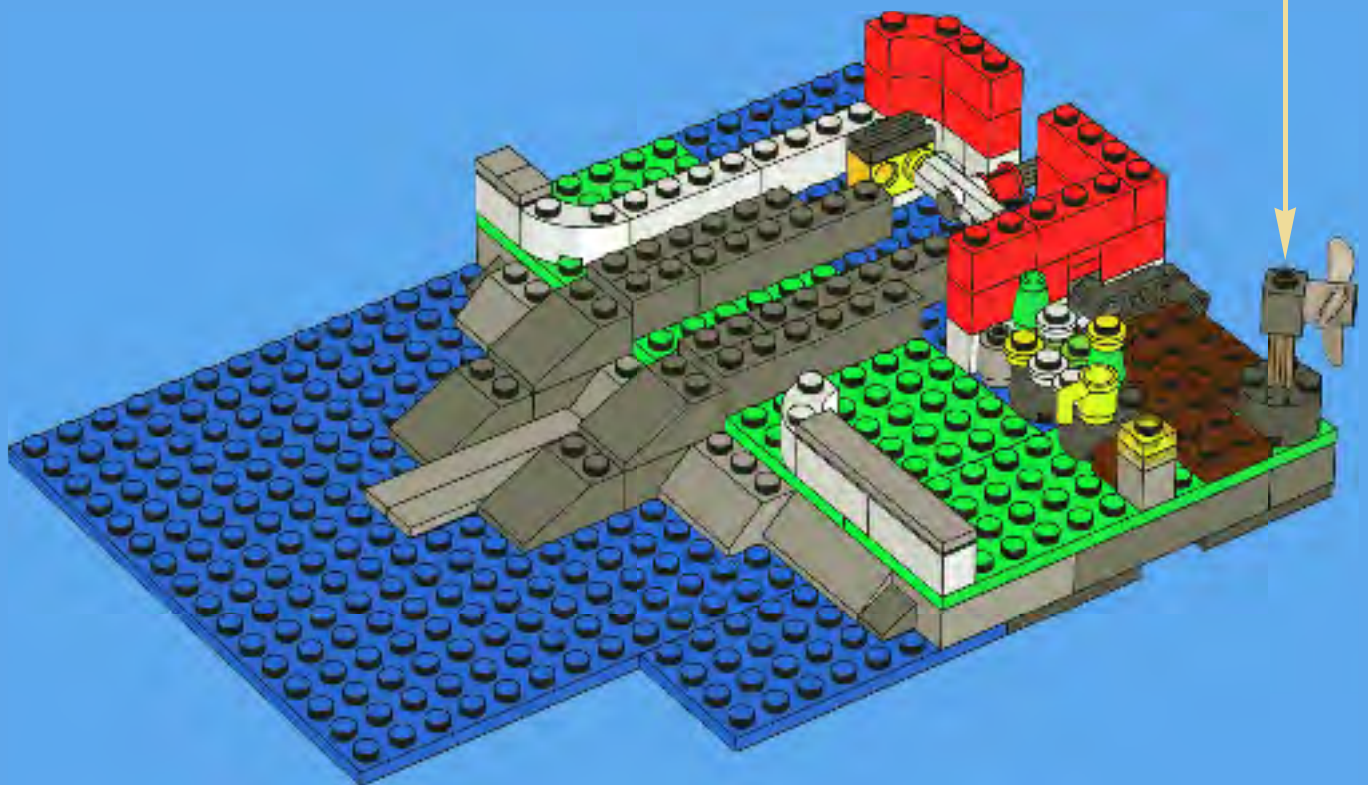



2x



2x



1x



2x



1x



1x

27

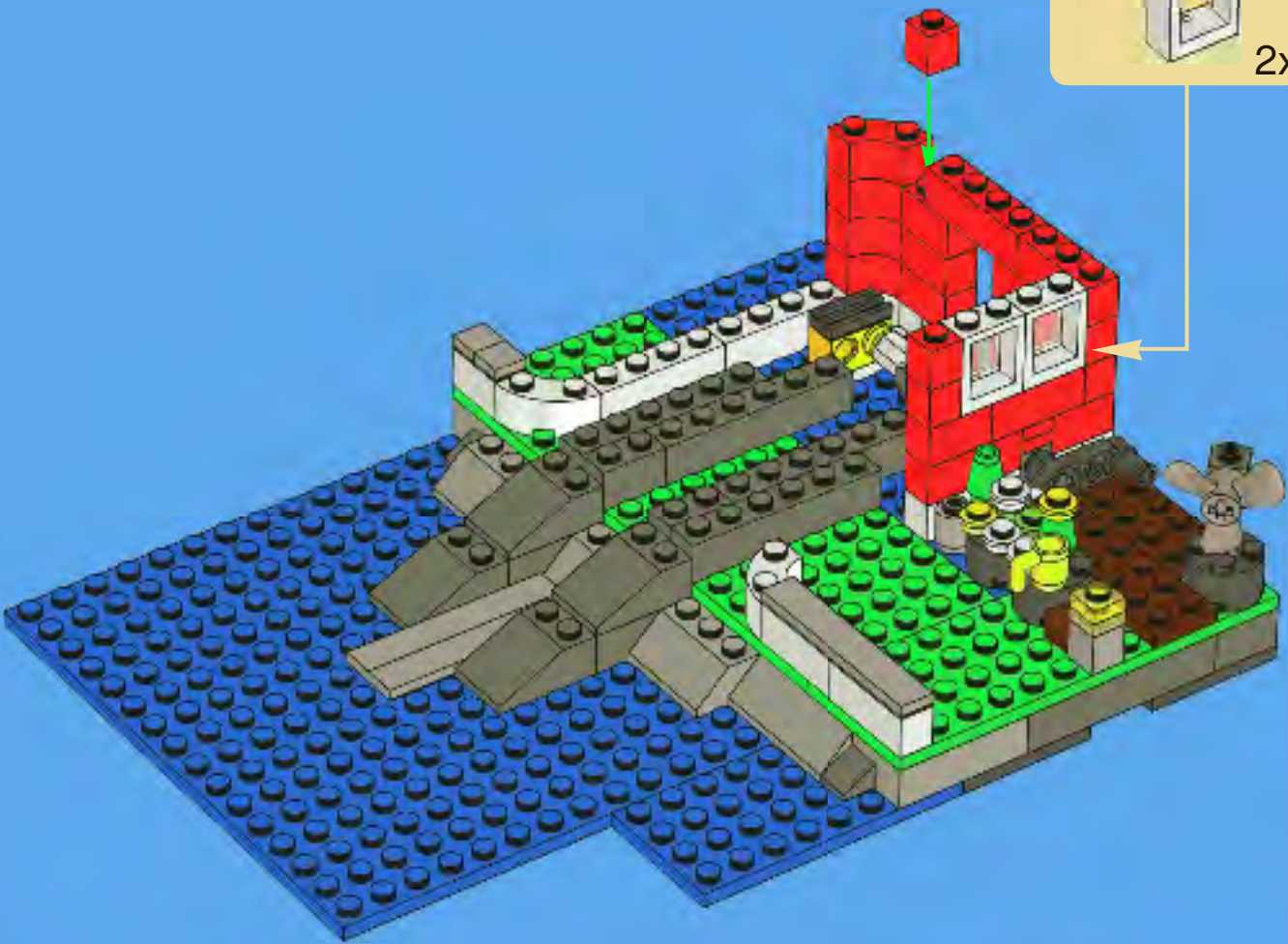
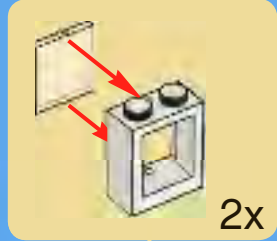



28

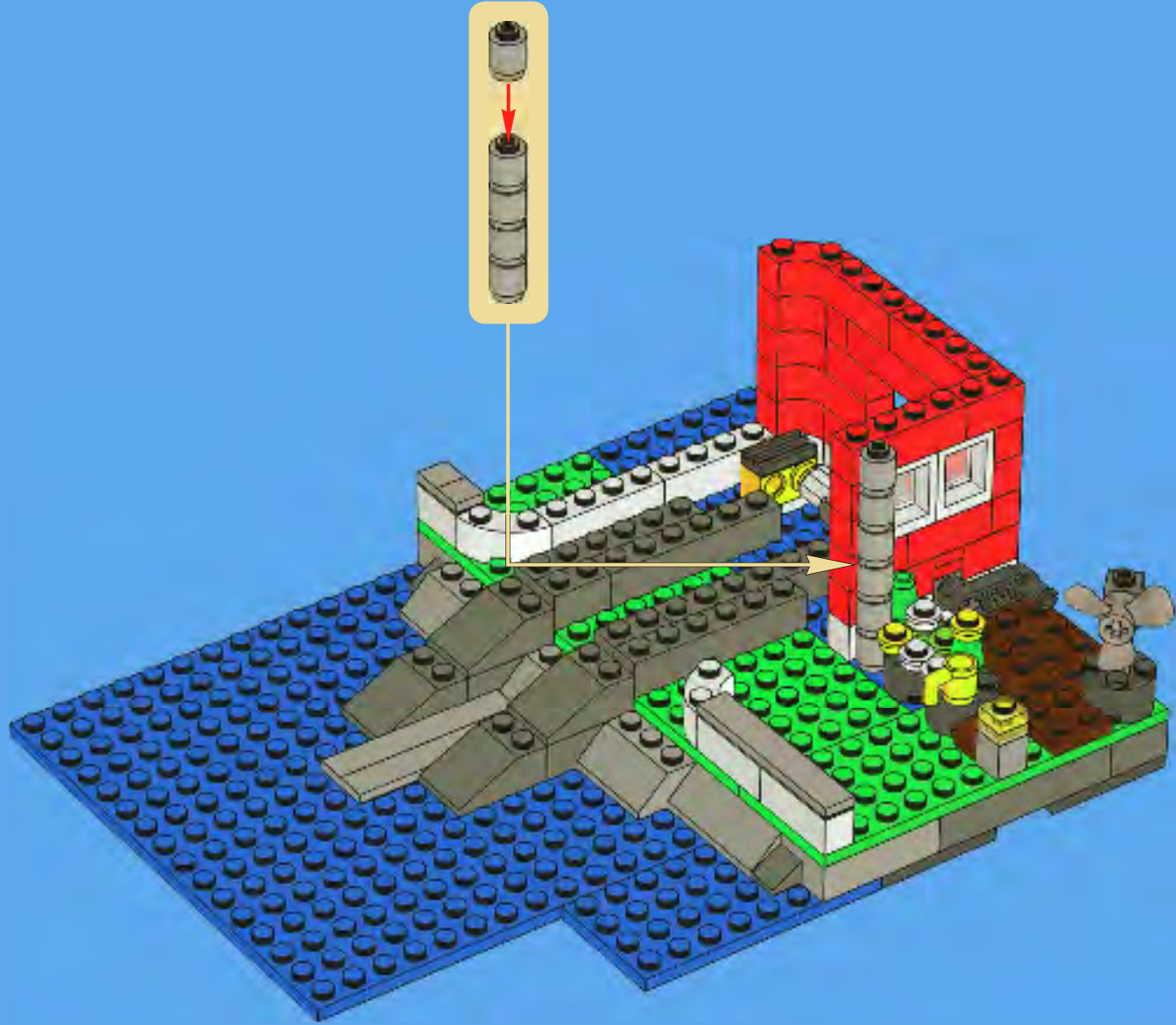



29

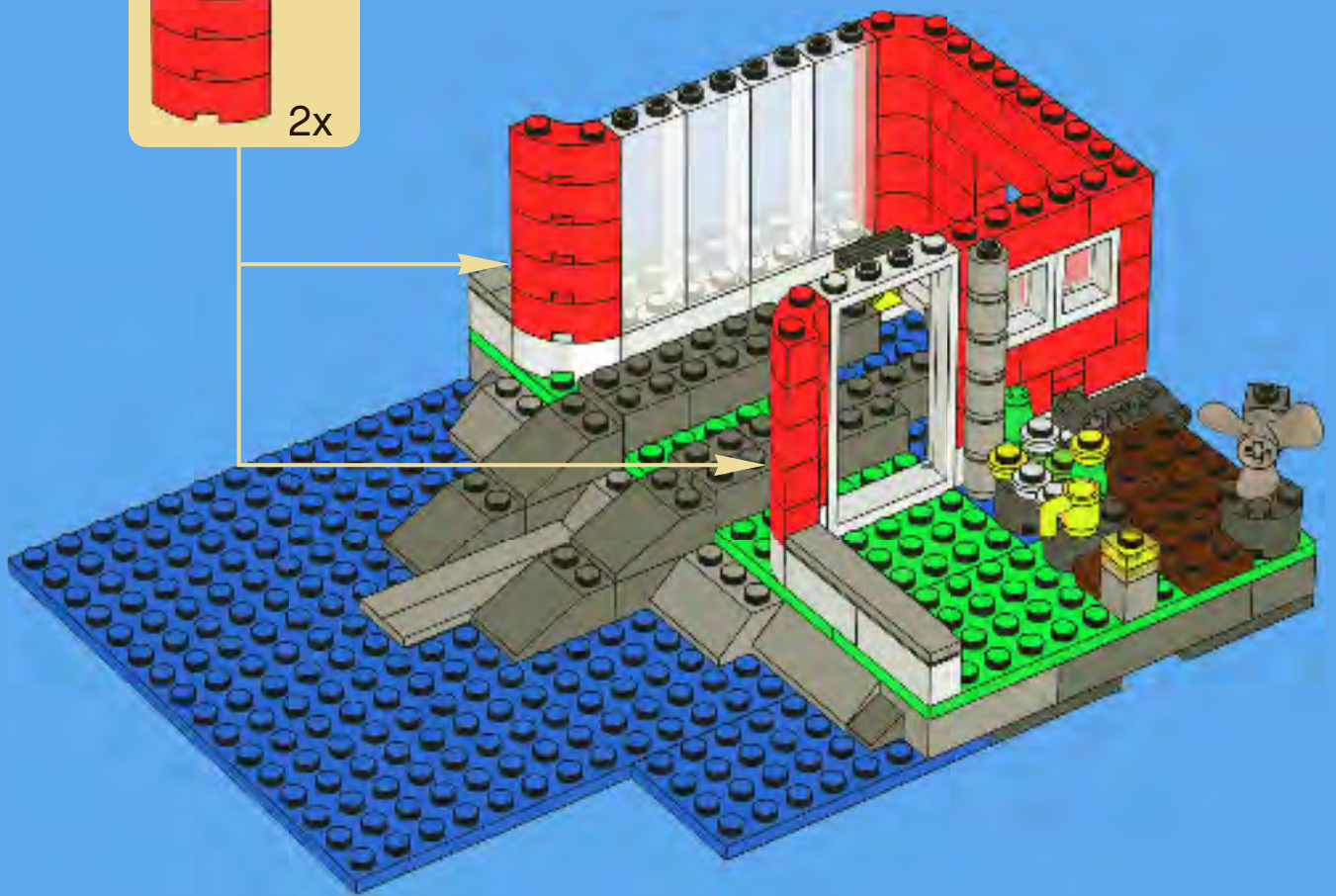
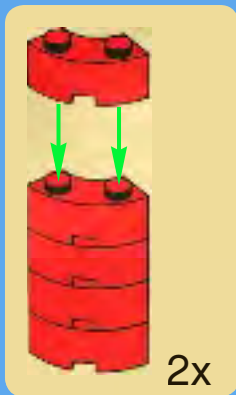



4x



4x



2x



8x

30





31





2x

1

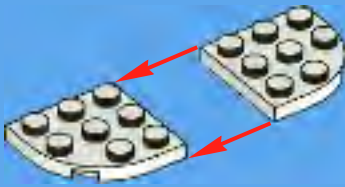

1x



1x

2



2x

3



1x

4



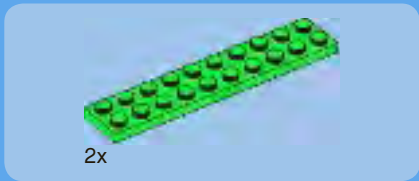

5

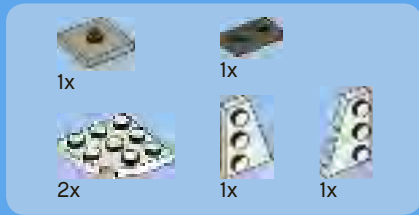
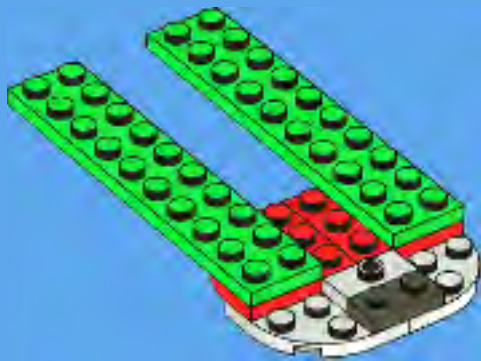

6

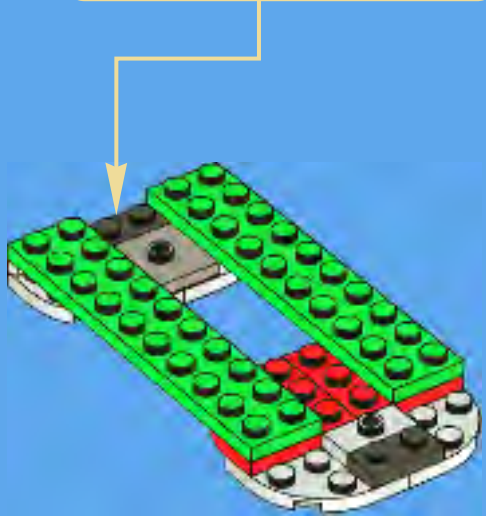



2x

7

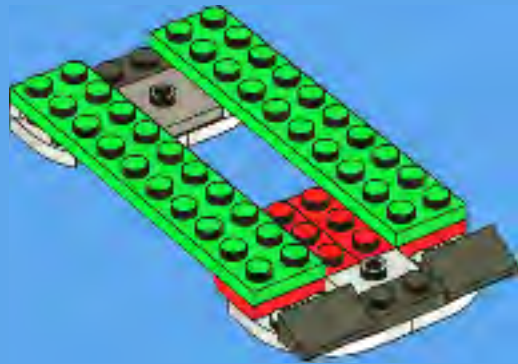

32



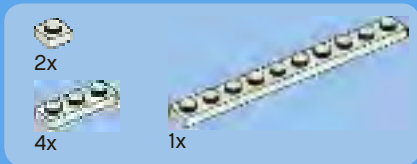

33

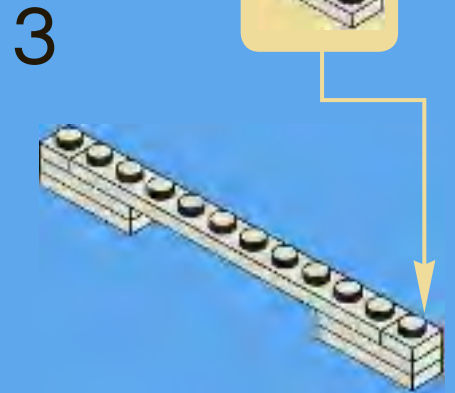
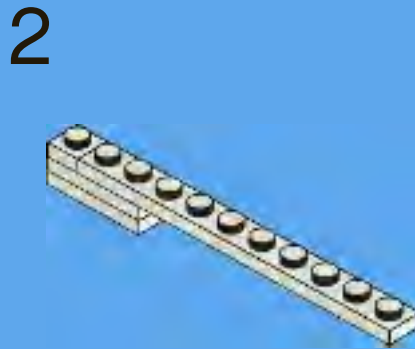
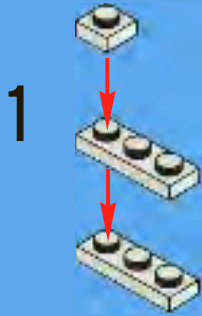

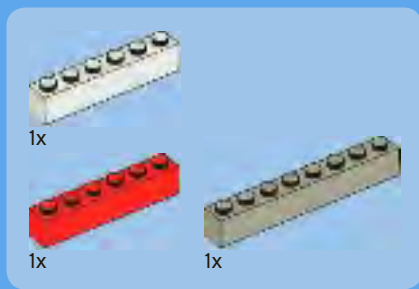

34





1x



2x



2x

35





36





1x



1x



1x

37





1x



2x



1x



2x

38



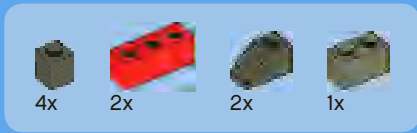

39





1x



1x

40

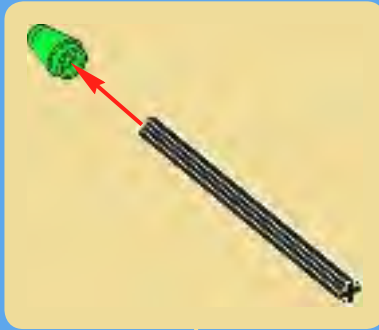

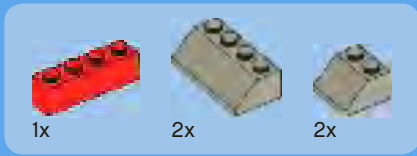

41

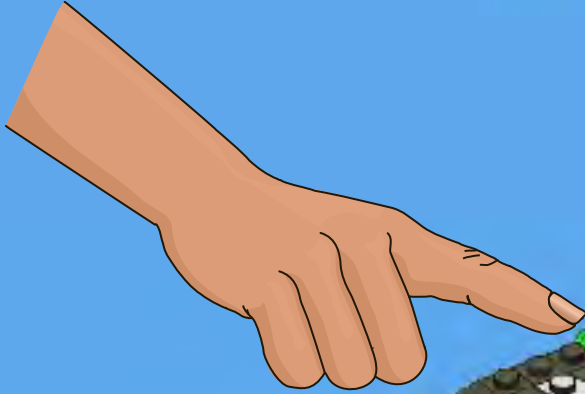

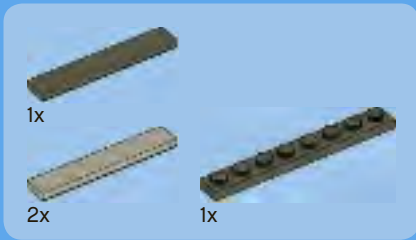

42

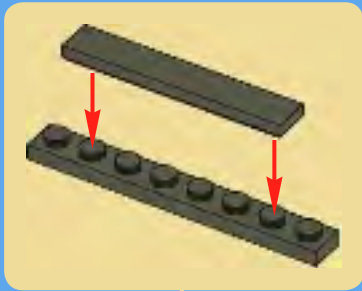



2x



1x



2x

43





1x



4x

44





45





1x



2x

46



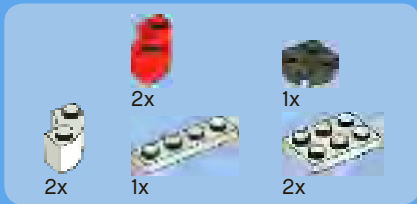

47

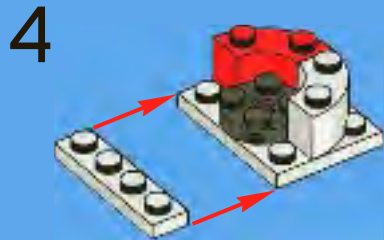
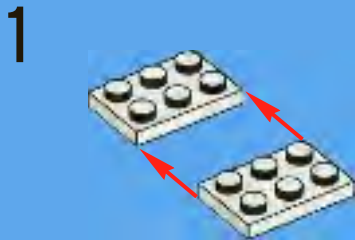

- 2x
- 2x
- 2x
- 2x
- 2x
- 2x
- 1x

48

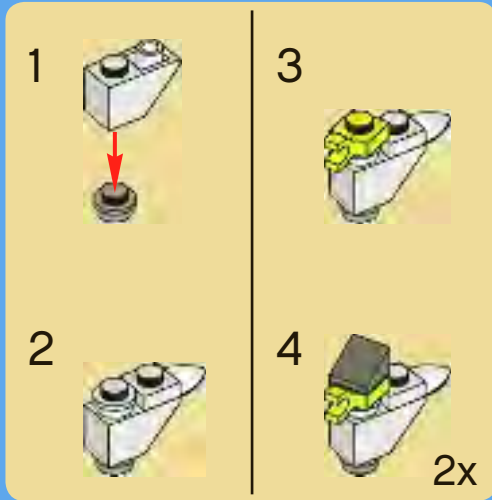





WIN!

Go to www.LEGOsurvey.com/product to fill out a survey for a chance to win a cool LEGO® Product. No purchase necessary. Open to all residents where not prohibited.

 www.LEGO.com



www.LEGOsurvey.com/product

GEWINNE!

Nimm an der Umfrage auf www.LEGOsurvey.com/product teil und hab die Chance ein cooles LEGO® Produkt zu gewinnen!

Die Teilnahme am Gewinnspiel führt zu keinerlei Kaufverpflichtungen. Teilnahme in allen nicht ausgeschlossenen Ländern möglich.

WIN!

Ga naar www.LEGOsurvey.com/product, vul een enquêteformulier in en maak kans op een cool LEGO® product.

Geen aankoopverplichting. Iedereen mag deelnemen, uitgezonderd ingezetenden van landen waar een enquêteverbod geldt.

GAGNE!

Visite www.LEGOsurvey.com/product pour répondre à un questionnaire et avoir une chance de gagner un produit LEGO® très cool!

Aucune obligation d'achat. Ouvert à tous les résidents des pays autorisés.

当てよう!

www.LEGOsurvey.com/product にアクセスして、アンケートにご記入ください。当選者にはレゴ®製品を差し上げます。

お買い上げの必要はありません。

禁止されていない限り、すべての皆様にご利用いただけます。



CREATOR

5770



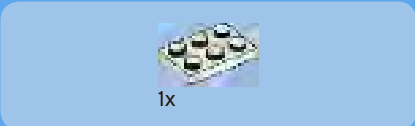

1x

1

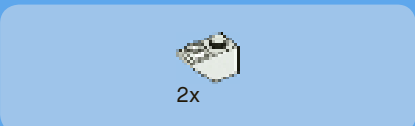

2x

2

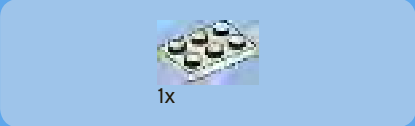
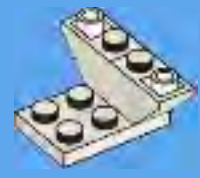

1x

3

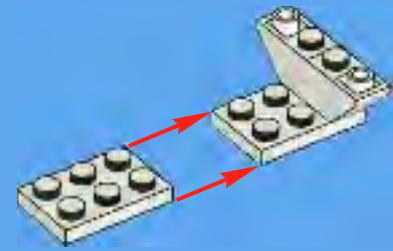



1x

4

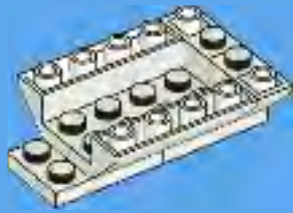

1x

5



1x

6



2x



1x

7

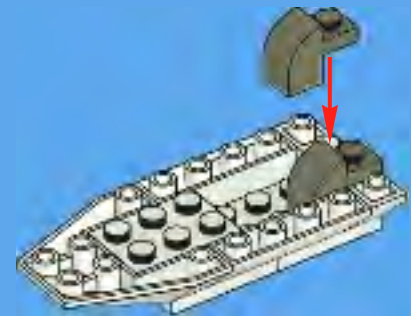



1x



1x

8



2x



2x



2x

9



2x



2x

10

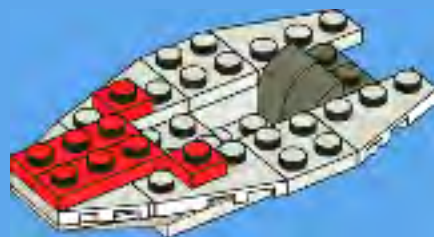



2x



2x



1x

11



1x



1x

12

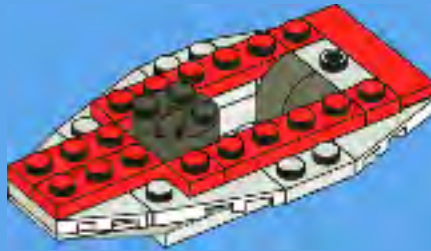

4x



1x

13

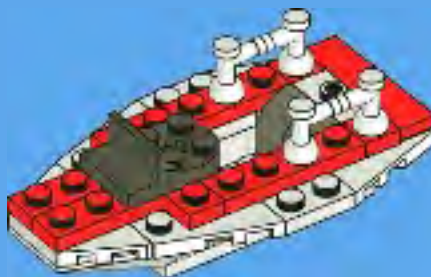



1x



1x

14

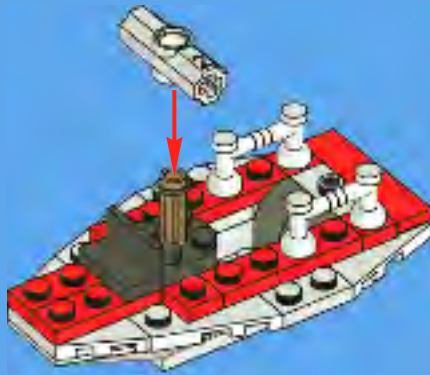

1x



1x

15

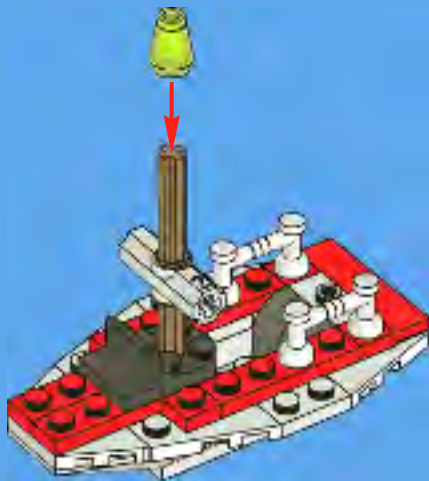

1x



1x



2x



1x



1x

16

1



3



2



4

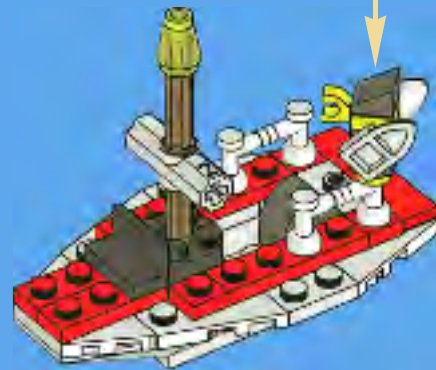



2x



2x

1

1



2



2x

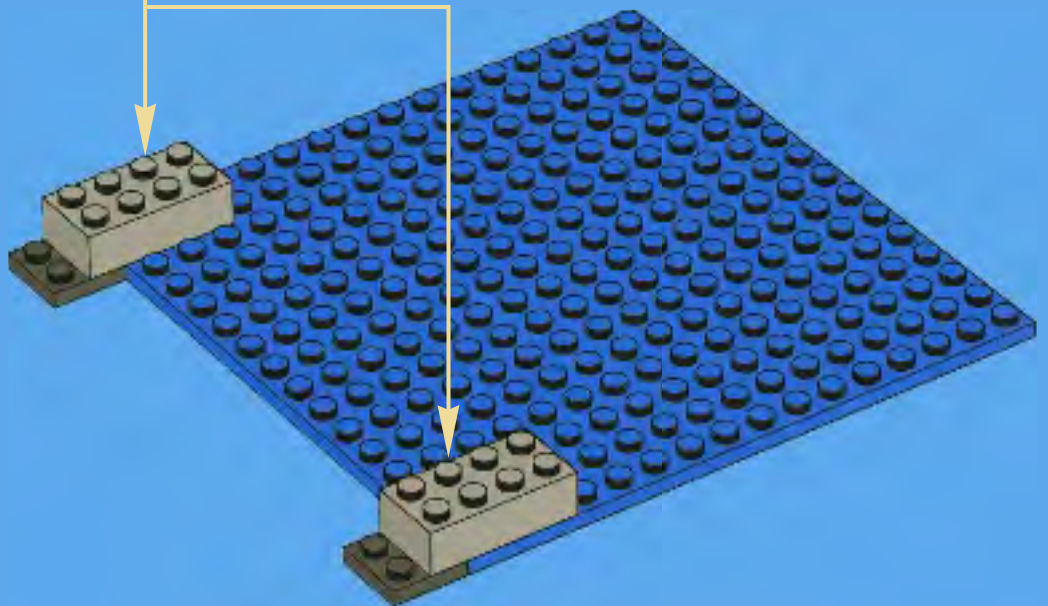



2

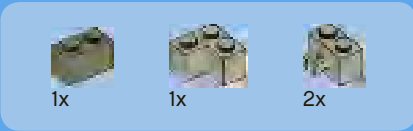
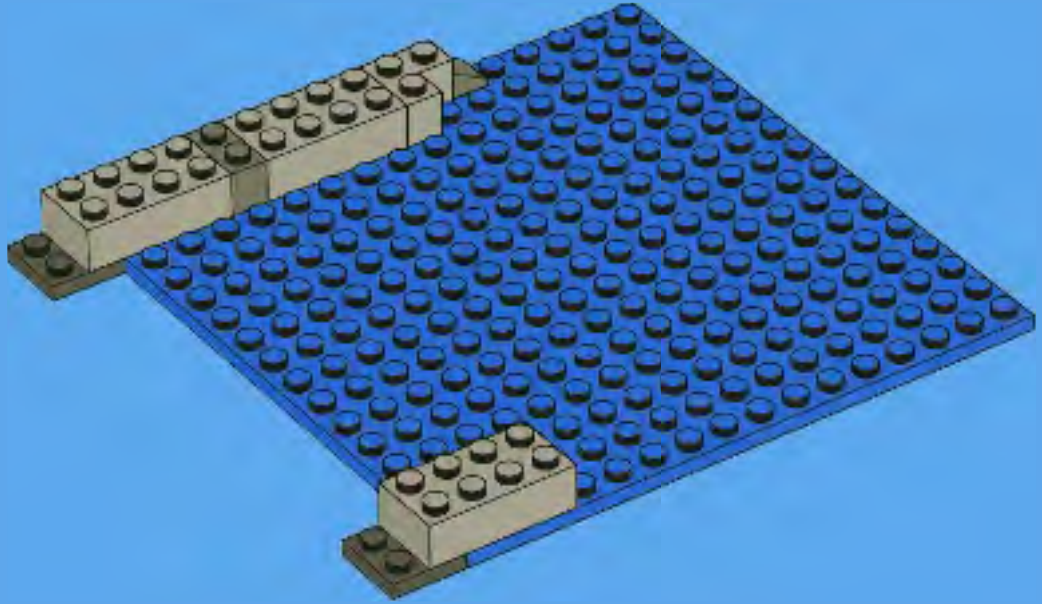

3

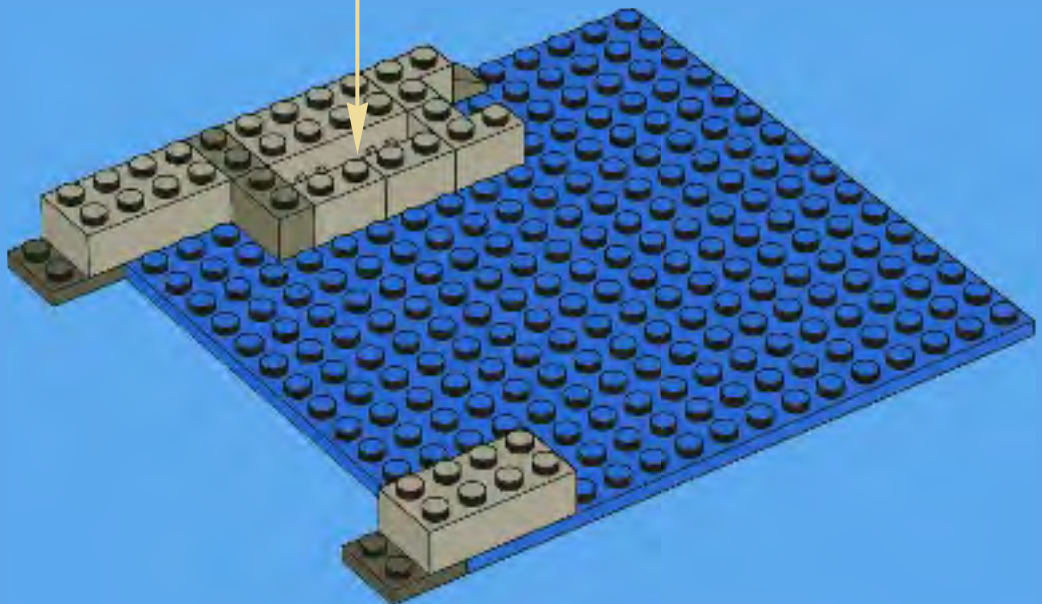



4

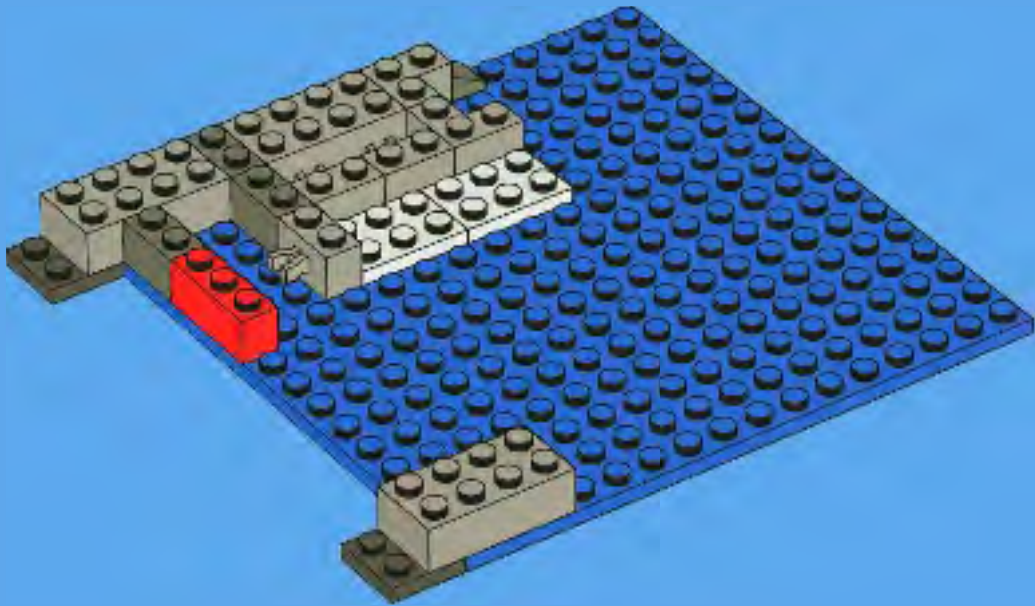



2x



1x



1x



1x

5

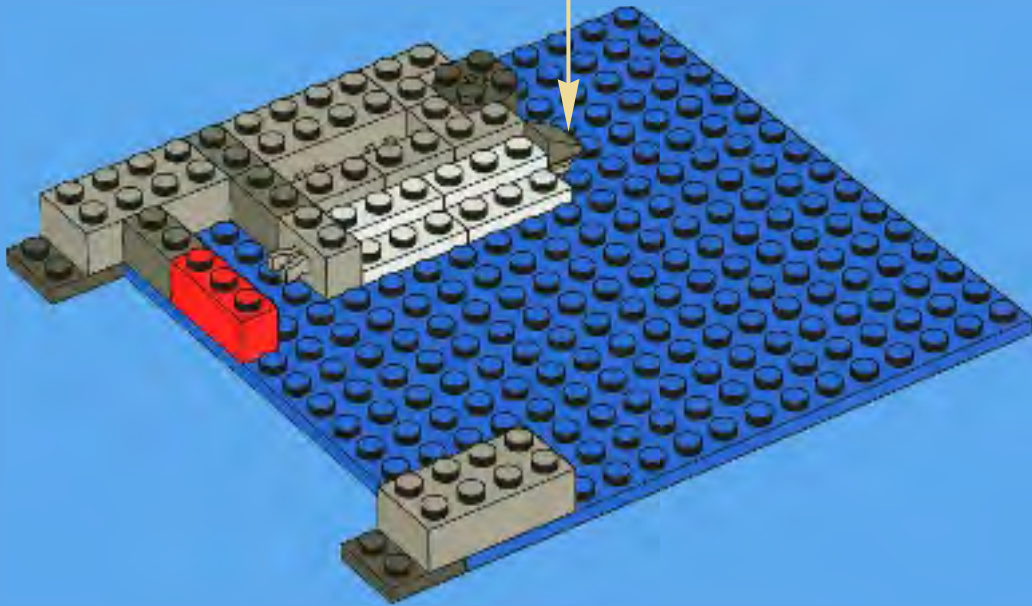

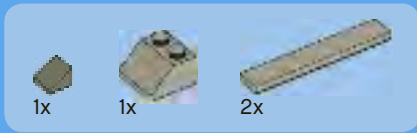

6

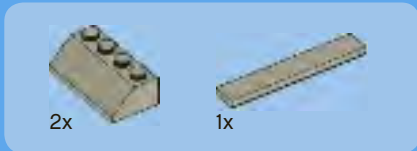
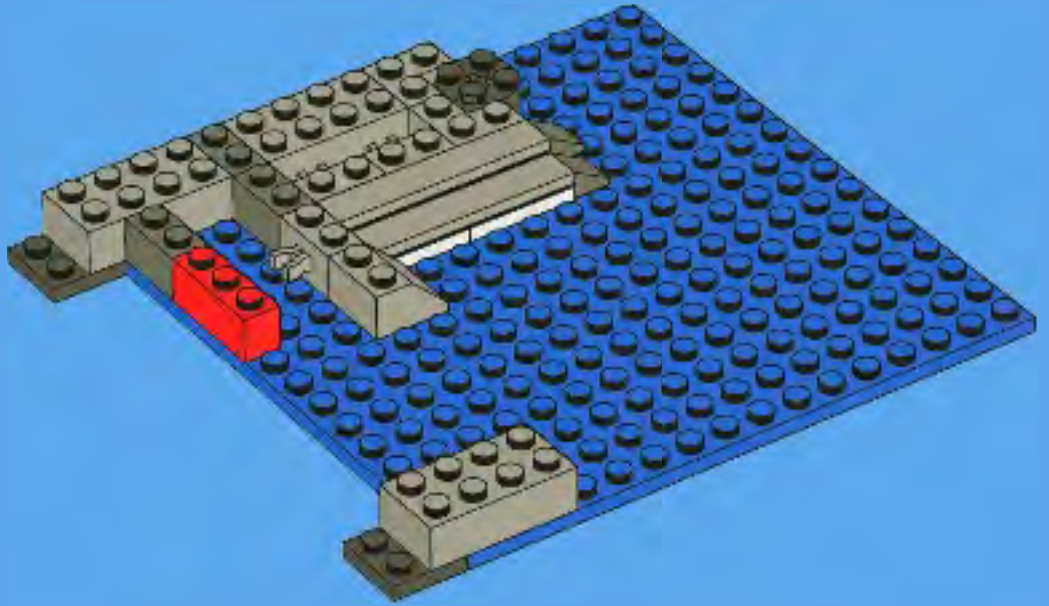

7

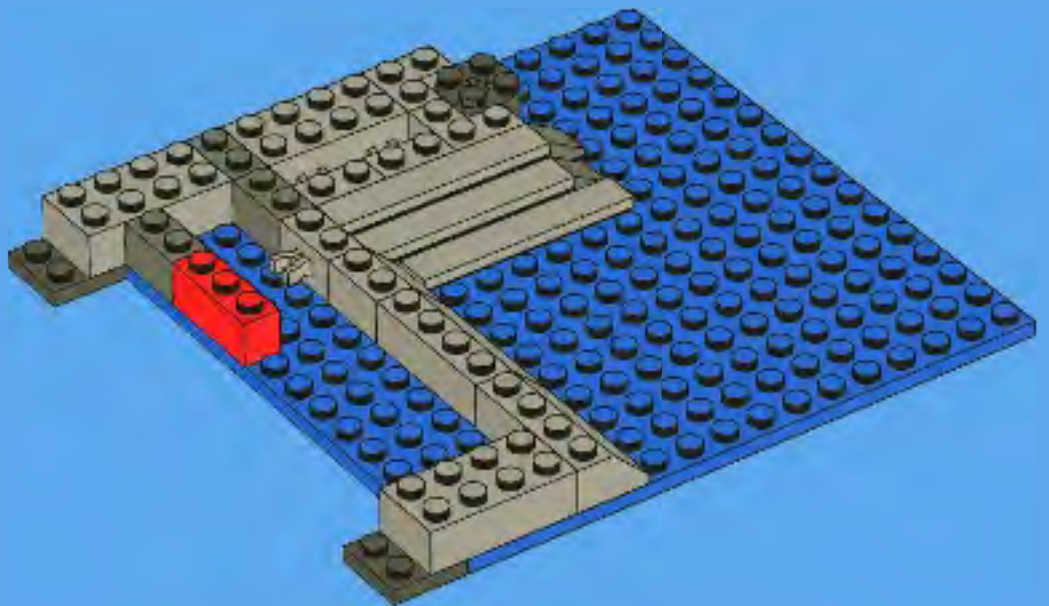

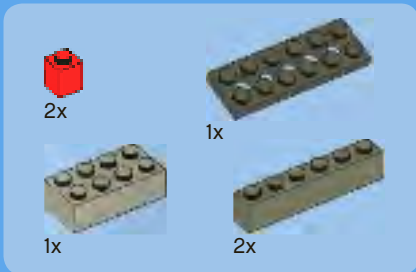

8

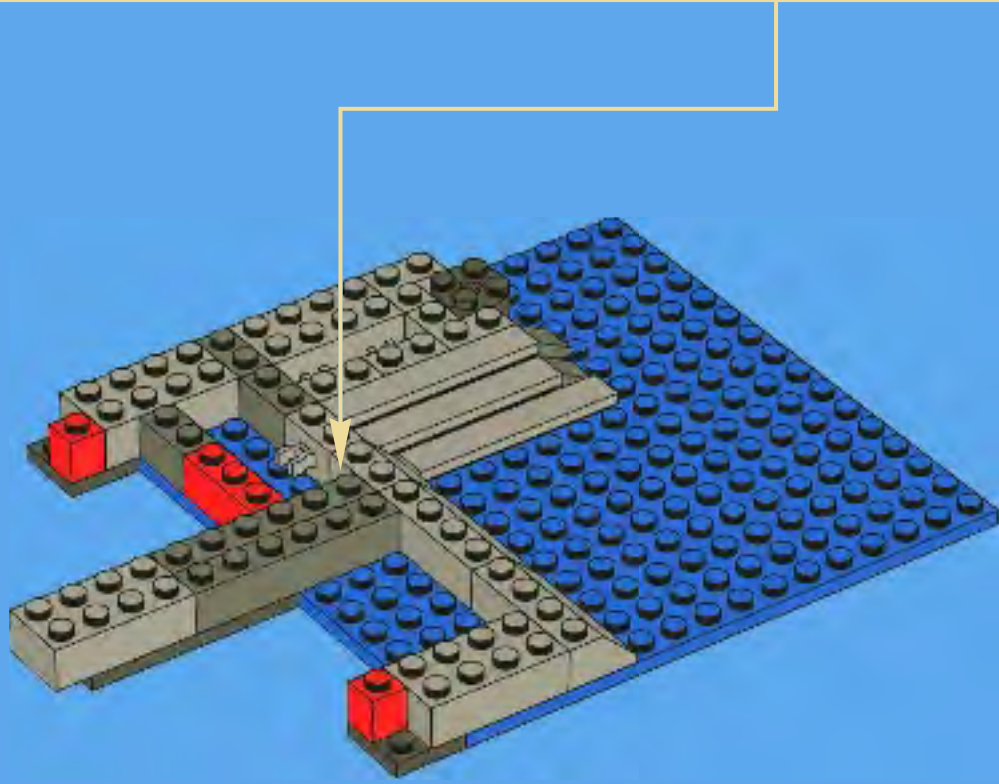
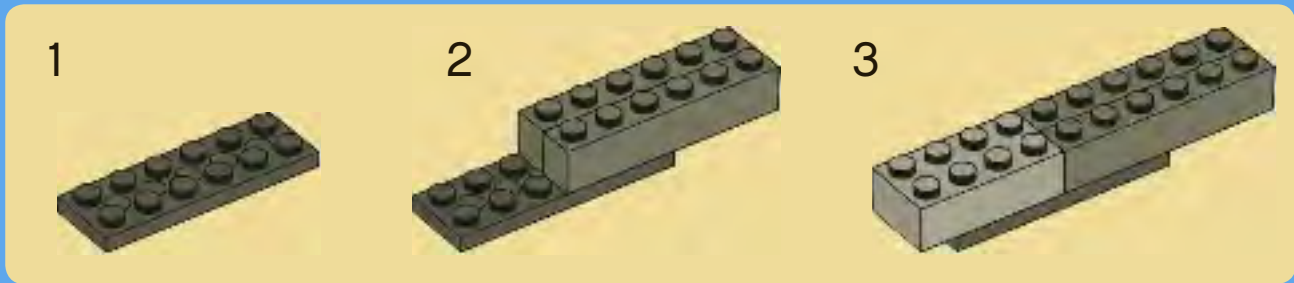



9

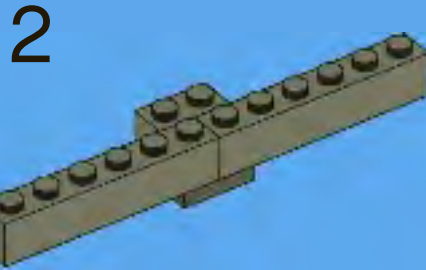

2x

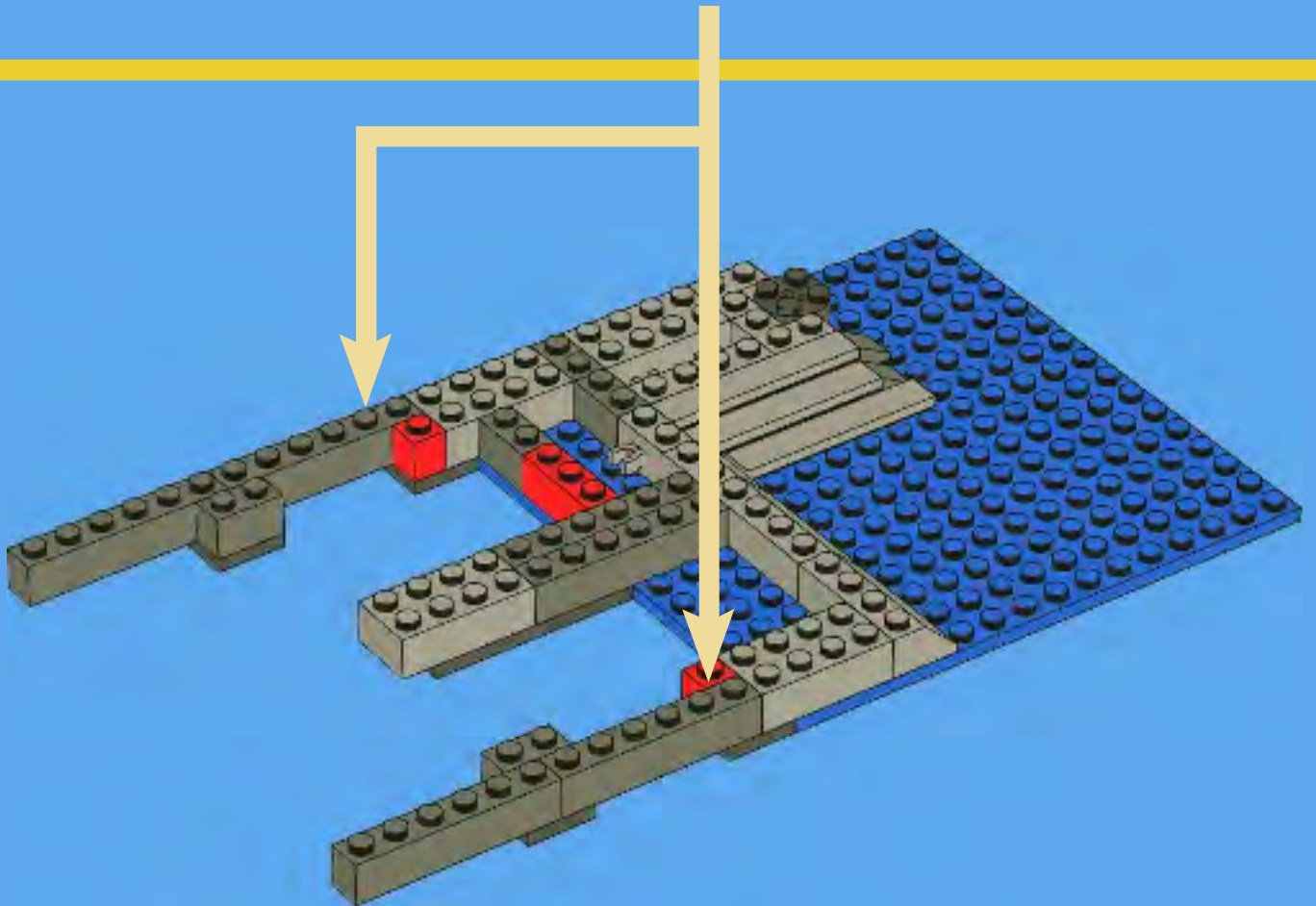



2x



1x

10

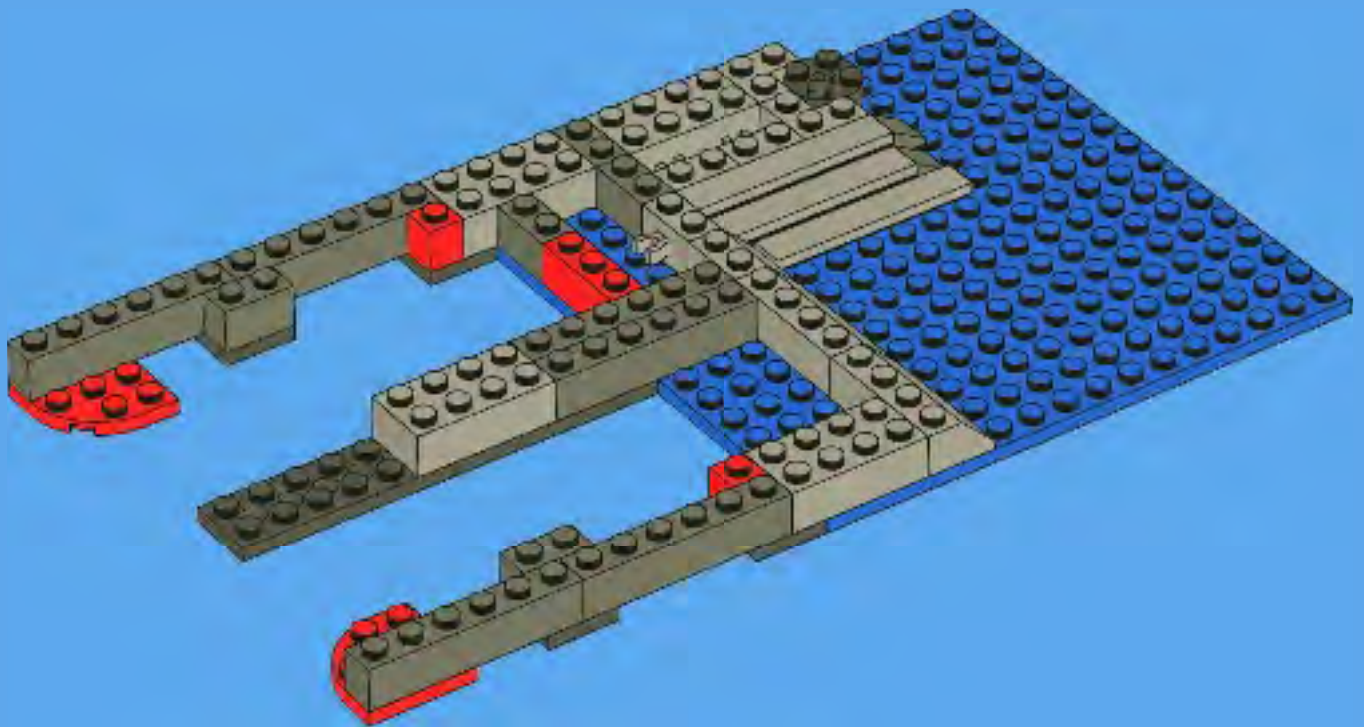



2x



2x

11

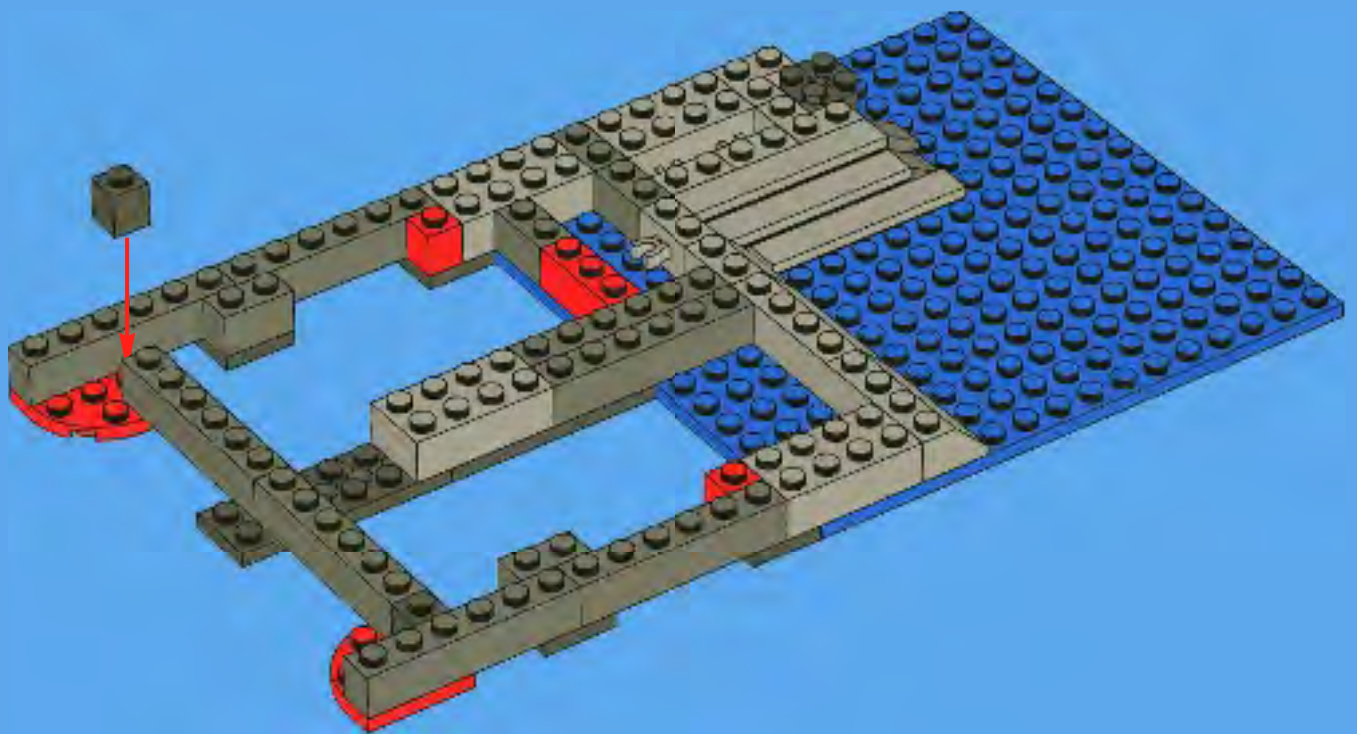



1x



2x



1x

12

1



2

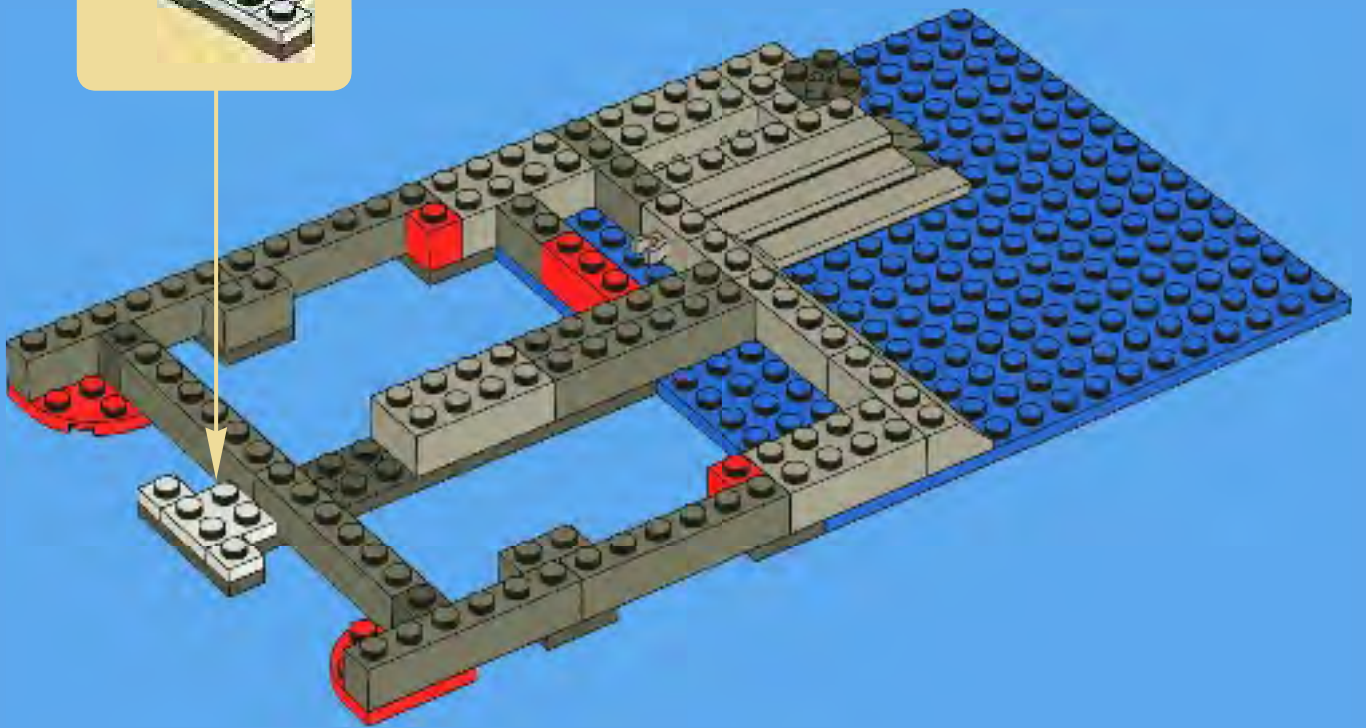

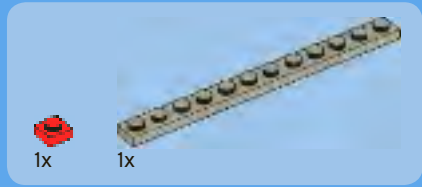

1

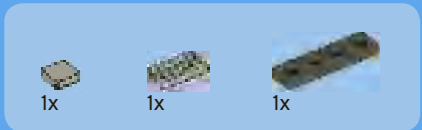
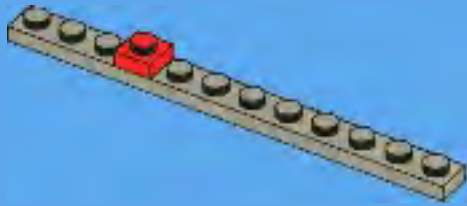

2

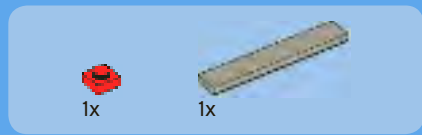
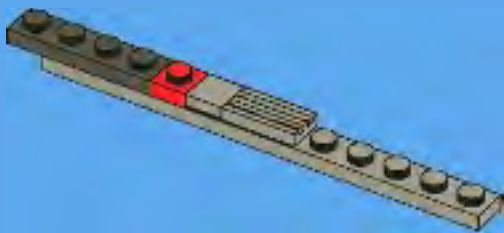

3

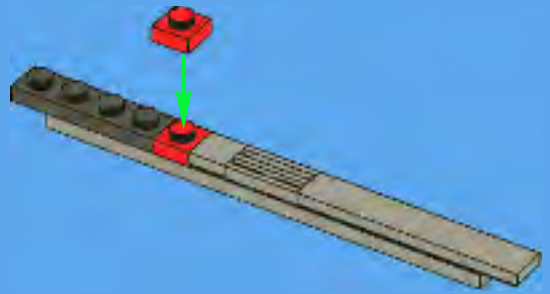

4

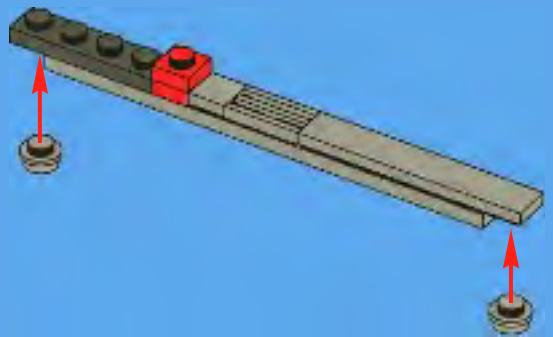



2x

5

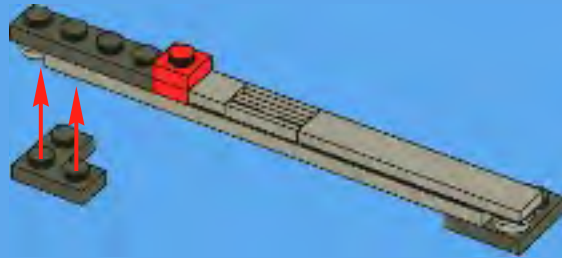

13

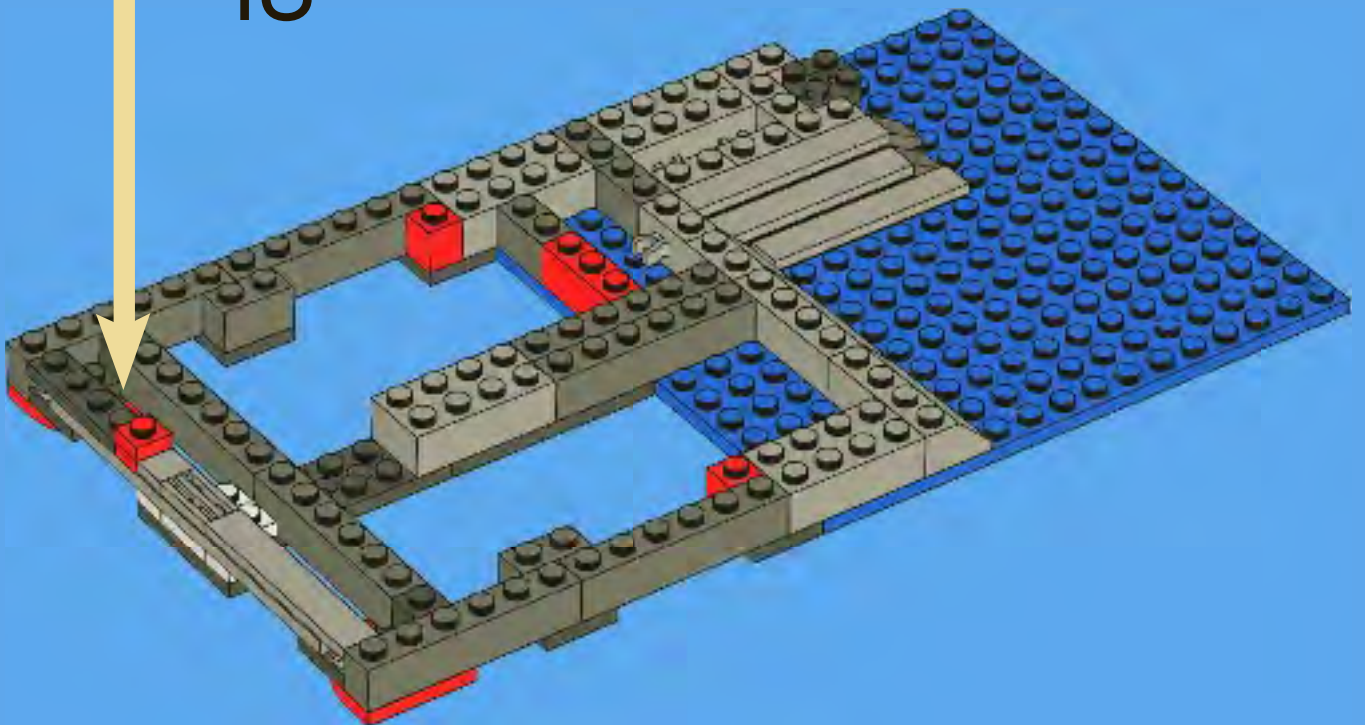

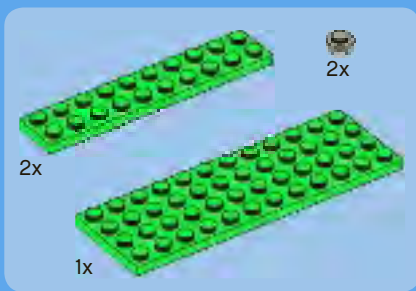

14

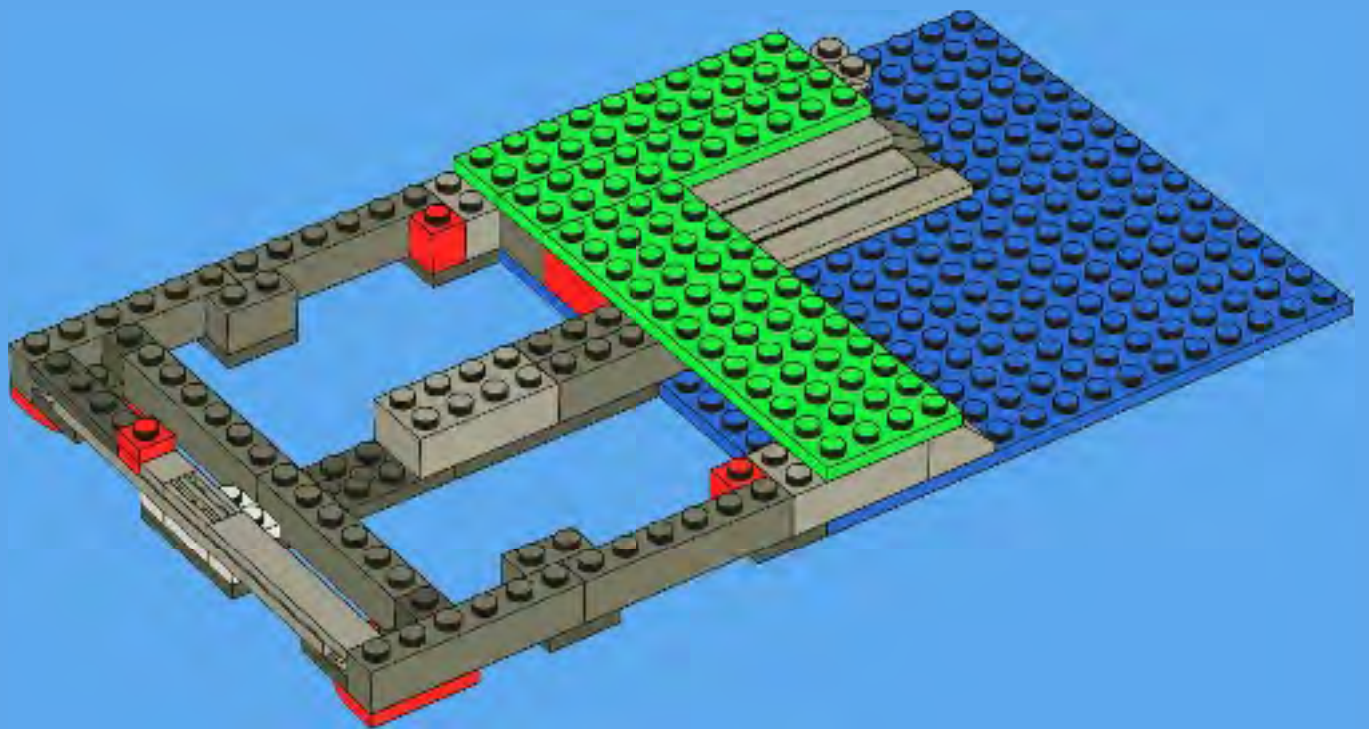

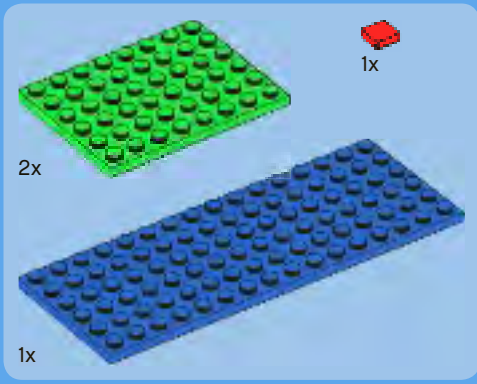

15

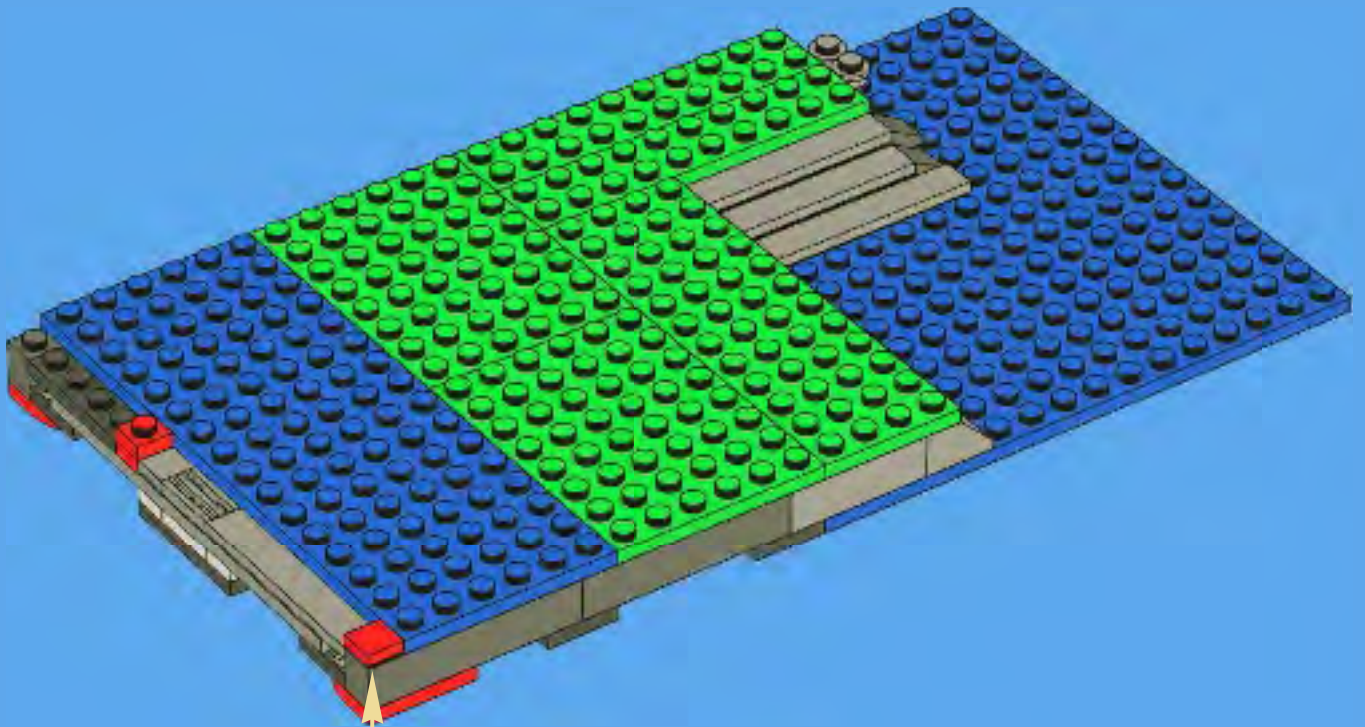



16



17

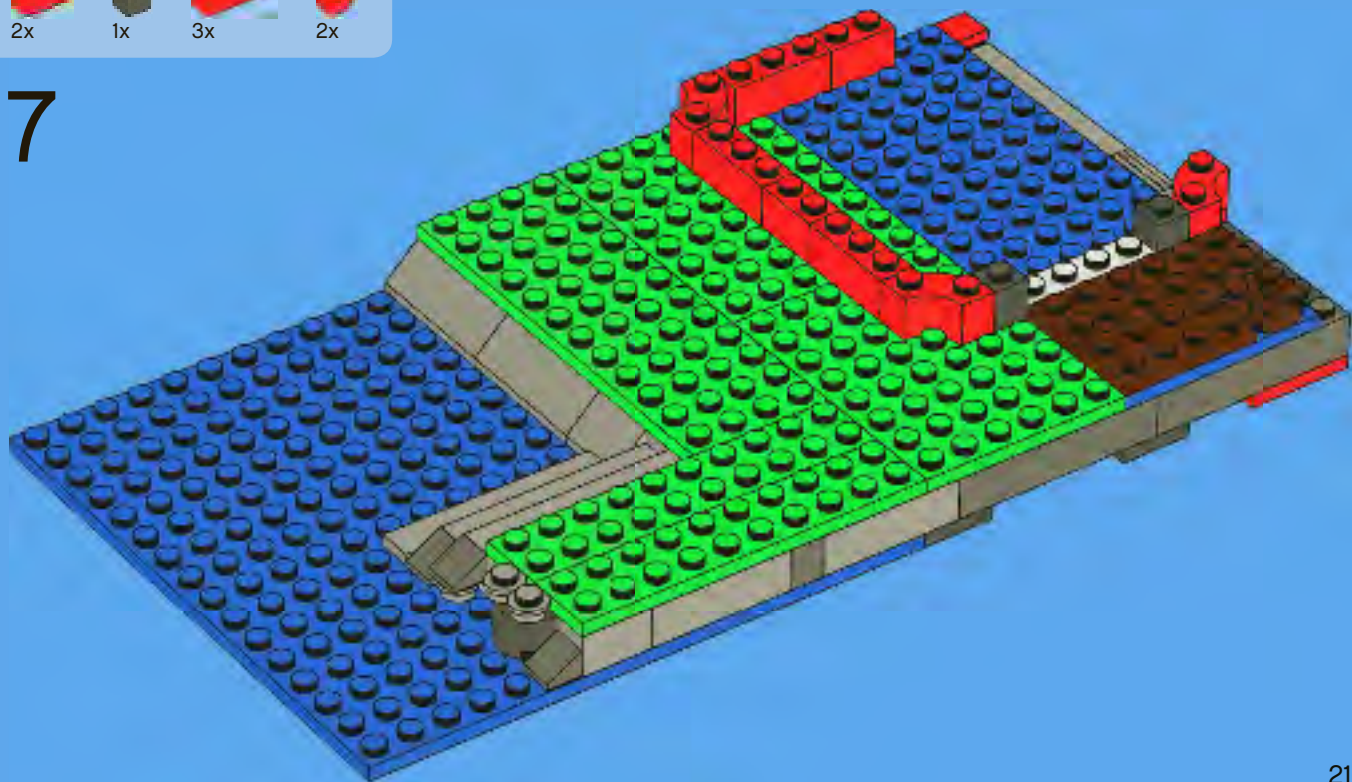



1x

1



1x



1x



1x

2

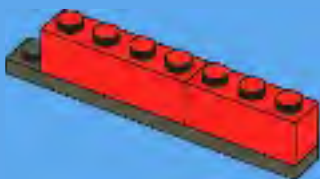

1x



1x

3

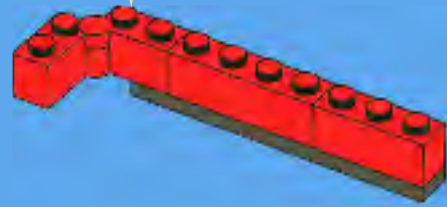

3x



2x

4

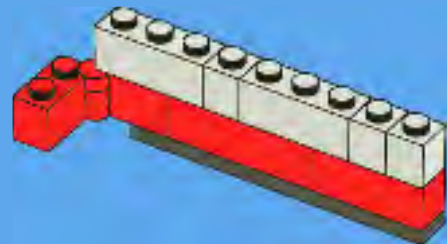





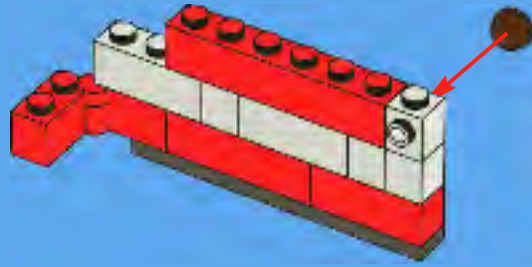

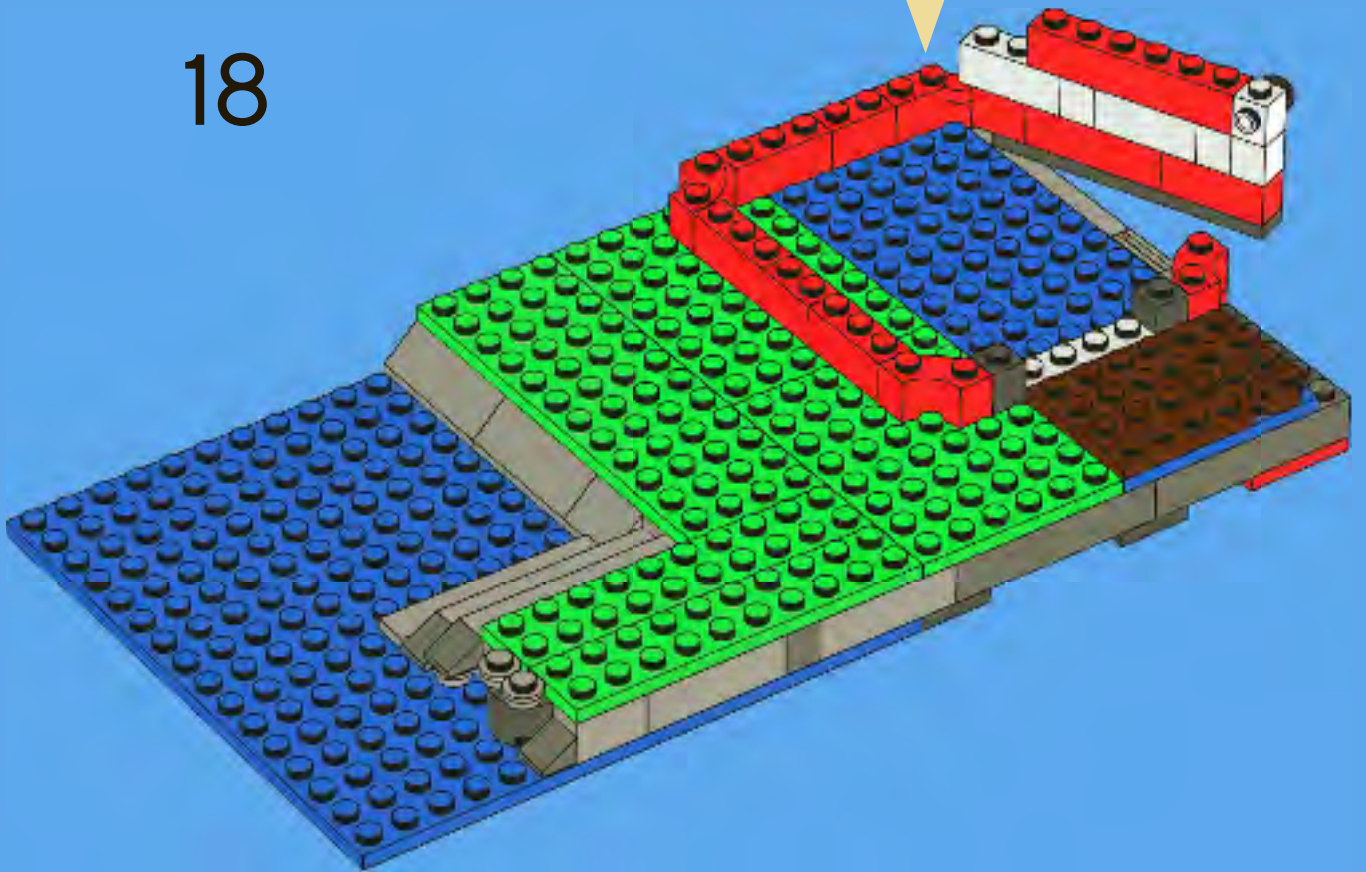

5



18



 2x	 2x	 1x	 2x
 4x	 1x		

19

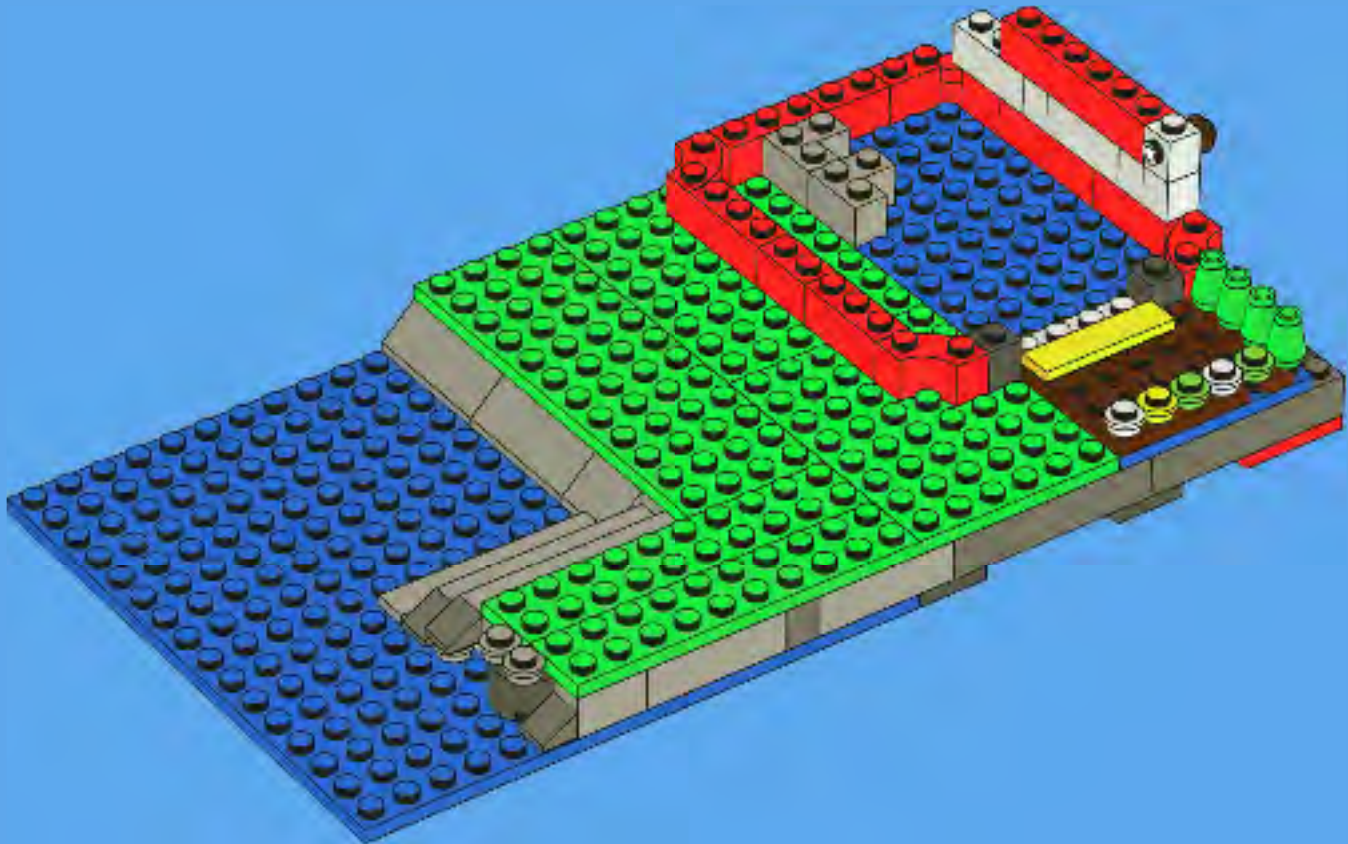



1x



2x



1x



3x

20

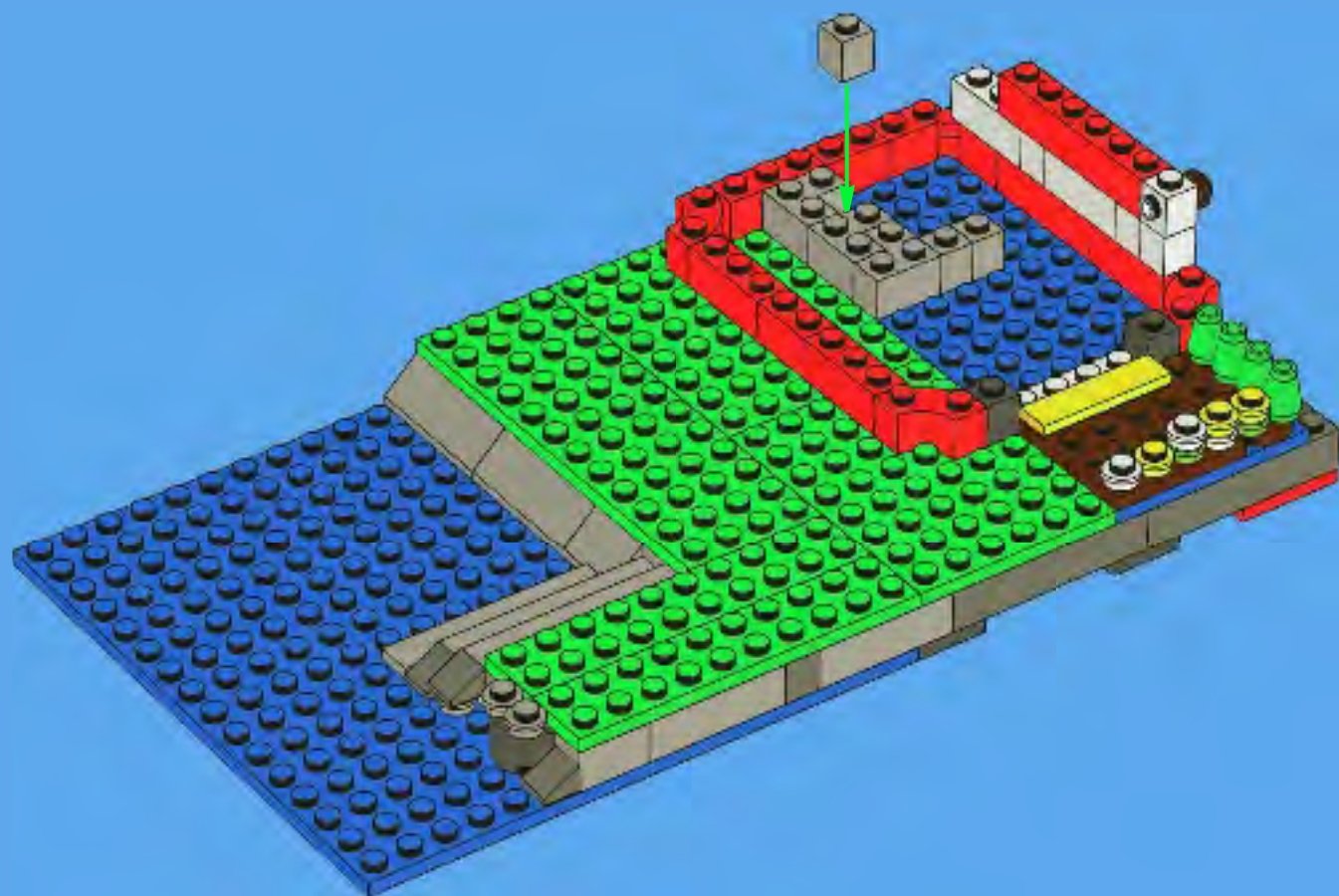

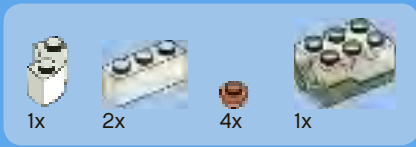

21

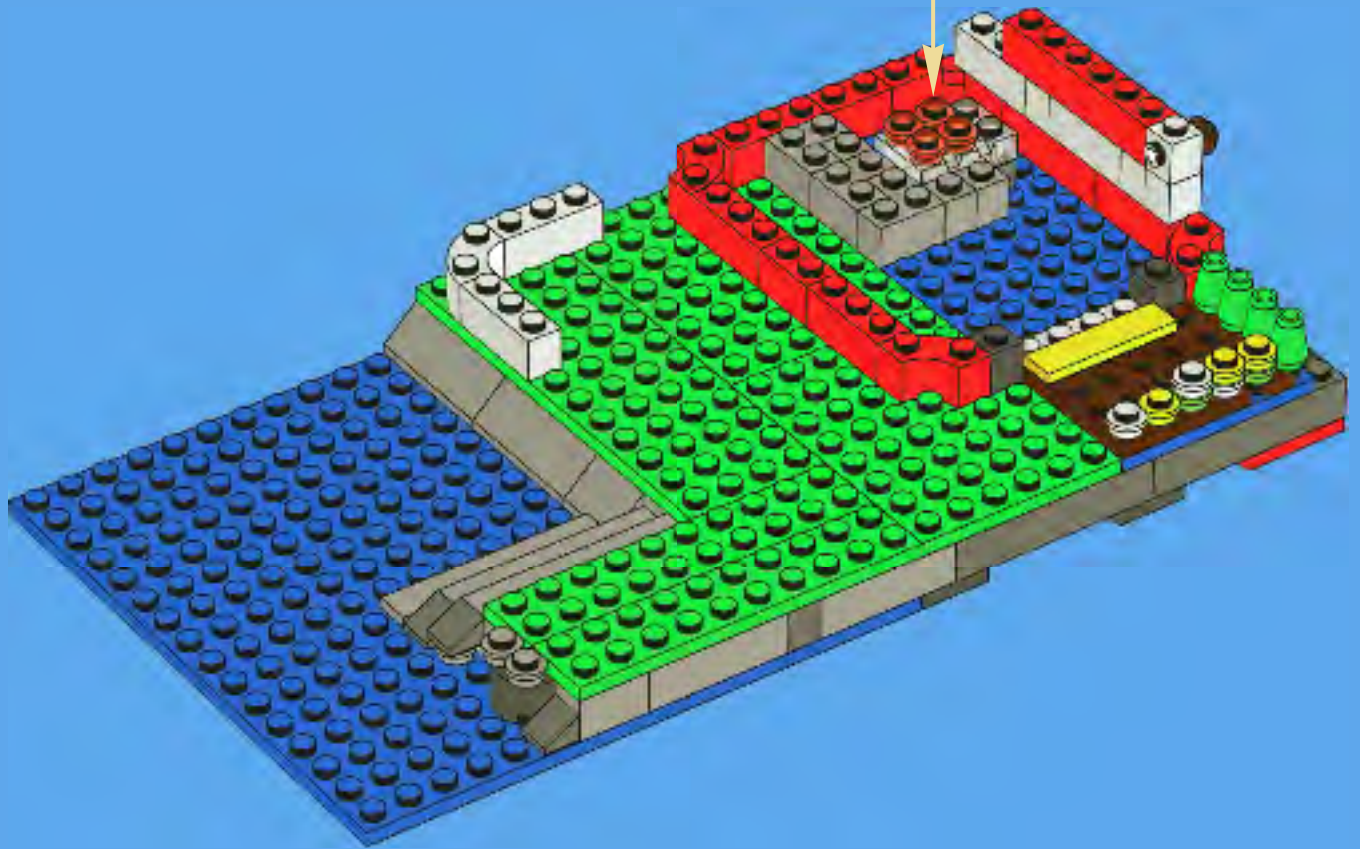



22

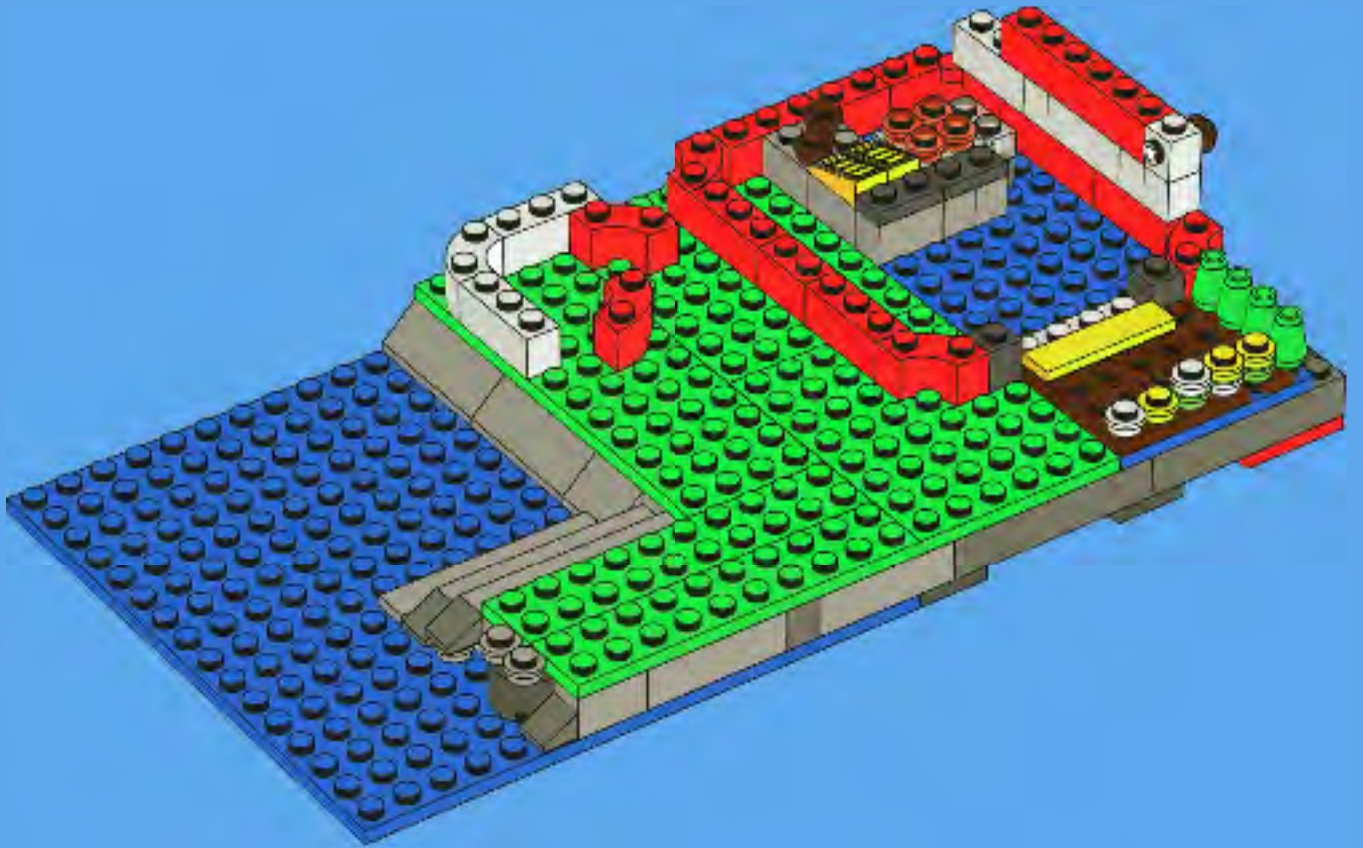



1x



1x



1x



1x



1x

23





2x



1x



1x



2x



1x



1x

24

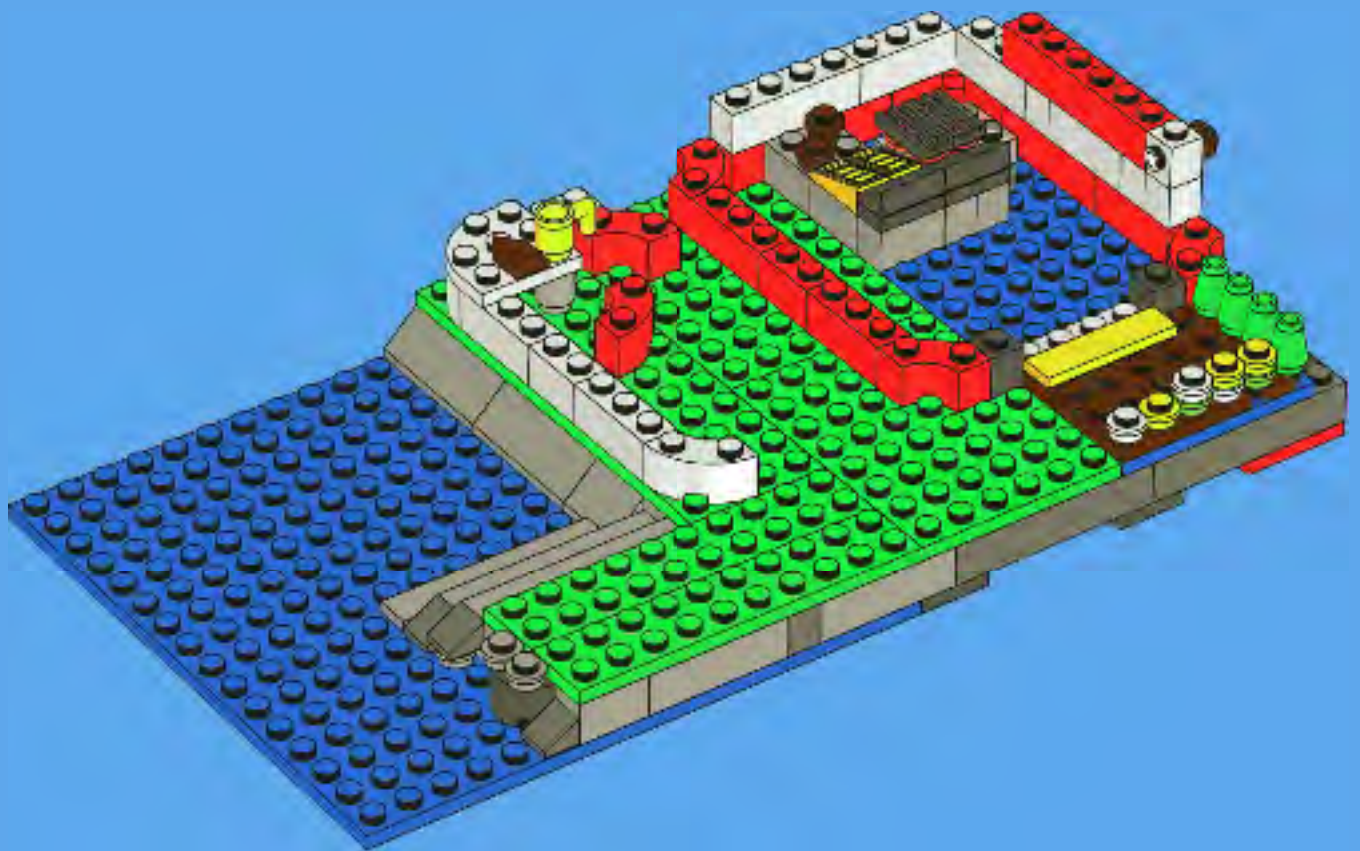



1x



1x



1x



1x

25

1



2

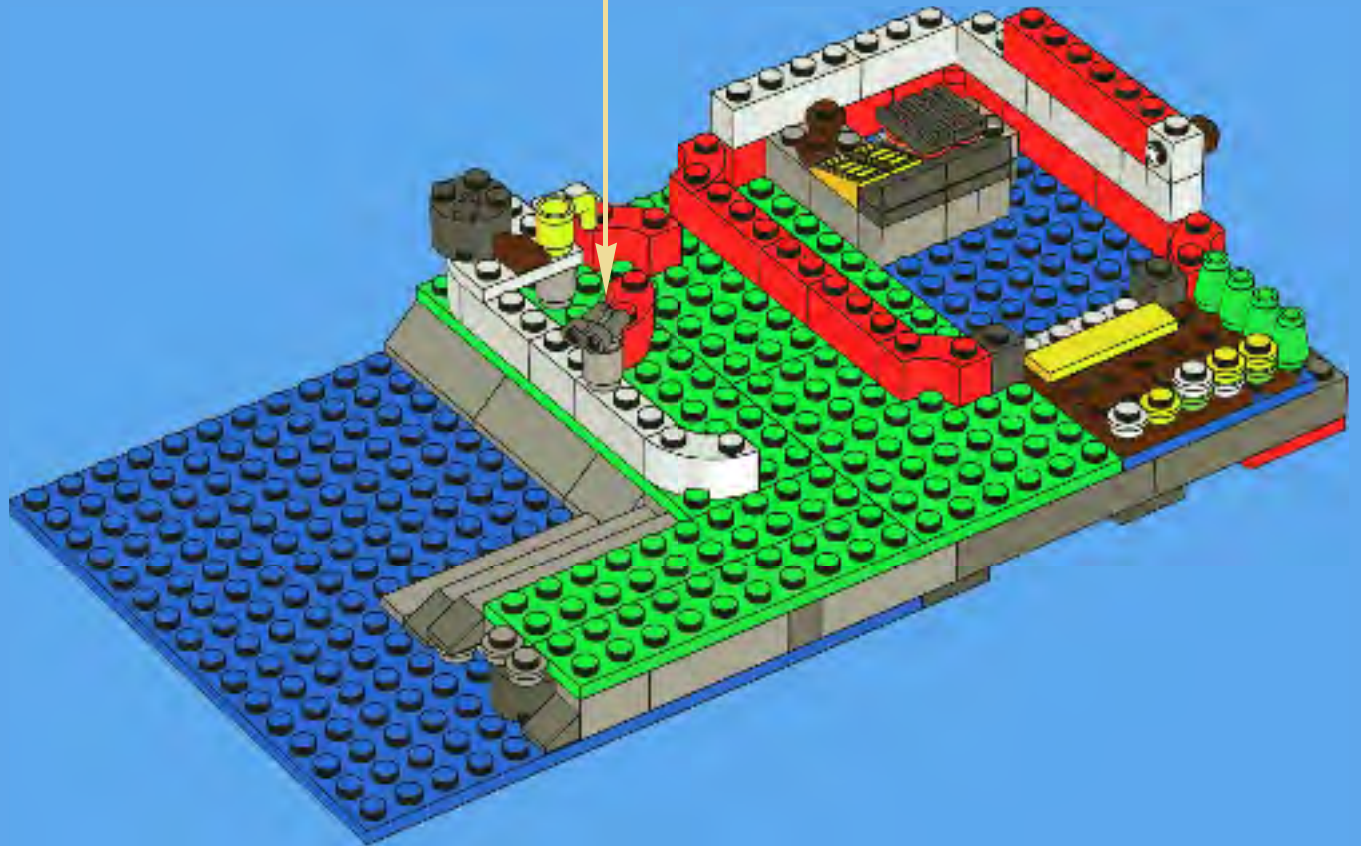

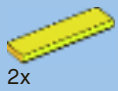

2x



2x



2x



6x

26

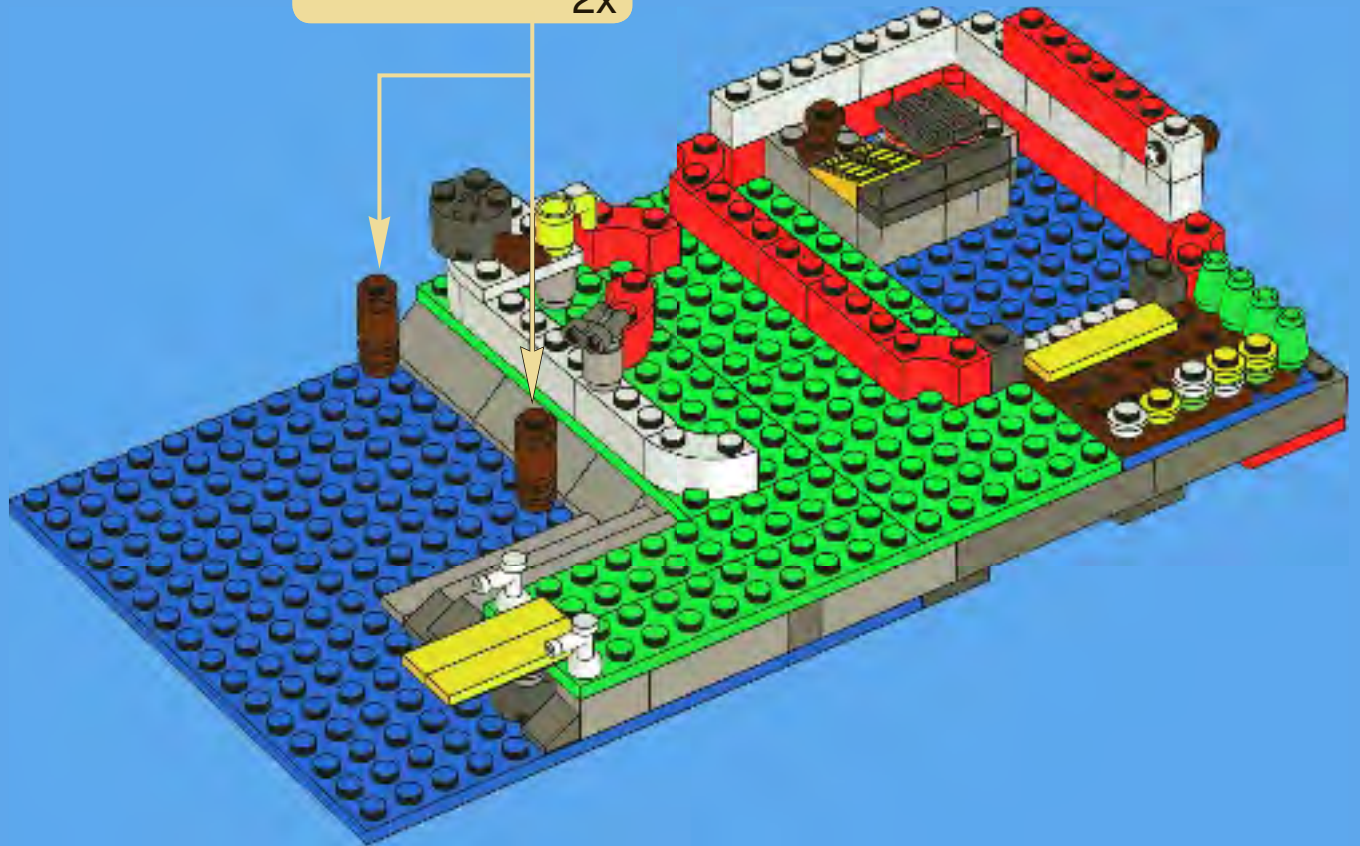
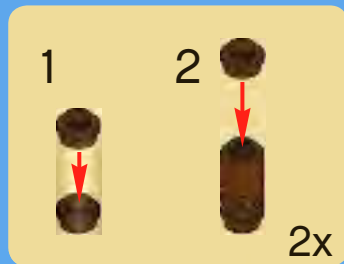



27

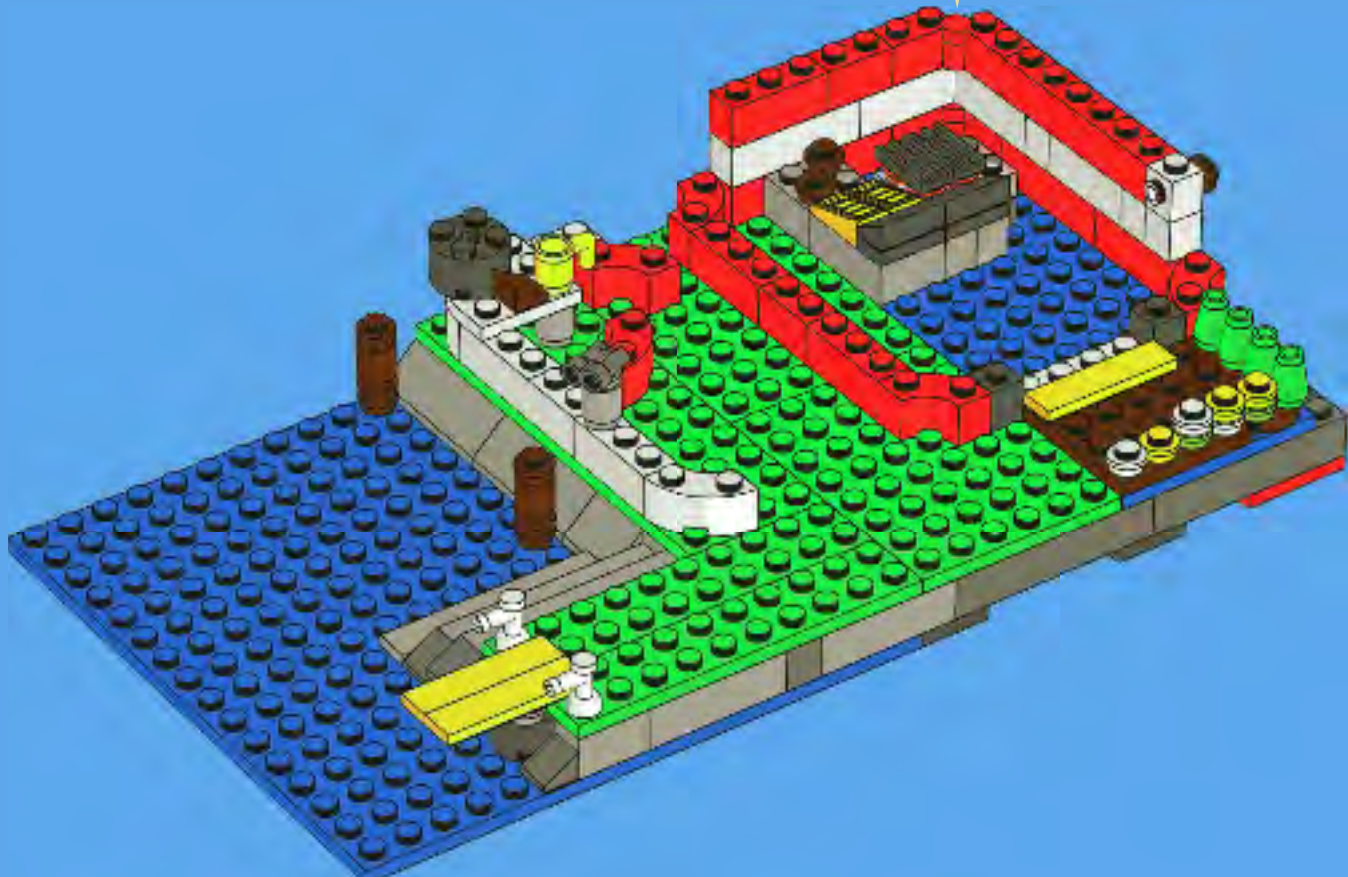

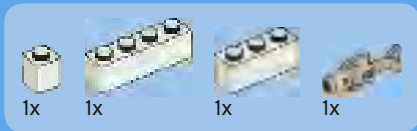

28

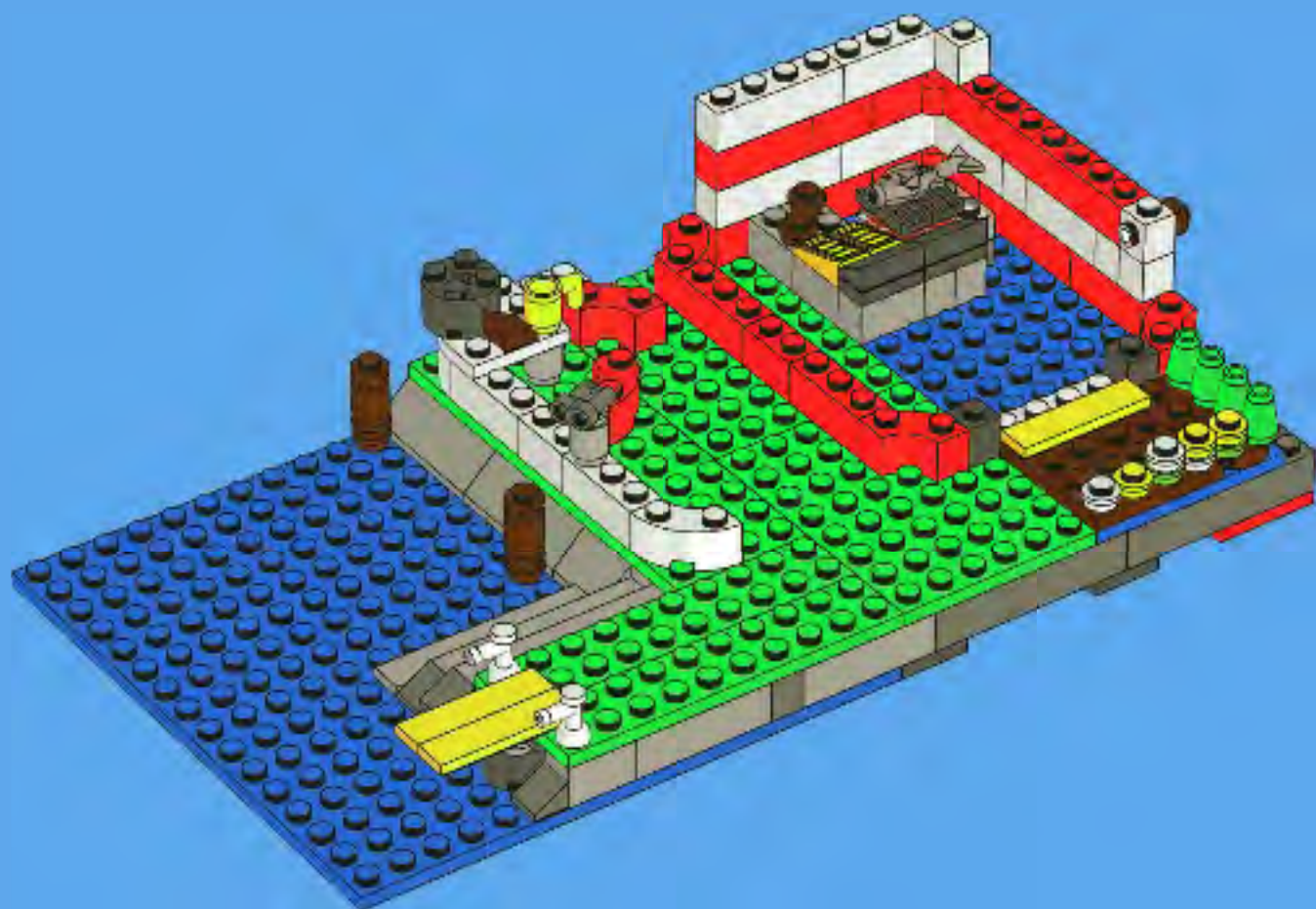

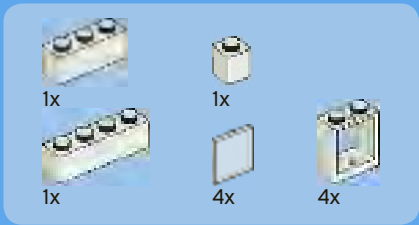

29

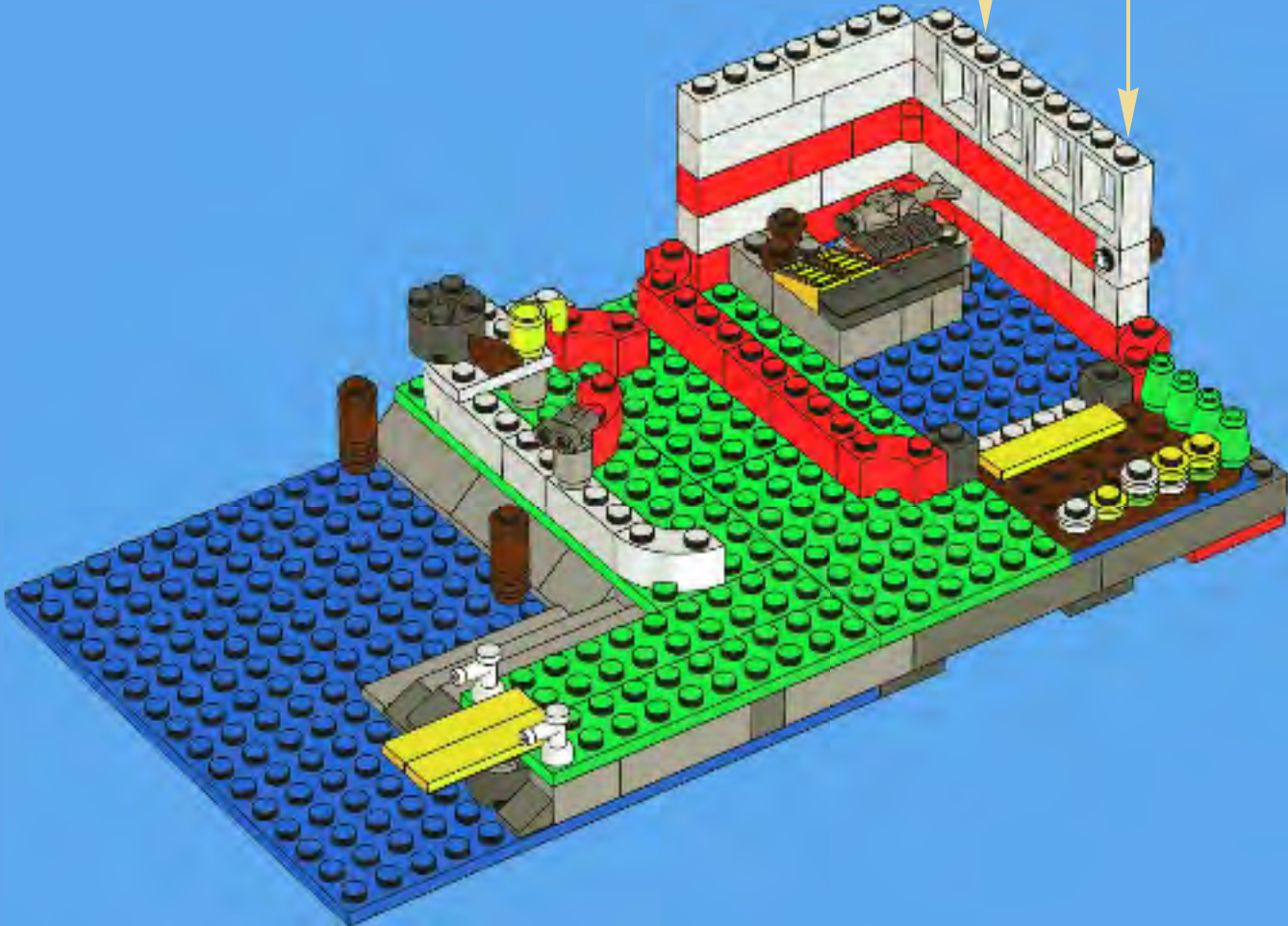
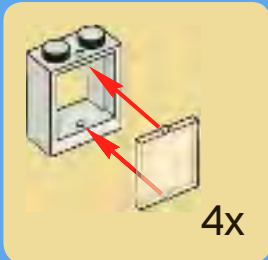



2x



1x



1x



1x

30

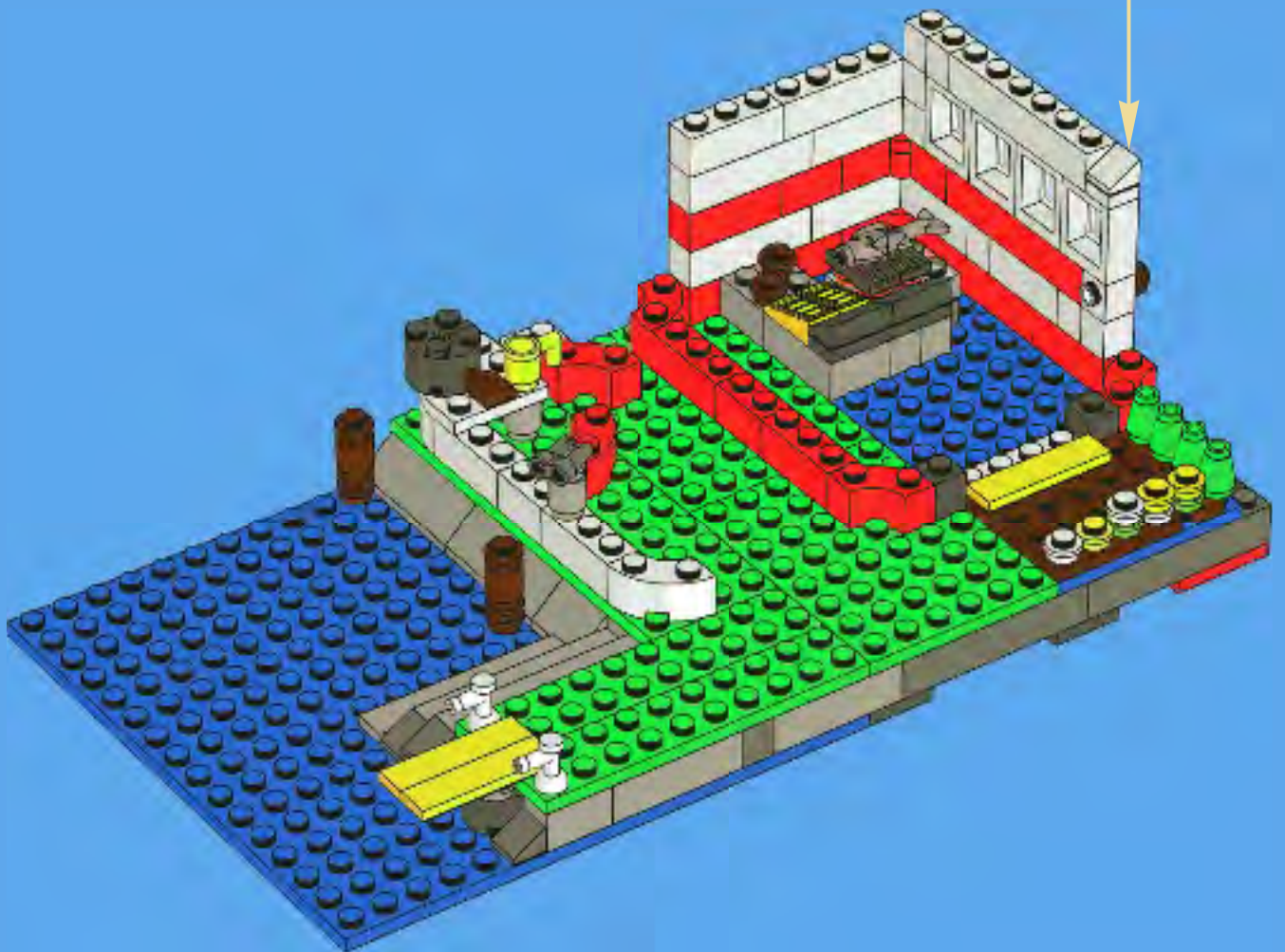
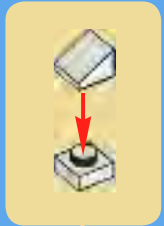

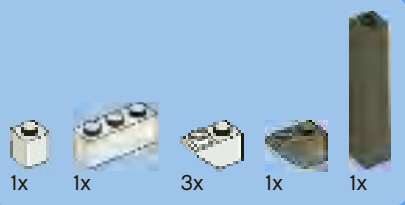

31

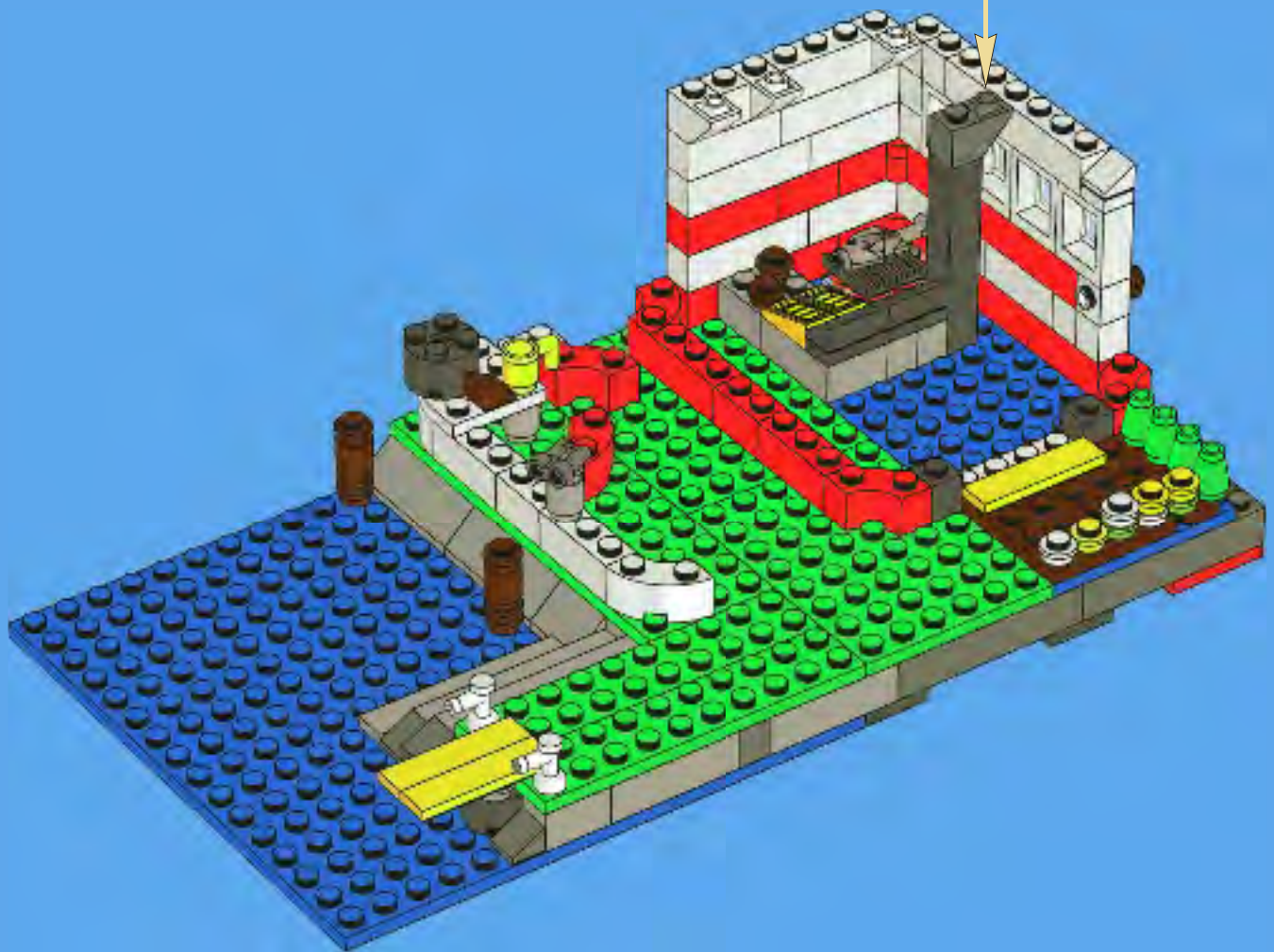

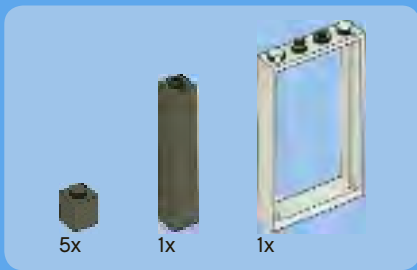

32

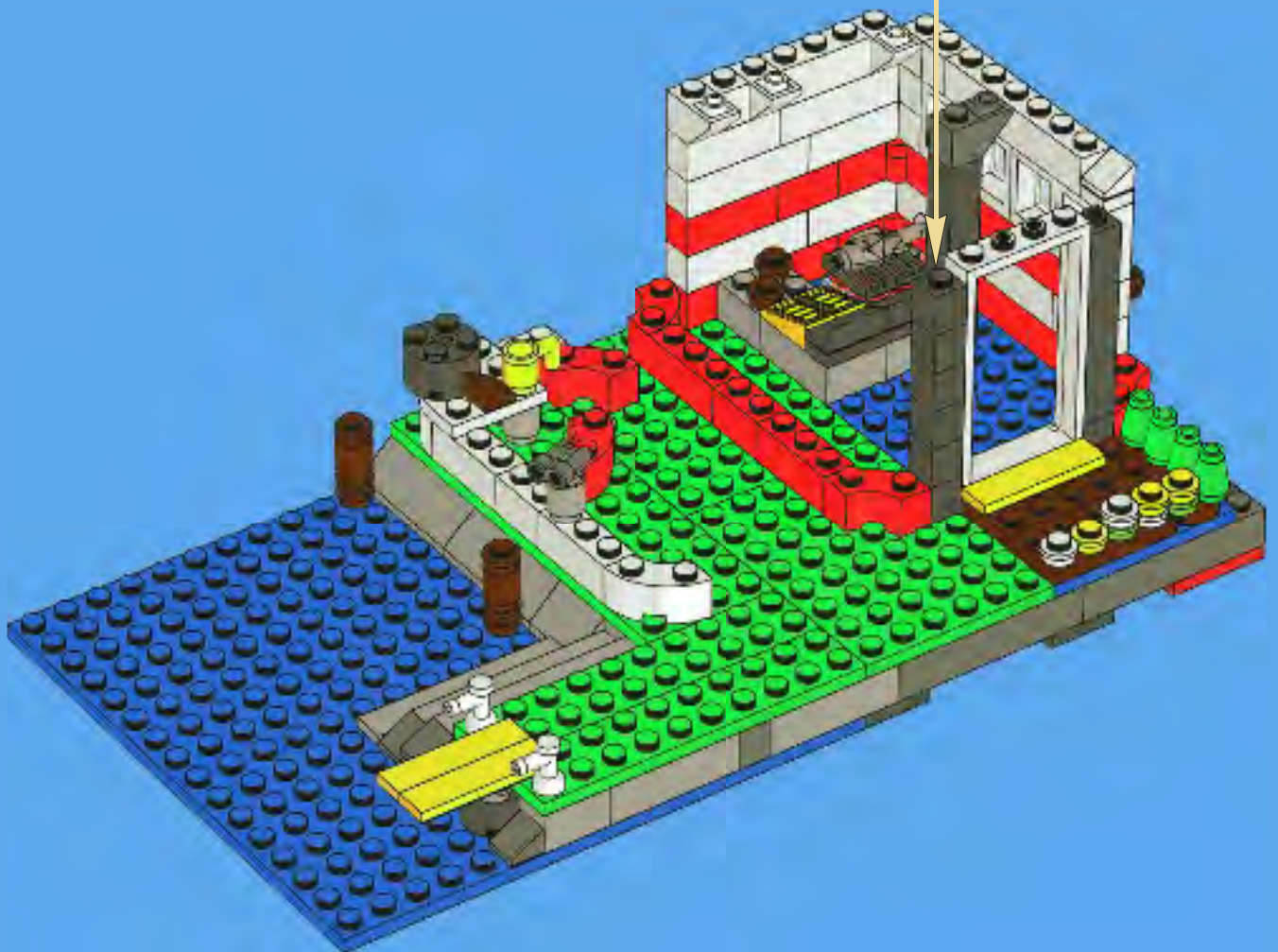



3x



12x

33

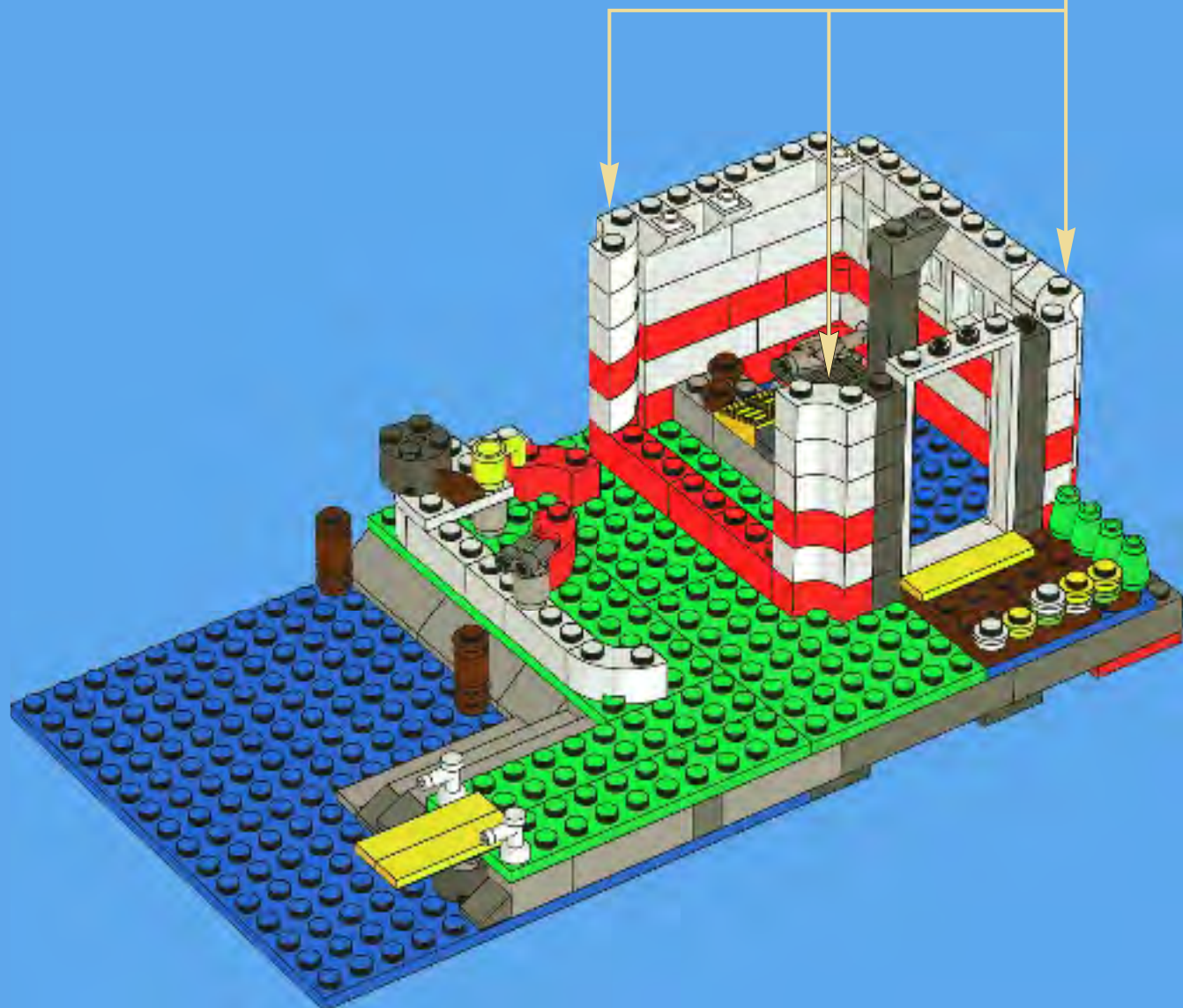
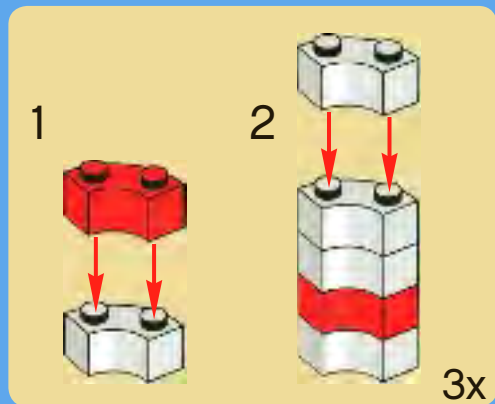



2x



4x

34





2x



5x

35



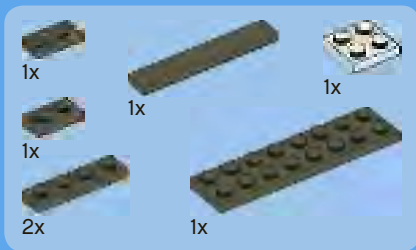

36

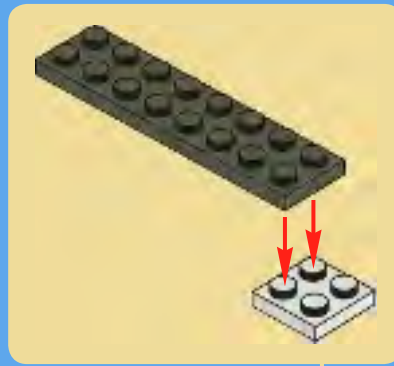

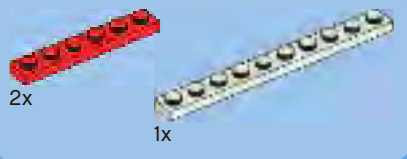

37





1x



1x



3x



1x

38





6x



2x



2x

39





1x



2x

40



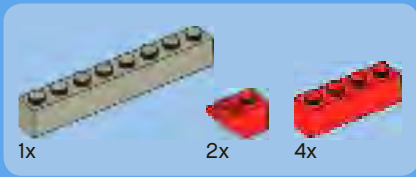

41

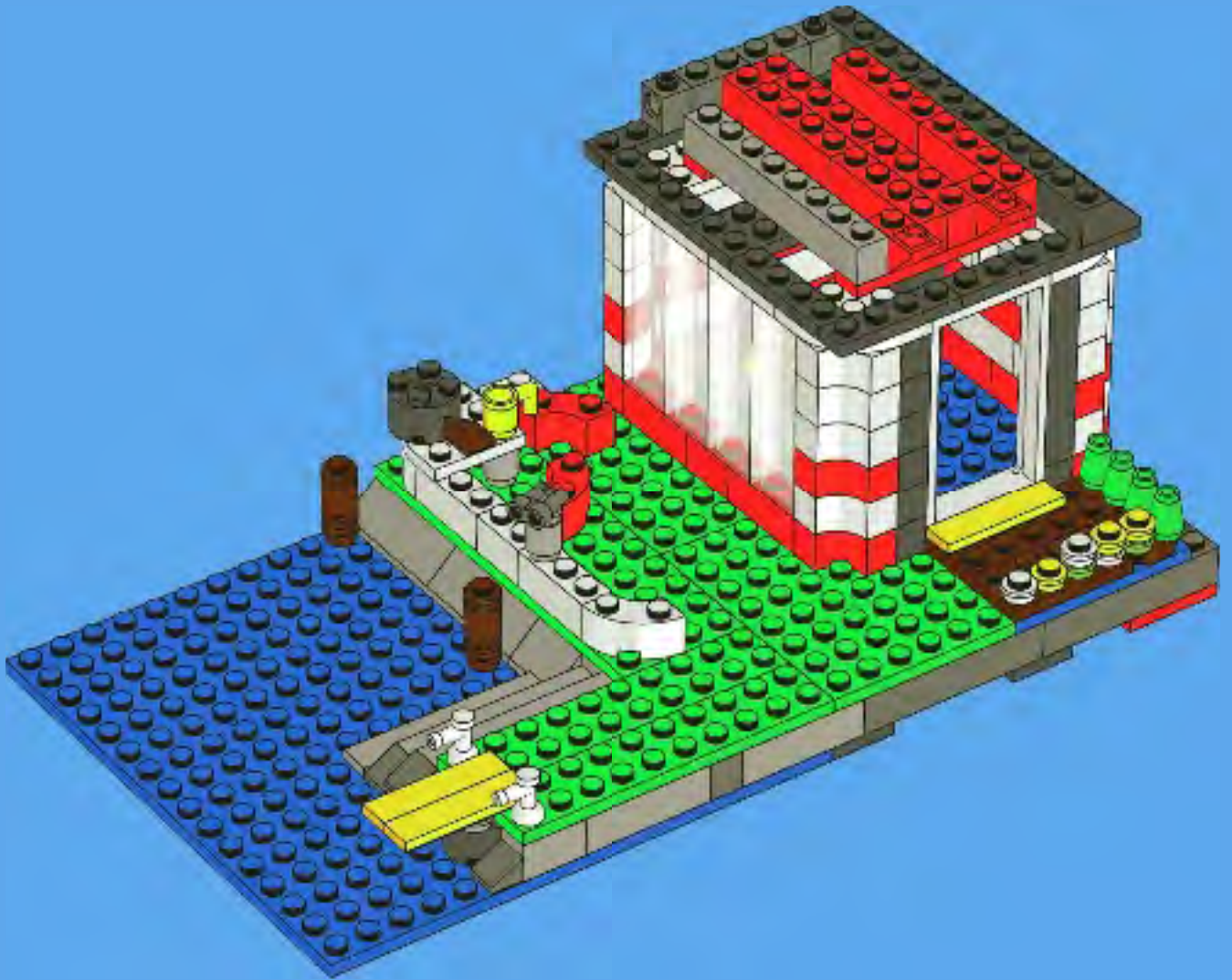



42





4x



6x

43





4x



4x

44





1x



1x

45





2x



2x



1x

46





1x



2x

47





1x



1x



1x

48

1



2





2x



1x



1x



1x

49

1



2



3



4





1x



1x



1x



1x



1x

50

1



2



3



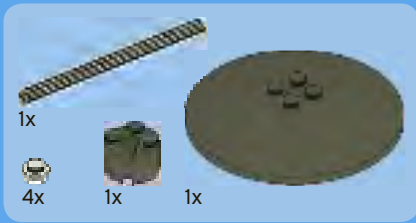

51

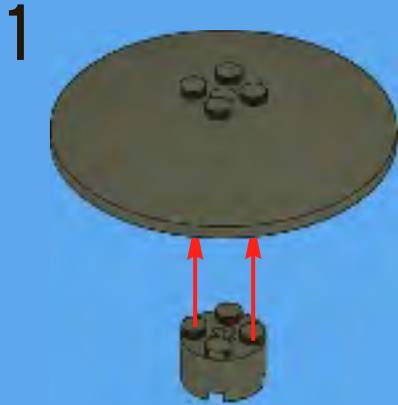

2



3



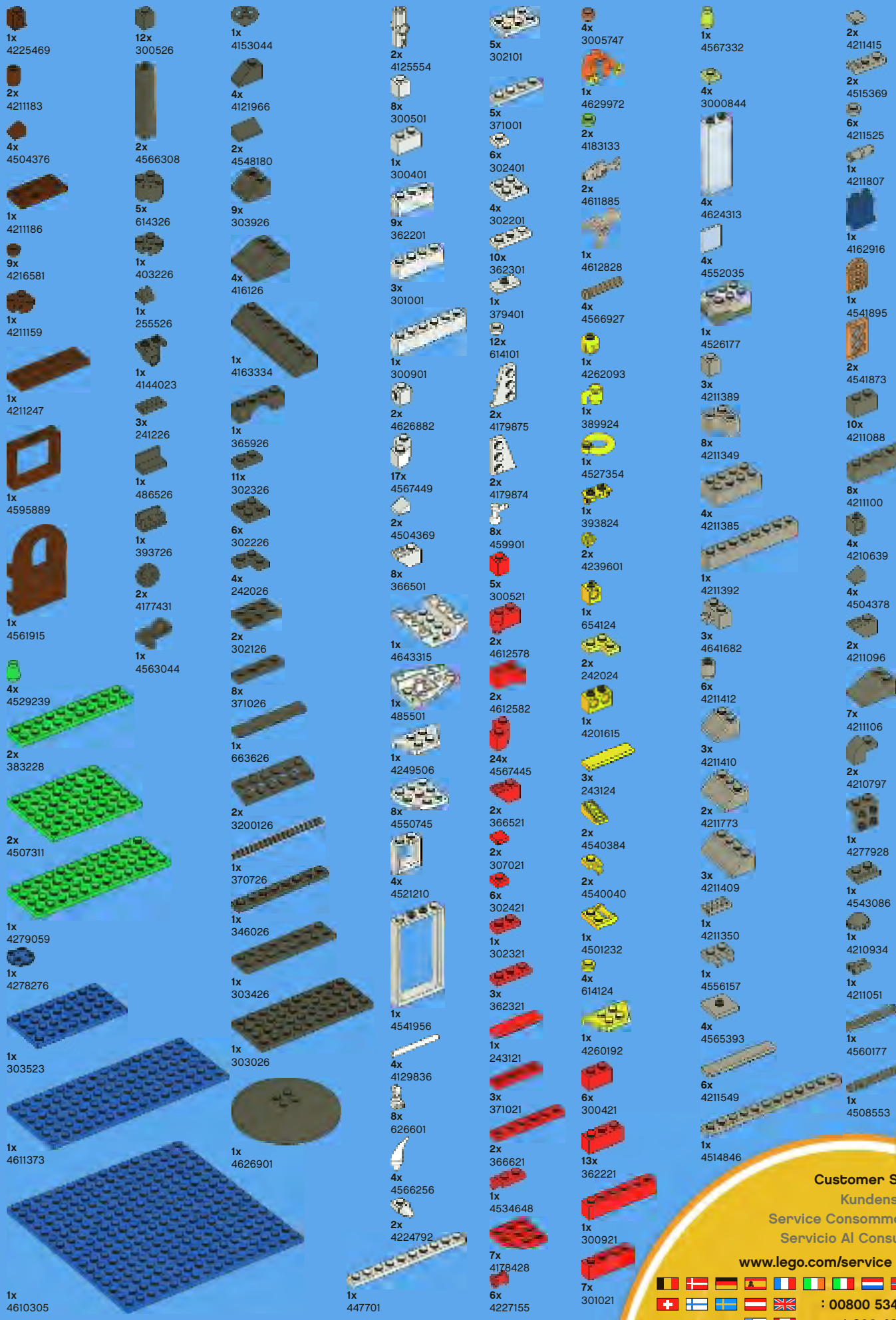

Customer Service
Kundenservice
Service Consommateurs
Servicio Al Consumidor

www.lego.com/service or dial

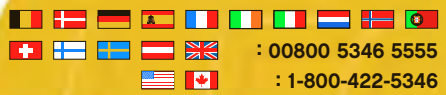

: 00800 5346 5555

: 1-800-422-5346



www.LEGOclub.com

LEGO club™

FREE! GRATIS! GRATUIT!



LEGO® Club Email



LEGO® Club Magazine



VISIT THE WORLD'S
BIGGEST LEGO® SHOP!
www.LEGOshop.com

GO TO
www.LEGOclub.com

00800 5346 5555*

1-866-534-6258 • 1-877-518-5346

US & Canada only. Canada seulement.



* Freephone. Mobile charges may apply. * Numéro sans frais. Des frais peuvent s'appliquer avec les téléphones cellulaires.
* Gebührenfrei. Kosten für Anrufe aus Mobilfunknetzen können abweichen. * Gratis telefoonnummer vanaf vaste lijn. * Det er et gratis nummer, når du ringer fra fasttelefon. * Det är gratis, när du ringer från en fast telefon. * Numéro sans frais. Des frais peuvent s'appliquer avec les téléphones portables.



CREATOR

5763



5764



5765



creator.LEGO.com



CREATOR

5766





CREATOR

5771



 www.LEGO.com

creator.LEGO.com

LEGO and the LEGO logo are trademarks of the/son des marques de commerce de/
son marcas registradas de LEGO Group. ©2011 The LEGO Group. 4645139 / 4645140

