

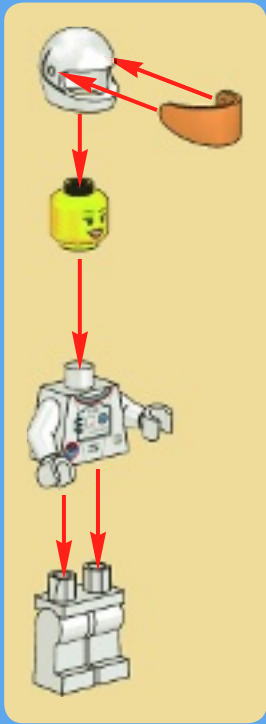

10231







1x

1



1x

4x

2

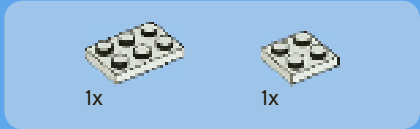

1x

1x

3



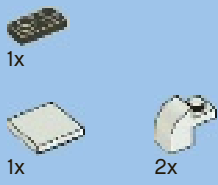
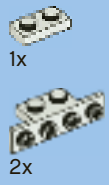

4

1

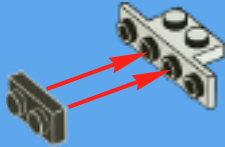

2

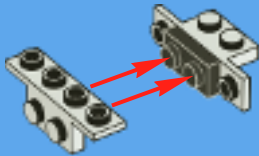

3

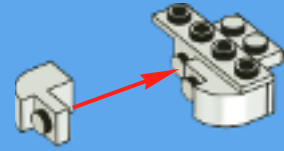

4

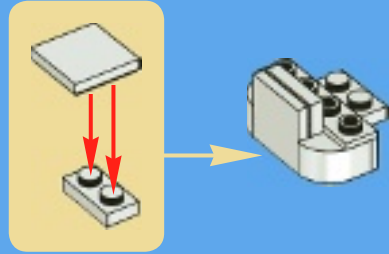

5

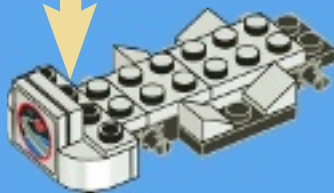
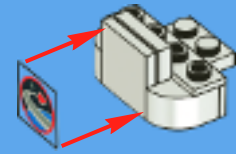



5

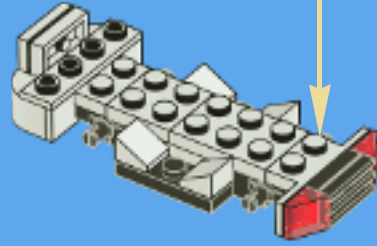
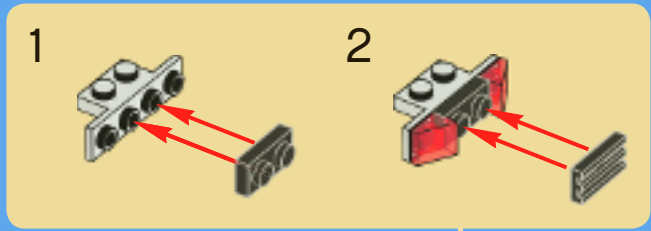

6

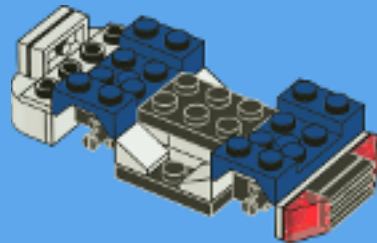



7

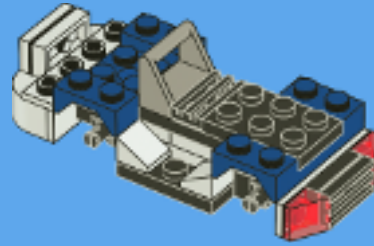

8

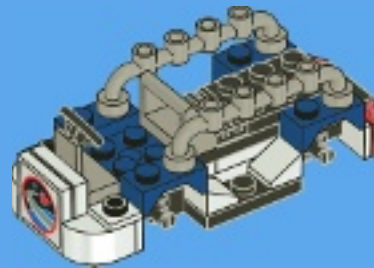

9

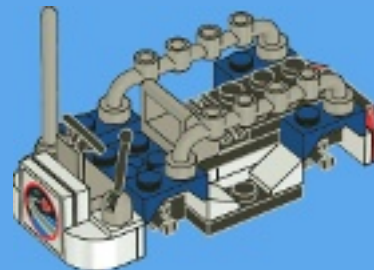

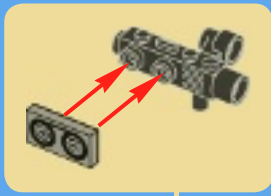

10

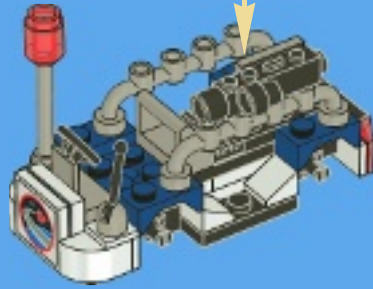

11

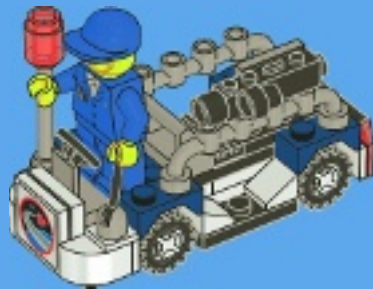

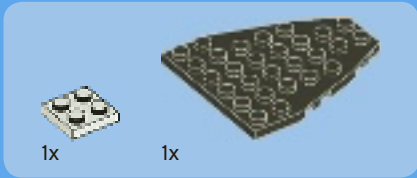
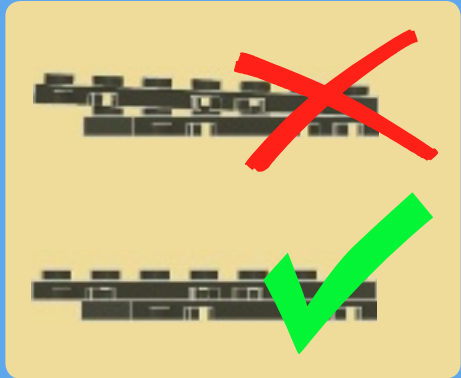
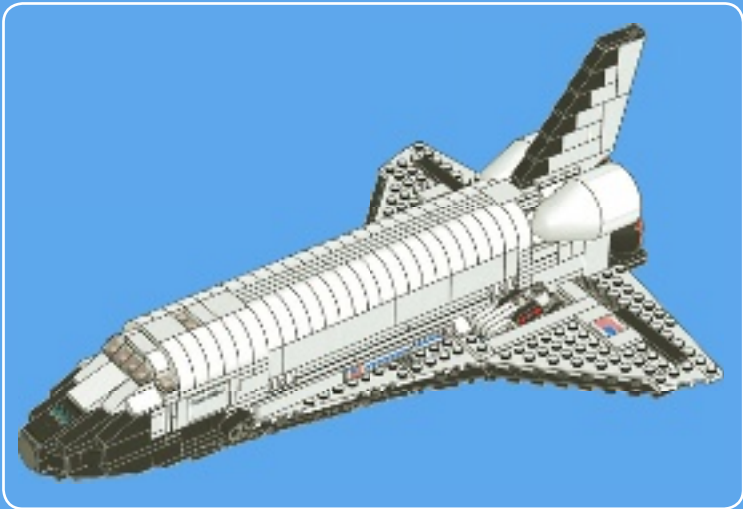

1

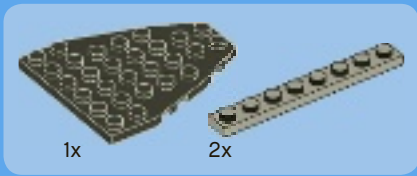
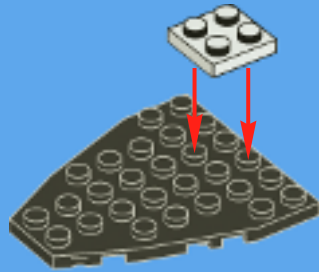

2

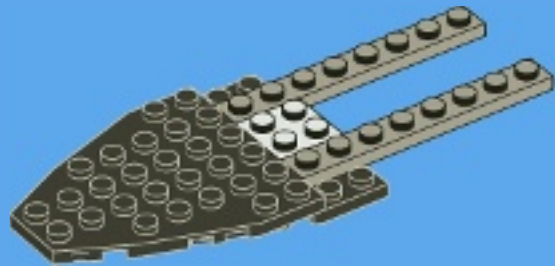



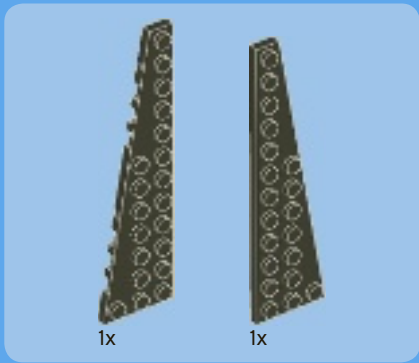

3

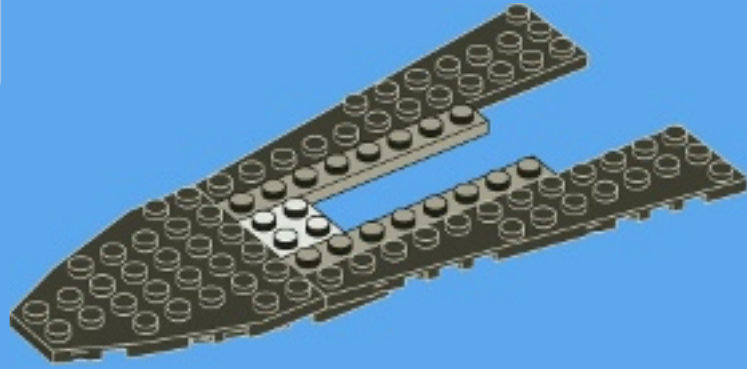

4

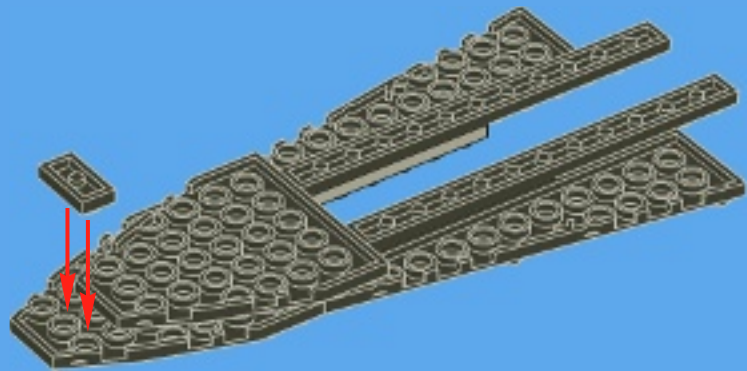

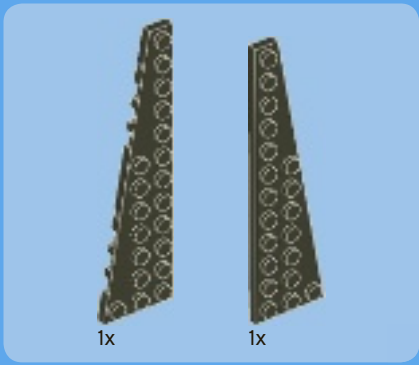

5

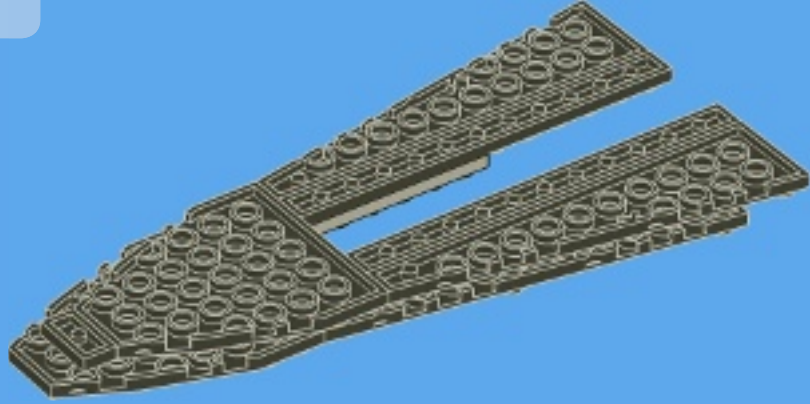

6

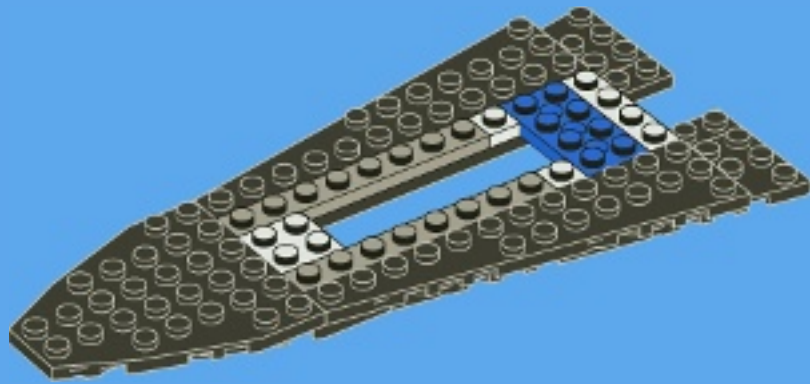

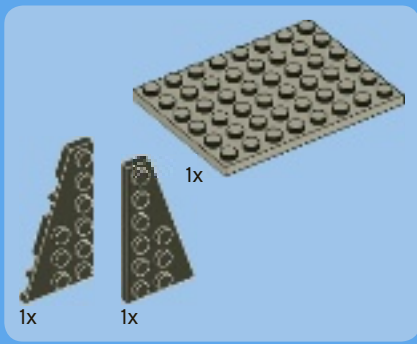

7

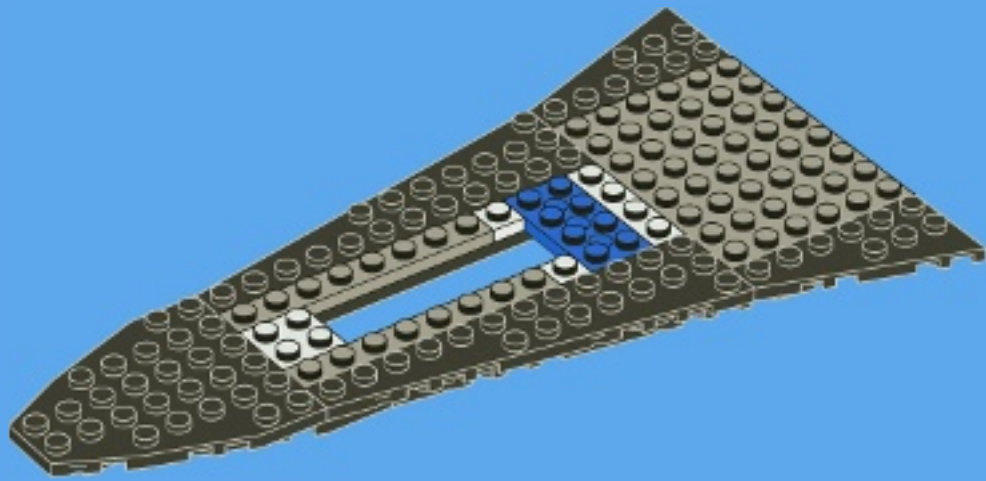

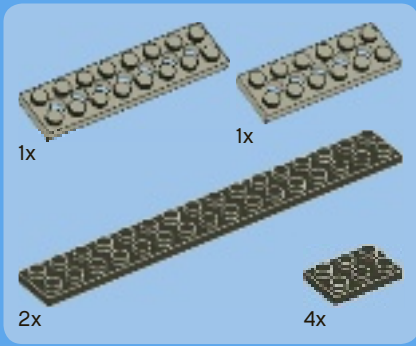

8

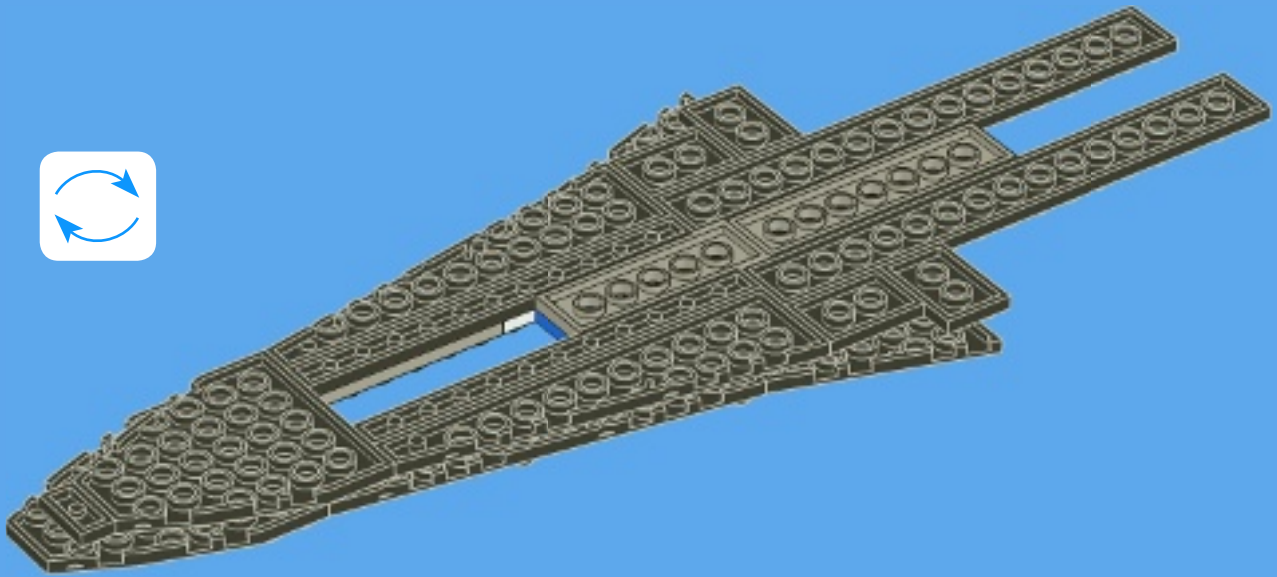

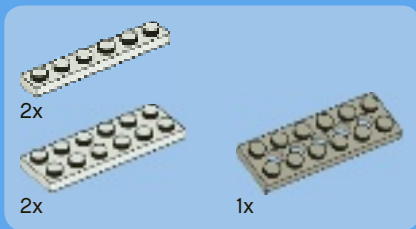

9

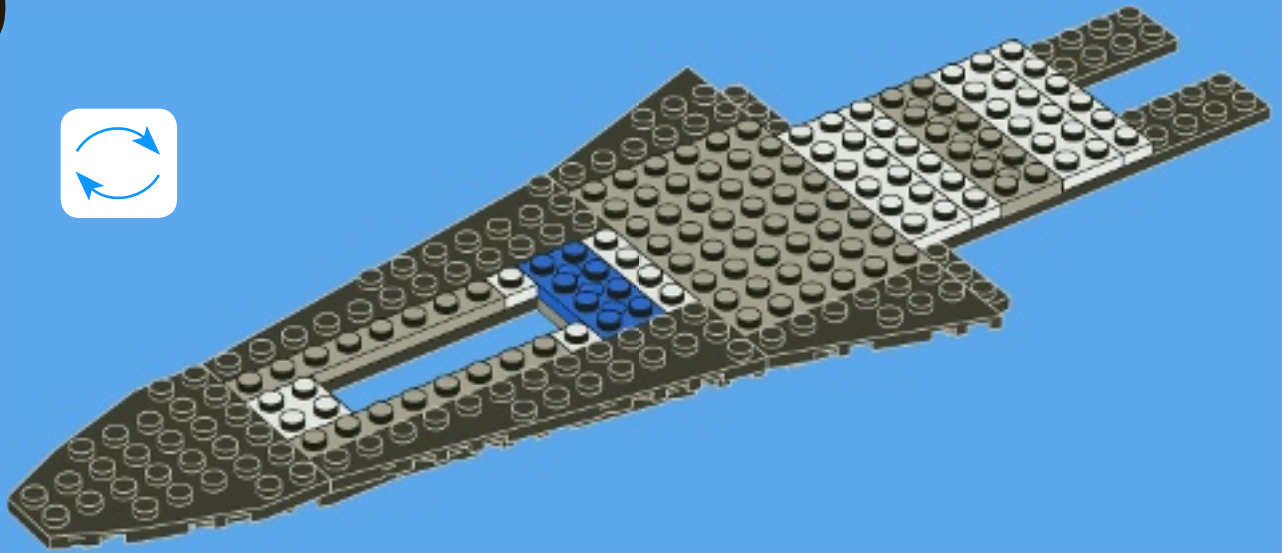

10

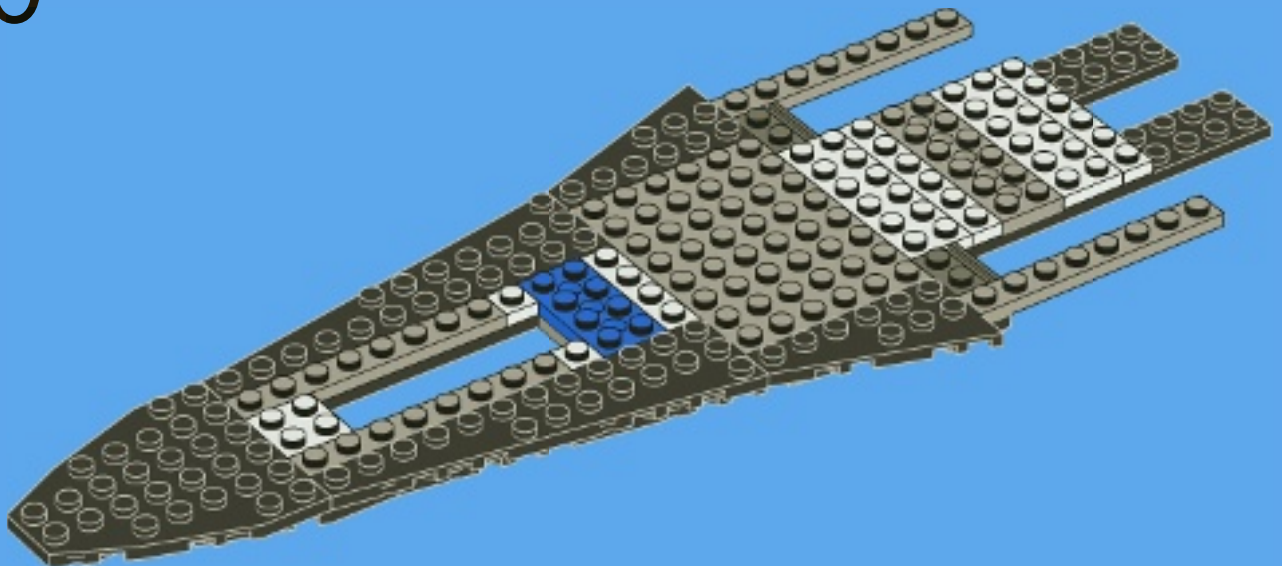

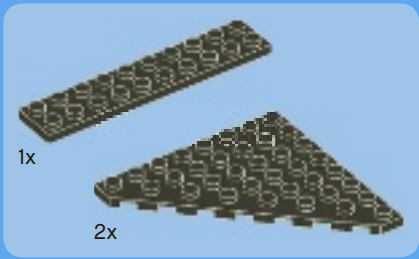

11

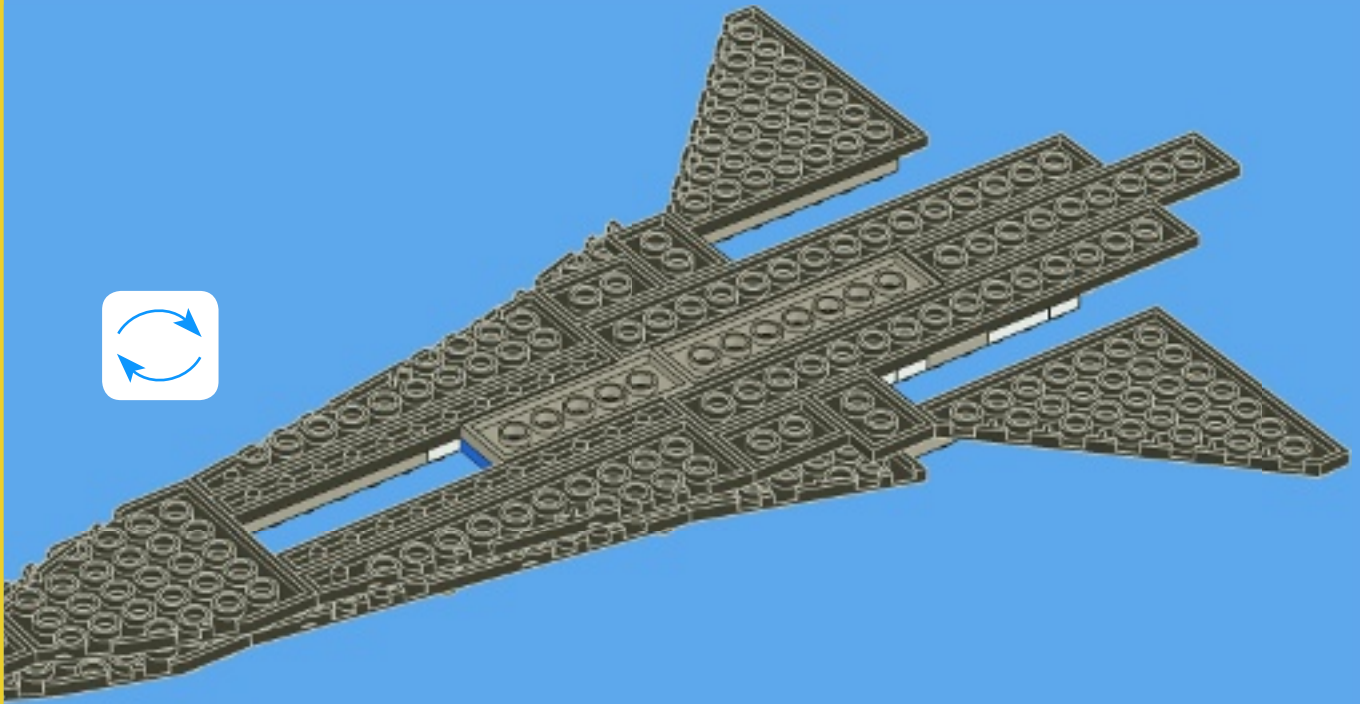



2x



2x

# 12

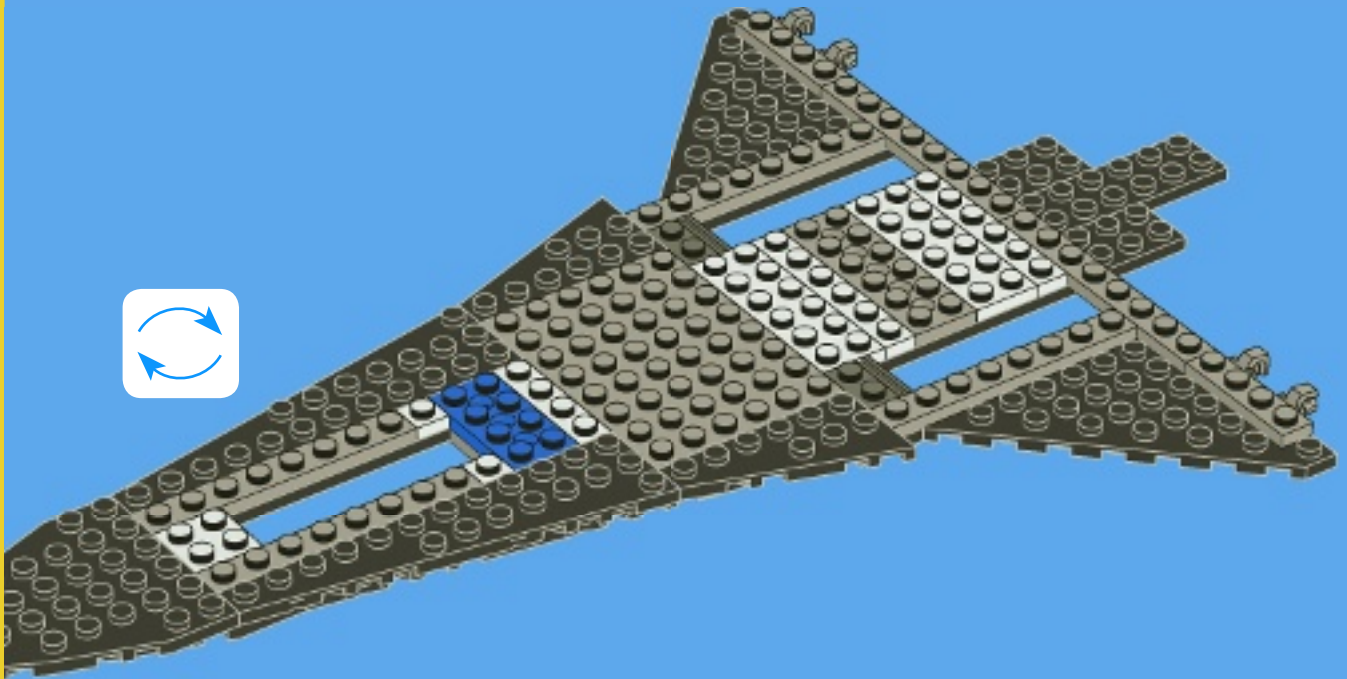

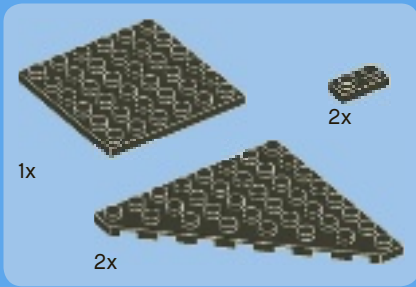

# 13

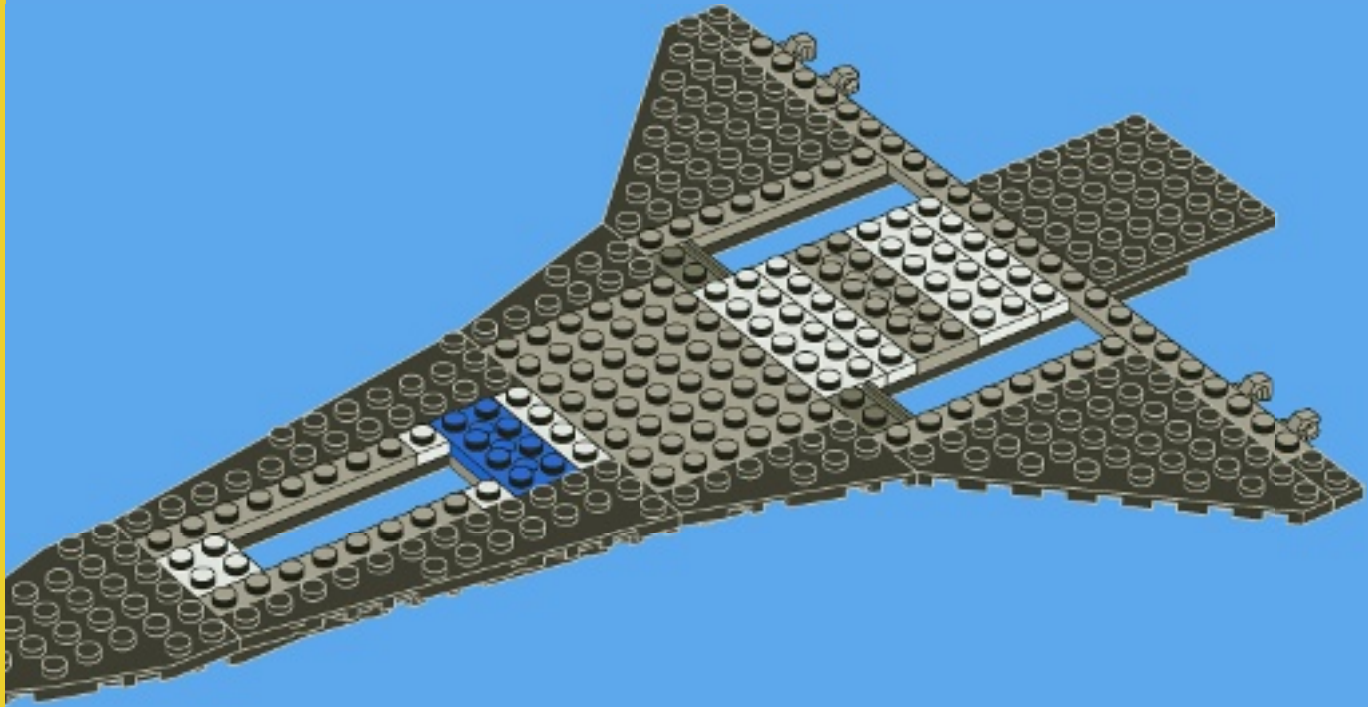





3x



1x

# 14

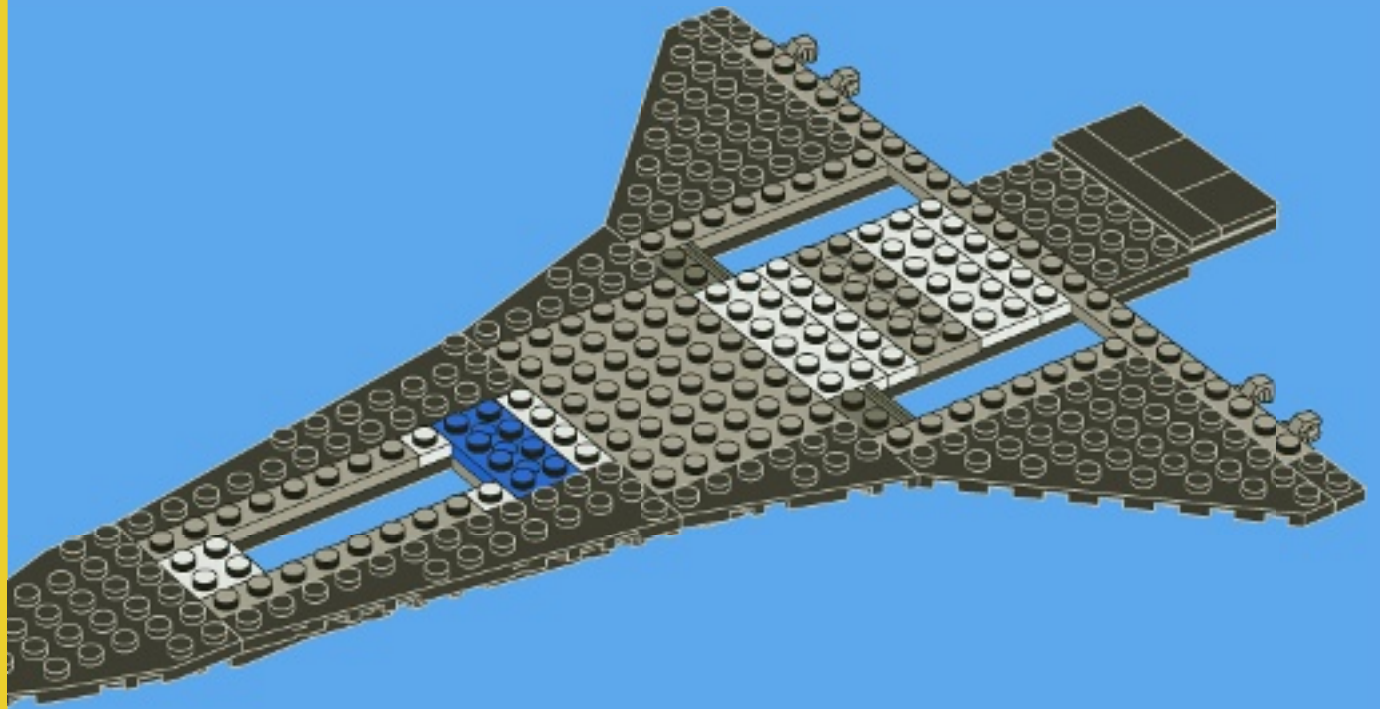

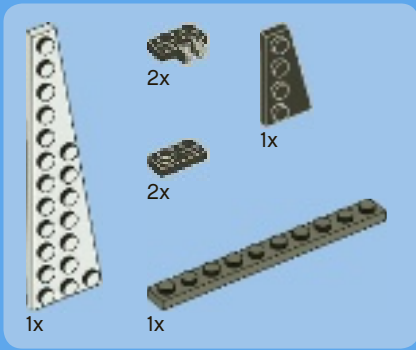

# 15

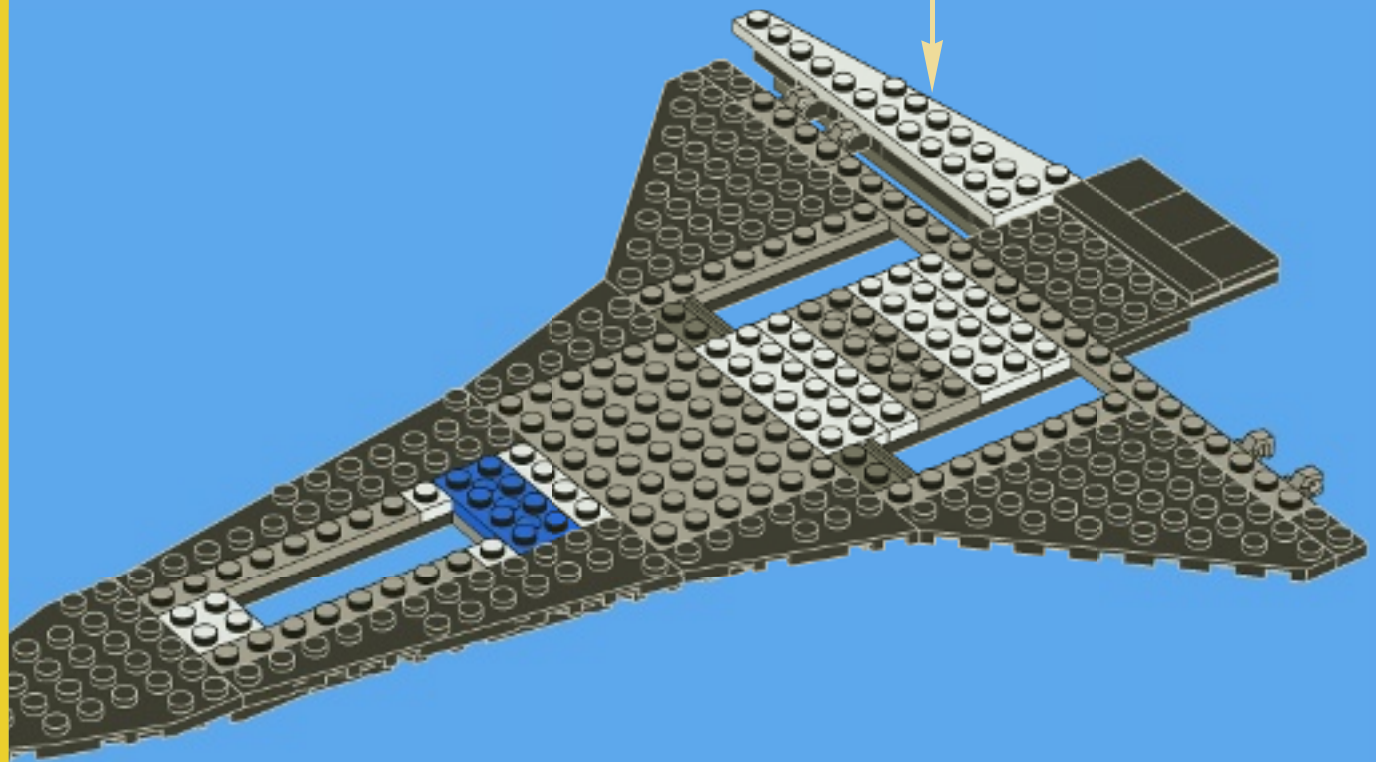
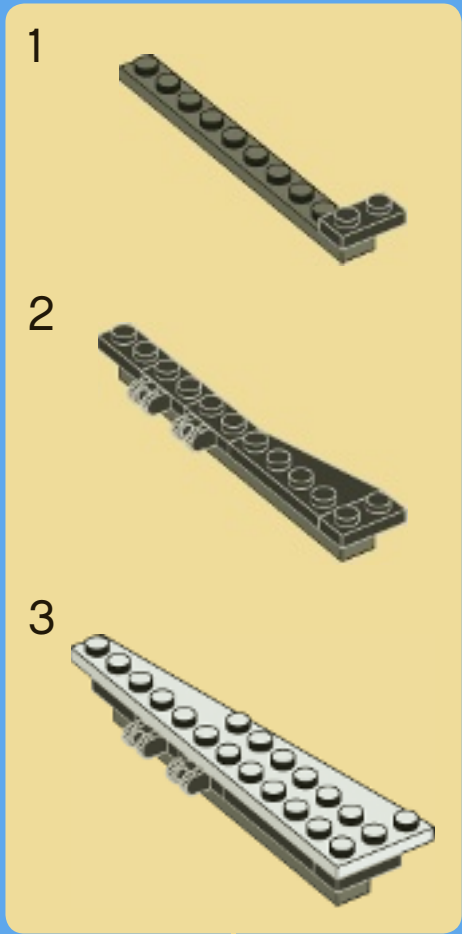

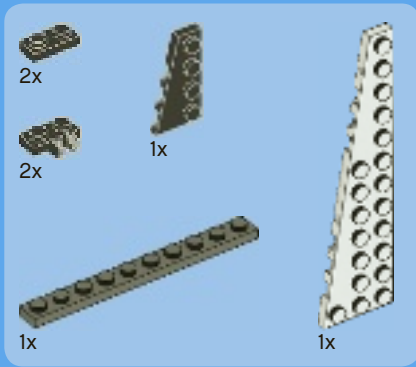

# 16

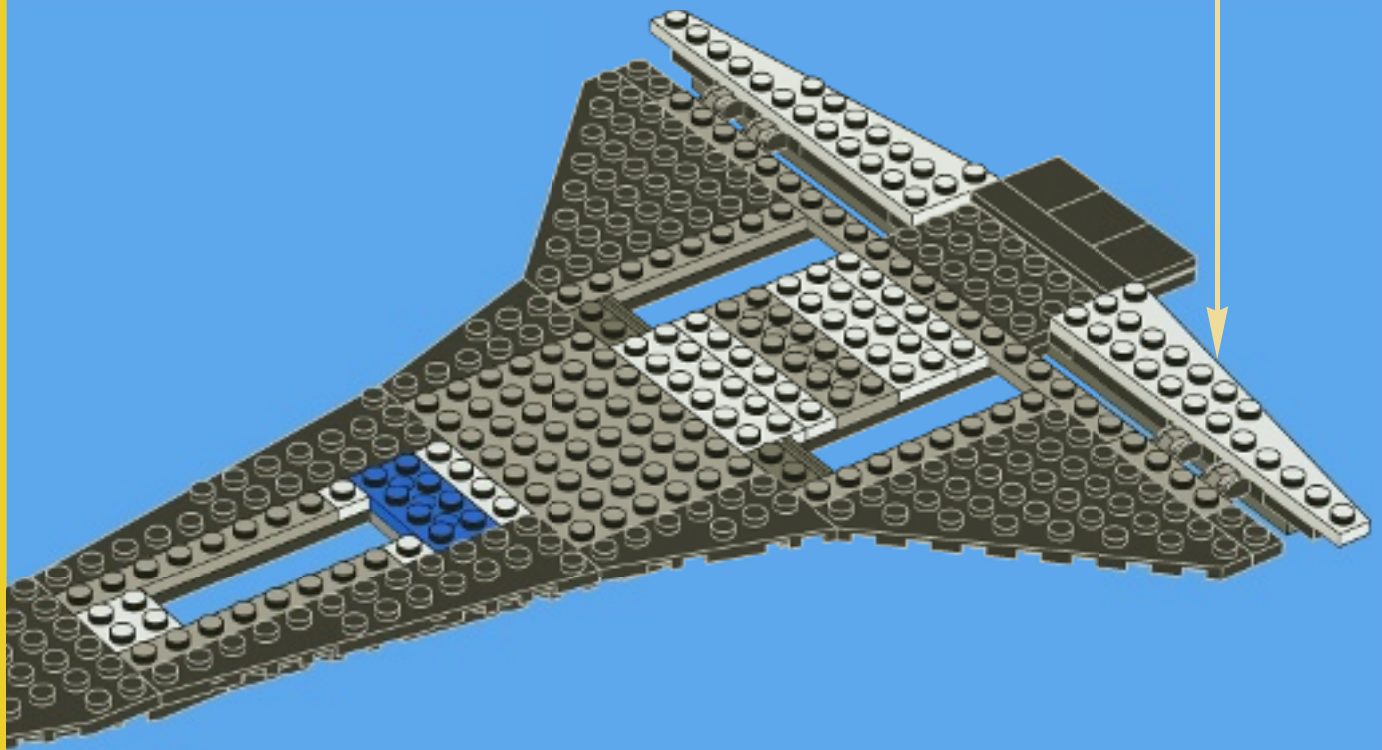
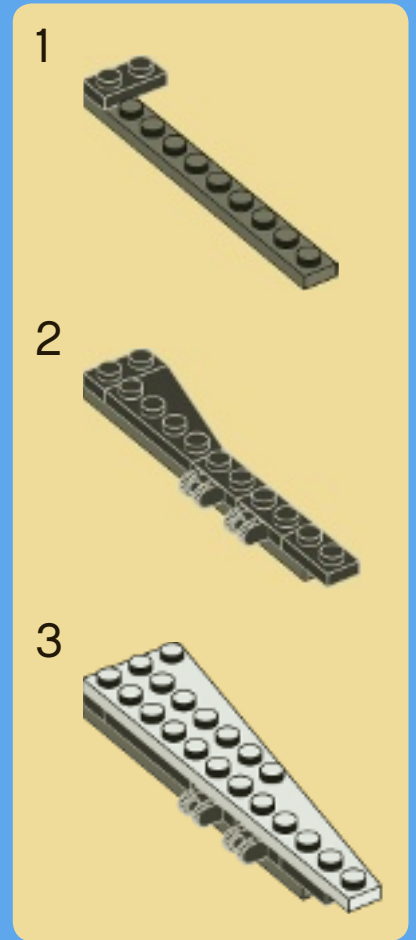

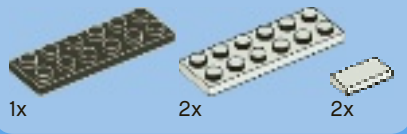

17

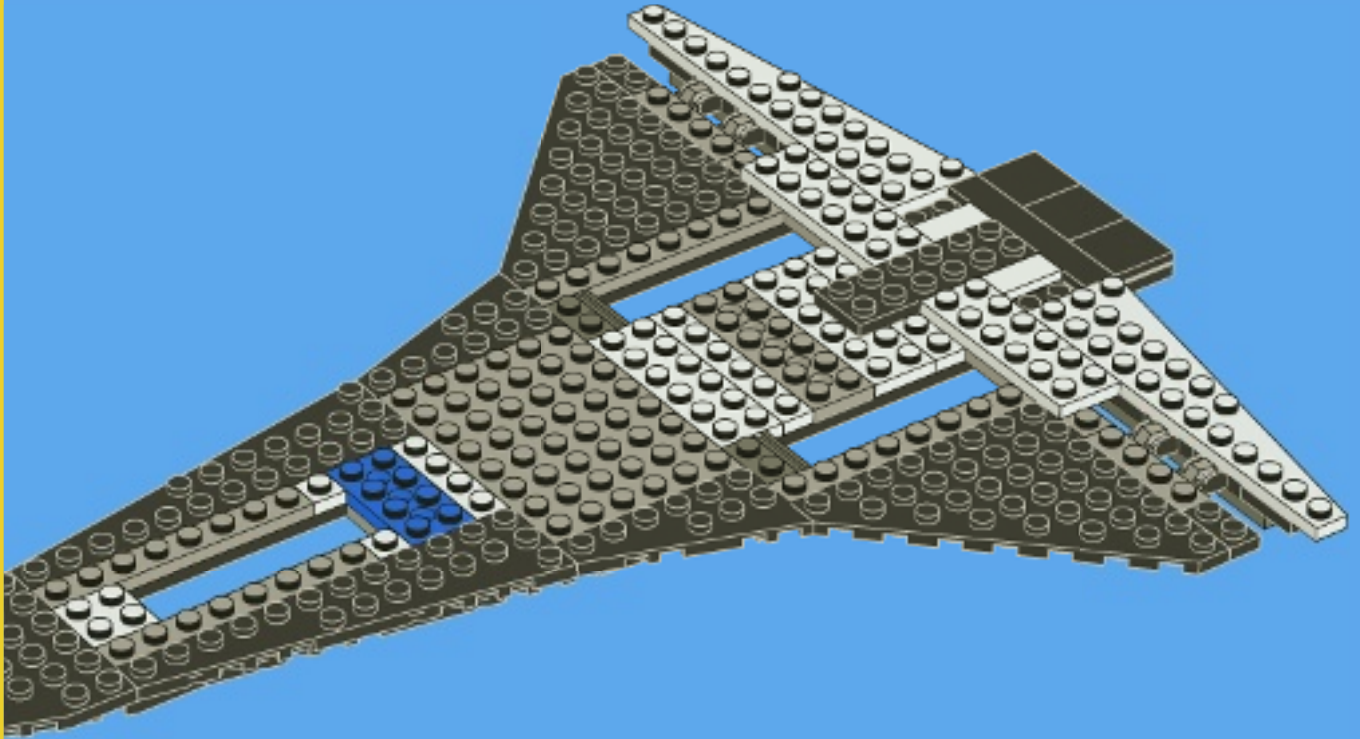



4x



2x

# 18

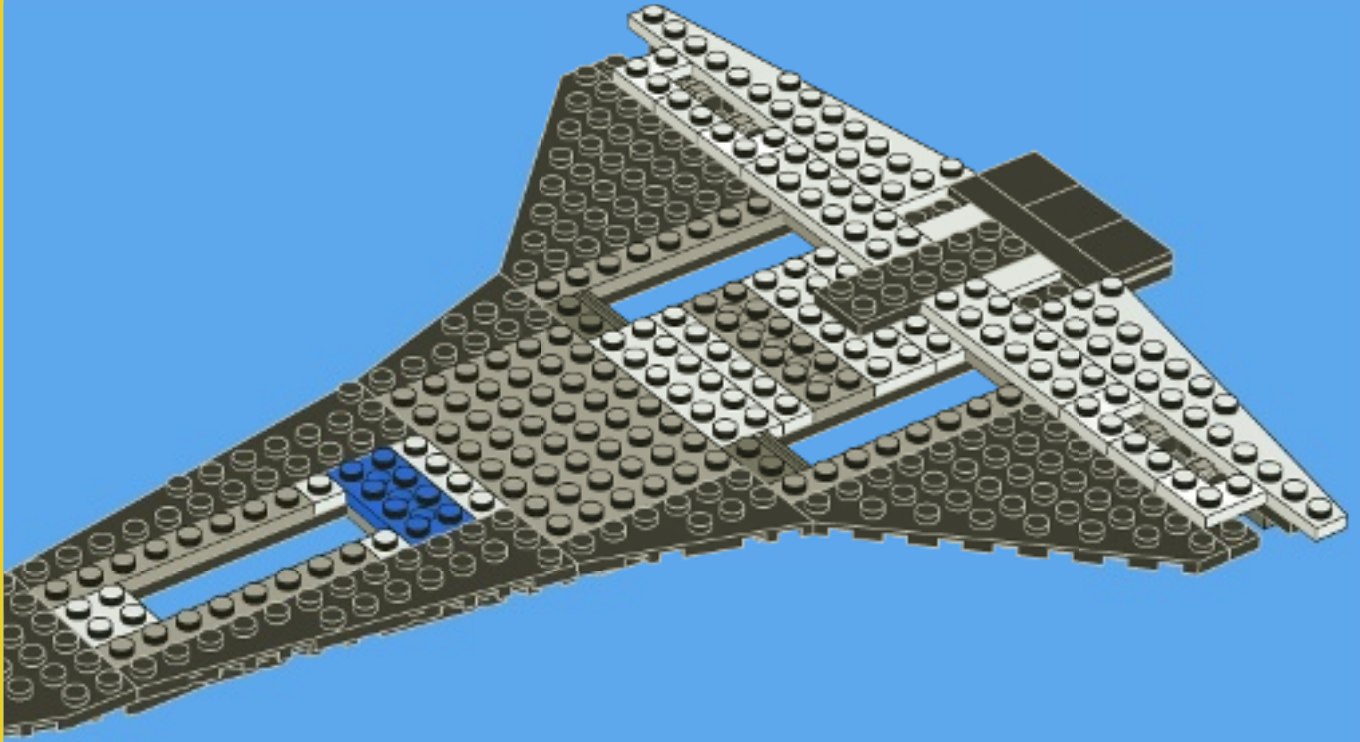

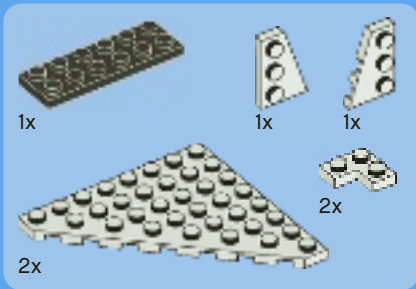

# 19

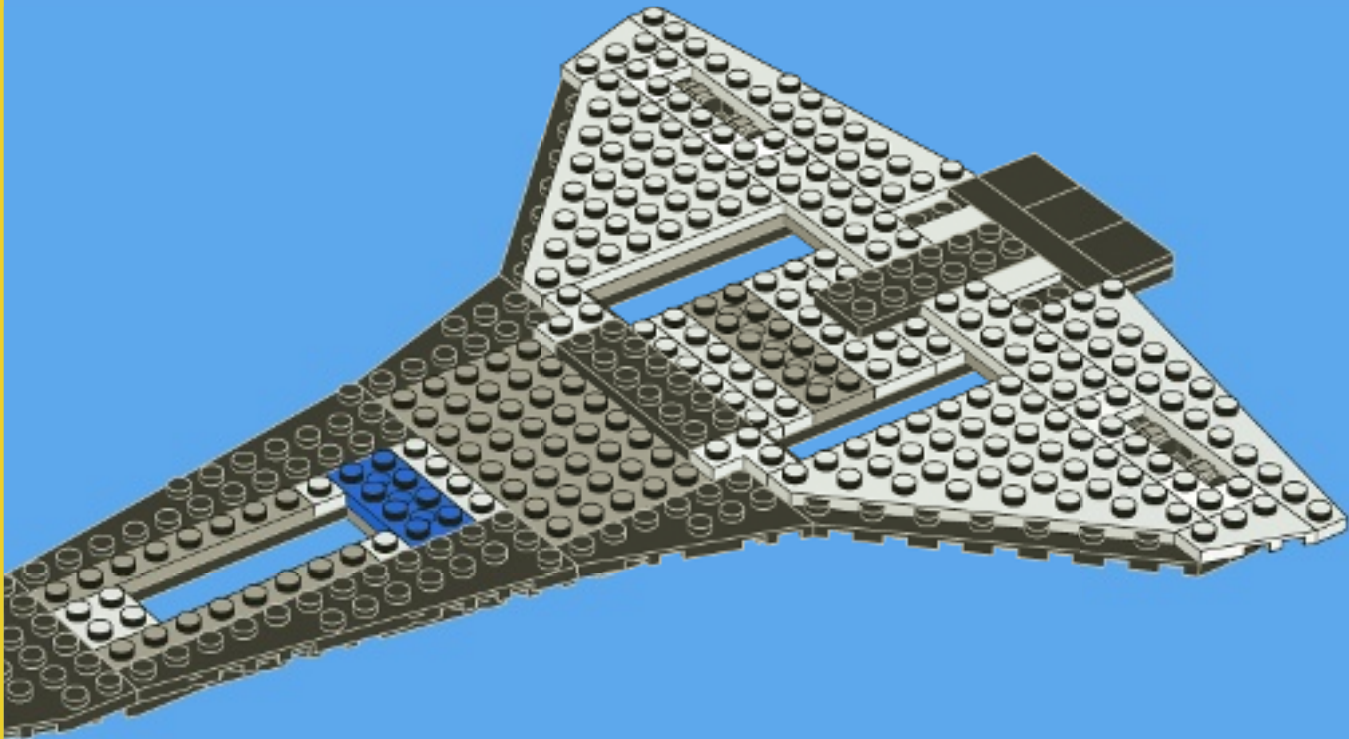

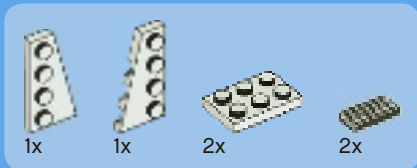

20

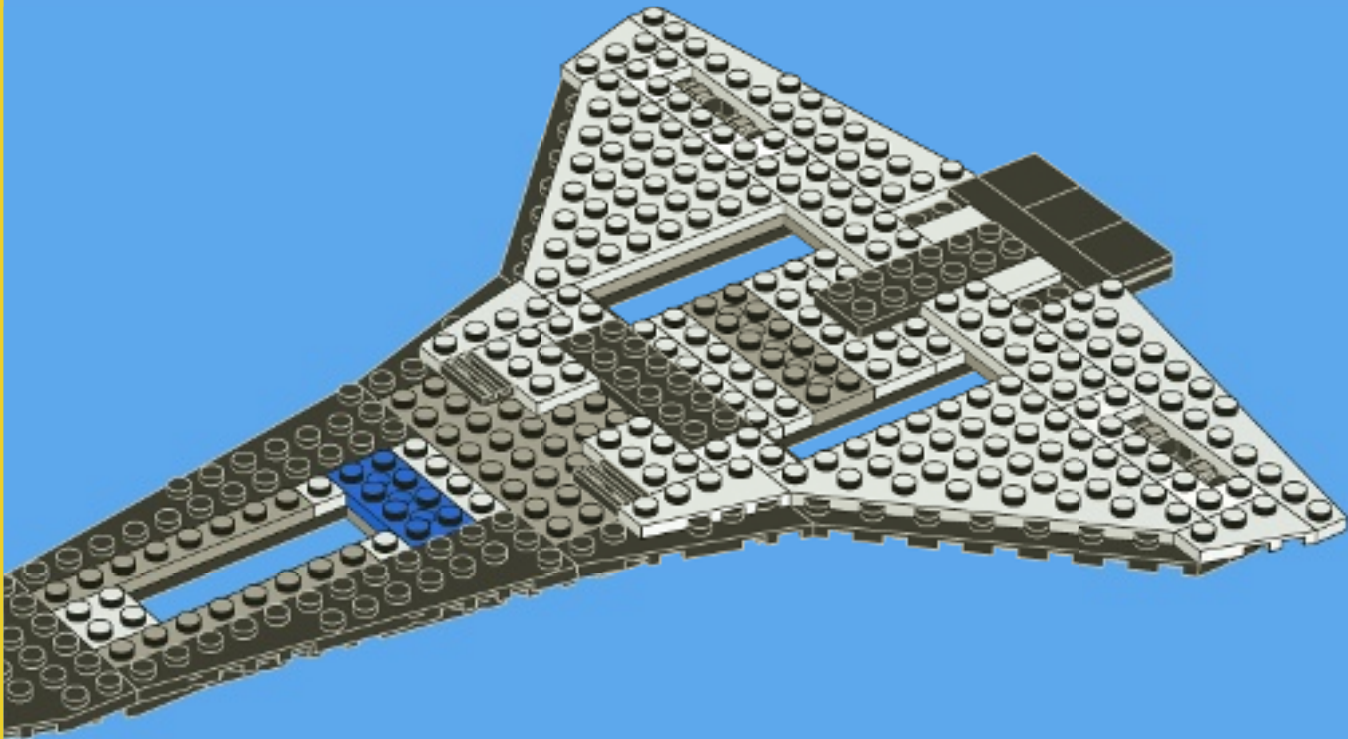

1:1

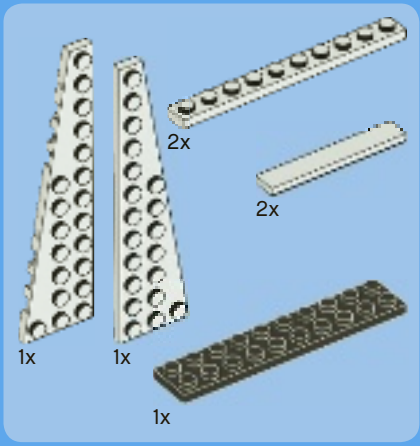

21

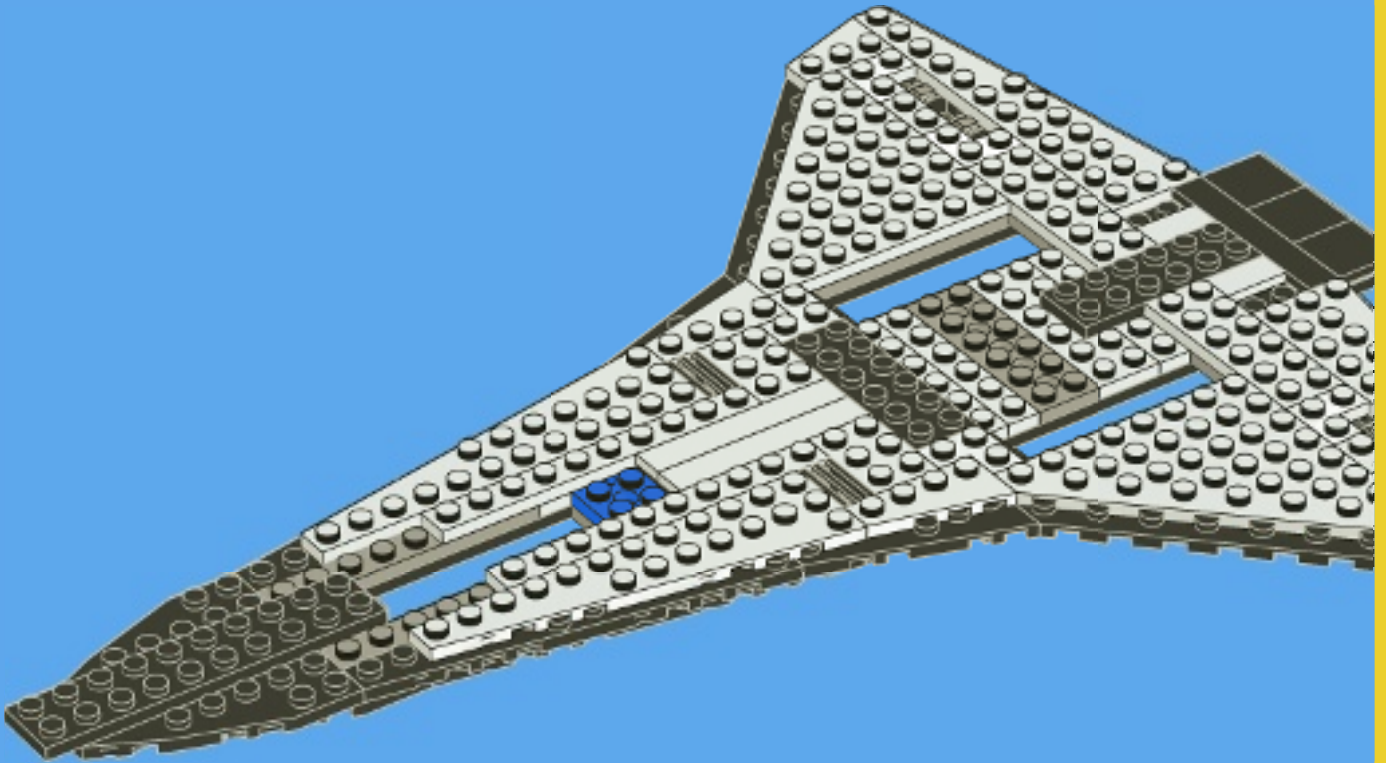



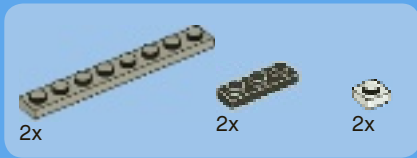

22

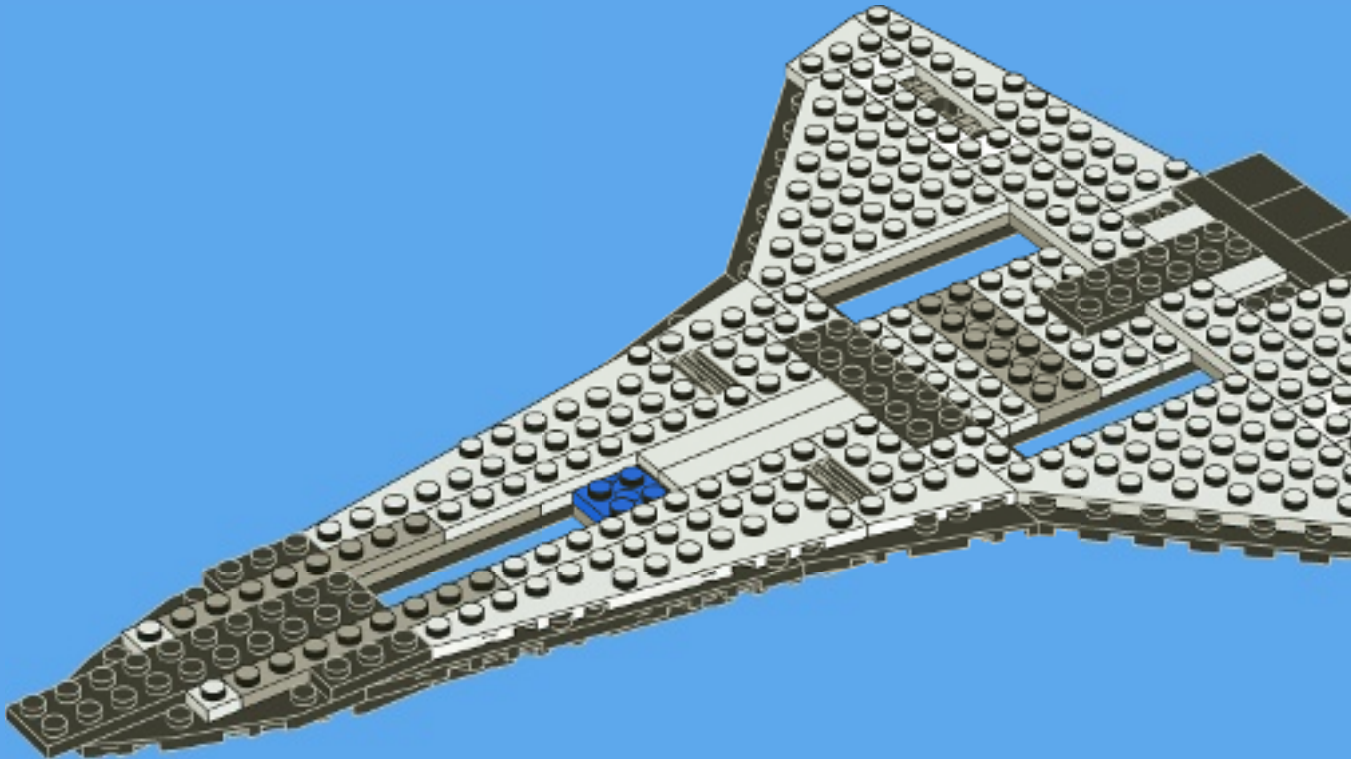

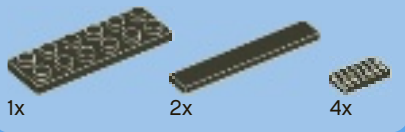

# 23

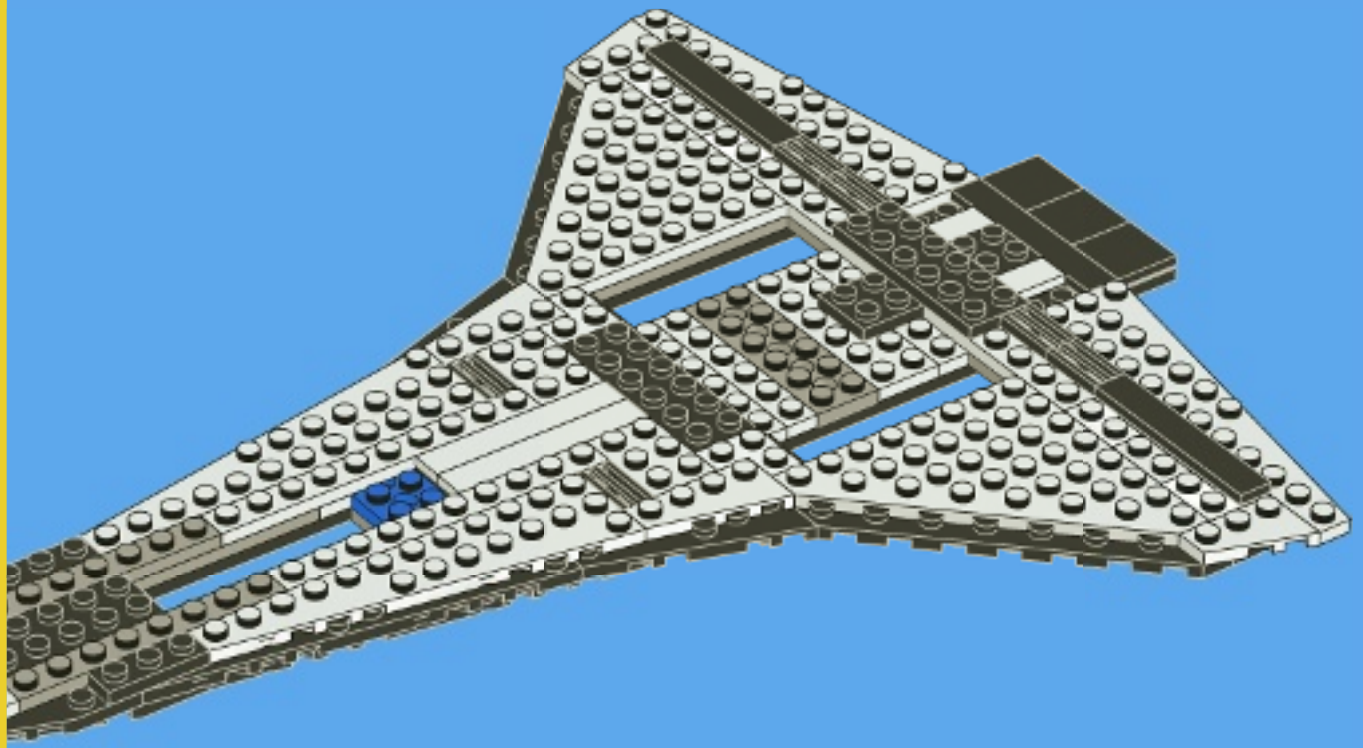

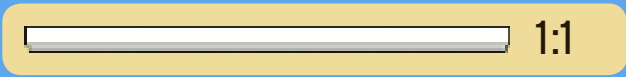
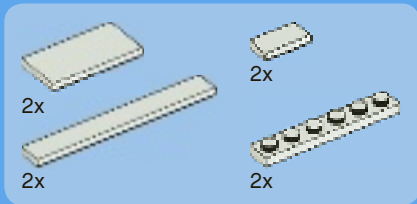

24

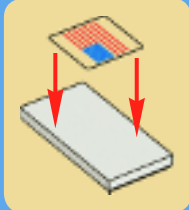
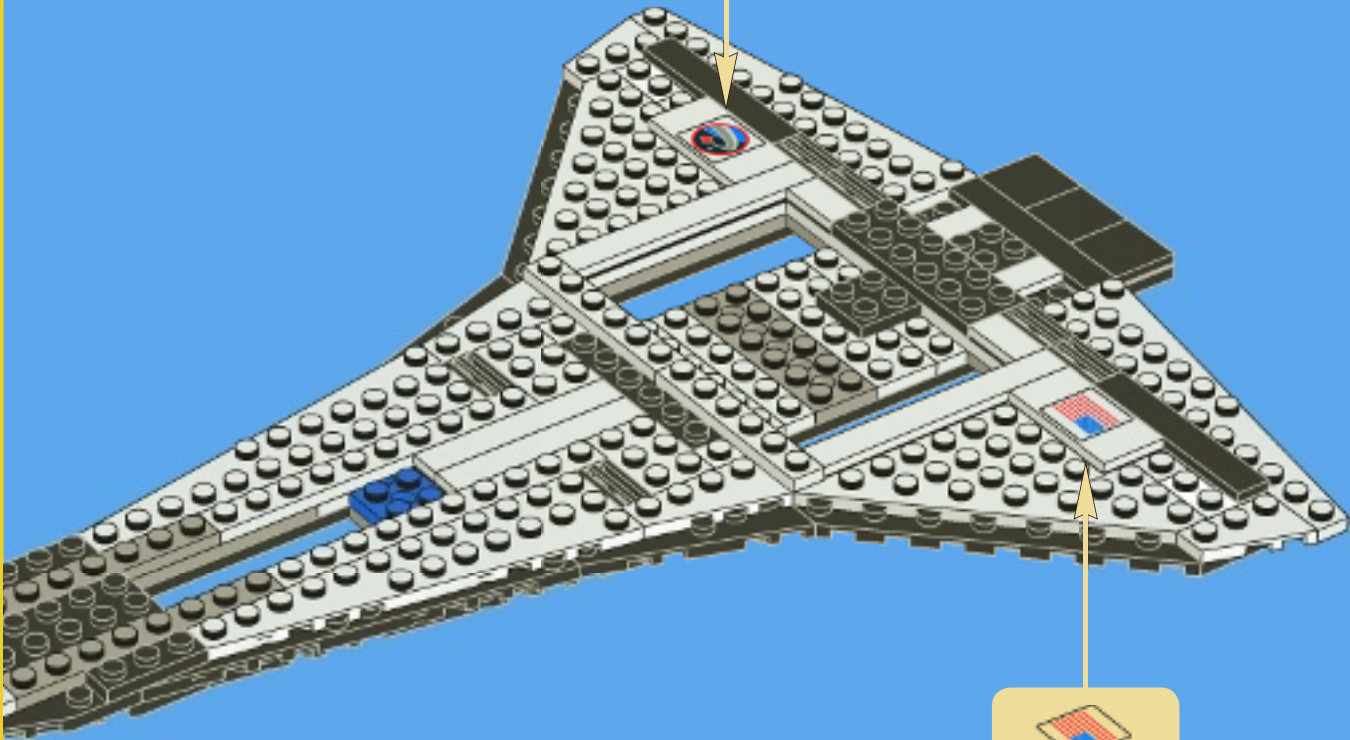
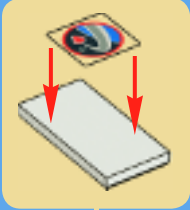



1x



2x



2x



1x

# 25

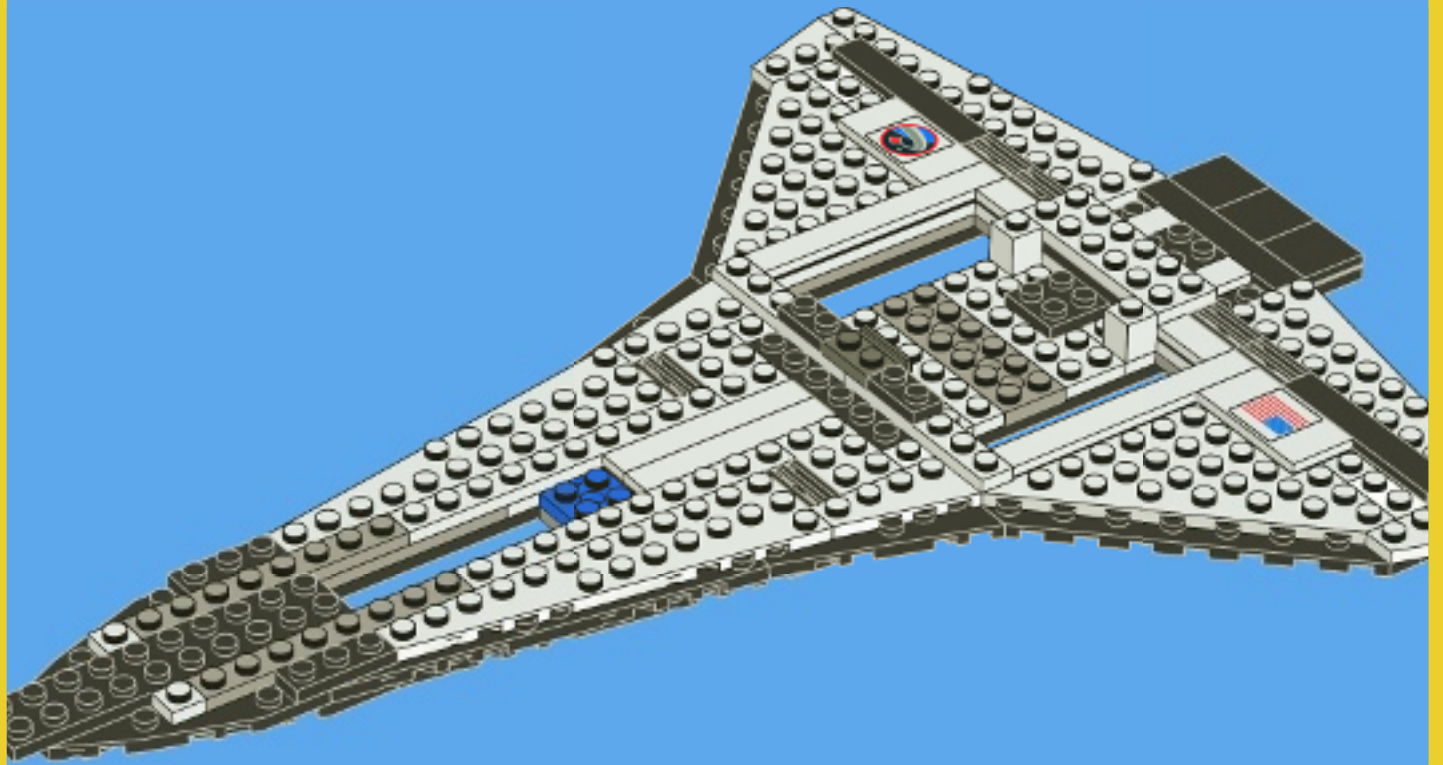



1



2

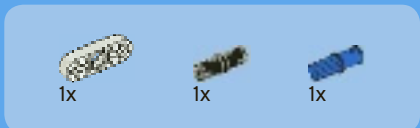
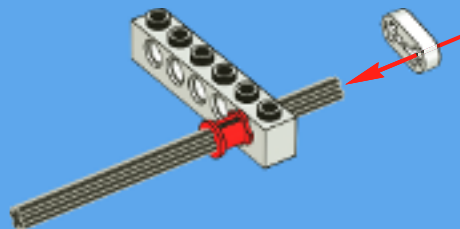

3

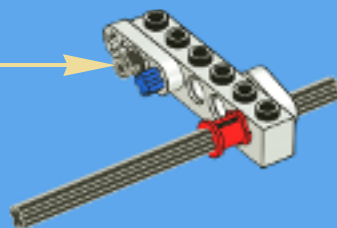
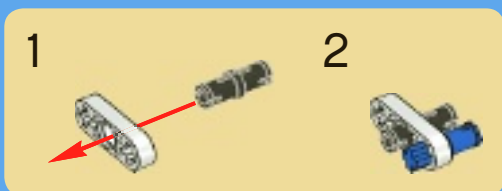

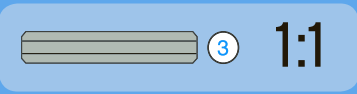

4

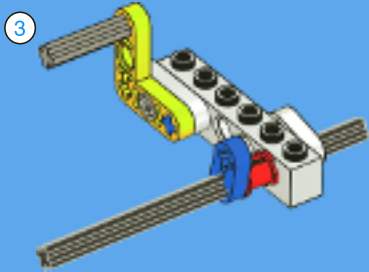

5

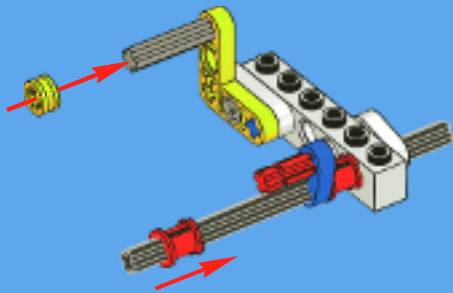

6

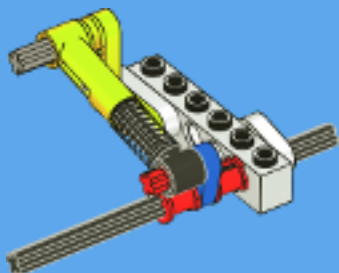



1x



1x



1x

# 7

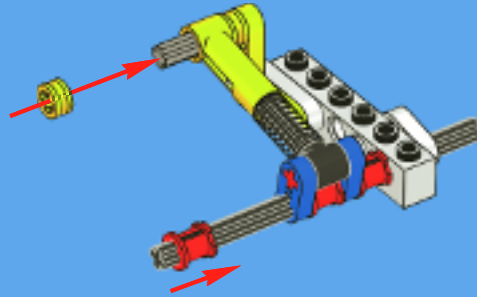

1x



1x



1x



1x

# 8

1

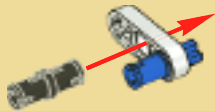

2

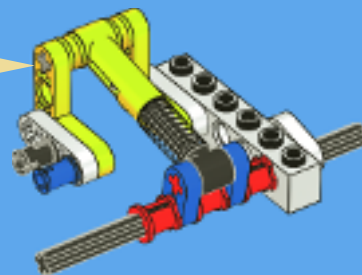



9

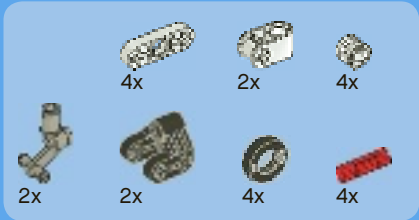
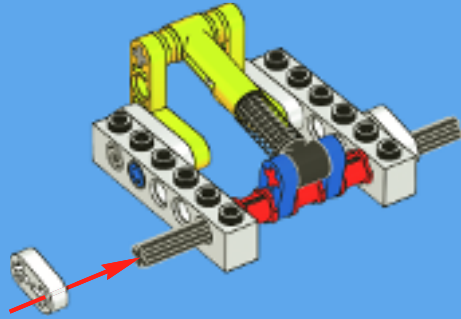

10

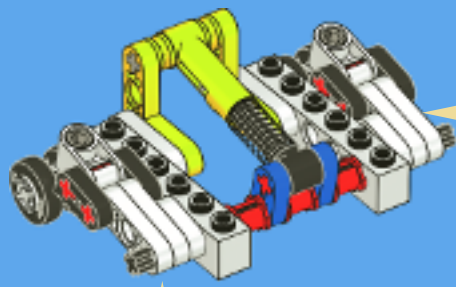
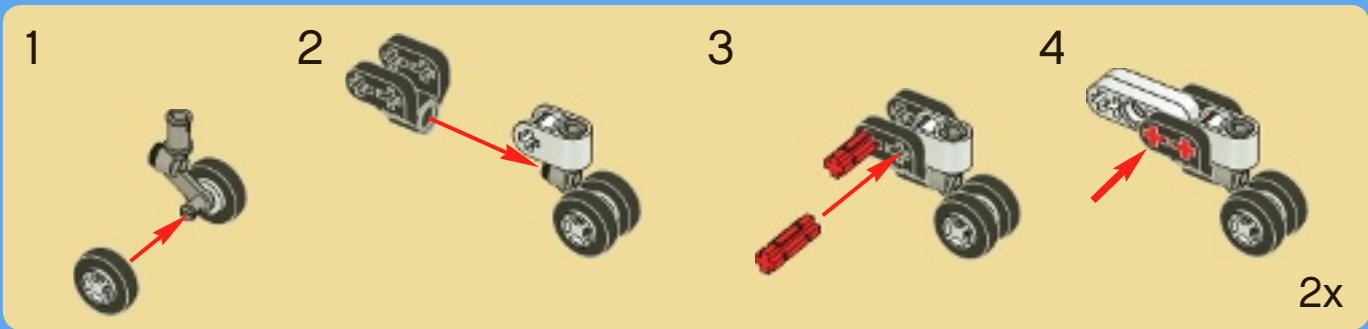





11

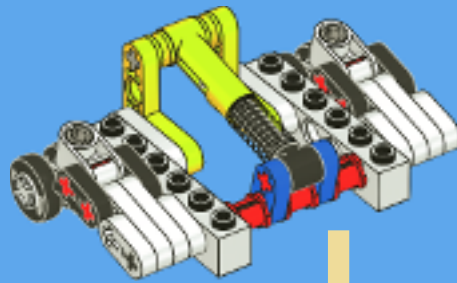

26

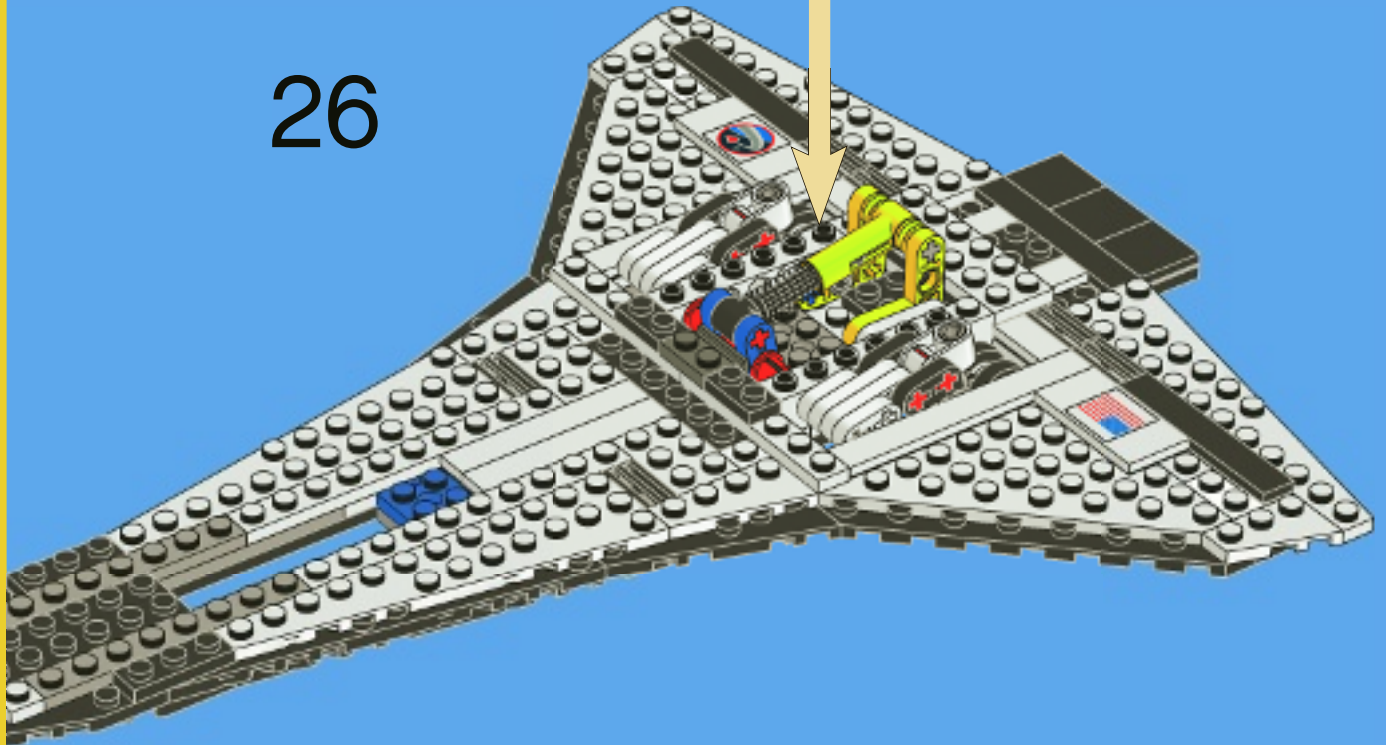



1x



2x



2x

# 27

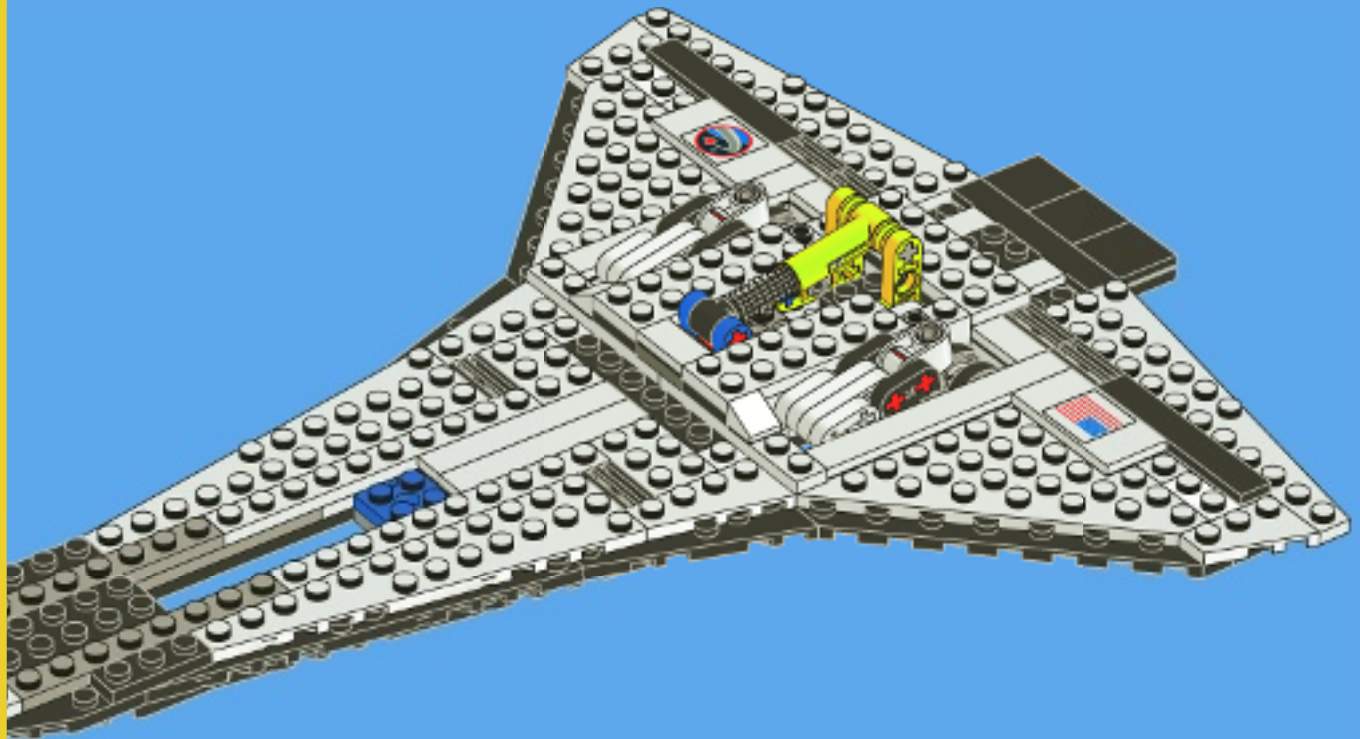



2x



4x

# 28

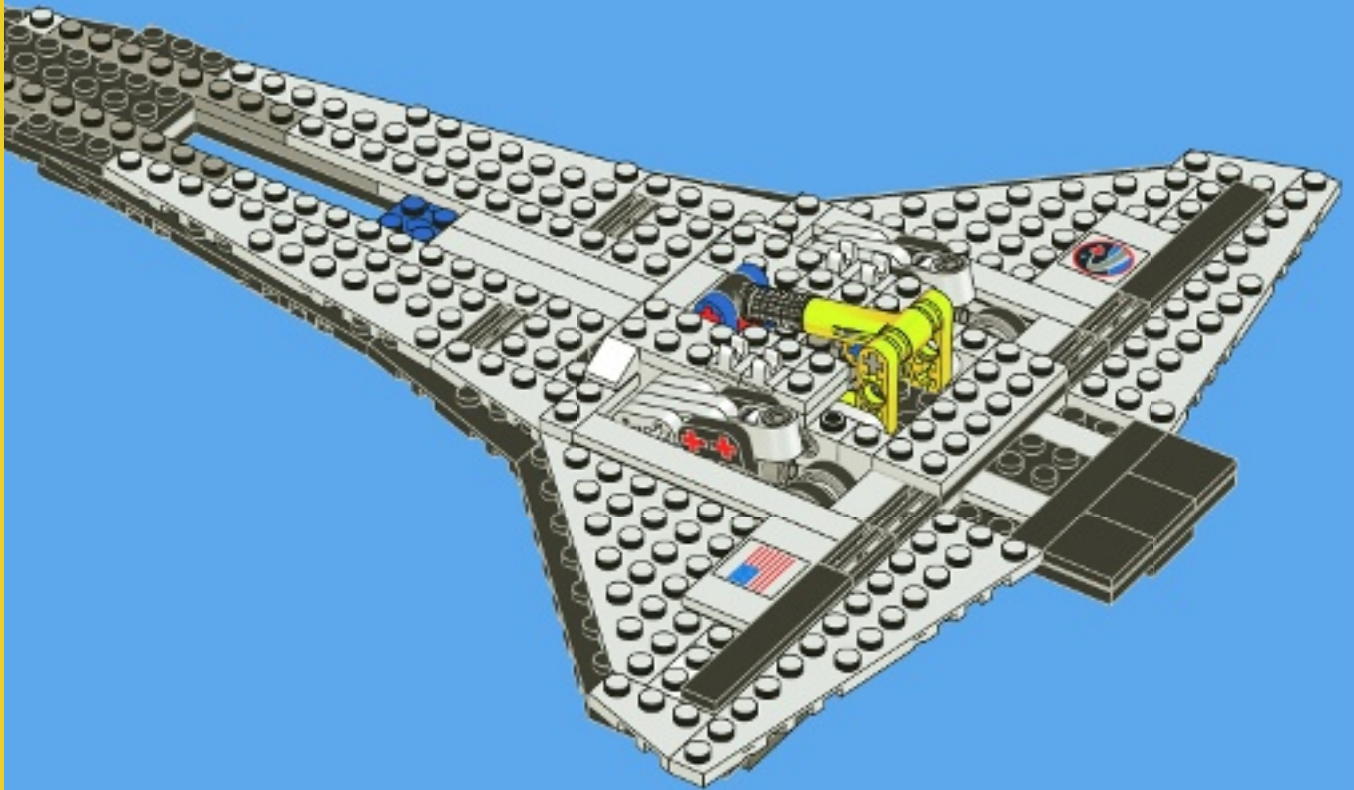



2x



2x



1x

# 29

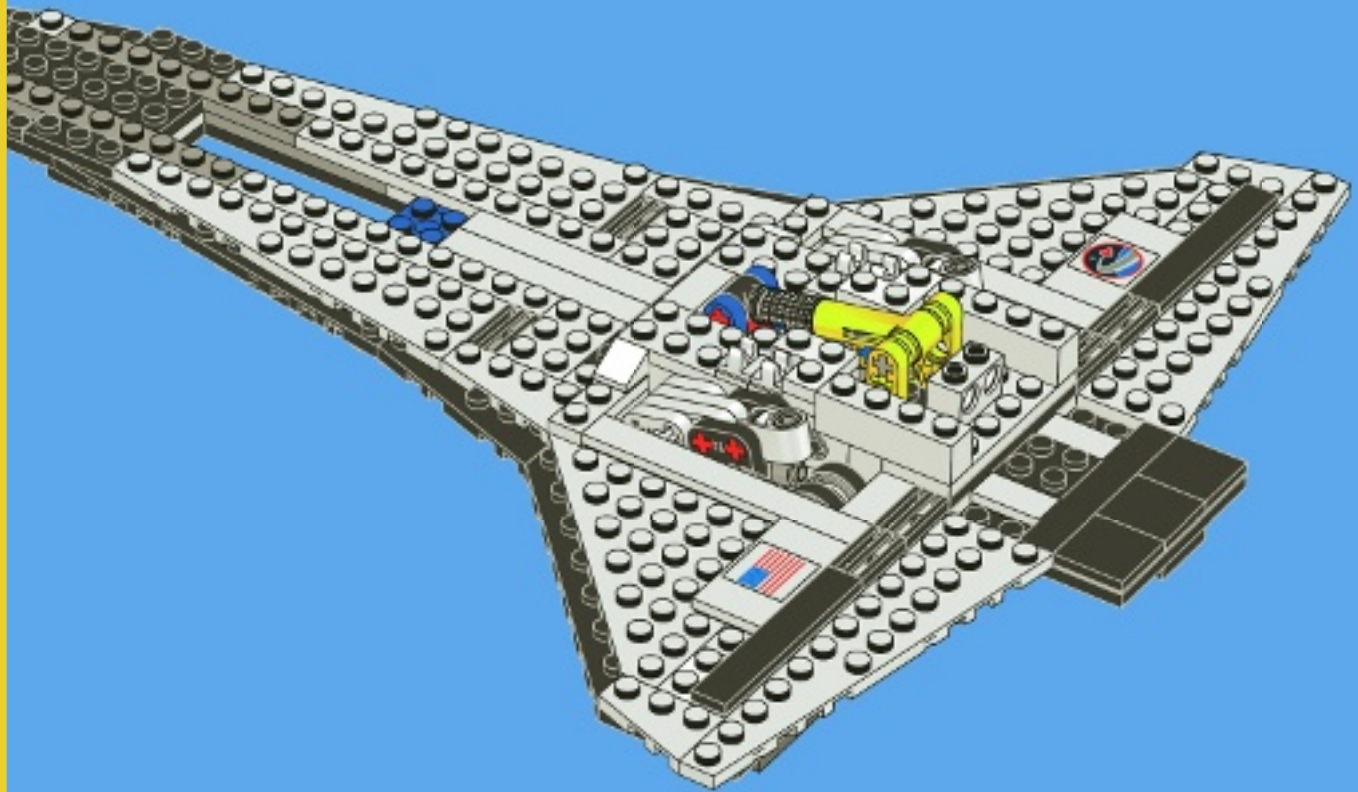

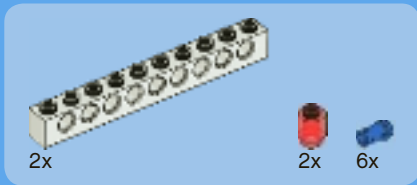

# 30

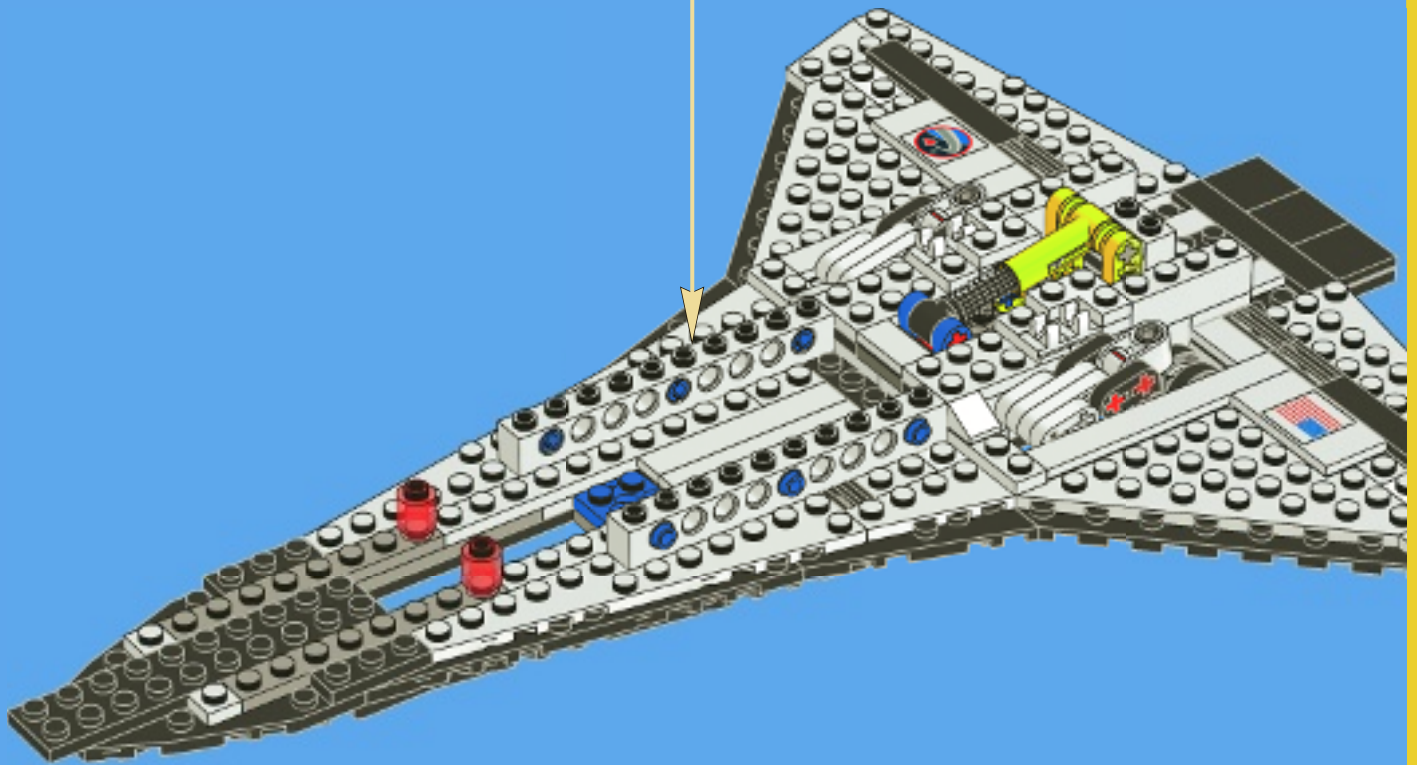
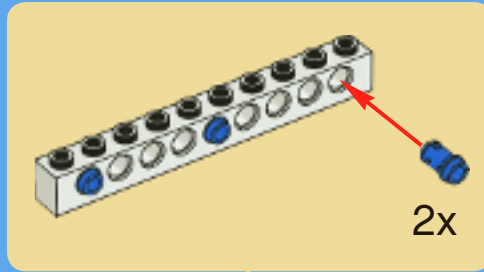

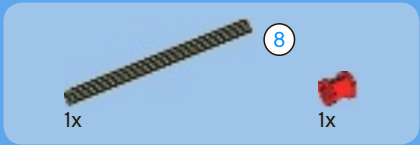

1



2

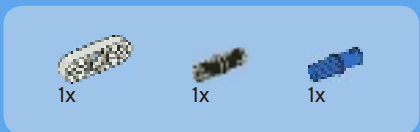
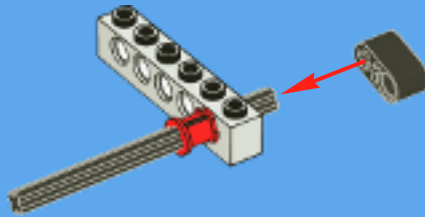

3

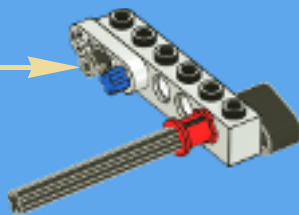



1x



1x

# 4

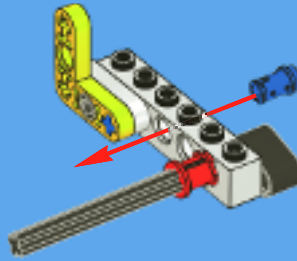

1x



1x

3

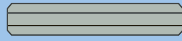

3

1:1

# 5

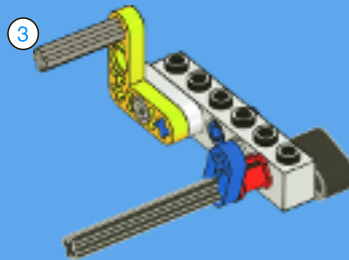

1x



1x



1x

3



1x

# 6

1



3

2

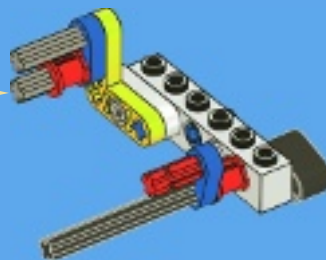

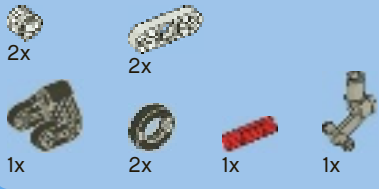

7

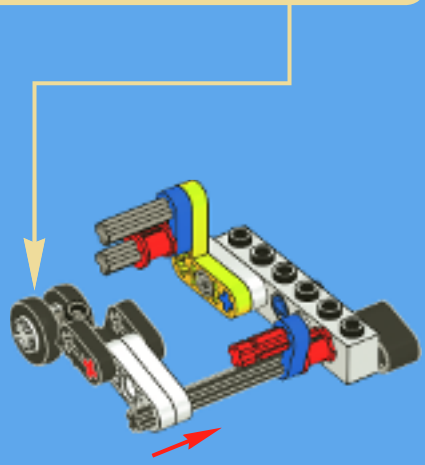
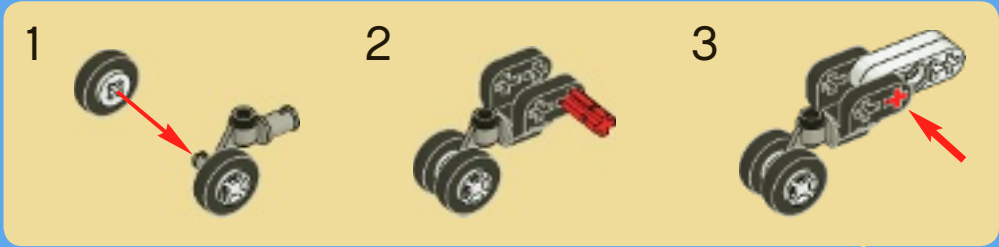

8

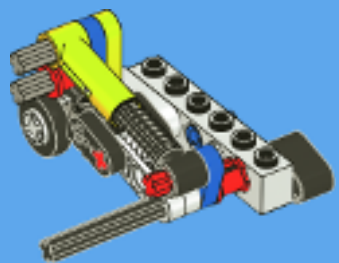





2x



1x

# 9

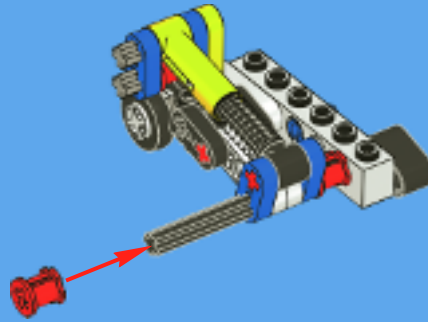

1x



1x



1x



1x

# 10

1

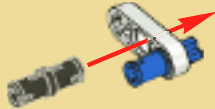

2

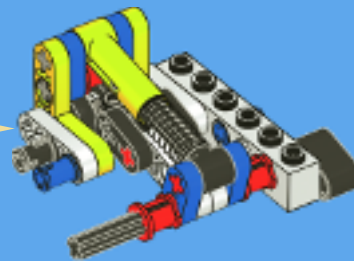



1x

# 11

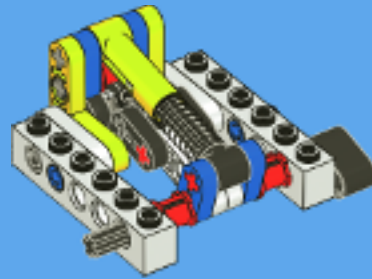

1x



1x

# 12

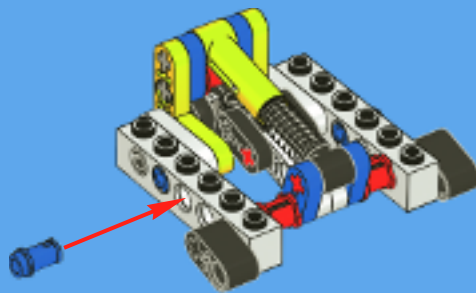

31

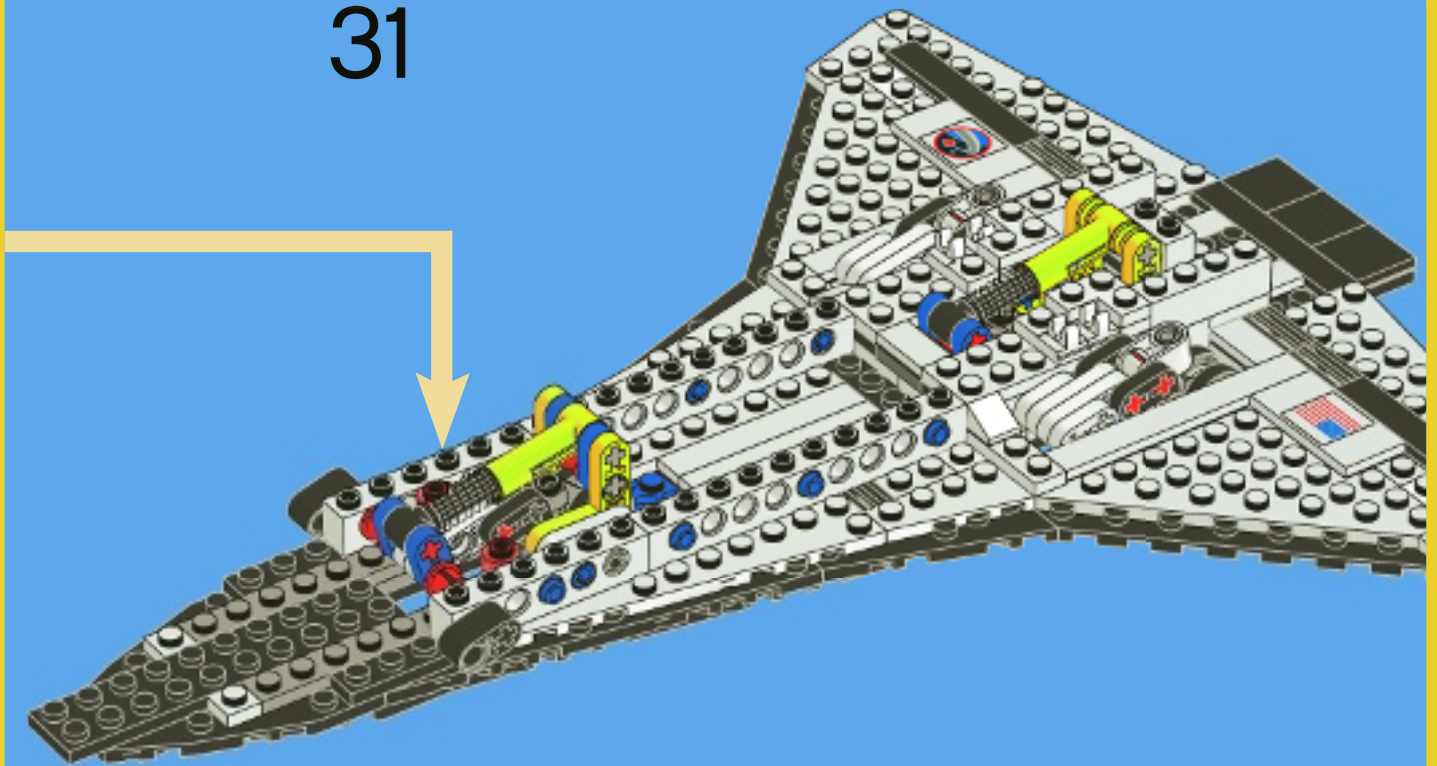

32

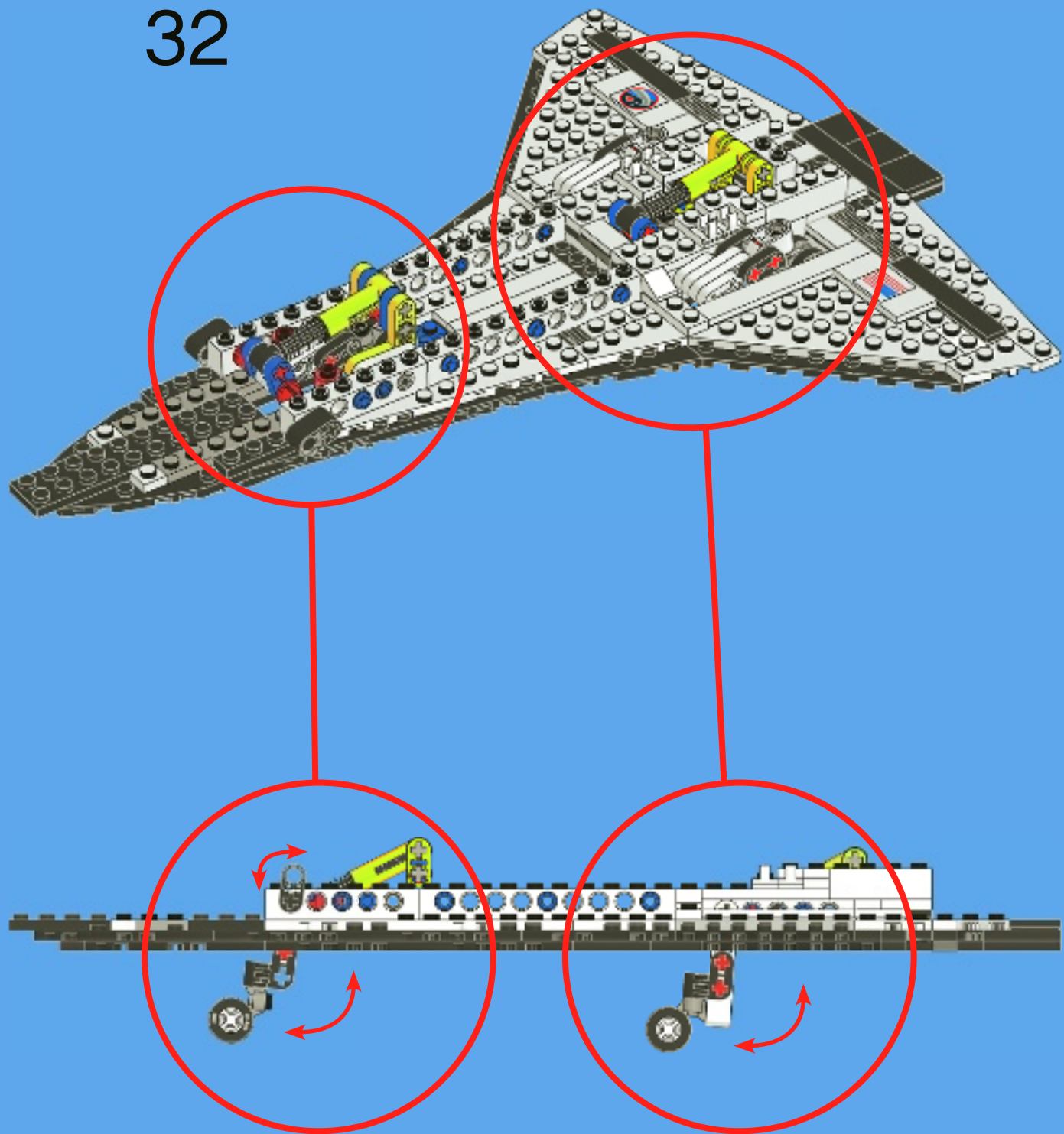

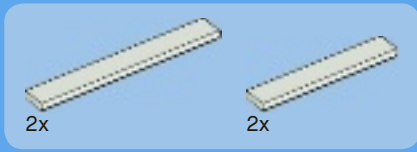

# 33

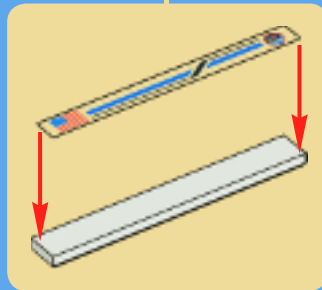
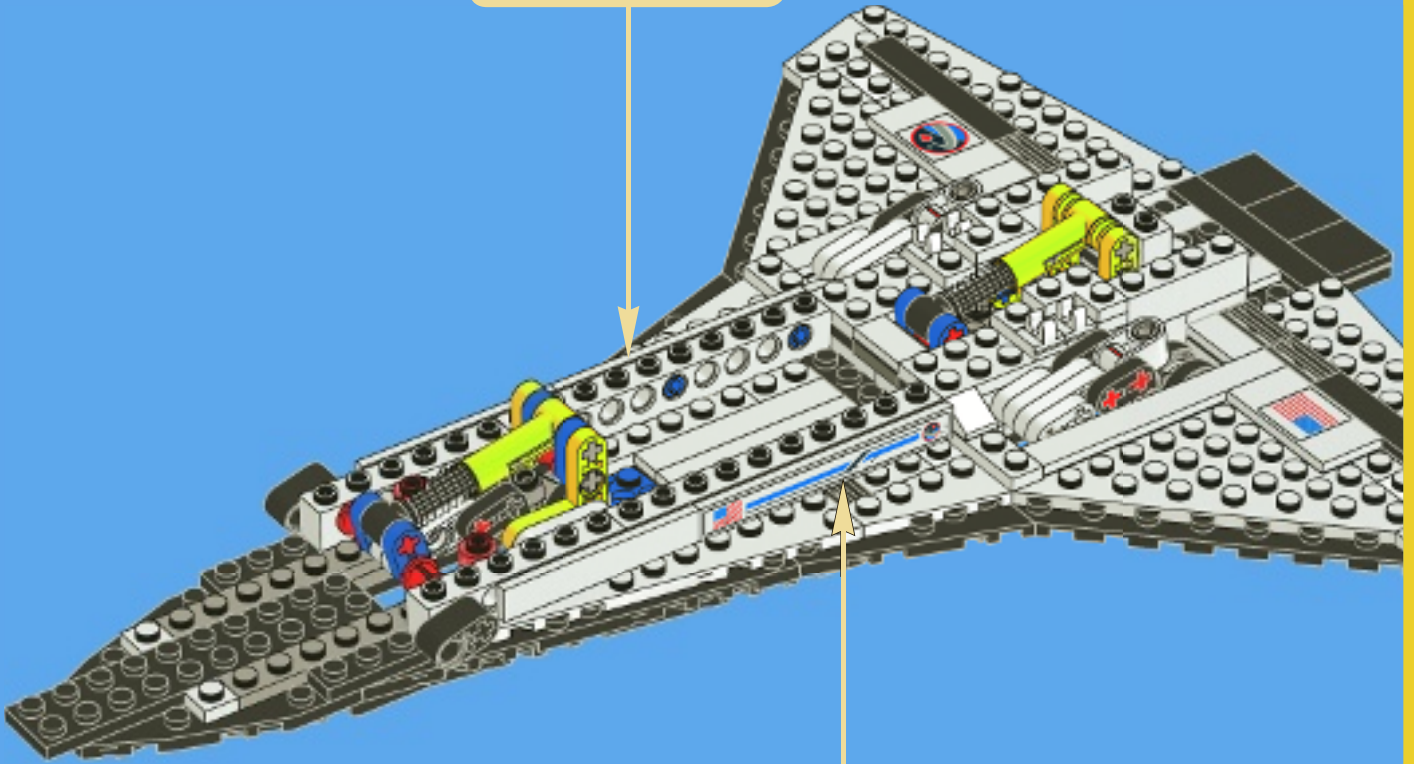
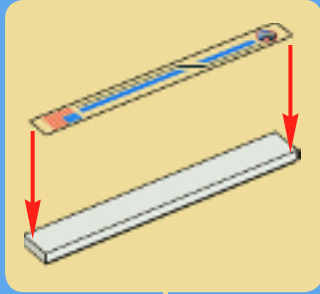



2x

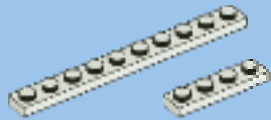

2x



2x

# 34

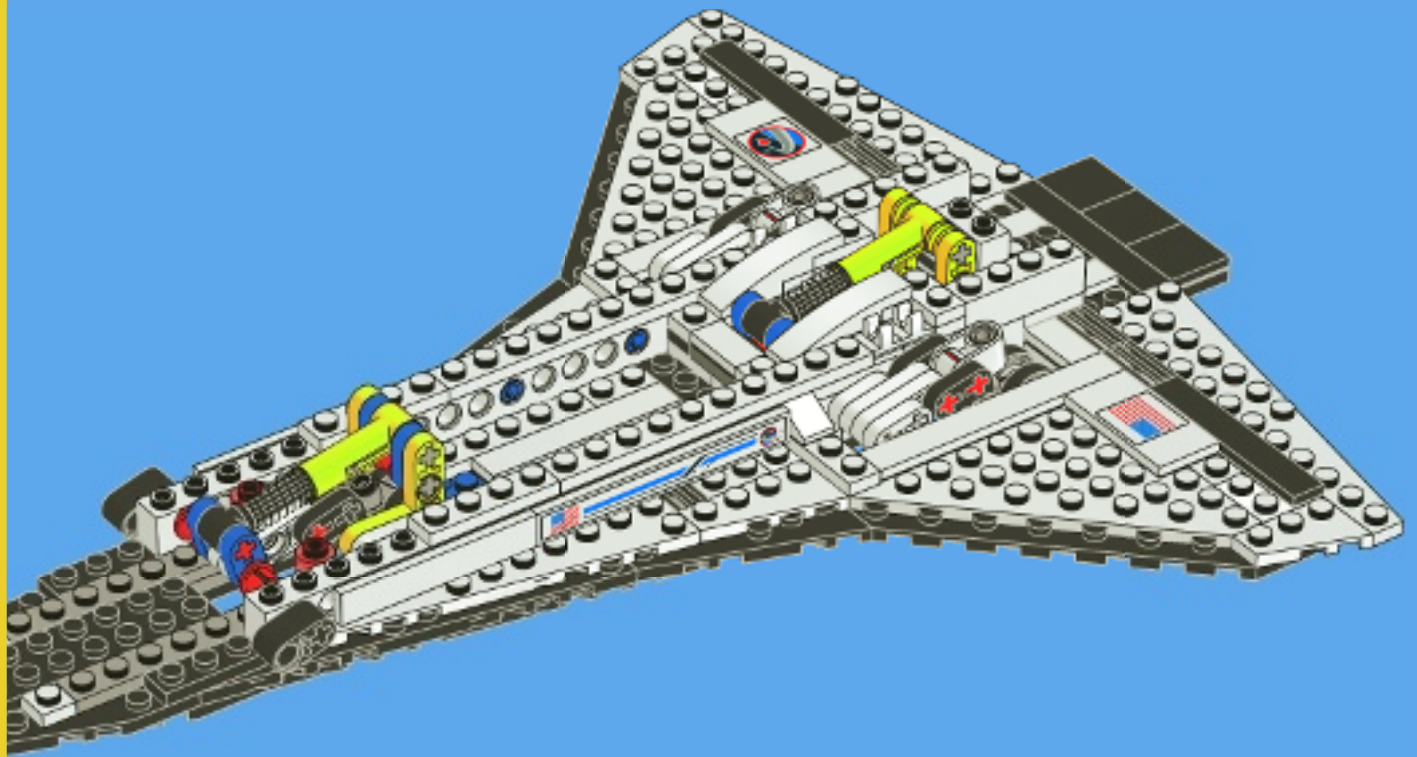



2x



2x



4x

# 35

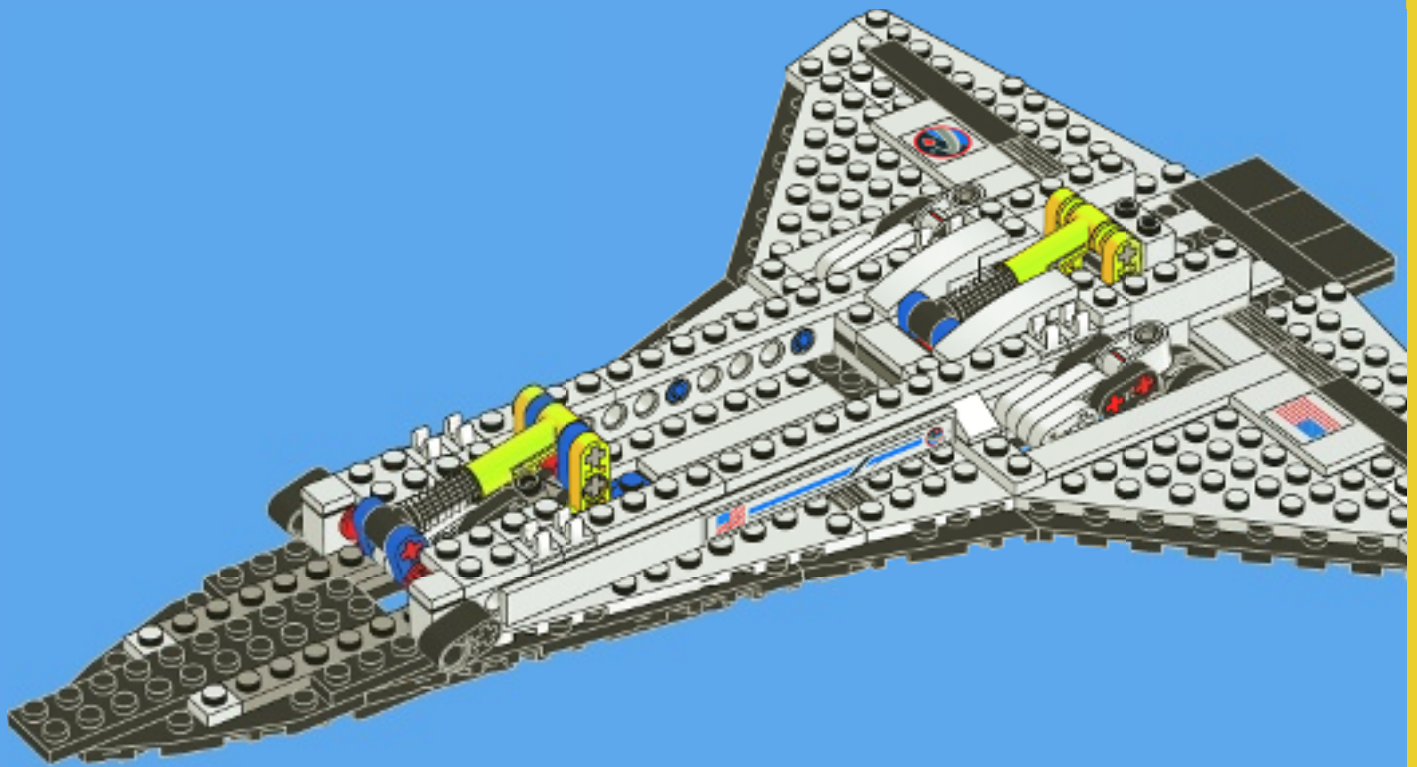

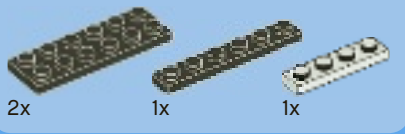

# 36

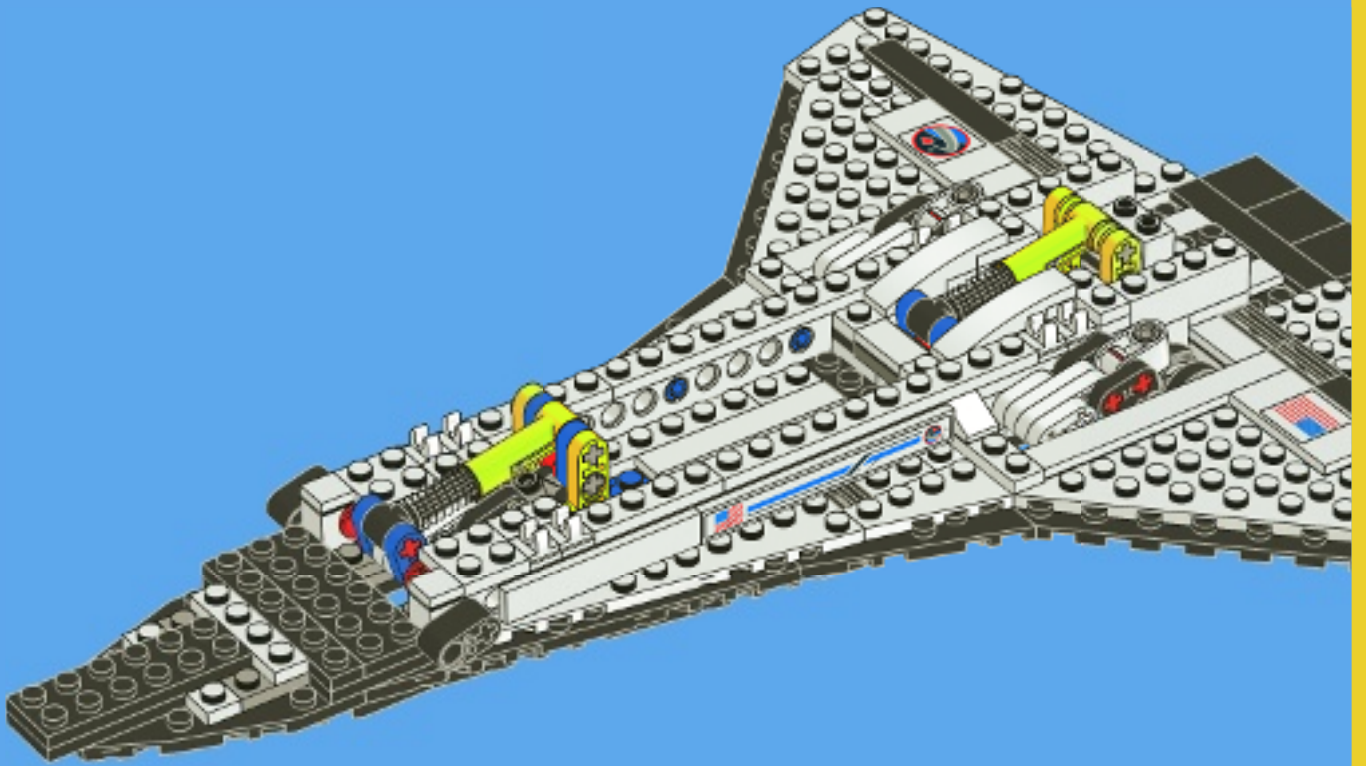





2x



1x



1x

# 37

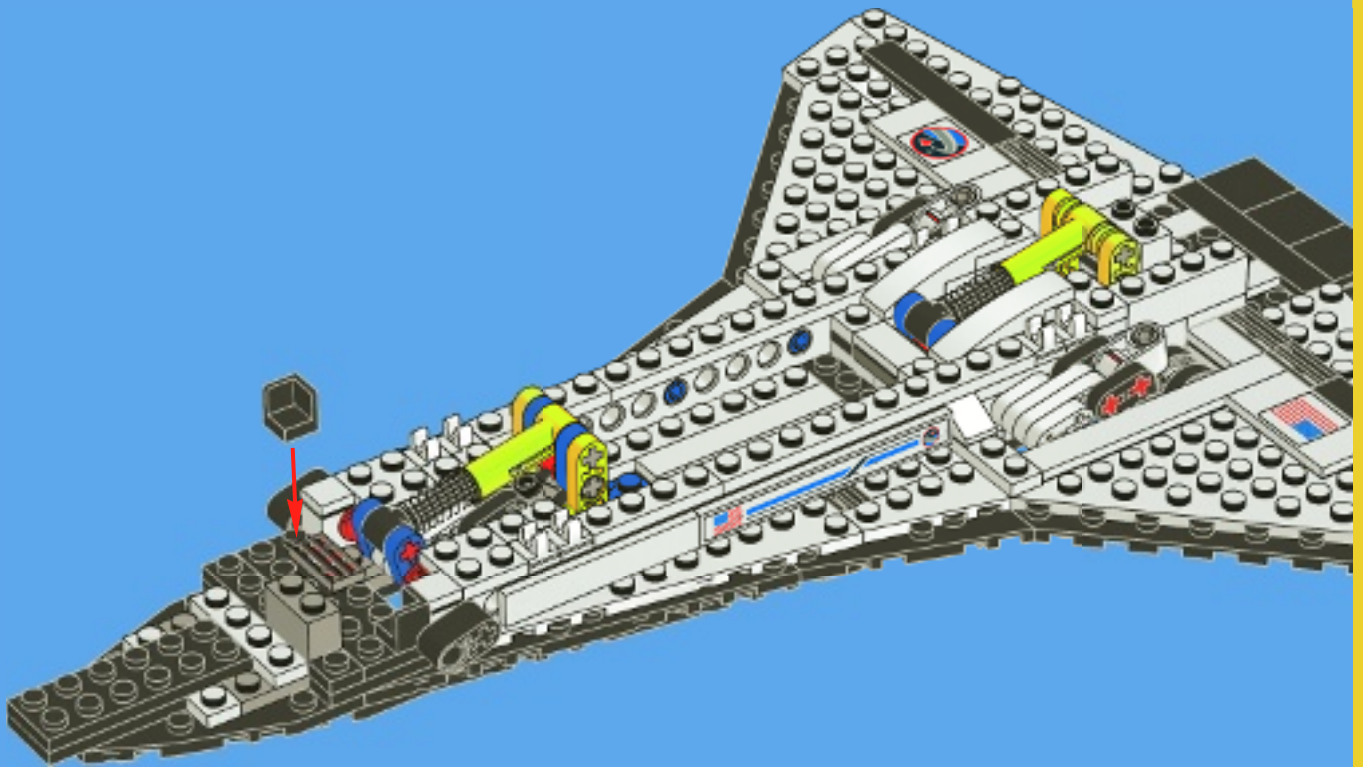



1x



1x



2x



2x

# 38

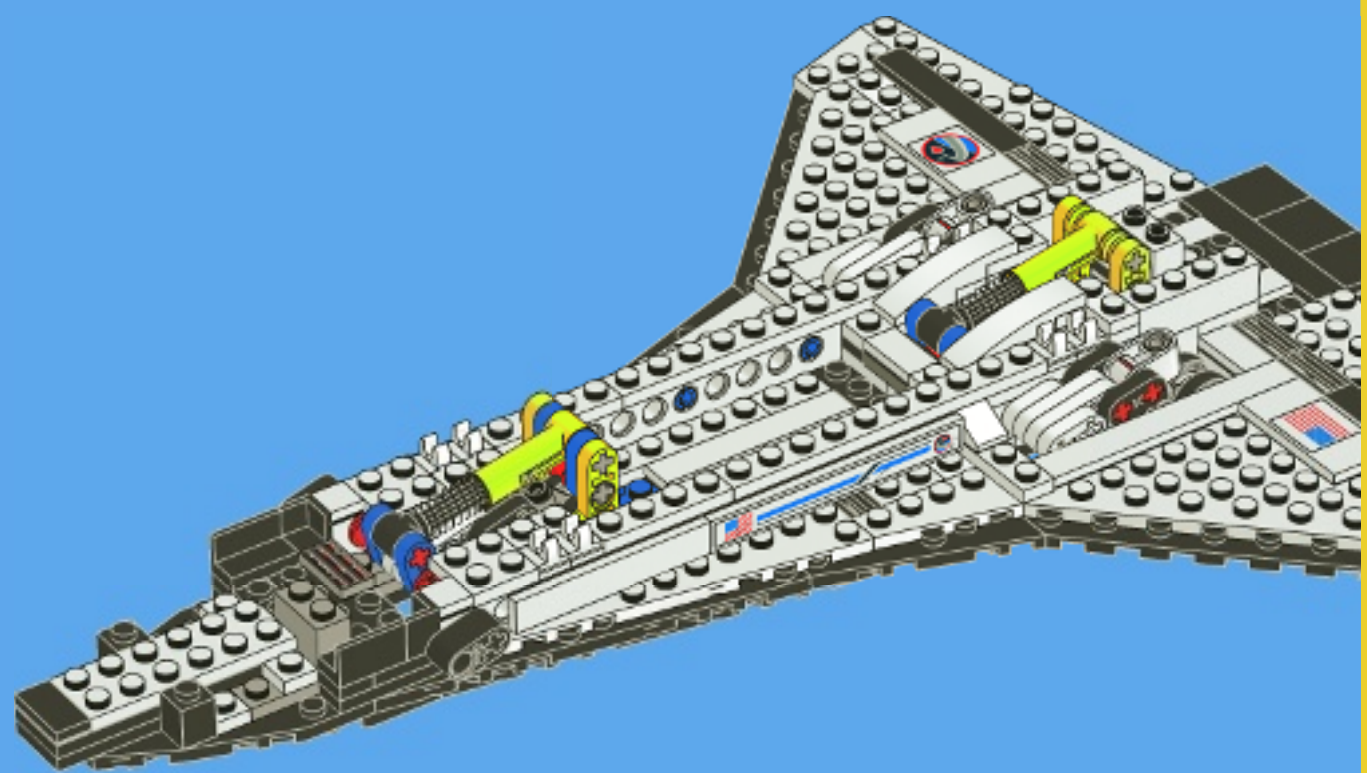

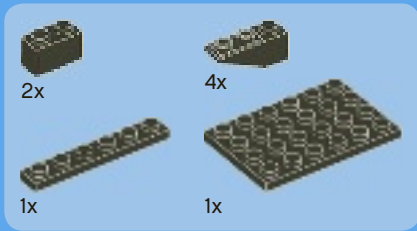

39

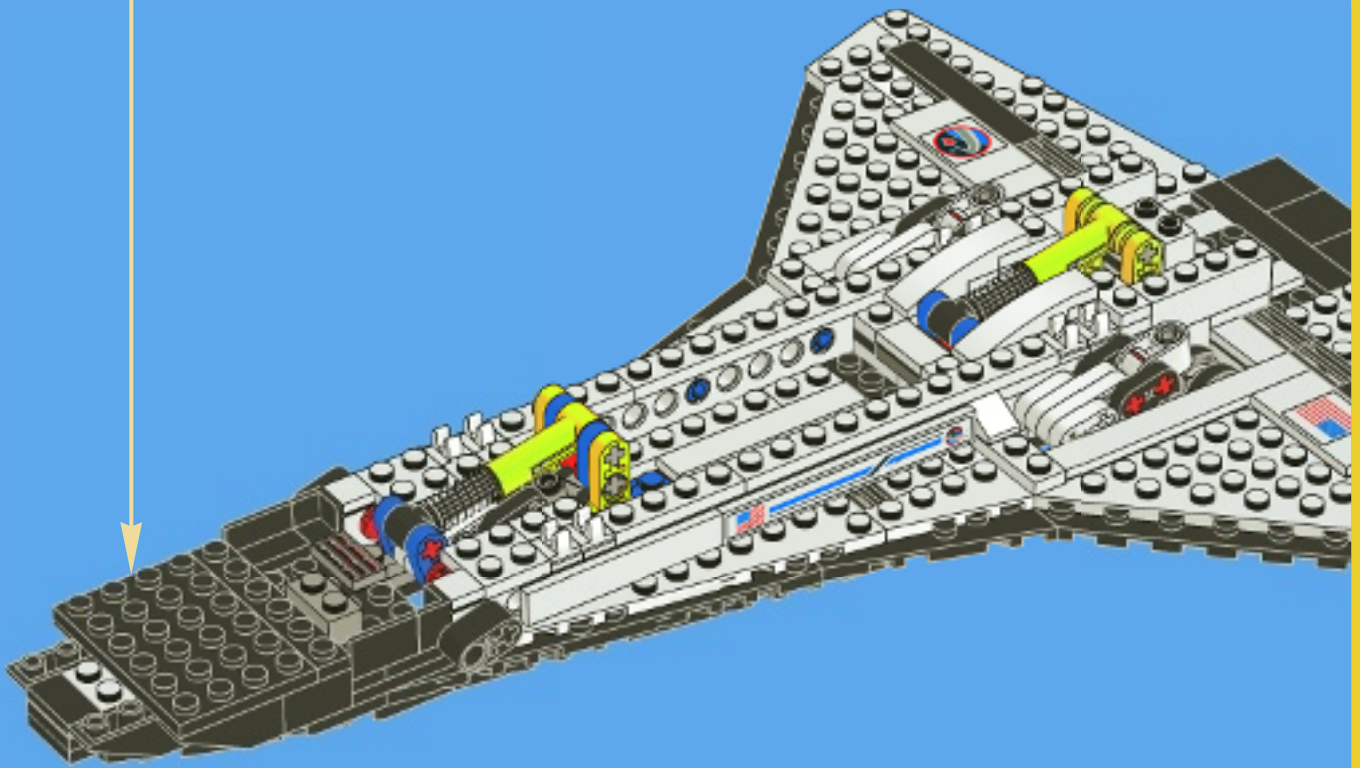
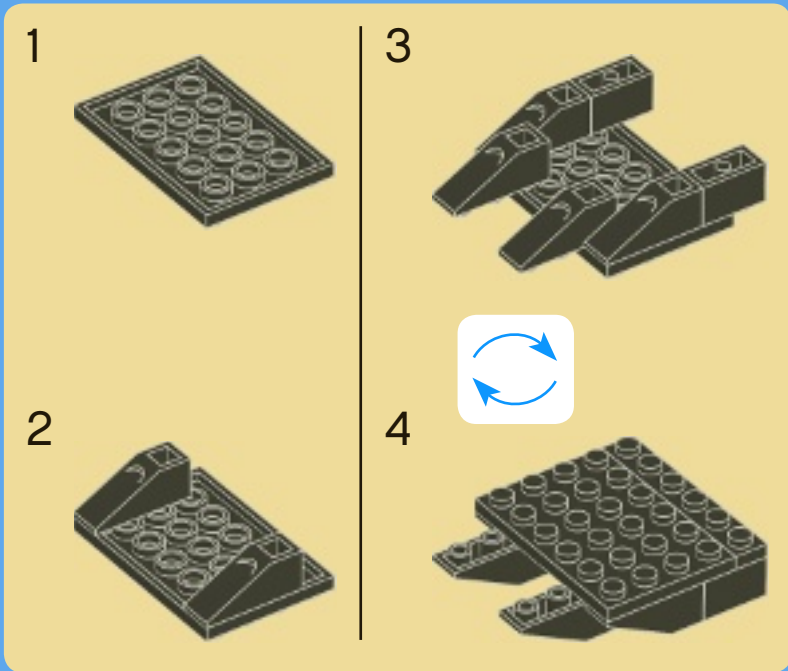

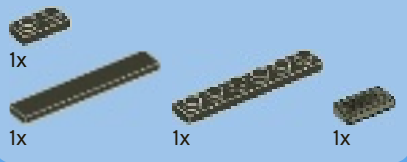

40

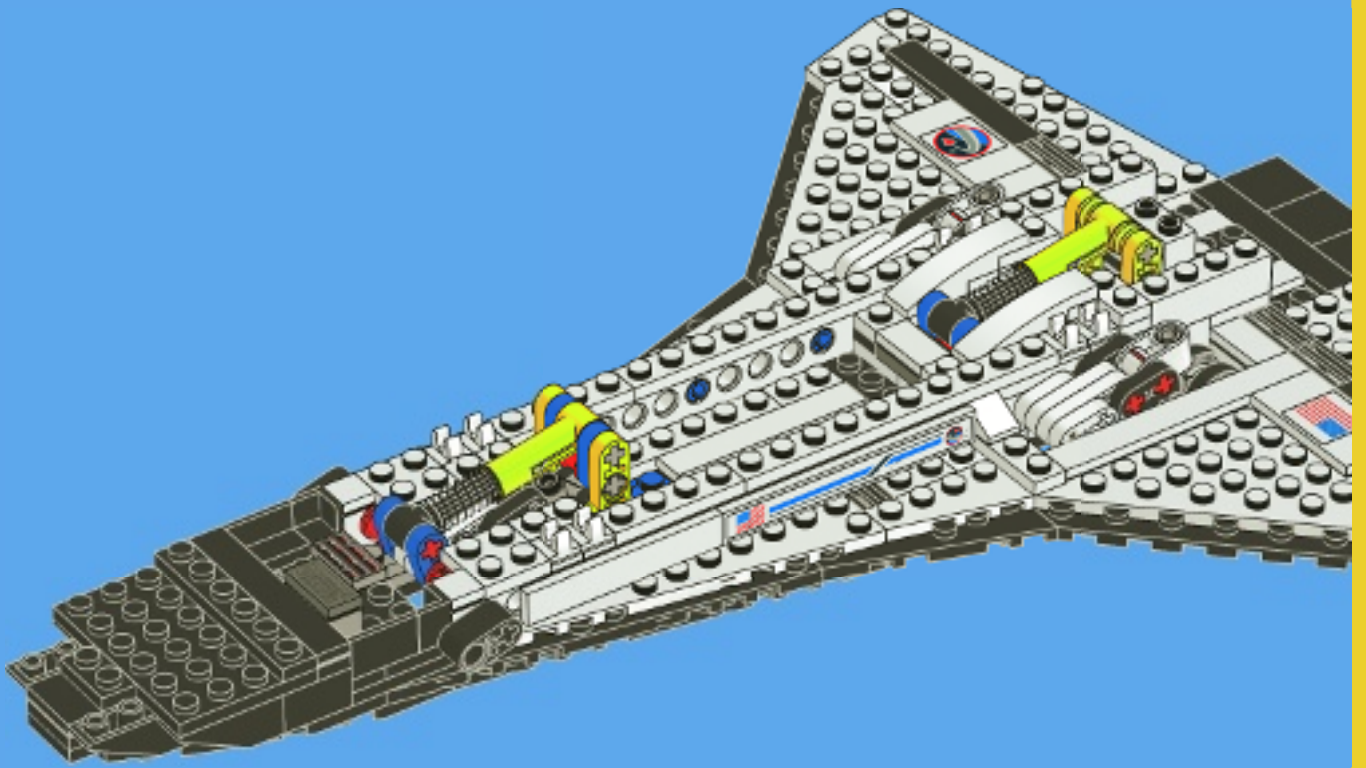

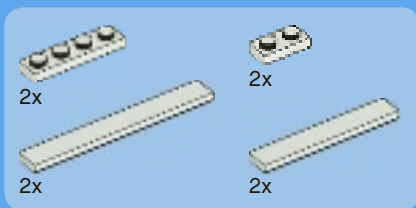

41

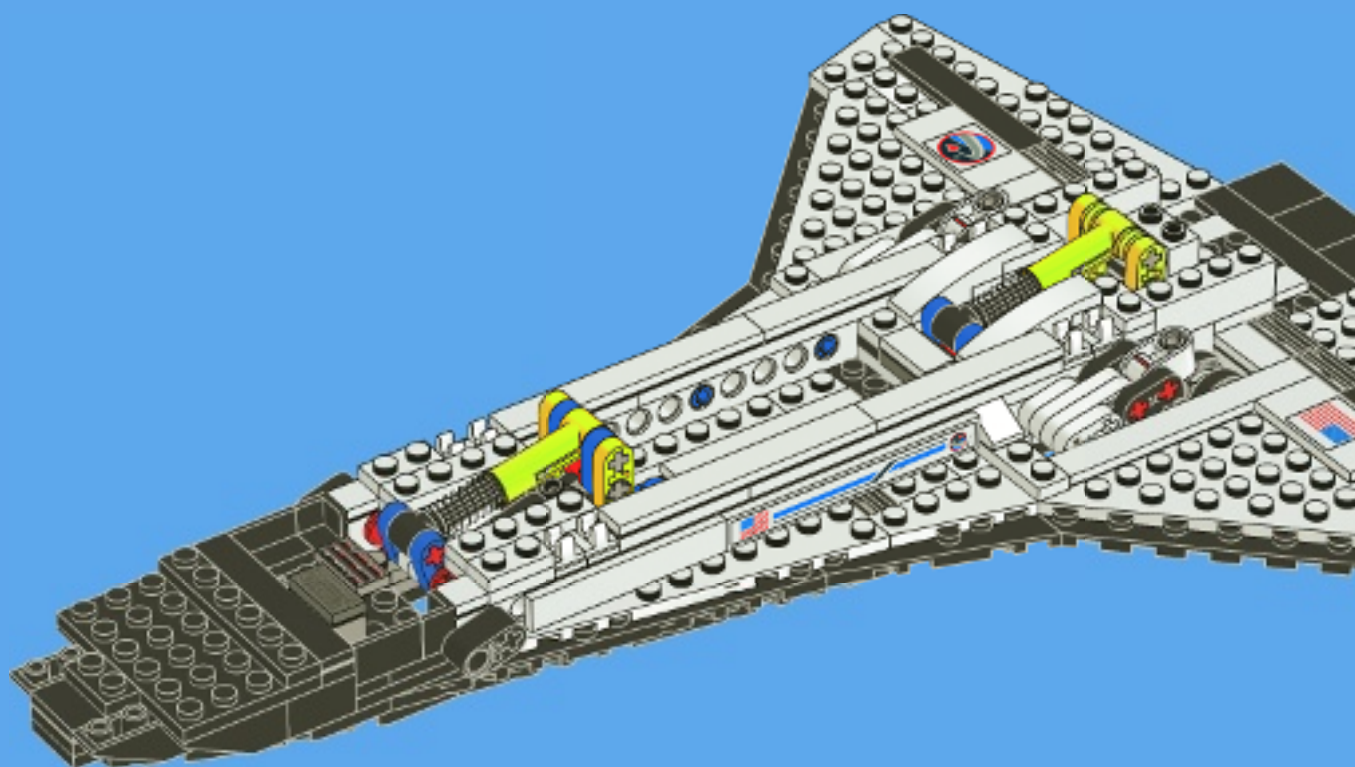



42

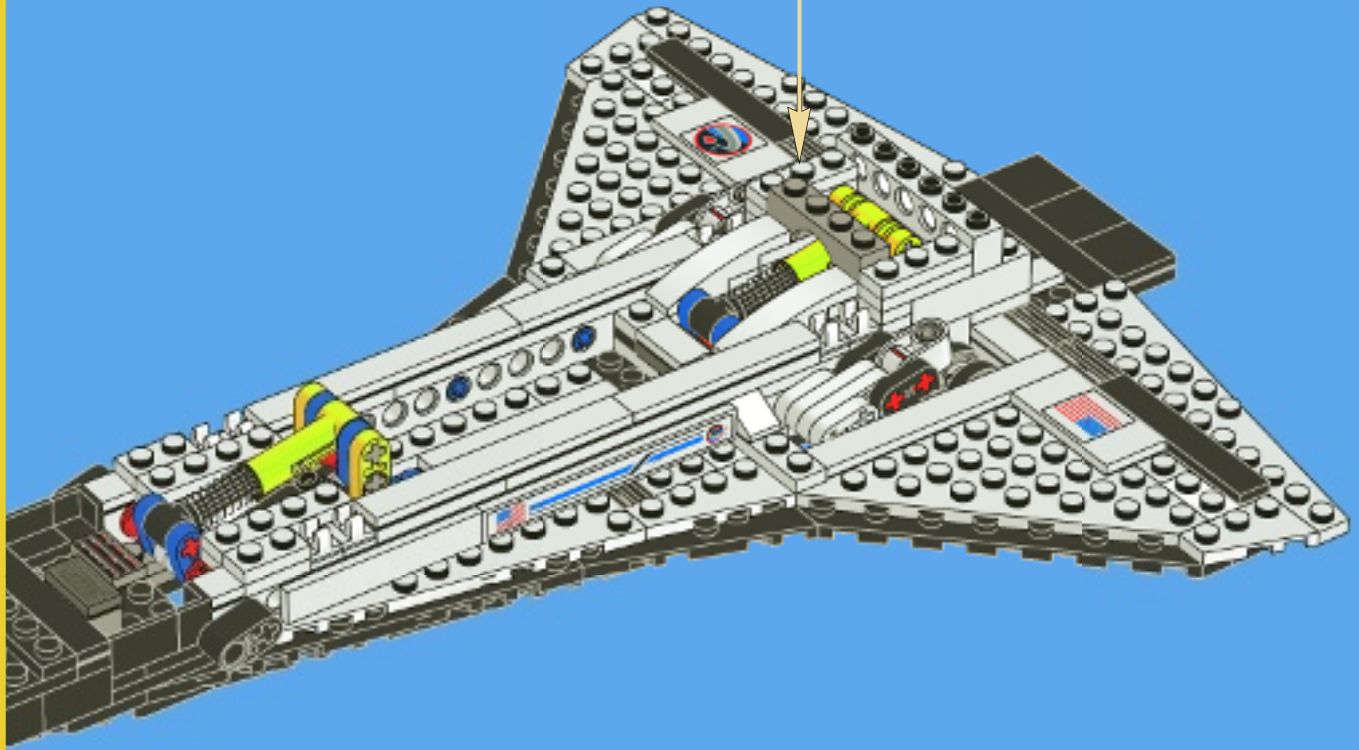
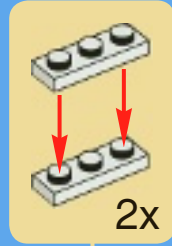

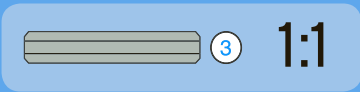
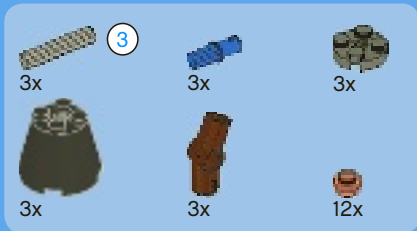

# 43

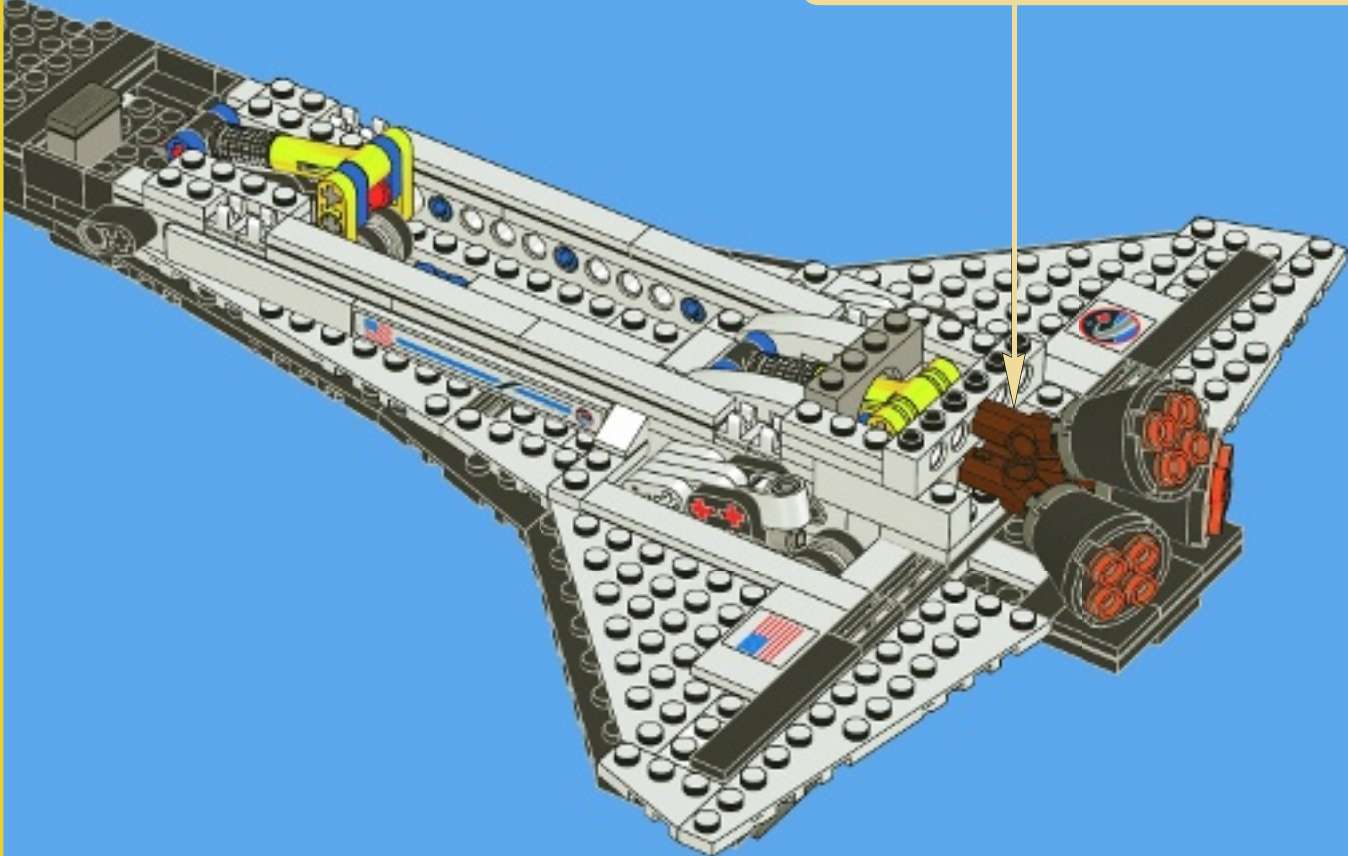
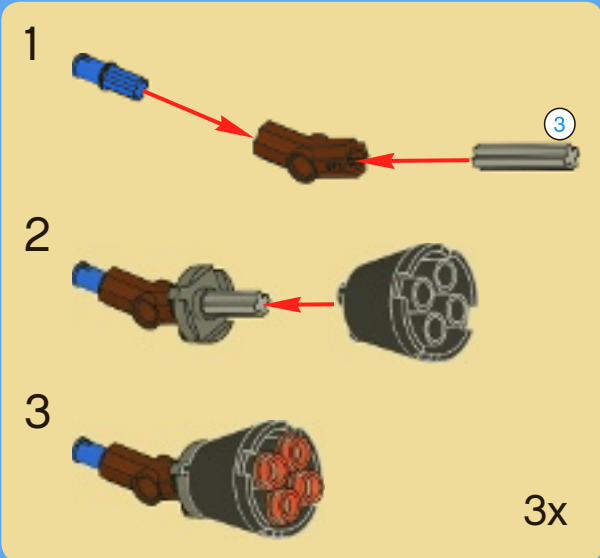

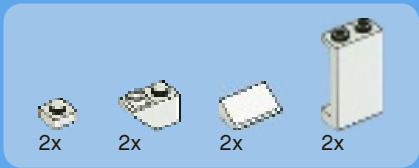

# 44

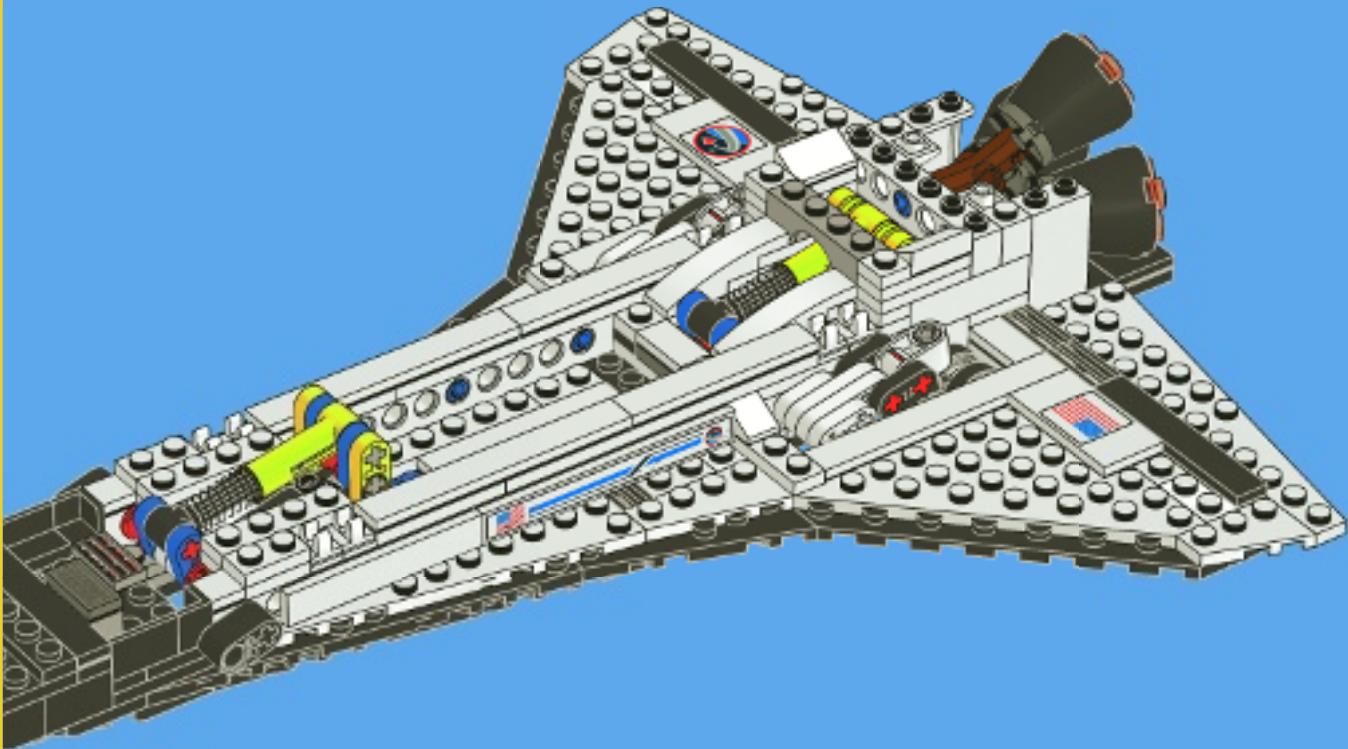





2x



2x



2x



2x

# 45

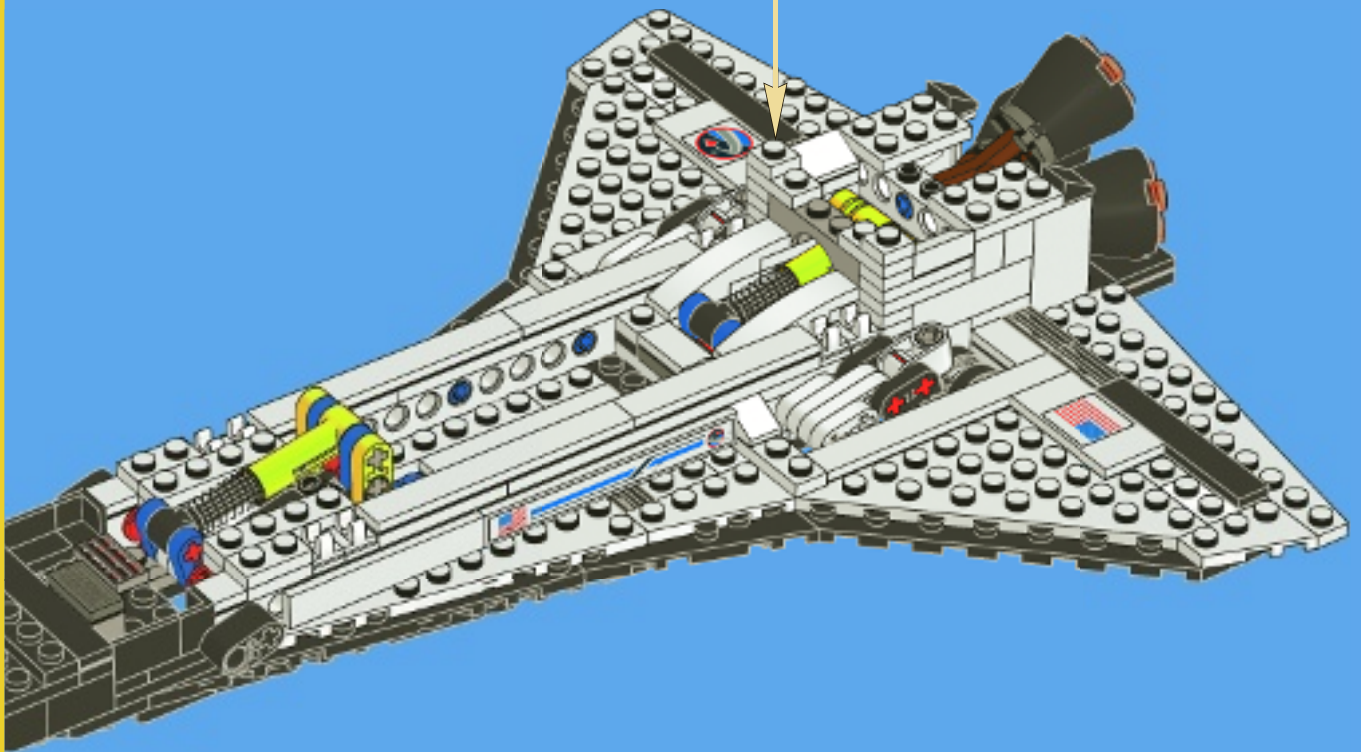
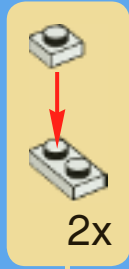

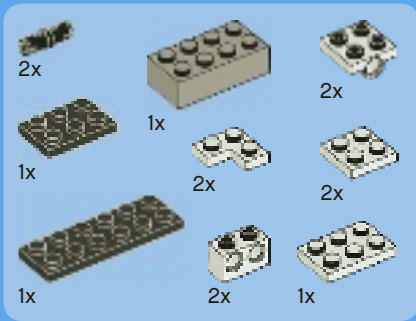

# 46

1

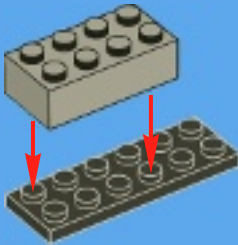

2

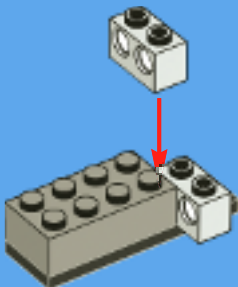

3

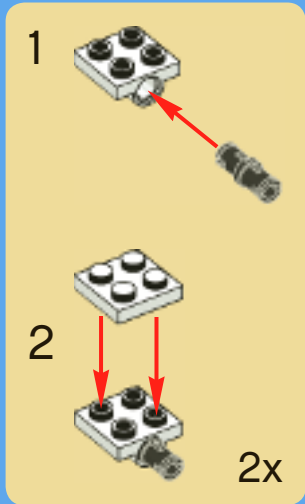

4

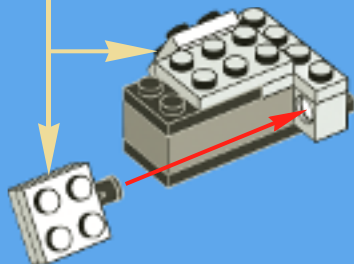

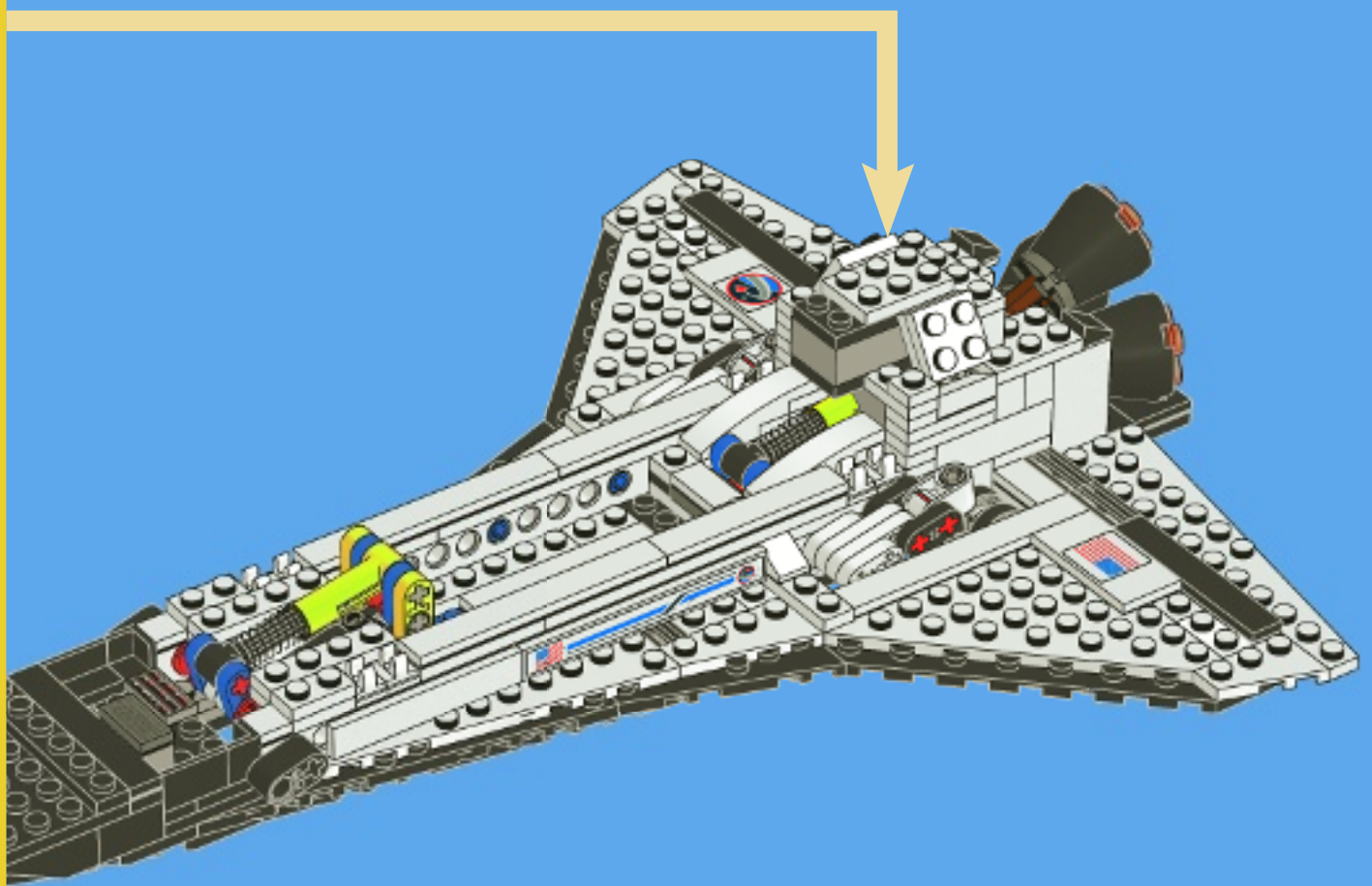



2x

1x



2x



2x

# 47

1



2



3

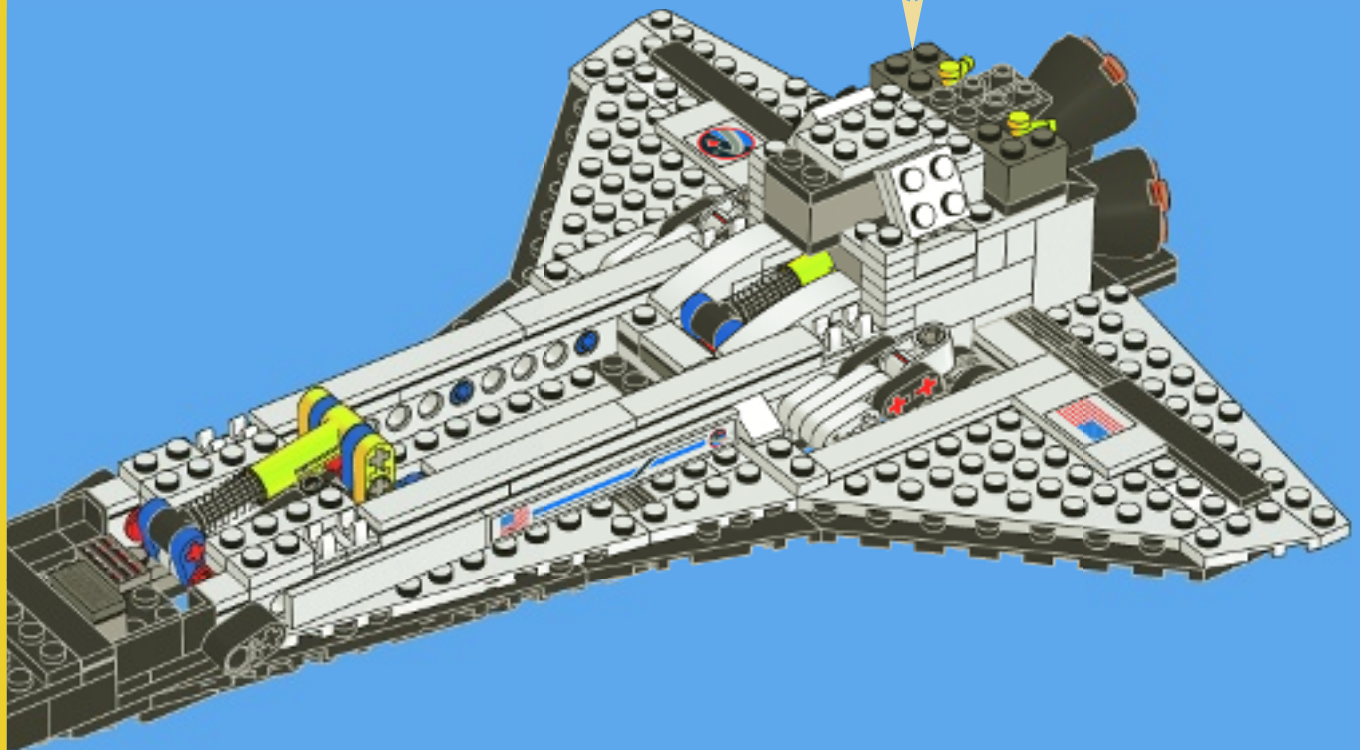



1x



2x



2x

# 48

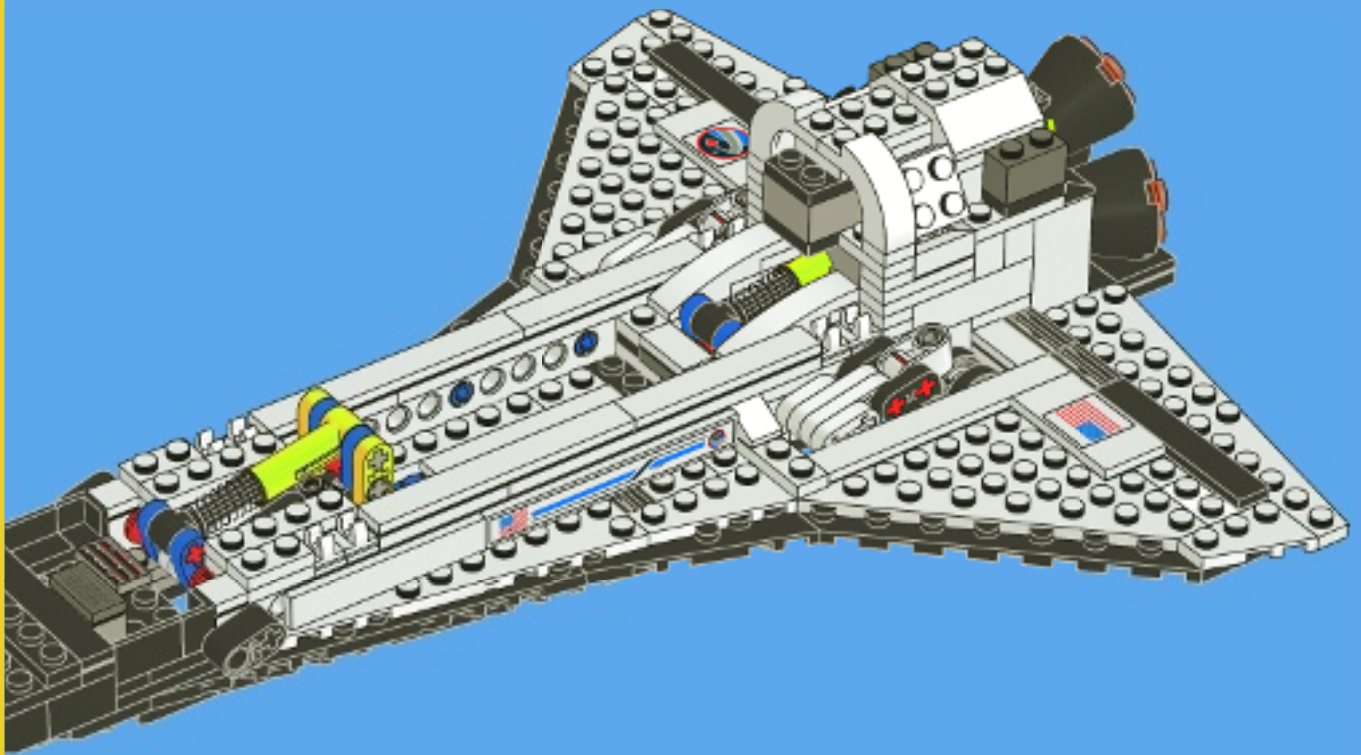



2x



1x



4x

# 49

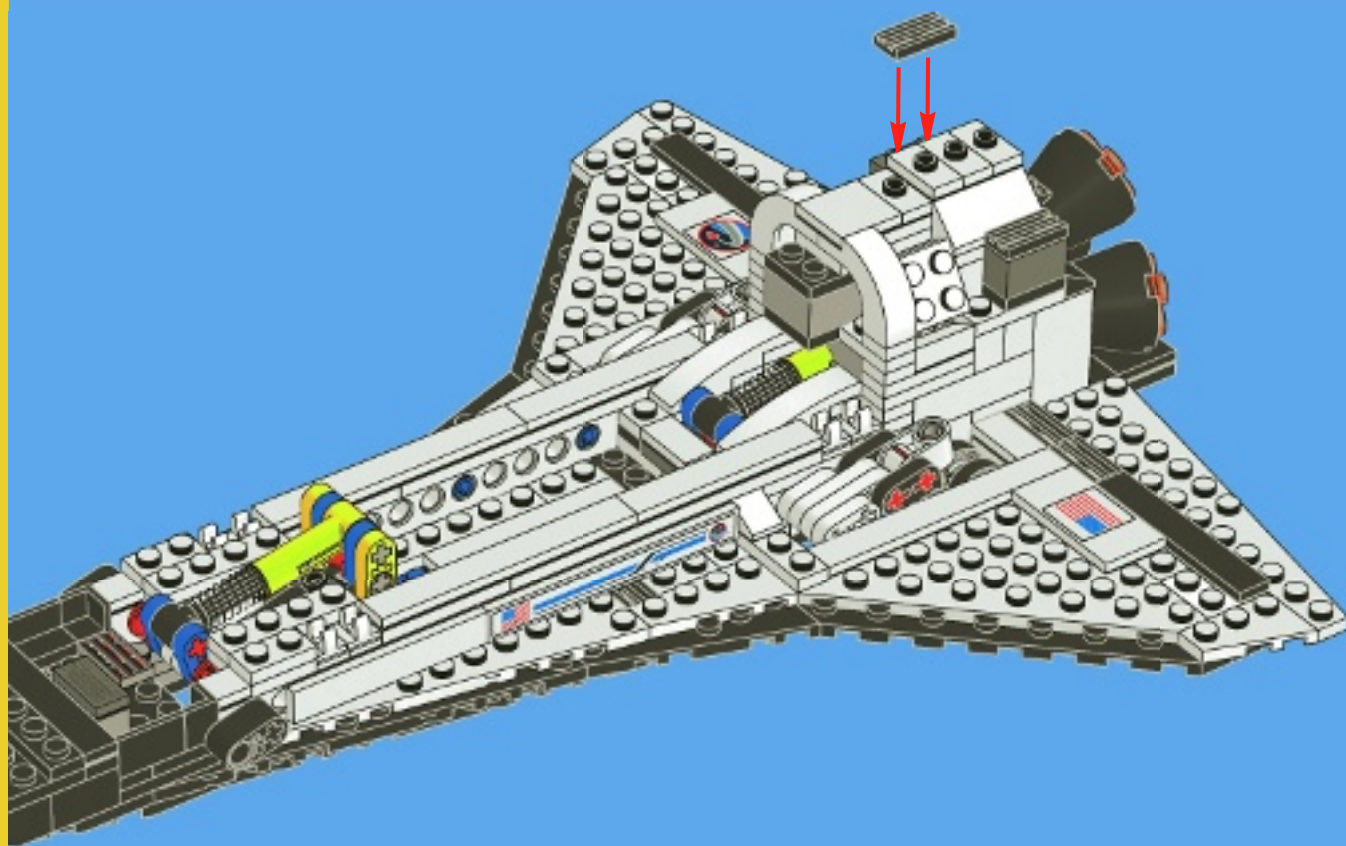



1x



2x

# 50

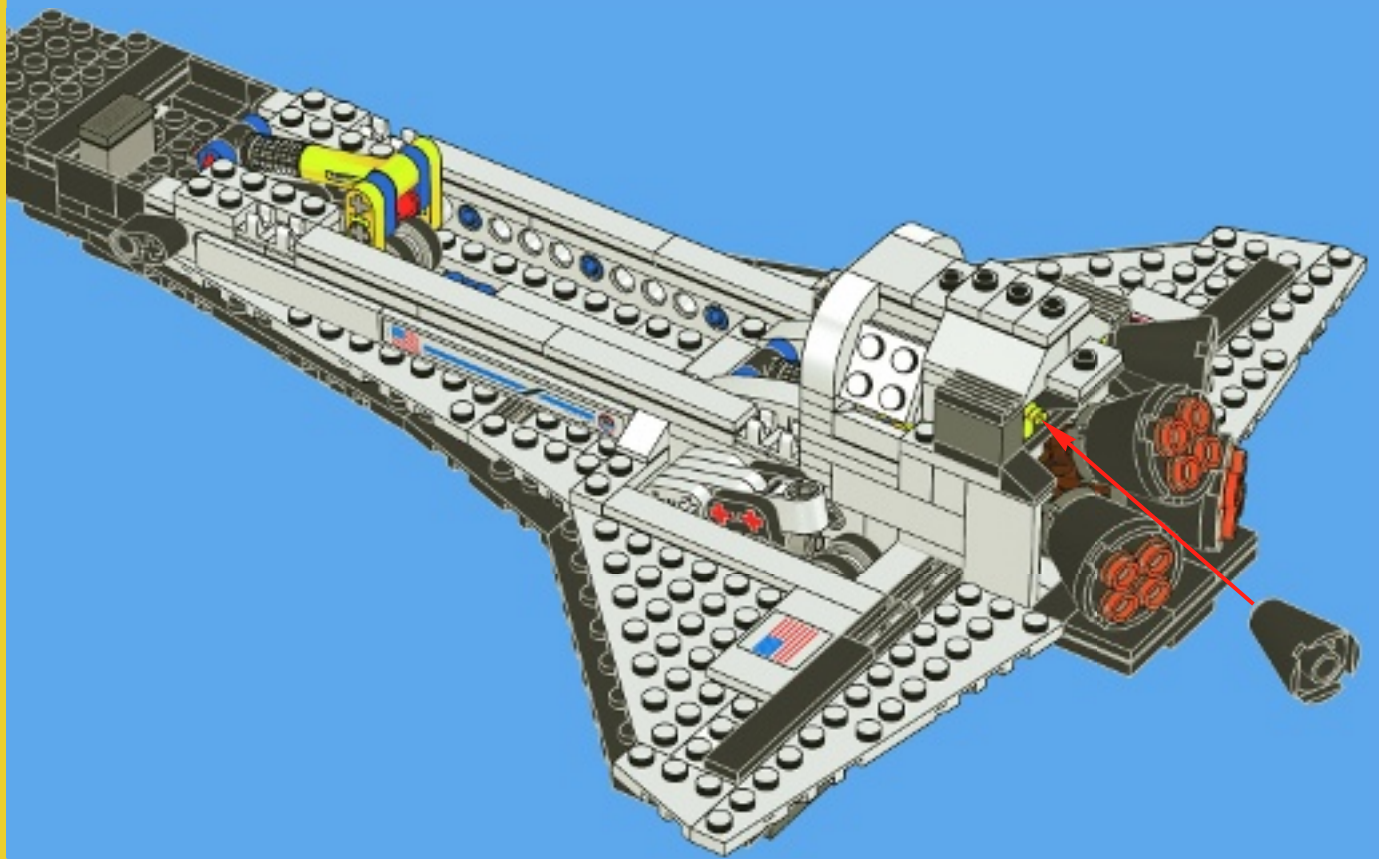

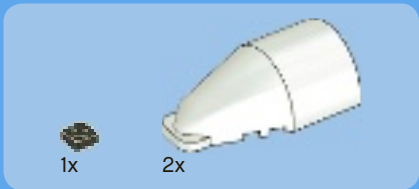

51

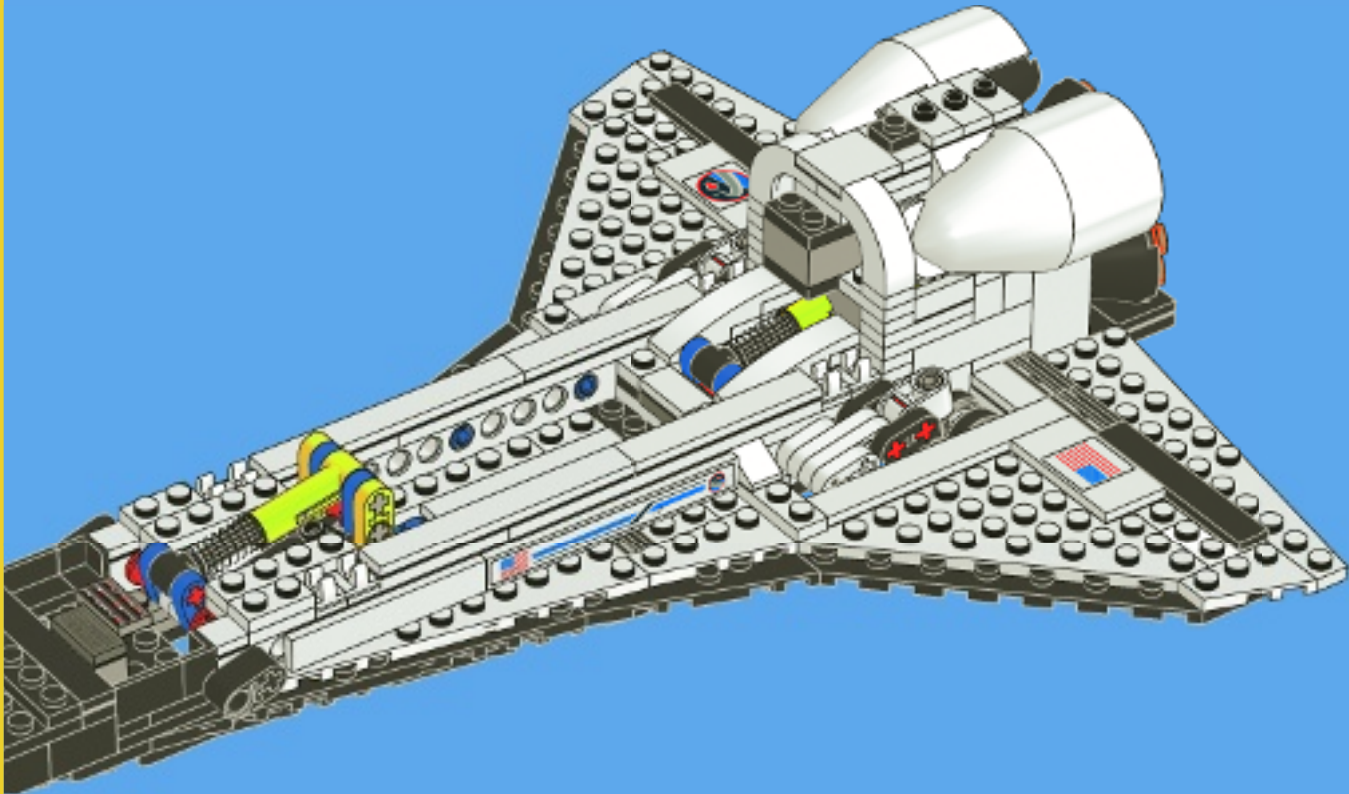



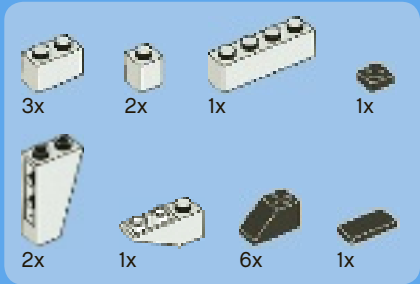

# 52

1



2

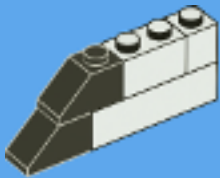

3



4



5

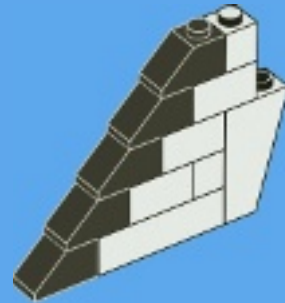

6

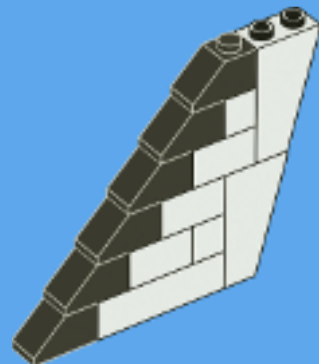

7

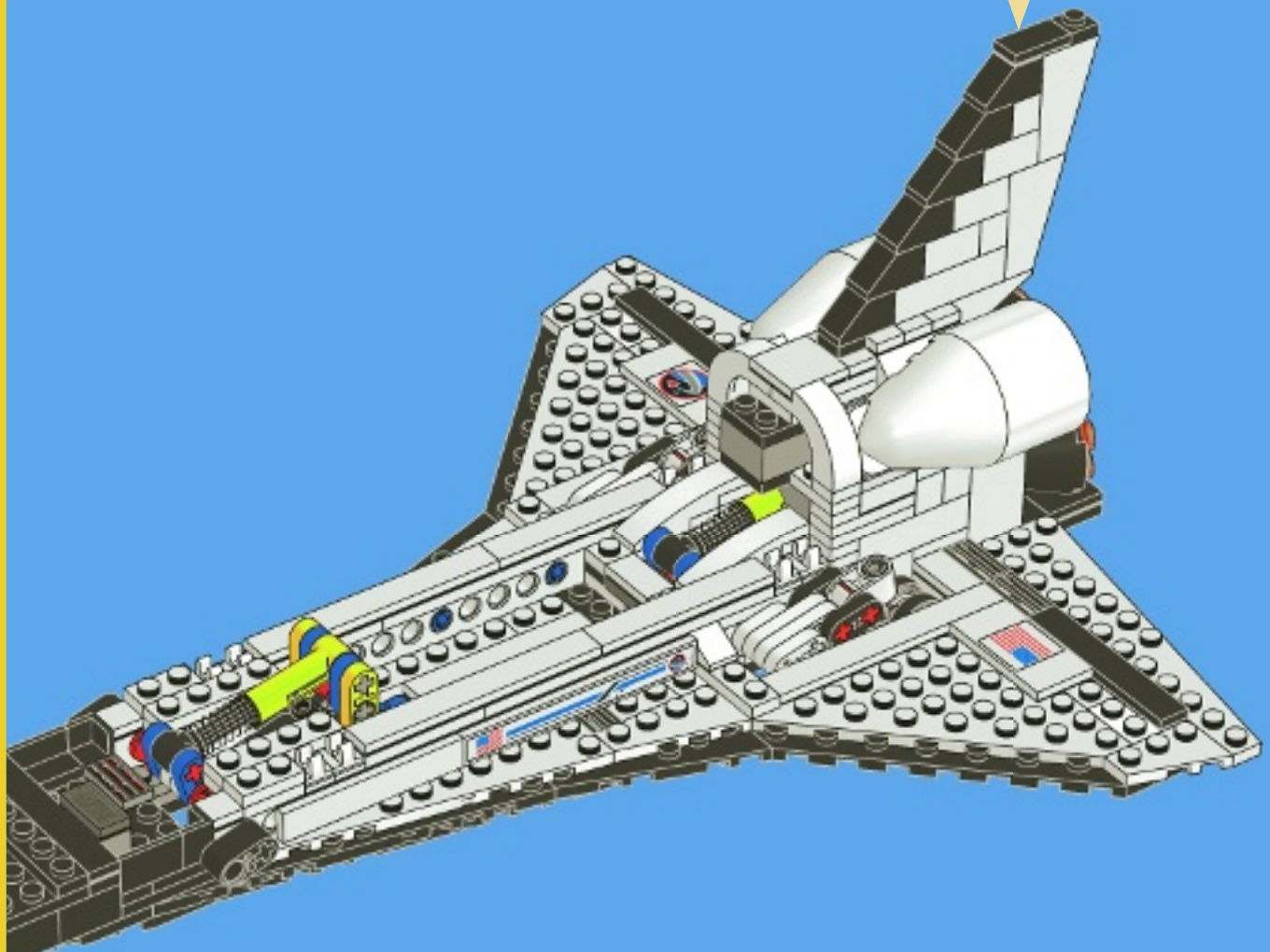
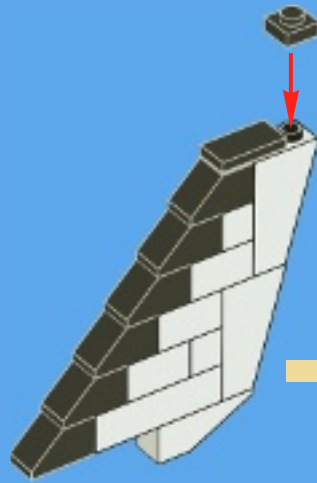

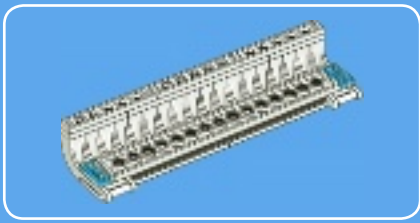

1

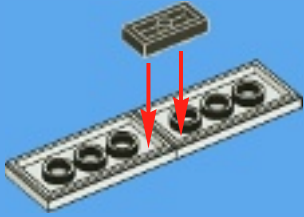

2

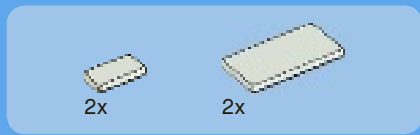

3

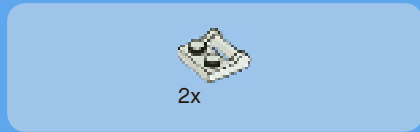
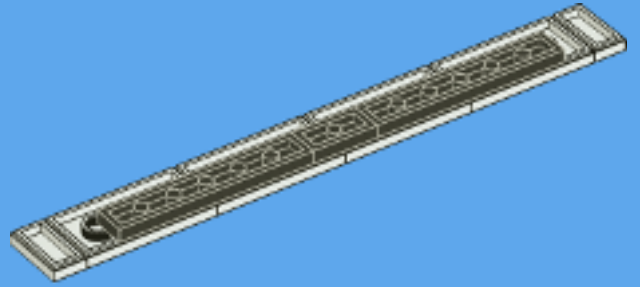

4

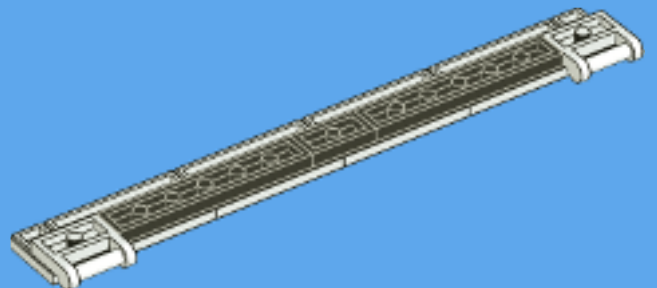



18x

5

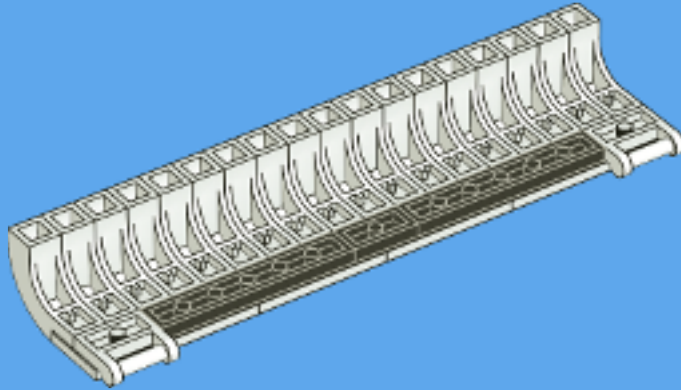

2x

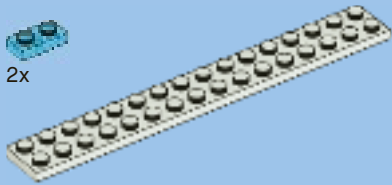

1x

6

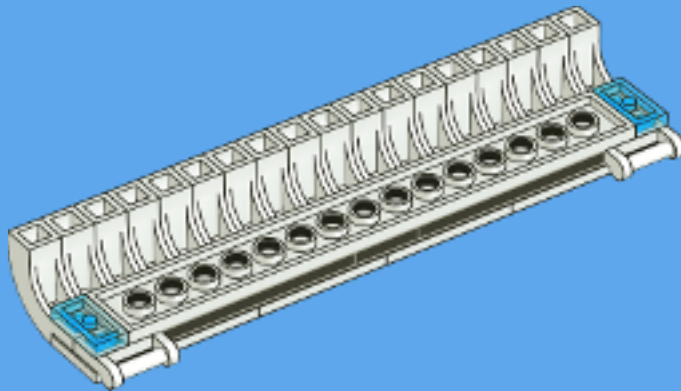

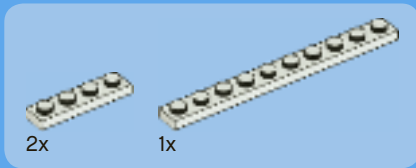

7

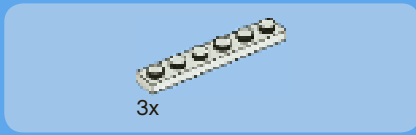
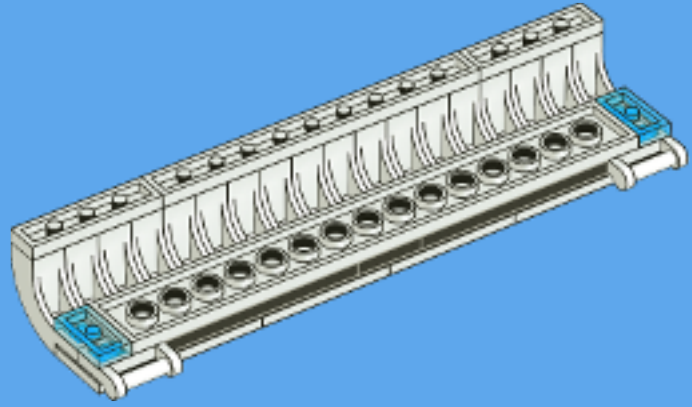

8

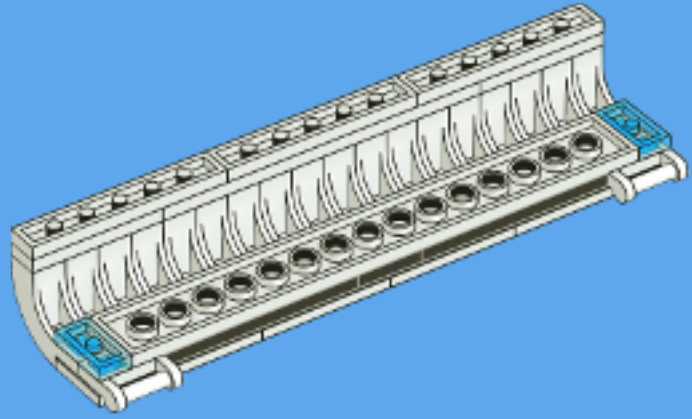

53

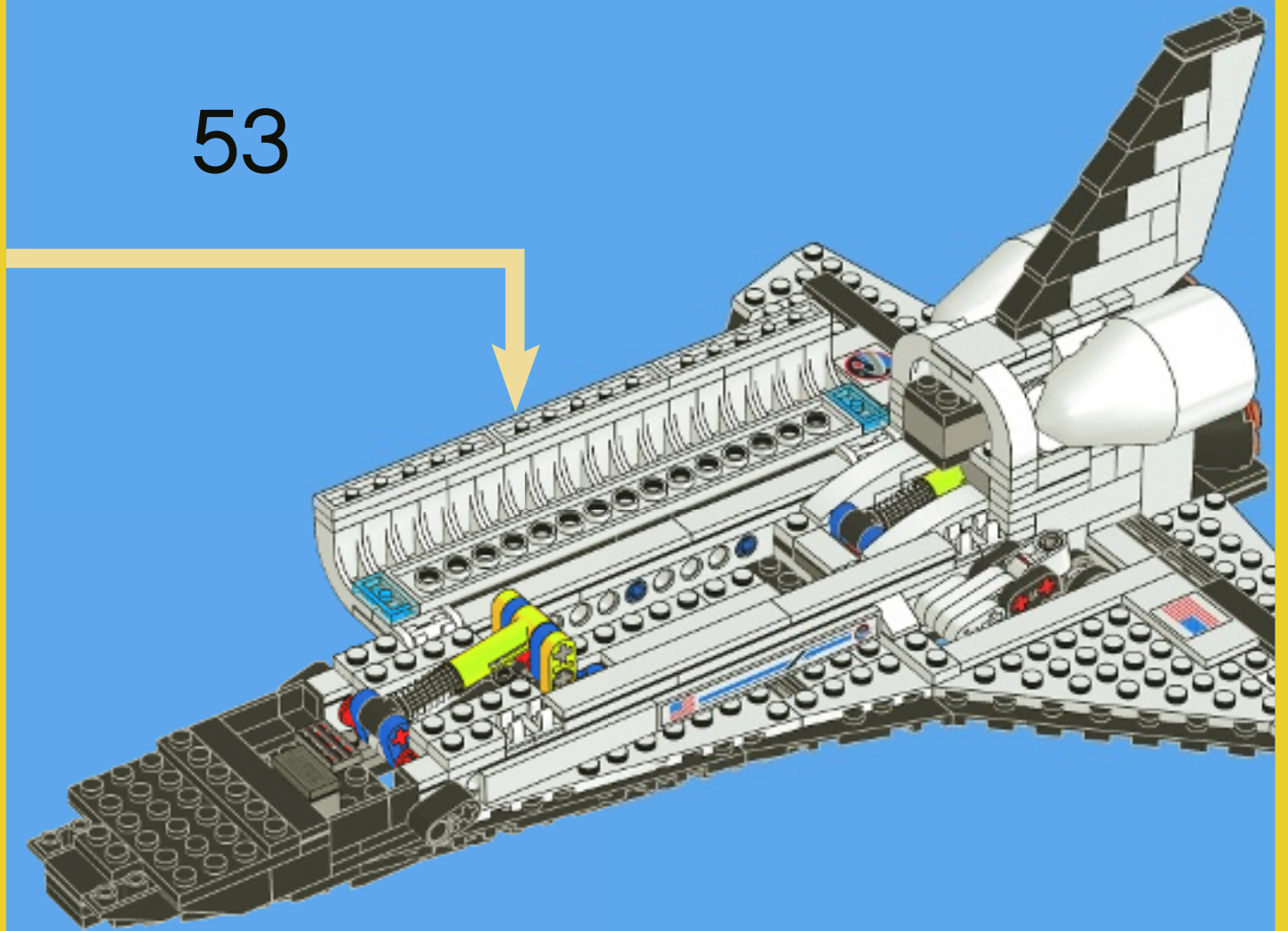

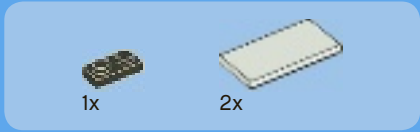

1

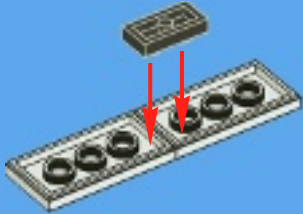

2

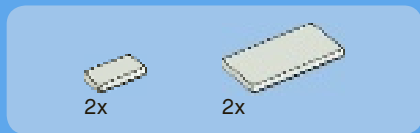

3

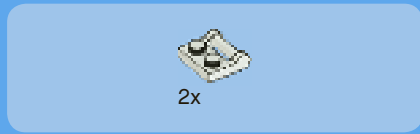
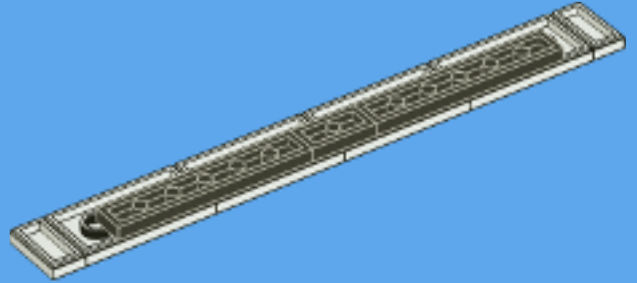

4

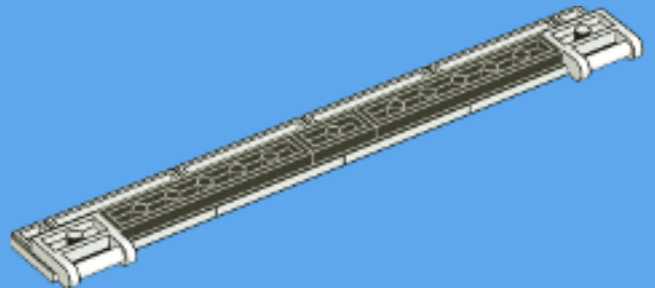



18x

5

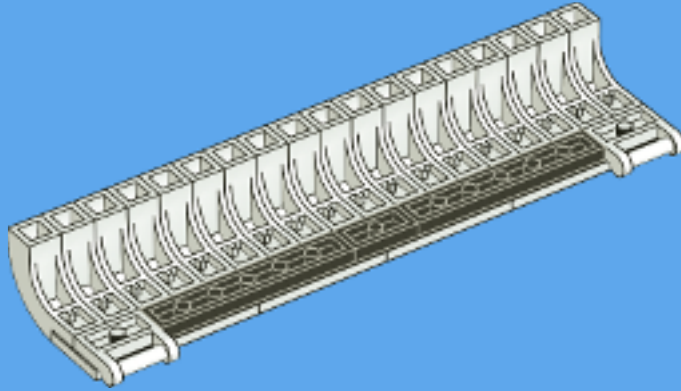

2x

1x

6

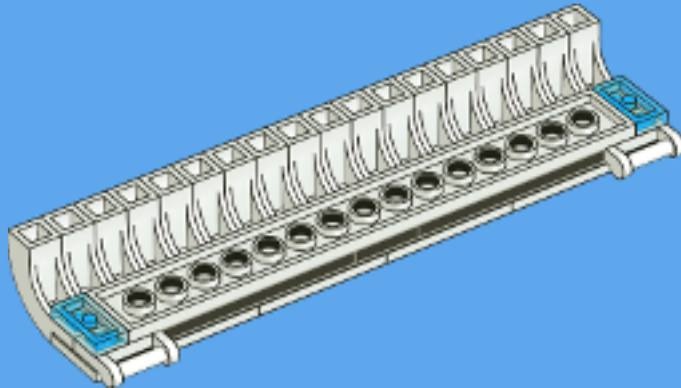



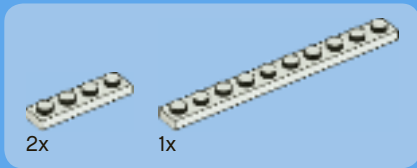

7

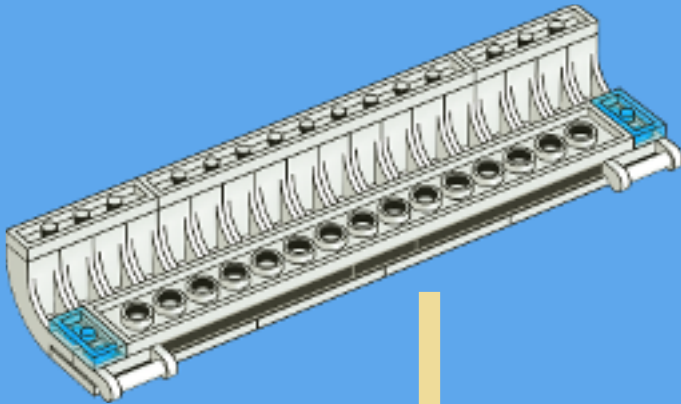

54

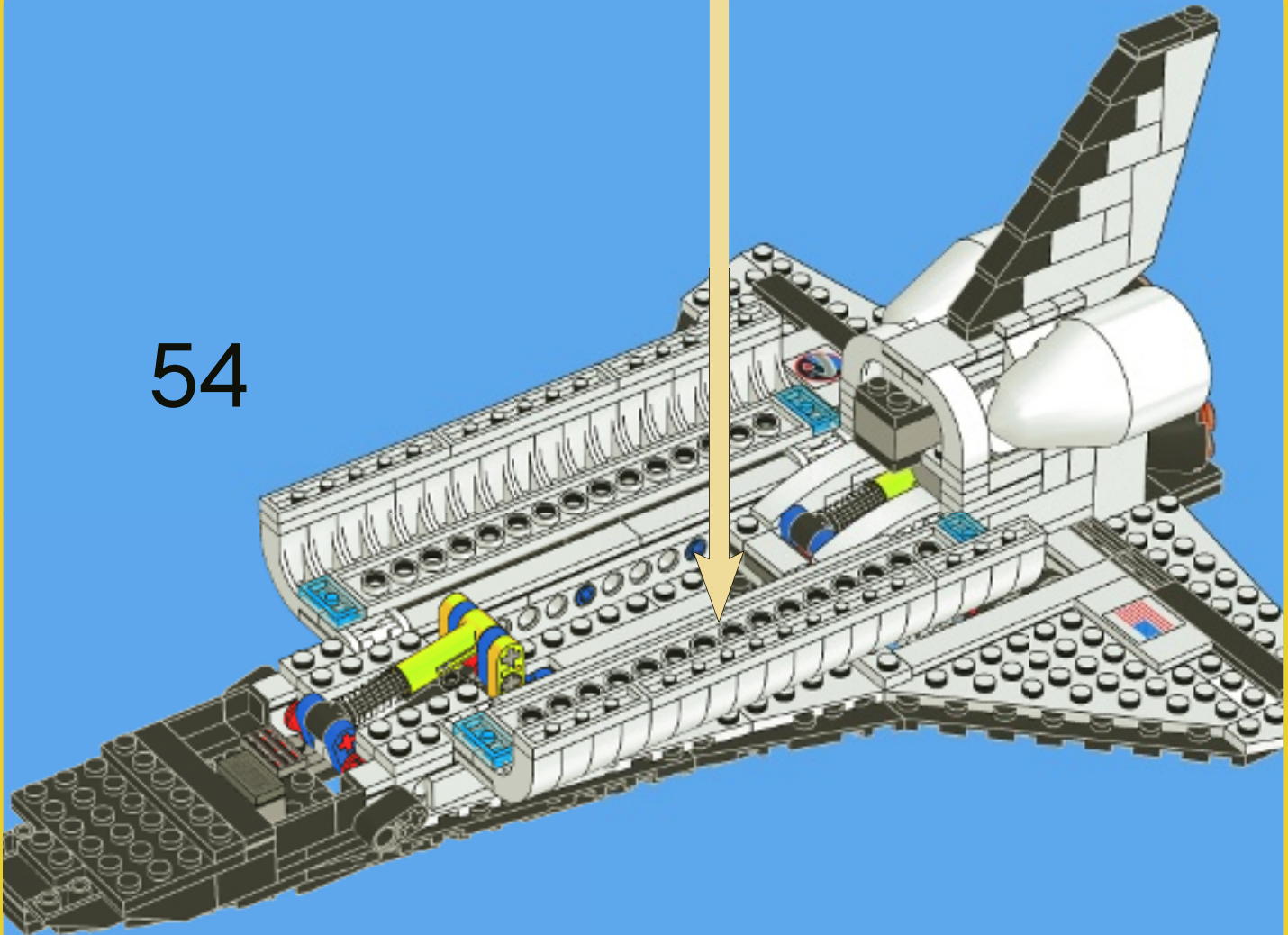



2x



2x

# 55

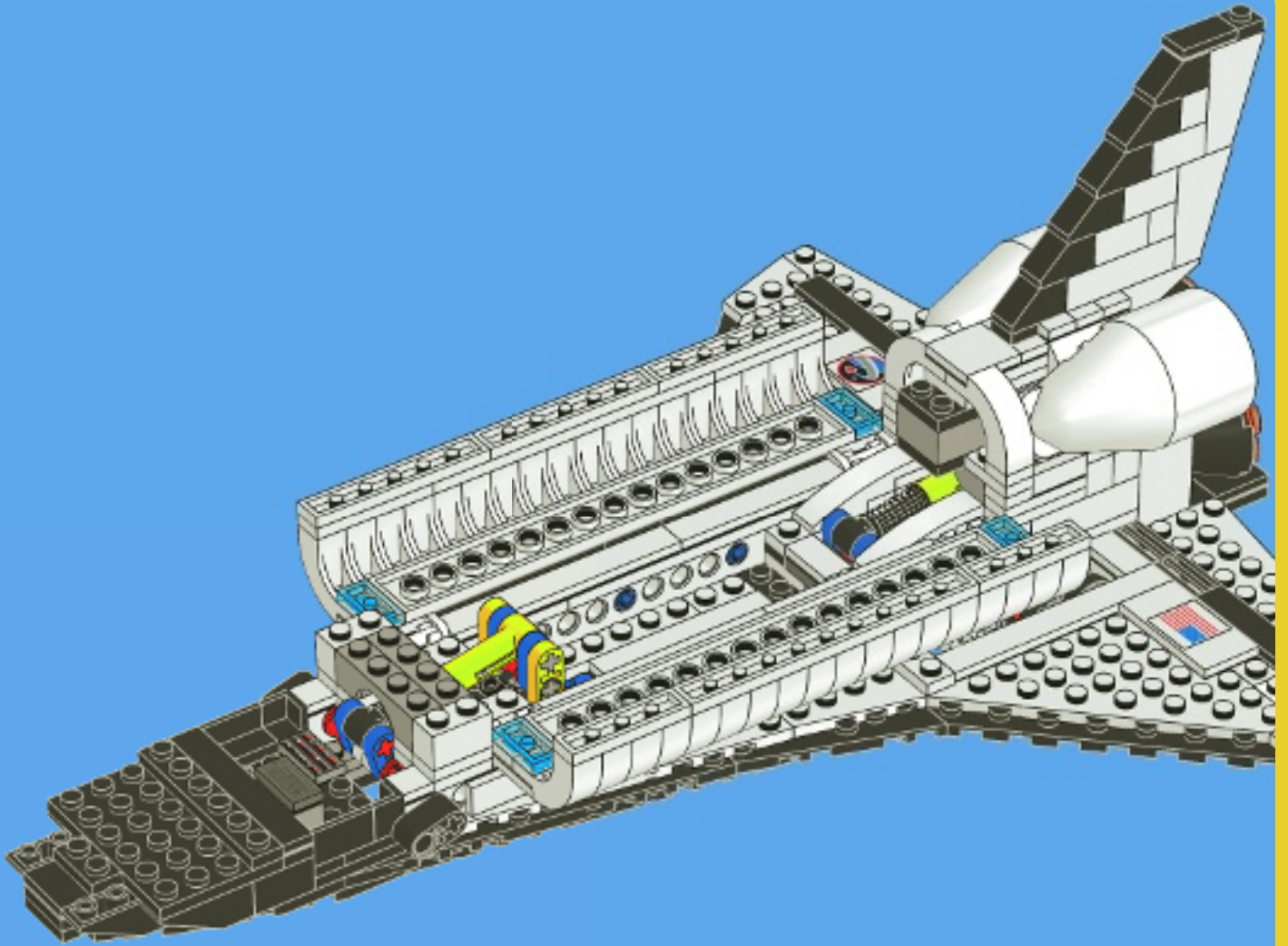



1x



1x



2x

# 56

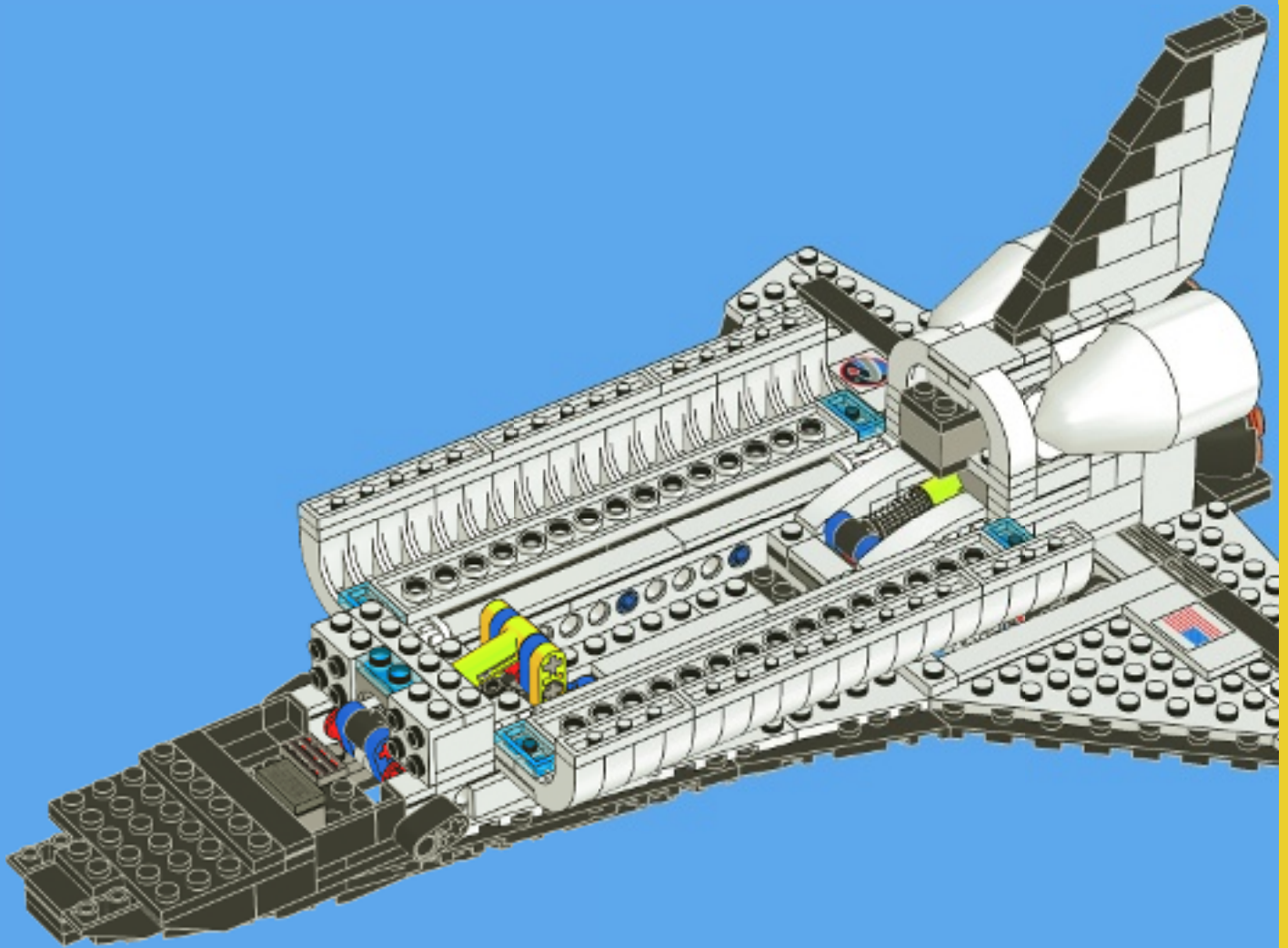

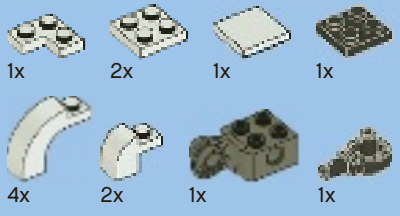

# 57

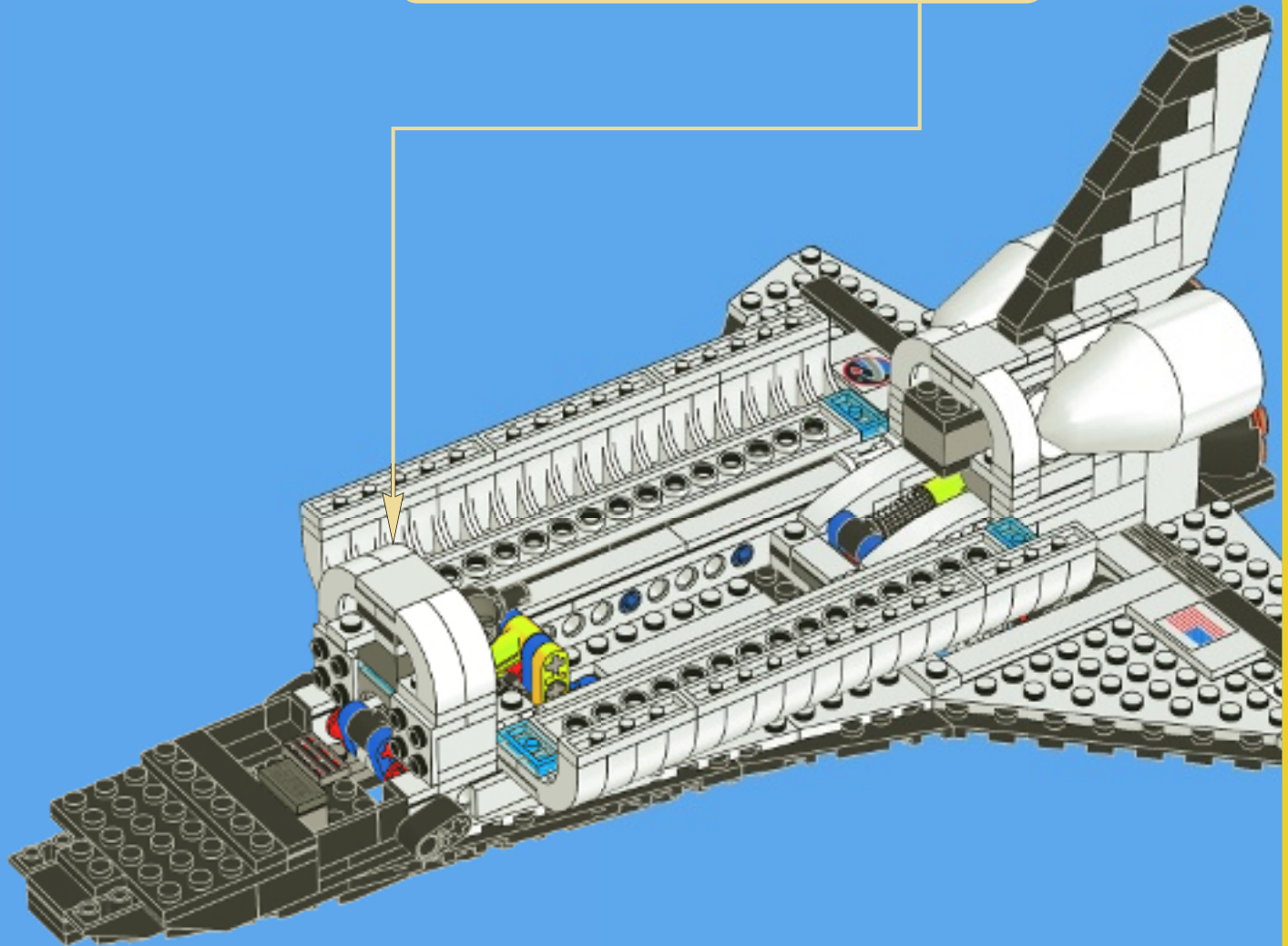
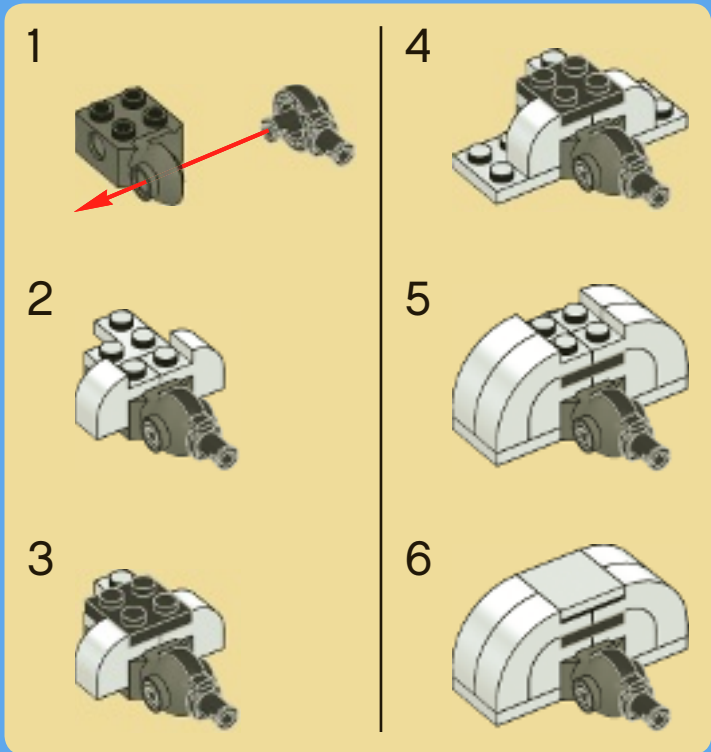

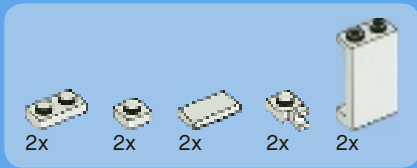

# 58

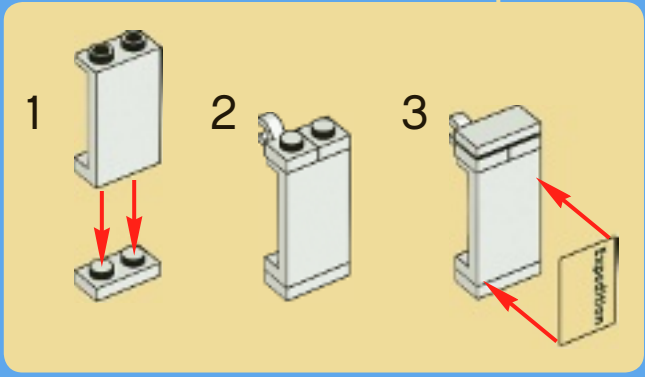
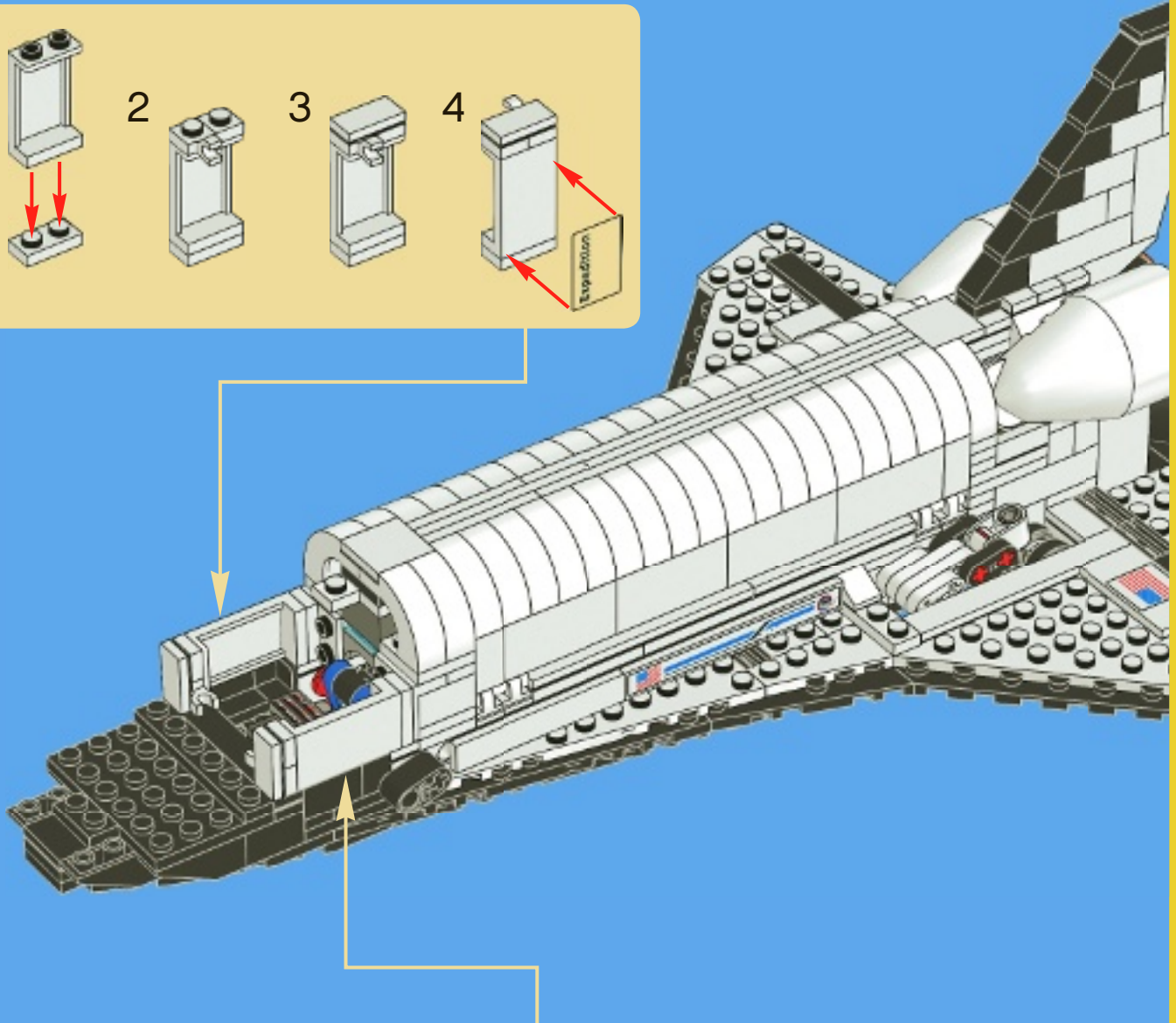
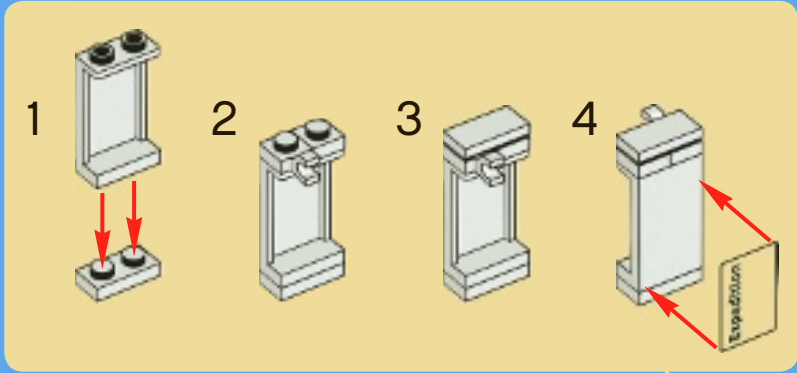



# 59

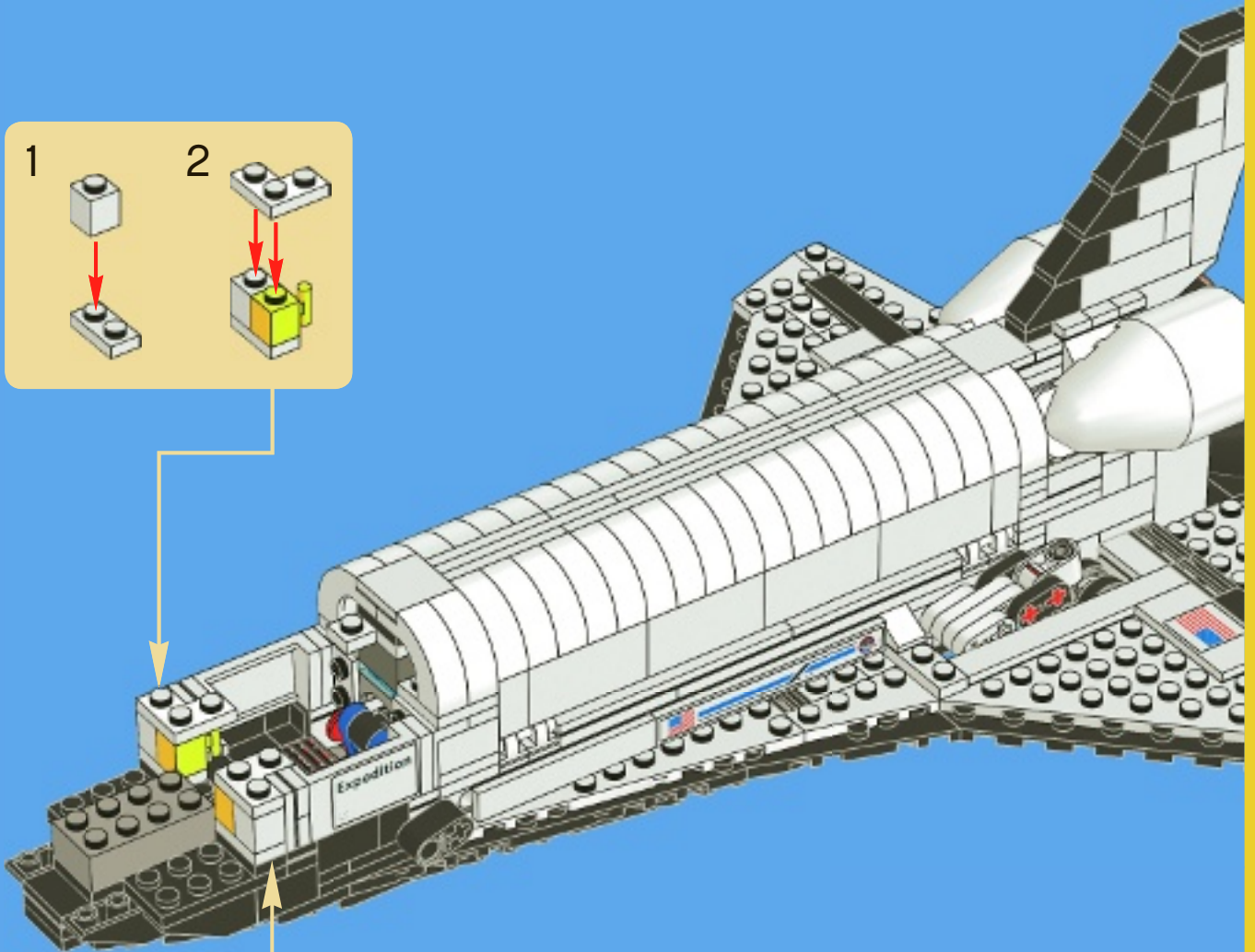
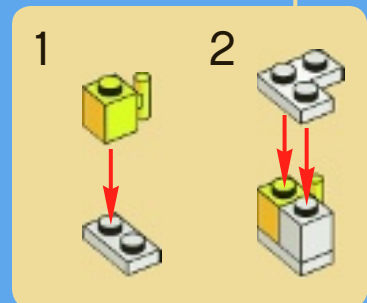
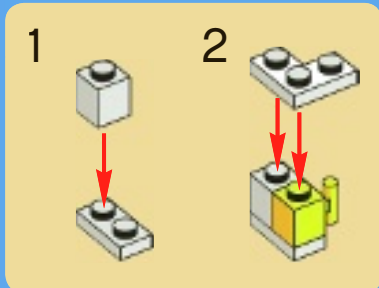



2x



4x

# 60

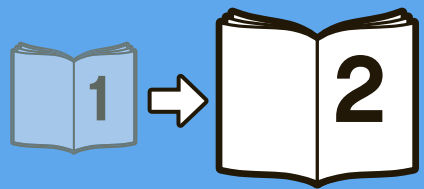
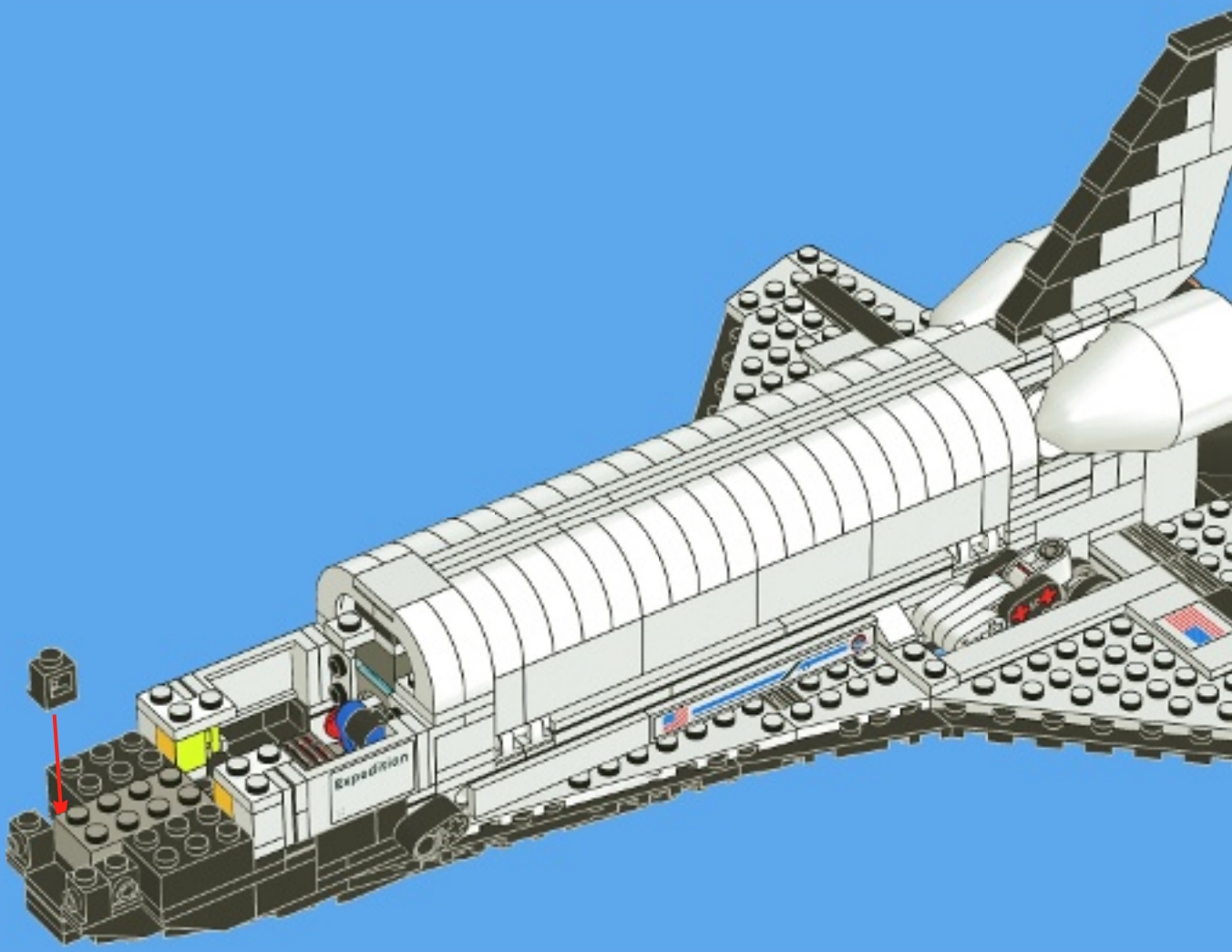



10214



LEGO and the LEGO logo are trademarks of the/son des marques de commerce de/  
son marcas registradas de LEGO Group. ©2011 The LEGO Group. 4656627 / 4658281





10231

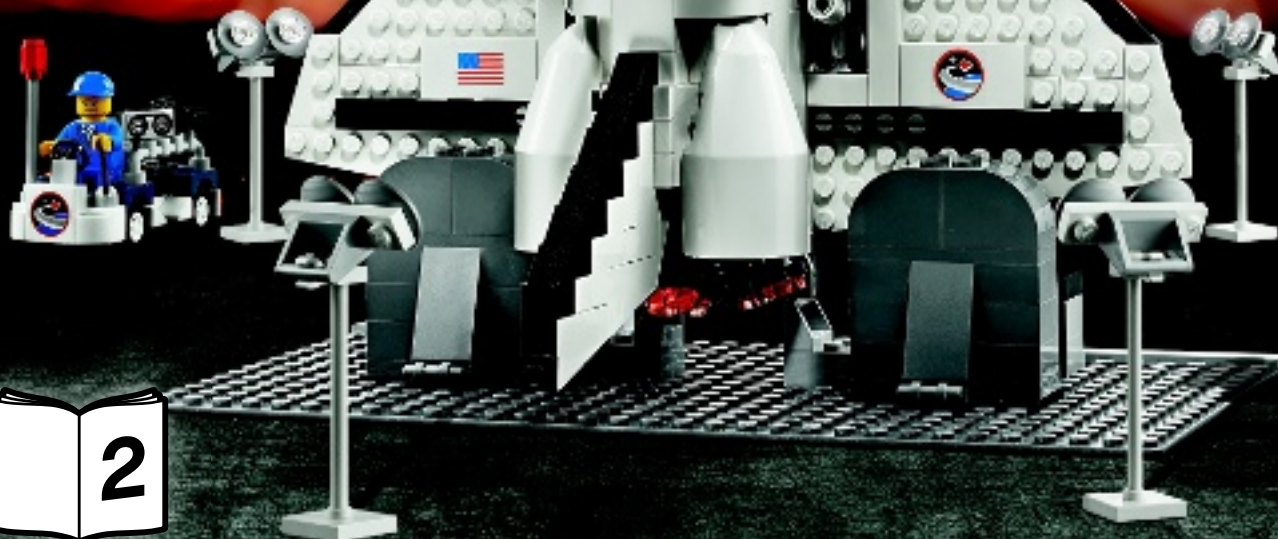



# 61

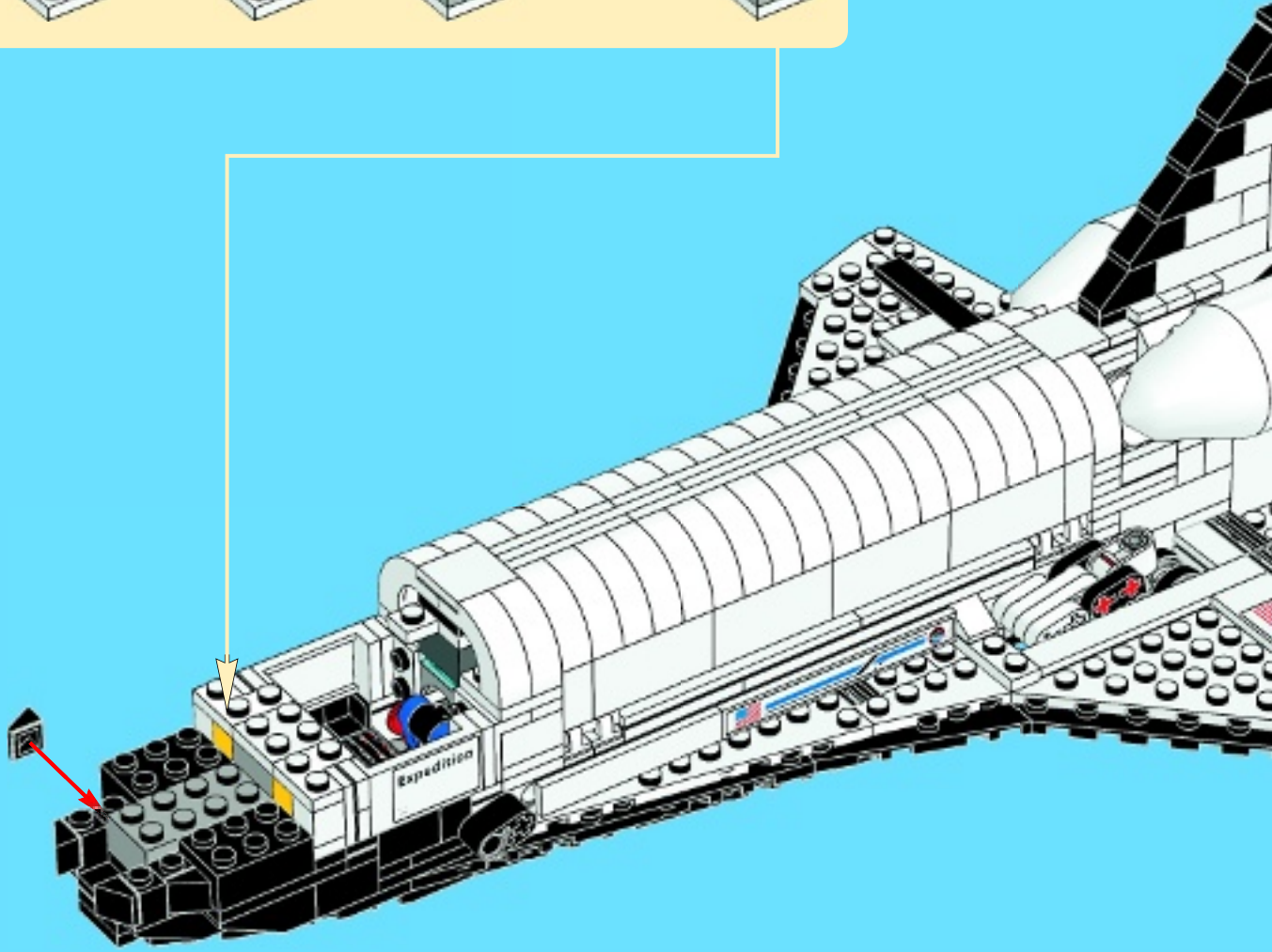
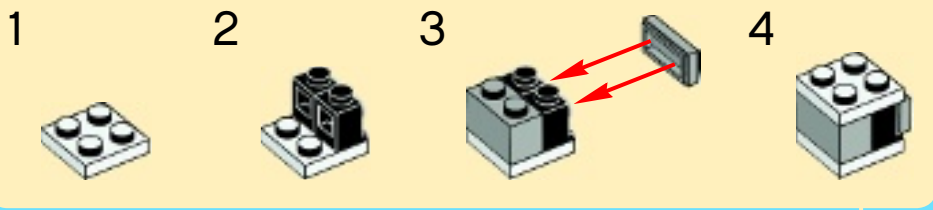



2x



2x

# 62

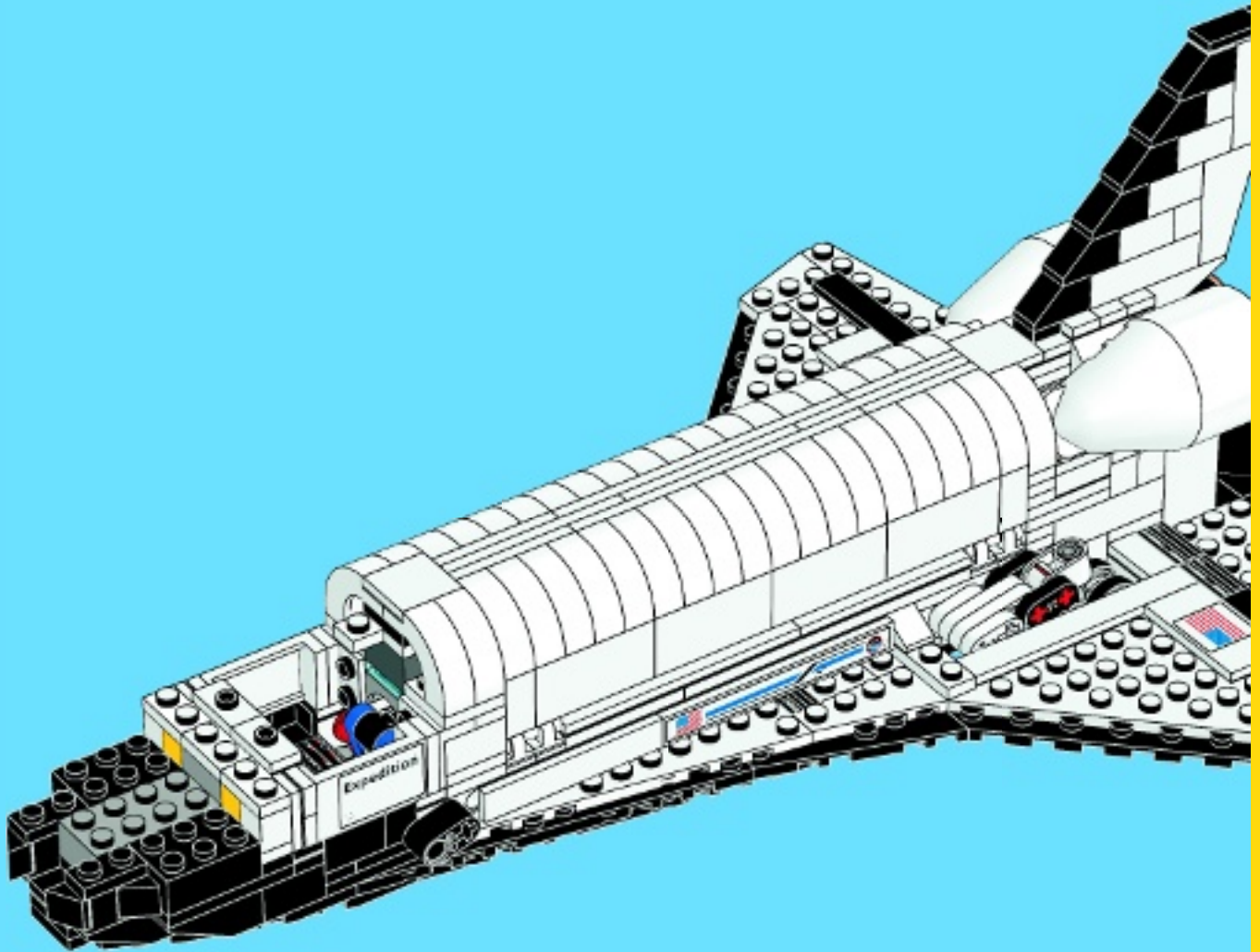



2x



2x



2x

# 63

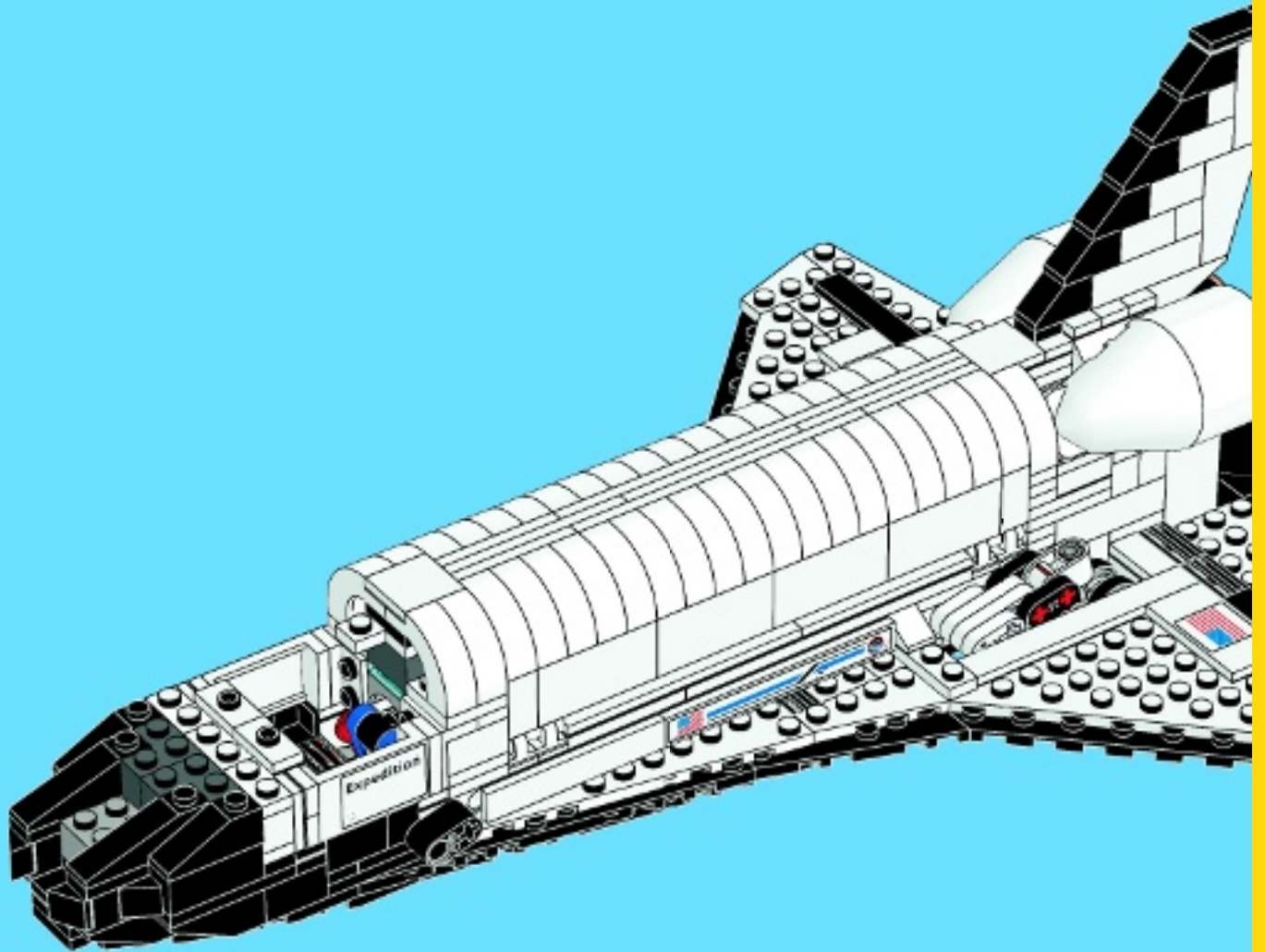



4x

1x

1x

1x

# 64

1



2



3



4

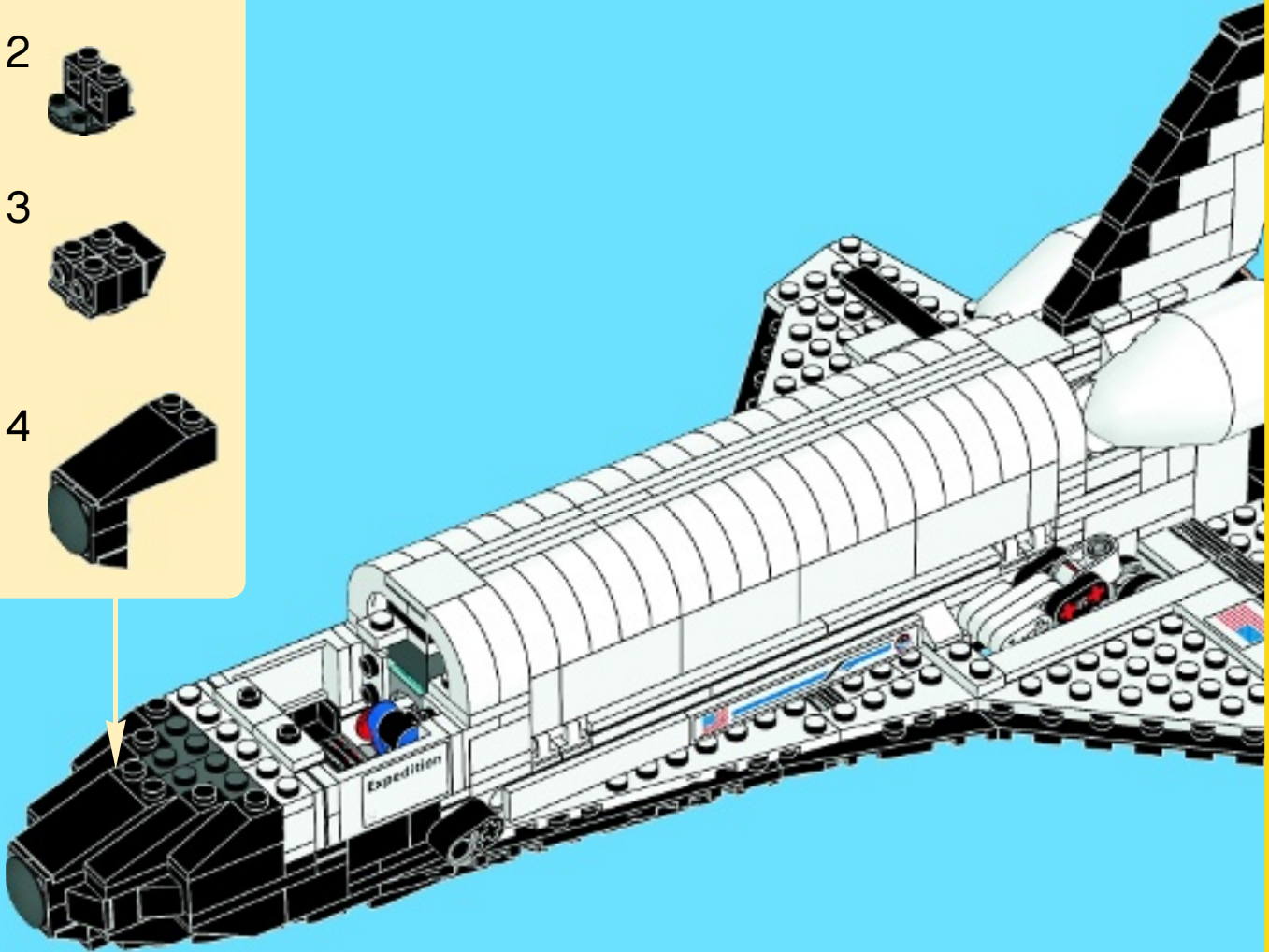



2x



1x



2x

# 65

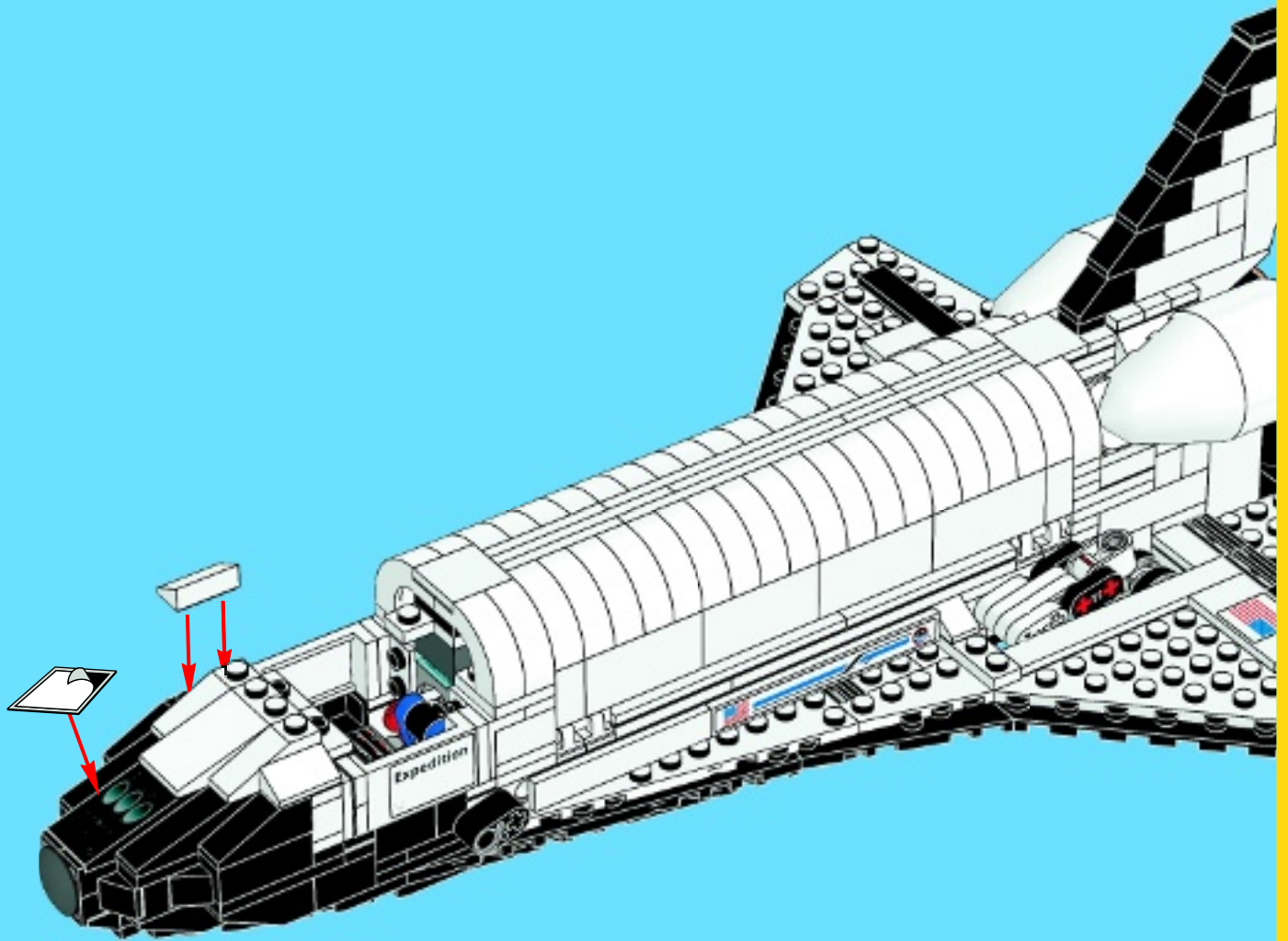



4x

66

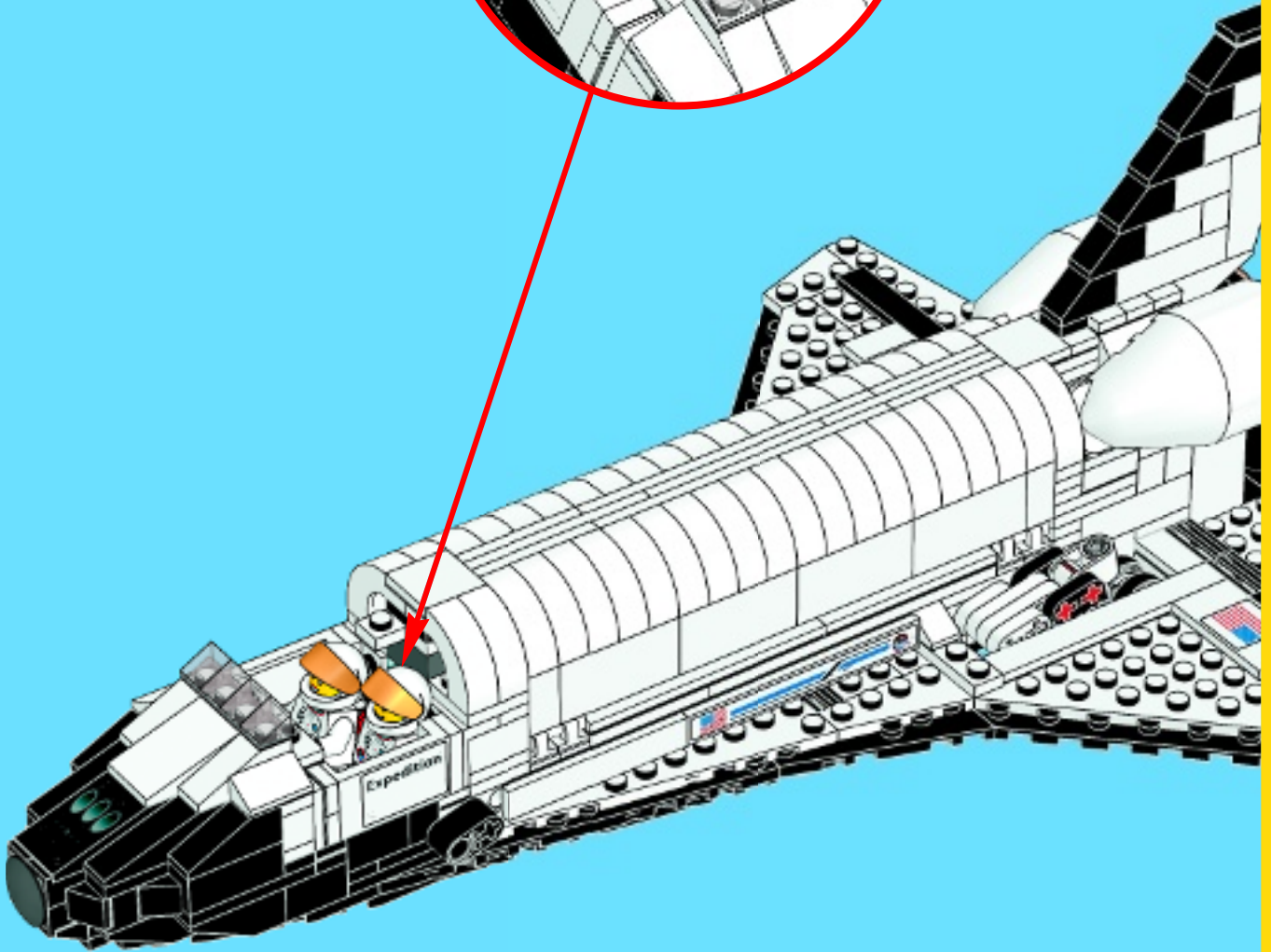
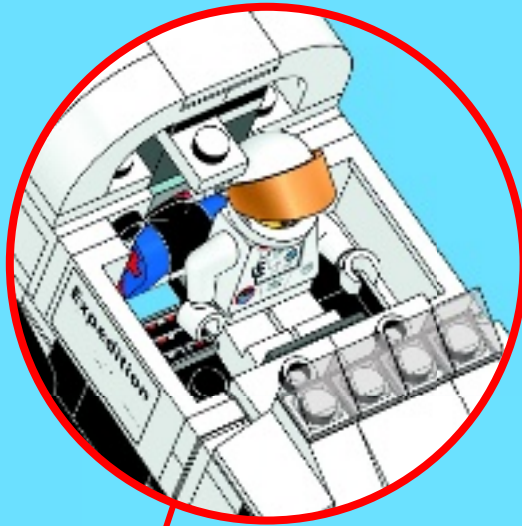

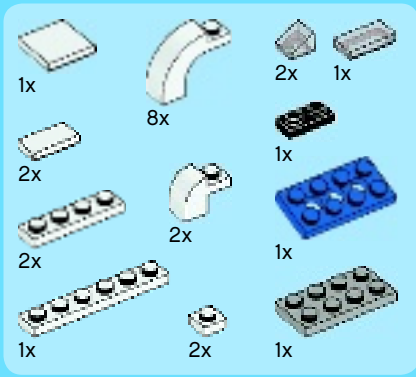

# 67

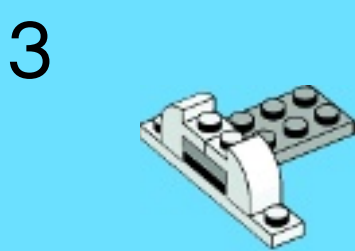
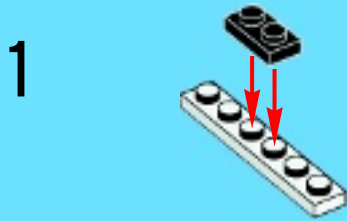

# 4



# 5

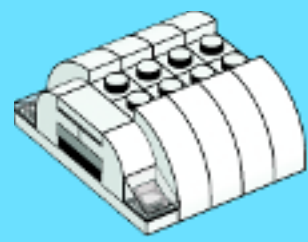

# 6

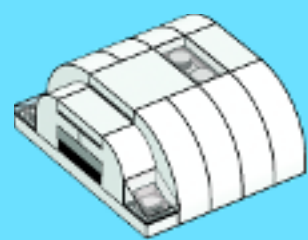



7

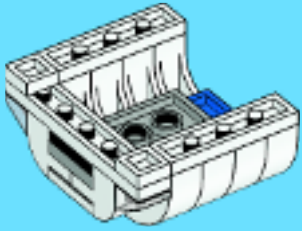

8

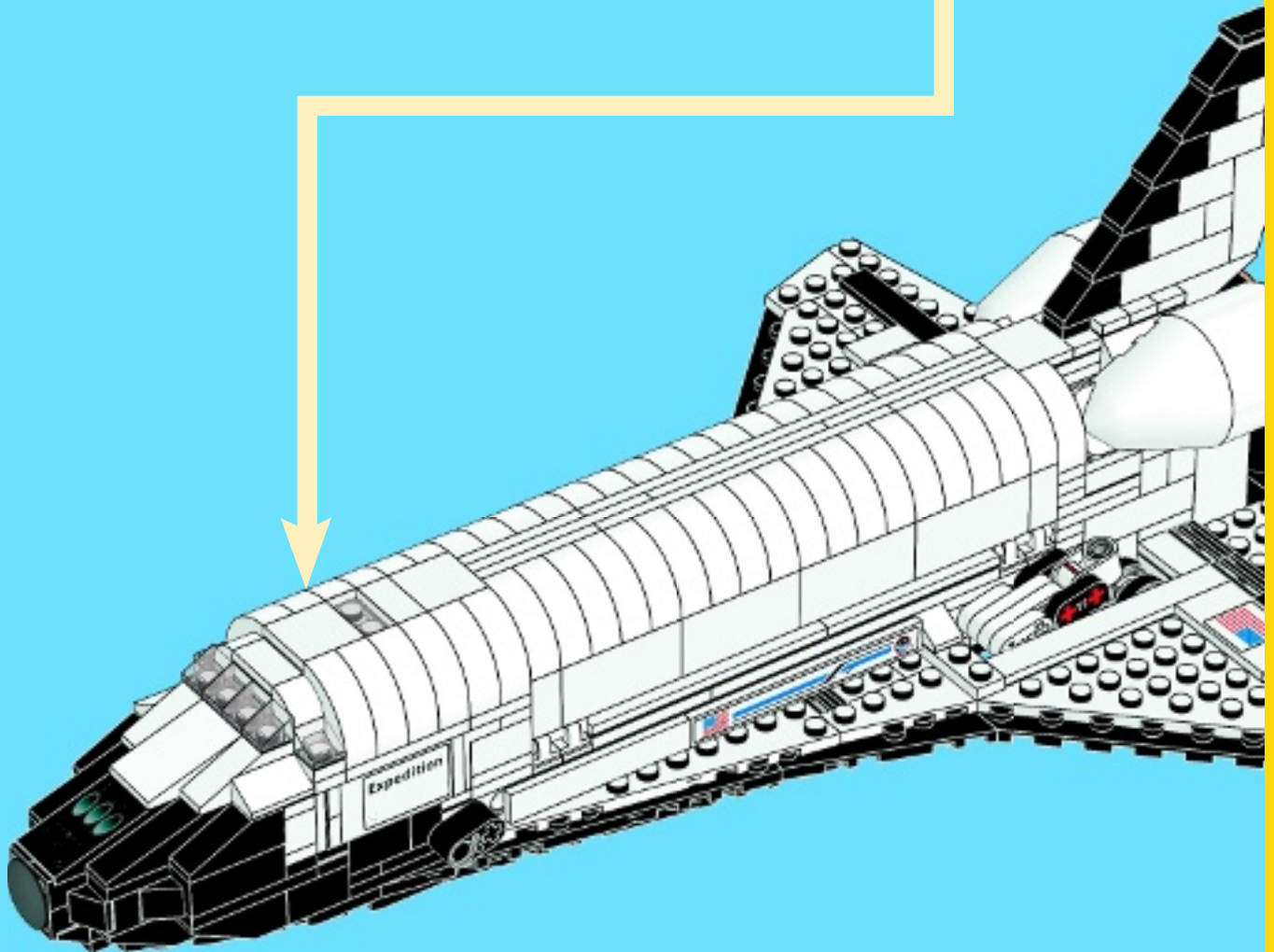
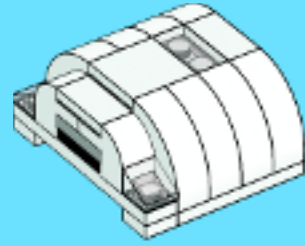

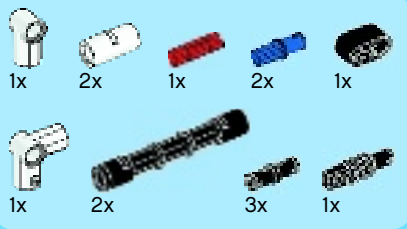

# 68

1



2

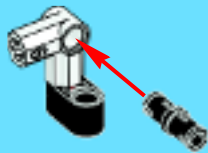

3

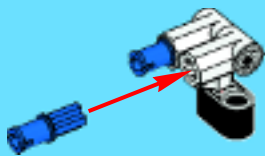

4

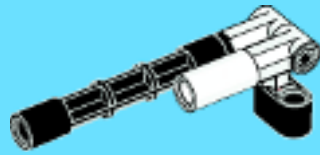

5

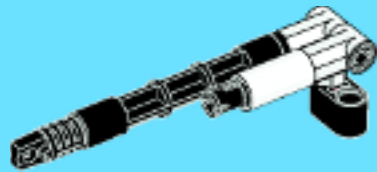

6

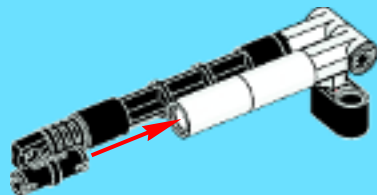

7

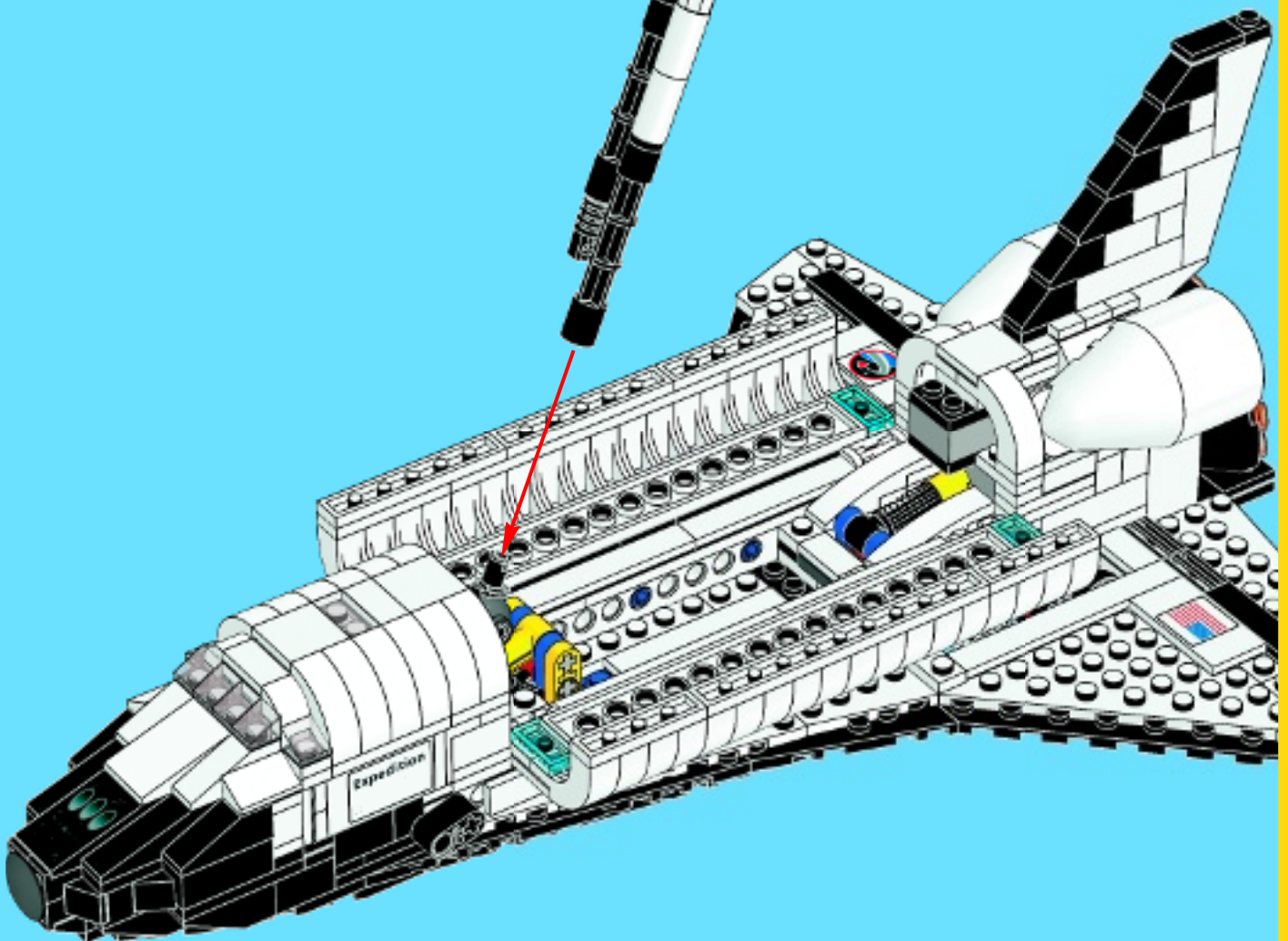
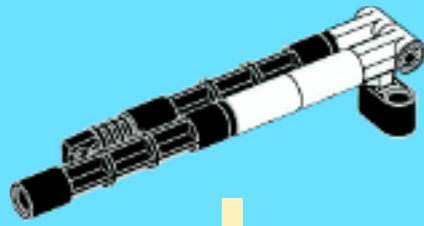



1

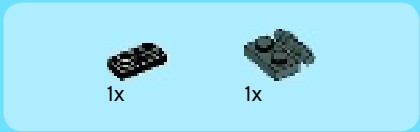
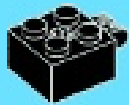

2



3

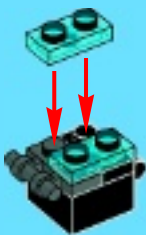

4

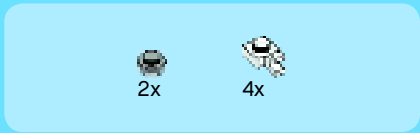

5



6





7

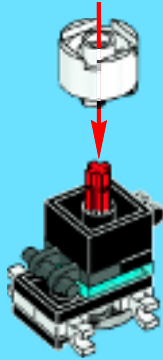

8



9



10

1



2



3

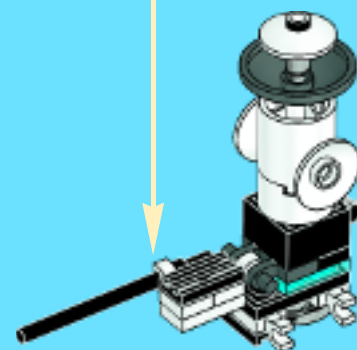

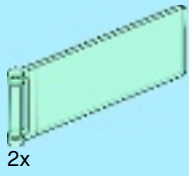

11

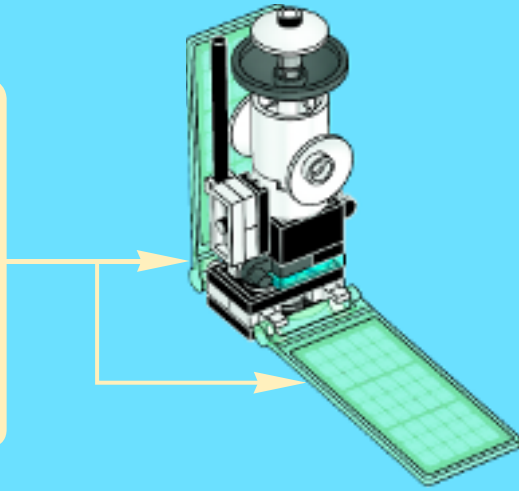
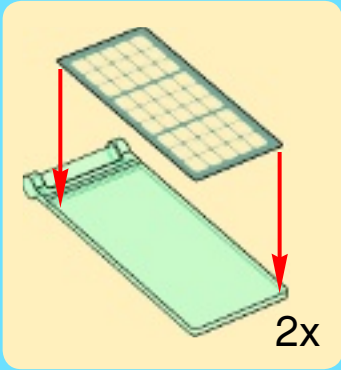

12

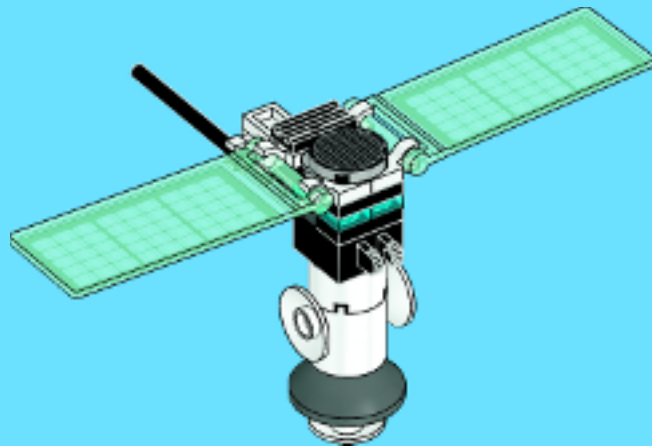

69

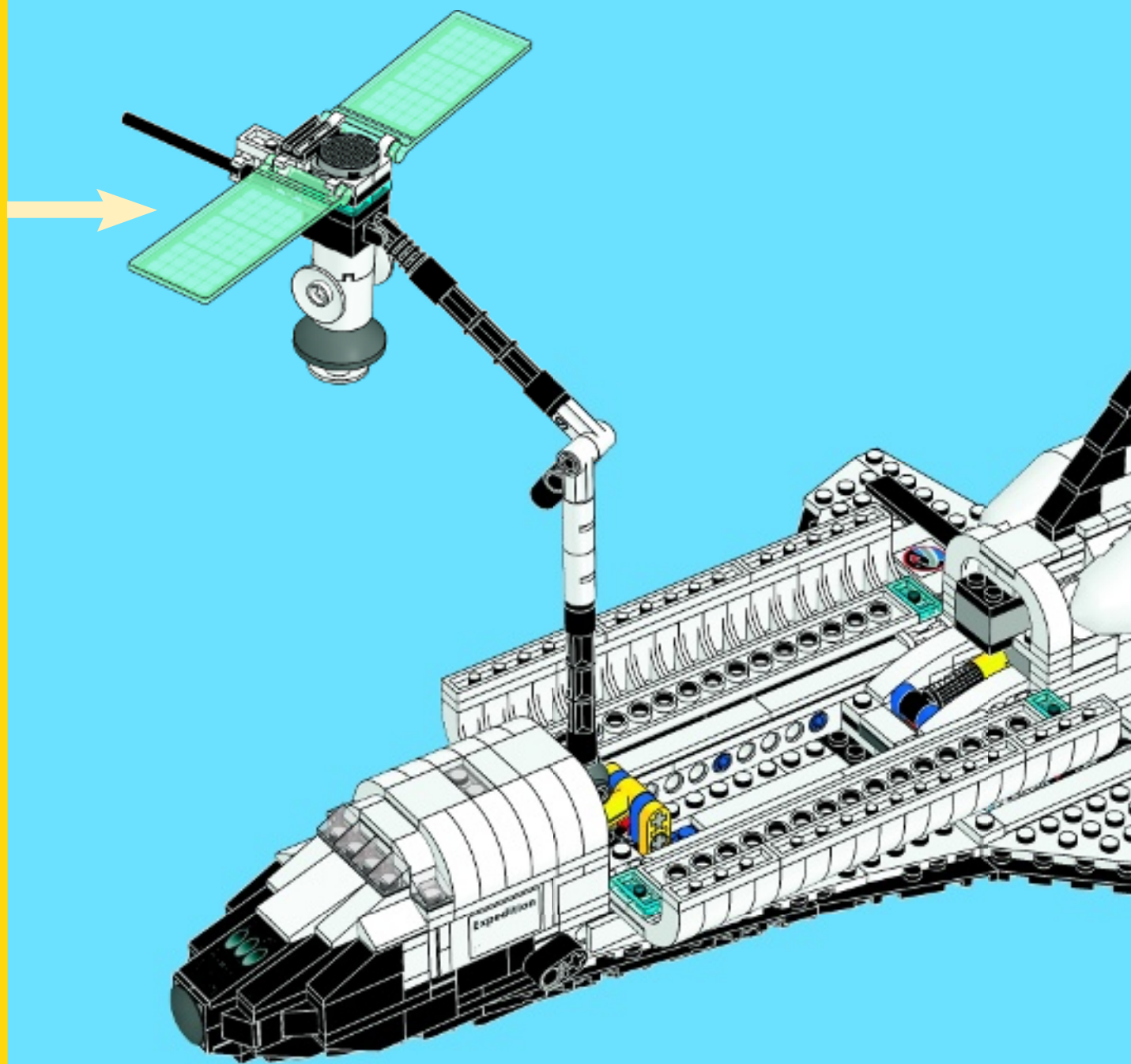

70

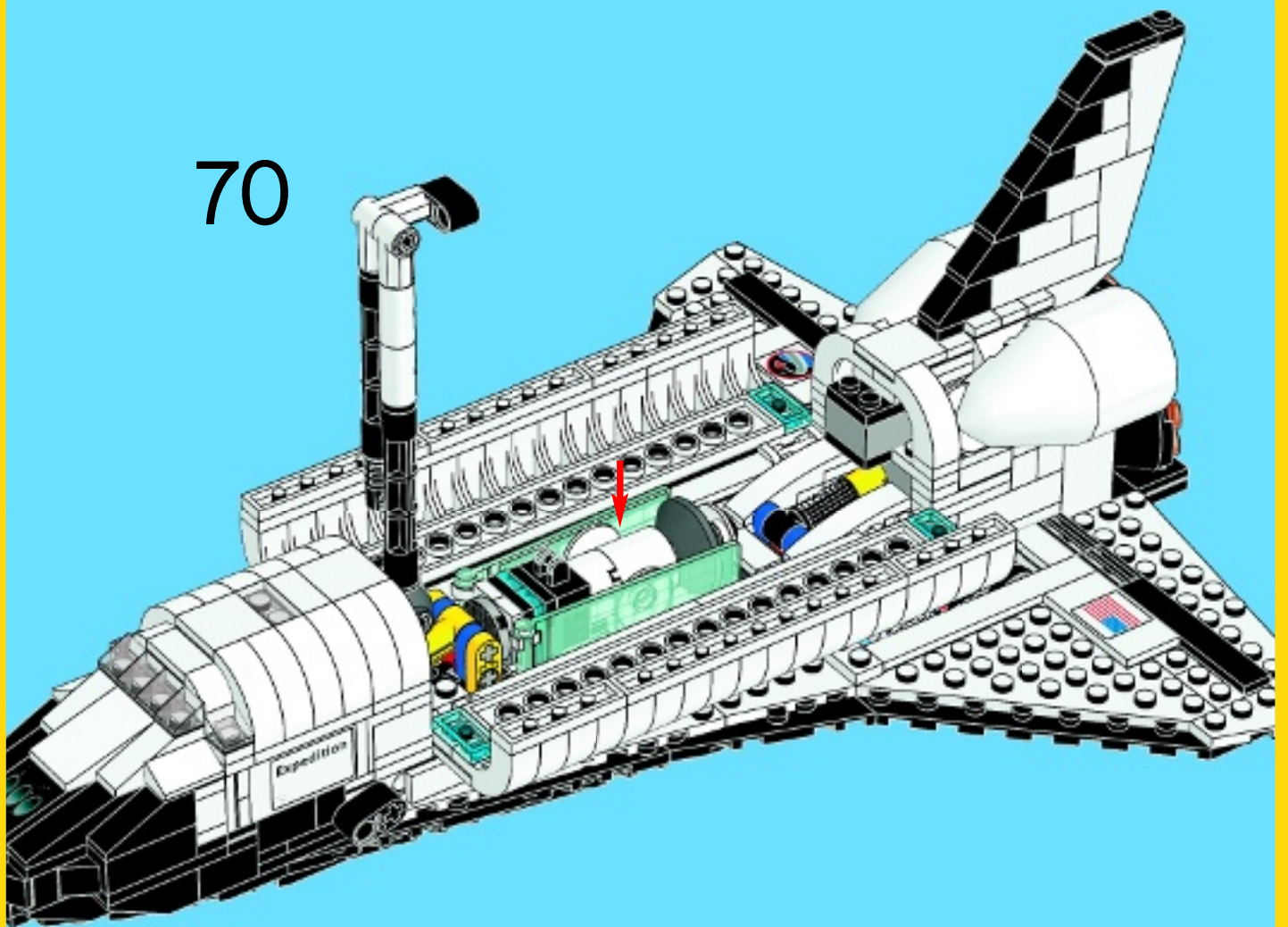



71

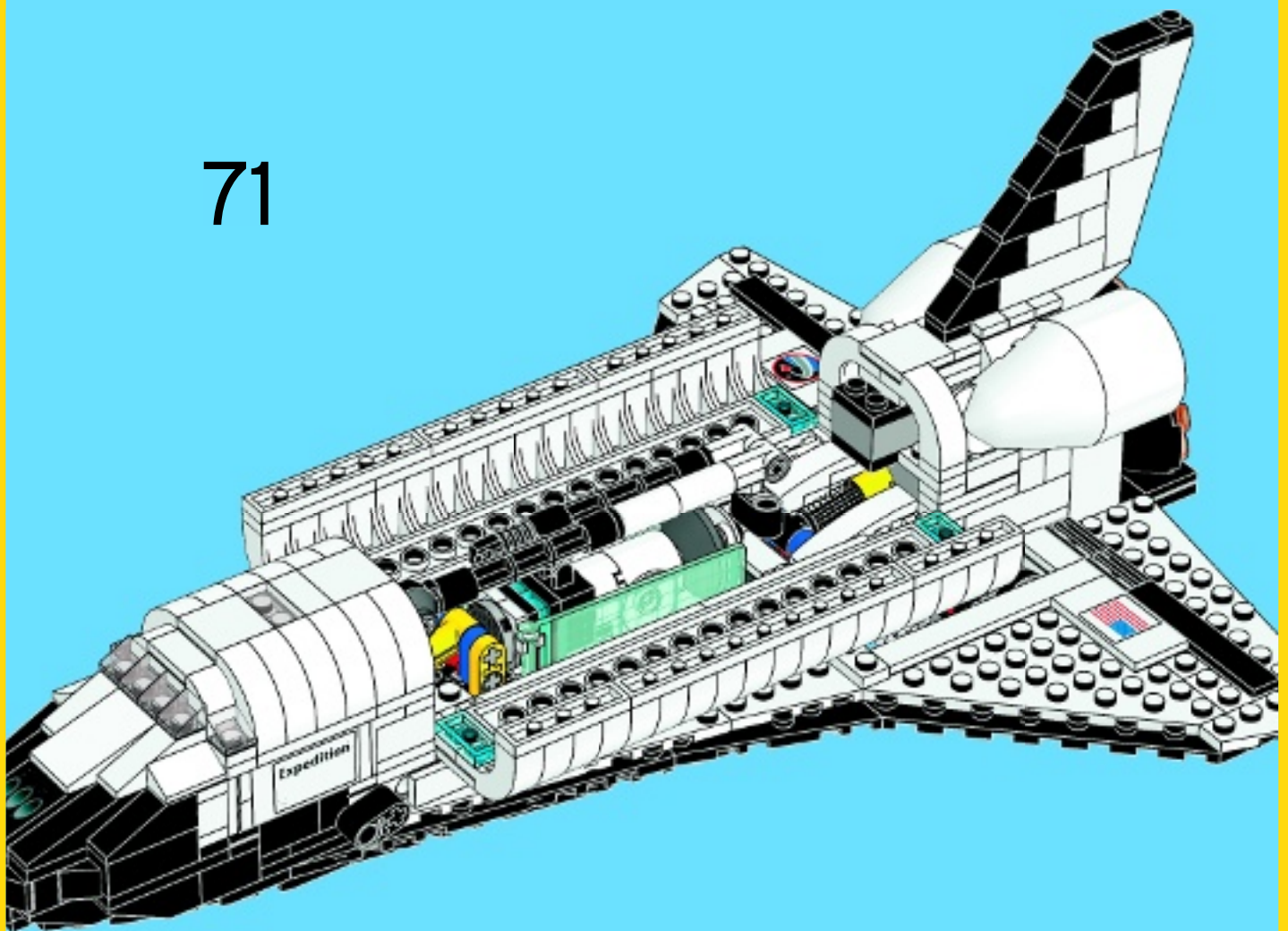

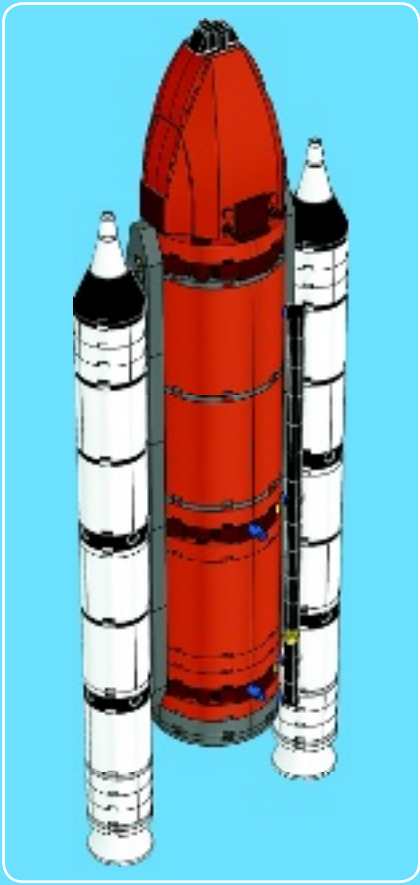

1

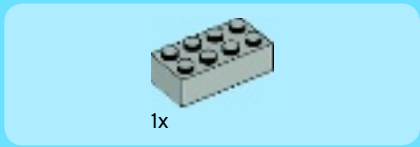
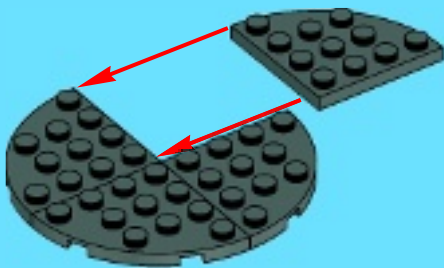

2



3

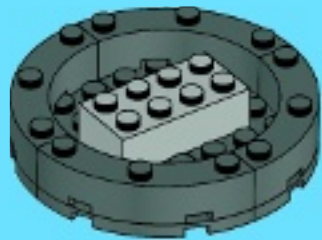



4x

4

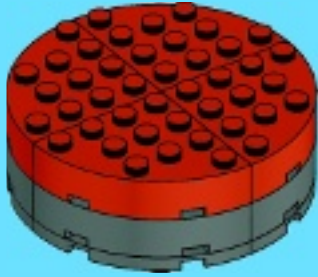

8x

6

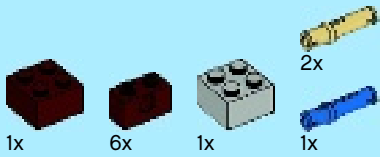
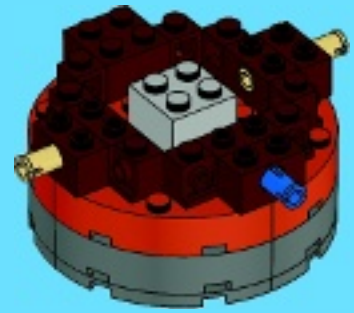

5

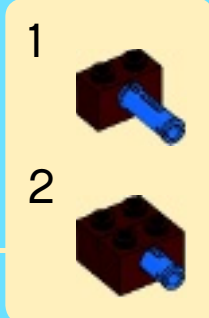
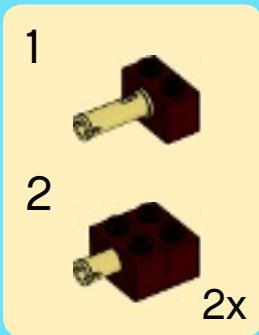

7

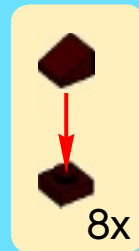



4x

# 8

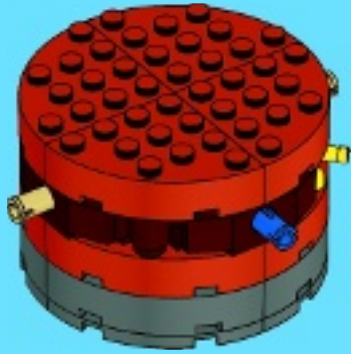

4x

# 9

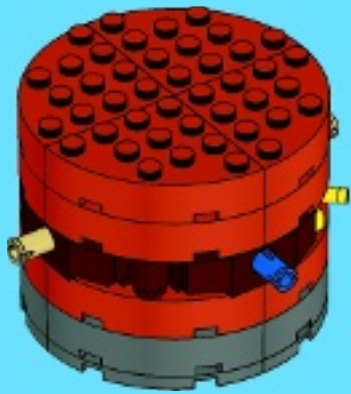

1x



1x

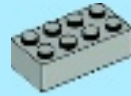

2x

# 10

1

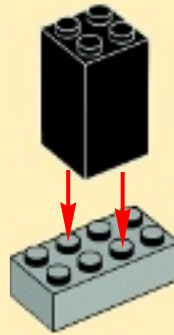

2

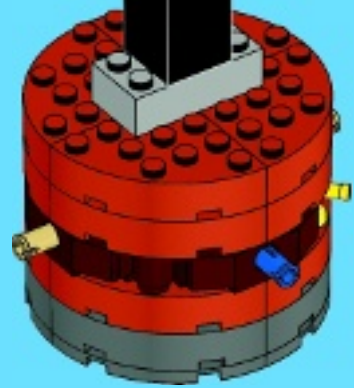
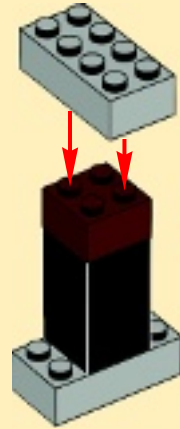



4x

11

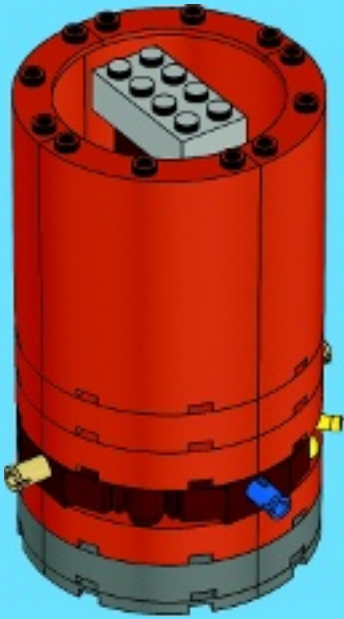

4x

12



1x

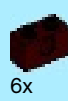

6x



1x



2x



1x

13

1



2



2x

1



2

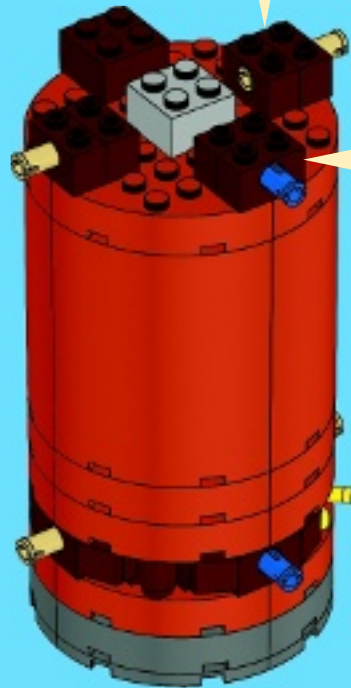



8x

# 14

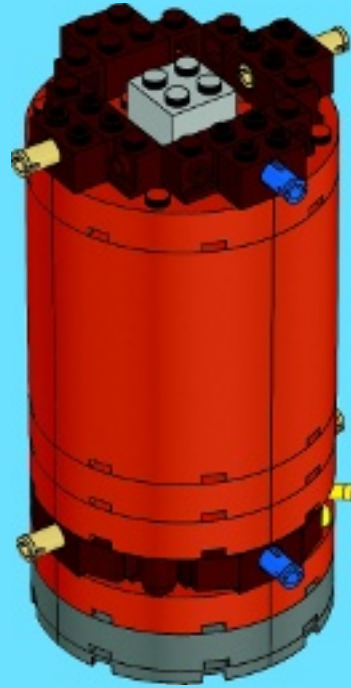

8x



3x



8x



1x

# 15

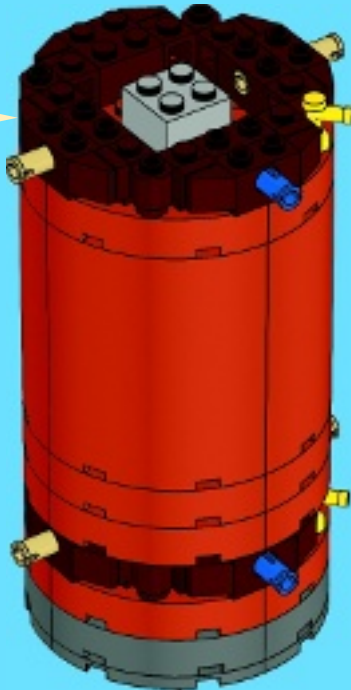
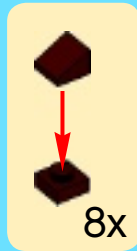



4x

# 16

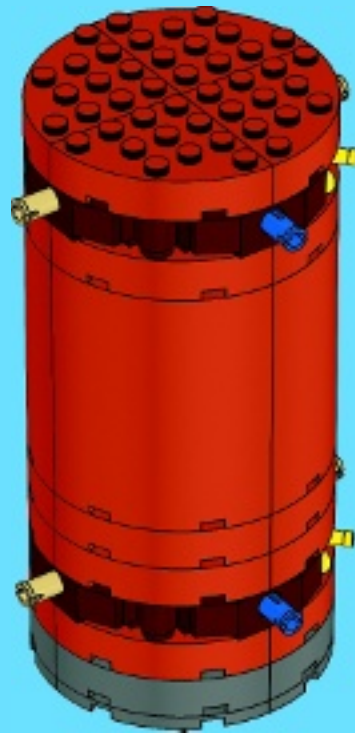

4x

# 17





1x



1x

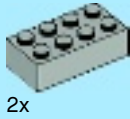

2x

# 18

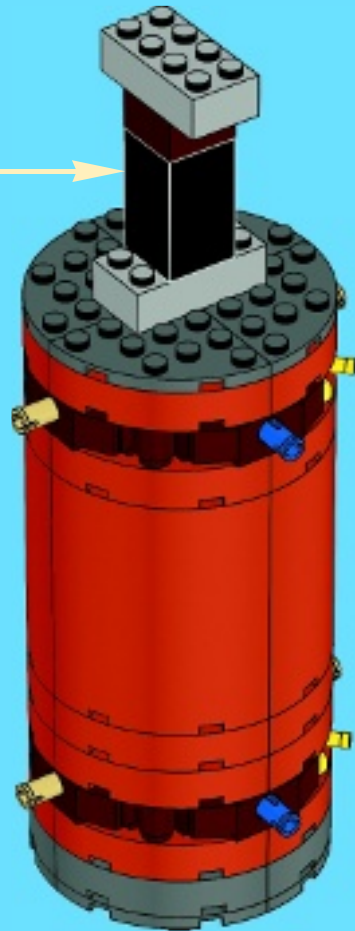
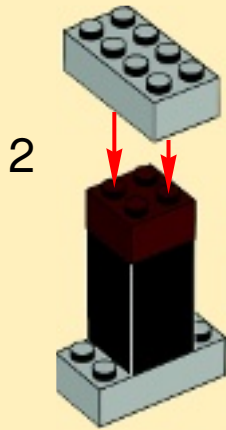
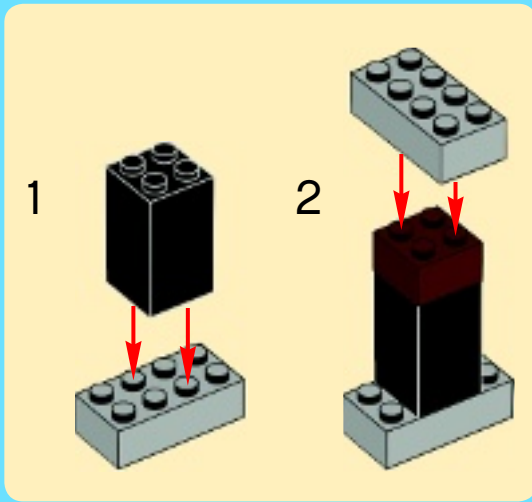





4x

19

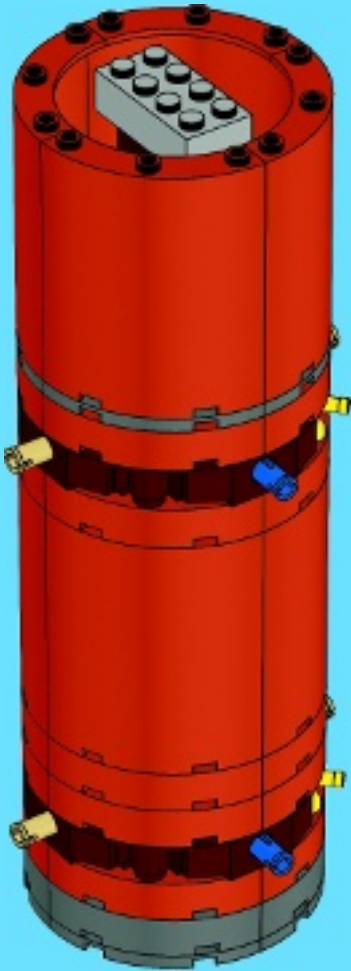

4x

20

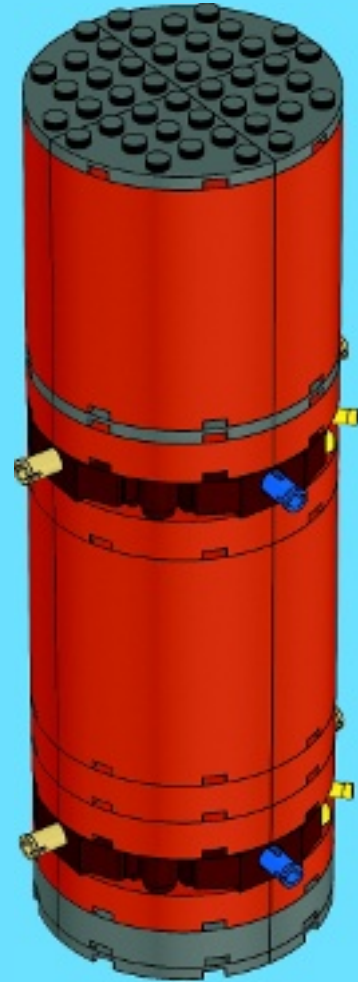



1x



1x

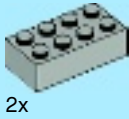

2x

# 21

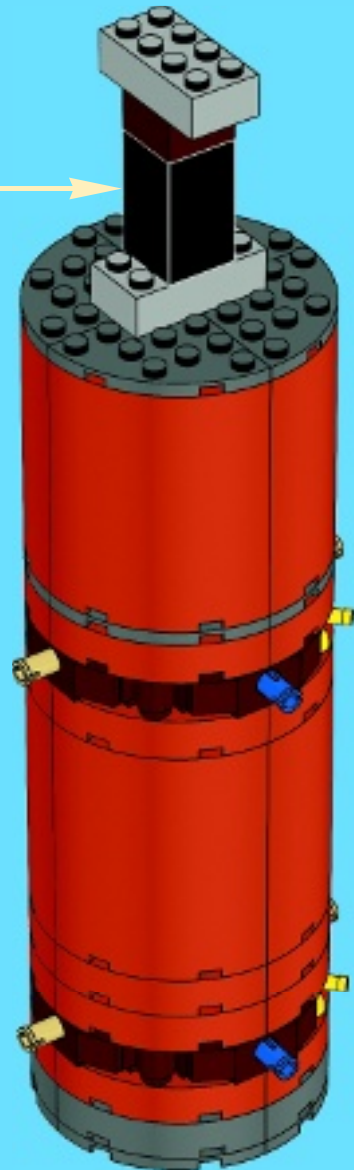
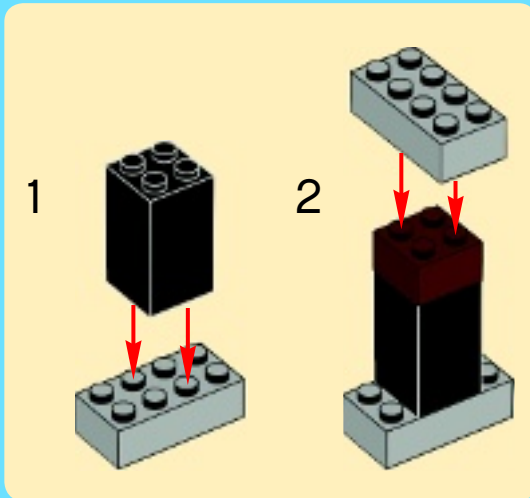



4x

22

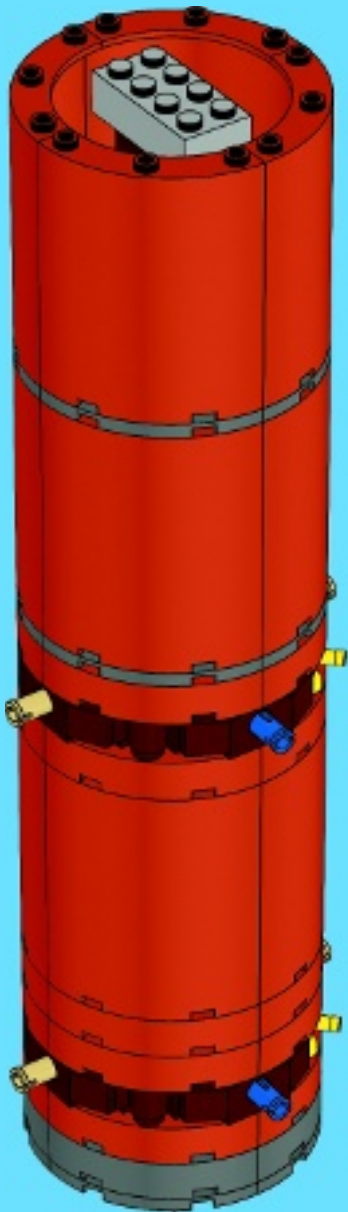

4x

23

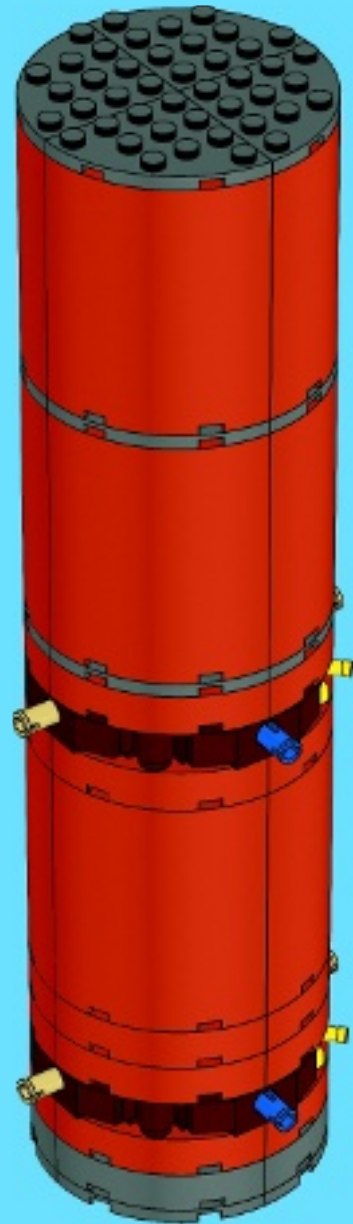



2x



4x



1x



2x

# 24

1



2



2x

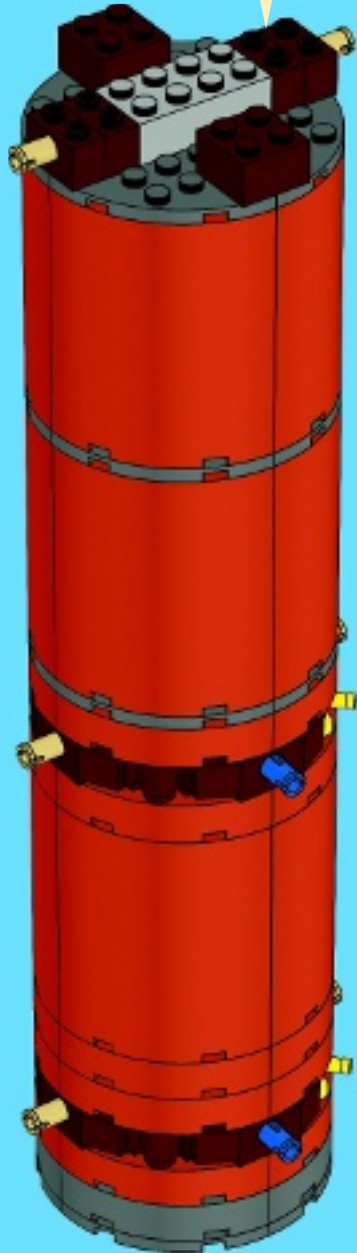



8x

25

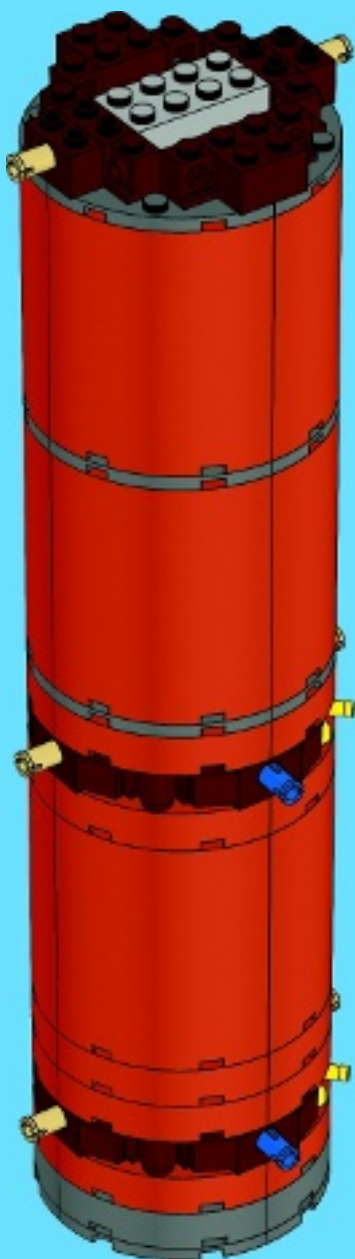



8x



4x



8x

# 26

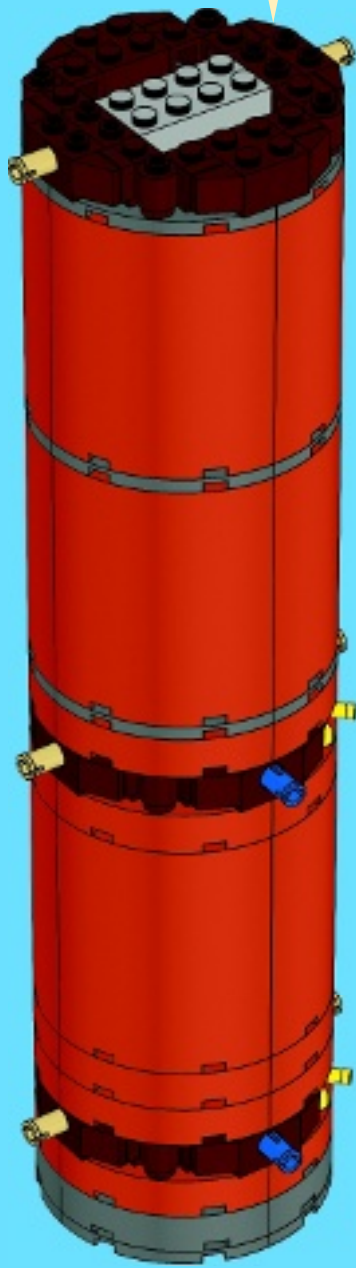
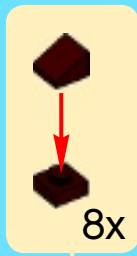

4x

# 27

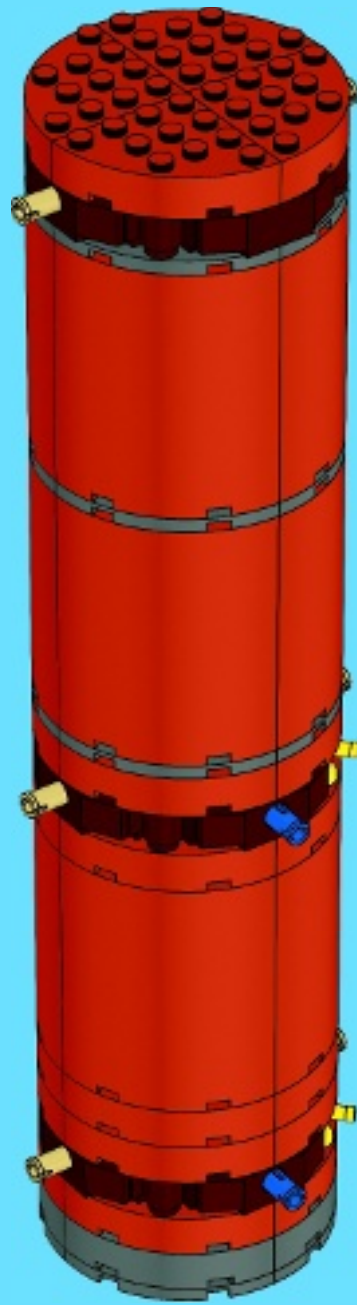



4x



4x

28

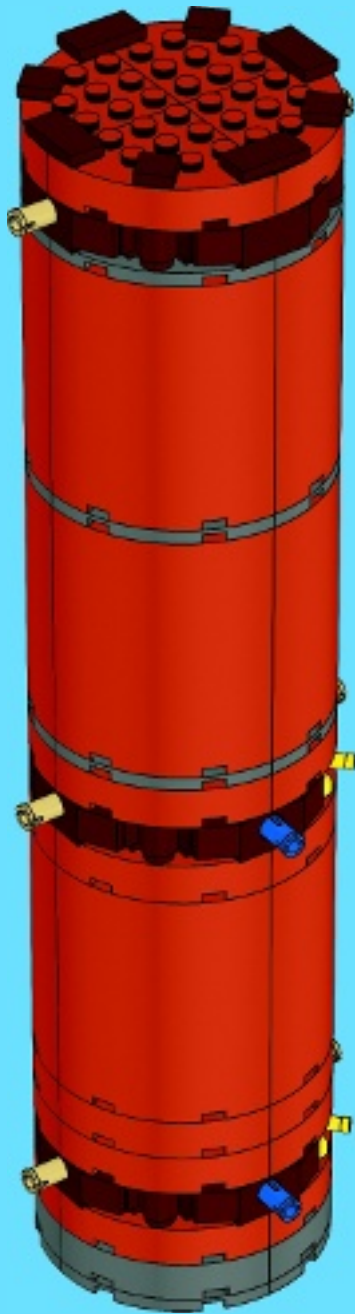



# 29

1



2



3



4







5



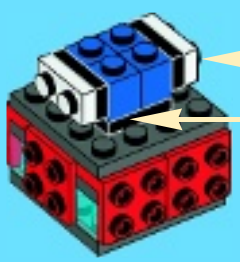

6



- 1 
- 2   2x

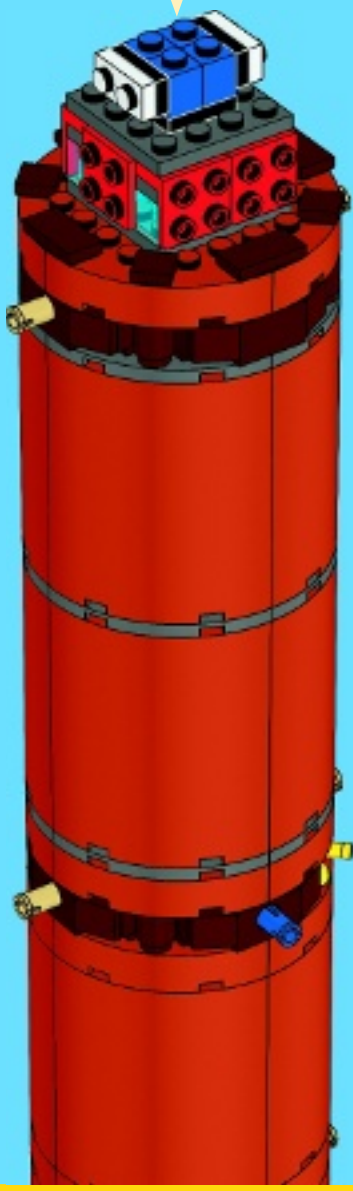

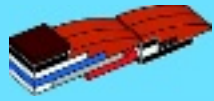

2x



2x



2x



8x



2x



2x



2x



4x



2x



2x



2x



2x

# 30

## 1

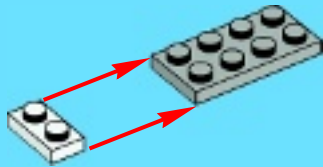

## 2



## 3



## 4

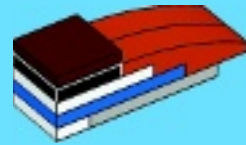

## 5



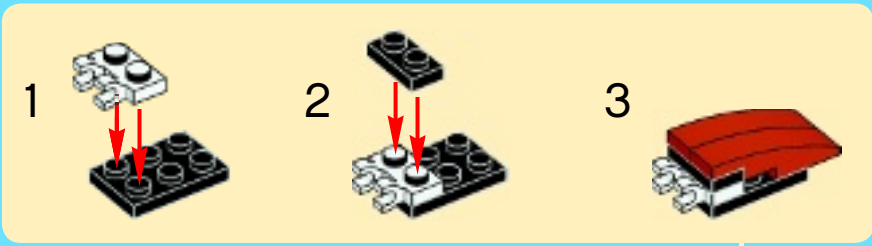

6

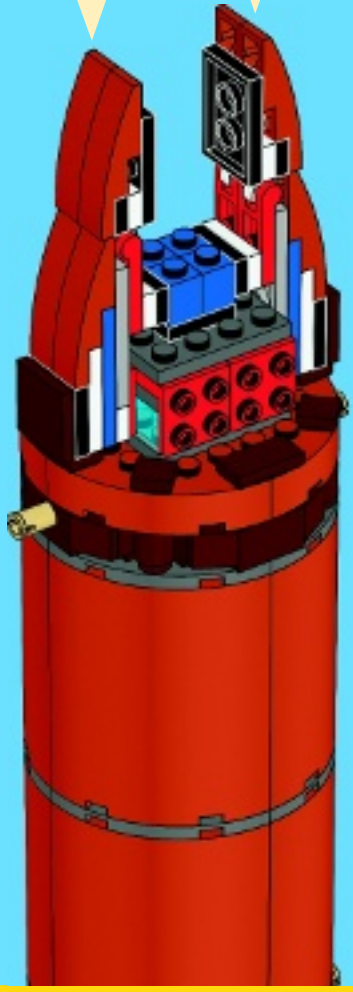
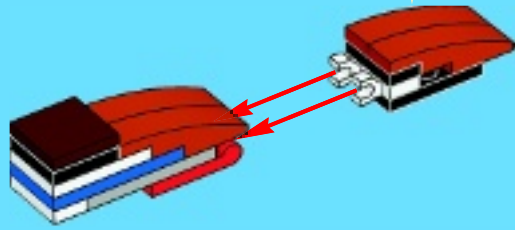

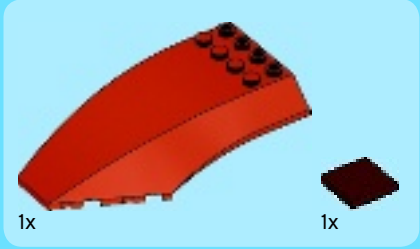

1

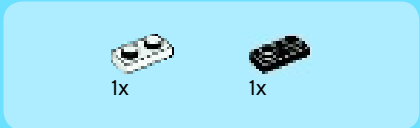
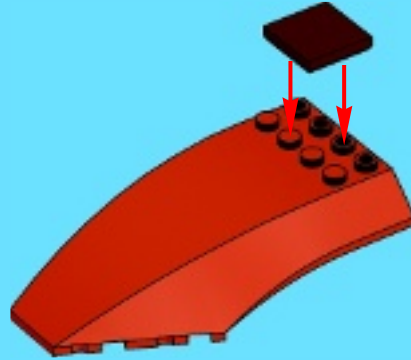

2

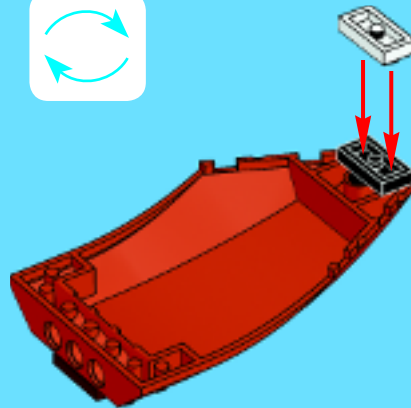



1x

1x

1x

# 3

1



2



1x

1x

# 4





1x



1x

5



1x



1x

6

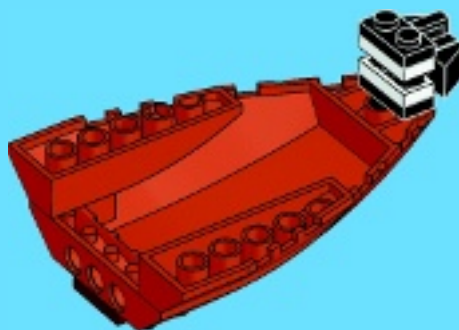

31

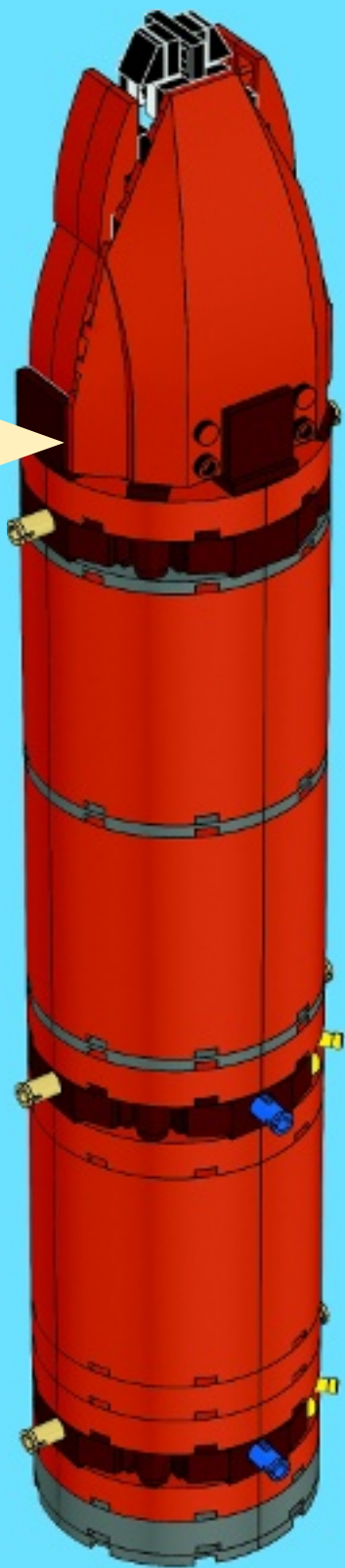

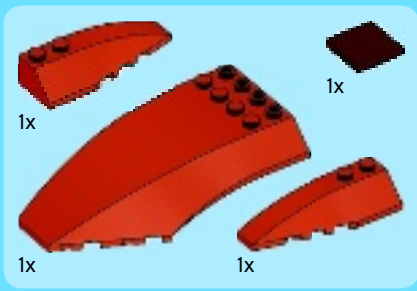

32

1

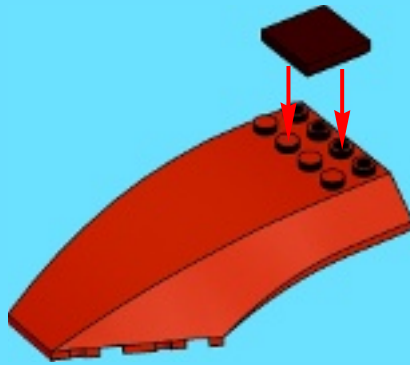

2

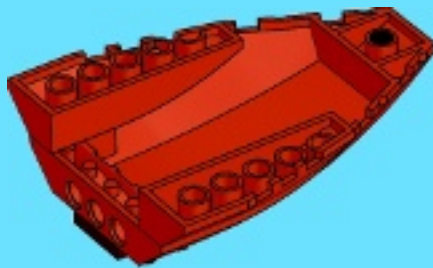



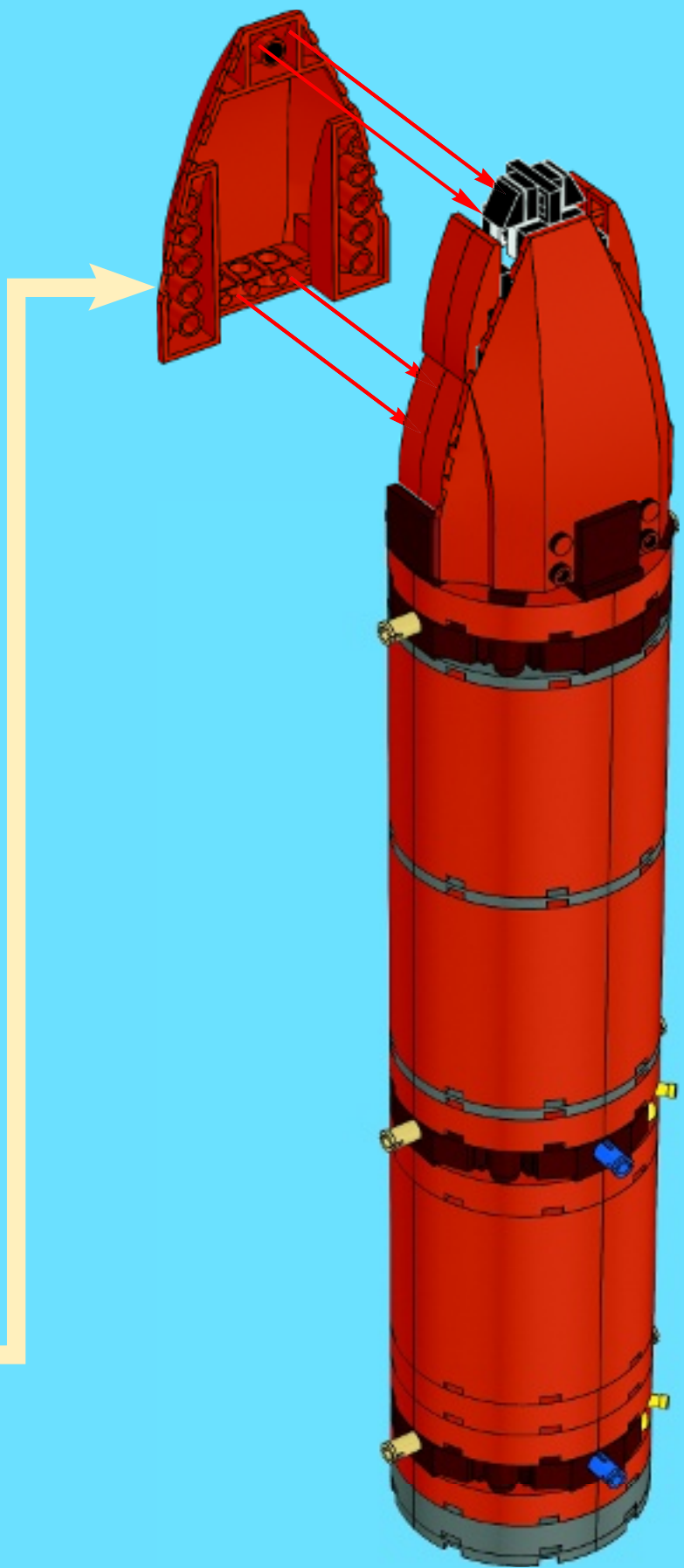

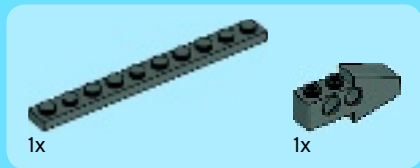
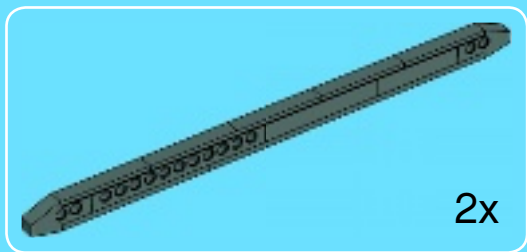

1

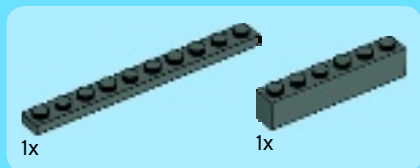
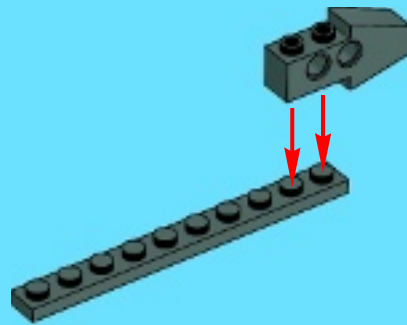

2

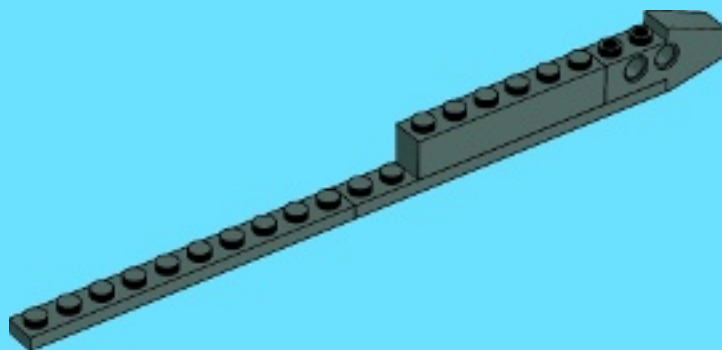

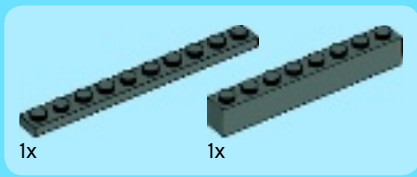

3

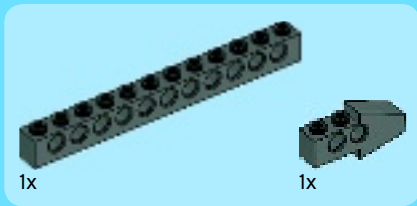
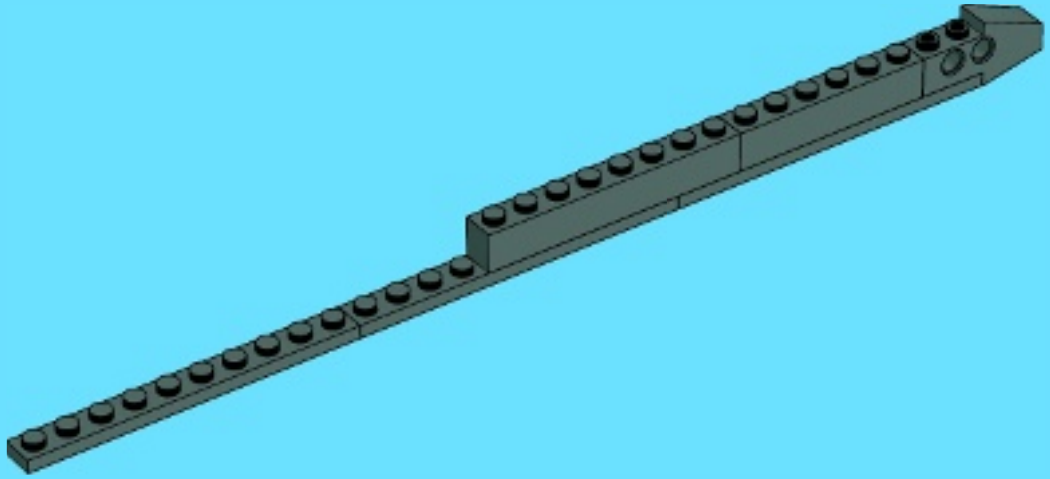

4

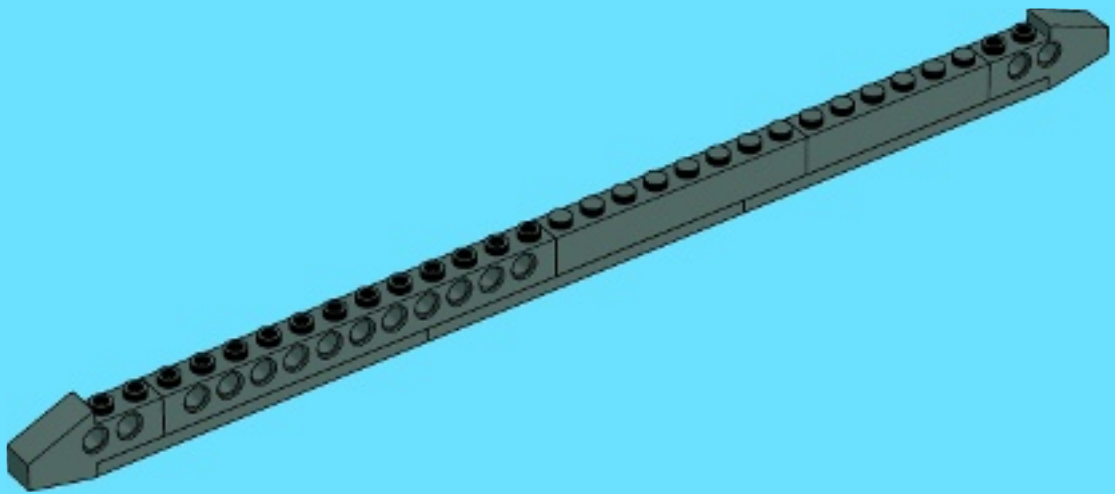



5x

5

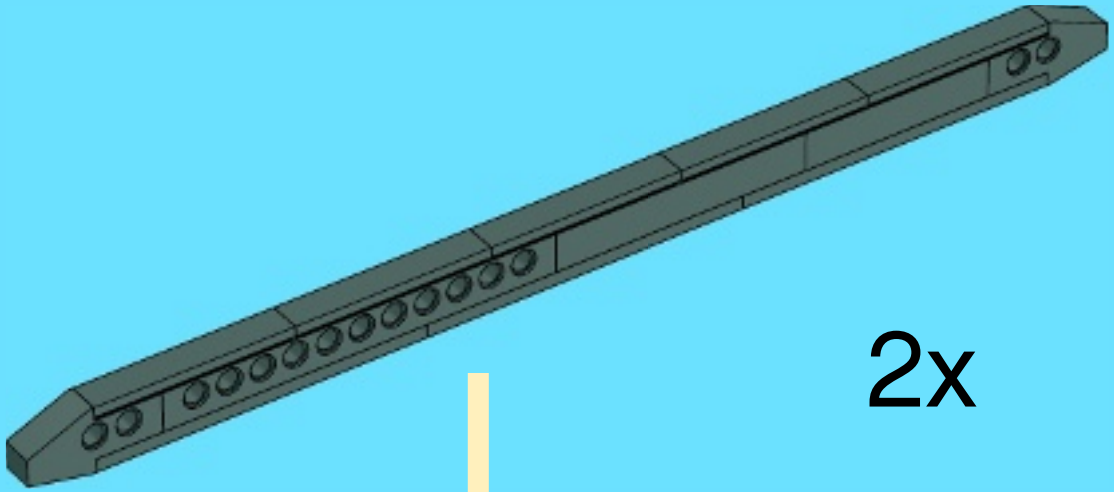

2x

33



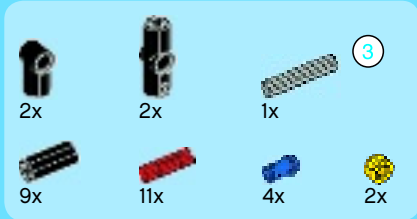

34

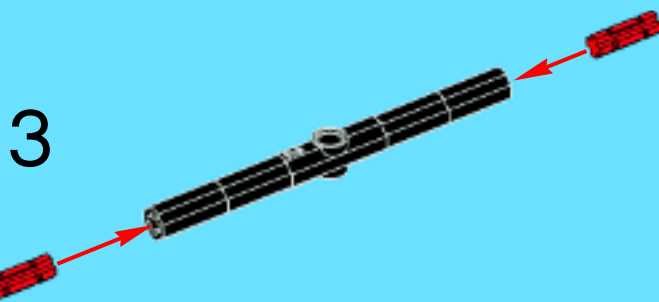
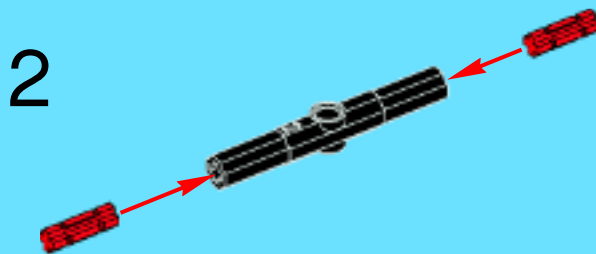
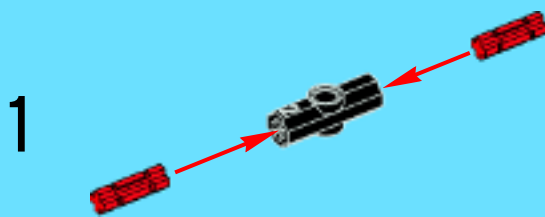

4

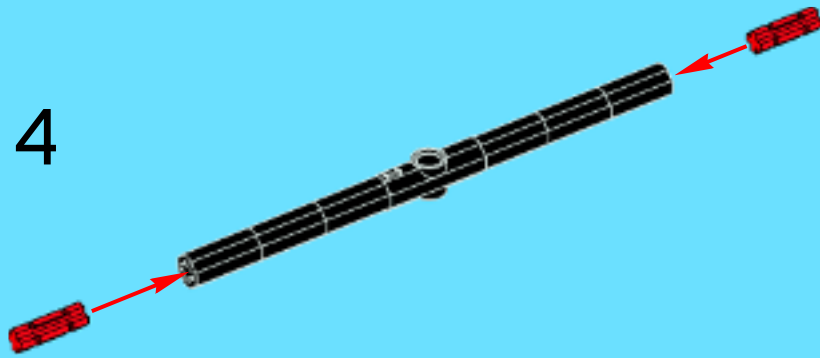

1

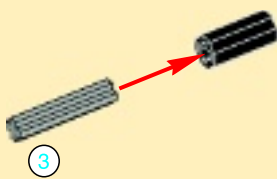

3



2

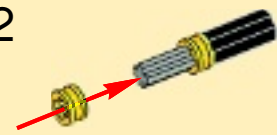

4



5

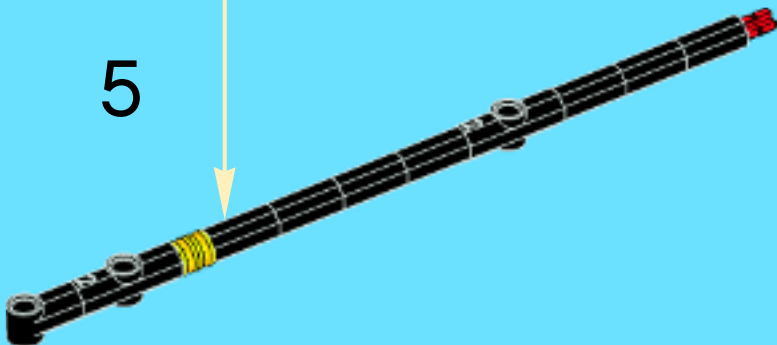

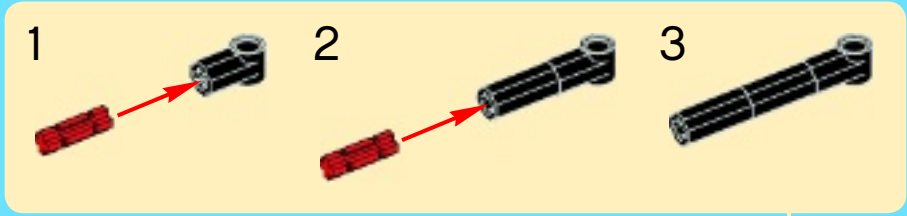

6

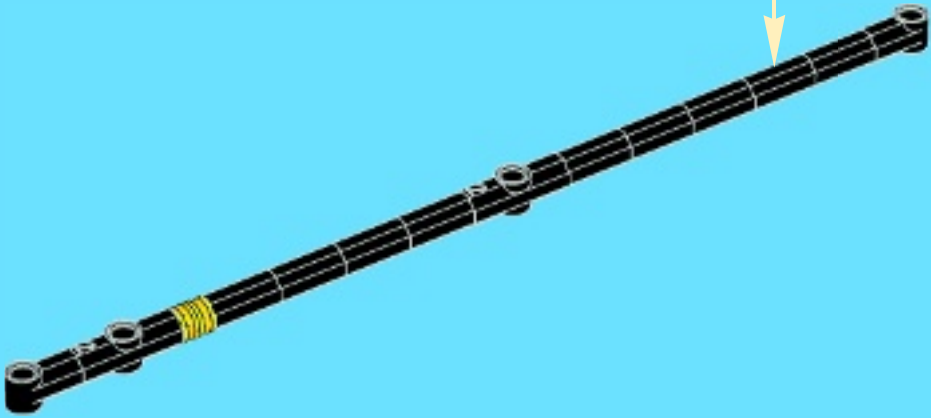

7



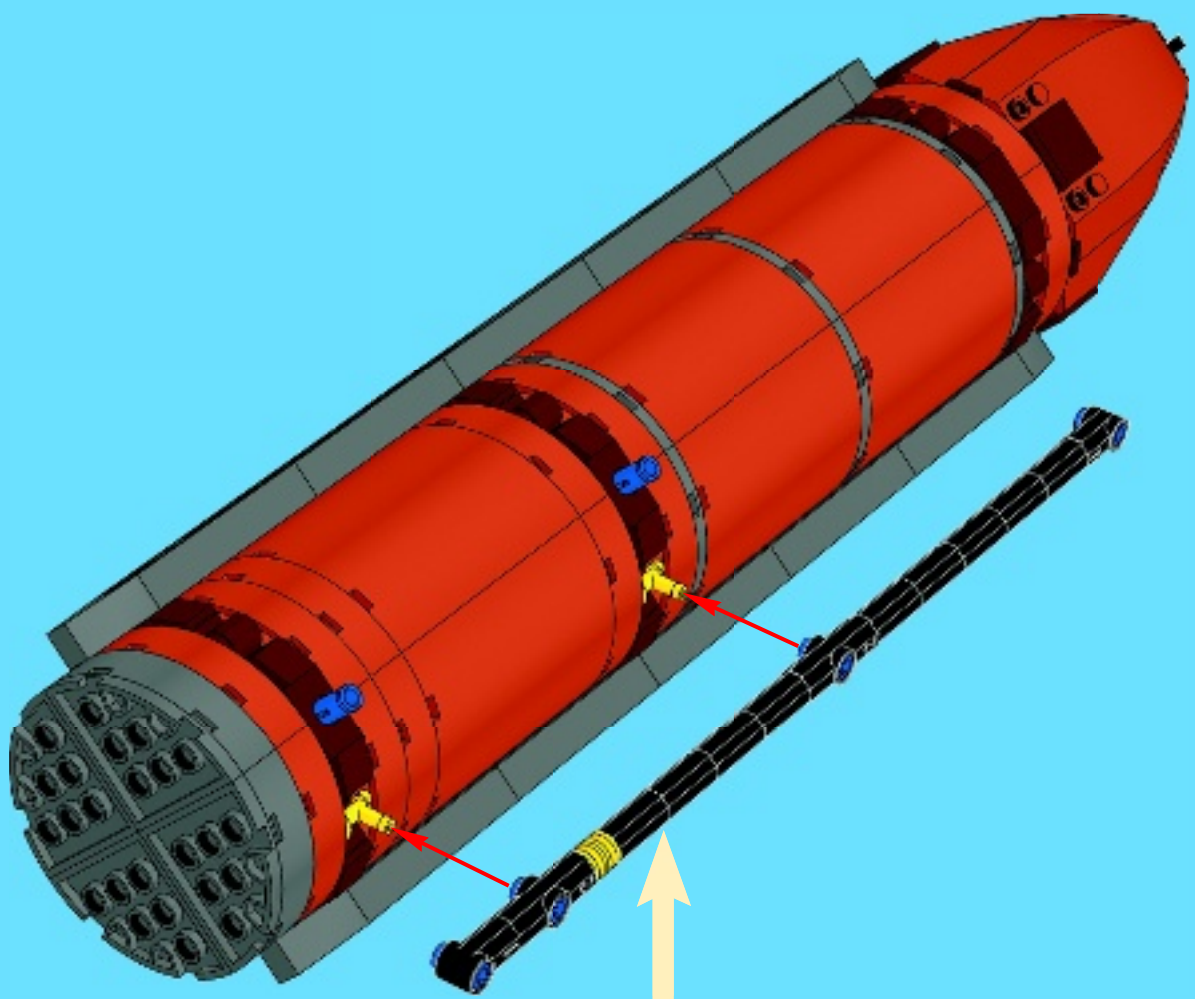





1x

# 35

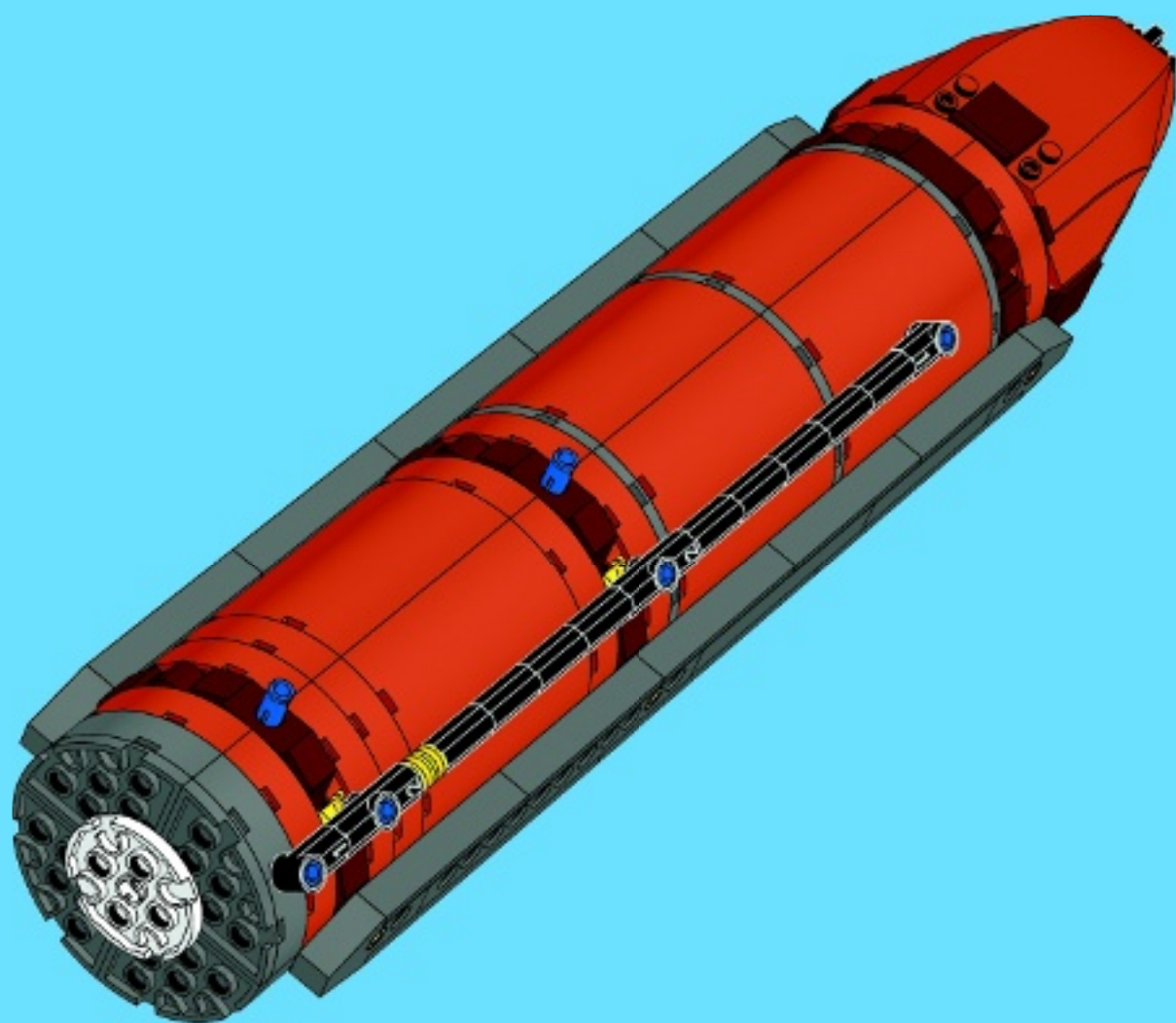



1x



1x

# 36

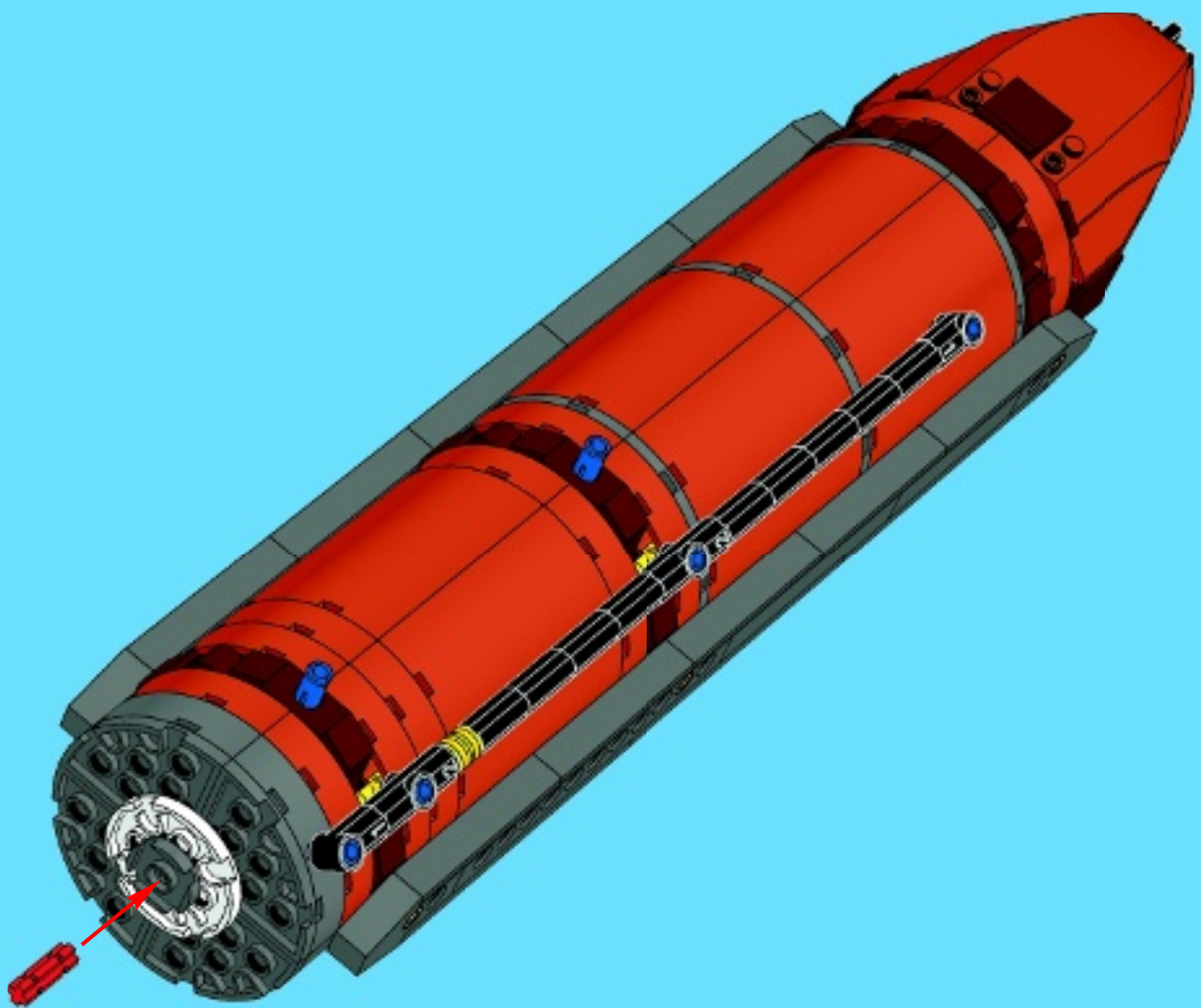

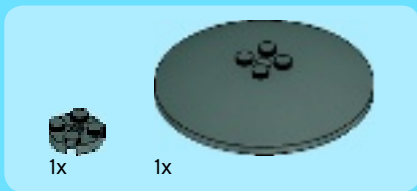

37

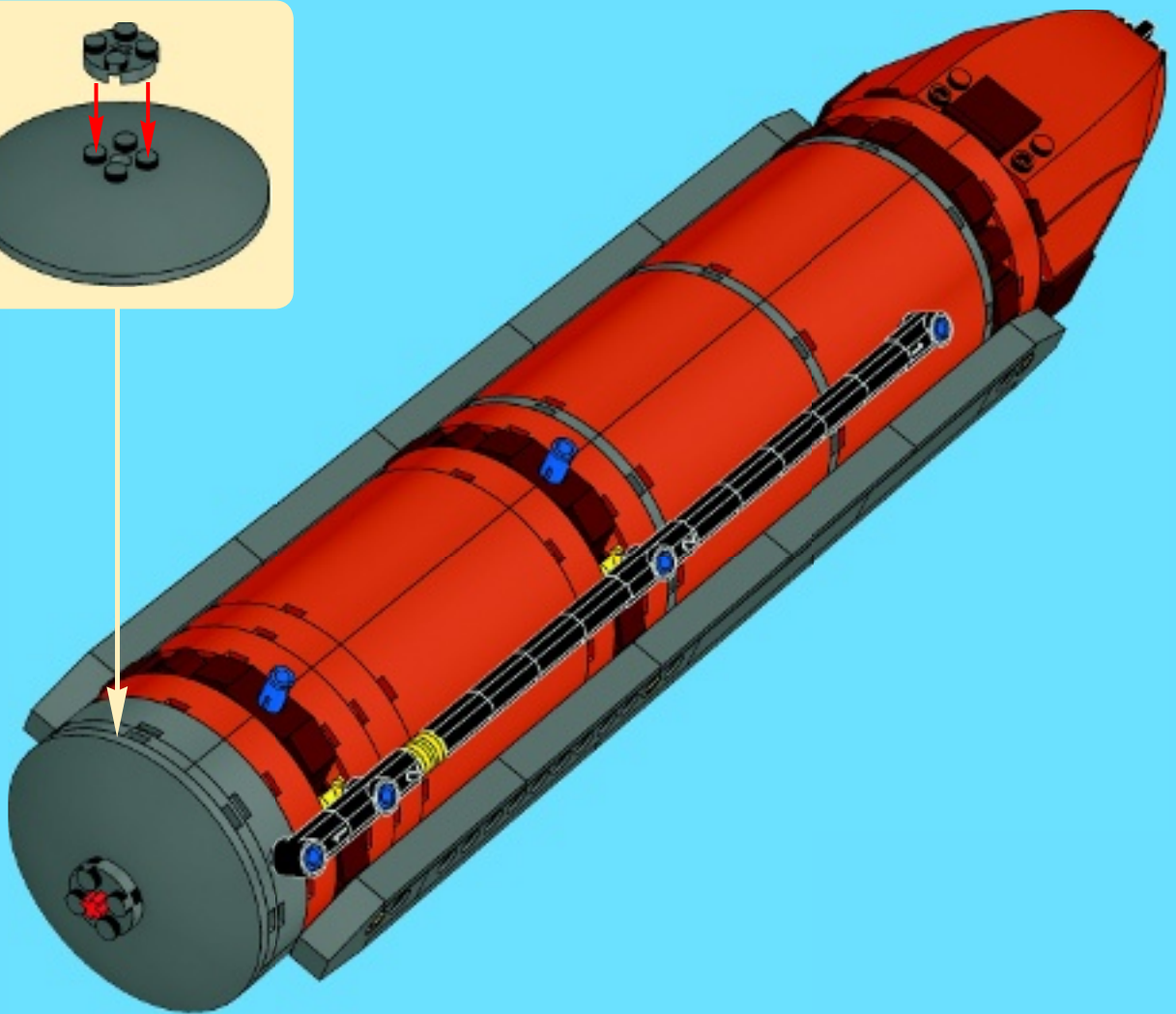
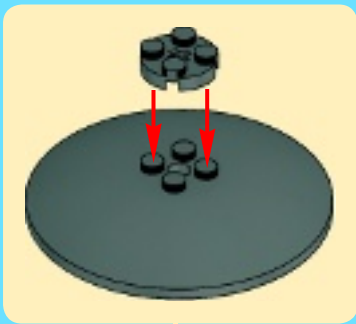

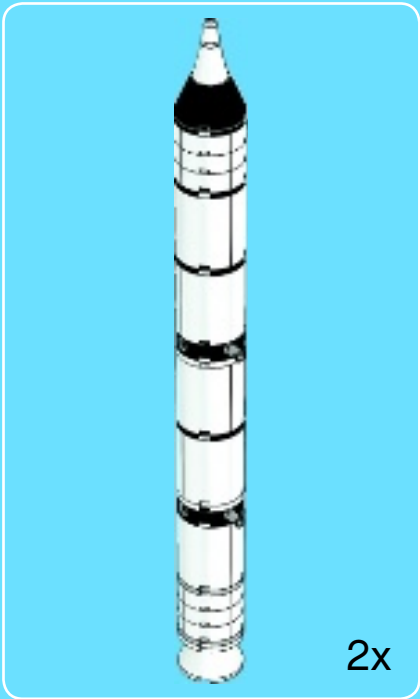

1



2

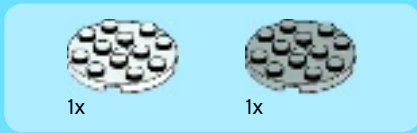

3

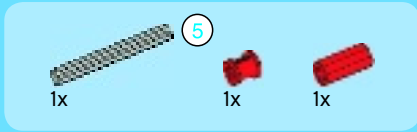
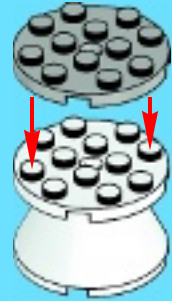

4

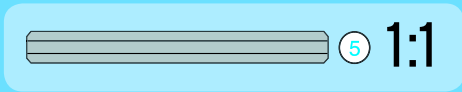
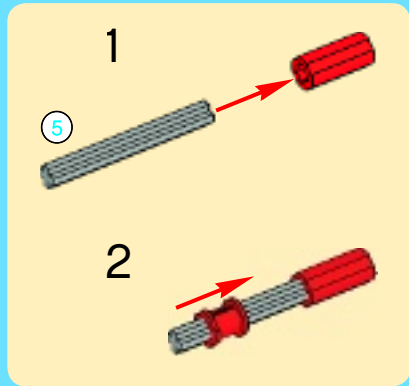



12x

5

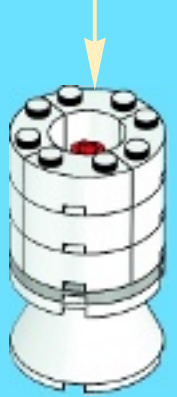
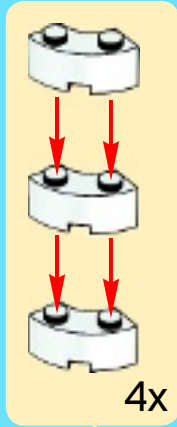

1x

6

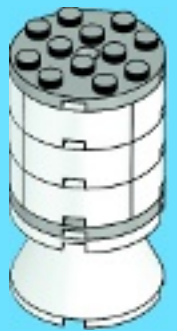

2x



1x

7



1x

8

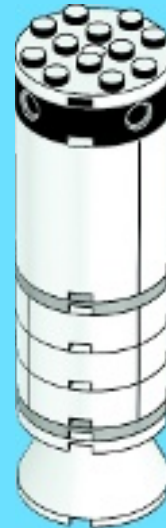

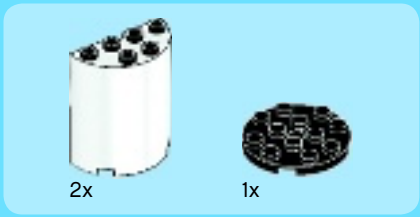

9

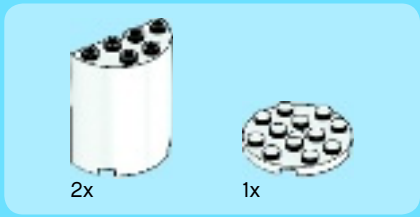

10



2x



1x

11

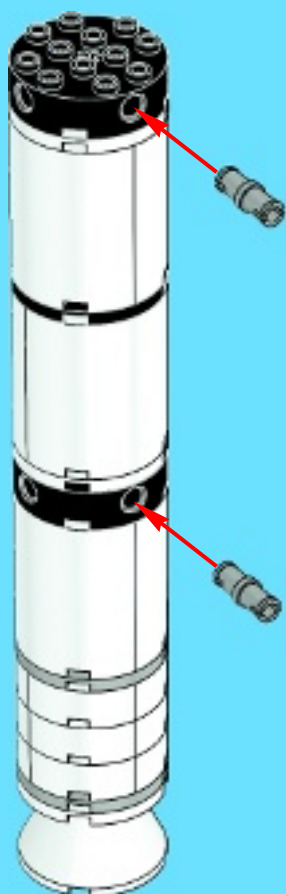

2x



1x

12



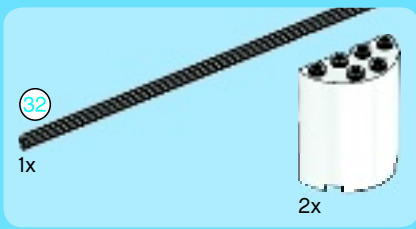

13

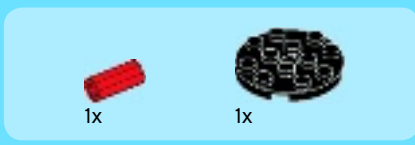

14







12x

15

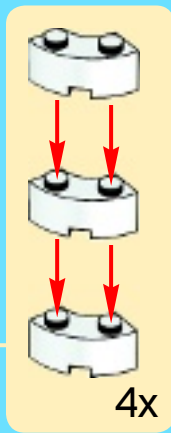

4x



1x



1x

16



6



6

1:1

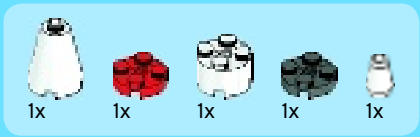

17

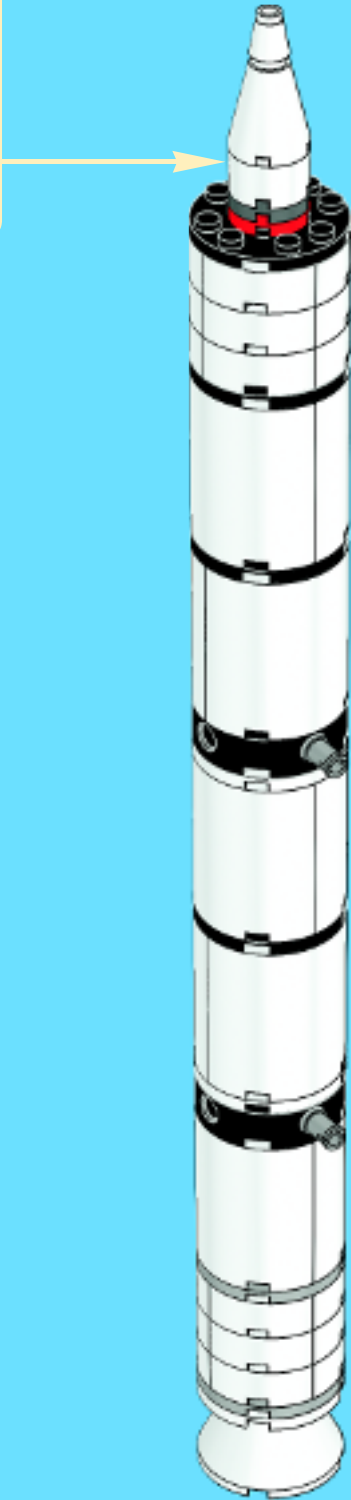
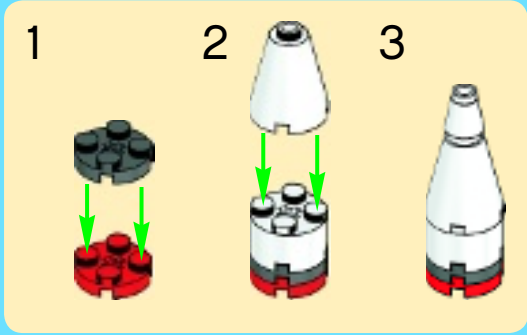



1x

18



2x

38

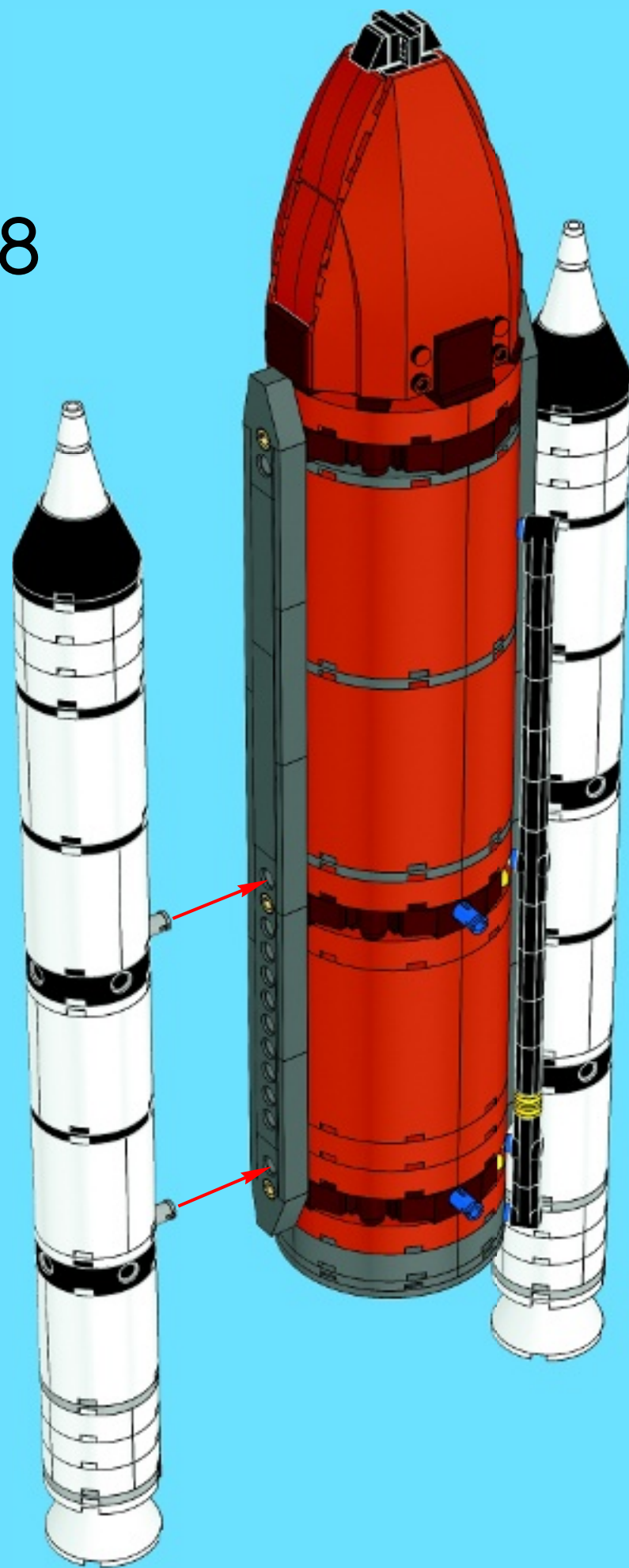

39

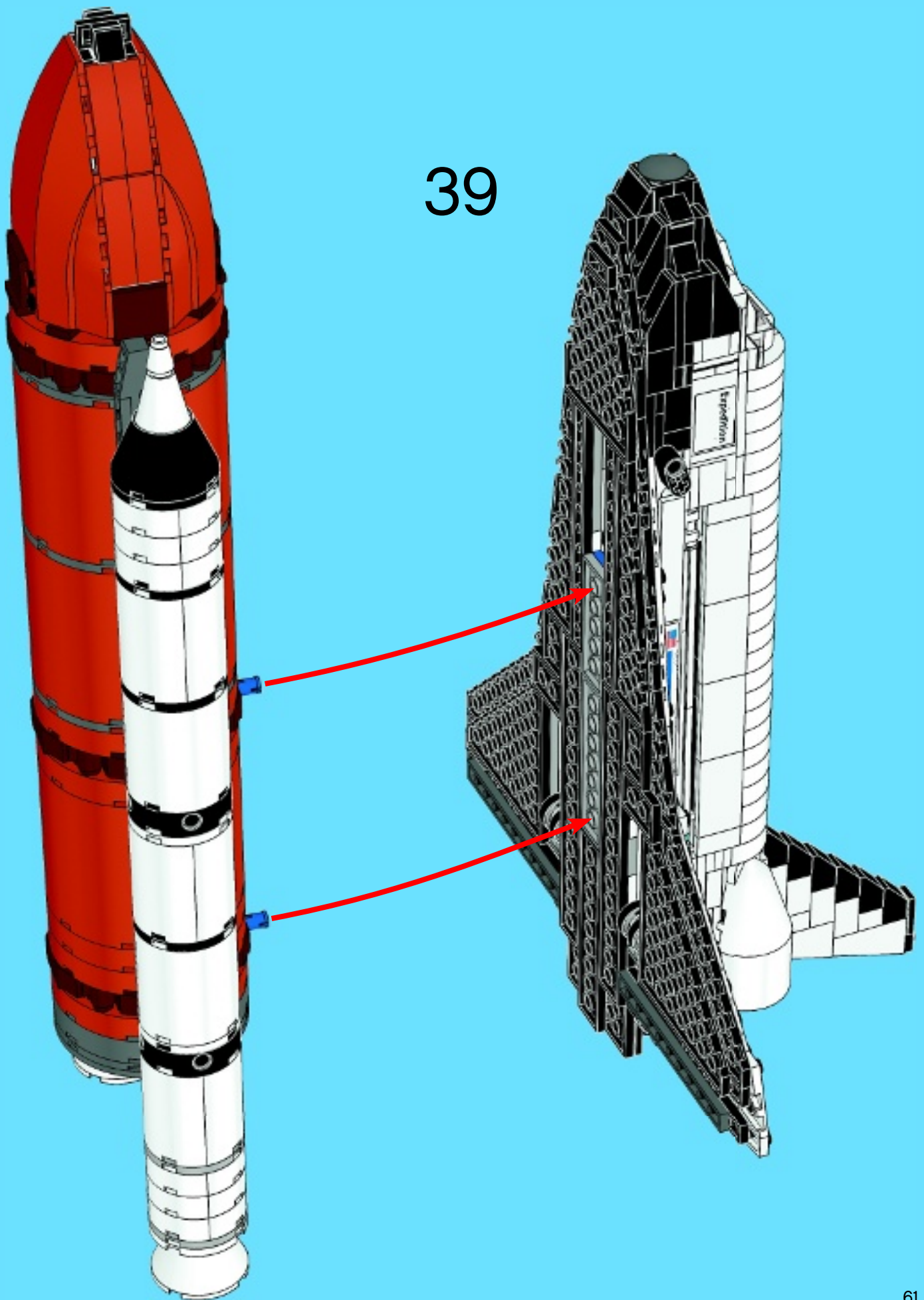

40

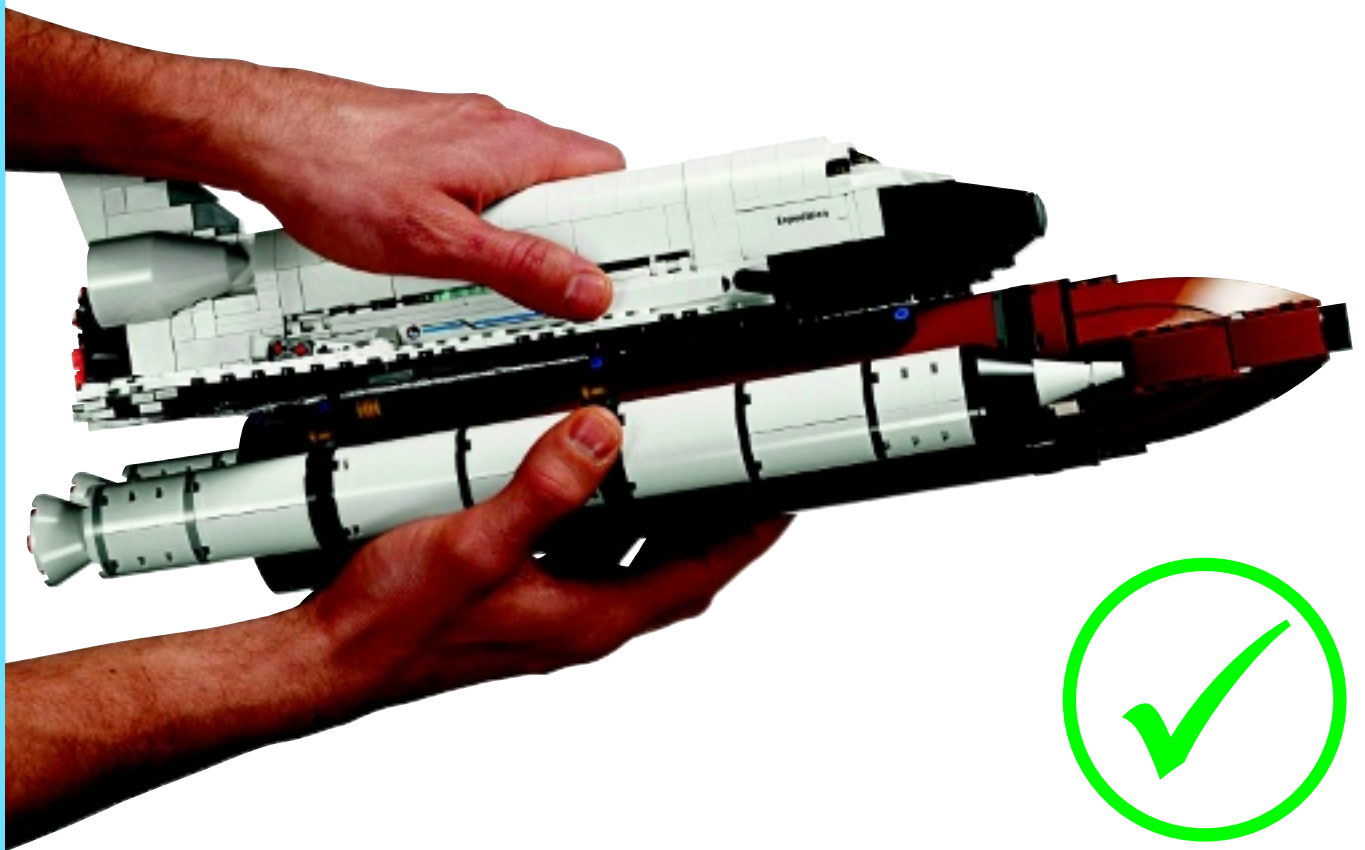

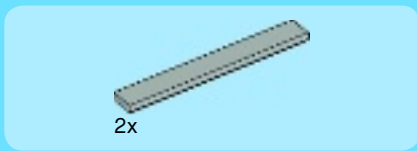
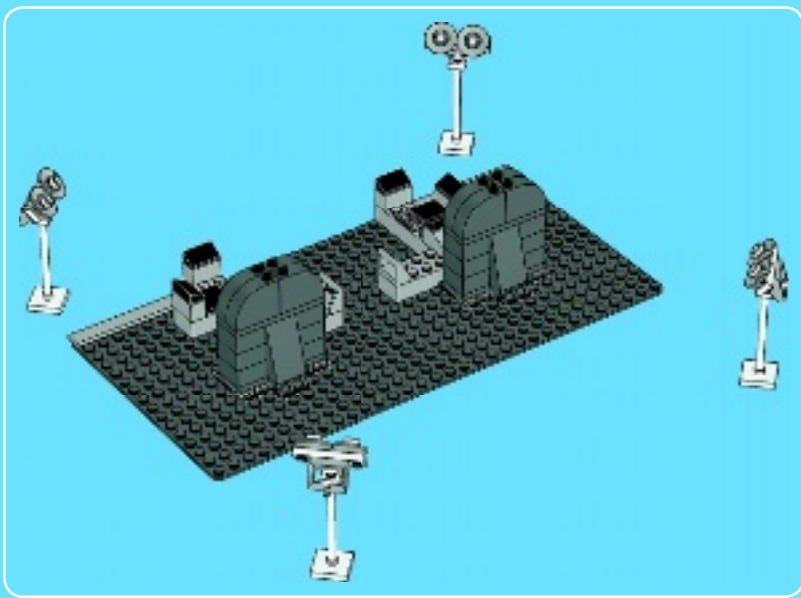

1

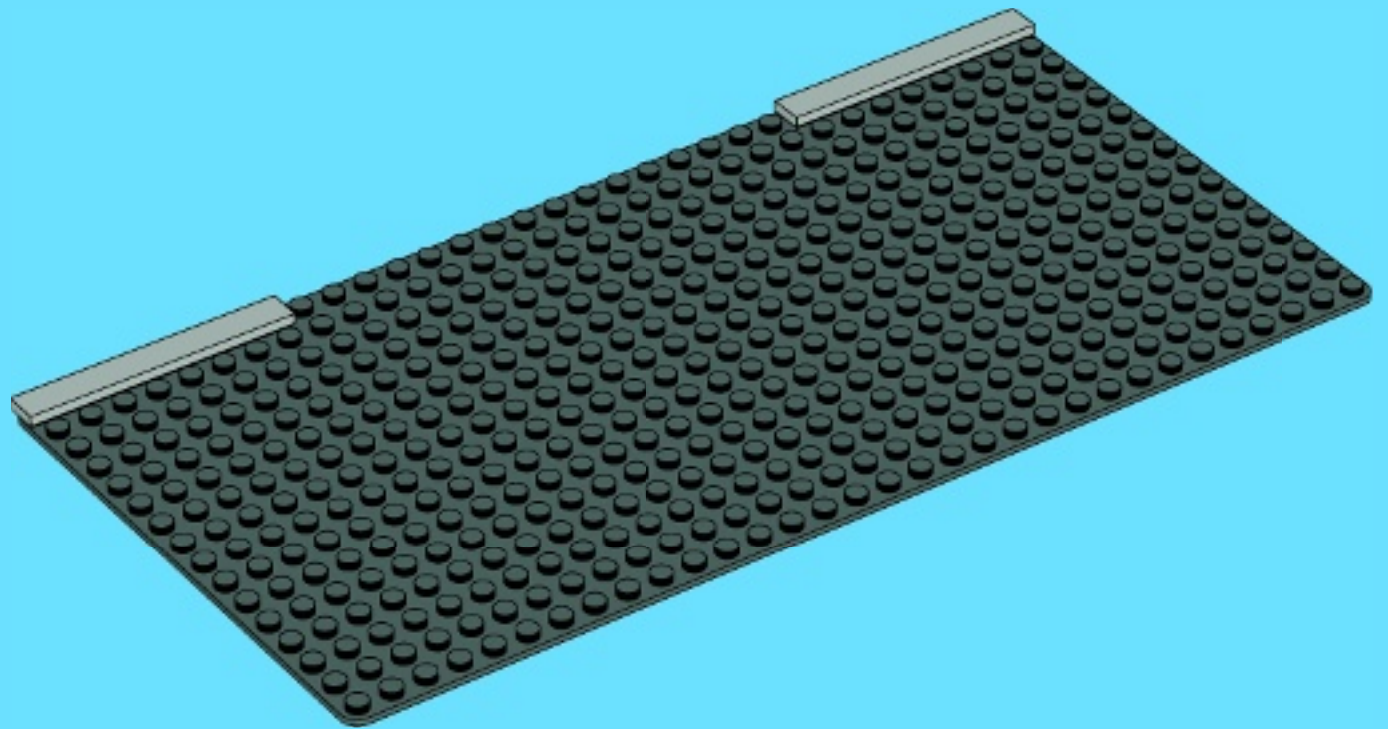



2x

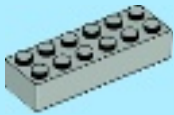

4x

2

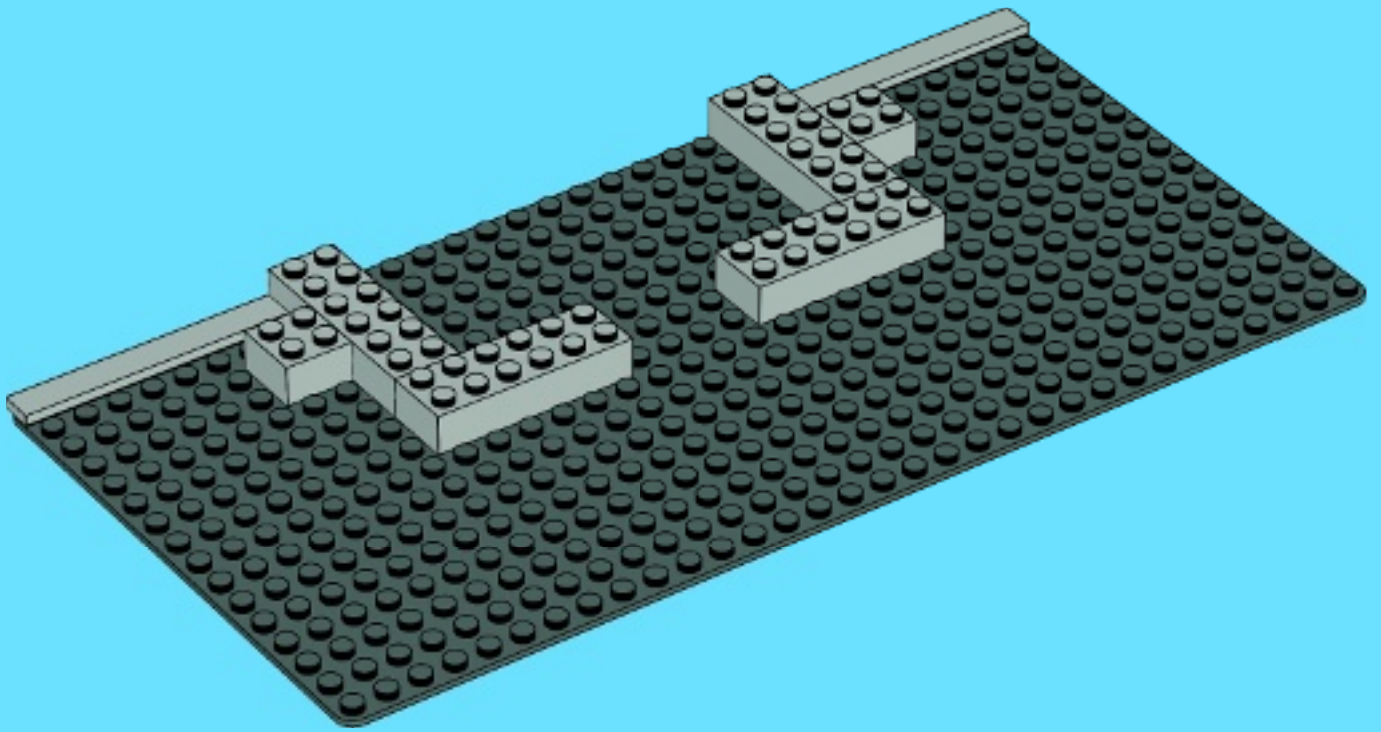





2x



2x



4x

3

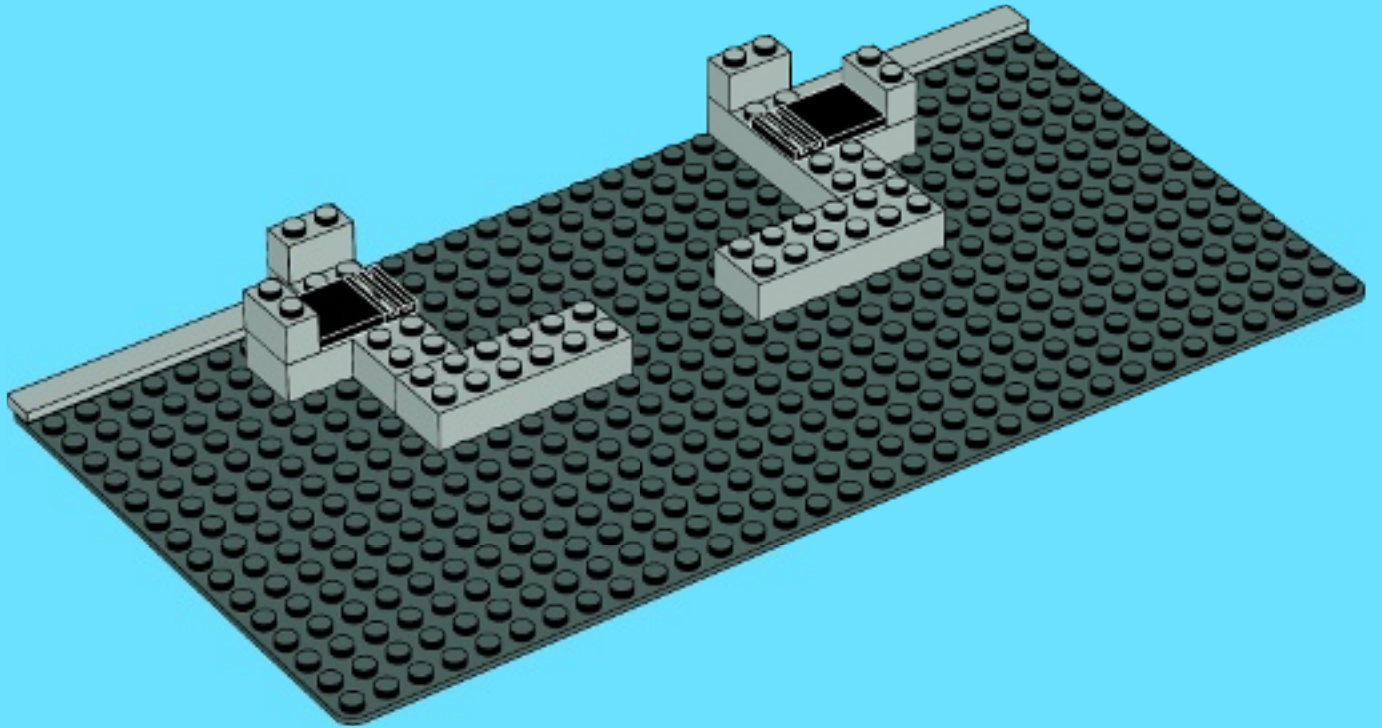



4x



16x



2x



2x

4

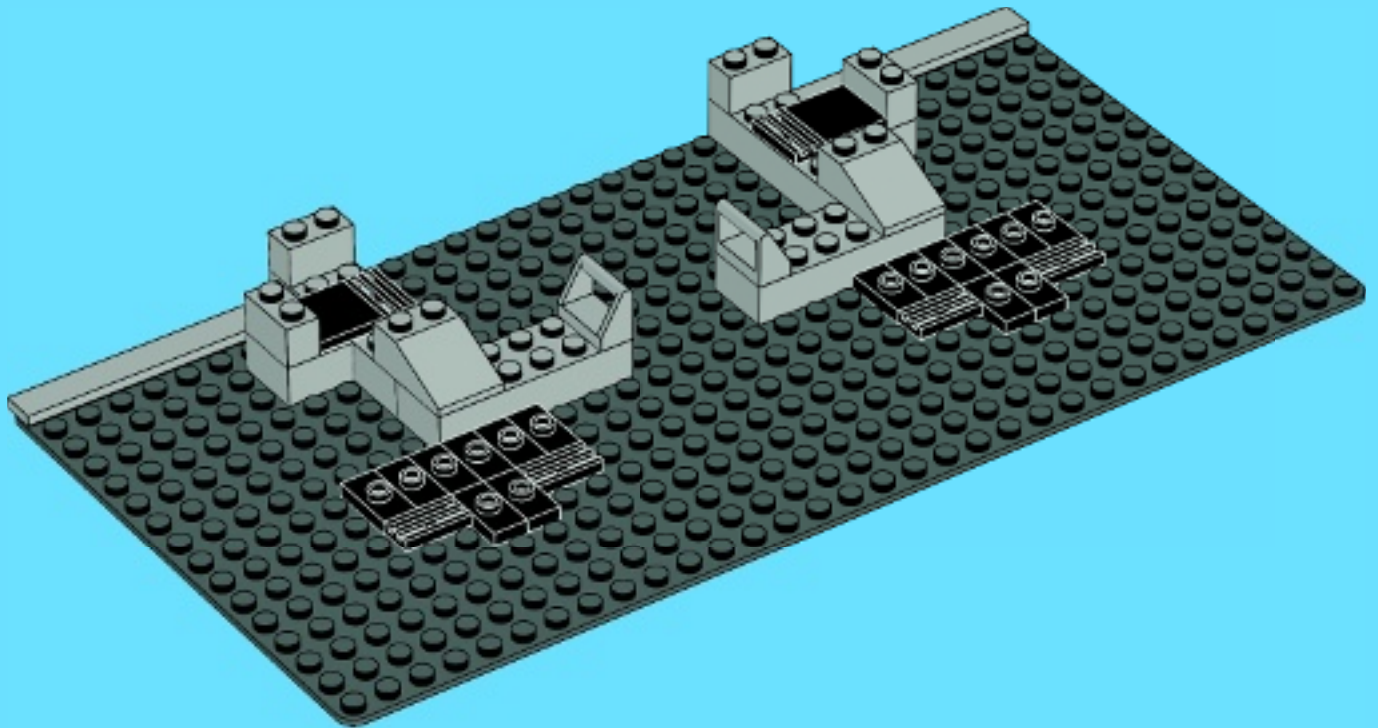



6x

5

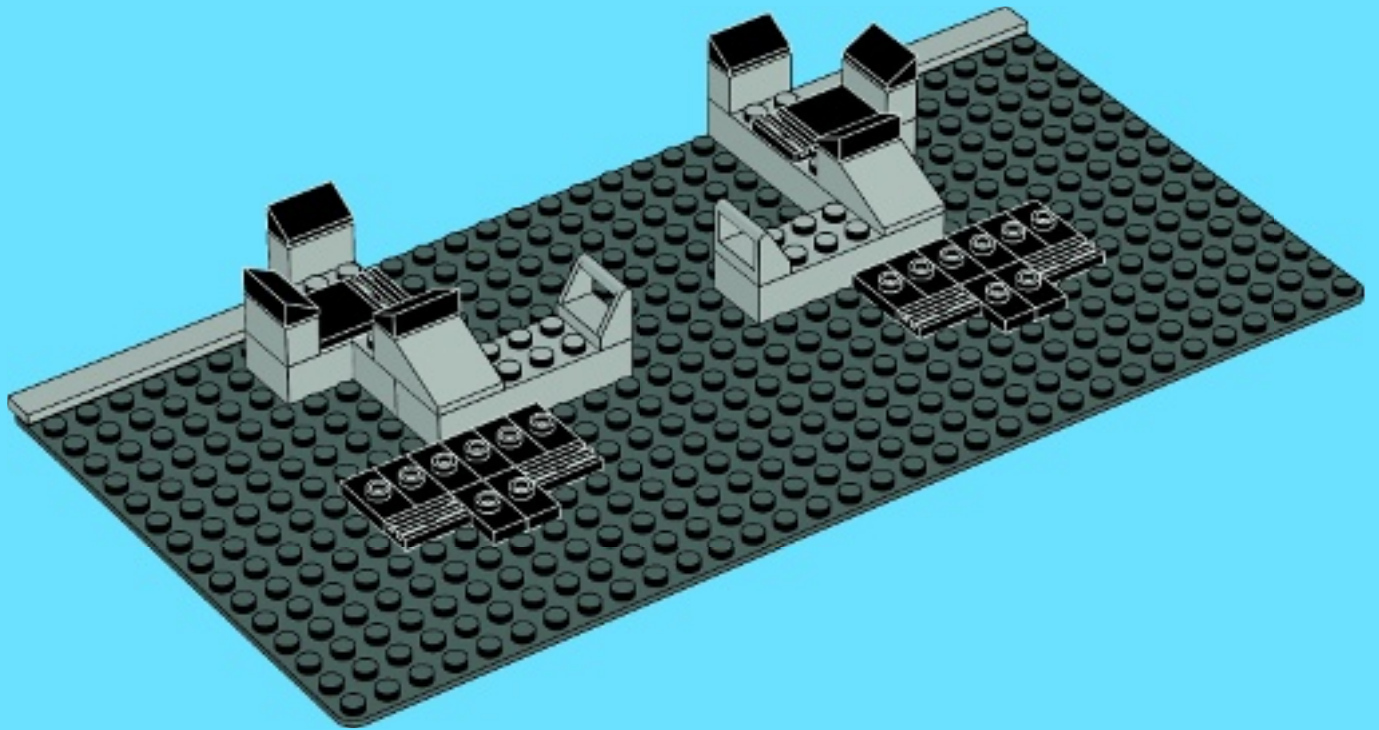

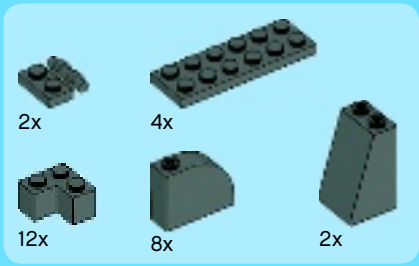

# 6

1



2



3

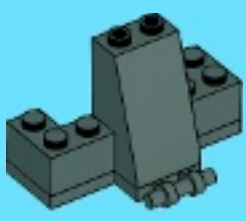

4

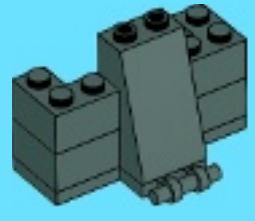

5



6

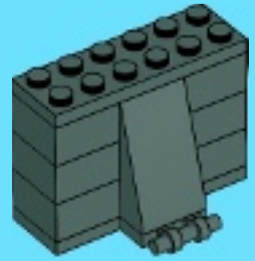

7



2x

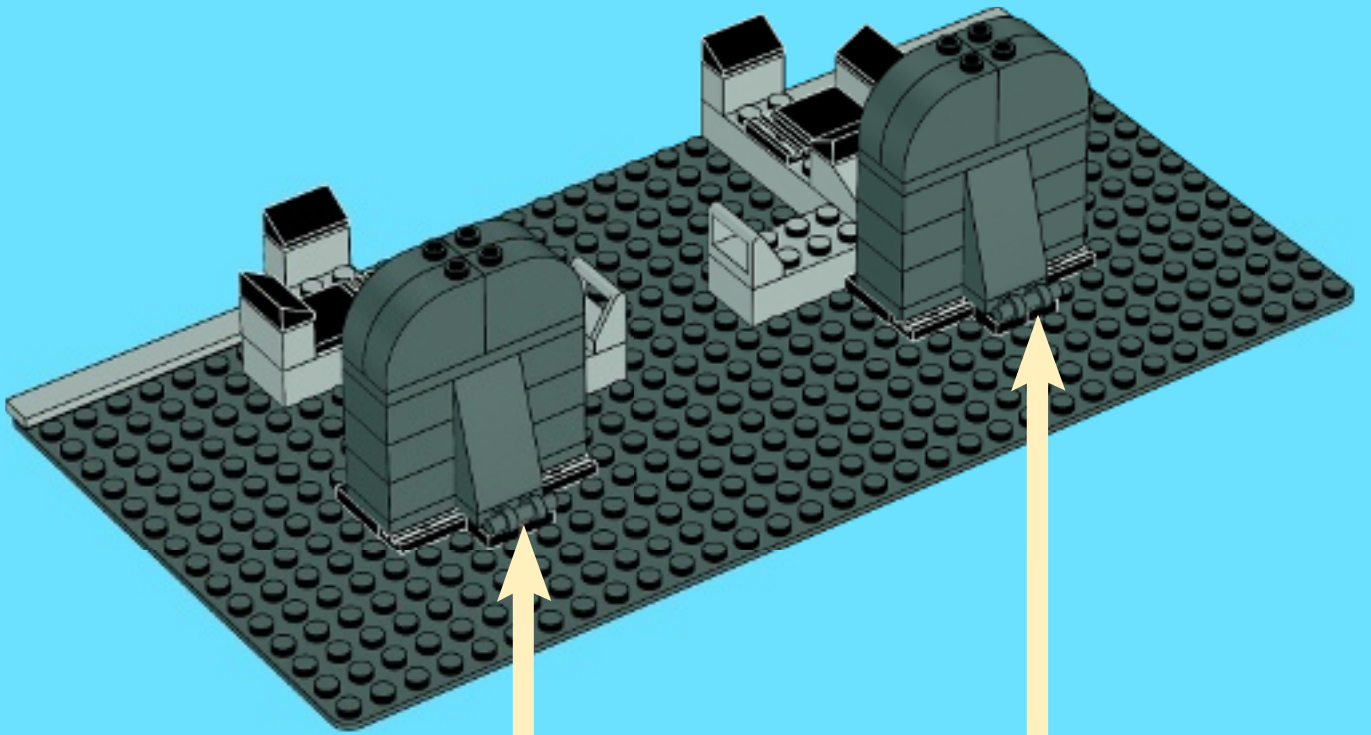

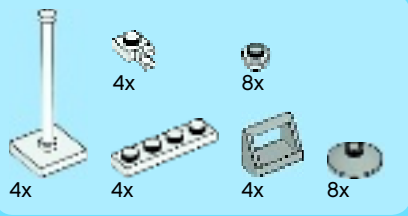

7

1

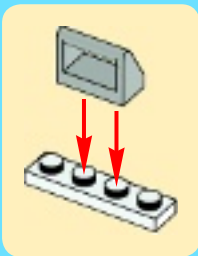

2



3

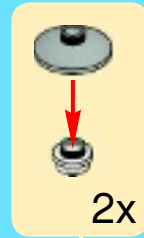

2x

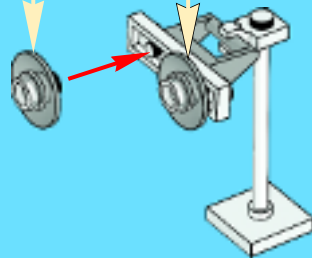

4



4x

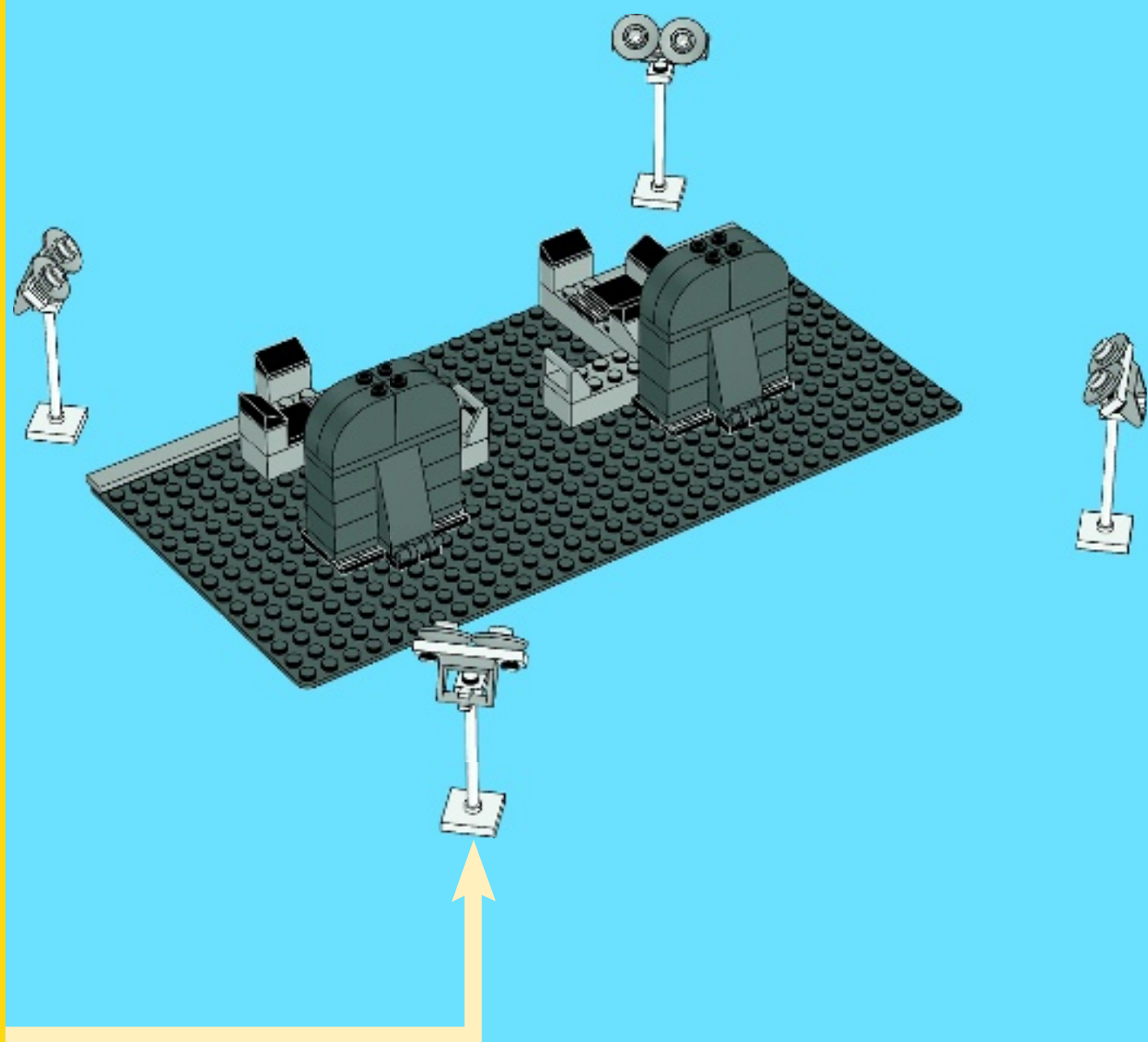

41

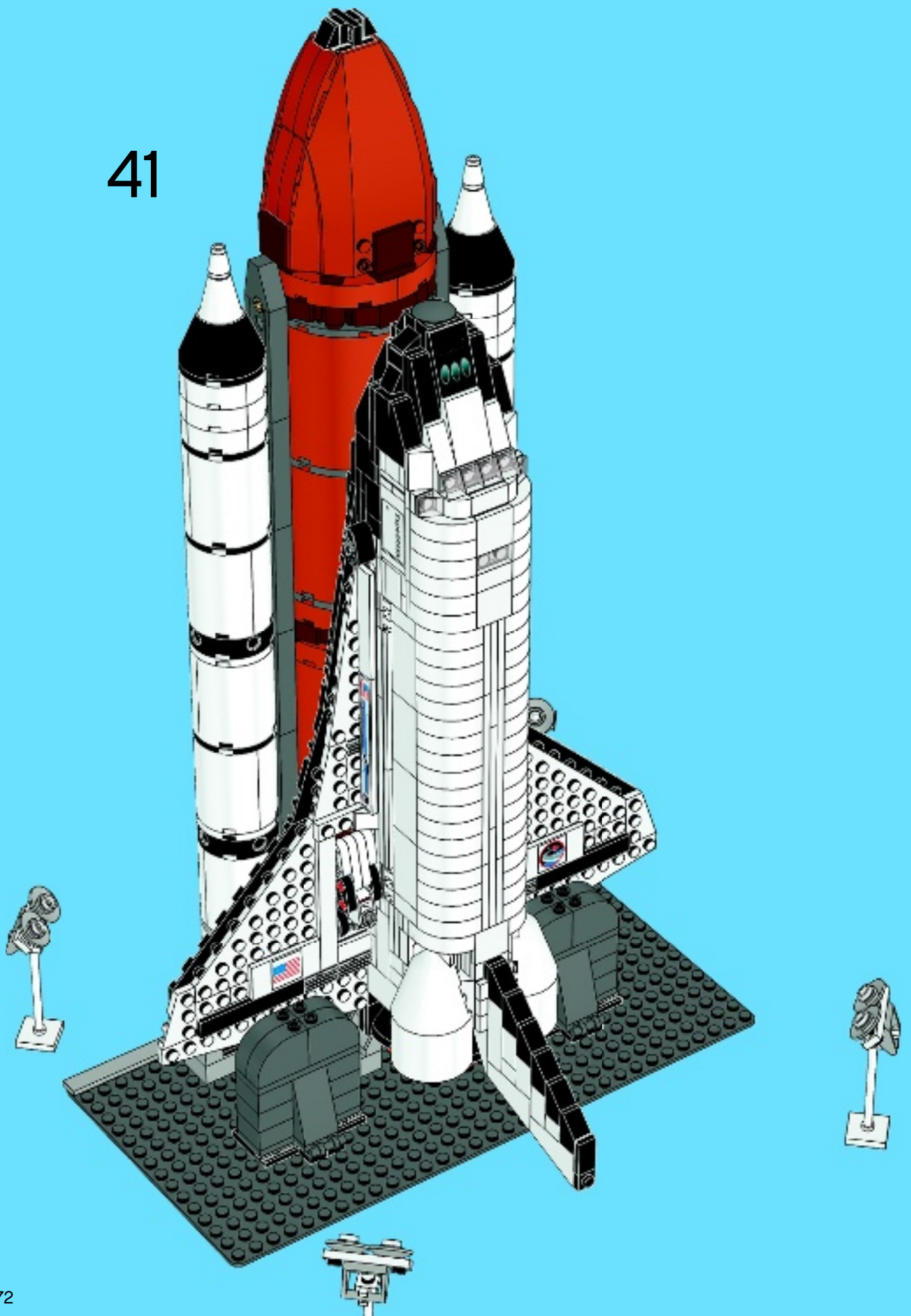



42

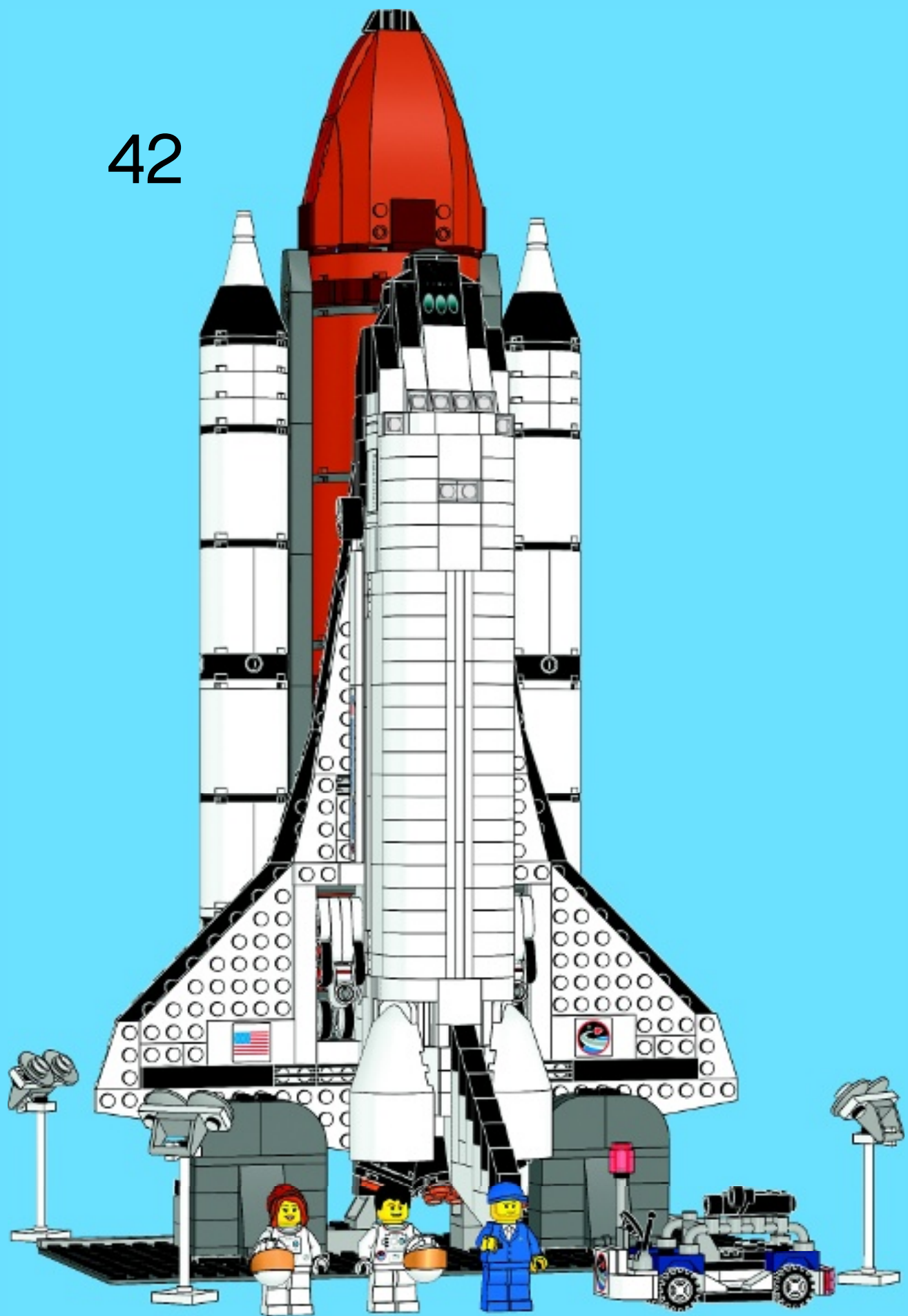

6x 300501  
5x 300401  
3x 301001  
2x 4518400  
48x 4567449  
3x 614301  
2x 394201  
1x 4194010  
2x 4288051  
3x 3200001  
5x 389401  
2x 273001  
6x 4504369  
4x 4547489  
2x 366501  
2x 4532972  
1x 428701  
2x 428601  
2x 4258358

1x 4143000  
6x 609101  
50x 4629913  
2x 4518992  
2x 307001  
12x 302401  
20x 302301  
13x 306901  
4x 306801  
13x 242001  
11x 302201  
4x 362301  
9x 302101  
16x 371001  
10x 4560178  
9x 366601  
6x 663601  
8x 379501  
6x 416201  
6x 447701

2x 4119227  
12x 4538353  
7x 379401  
8x 4598527  
2x 4615649  
2x 4556152  
4x 4222017  
2x 244401  
3x 4282737  
1x 4179874  
1x 4179875  
1x 4161326  
1x 4160857  
3x 474001  
2x 4208987  
2x 4209005

7x 4515347  
2x 4585737  
4x 4585448  
20x 4163987  
4x 4117032  
2x 9327  
2x 4654341  
2x 4298609  
10x 462401  
2x 4581453  
2x 4173670  
4x 4163533  
10x 4107826  
1x 4118981  
2x 4526981  
1x 4654049  
6x 4514554

6x 4277933  
4x 4515365  
2x 403221  
8x 4227155  
21x 4142865  
4x 4513174  
4x 4583862  
4x 370923  
1x 9341  
1x 4287488  
1x 4567909  
6x 4186834  
12x 4143005  
9x 4206482  
2x 4514553  
2x 4262786  
4x 4256320  
1x 4261572  
1x 4506727  
1x 4651443  
4x 4112289  
4x 4239601

2x 300526  
 2x 300426  
 3x 4113241  
 2x 300226  
 10x 407026  
 1x 4162235  
 2x 394226  
 3x 4500978  
 4x 4290056  
 2x 4550922  
 8x 4504382  
 6x 4121966  
 7x 4548180  
 6x 428726  
 2x 428626  
 2x 4515362  
 1x 4185583  
 2x 302426  
 2x 306926

24x 302326  
 5x 306826  
 4x 302226  
 2x 362326  
 10x 302126  
 7x 366626  
 4x 663626  
 7x 379526  
 1x 303226  
 1x 395826  
 2x 383226  
 2x 4514845  
 2x 428226  
 2x 4632571  
 4x 4515340  
 17x 379426  
 18x 241226  
 1x 244126

1x 4161332  
 1x 4160869  
 1x 4283047  
 2x 4209003  
 1x 4283046  
 2x 4209013  
 8x 4515350  
 2x 4550190  
 4x 4205347  
 2x 4106347  
 2x 486526  
 2x 4233937

1x 4538722  
 1x 436026  
 4x 4578677  
 6x 4516843  
 1x 4159335  
 1x 4213374  
 2x 4155558  
 3x 4515185  
 3x 4610371  
 2x 4107783  
 2x 4107085  
 9x 4121715  
 9x 4512363  
 2x 370626  
 1x 370726  
 1x 373726  
 2x 4142622



24x  
4654110



8x  
4582992



2x  
4582987



2x  
4582984

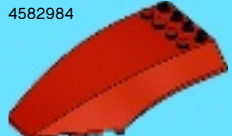

2x  
4654114



12x  
4654111



1x  
4614107



2x  
4654119



8x  
3005740



3x  
3006841



2x  
4244363

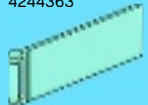

2x  
4508534



4x  
4144387



7x  
4260426



22x  
3005747



6x  
4244368



1x  
4529685



7x  
4211210



24x  
4225469



10x  
4211183



16x  
4211252



24x  
4504376



24x  
4221744



4x  
4211288



4x  
4211151



4x  
4271949



3x  
4610666



6x  
4211388



4x  
4211387

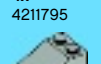

10x  
4211385

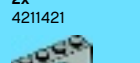

4x  
4211795



2x  
4211421



3x  
4211435



2x  
4212363



1x  
4654046

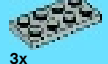

3x  
4211395



2x  
4211481

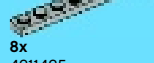

8x  
4211425



1x  
4211408



2x  
4211840



2x  
4211542



1x  
4211449



2x  
4211525



1x  
4221881



8x  
4211512



4x  
4515351



7x  
4211357



2x  
4211524



1x  
4221775



1x  
4211473



3x  
4519013



1x  
4226995



1x  
4520320



4x  
4211807



7x  
4211815



2x  
4211639



16x  
4211109



2x  
4211100



2x  
4211099



1x  
4225975



4x  
4535931



4x  
4273814



2x  
4210963



2x  
4210696



8x  
4654039



1x  
4493478



10x  
4210651



3x  
4243831

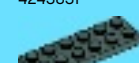

4x  
4211002



8x  
4257526



3x  
4543086



3x  
4210660



7x  
4211042



1x  
4278274



1x  
4210865



16x  
4222042

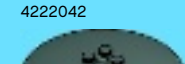

1x  
4268409



2x  
4505182



1x  
4535553

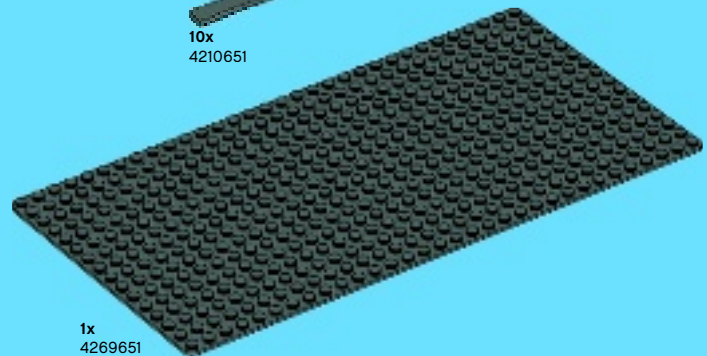

1x  
4269651



**Customer Service**  
**Kundenservice**  
**Service Consommateurs**  
**Servicio Al Consumidor**  
[www.lego.com/service](http://www.lego.com/service) or dial

00800 5346 5555 :     

1-800-422-5346 :  



10211

10197

10135



10220



**LEGO club**™

**FREE! GRATIS! GRATUIT!**



[www.LEGOclub.com](http://www.LEGOclub.com)



**LEGO® Club Magazine**



**LEGO® Club Email**

**SIGN UP ONLINE!**

[www.LEGOclub.com](http://www.LEGOclub.com)

VISIT THE WORLD'S  
BIGGEST LEGO® SHOP!

[www.LEGOshop.com](http://www.LEGOshop.com)

GO TO  
[www.LEGOclub.com](http://www.LEGOclub.com)

00800 5346 5555\*

1-866-534-6258 • 1-877-518-5346

US & Canada only

Canada seulement



\* Freephone. Mobile charges may apply. \* Numéro sans frais. Des frais peuvent s'appliquer avec les téléphones cellulaires. \* Gebührenfrei, Kosten für Anrufe aus Mobilfunknetzen können abweichen. \* Gratis telefoonnummer vanaf vaste lijn. \* Det er et gratis nummer, når du ringer fra fasttelefon. \* Det är gratis, när du ringer från en fast telefon. \* Numéro sans frais. Des frais peuvent s'appliquer avec les téléphones portables.



# WIN!

Go to [www.LEGOsurvey.com/product](http://www.LEGOsurvey.com/product) to fill out a survey for a chance to win a cool LEGO® Product. No purchase necessary. Open to all residents where not prohibited.

 [www.LEGO.com](http://www.LEGO.com)



# [www.LEGOsurvey.com/product](http://www.LEGOsurvey.com/product)

## GEWINNE!

Nimm an der Umfrage auf [www.LEGOsurvey.com/product](http://www.LEGOsurvey.com/product) teil und hab die Chance ein cooles LEGO® Produkt zu gewinnen!

Die Teilnahme am Gewinnspiel führt zu keinerlei Kaufverpflichtungen. Teilnahme in allen nicht ausgeschlossenen Ländern möglich.

## WIN!

Ga naar [www.LEGOsurvey.com/product](http://www.LEGOsurvey.com/product), vul een enquêteformulier in en maak kans op een cool LEGO® product.

Geen aankoopverplichting. Iedereen mag deelnemen, uitgezonderd ingezetenden van landen waar een enquêteverbod geldt.

## GAGNE!

Visite [www.LEGOsurvey.com/product](http://www.LEGOsurvey.com/product) pour répondre à un questionnaire et avoir une chance de gagner un produit LEGO® très cool!

Aucune obligation d'achat. Ouvert à tous les résidents des pays autorisés.

## 当てよう!

[www.LEGOsurvey.com/product](http://www.LEGOsurvey.com/product) にアクセスして、アンケートにご記入ください。当選者にはレゴ®製品を差し上げます。

お買い上げの必要はありません。禁止されていない限り、すべての皆様にご利用いただけます。