



# NINJAGO

Masters of Spinjitzu



2508



1

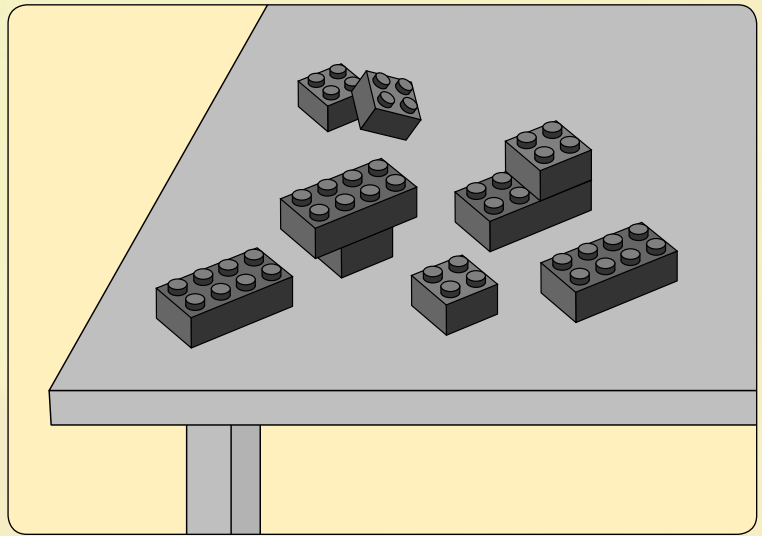
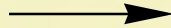
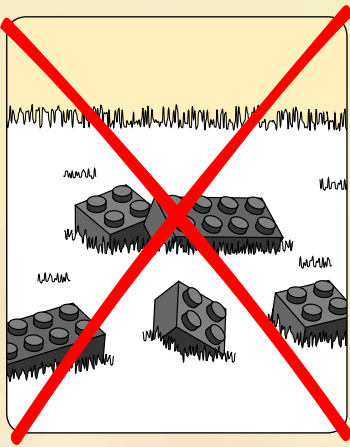

2

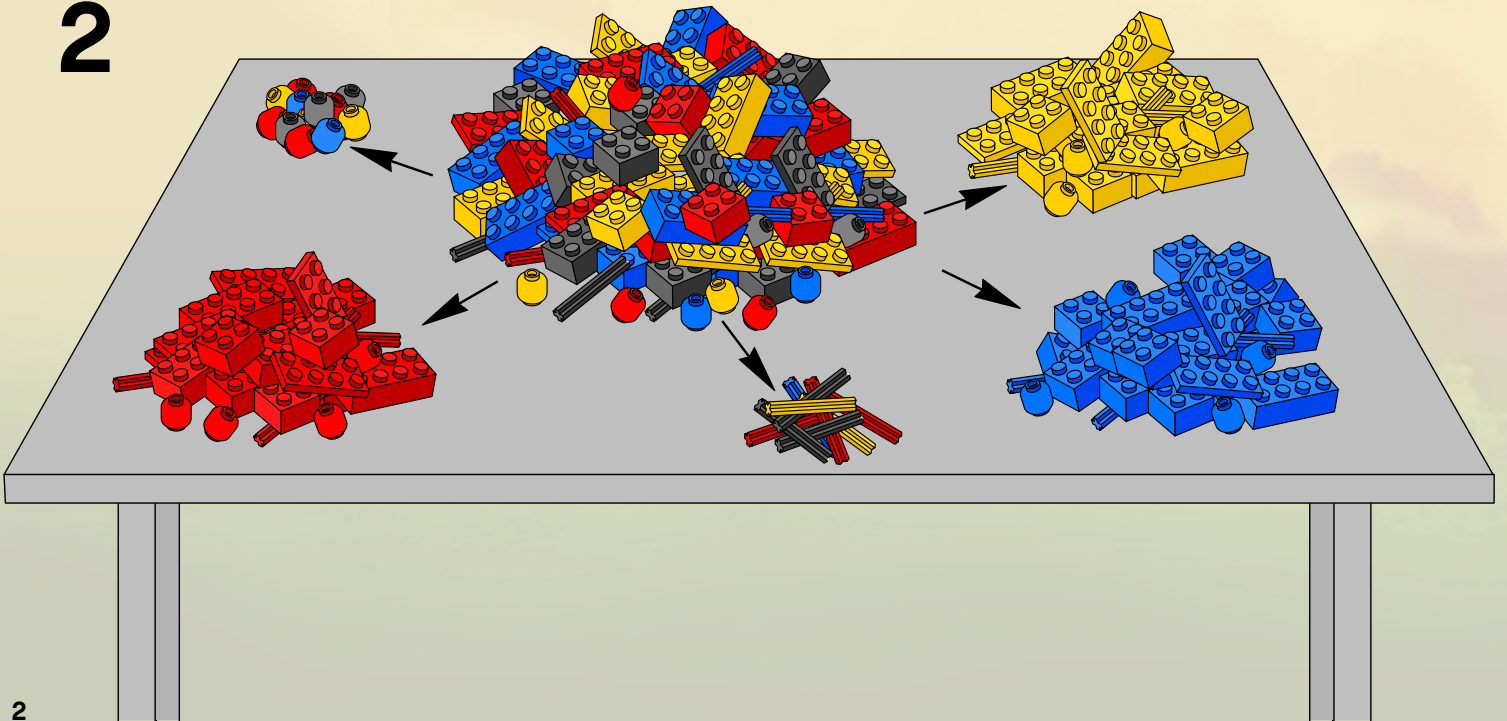

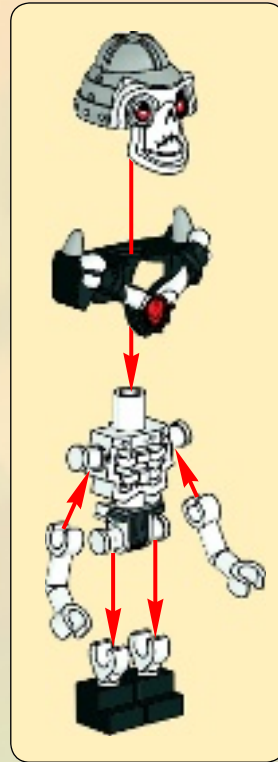
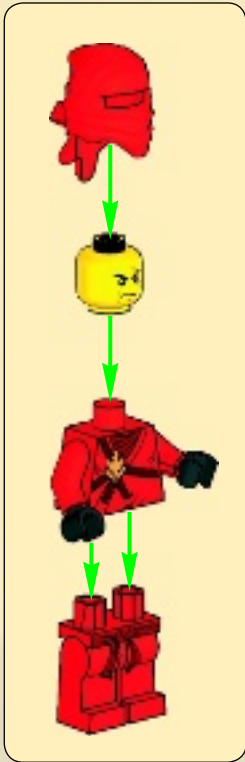

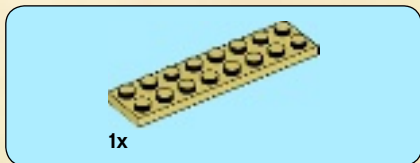
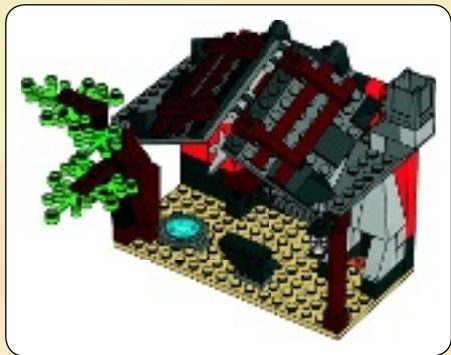

1

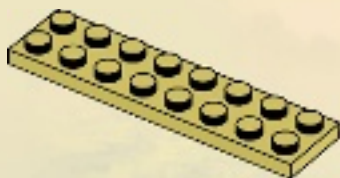

2

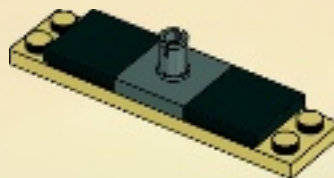



3

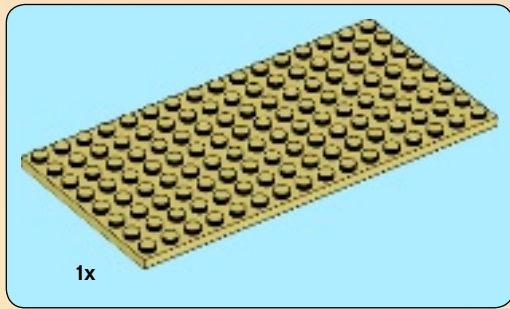
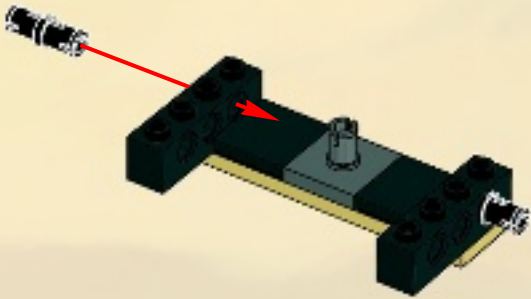

4

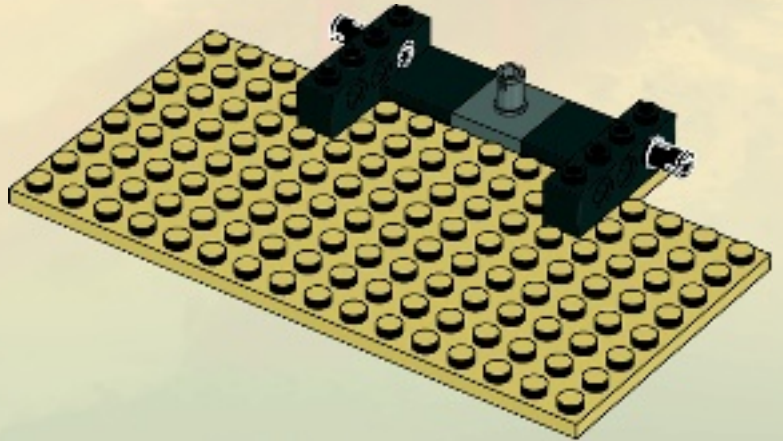



5

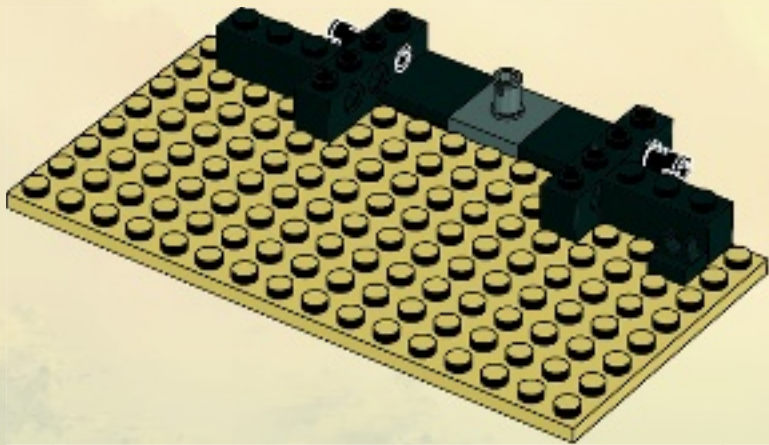



2x



1x

# 6

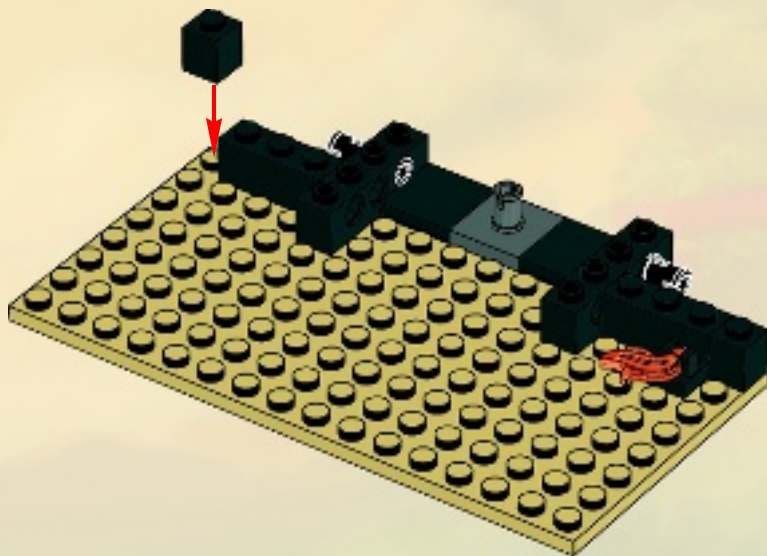



2x

7

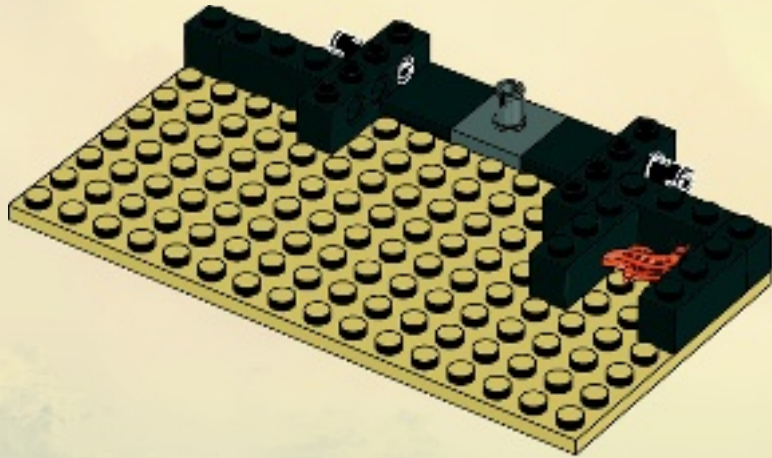

8





2x



2x

8

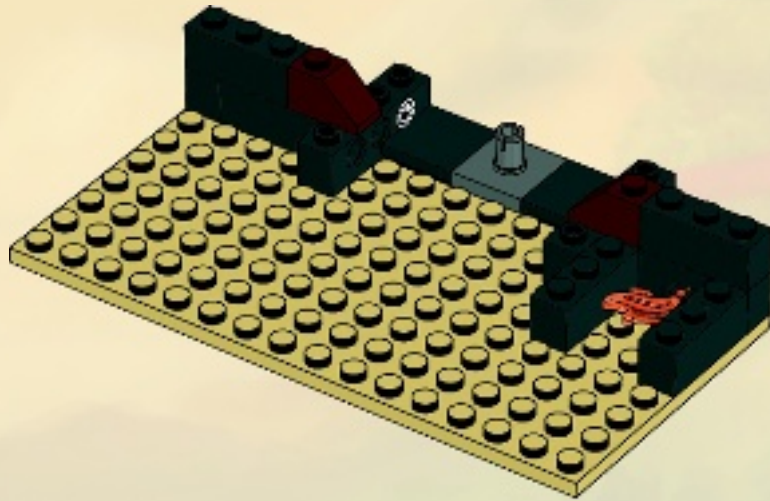



12x

9

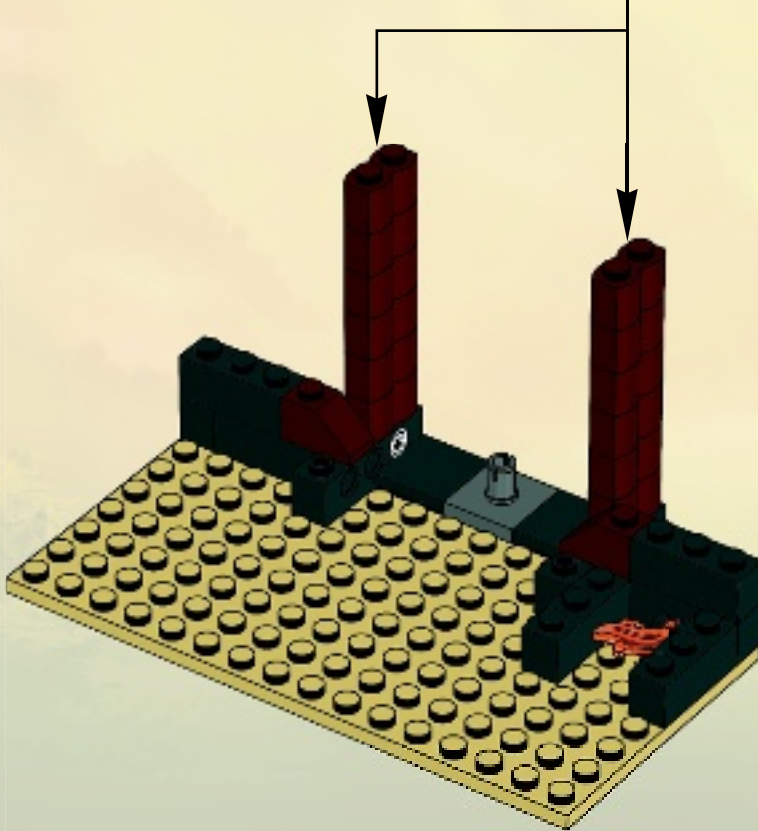
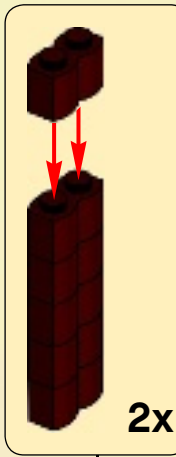

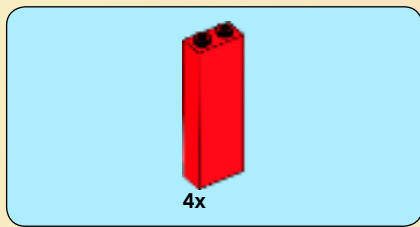

10

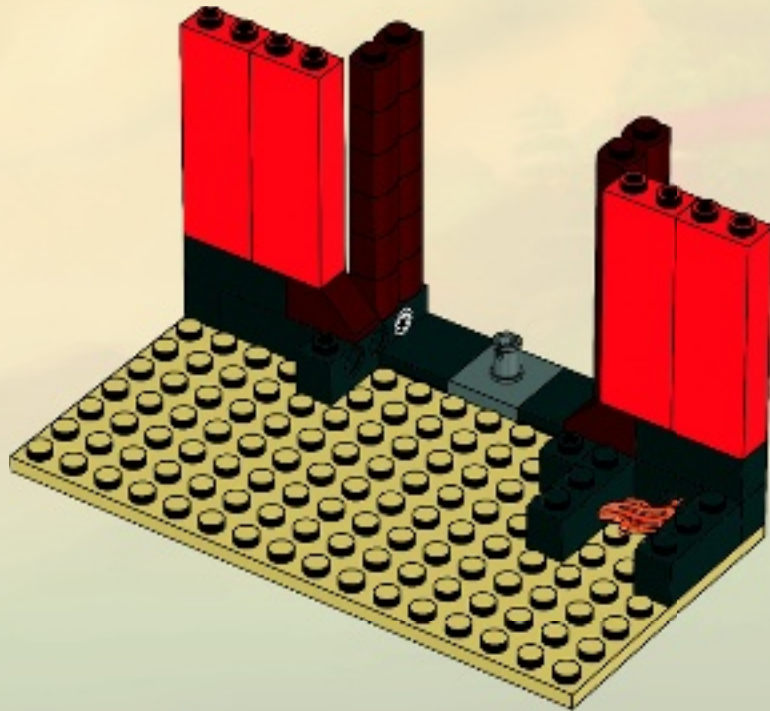

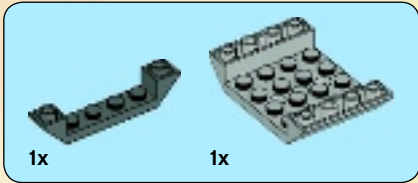

**1**

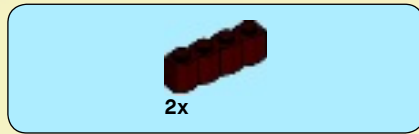
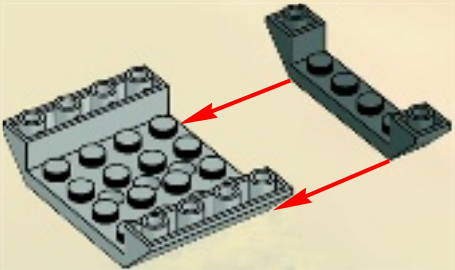

**2**

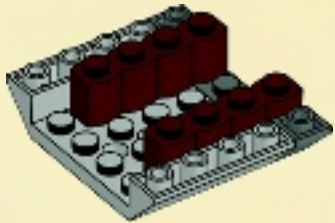

**3**

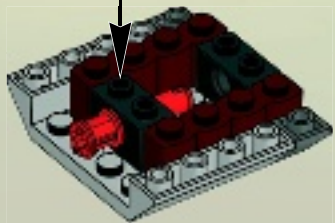
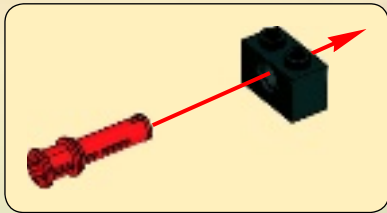

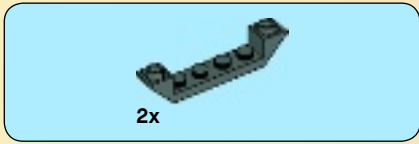

4

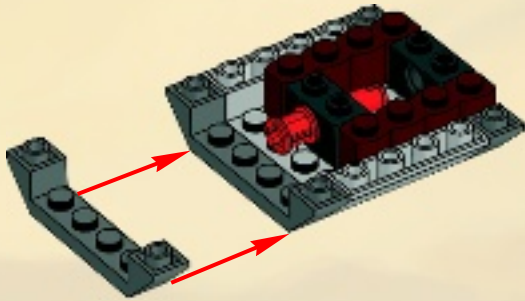

5

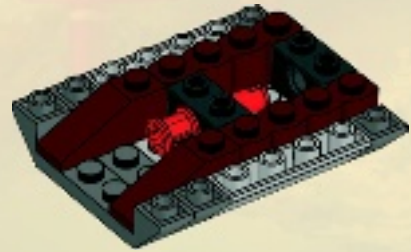

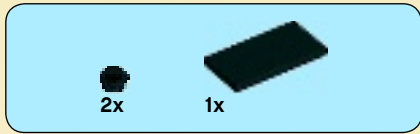

6

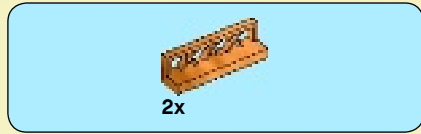
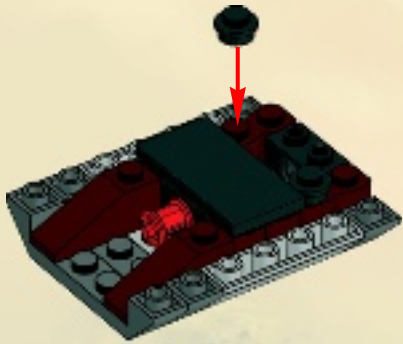

7

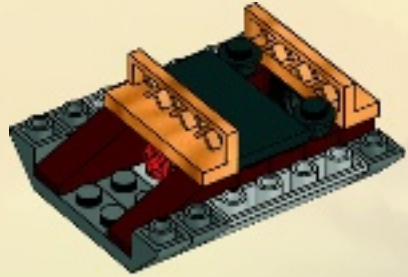



8

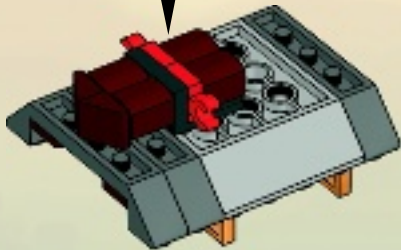
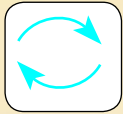
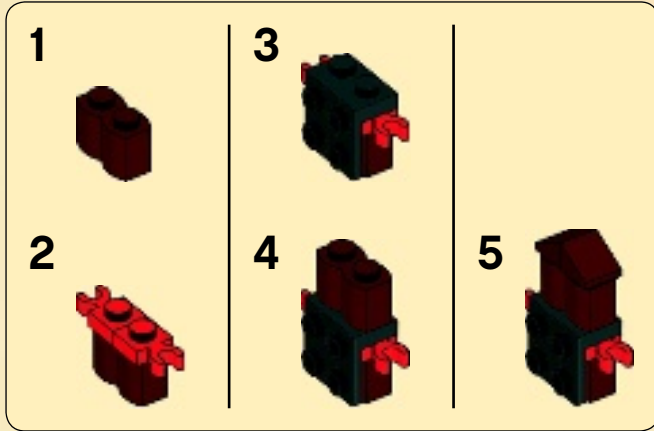

9

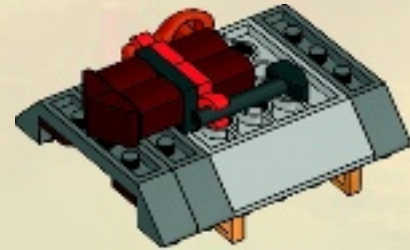

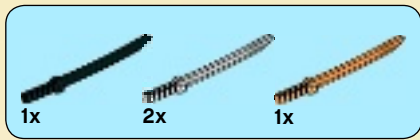

10

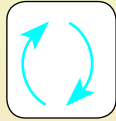

11

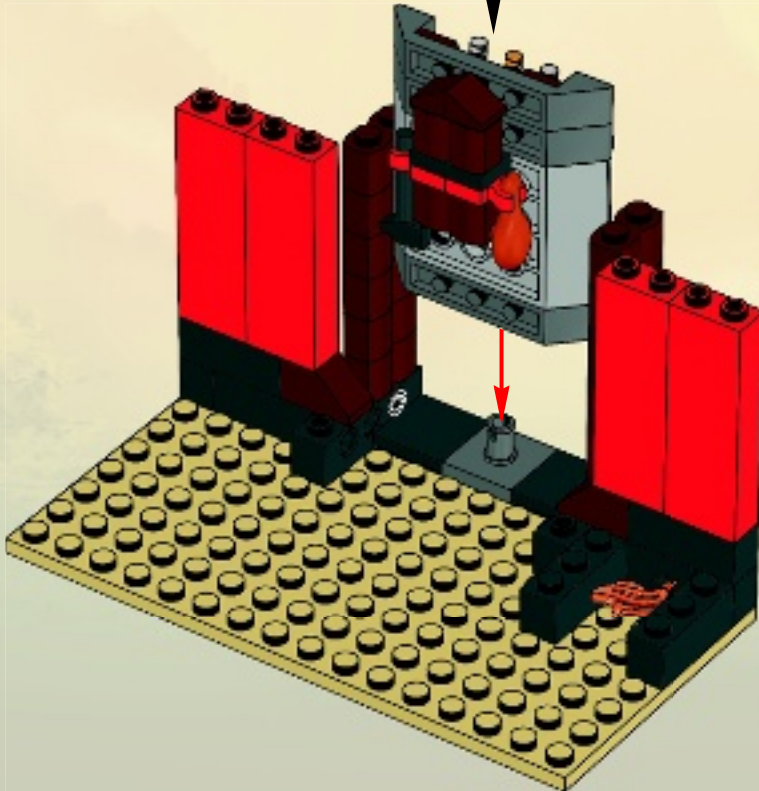



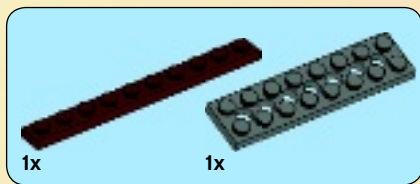

12

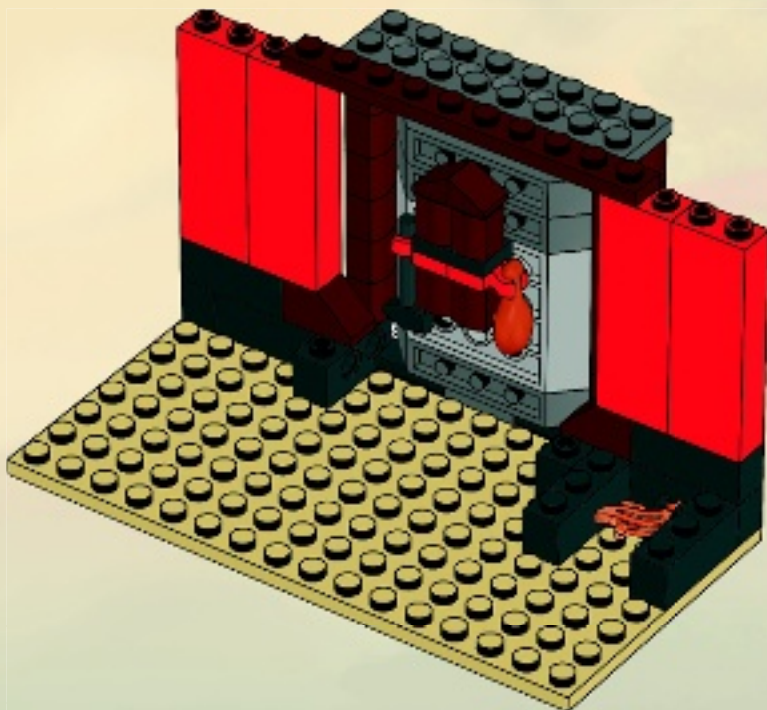

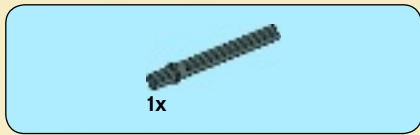

# 13

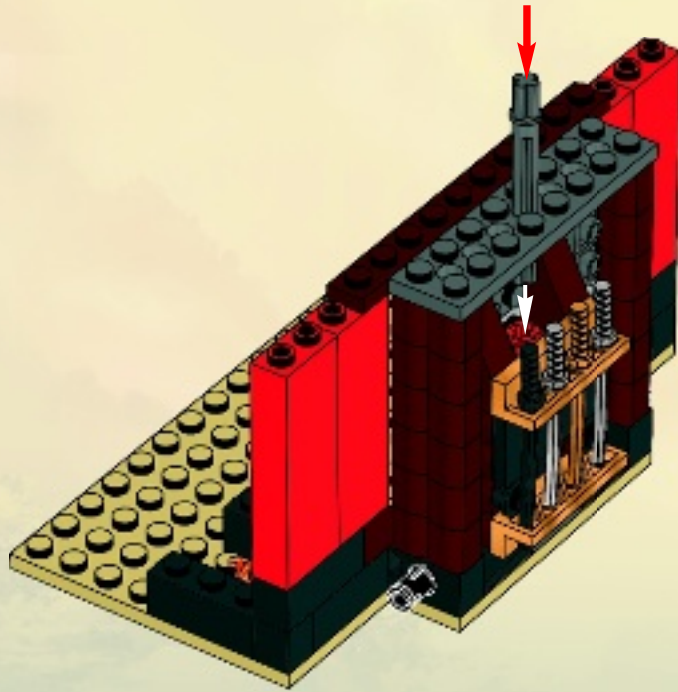
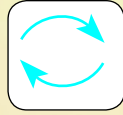



2x



2x

# 14

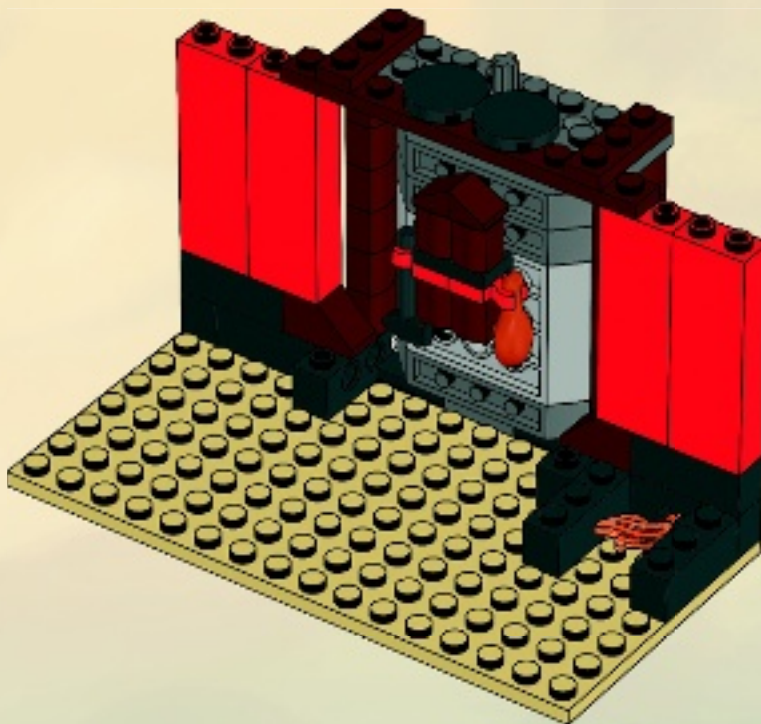
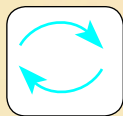



4x



1x

# 15

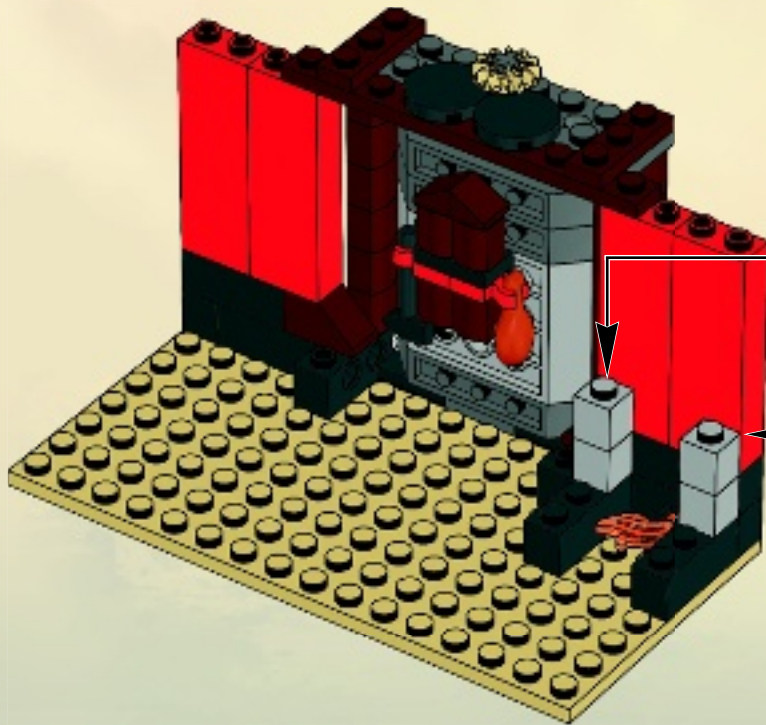

2x

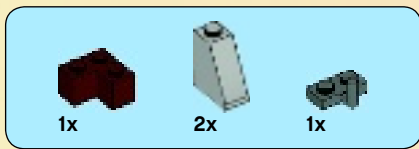

16

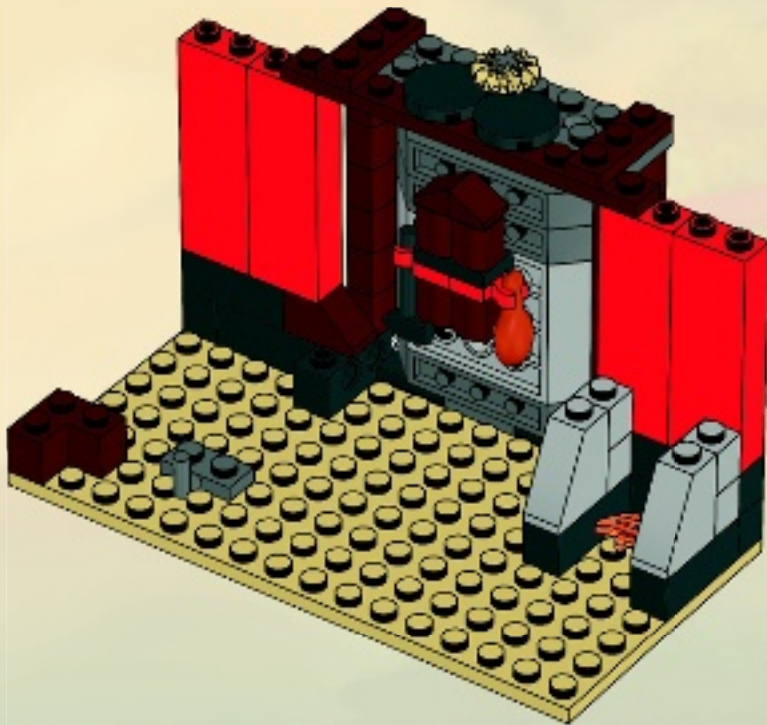

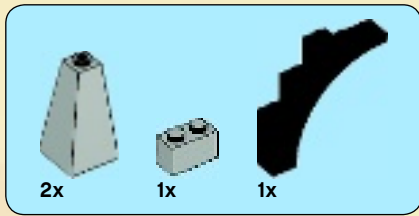

17

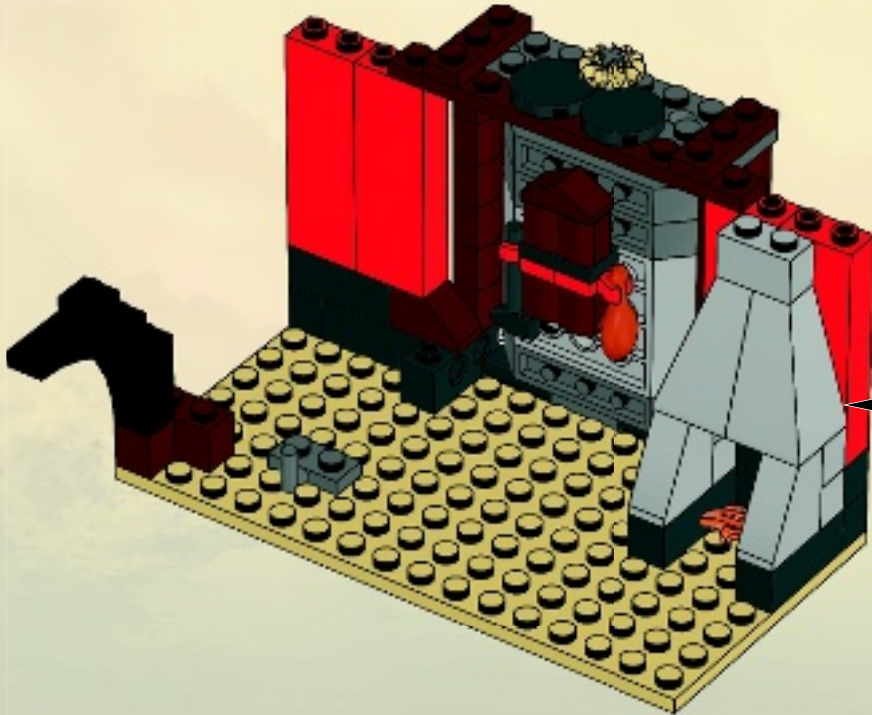
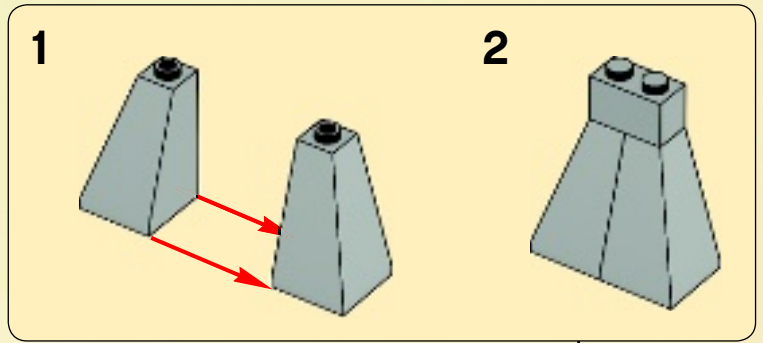

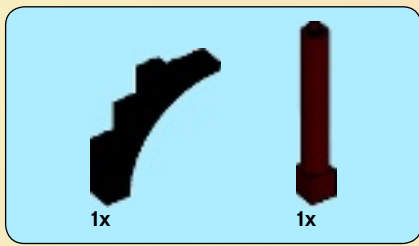

18

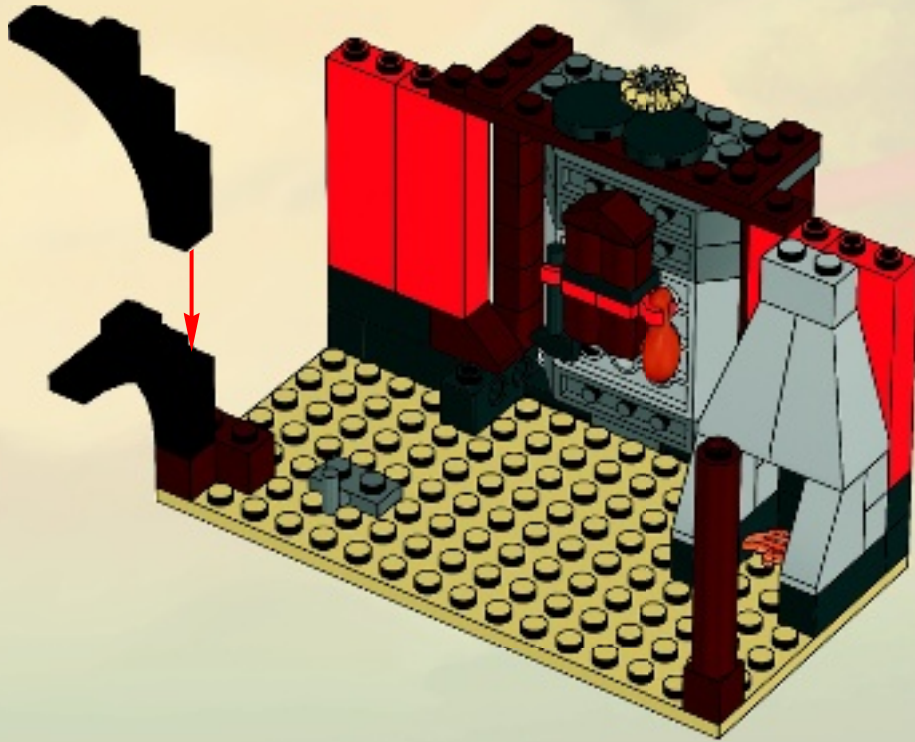

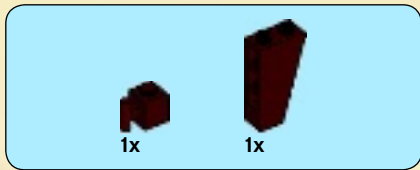

19

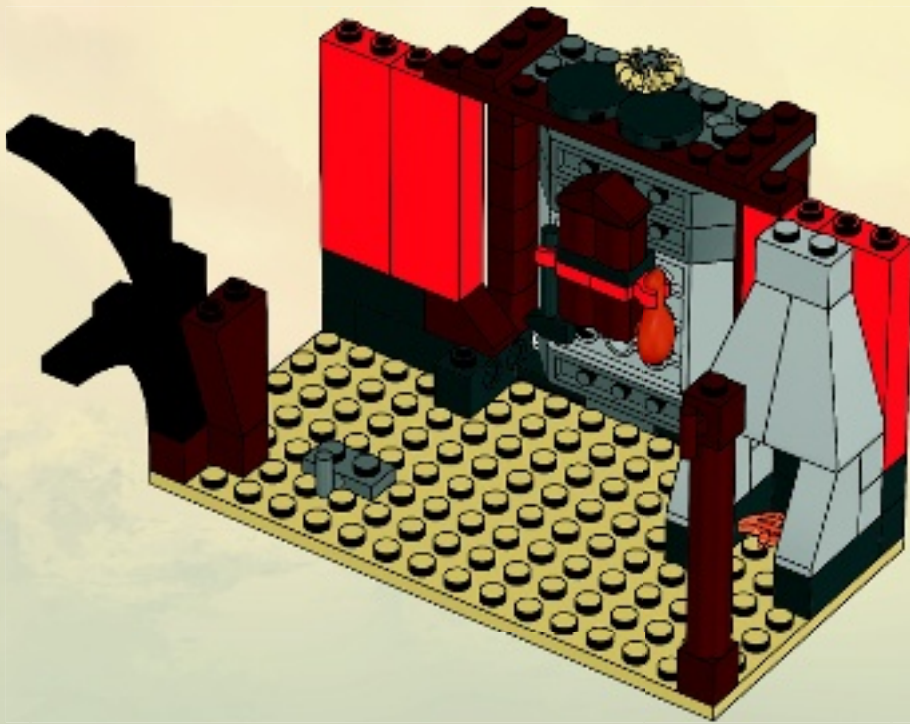





1x

# 20

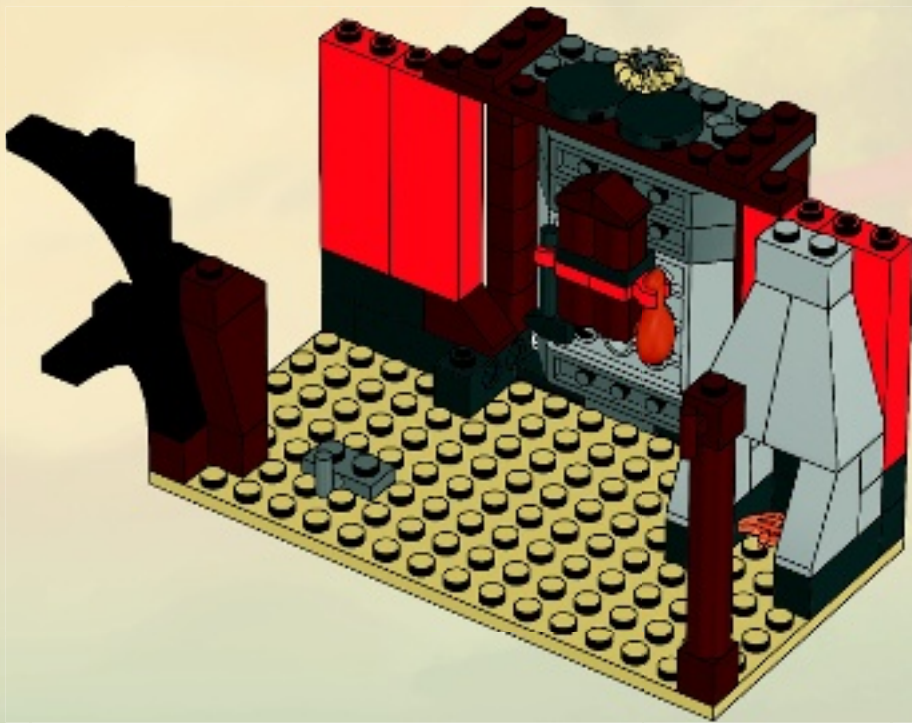

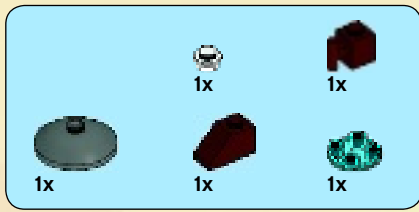

21

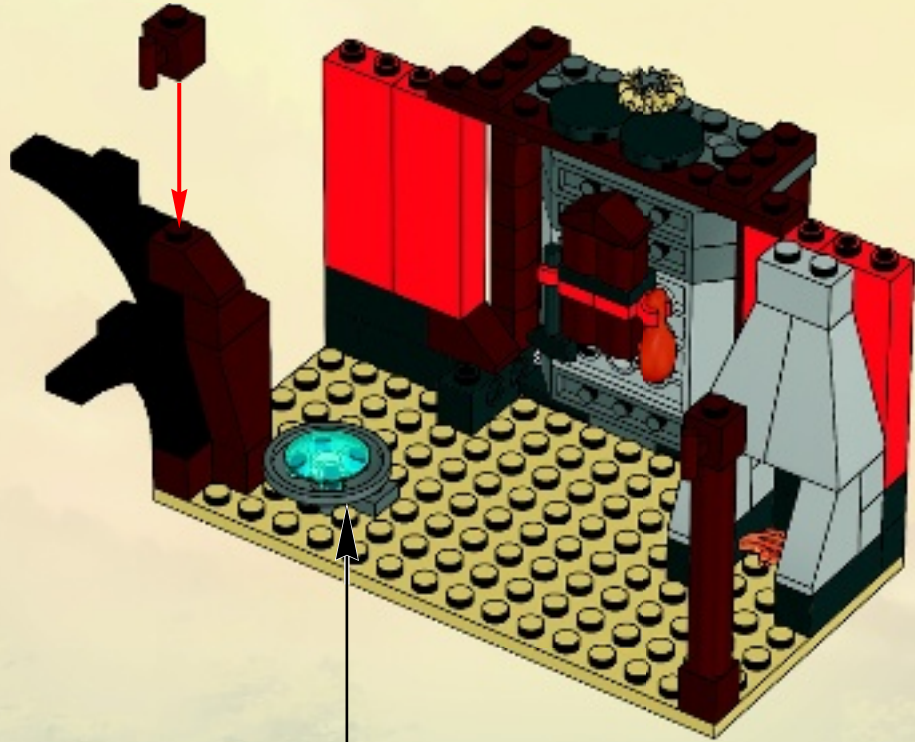

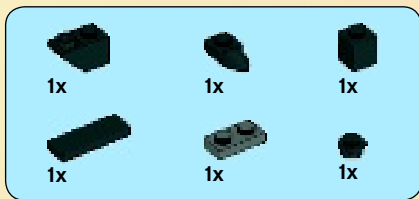

# 22

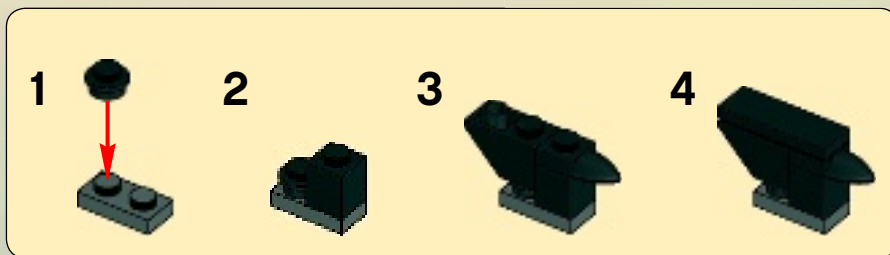
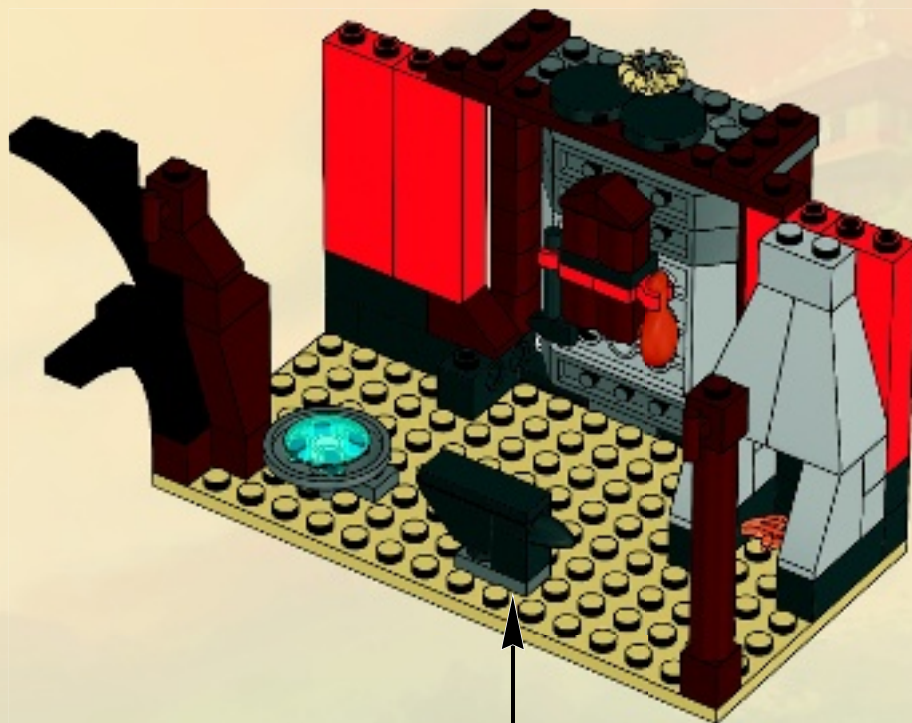

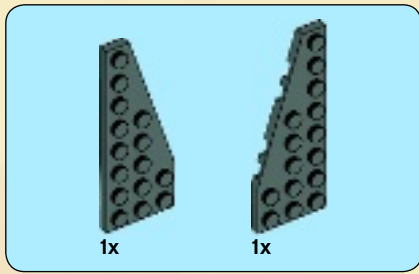

23

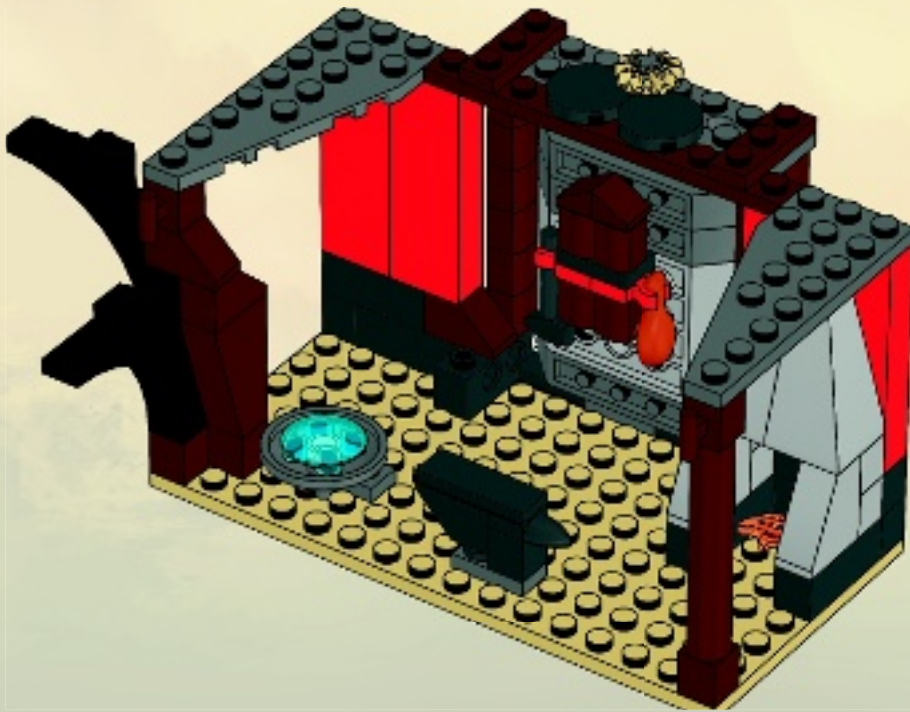



24

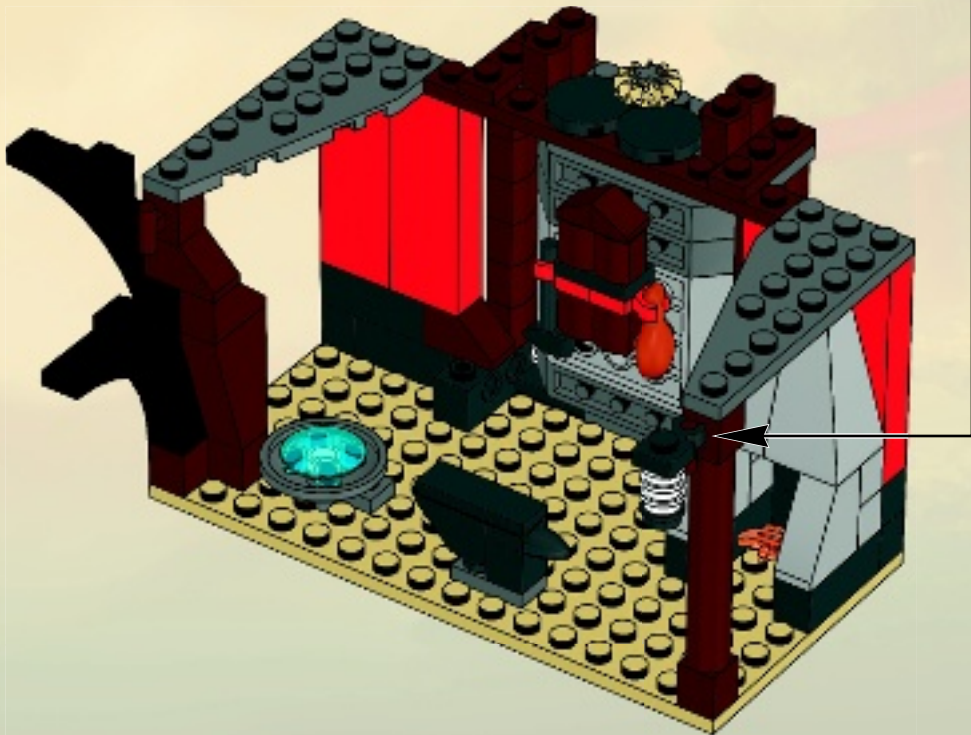
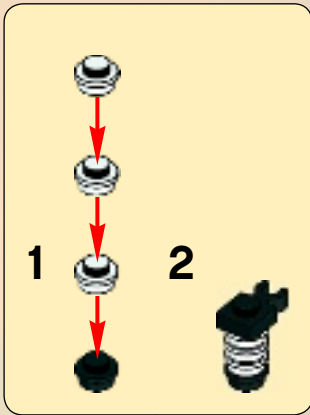

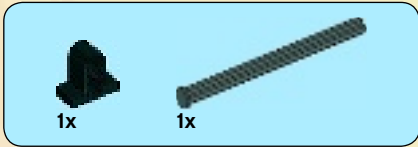

1

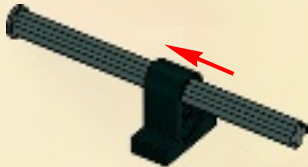

2

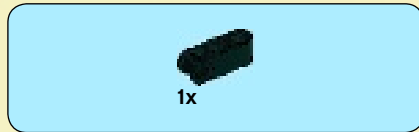
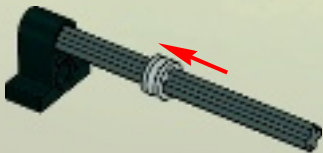

3

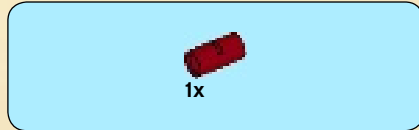

4

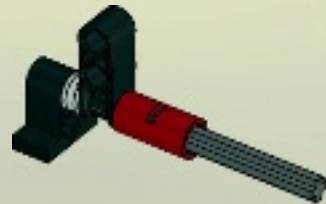



5

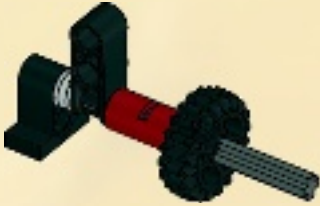

6

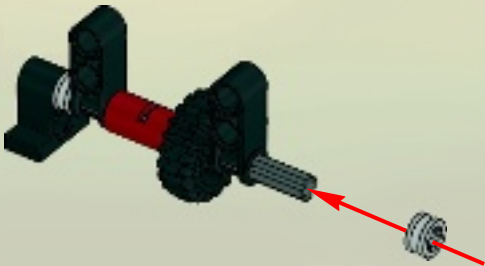

7

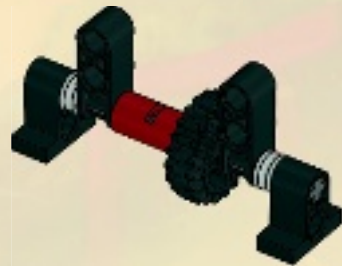

25

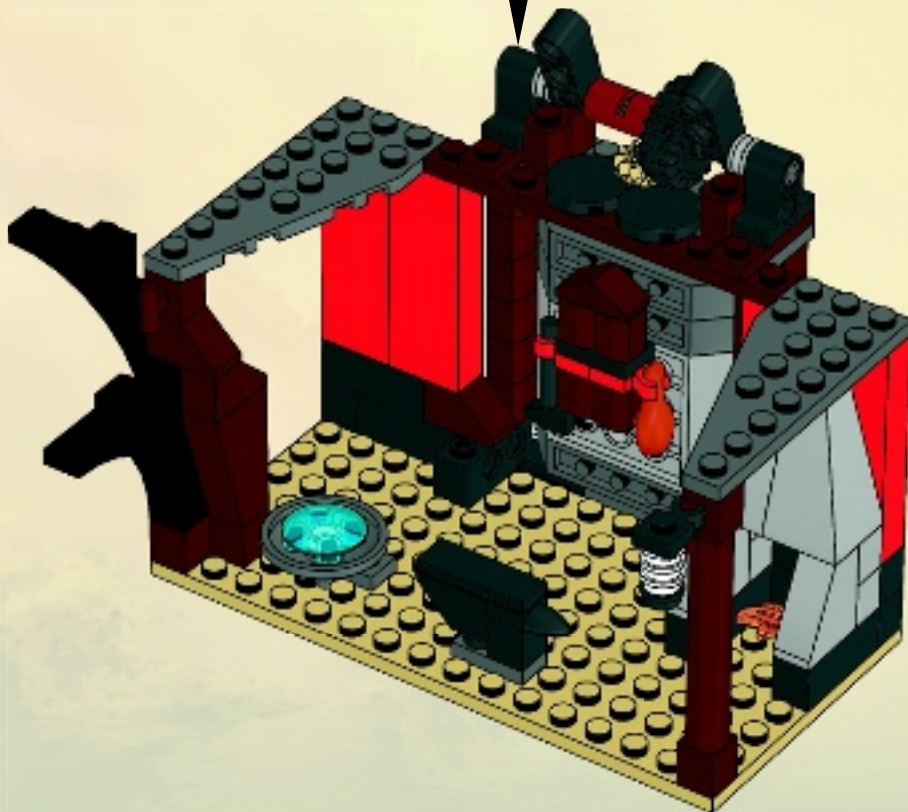





2x

# 26

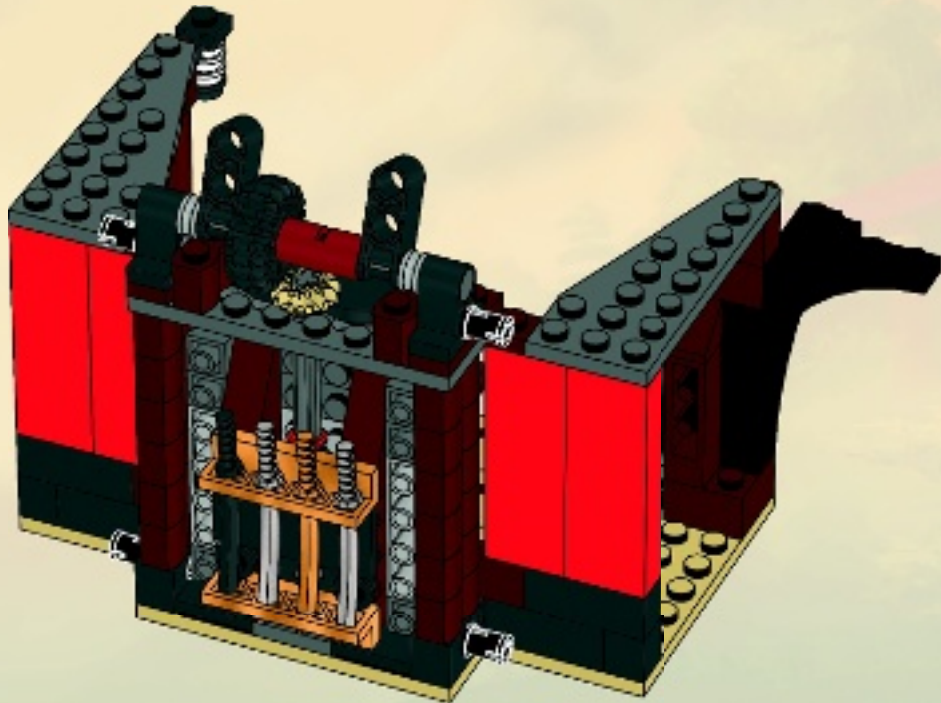
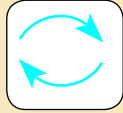

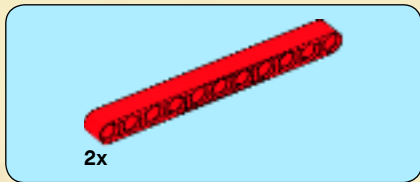

27

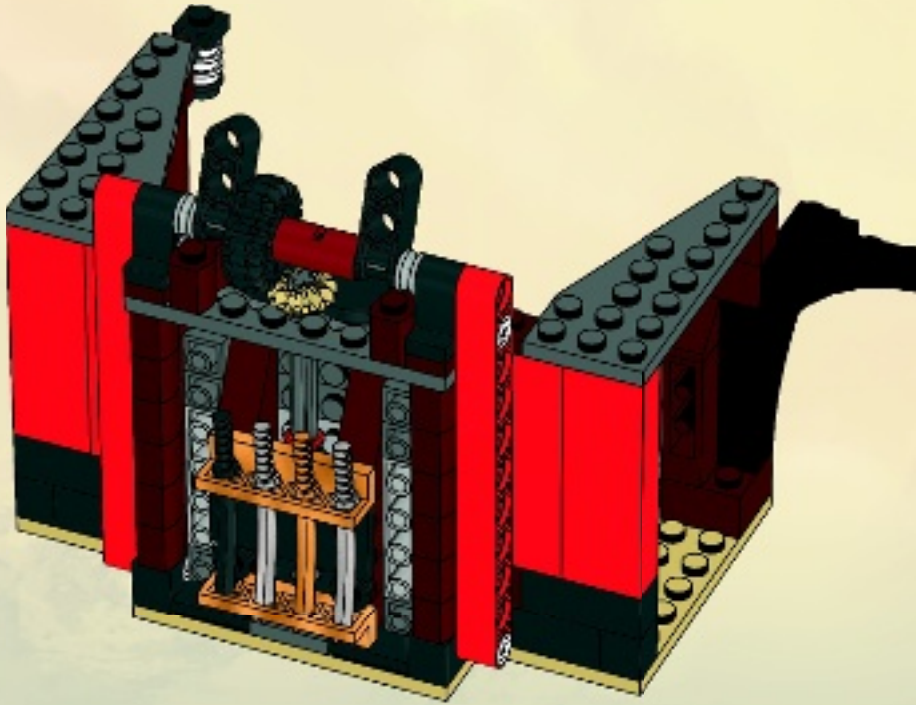

28

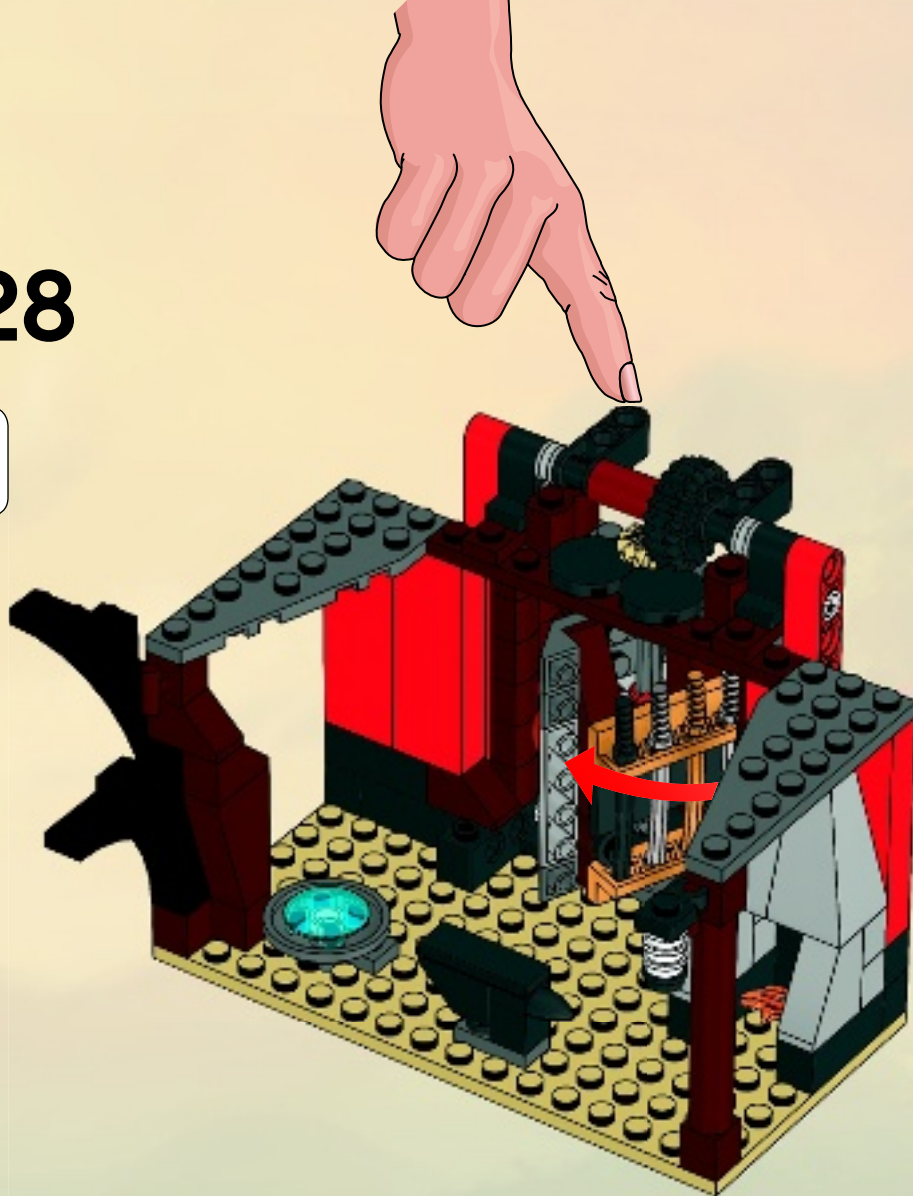
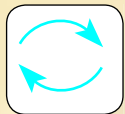

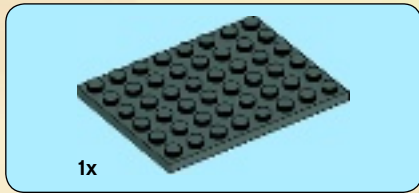
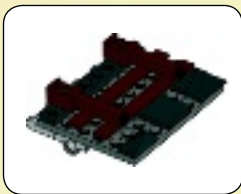

1x

1



2x

1x

2

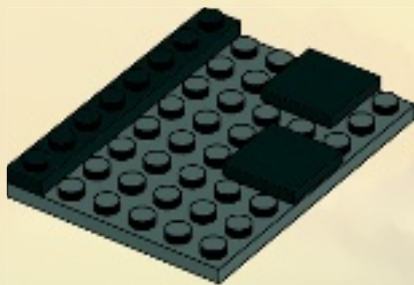

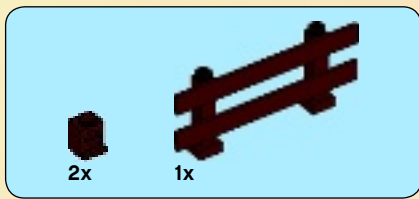

3

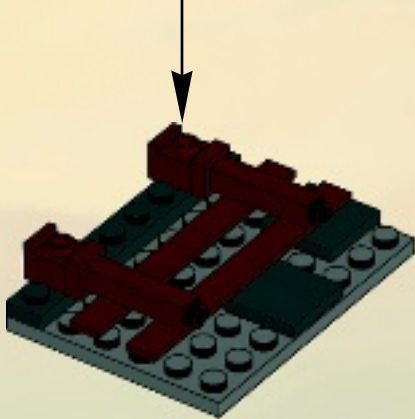
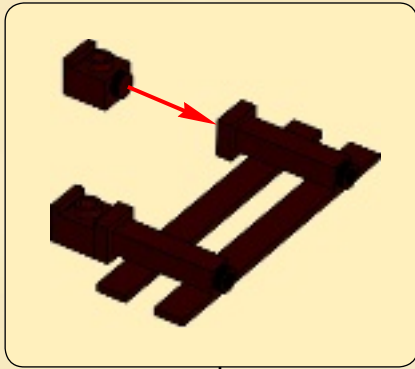

4

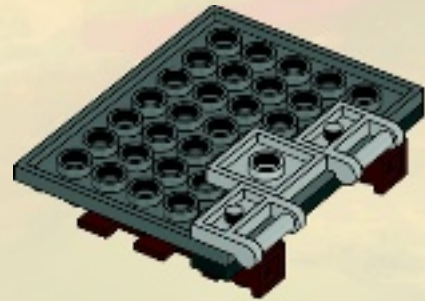
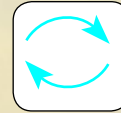

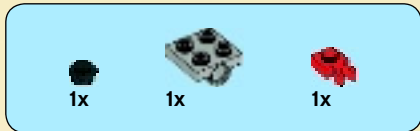

5

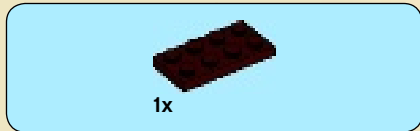
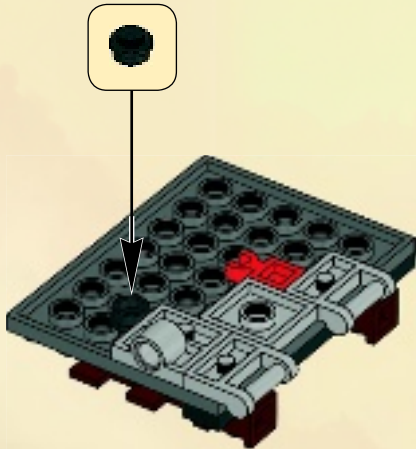

6



7

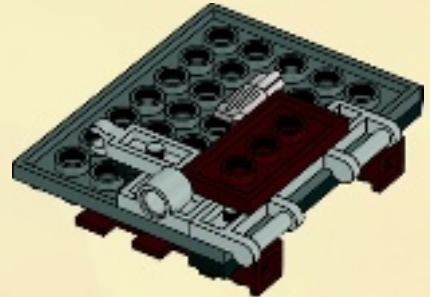

8

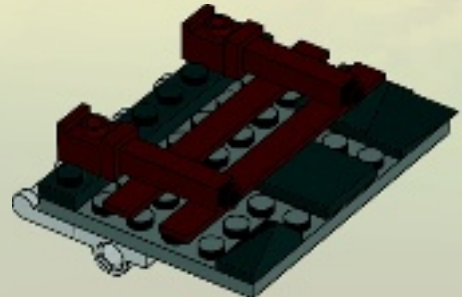
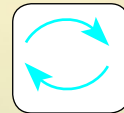

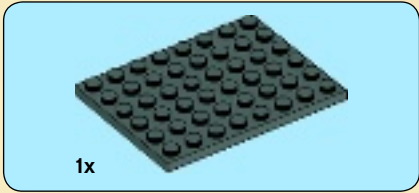

1

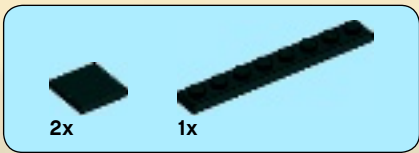

2

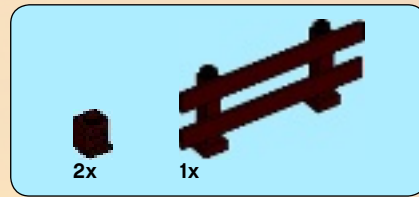
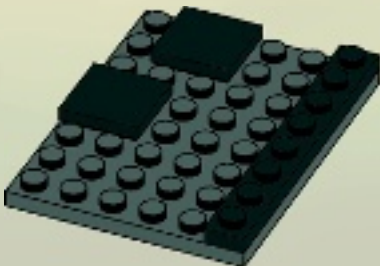

3

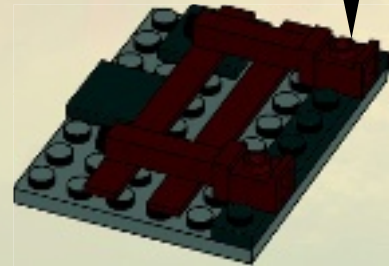
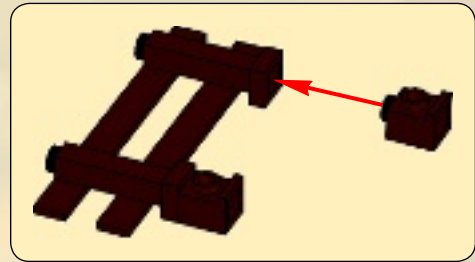



1x



2x

4

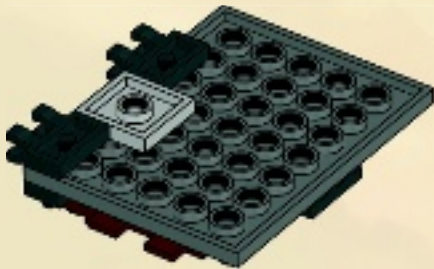

1x



1x



1x

5

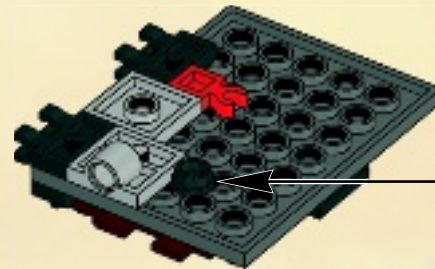





6



7

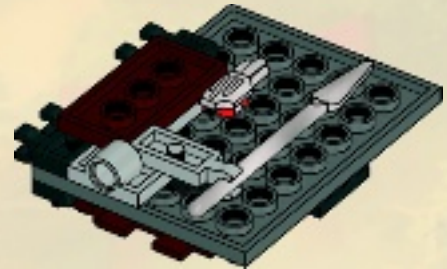



8

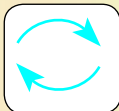

9

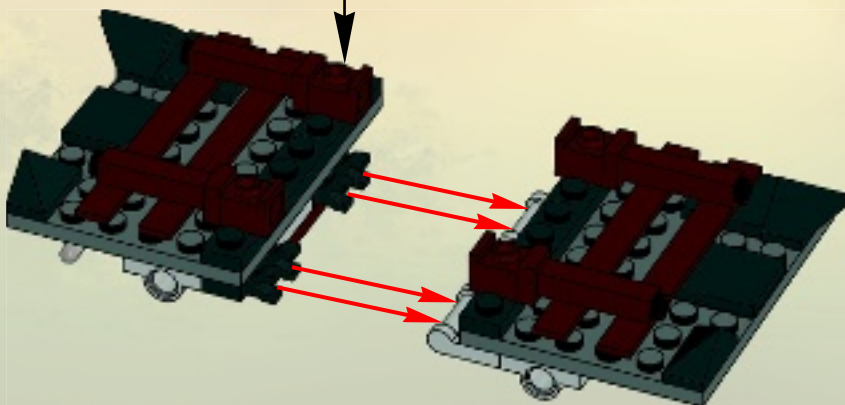



2x

10

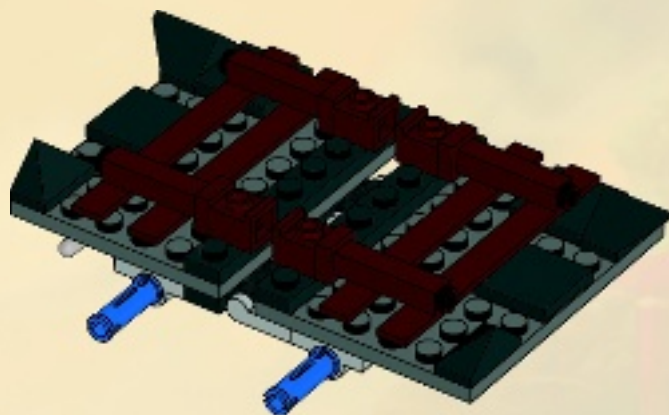



11

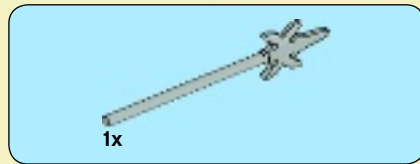
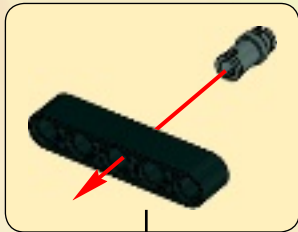

12

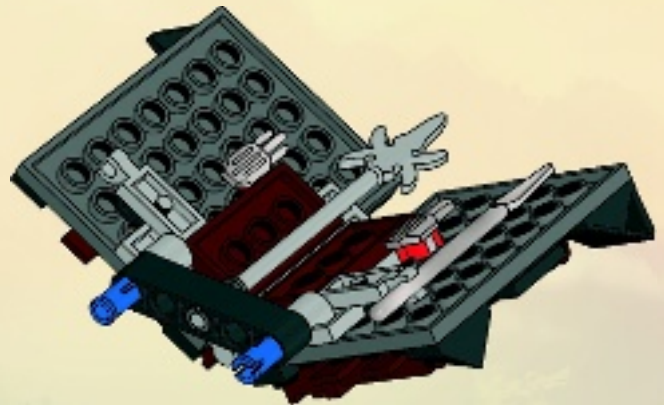
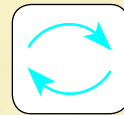

13

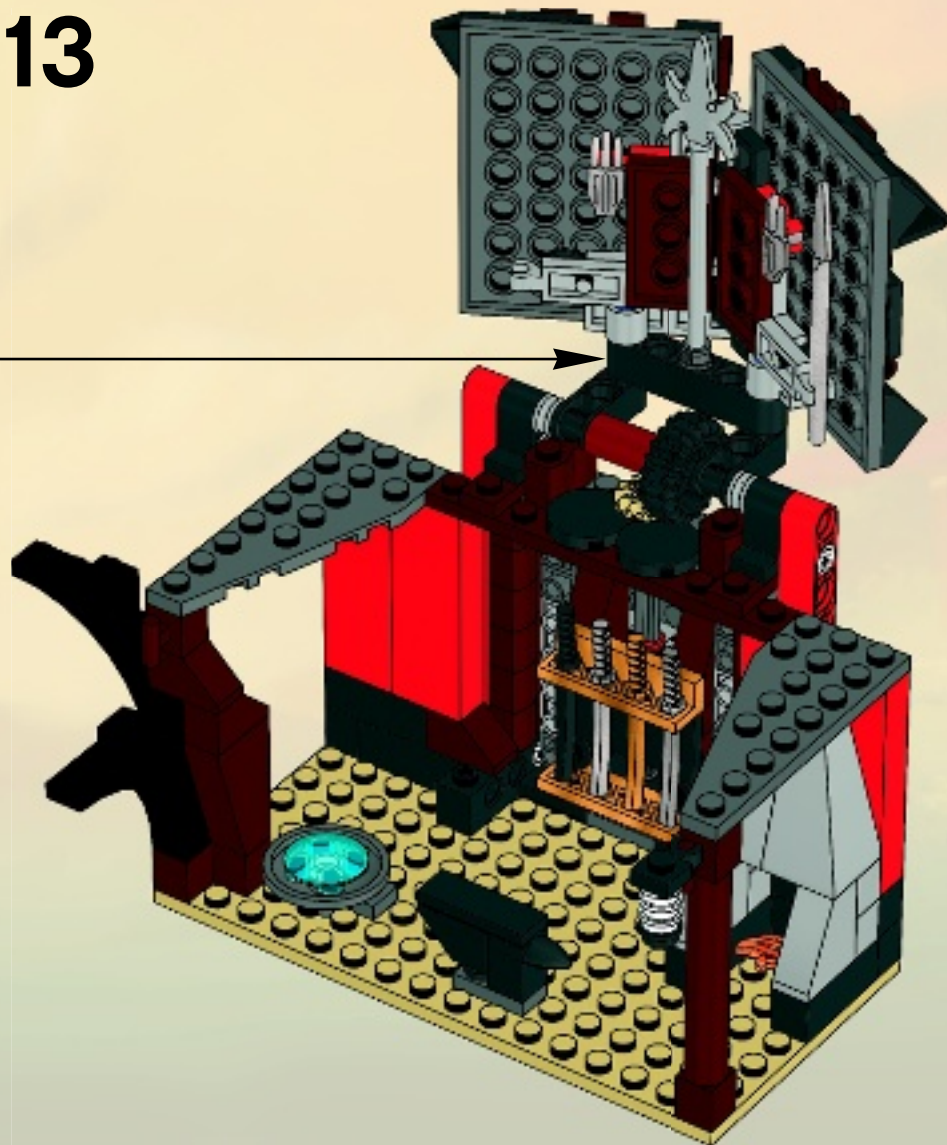



14

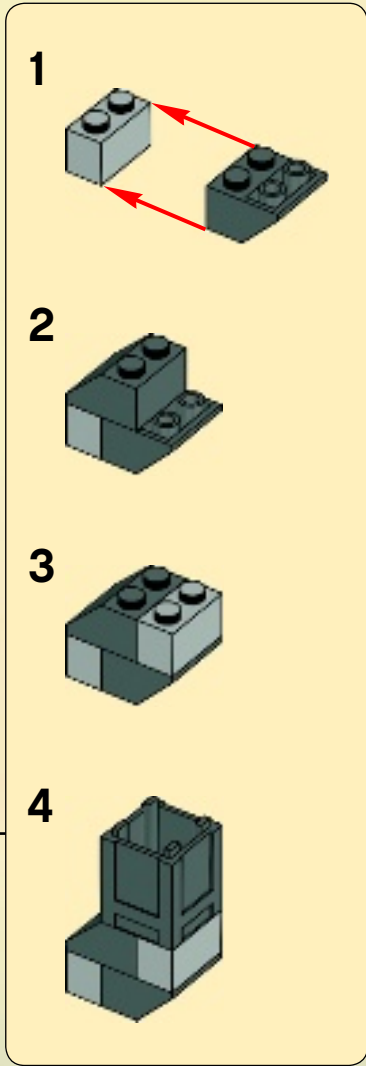
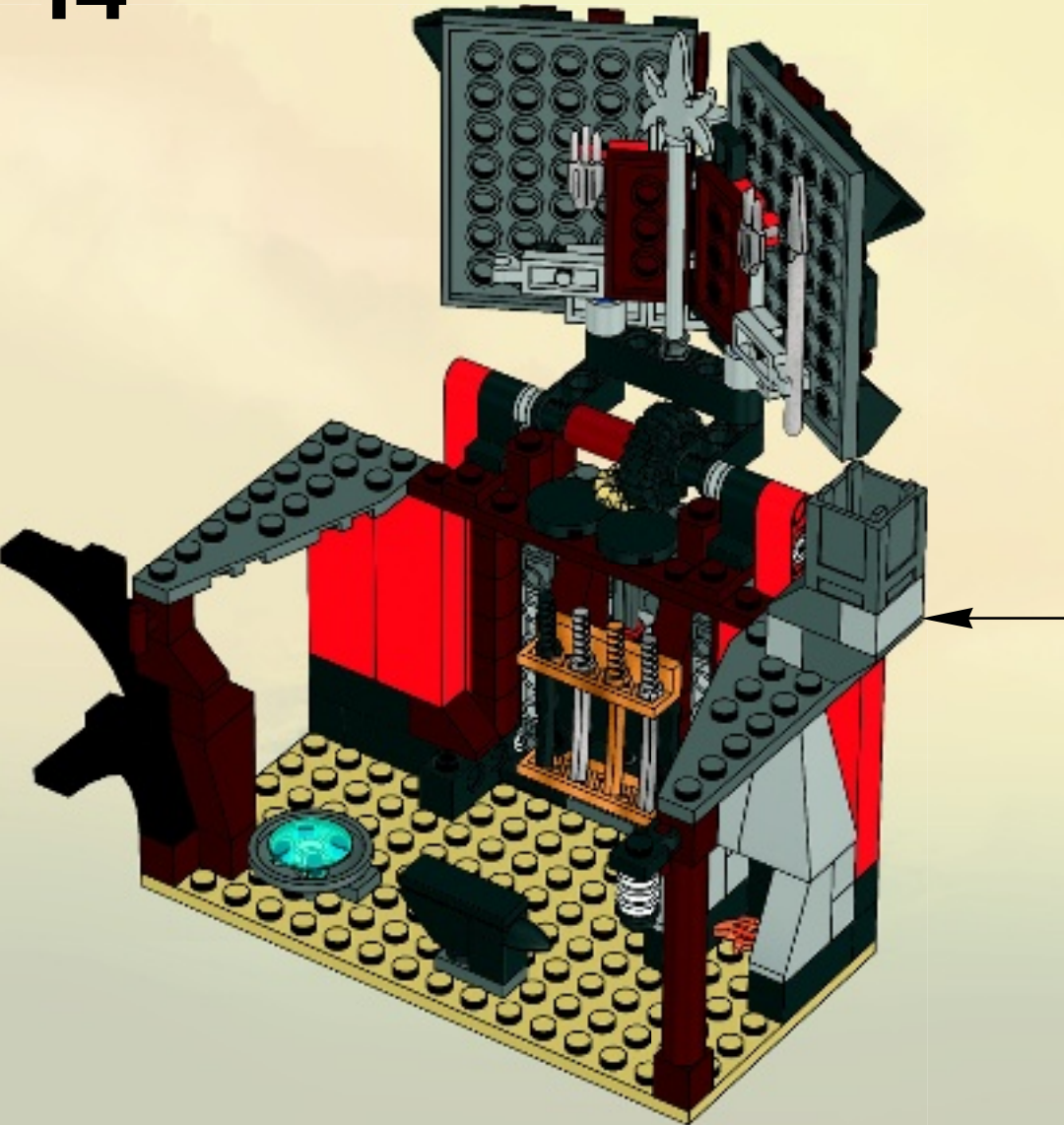



2x

# 15

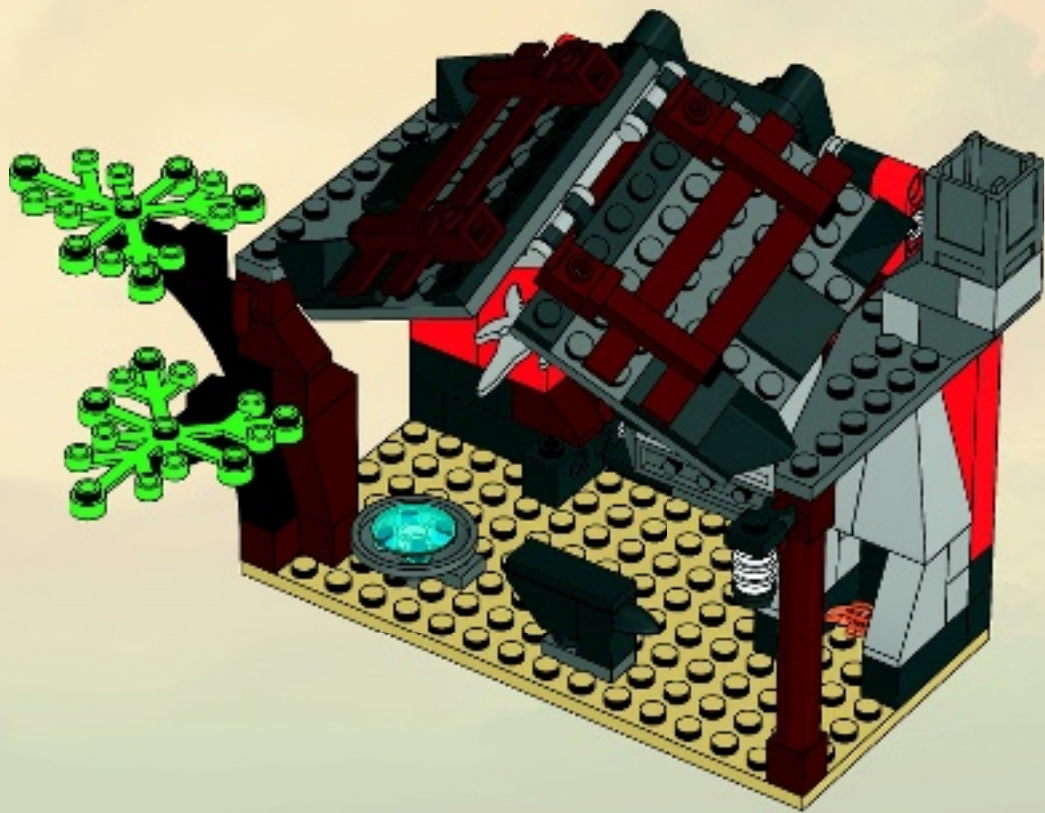

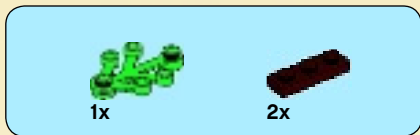

# 16

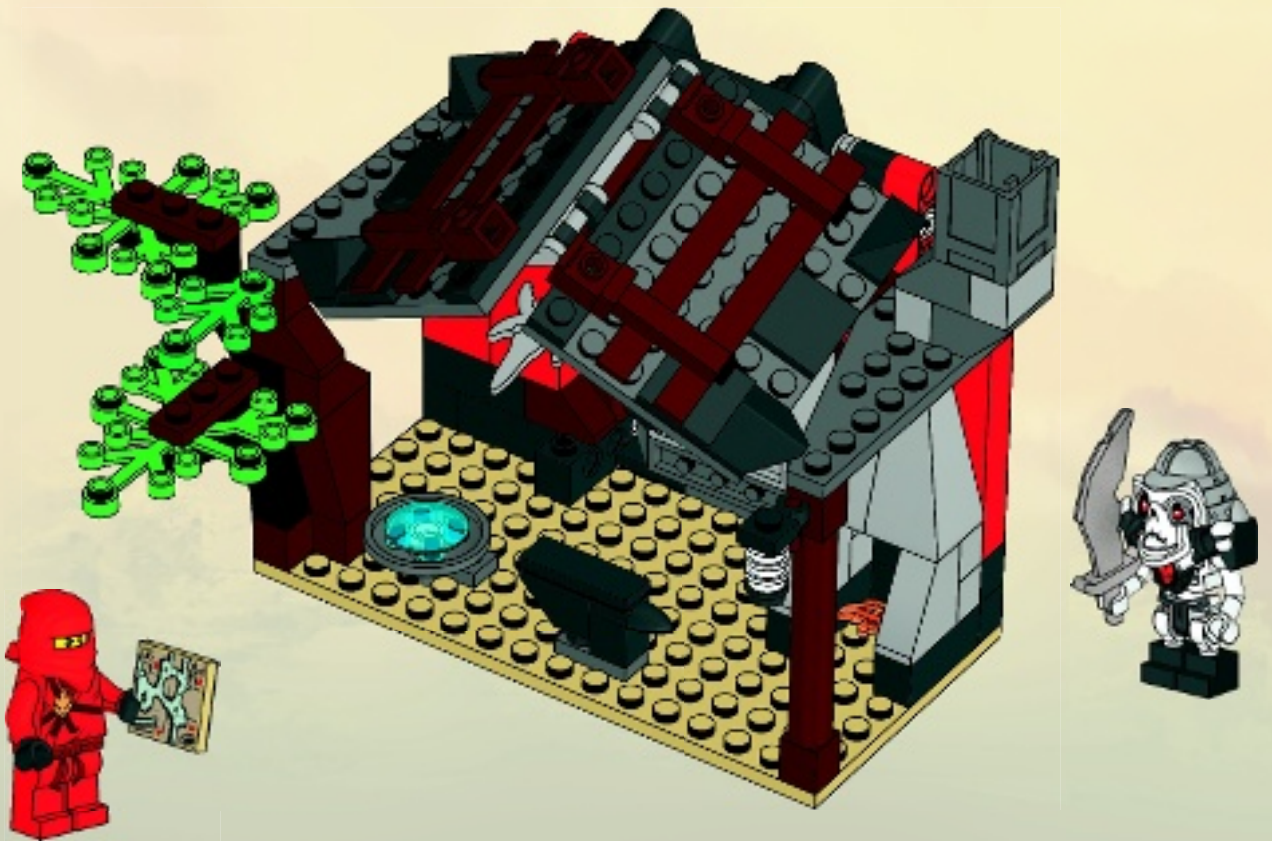



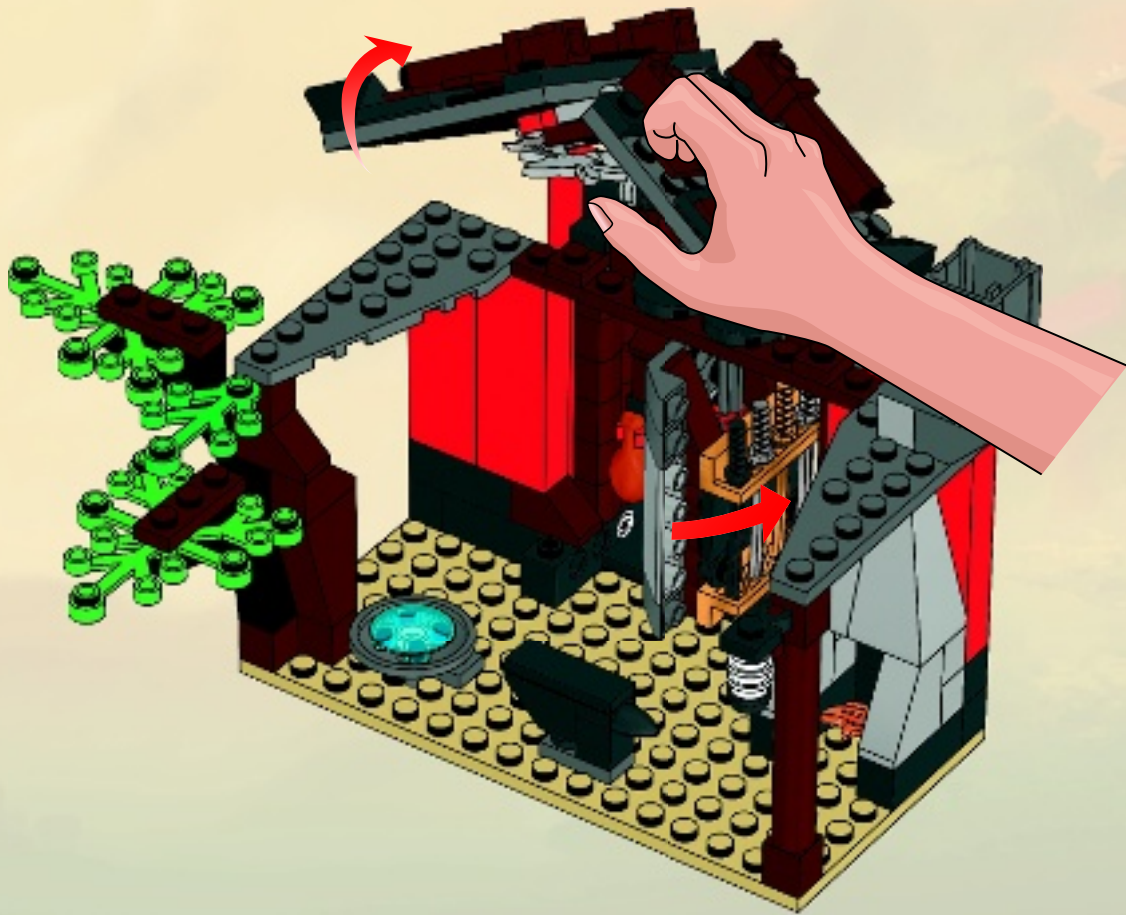



4x  
614101

2x  
4609295

2x  
4602970

1x  
4612346

1x  
4623786

1x  
4630045

1x  
4113988

1x  
4565452

4x  
4212414

4x  
4588003

1x  
4612645

1x  
4631529

1x  
4641677

2x  
4562805

1x  
4140806

2x  
4514553

1x  
4611424

3x  
300526

6x  
362226

2x  
370026

2x  
370126

2x  
304826

1x  
366526

2x  
4220539

6x  
306826

1x  
4558170

1x  
4560182

2x  
346026

1x  
4550017

2x  
4144024

1x  
4277932

2x  
4556158

6x  
614126

2x  
415026

1x  
4624209

1x  
452226

1x  
4114206

1x  
4273590

1x  
4142135

2x  
4173970

4x  
4121715

1x  
4177430

1x  
255526

2x  
4129872

1x  
4278013

1x  
4623595

1x  
4540865

1x  
4539091

1x  
4211200

4x  
4225469

2x  
4225823

16x  
4211180

2x  
4211181

1x  
4520612

2x  
4504376

1x  
4264755

4x  
4211199

2x  
4211197

4x  
4211152

2x  
4211186

2x  
4264031

1x  
4223683

4x  
4211389

3x  
4211388

2x  
4515374

2x  
4191414

1x  
4549997

2x  
4211397

2x  
4244627

2x  
4535738

2x  
4211359

1x  
4520991

2x  
4210794

1x  
4260707

2x  
4211573

1x  
4211054

1x  
4211000

3x  
4294180

1x  
4211063

1x  
4611703

1x  
4211129

1x  
4529728

1x  
4529727

1x  
4210865

1x  
4520307

1x  
4609726

1x  
4211050

1x  
4508553

1x  
4499858

2x  
4536675

1x  
4614404

2x  
4518606

1x  
4611882

2x  
4636105

2x  
4612900

1x  
4611883

1x  
242328

**Customer Service**  
**Kundenservice**  
**Service Consommateurs**  
**Servicio Al Consumidor**  
[www.lego.com/service](http://www.lego.com/service) or dial  
 00800 5346 5555 :       
 1-800-422-5346 :  

**LEGO**

# NINJAGO

Masters of Spinjitzu



2509



2506



2507

2508



2509

2507



2506



2508



# NINJAGO

Masters of Spinjitzu





# NINJAGO

Masters of Spinjitzu



 2170 2507 2509	 2508 2507	 2170	 2170 2507 2508 2509	 2171	 2171	 2171 2507 2508	 2507	 2507	 2172	 2172
 2172 2507	 2173	 2173 2174	 2173 2256 2508	 2174	 2174 2175	 2175	 2175			
 2255	 2255	 2255 2507 2508	 2256	 2256	 2506	 2506 2507	 2506 2507			
 2506 2507	 2507 2254	 2507	 2508	 2508	 2509	 2509	 2254	 2254		



# NINJAGO

Masters of Spinjitzu



2254



2257



2174



2175



2255



2256



# NINJAGO

Masters of Spinjitzu

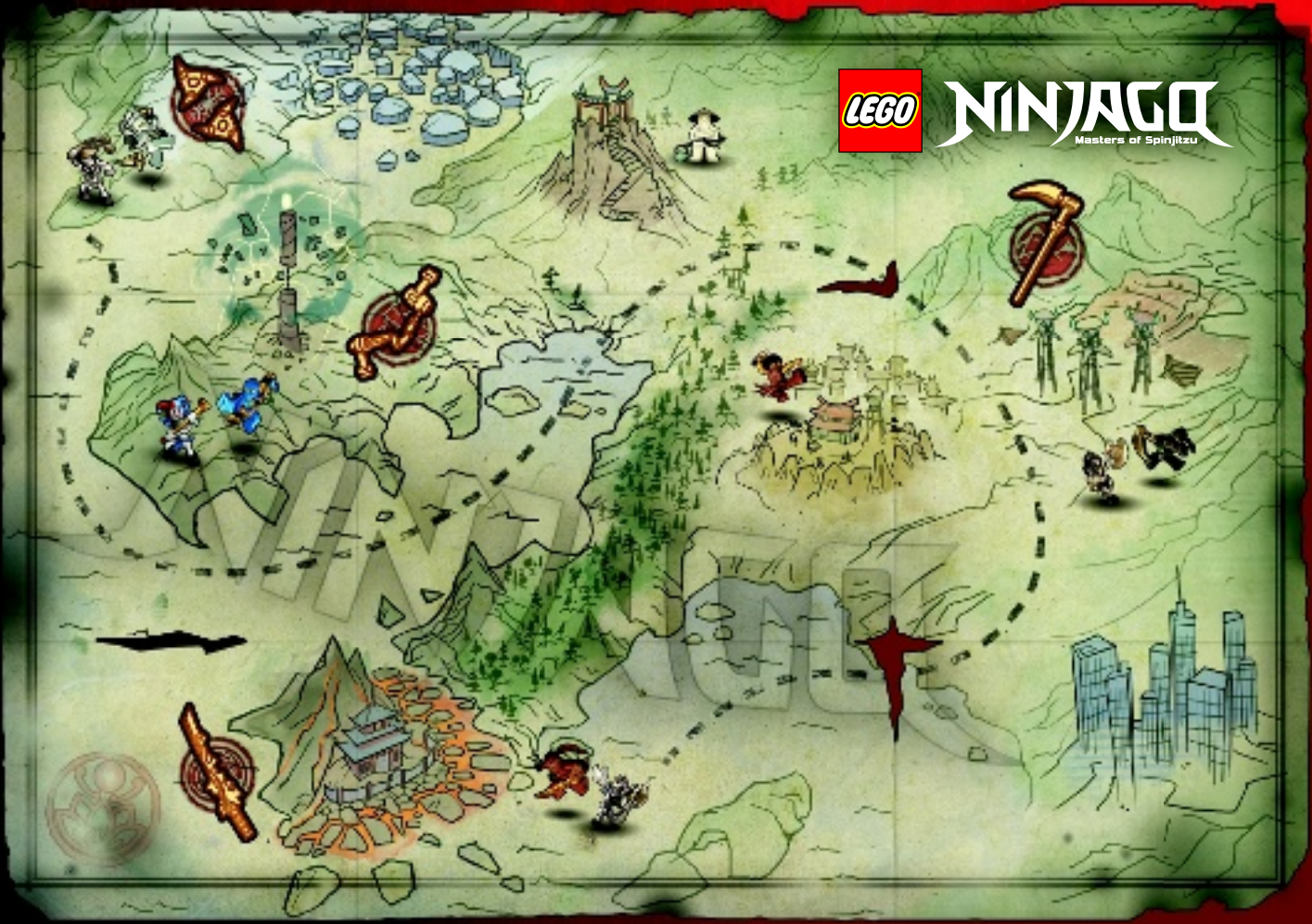



# NINJAGO

Masters of Spinjitzu



[NINJAGO.COM](http://NINJAGO.COM)





# NINJAGO

THE VIDEO GAME  
LE JEU VIDÉO  
EL VIDEO JUEGO



**OUT NOW!**  
**MAINTENANT DISPONIBLE !**  
**¡DISPONIBLE AHORA!**

LEGO Battles: Ninjago software © 2011 TT Games Publishing Ltd. Produced by TT Games under license from the LEGO Group. LEGO, the LEGO logo, the Brick and the Knob configurations and the Minifigure are trademarks of the LEGO Group. © 2011 The LEGO Group. Hellbent Games and the Hellbent logo are trademarks of Hellbent Games Inc. Nintendo DS is a trademark of Nintendo. © 2011 Nintendo. All other trademarks and copyrights are the property of their respective owners. All rights reserved.

LEGO Battles: Le jeu vidéo Ninjago © 2011 TT Games Publishing Ltd. Produit par TT Games sous licence du LEGO Group. LEGO, le logo LEGO, la Brique et les configurations du tenon et la Figurine sont des marques de commerce de LEGO Group. © 2011 The LEGO Group. Hellbent Games et le logo Hellbent sont des marques de commerce de Hellbent Games Inc. Nintendo DS est une marque de commerce de Nintendo. © 2011 Nintendo. Toutes les autres marques de commerce et droits d'auteur sont la propriété de leurs propriétaires respectifs. Tous droits réservés.

Batallas LEGO®: Software Ninjago © 2011 TT Games Publishing Ltd. Producido por TT Games bajo licencia de the LEGO Group. LEGO, el logo LEGO, el Brick, la configuración del tenon y la Minifigura son marcas de the LEGO Group. © 2011 The LEGO Group. Hellbent Games y el Hellbent logo son marcas de Hellbent Games Inc. Nintendo DS es una marca de Nintendo. © 2011 Nintendo. Todas las otras marcas y derechos son propiedad de sus dueños respectivos. Todos los derechos reservados.



[www.pegi.info](http://www.pegi.info)



WB GAMES LOGO, WB SHIELD, TM & © Warner Bros. Entertainment Inc. (411)

NINTENDO DS

hellbent games





# UNIVERSE

MASSIVELY MULTIPLAYER ONLINE GAME  
JEU EN LIGNE MASSIVEMENT MULTJOUEUR

Become your favorite Spinjitzu hero in LEGO Universe  
Spiele in LEGO Universe deine Lieblings-Figur aus Ninjago  
Convírtete en tu héroe favorito de Spinjitzu en LEGO Universe  
Deviens ton héros Spinjitzu préféré dans LEGO Universe  
Légy olyan, mint kedvenc Ninjago hősöd a LEGO Universe  
Transforma-te no teu herói Ninjago favorito em LEGO Universe

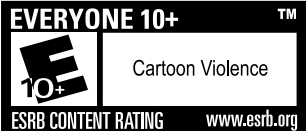

Online Interactions Not Rated by the ESRB



[www.LEGOuniverse.com](http://www.LEGOuniverse.com)



# WIN!

Go to [www.LEGOsurvey.com/product](http://www.LEGOsurvey.com/product) to fill out a survey for a chance to win a cool LEGO® Product. No purchase necessary. Open to all residents where not prohibited.

 [www.LEGO.com](http://www.LEGO.com)



## [www.LEGOsurvey.com/product](http://www.LEGOsurvey.com/product)

### GEWINNE! WIN!

Nimm an der Umfrage auf [www.LEGOsurvey.com/product](http://www.LEGOsurvey.com/product) teil und hab die Chance ein cooles LEGO® Produkt zu gewinnen!  
Die Teilnahme am Gewinnspiel führt zu keinerlei Kaufverpflichtungen. Teilnahme in allen nicht ausgeschlossenen Ländern möglich.

Ga naar [www.LEGOsurvey.com/product](http://www.LEGOsurvey.com/product), vul een enquêteformulier in en maak kans op een cool LEGO® product.  
Geen aankoopverplichting. Iedereen mag deelnemen, uitgezonderd ingezetenden van landen waar een enquêteverbod geldt.

### GAGNE! 当てよう!

Visite [www.LEGOsurvey.com/product](http://www.LEGOsurvey.com/product) pour répondre à un questionnaire et avoir une chance de gagner un produit LEGO® très cool!  
Aucune obligation d'achat. Ouvert à tous les résidents des pays autorisés.

[www.LEGOsurvey.com/product](http://www.LEGOsurvey.com/product) にアクセスして、アンケートにご記入ください。当選者にはレゴ®製品を差し上げます。  
お買い上げの必要はありません。  
禁止されていない限り、すべての管轄にご利用いただけます。



# NINJAGO

Masters of Spinjitzu

2011

