

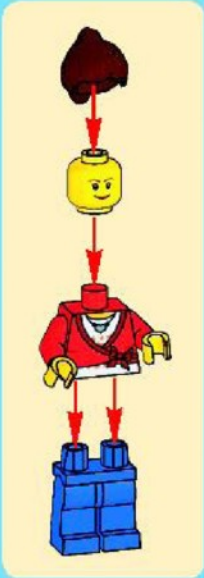

4-7

5899







1

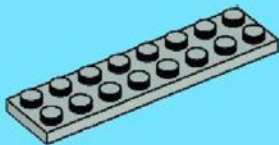

2



3

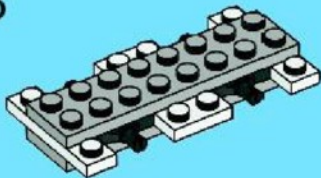

4

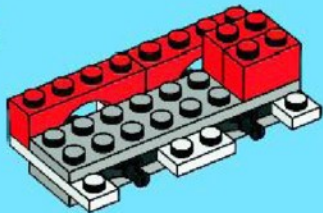

5

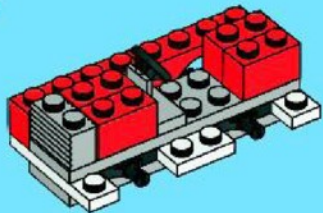

4

6

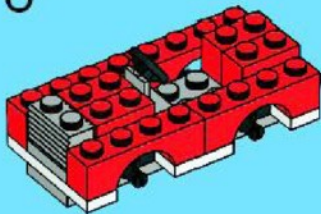

7

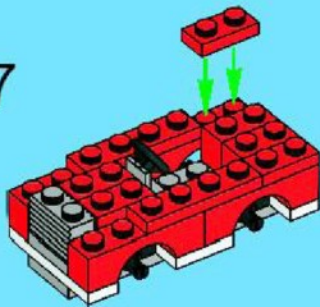

8





1

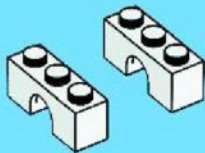

2



3

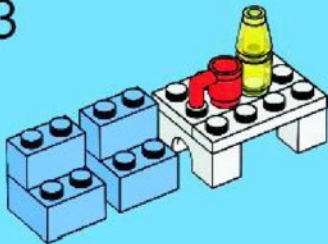





1

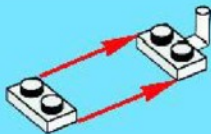

2

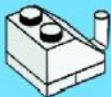

3



4









1

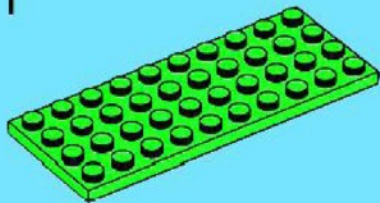

2

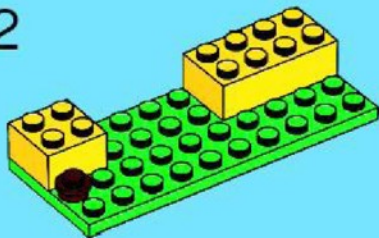

3

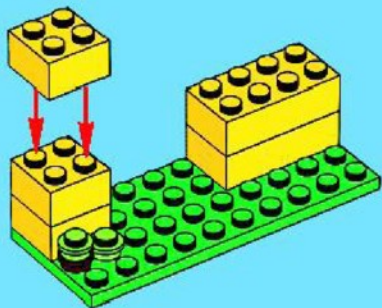

4

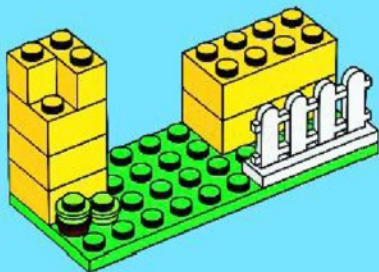

5

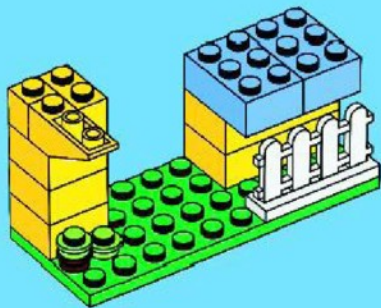

6

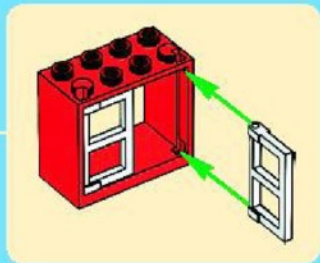
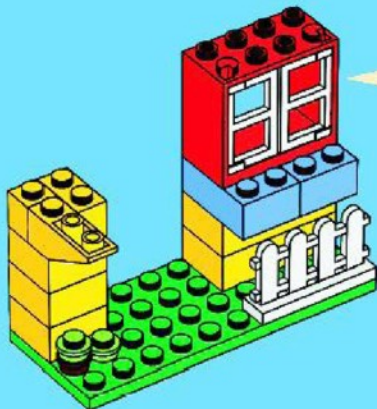

7

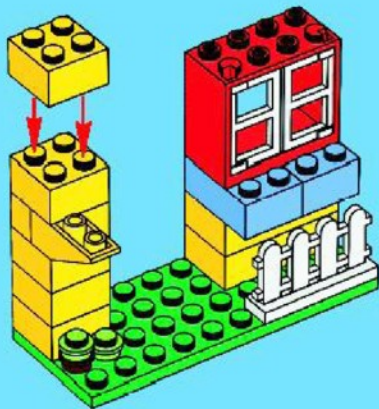

8

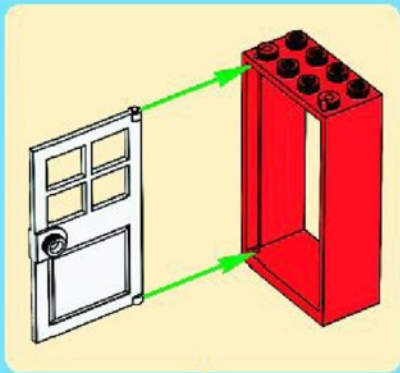
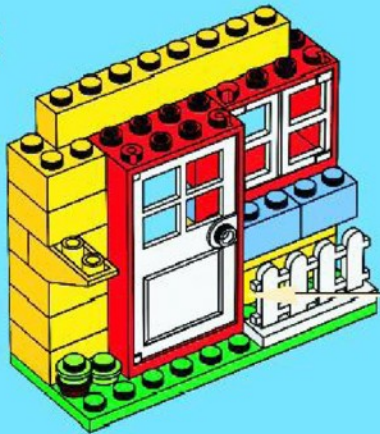

9

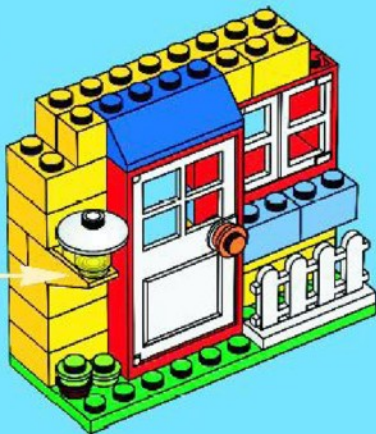
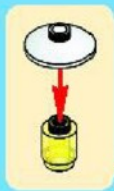



10

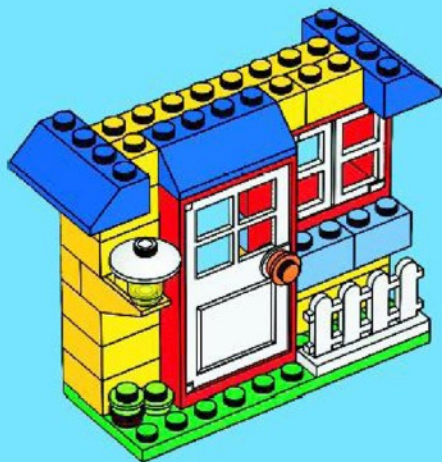

11

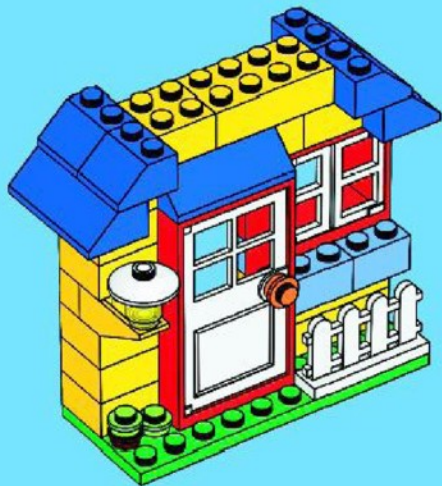

12

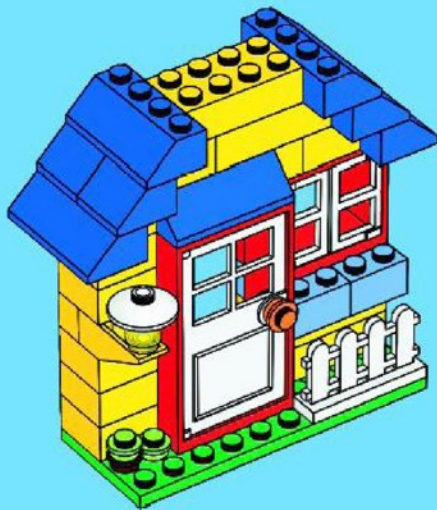

13





6192



6191



5898



626

5560



6194



6166



[www.LEGO.com](http://www.LEGO.com)





1x  
389921



4x  
302321



2x  
371021



2x  
302121



4x  
300421



4x  
365921



1x  
4550848



1x  
4540429



1x  
4528164



1x  
4528139



2x  
300123



1x  
9341



8x  
303923



5x  
4107437



2x  
301023



2x  
4179830



4x  
4179833



3x  
4201235



2x  
4210130



1x  
81508



2x  
4520970



4x  
371001



4x  
302001



1x  
4141607



1x  
4521943



1x  
474001



1x  
302301



2x  
303901



2x  
4520842



1x  
462301



4x  
462401



1x  
4521778





1x  
302224



2x  
428724



3x  
300524



2x  
300424



6x  
300324



4x  
300124



1x  
300824



1x  
4261269



1x  
4293369



2x  
4567332



2x  
3008844



2x  
4216581



1x  
4211165



2x  
4211210



2x  
4157103



4x  
4501046



2x  
460026



2x  
4504382



1x  
400626



4x  
4164022



2x  
4183133



2x  
4143562



1x  
300328



2x  
4109674



1x  
74040



1x  
4223986



1x  
4535553



1x  
4226995



1x  
4211383



2x  
4211406



Customer Service

Kundenservice

Service Consommateurs

Servicio Al Consumidor

[www.lego.com/service](http://www.lego.com/service) or dial



00800 5346 5555

1-800-422-5346



# WIN!

 [www.LEGO.com](http://www.LEGO.com)

Go to [www.nielsen.com/LEGO](http://www.nielsen.com/LEGO)  
to fill out a survey for a chance  
to win a cool LEGO® Product.  
No purchase necessary.  
Open to all residents where not prohibited.



## [www.nielsen.com/lego](http://www.nielsen.com/lego)

### GEWINNE!

Nimm an der Umfrage auf [www.nielsen.com/](http://www.nielsen.com/) LEGO teil und hab die Chance ein cooles LEGO Produkt zu gewinnen! Die Teilnahme am Gewinnspiel führt zu keinerlei Kaufverpflichtungen. Teilnahme in allen nicht ausgeschlossenen Ländern möglich.

### WIN!

Ga naar [www.nielsen.com/LEGO](http://www.nielsen.com/LEGO), vul een enquêteformulier in en maak kans op een cool LEGO® product. Geen aankoopverplichting. Iedereen mag deelnemen, uitgezonderd ingezetenden van landen waar een enquêteverbod geldt.

### GAGNE !

Visite [www.nielsen.com/LEGO](http://www.nielsen.com/LEGO) pour répondre à un questionnaire et avoir une chance de gagner un produit LEGO® très cool ! Aucune obligation d'achat. Ouvert à tous les résidents de pays autorisés.

### 当てよう!

[www.nielsen.com/LEGO](http://www.nielsen.com/LEGO) にアクセスして、アンケートにご記入ください。当選者にはLEGO製品を差し上げます。本賞以上の応募は取りません。発表されていない限り、すべての応募がご応募いただいたものと見做されます。