



RACERS

B475



5



47



RC

RADIO CONTROL



RC Race Buggy

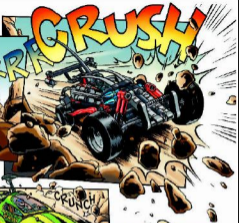

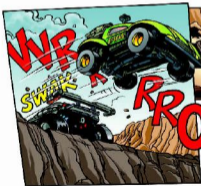



6x

1,5V LR6
1:1



1x

9V 6LR61
1:1



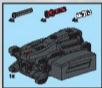

7

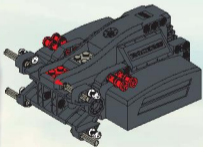



2

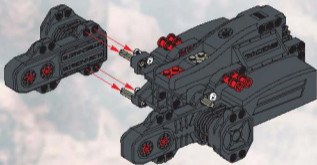



3

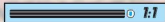
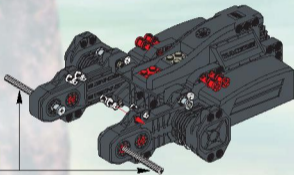



4





5

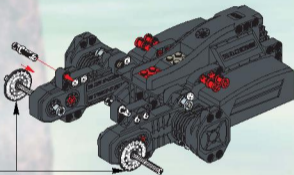



6

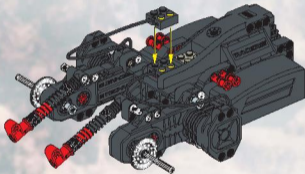



7

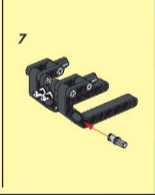
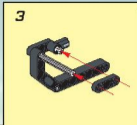
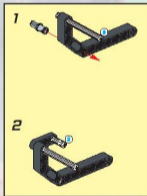

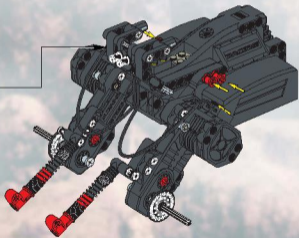



8

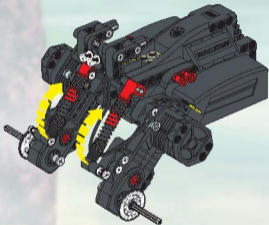



9

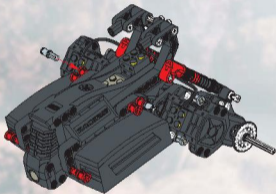





11

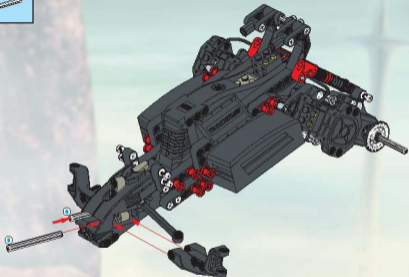



12

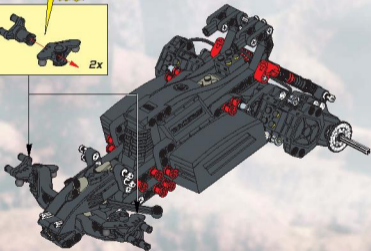

13

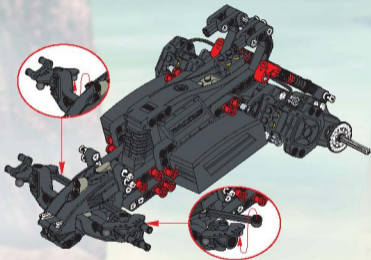



14

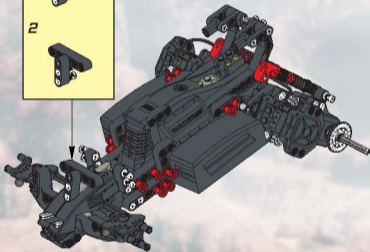
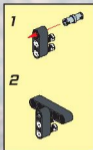



15

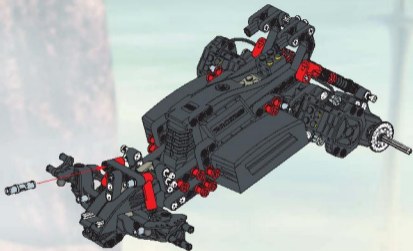

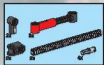

16

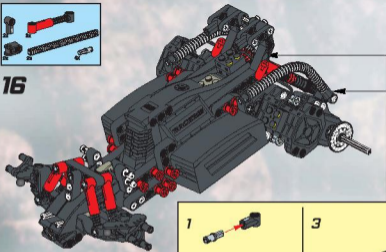

1



3



2





17





Channel 1 Channel 2 Channel 3



3 Channels

Channel 1 Channel 2 Channel 3



Channel 1

Channel 2

Channel 3





Technical Information: Frequency: 27.145 MHz



18

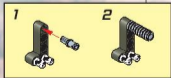



19

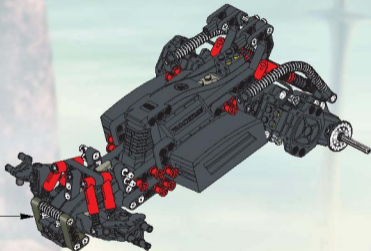



20

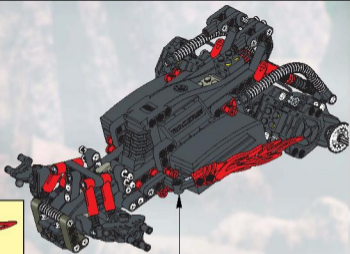

1



2



3



21

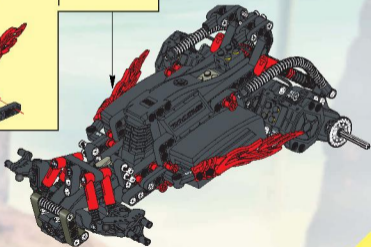
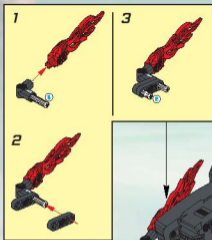



22

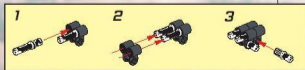
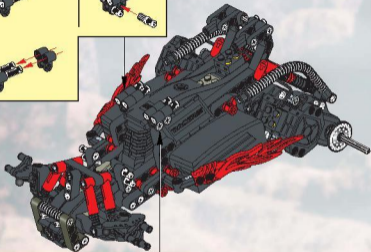
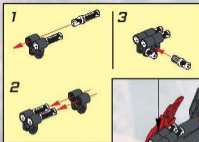



23

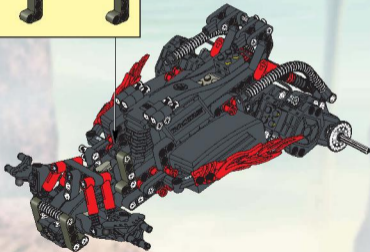

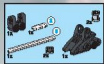

24

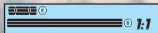
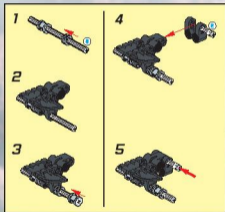



25

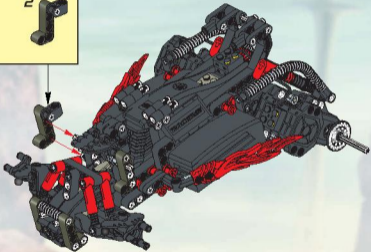



26

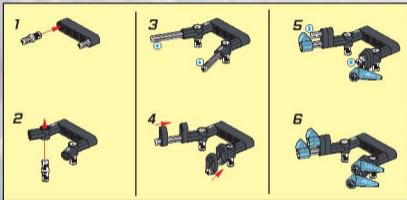

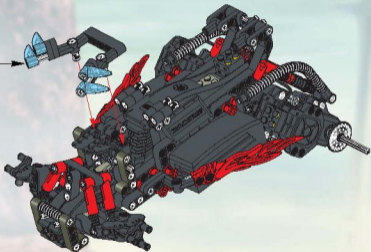



1



2



3



4





5

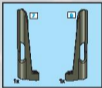

6

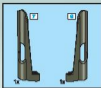

7





8

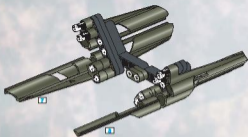

9



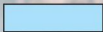

10



27

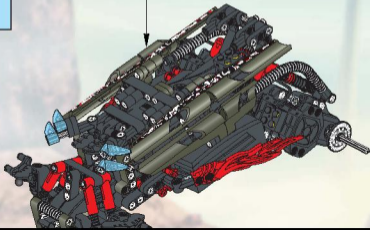

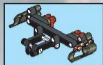

3

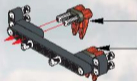
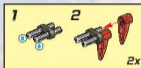

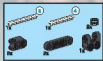

4

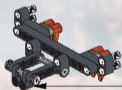
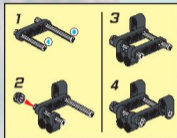

5

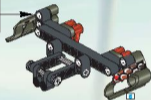

28

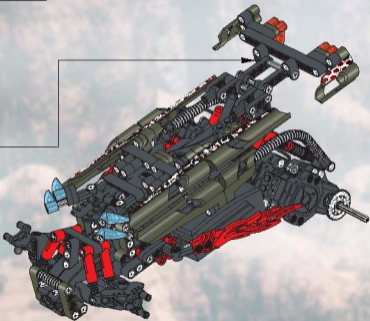



29

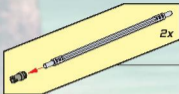





6x

1,5V

LR6
1:1

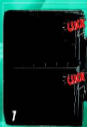

1x

9V

6LR01
1:1





1

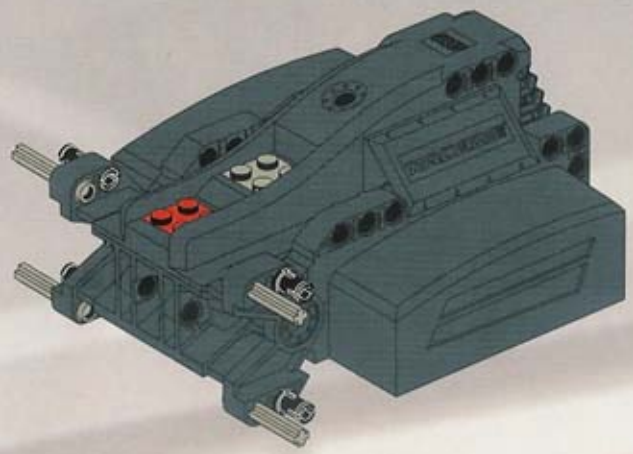



2

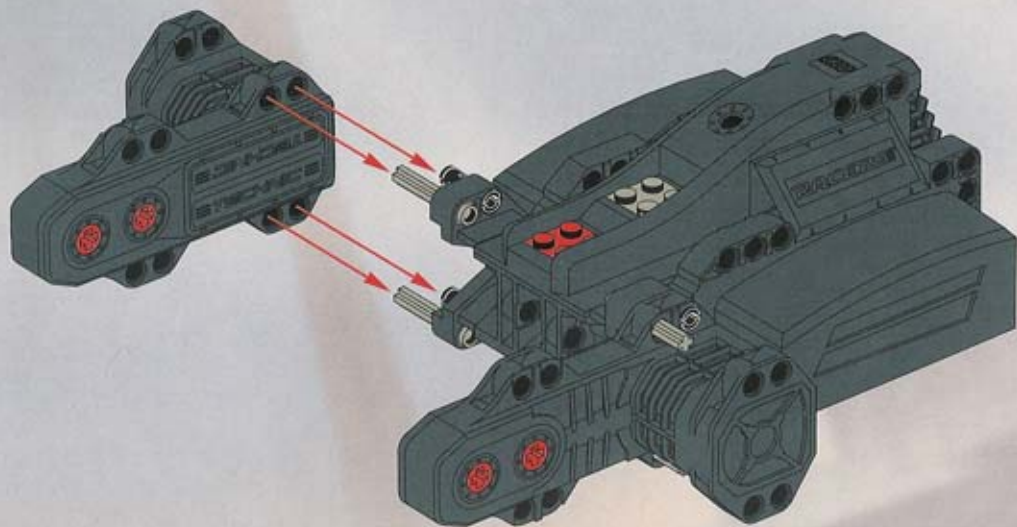



3

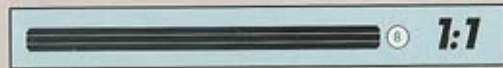
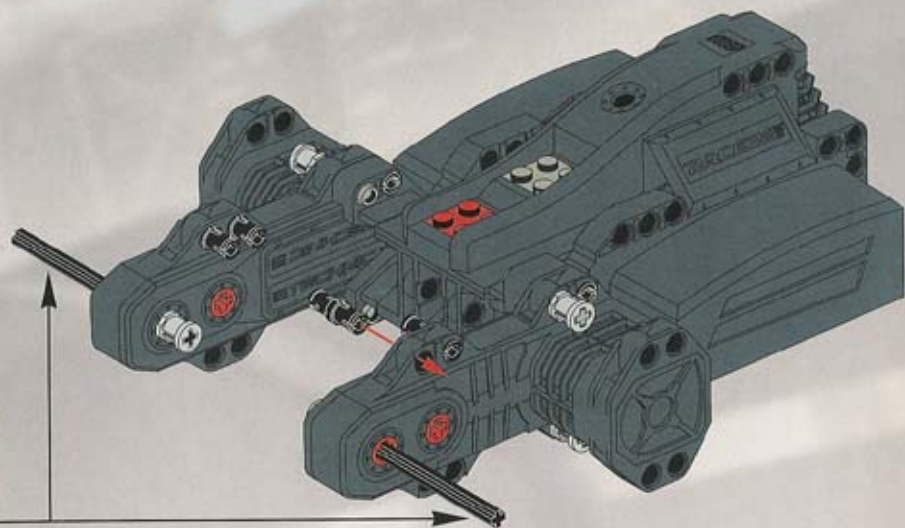

2x

2x

4

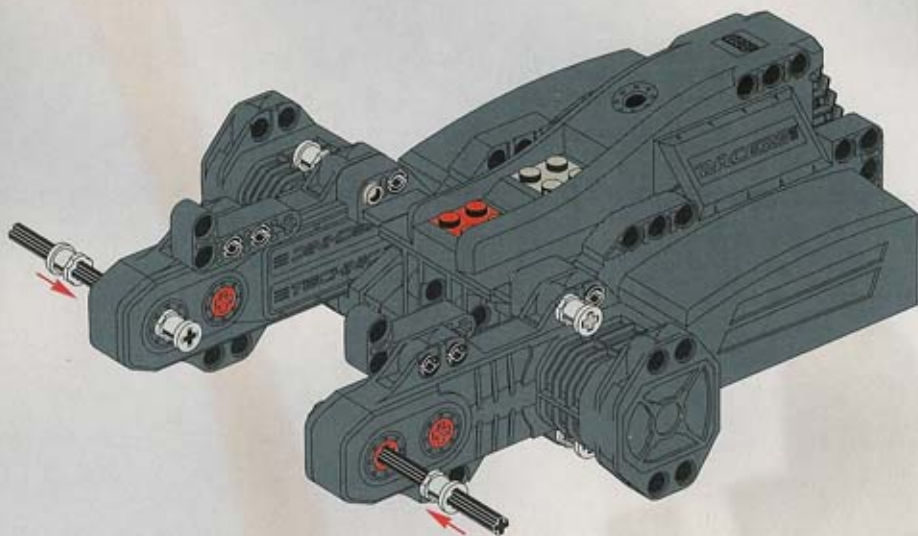



5

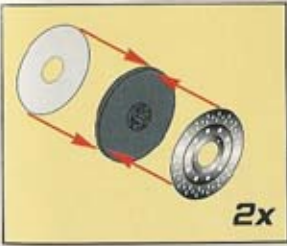
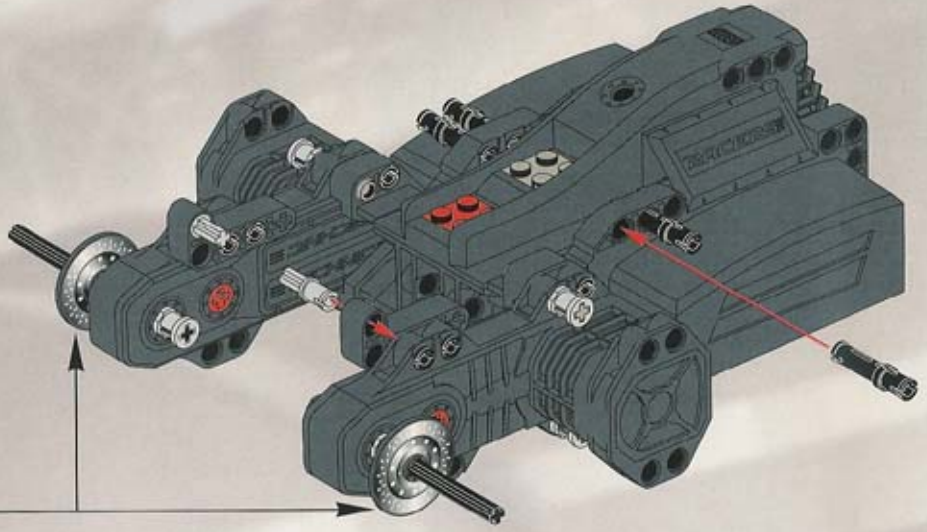

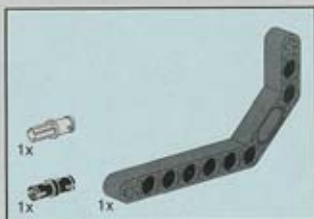

1



2

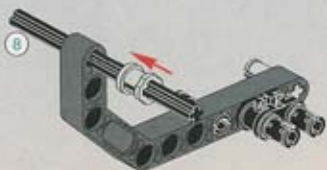

3



4

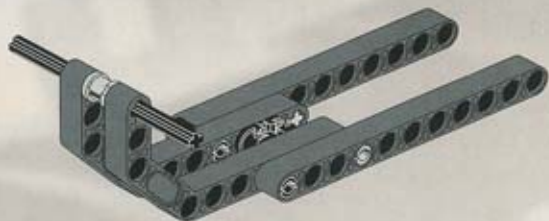



2x

5

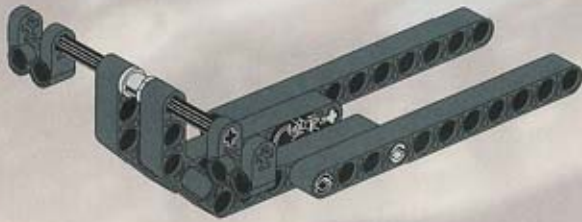

2x

6



2x



4x

7

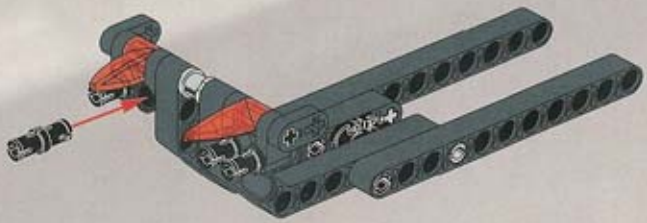

2x

4x

8

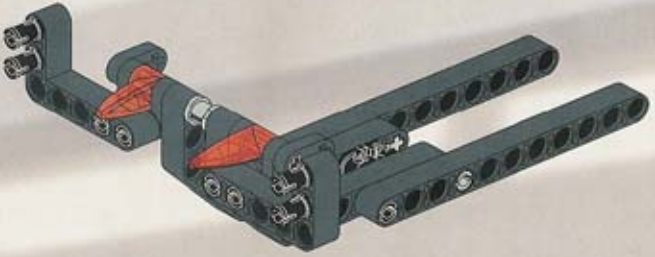

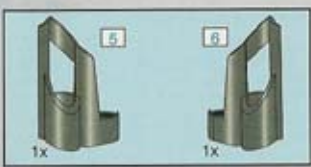

9

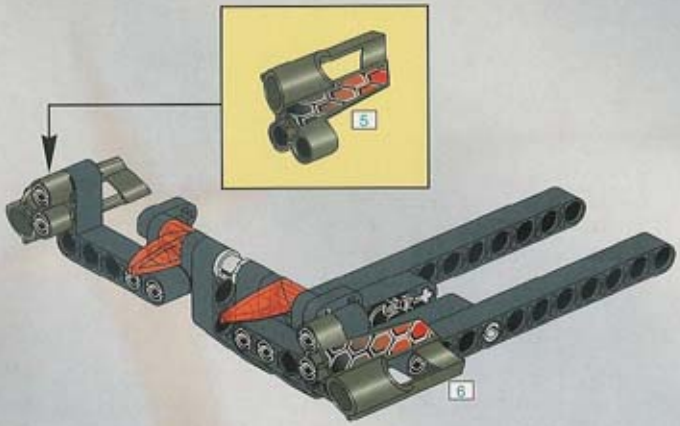

10

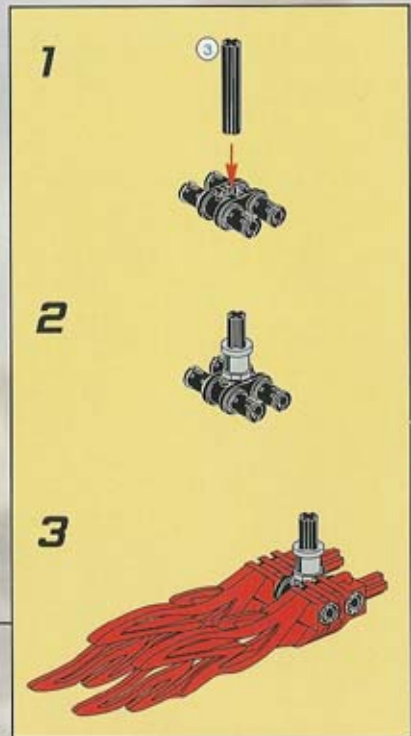
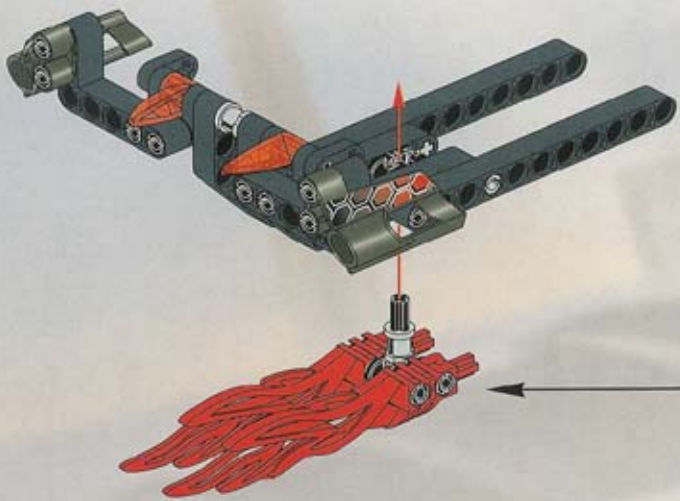



6

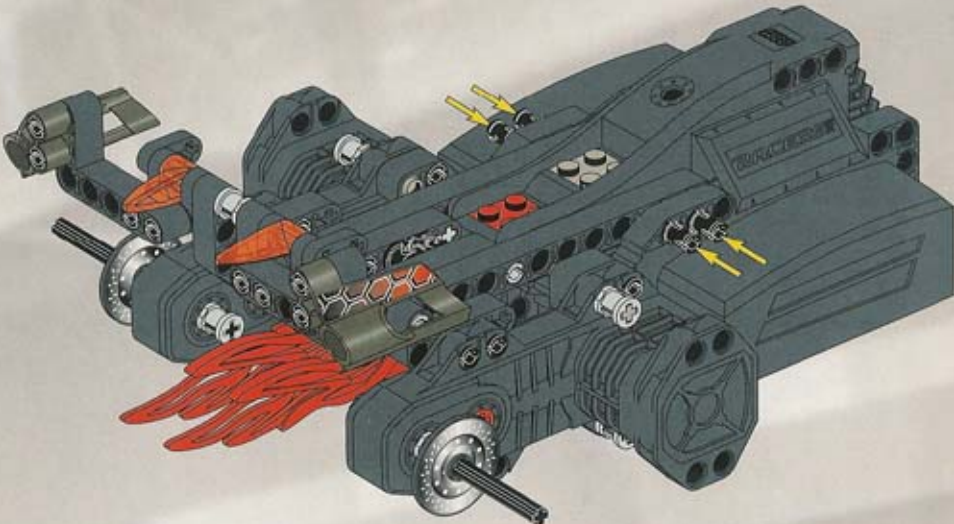

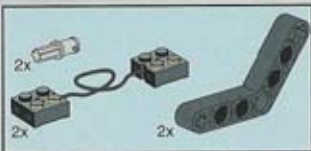

7

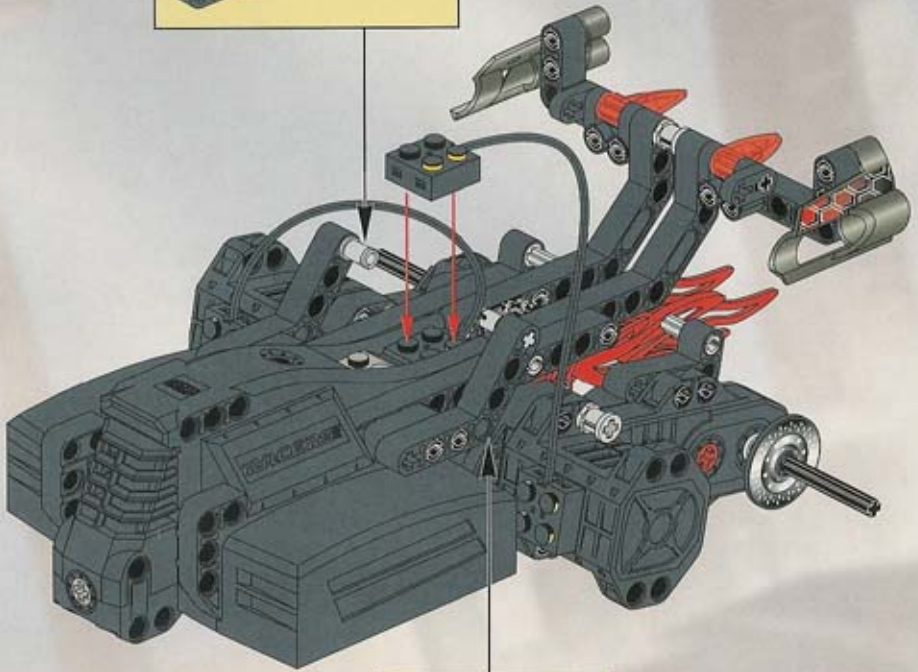
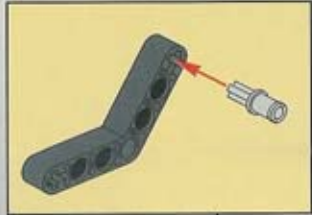



2x

8

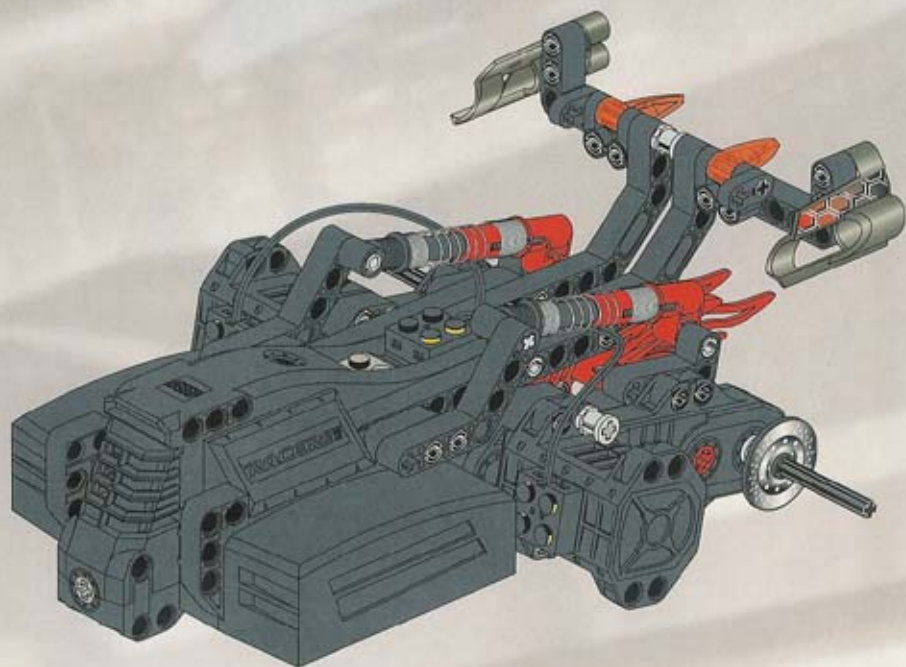



9

1



2

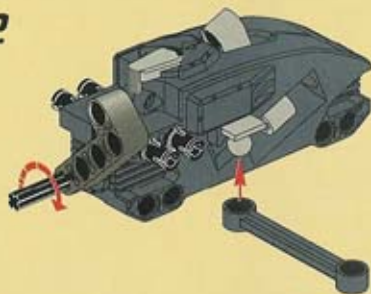

3

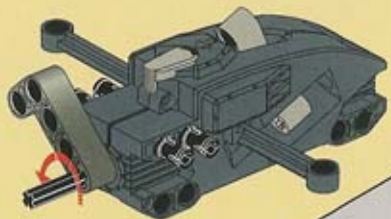

4

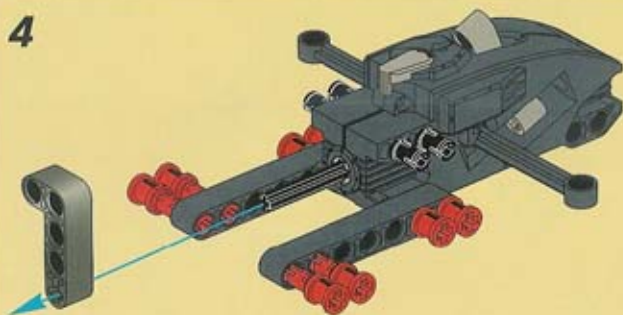

5

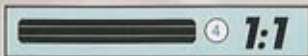
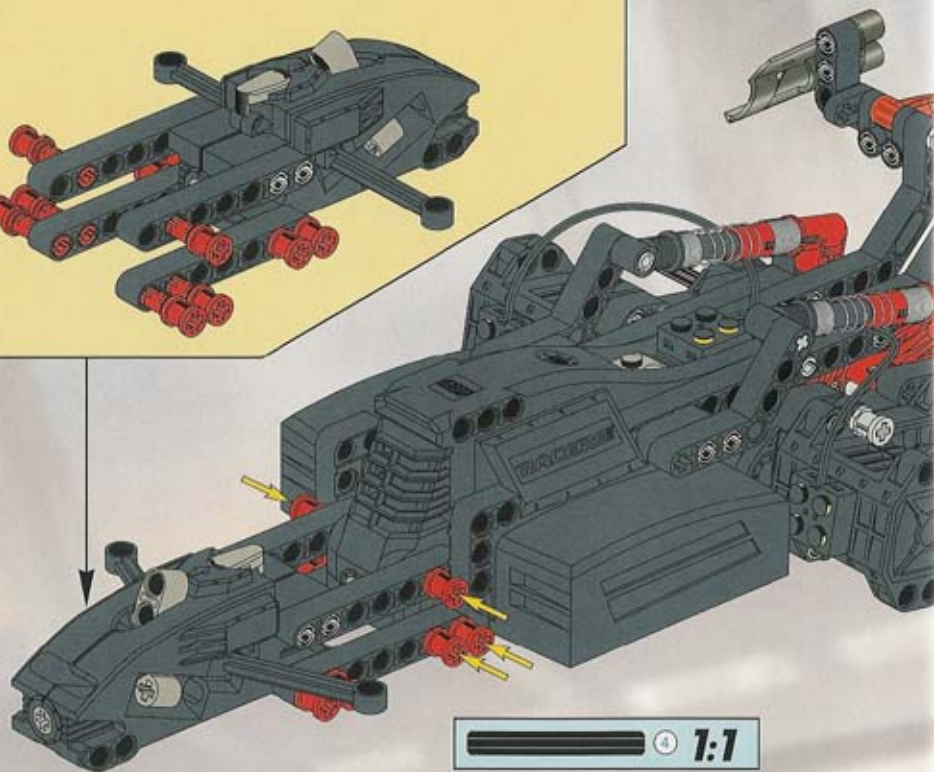
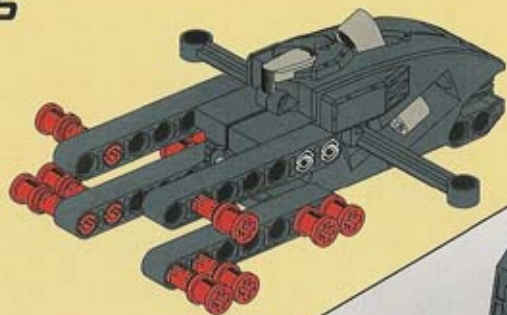

1:1



10

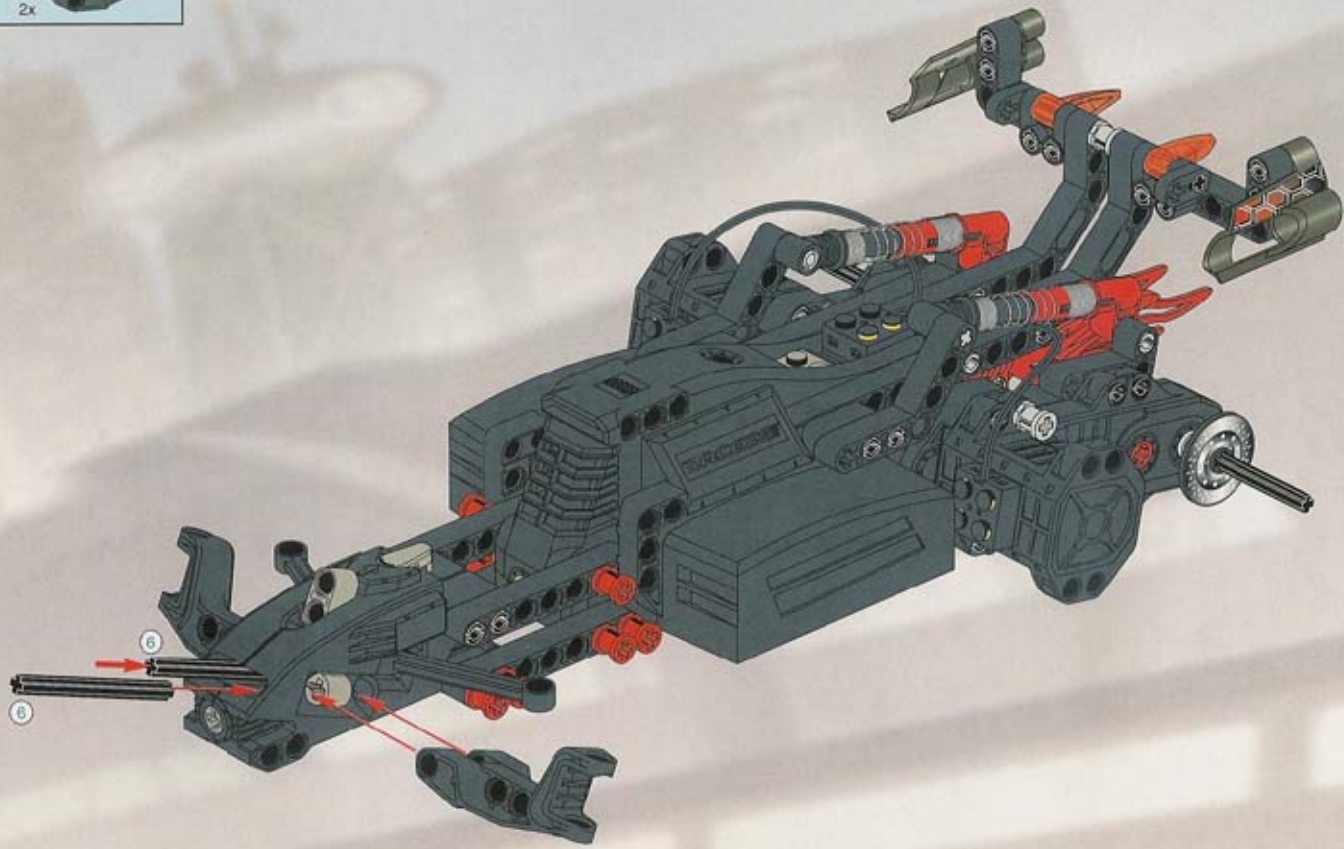



11

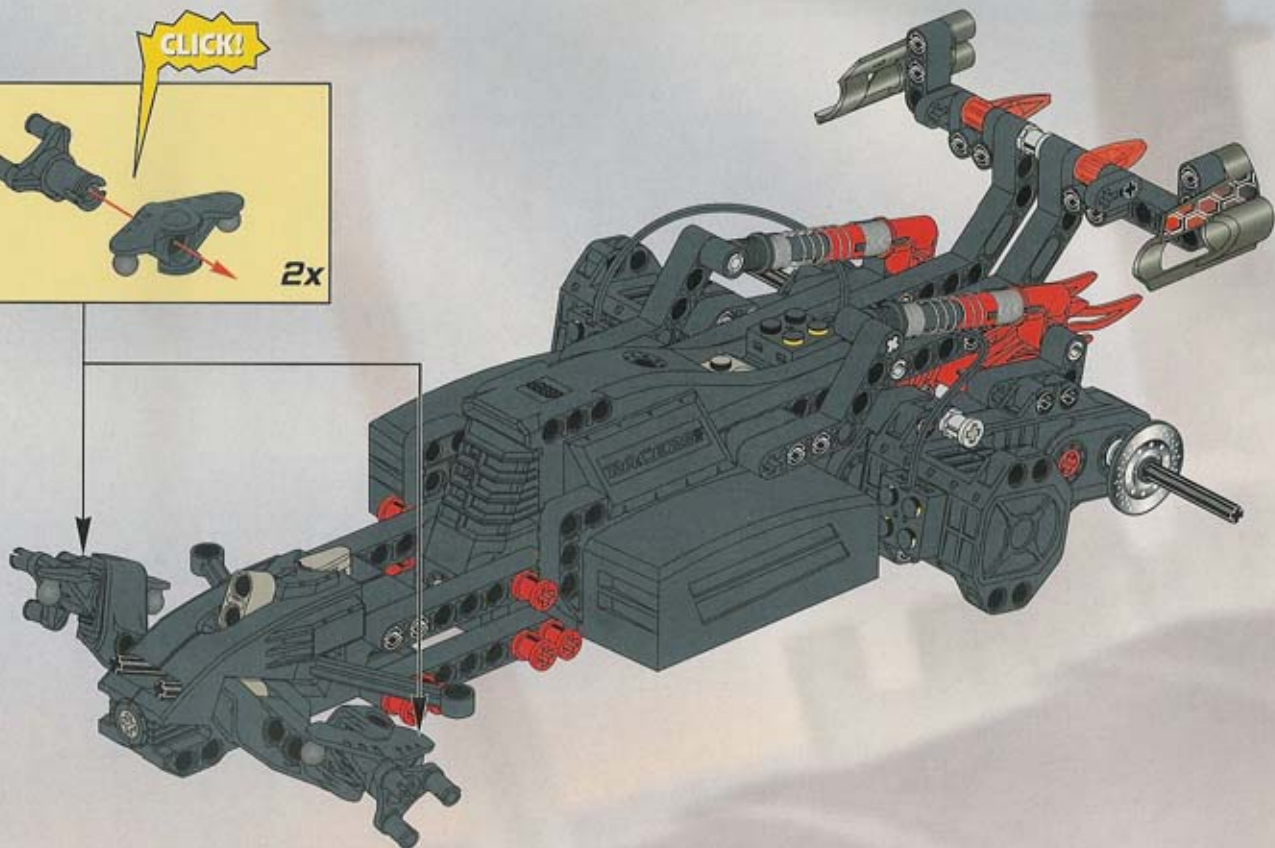

12

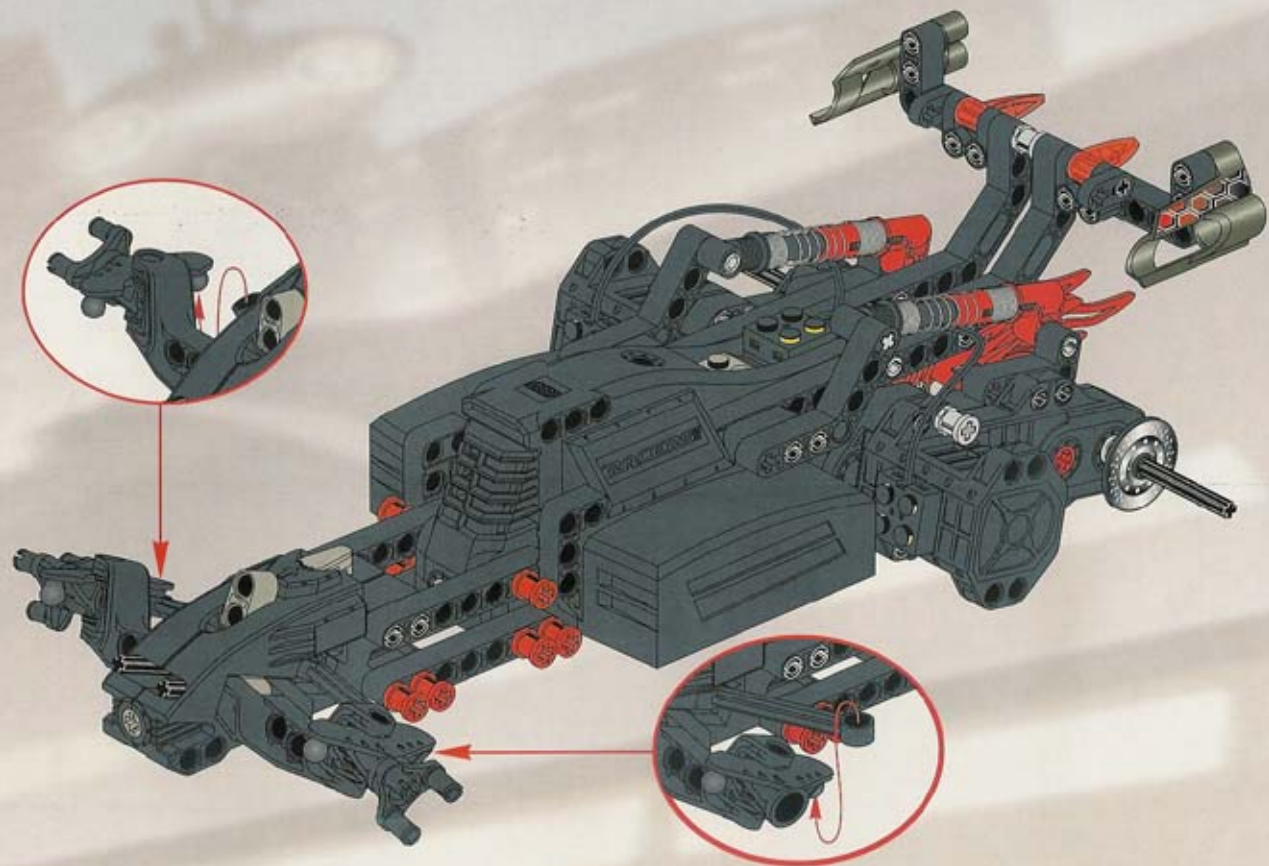



13

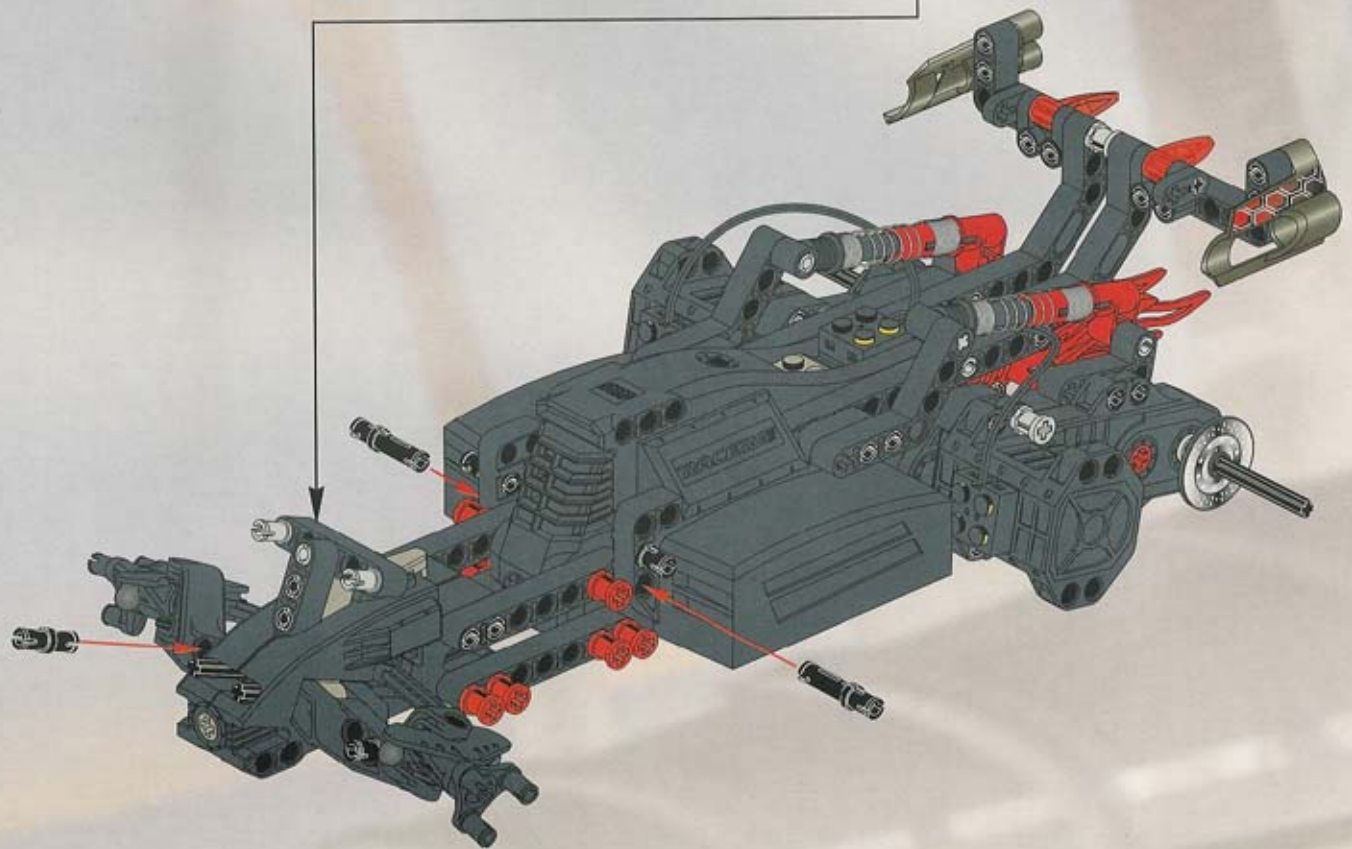
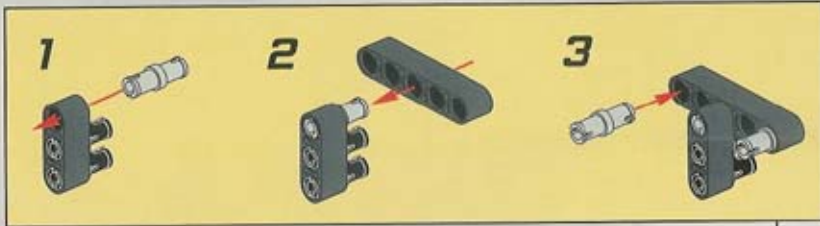



14



<p>1</p>	<p>3</p>	<p>5</p>
<p>2</p>	<p>4</p>	<p>6</p>

1:1

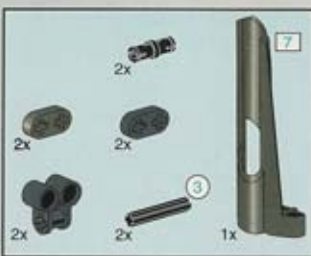

15

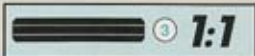
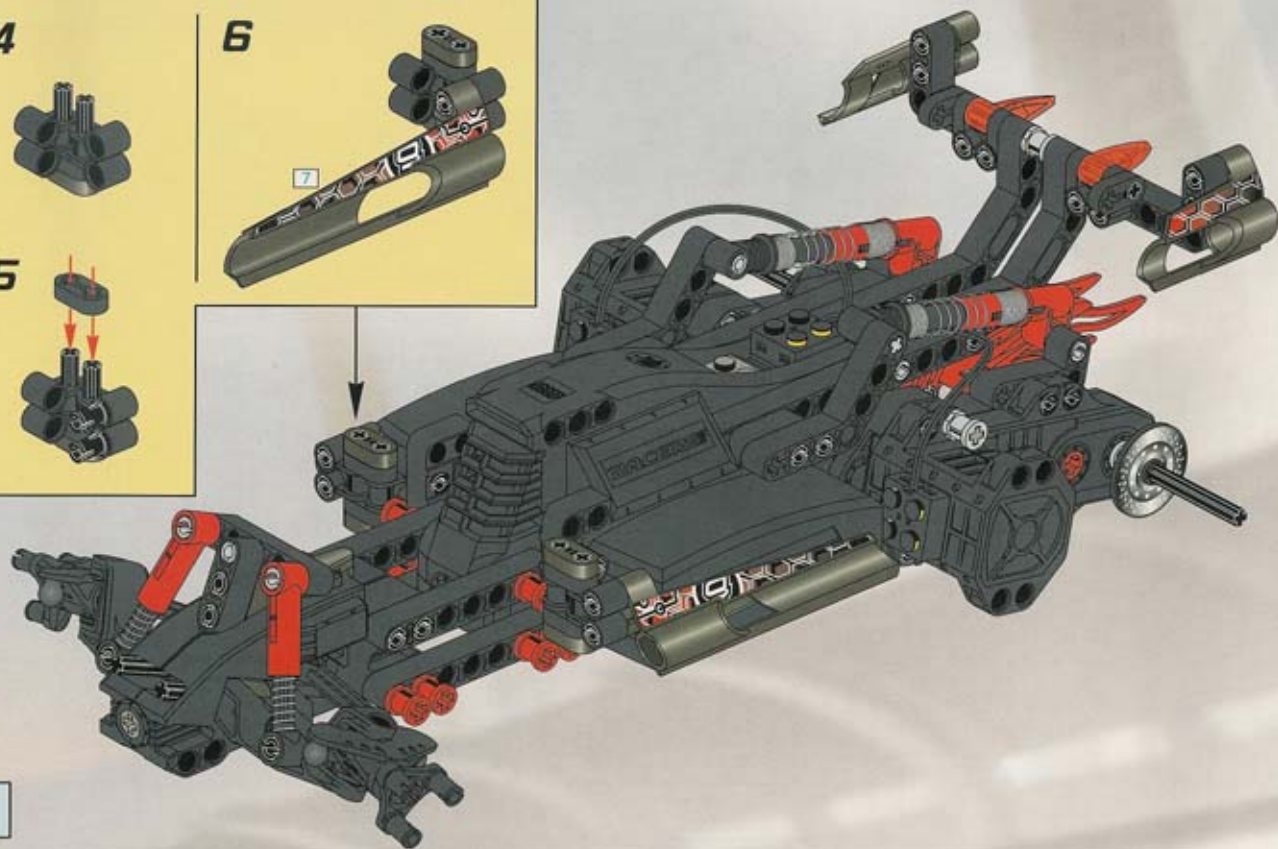
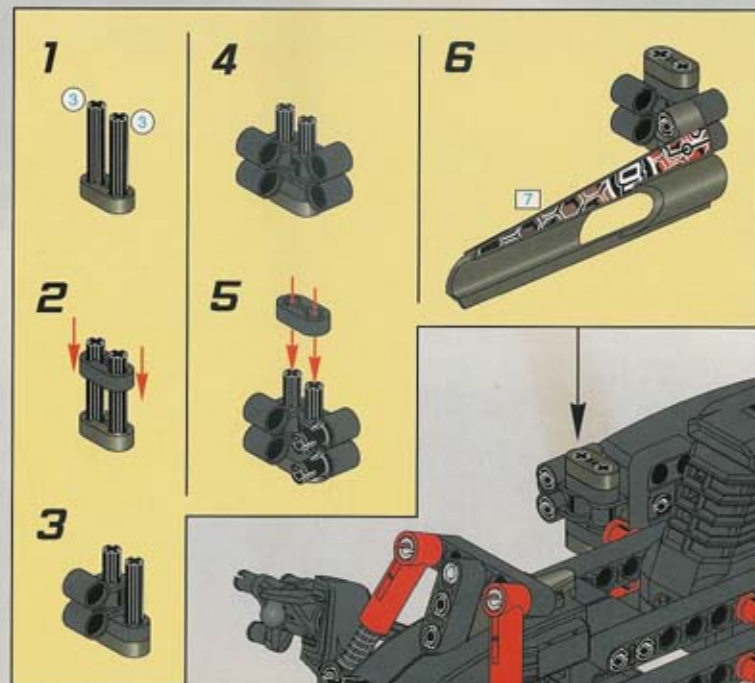



16

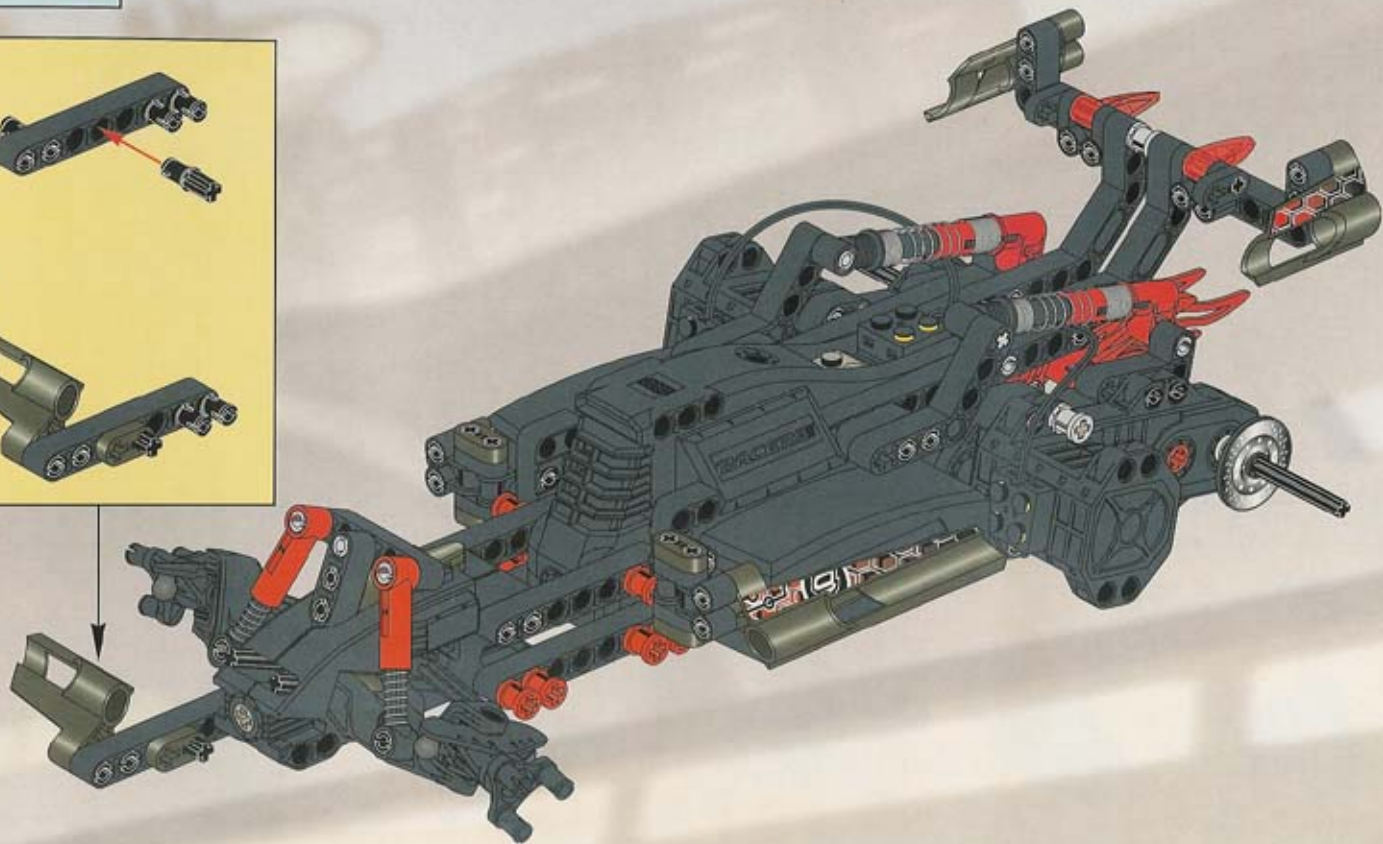
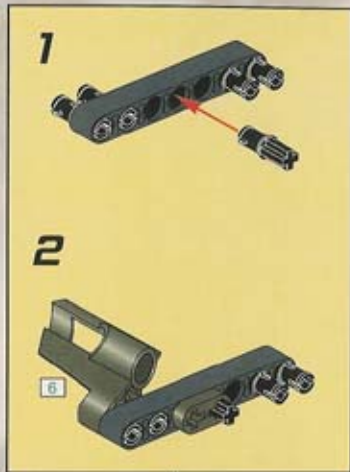



17

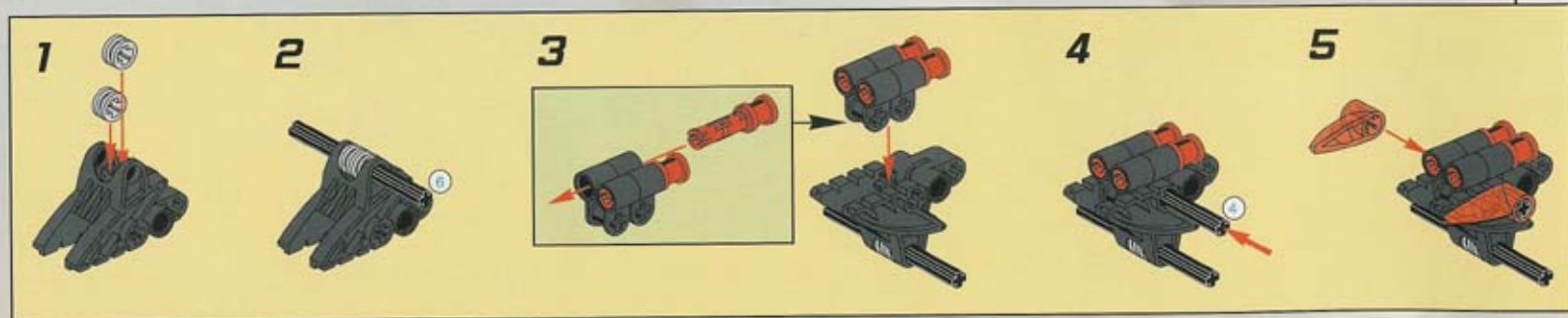
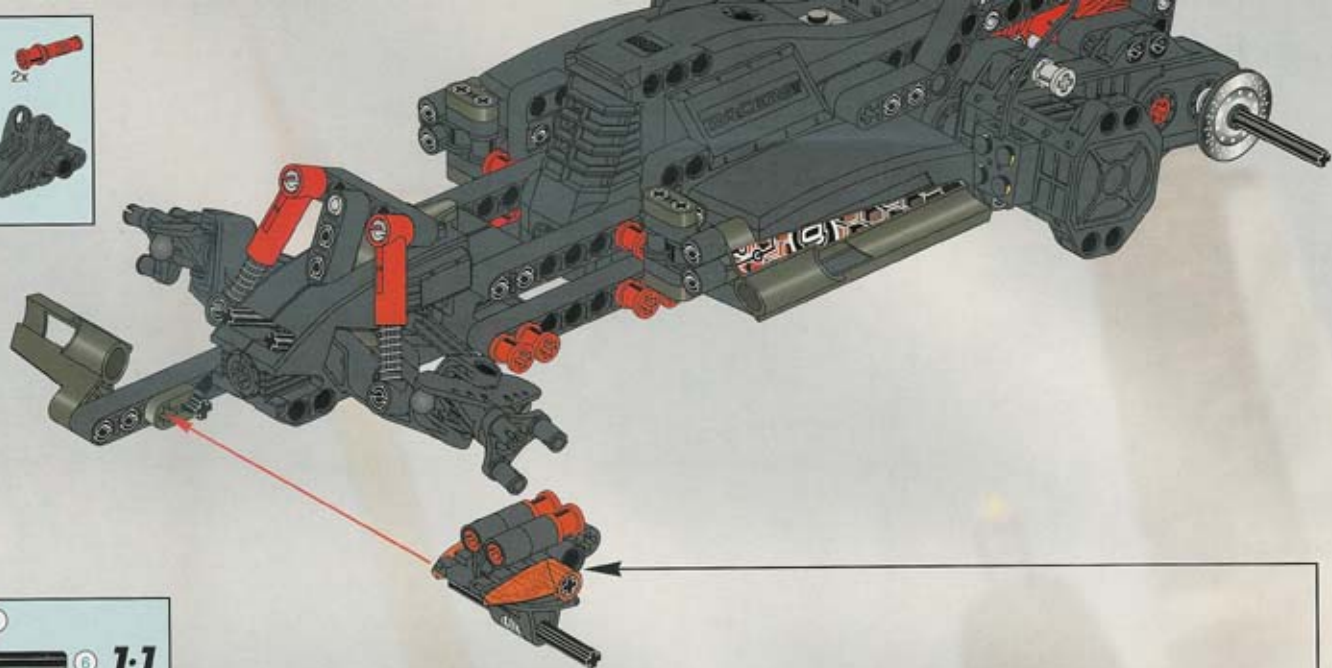

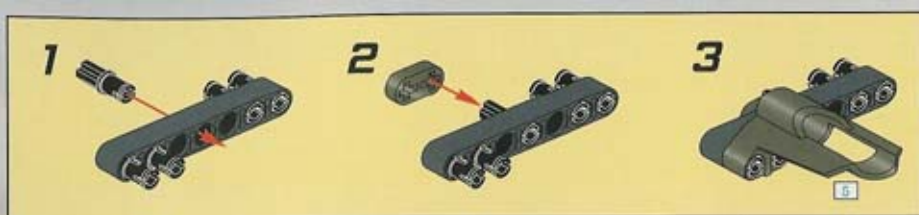
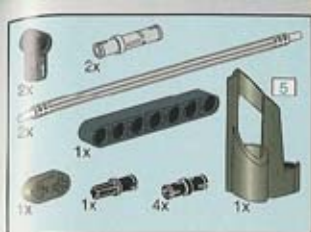

18

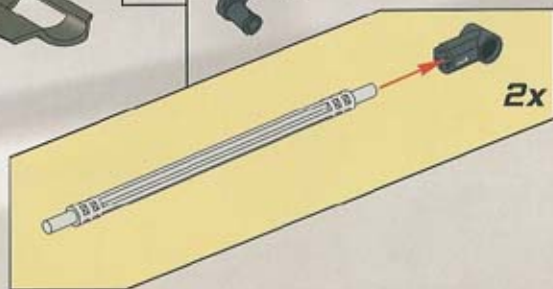
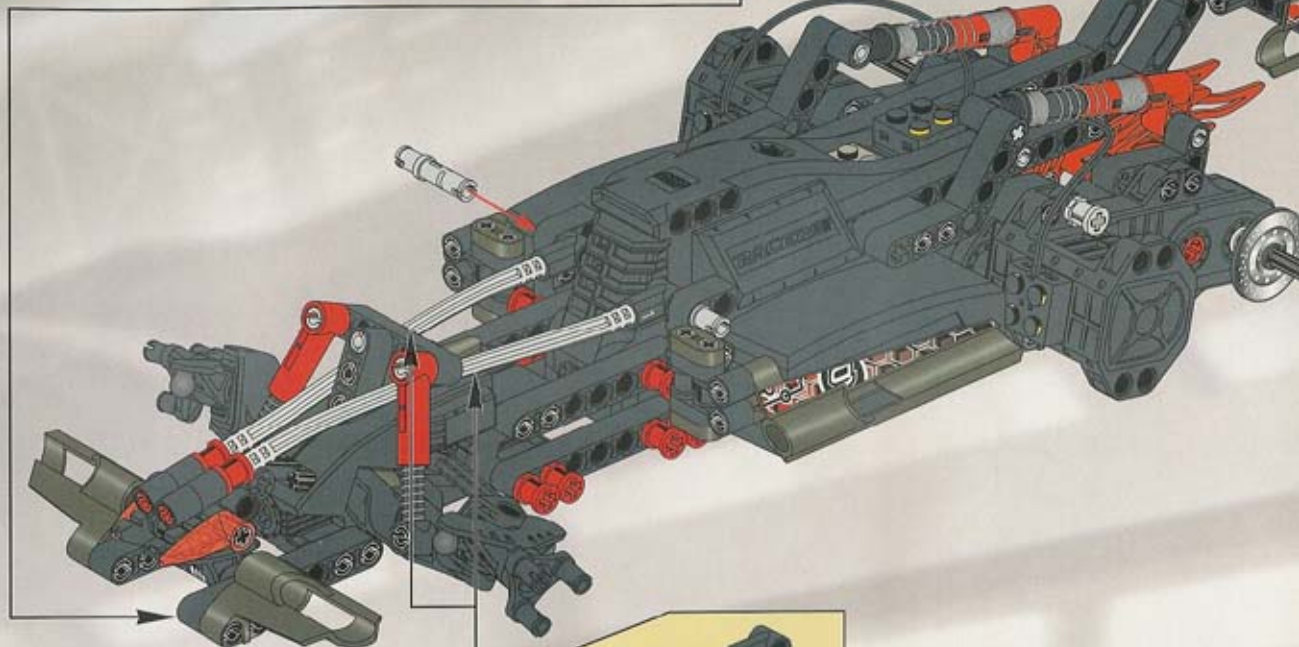

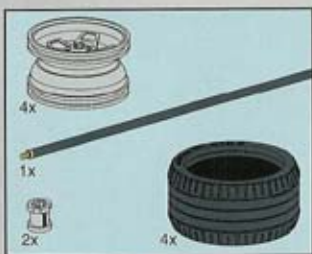

19

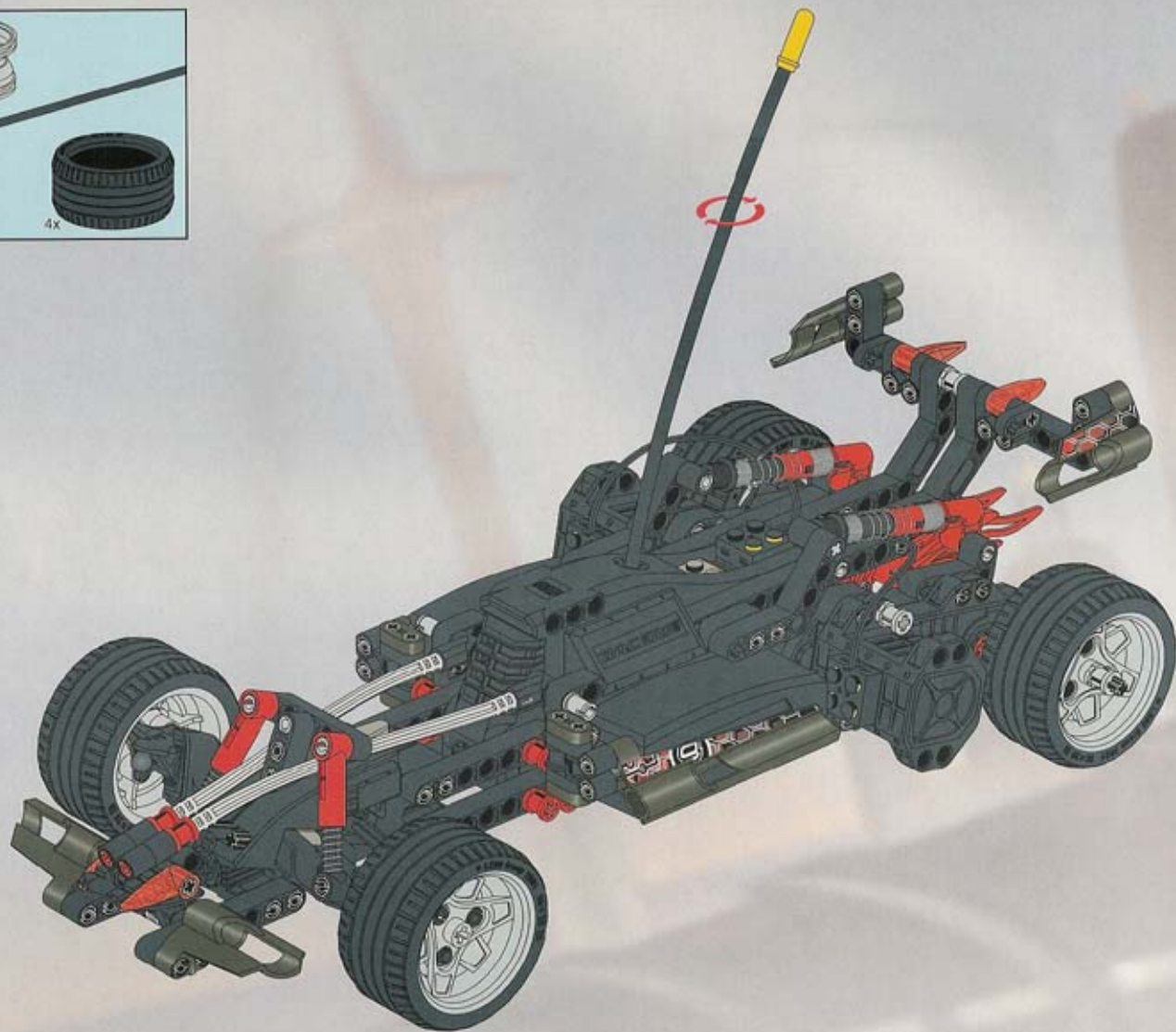



Channel 1 Channel 2 Channel 3



3 Channels

Channel 1 Channel 2 Channel 3



Channel 1

Channel 2

Channel 3

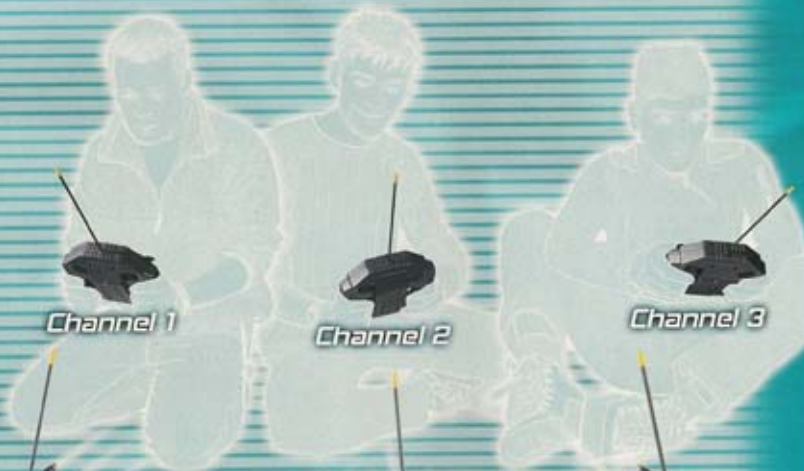



LEGO

just imagine...

Dear LEGO user
 Congratulations with your new LEGO product!
 We would very much like to know your opinion
 of this LEGO product.
 By answering a few questions you participate in
 a competition for valuable LEGO prizes.
 Please go to this internet address to answer
 the questions – it will take about 5 minutes:
www.aerlebnis.aim.dk/lego
 If you are younger than 15 years, please ask
 one of your parents to answer the questions
 together with you.
 This survey expires on 15 February 2003.
 Below you find some of the prizes you can win:
 LEGO Company

Cher consommateur LEGO
 Félicitations pour l'achat de votre nouveau
 produit LEGO! Nous aimerions bien connaître
 votre avis sur ce produit LEGO. En répondant
 à quelques questions, vous participez à
 un concours pour des prix en produits LEGO.
 Veuillez aller à cet adresse internet et répondre aux
 questions – cela vous prendra environ 5 minutes –
www.aerlebnis.aim.dk/lego
 Si vous avez moins de 15 ans, demandez s.v.p. à l'un
 de vos parents de répondre aux questions avec vous.
 Cette étude expirera le 15 février 2003.
 Au-dessous, vous pouvez voir certains des prix
 que vous pouvez gagner:
 La compagnie LEGO

Lieber LEGO Verbraucher
 Herzlichen Glückwunsch zu Deinem neuen LEGO
 Produkt! Wir möchten gerne Deine Meinung über
 dieses LEGO-Produkt wissen.
 Wenn Du einige Fragen beantwortest, kannst Du an
 einem Wettbewerb mit wertvollen LEGO-Preisen
 teilnehmen.
 Bitte auf dieser Internet-Adresse die Fragen
 beantworten – es dauert nur etwa 5 Minuten.
www.aerlebnis.aim.dk/lego
 Falls Du jünger als 15 Jahre bist, bitte Deine Eltern
 fragen, ob sie Dir dabei helfen.
 Ablauf des Angebotes: 15. Februar 2003.
 Hier siehst Du einige Produkte die Du gewinnen kannst.
 LEGO Company

レゴユーザーのみならずへ
 レゴ新製品の発売に感謝しております。
 このレゴ製品の品質に関するあなたの感想を聞かせてください。
 質問に答えていただくことで、貴重なレゴ製品がらうせんをいただきます。
 質問に答えるには、次のインターネットアドレスに入ってください。
 —5分ほどで終了します—
www.aerlebnis.aim.dk/lego
 15歳に達していない方は、ぜひご両親と一緒に答えてください。
 締め切りは、2003年2月15日です。
 ここにいくつかの賞品を写真がけいします。
 レゴ社



LEGO

RACERS



- T1
- T2
- T3
- T4
- T5
- T6
- T7

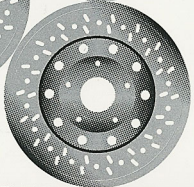
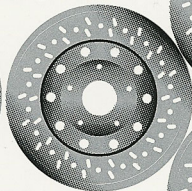
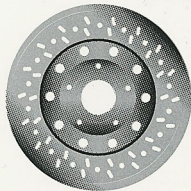

43475/4172598 © 2002 LEGO GROUP

