

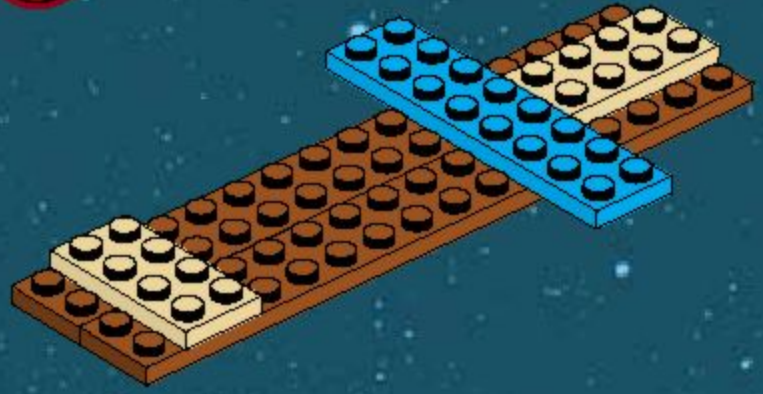

7155

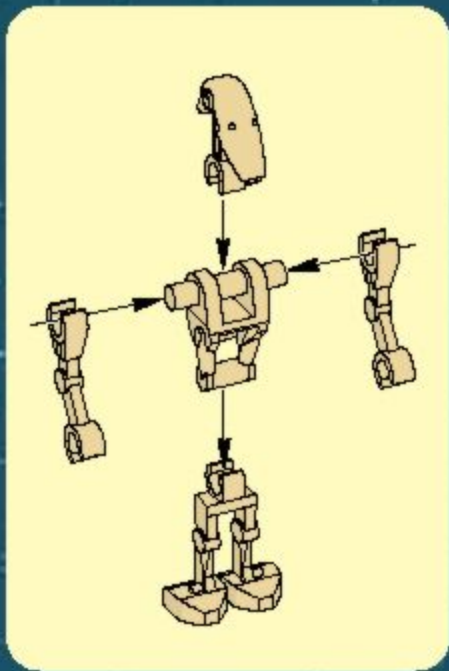

TRADE FEDERATION AAT™





3

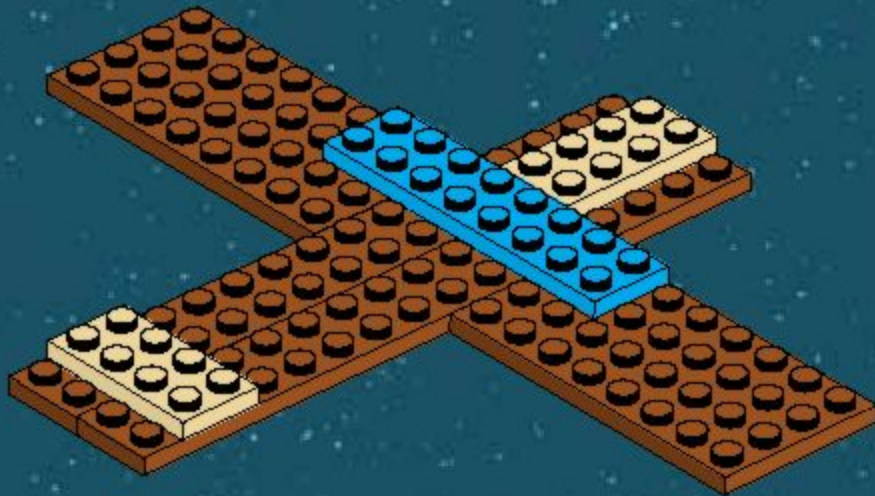



4



5

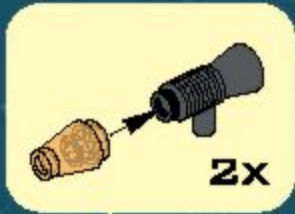



6





7

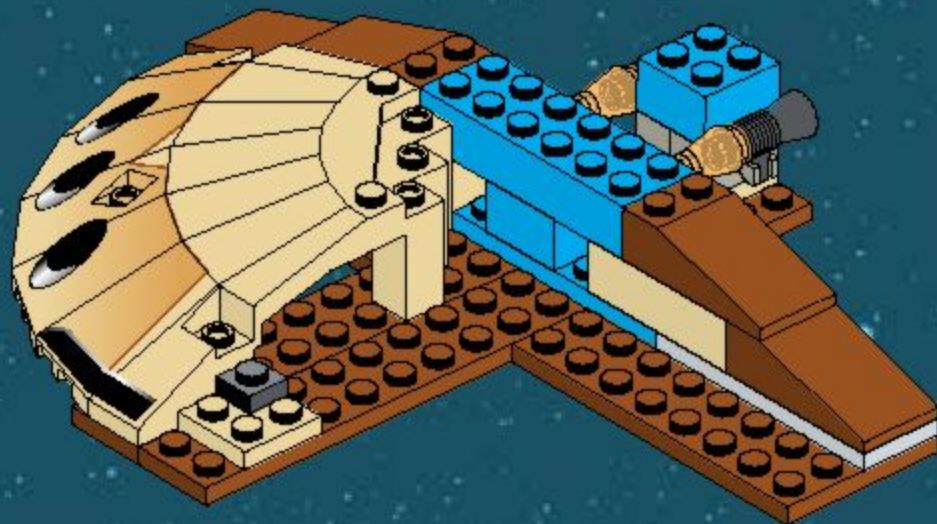

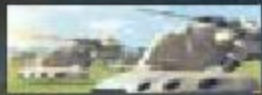





9





10





11



12





13

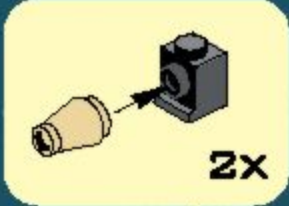



14

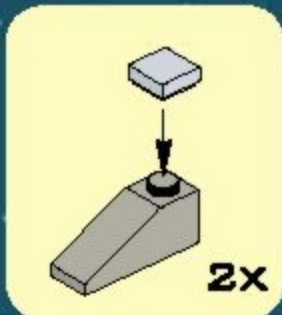

15





1

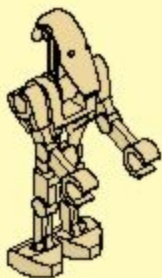

2

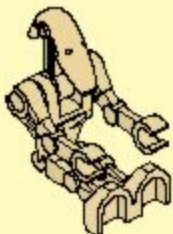

16

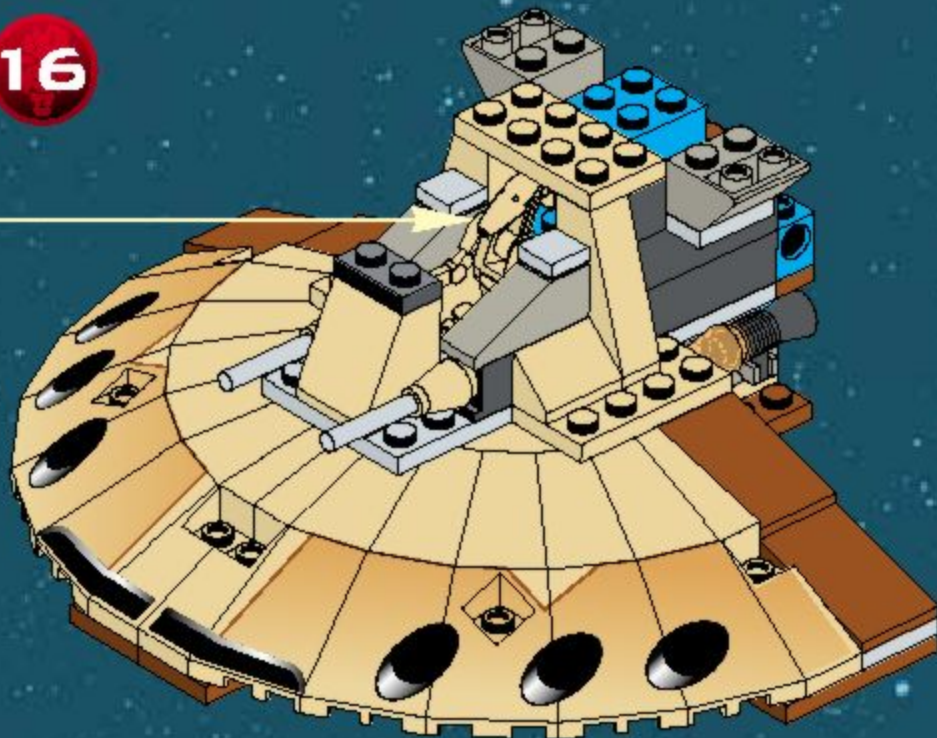





17





1



2



3



4



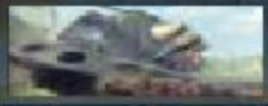

5



7



6



8





1

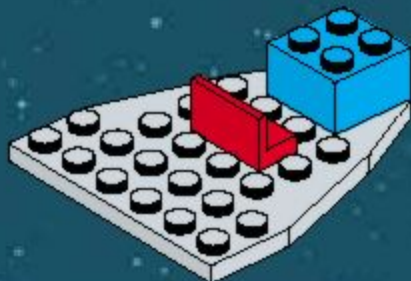

2



3

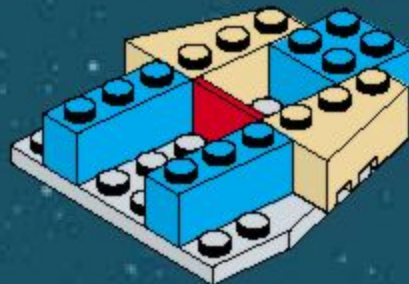

4

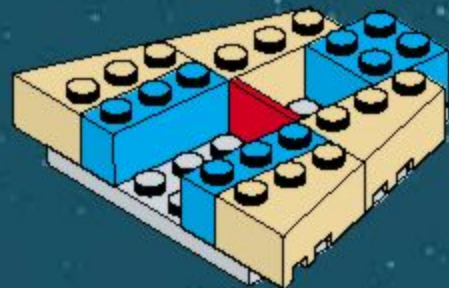



5

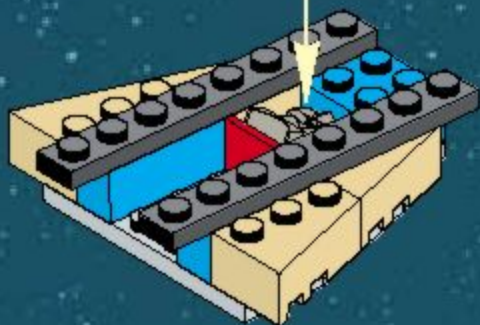

6

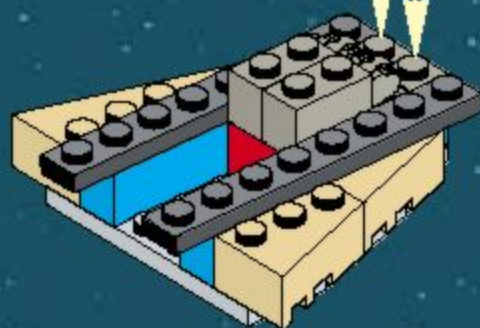
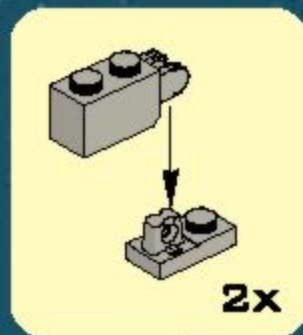



7

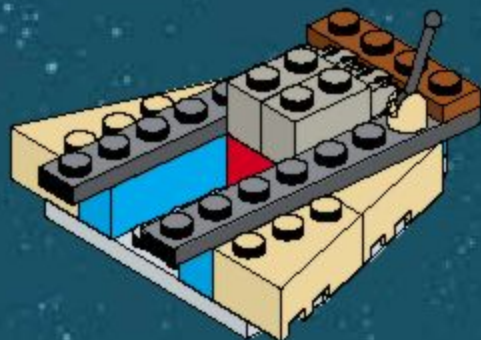

9



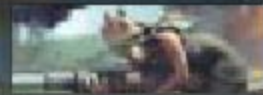

10



11

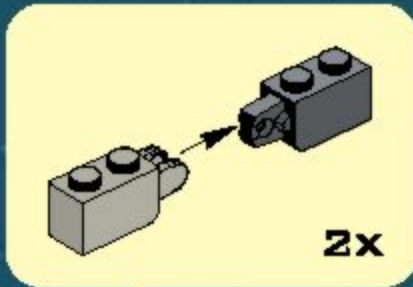

2x

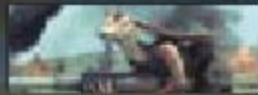

1



2



3



12



13

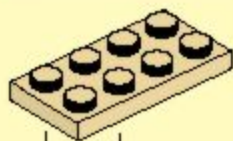





18

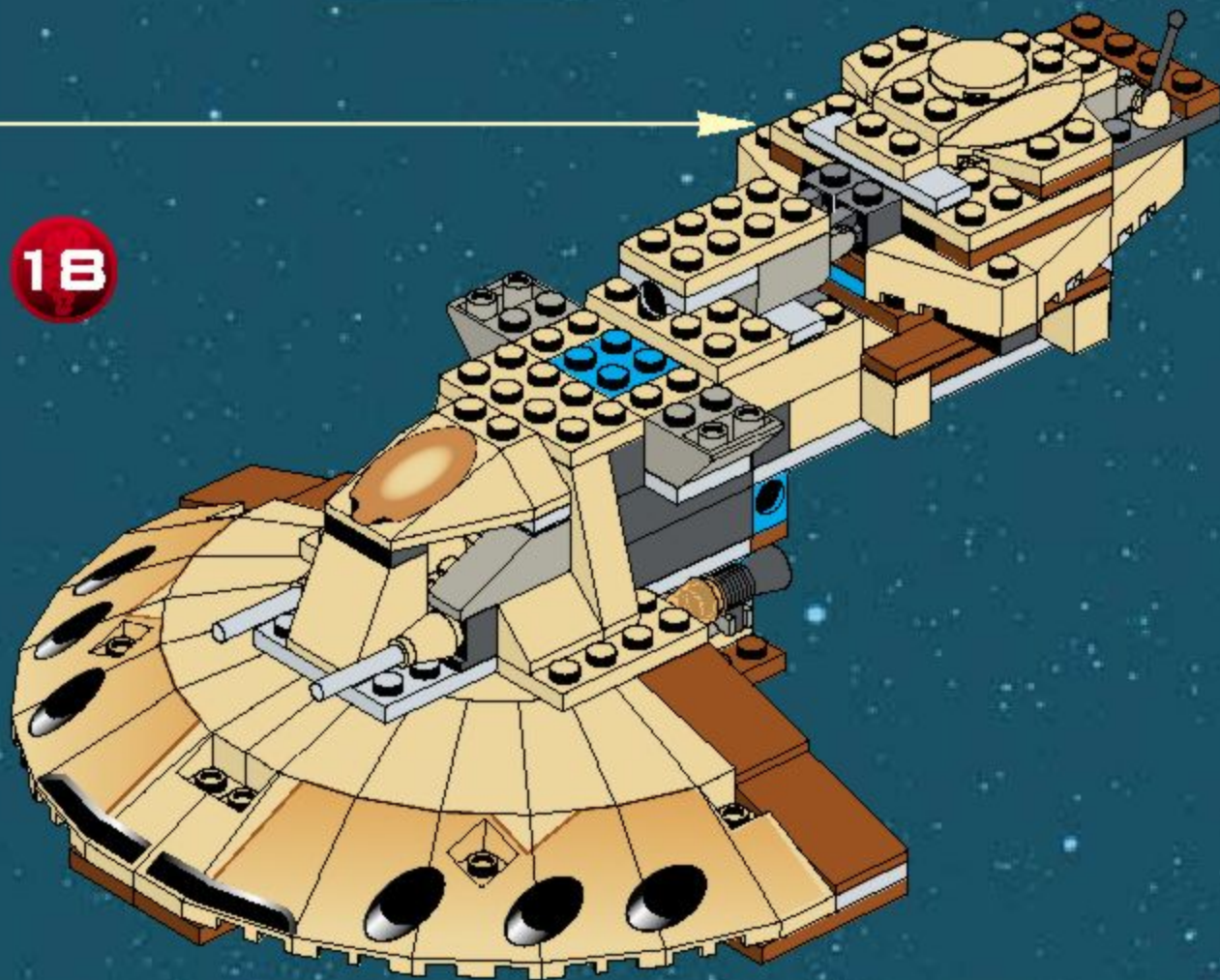

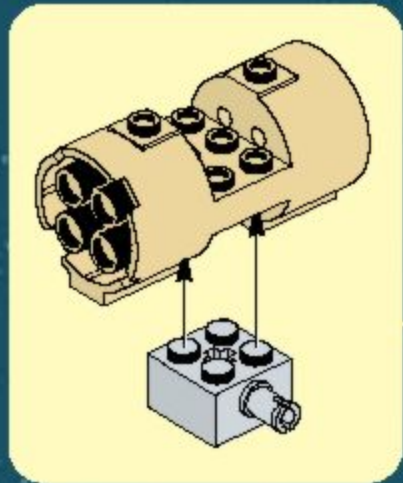

19

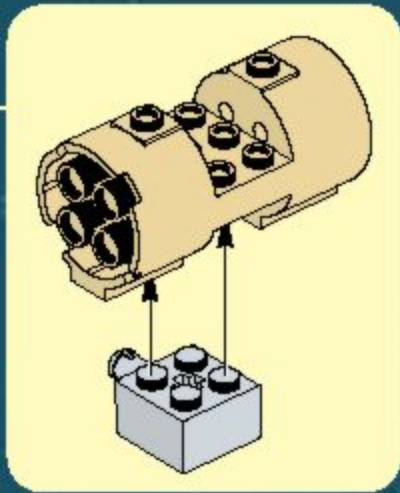
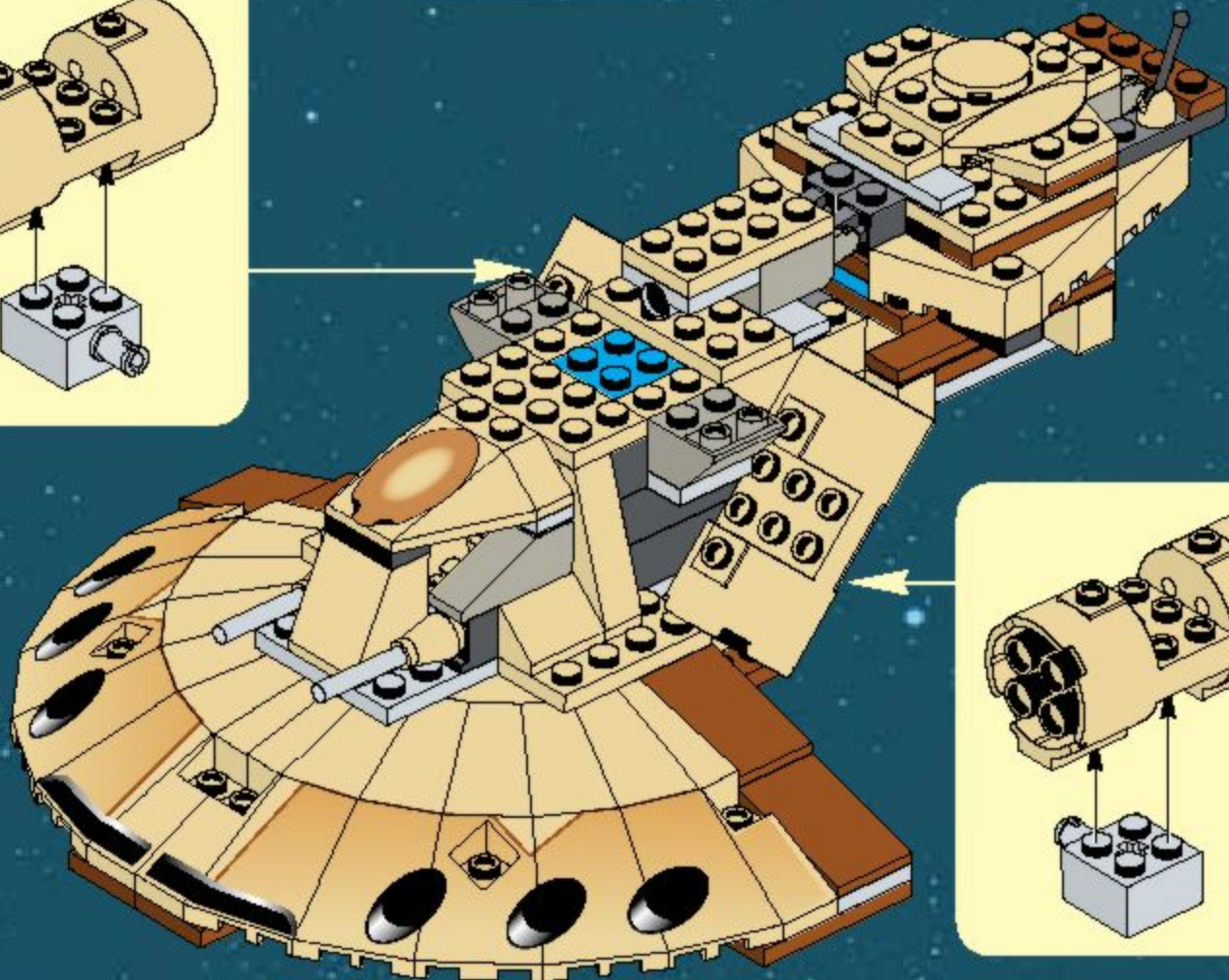

20



1

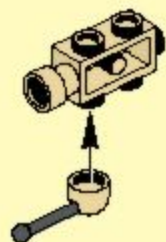

2

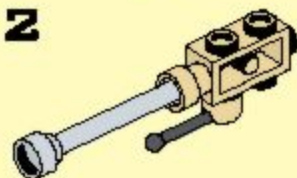

21

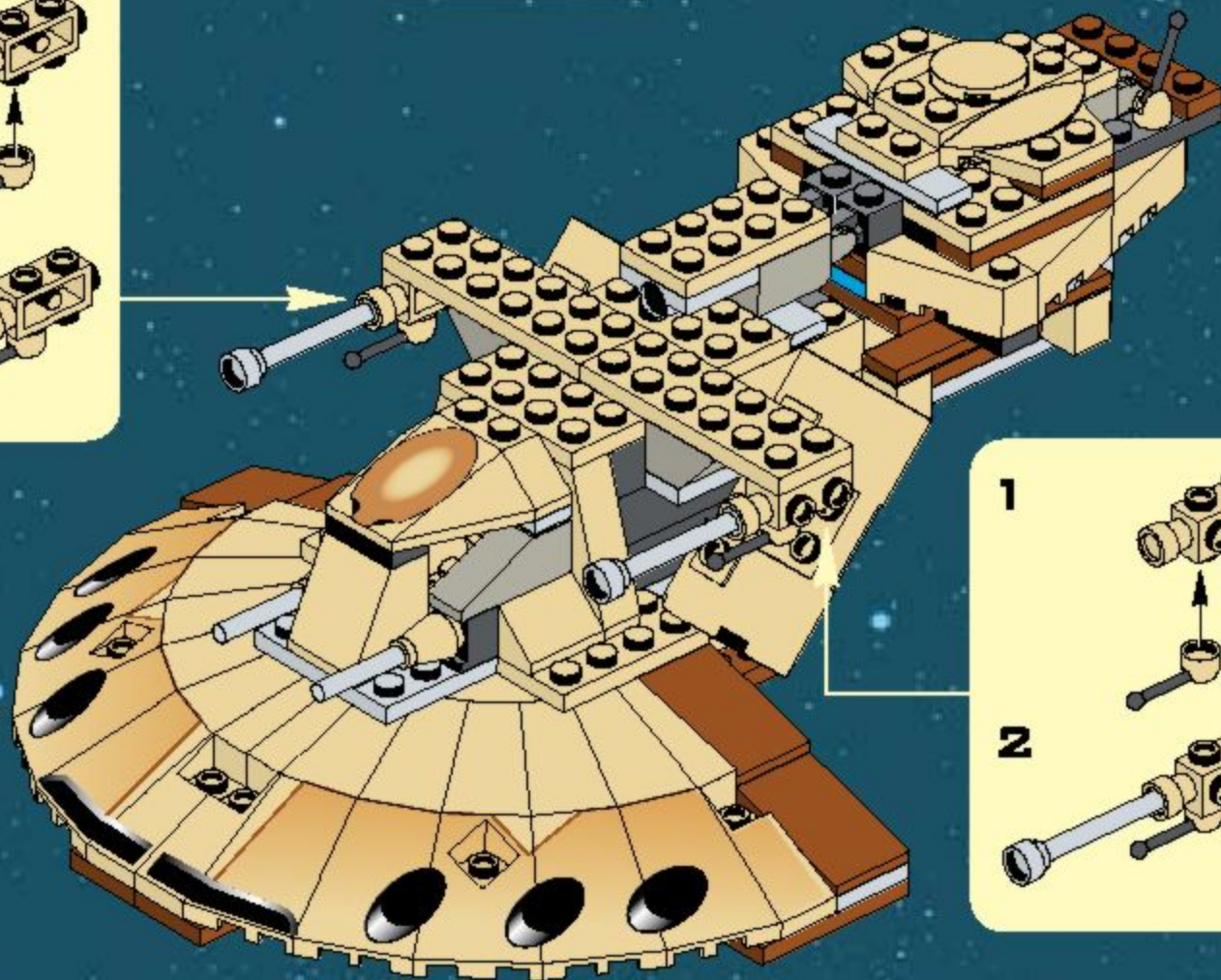

1

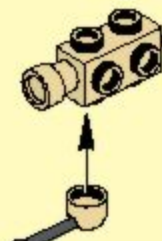

2

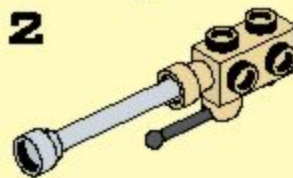



- 1
- 2
- 3
- 4

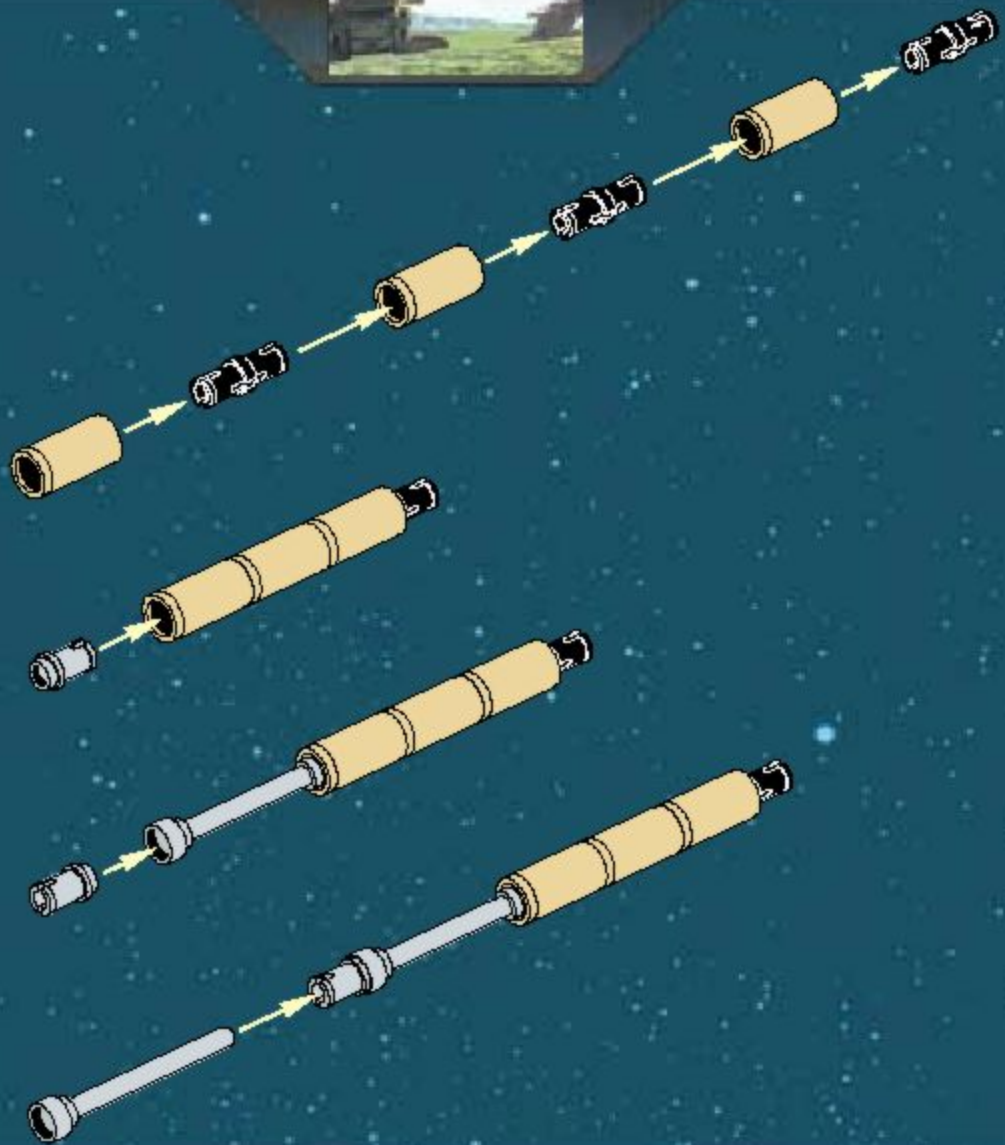



22





