

1



2



3

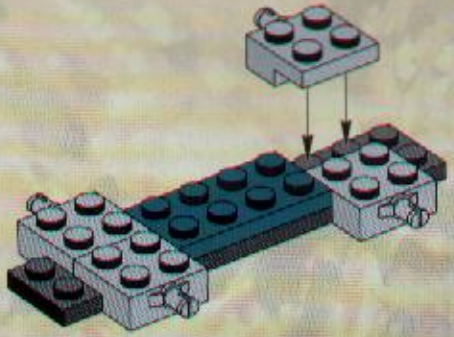

4

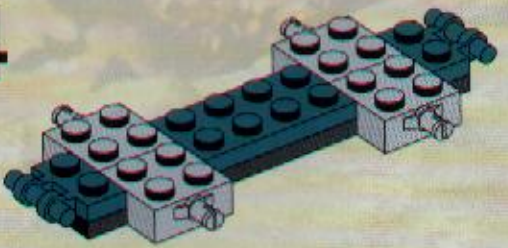

5

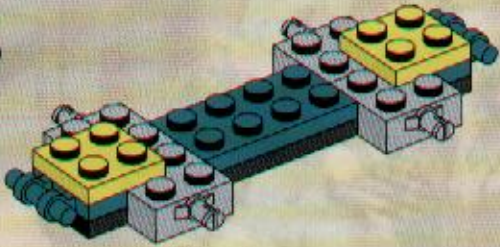

8

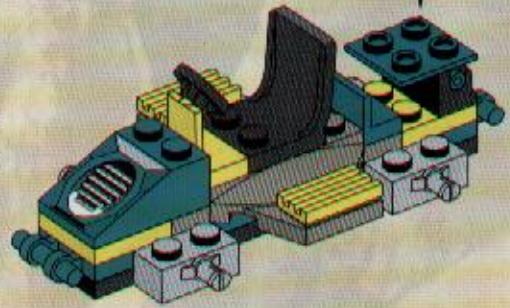

6

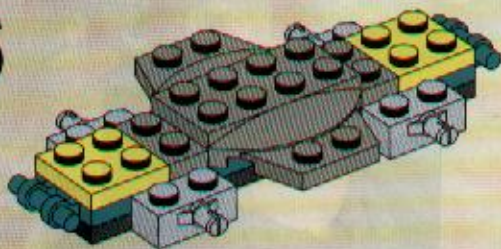

9

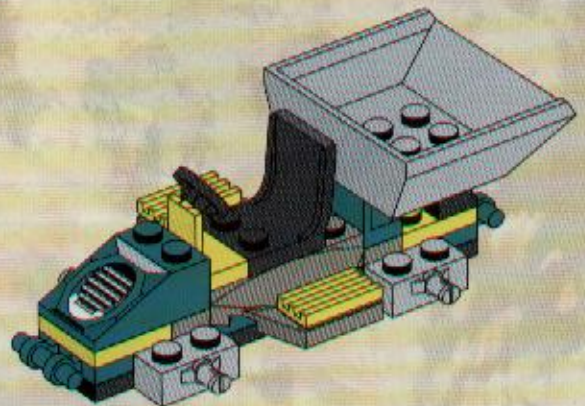

7

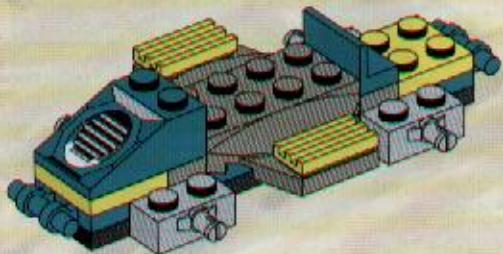

10

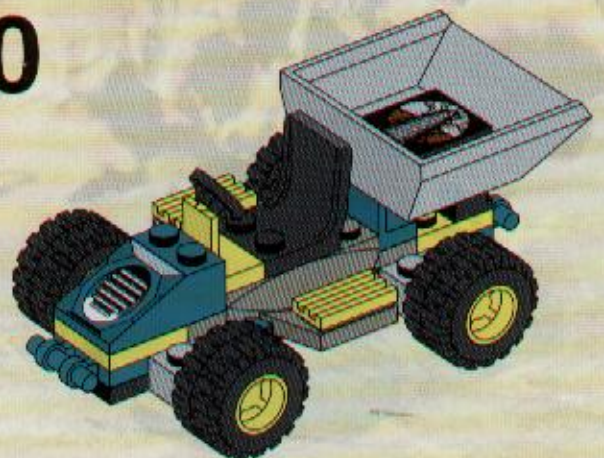



1



2



3

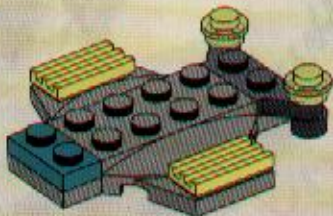

4

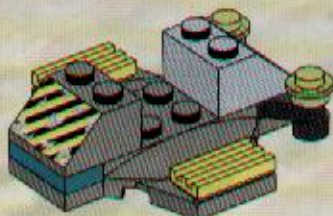

5



6

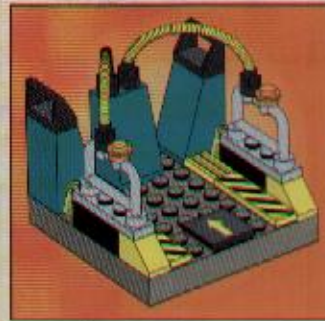

1

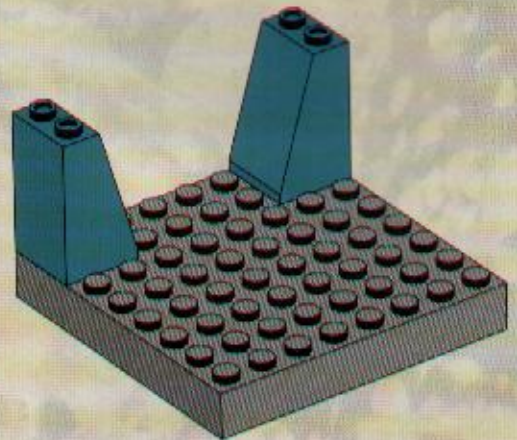

2

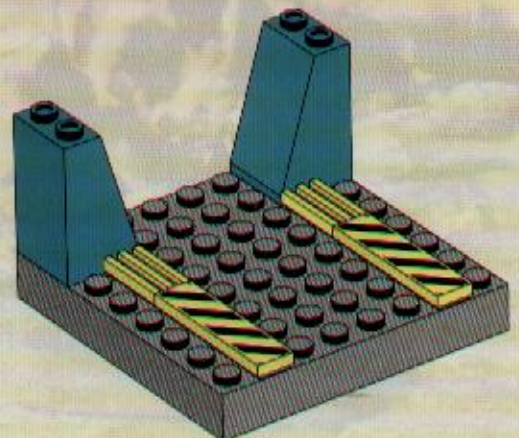

3

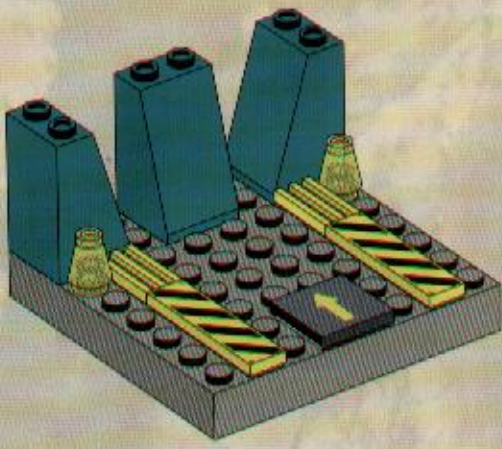

4

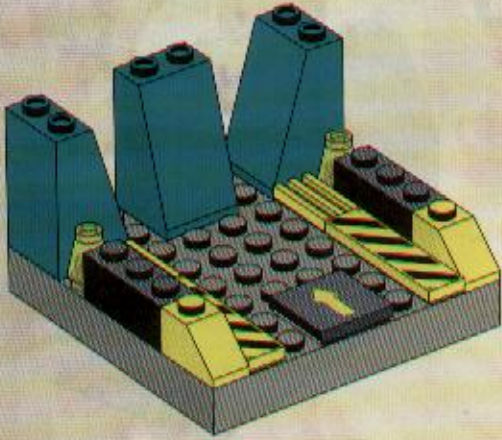

5

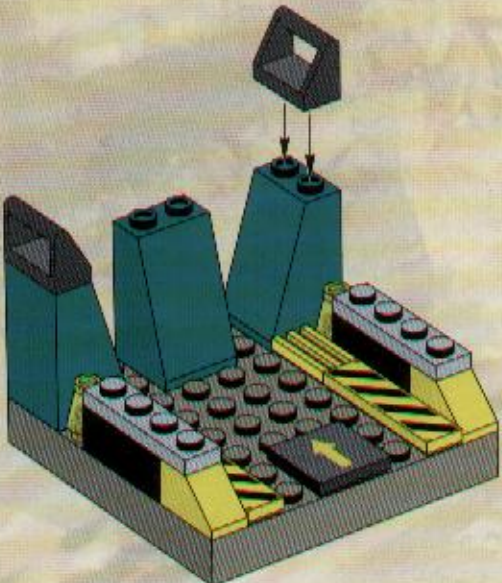

6

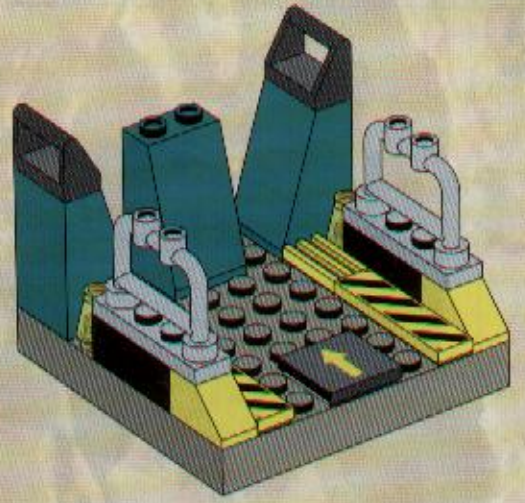

7

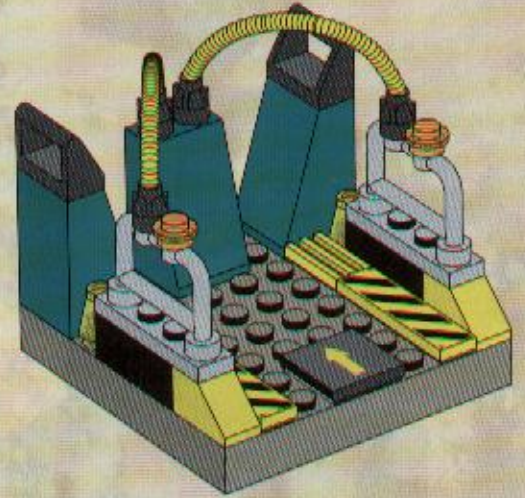

1

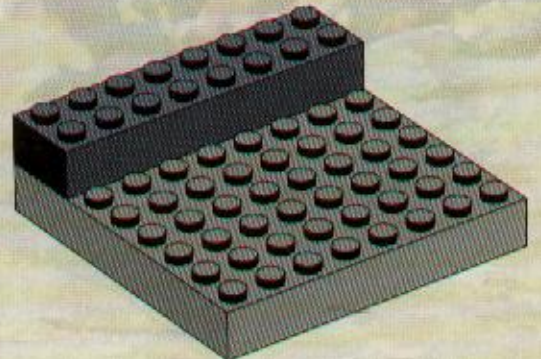

2

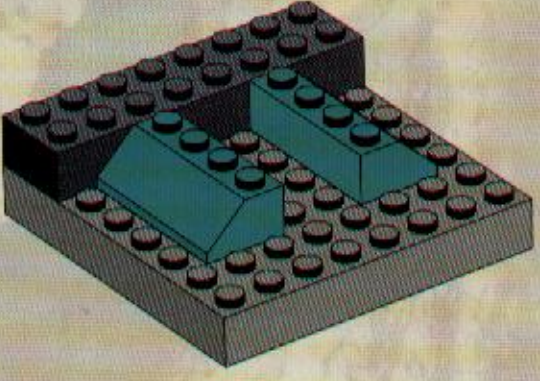

3

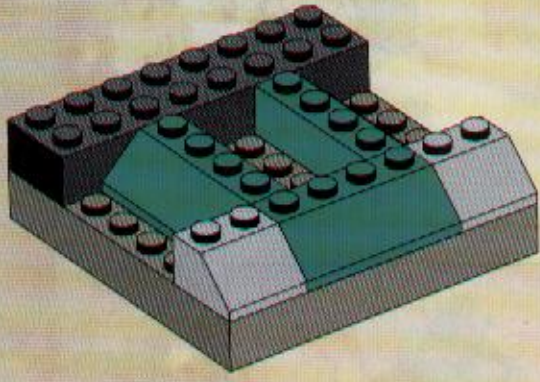

4

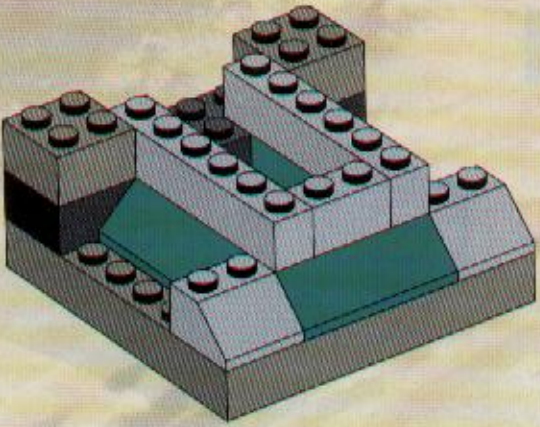

5

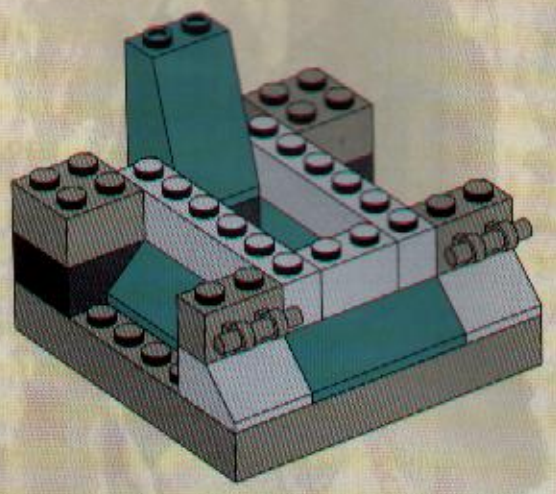

6

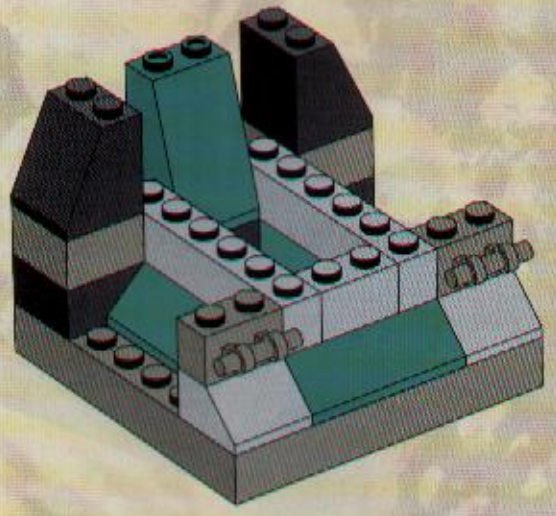

7

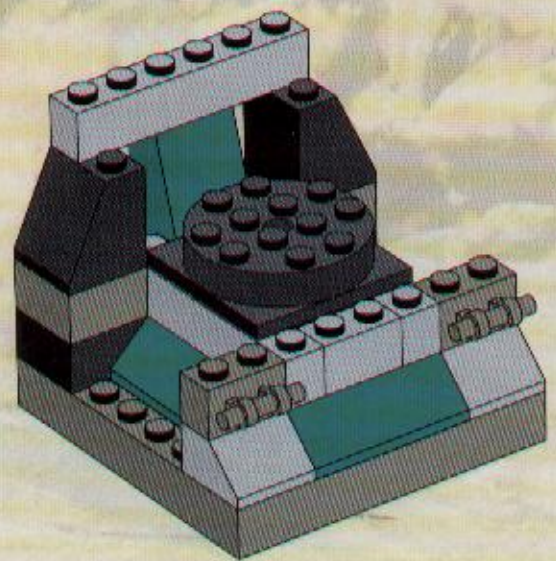

8

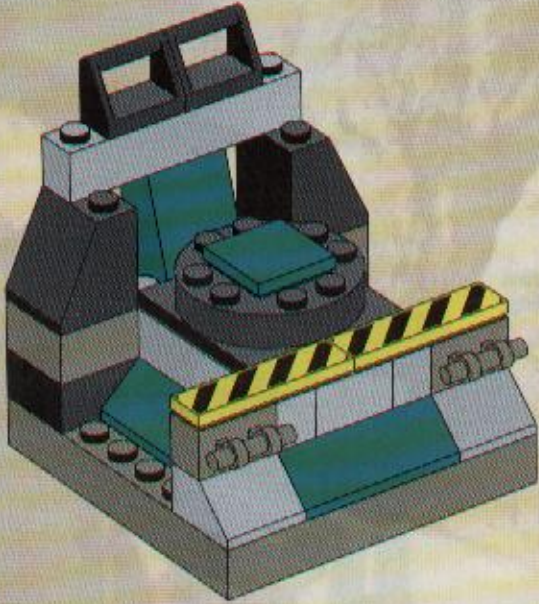

9

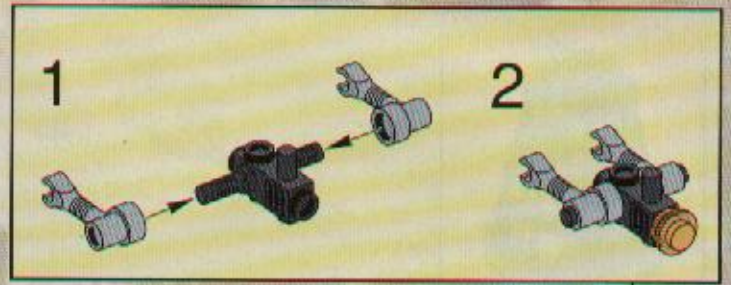
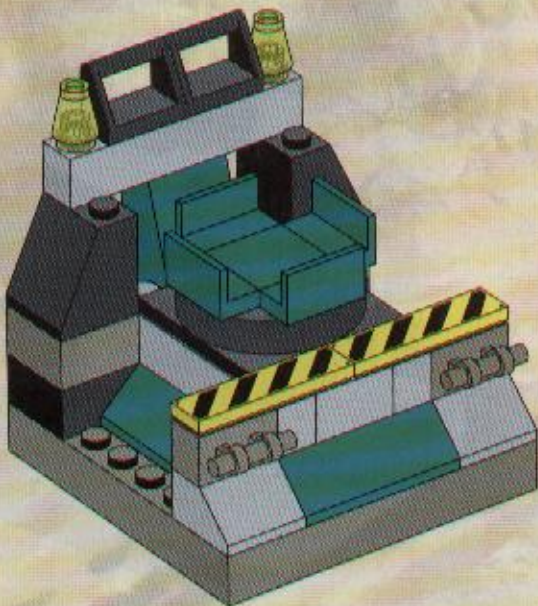

10

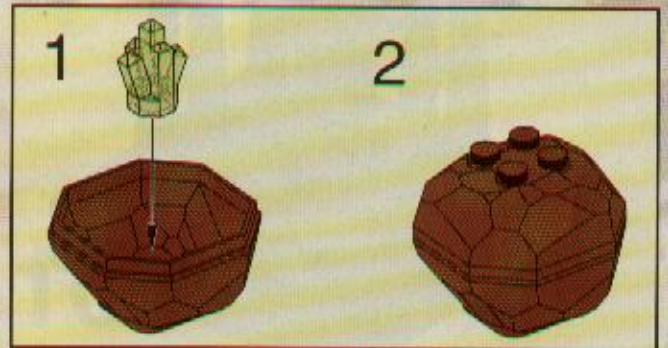
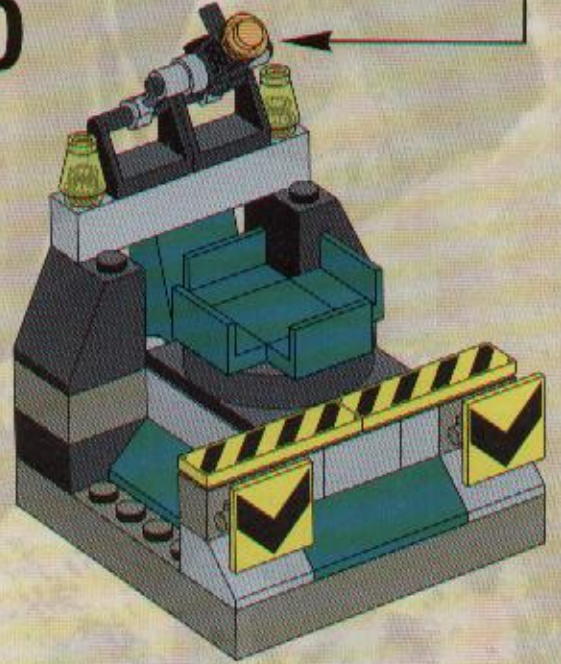

11

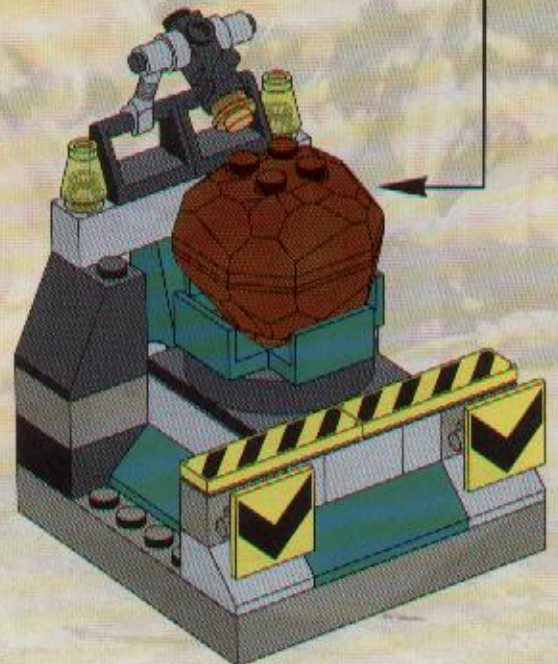

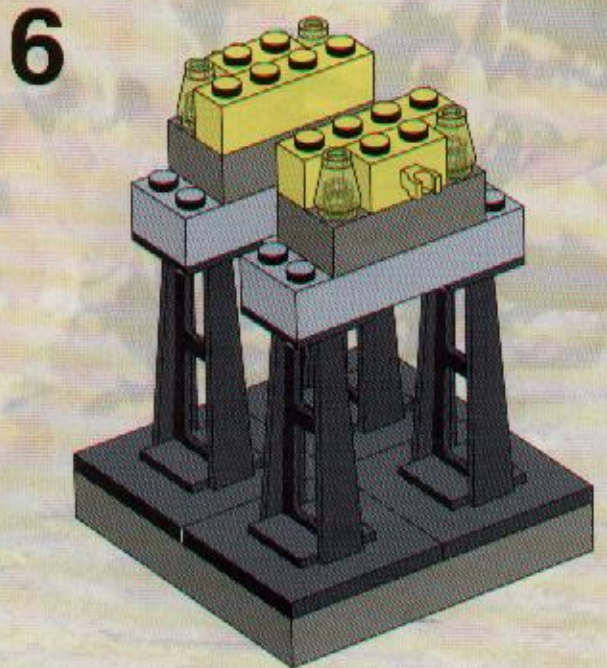
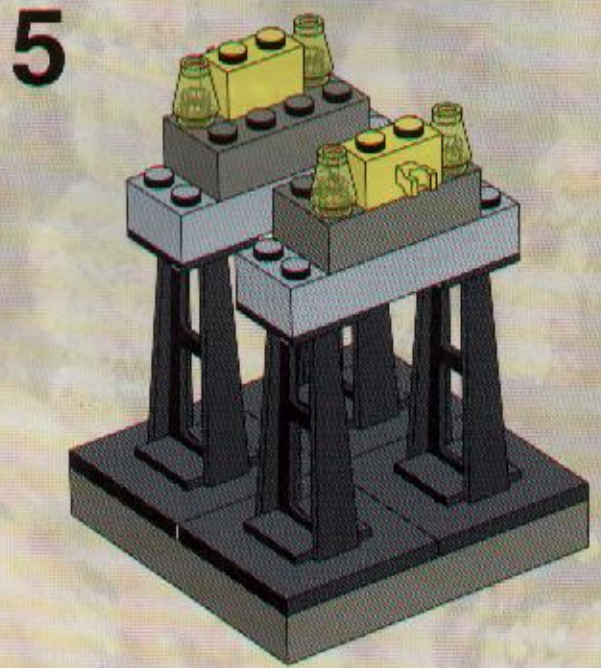
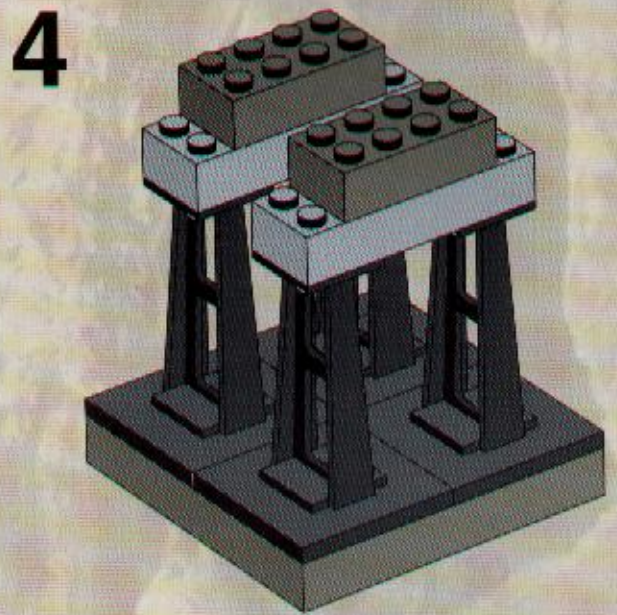
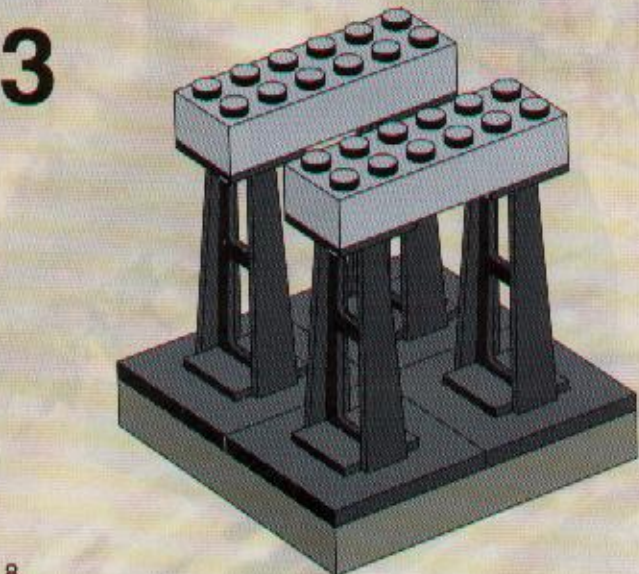
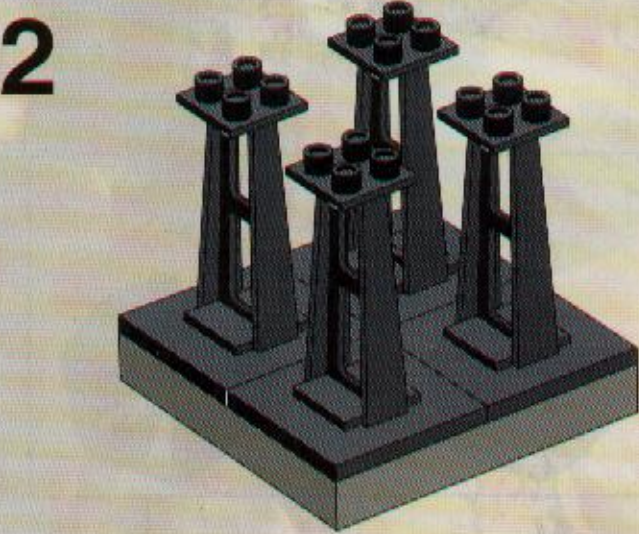
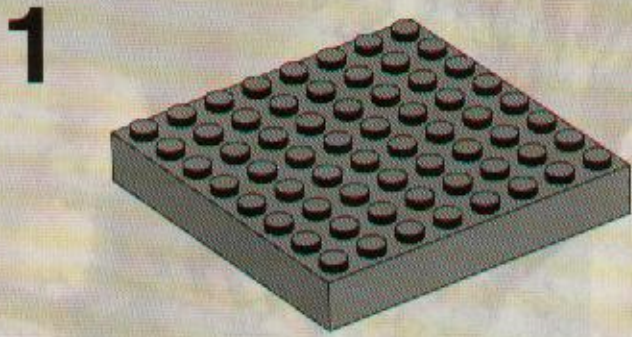

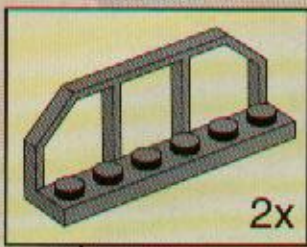

7

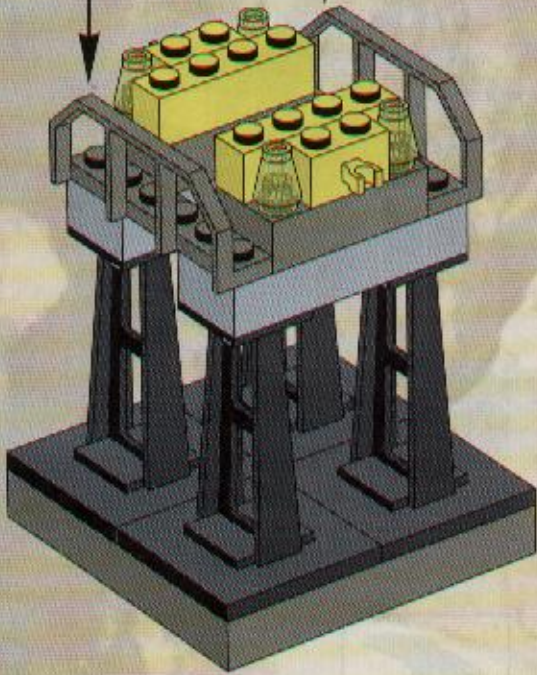

8

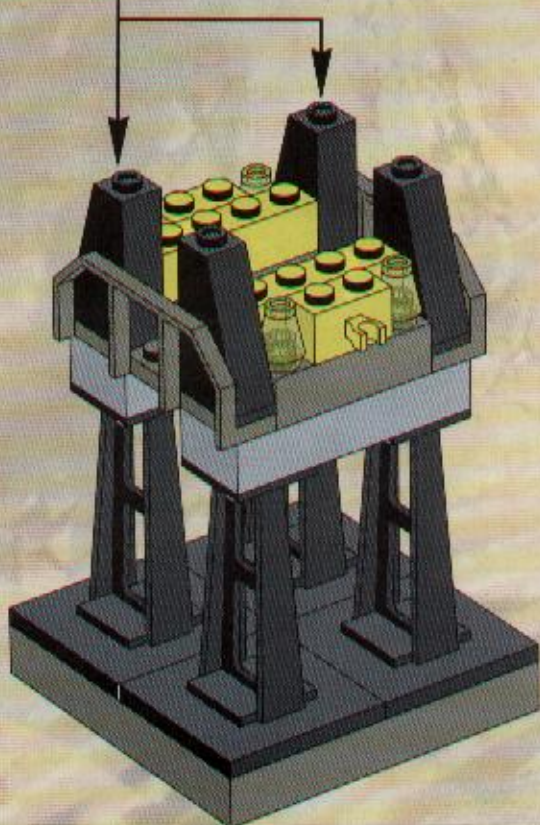

9

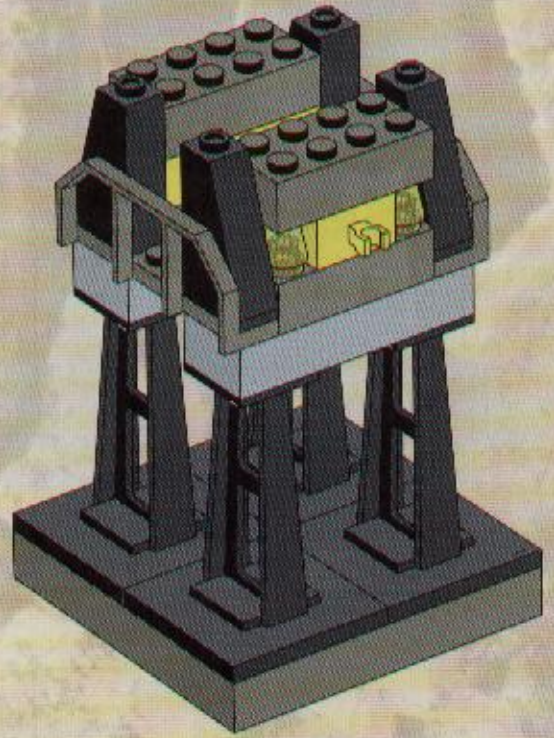

10

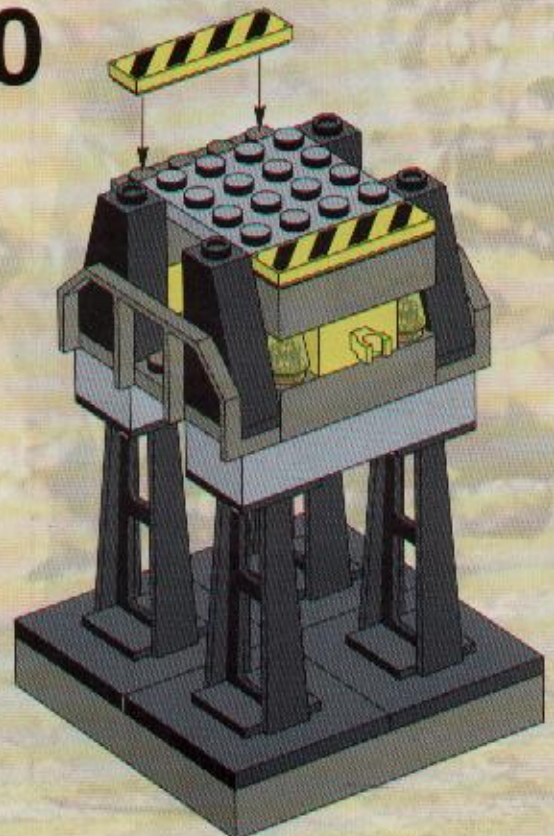

11

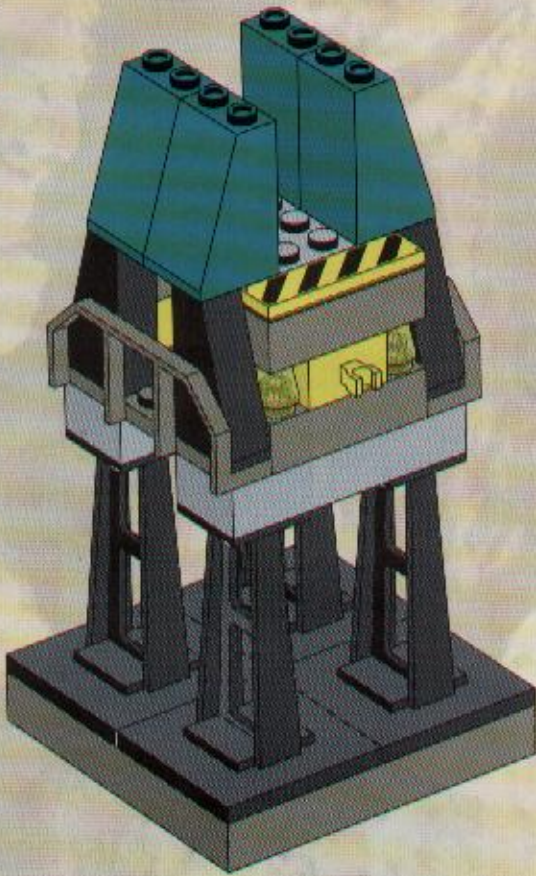

13

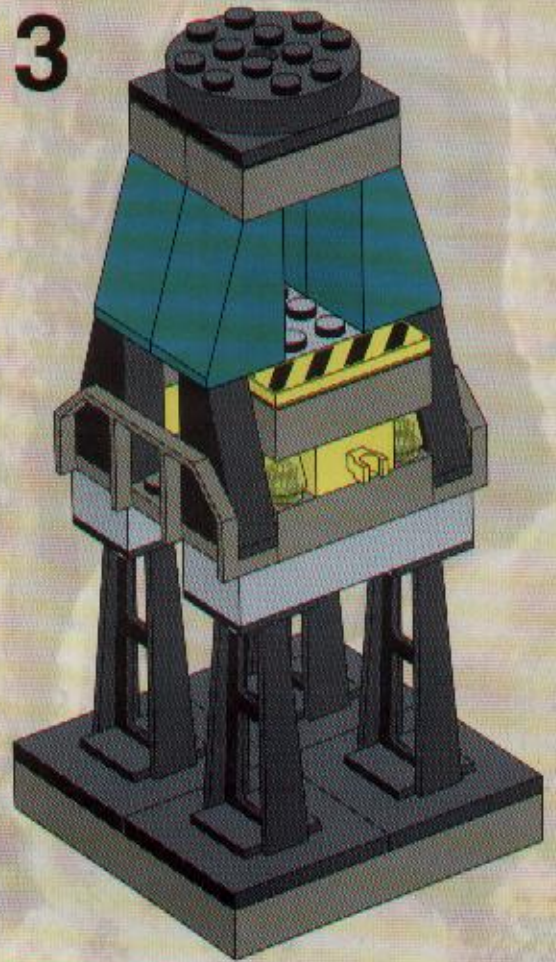

12

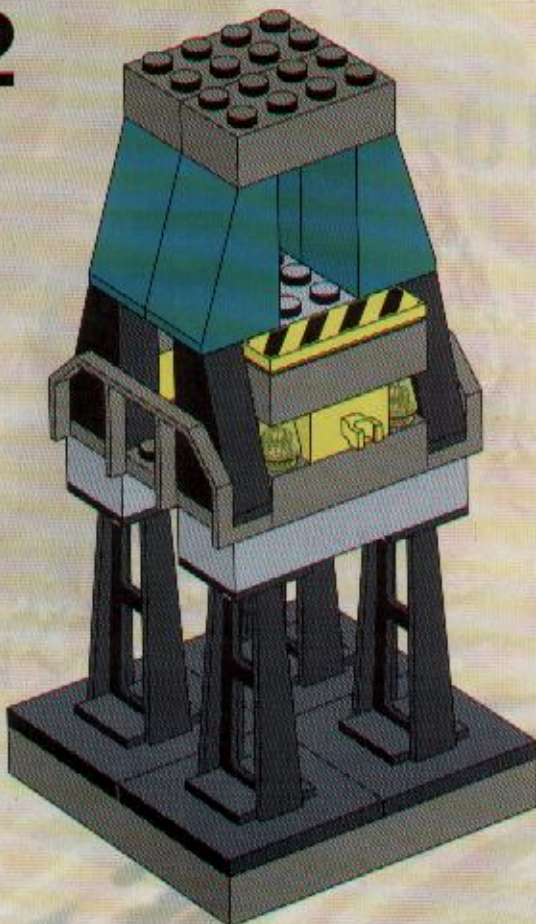

14

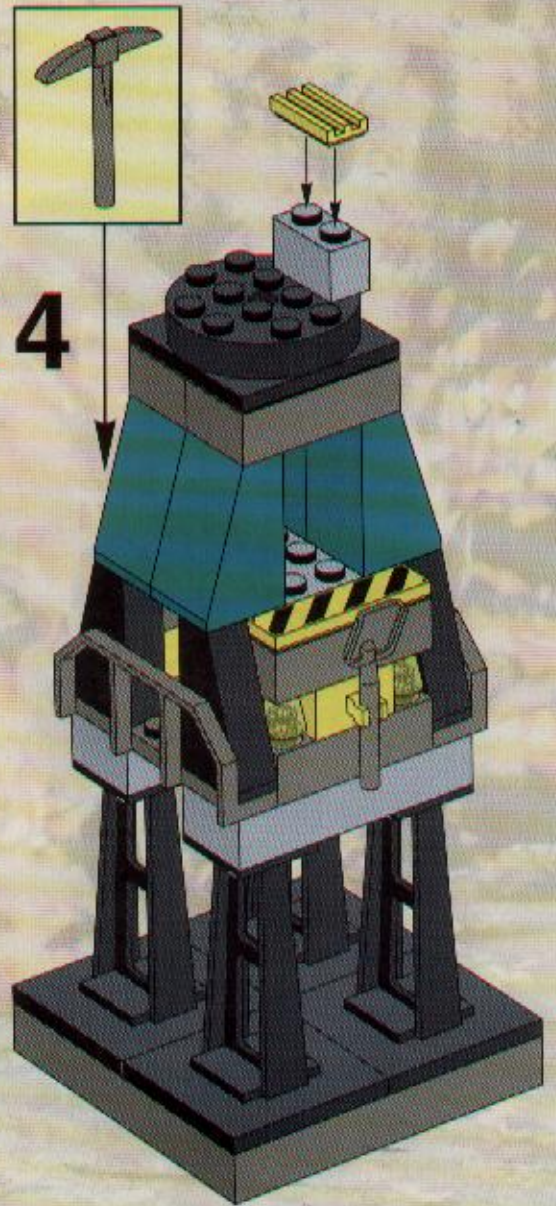



1

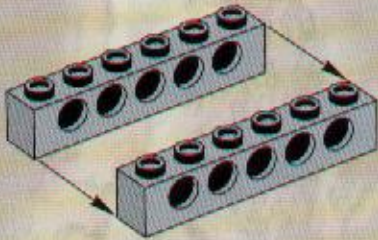

2

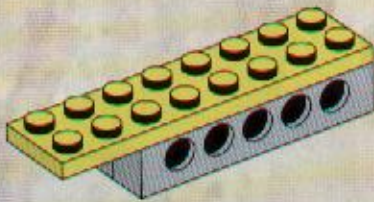

3

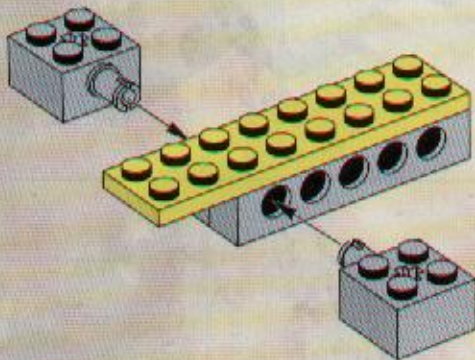

4

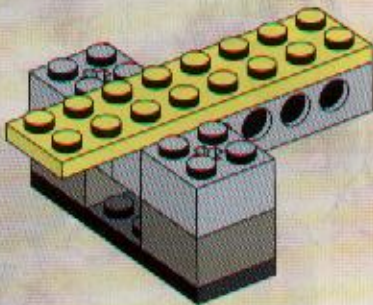

1



2

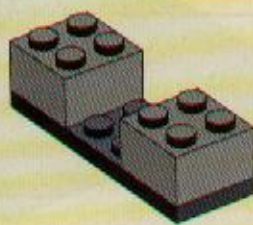

5

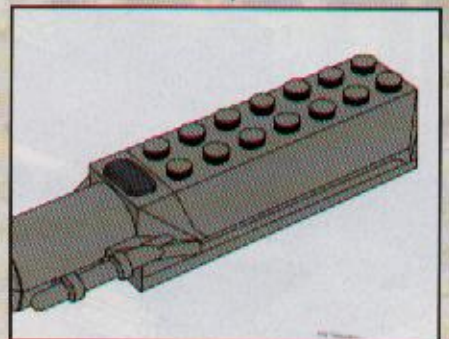
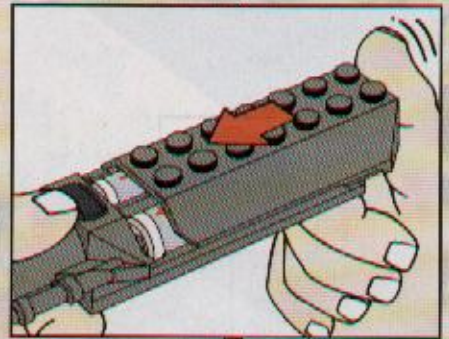
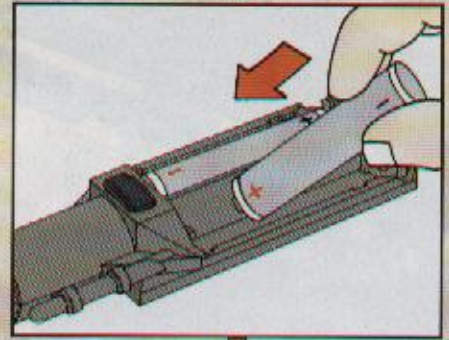
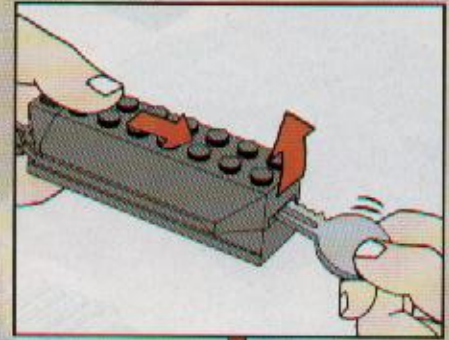
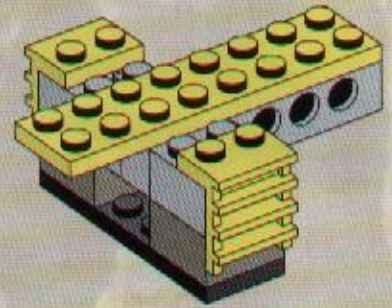

6

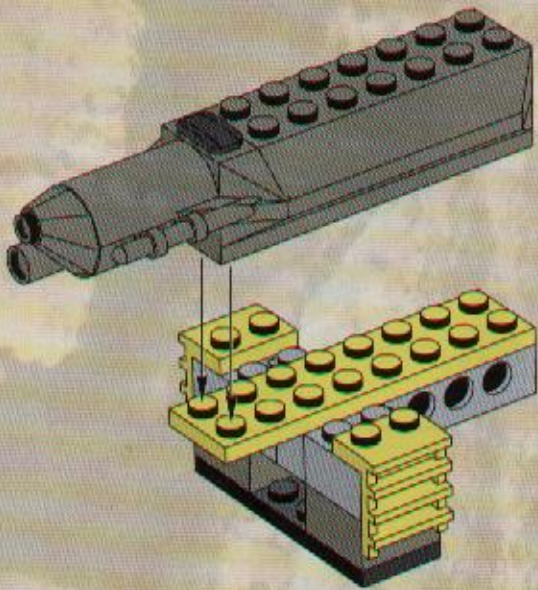

7

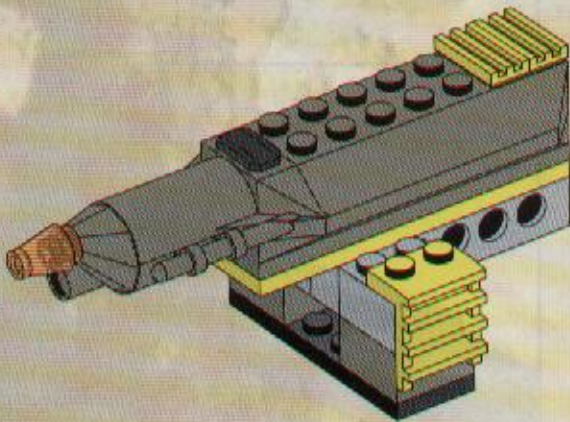

8

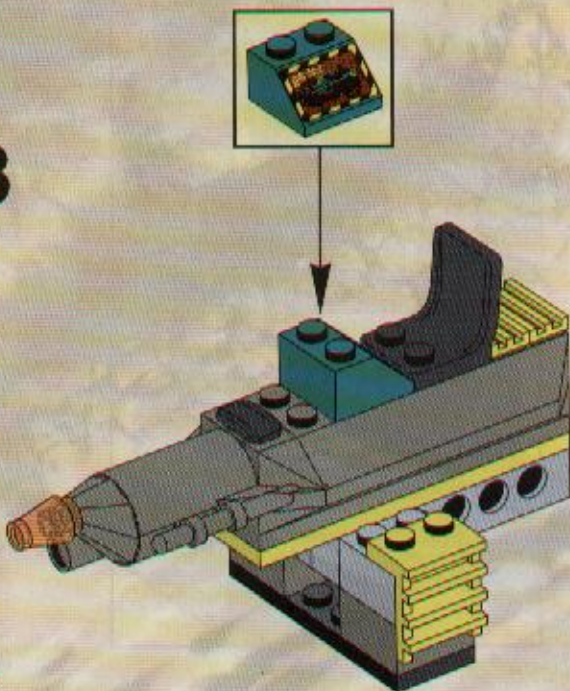

9

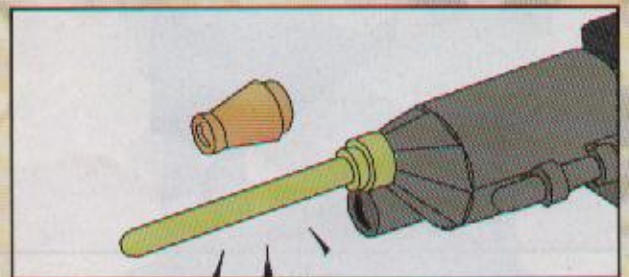
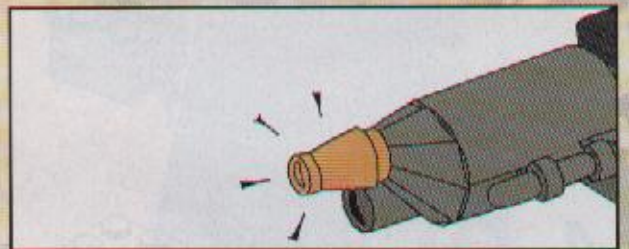
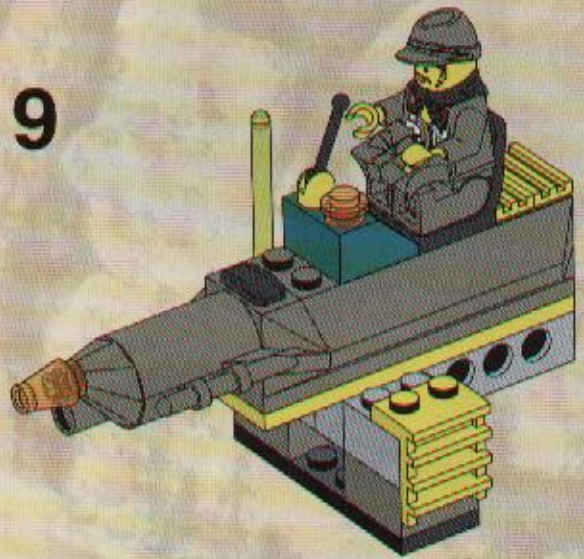

4

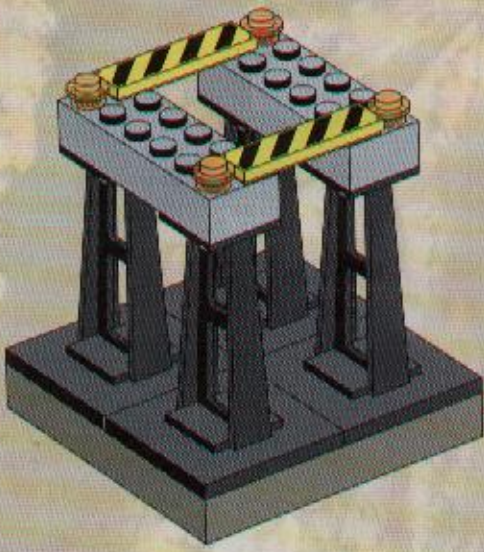

5

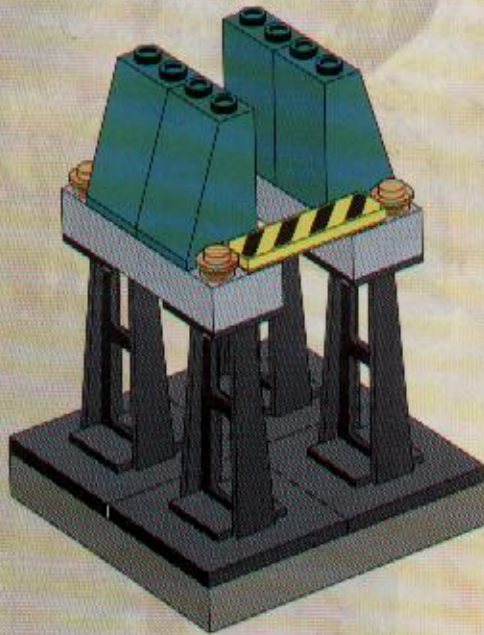

6

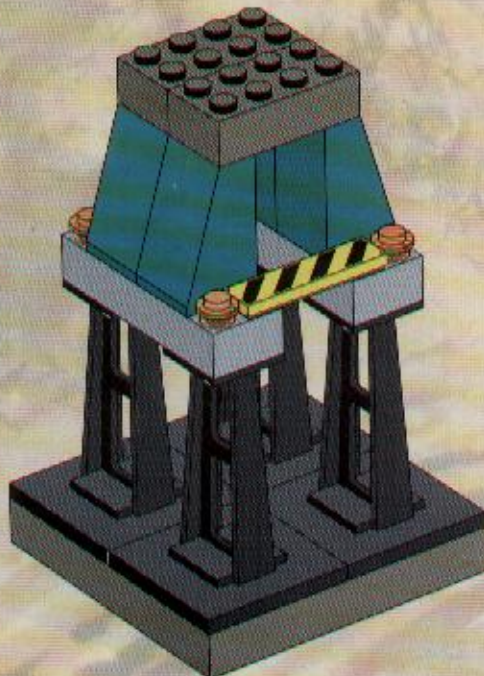

7

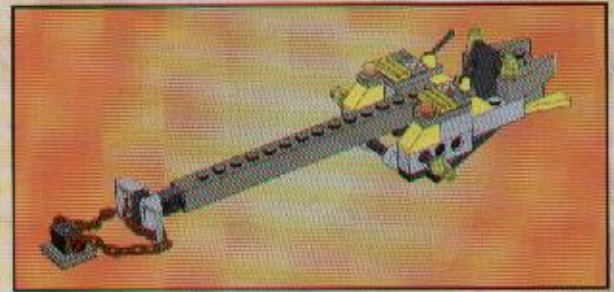

1

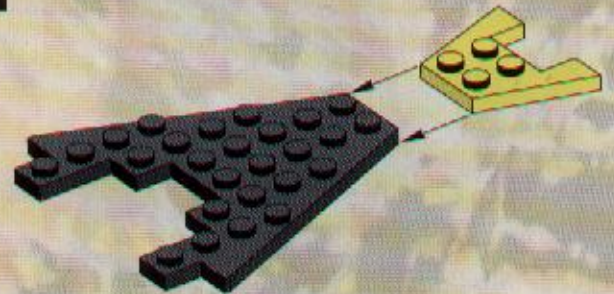

2

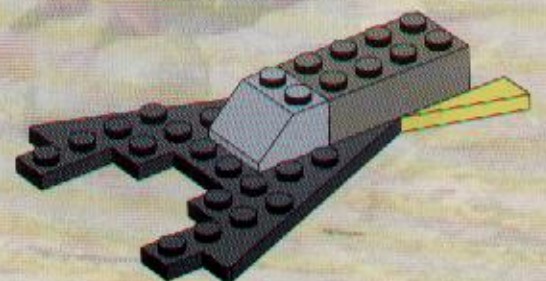

3

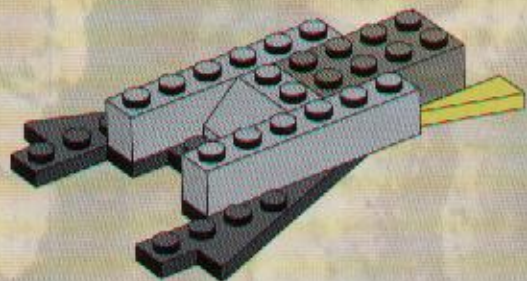

6

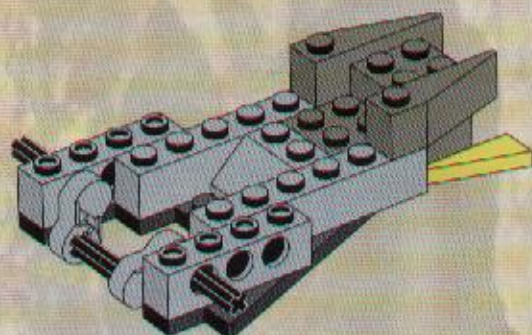

4



7

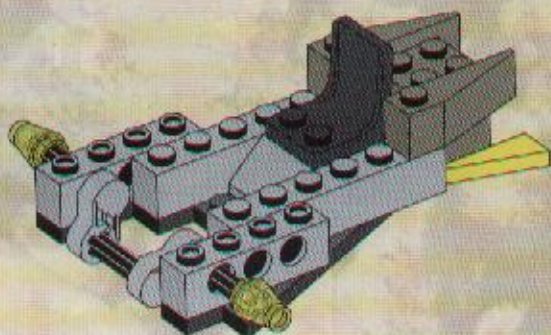

5



8

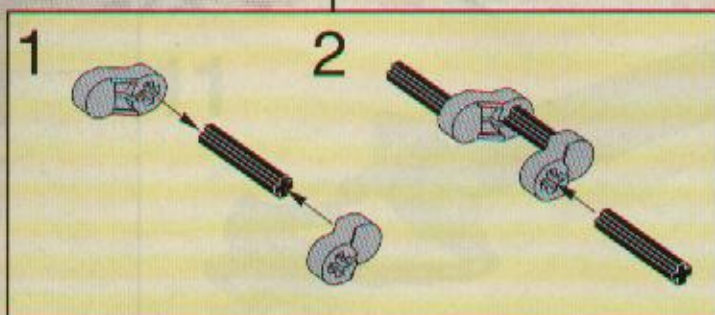
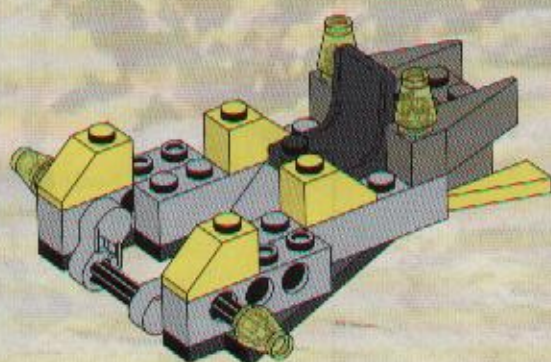

1

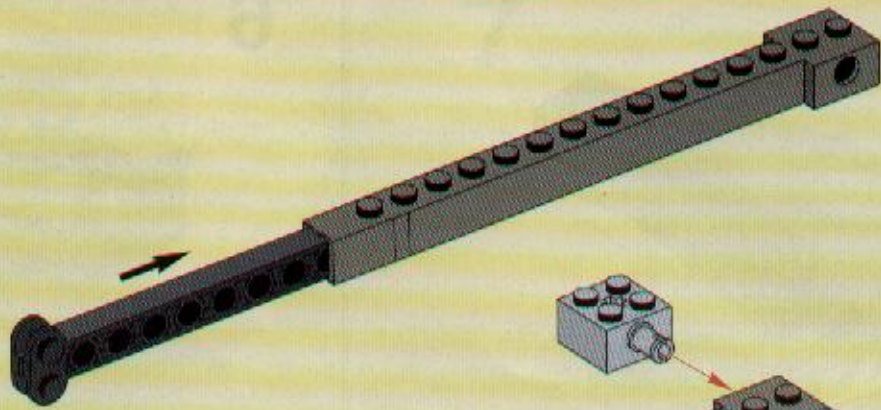

2

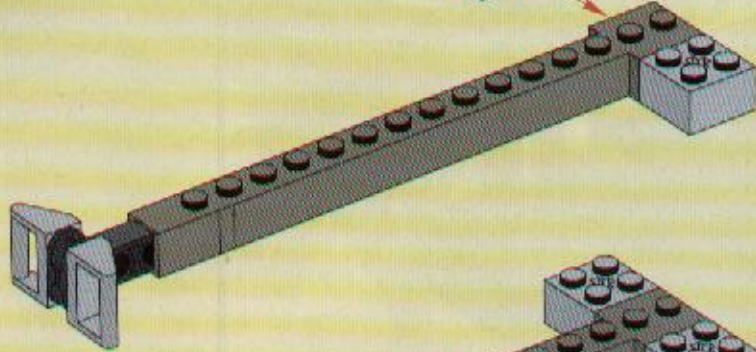

3

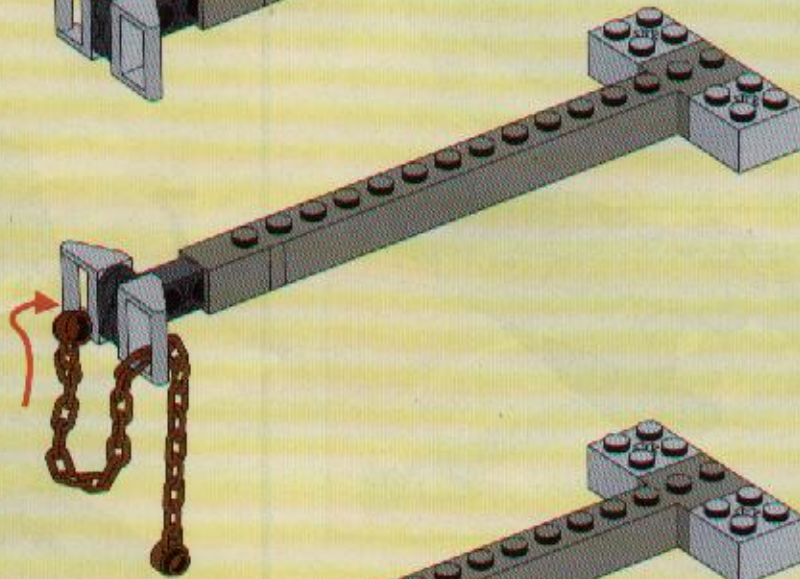

4

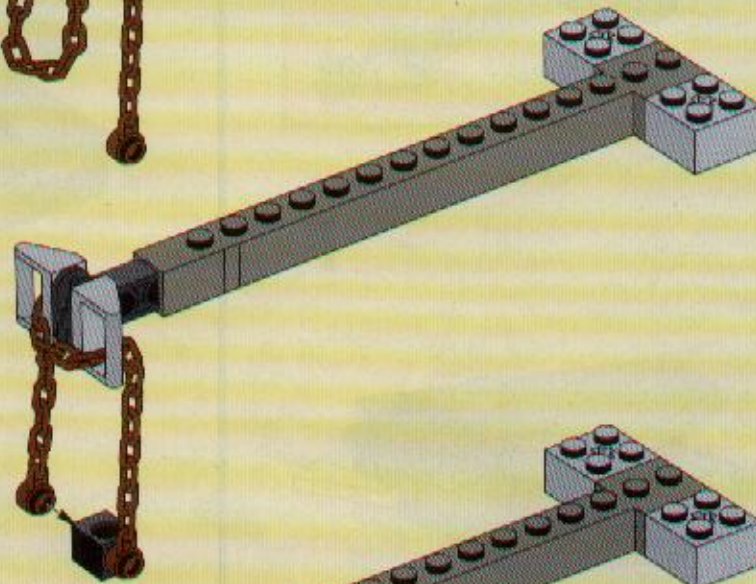

5

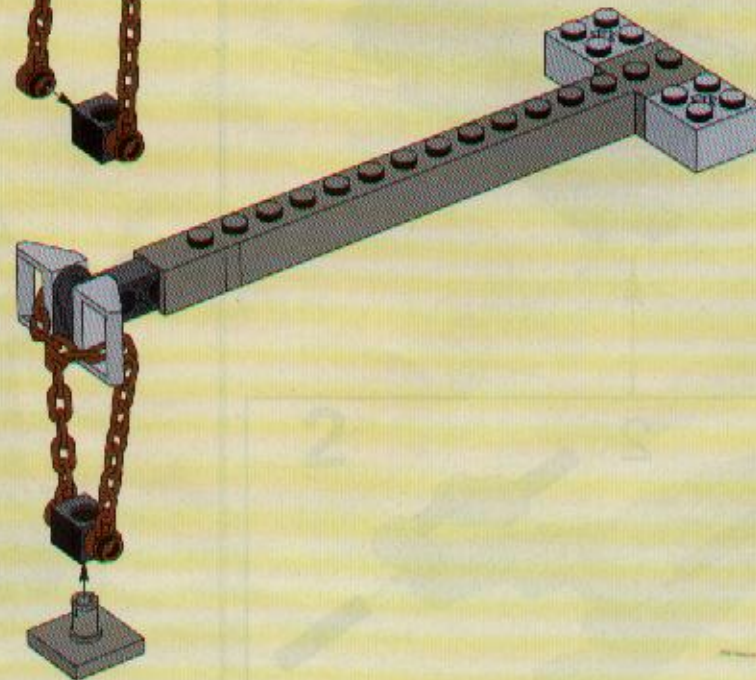

9

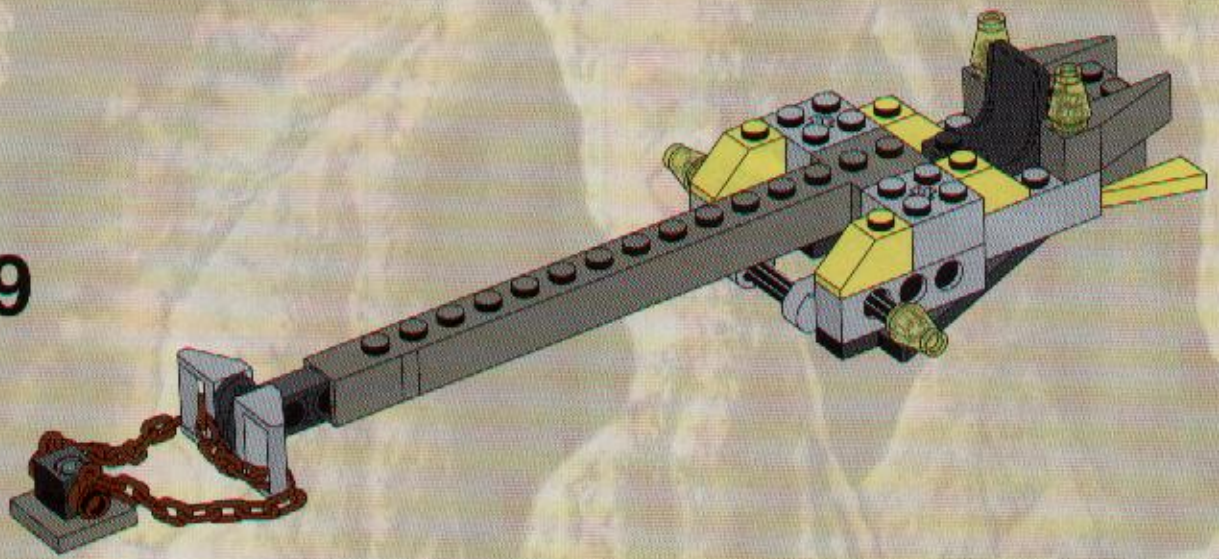

10

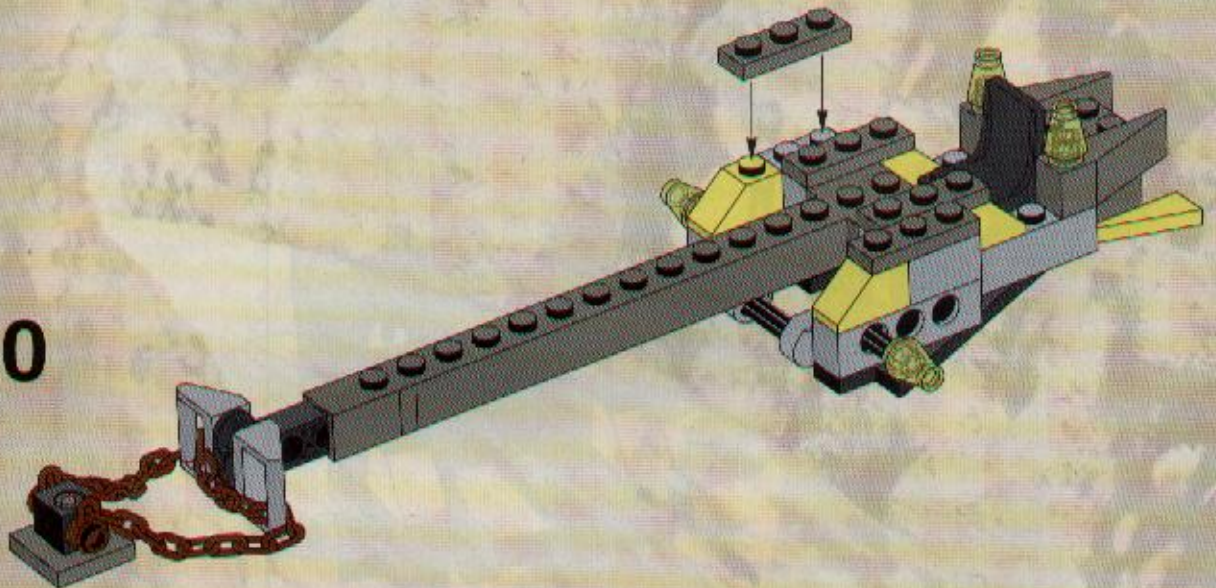

11

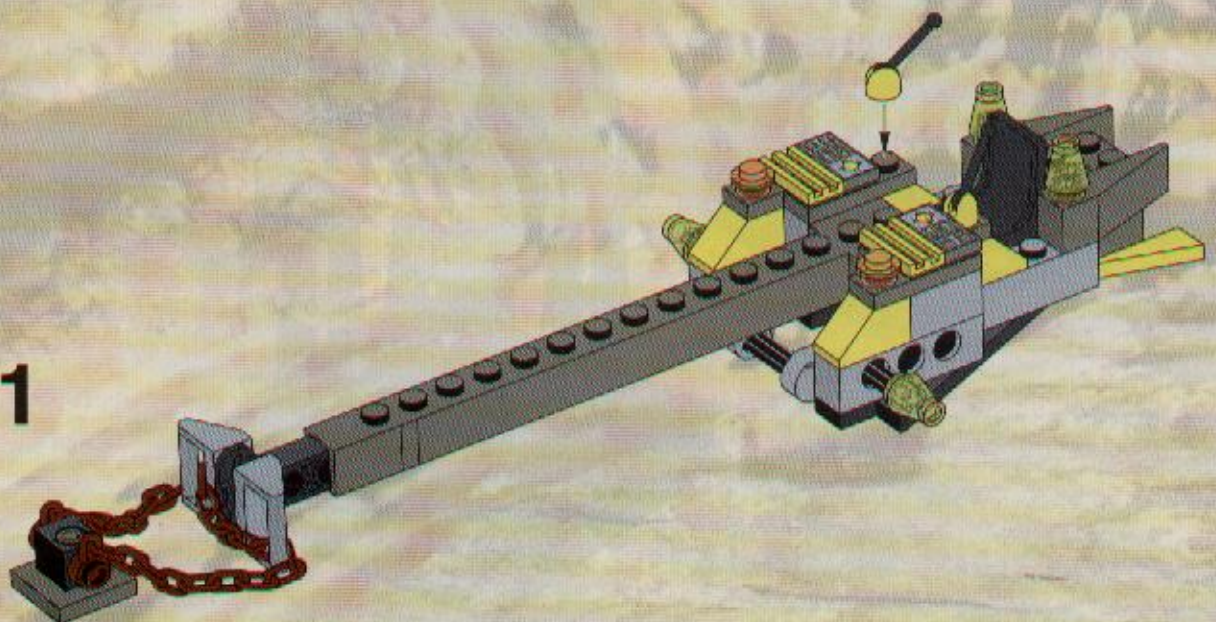

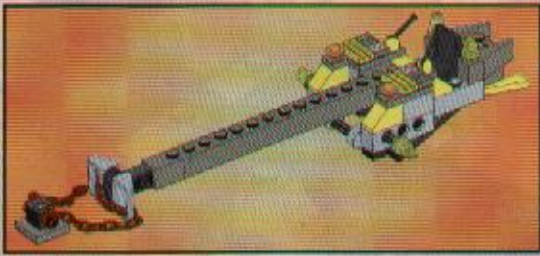

+



8

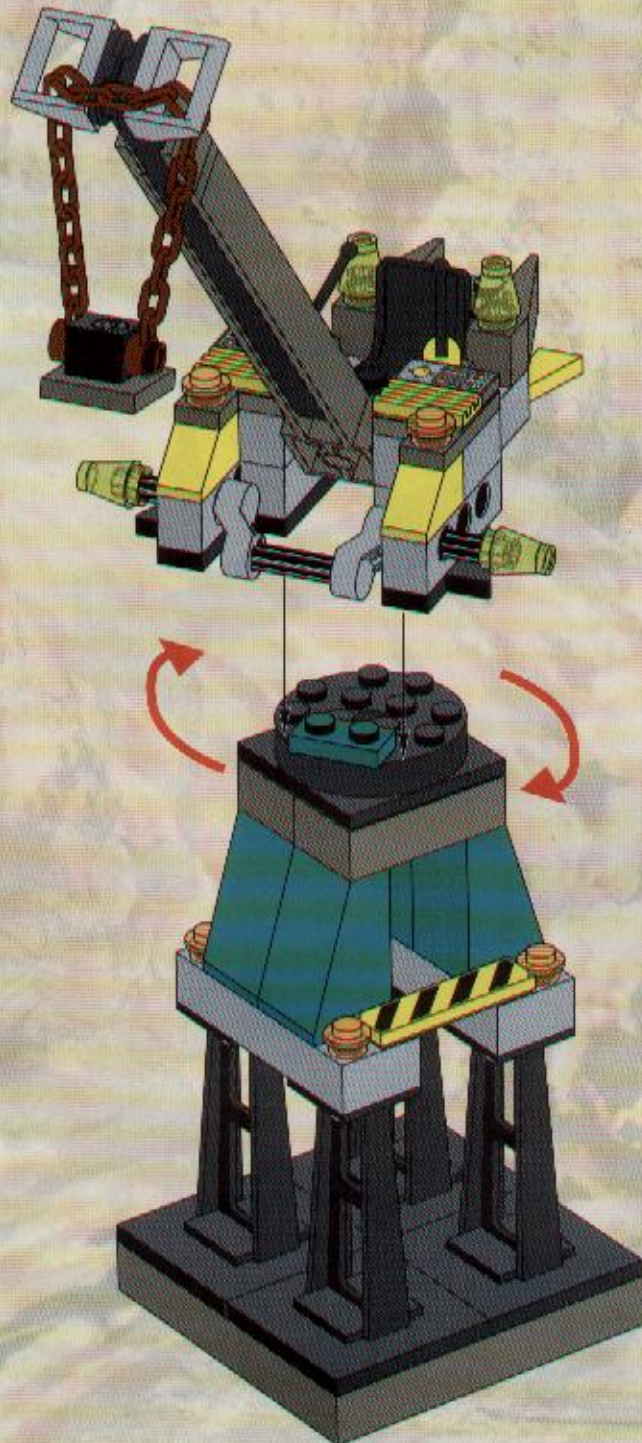

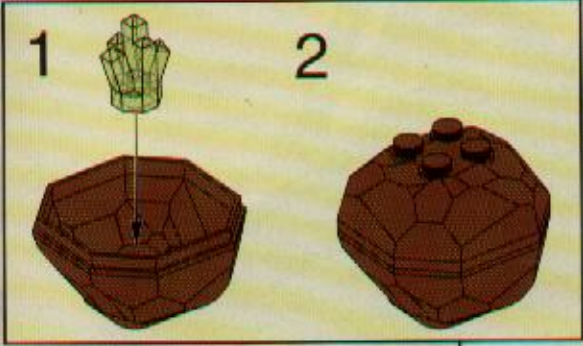

9

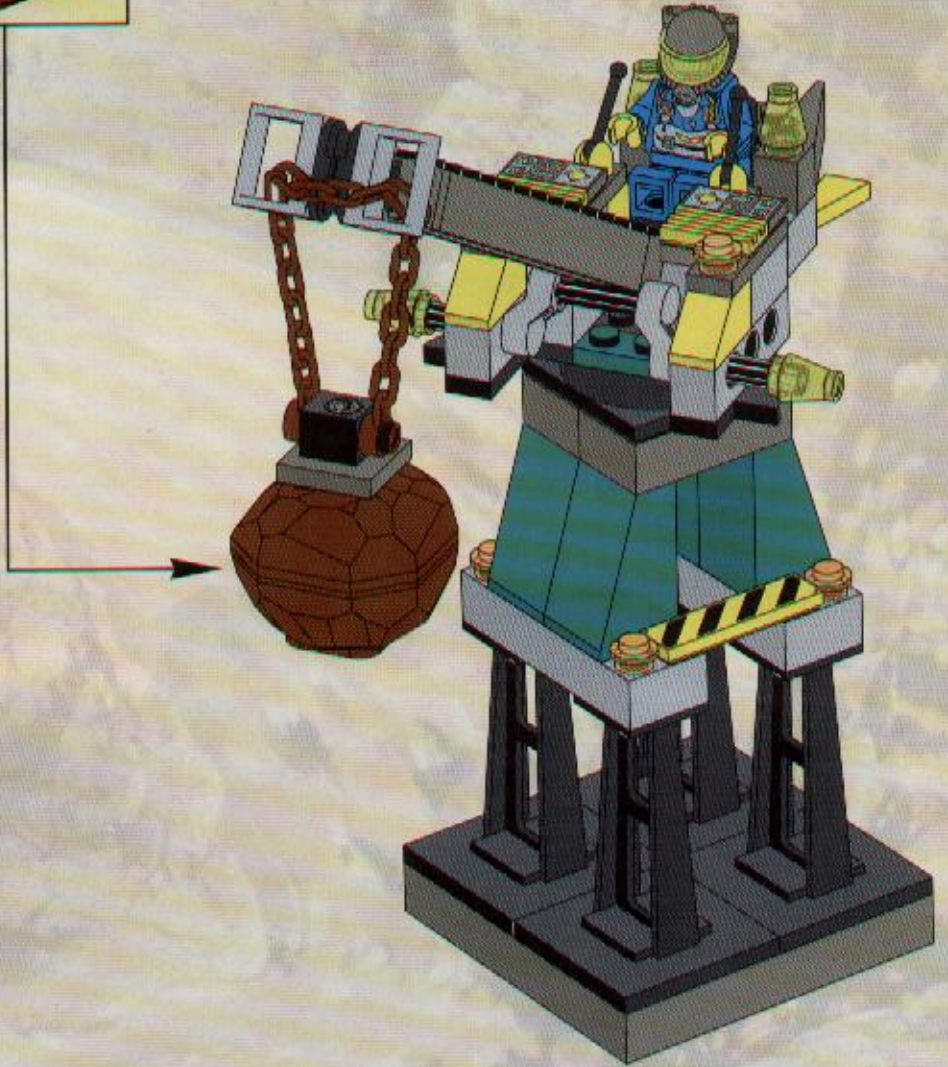

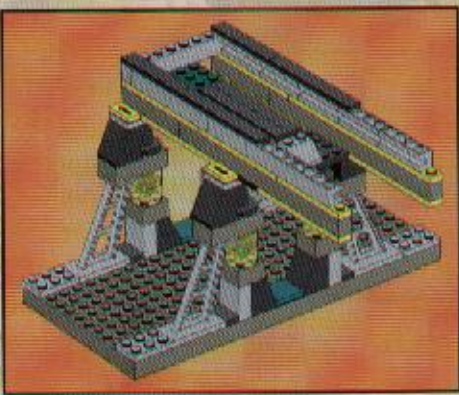

1

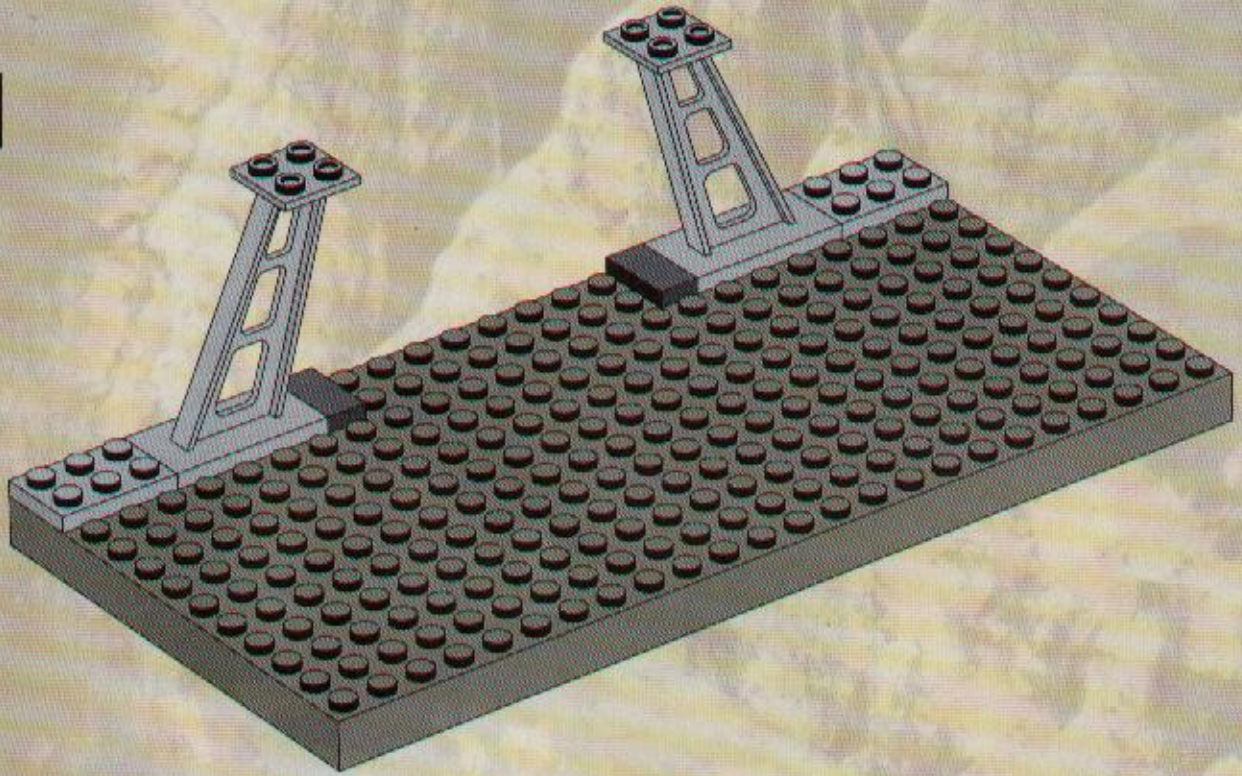

2

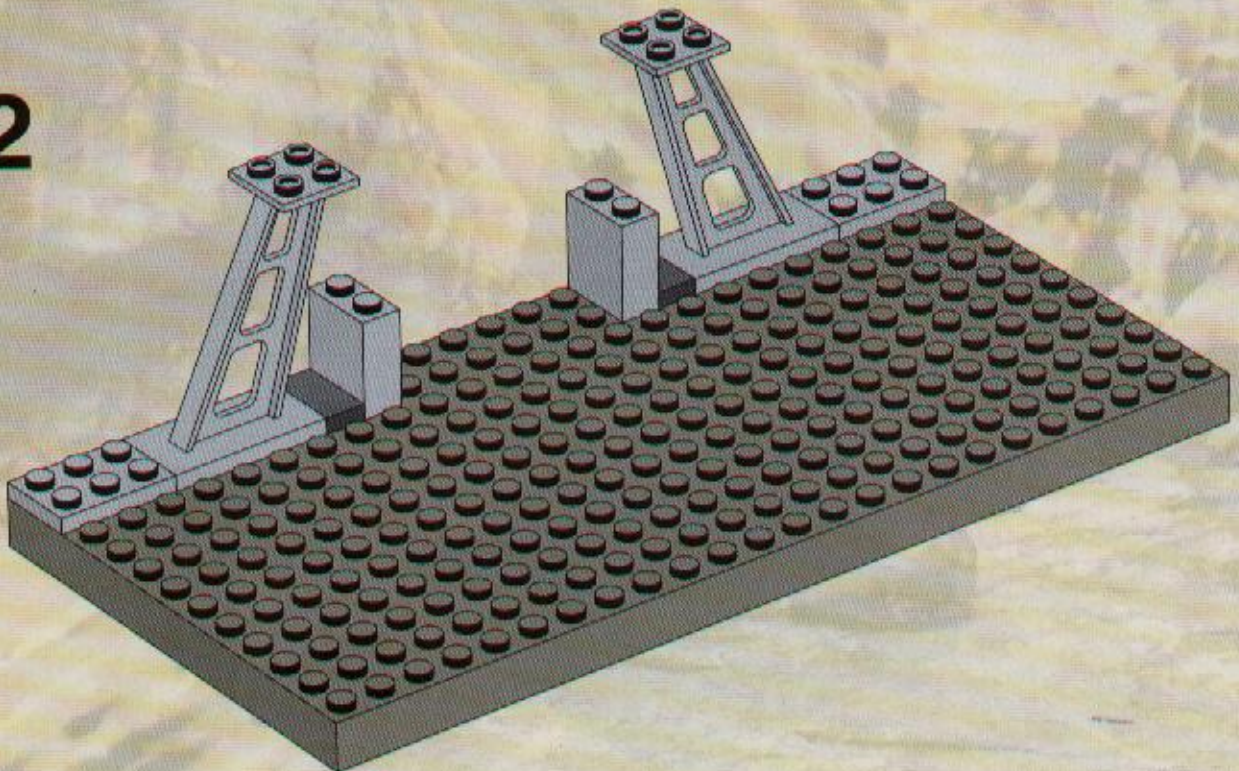

3

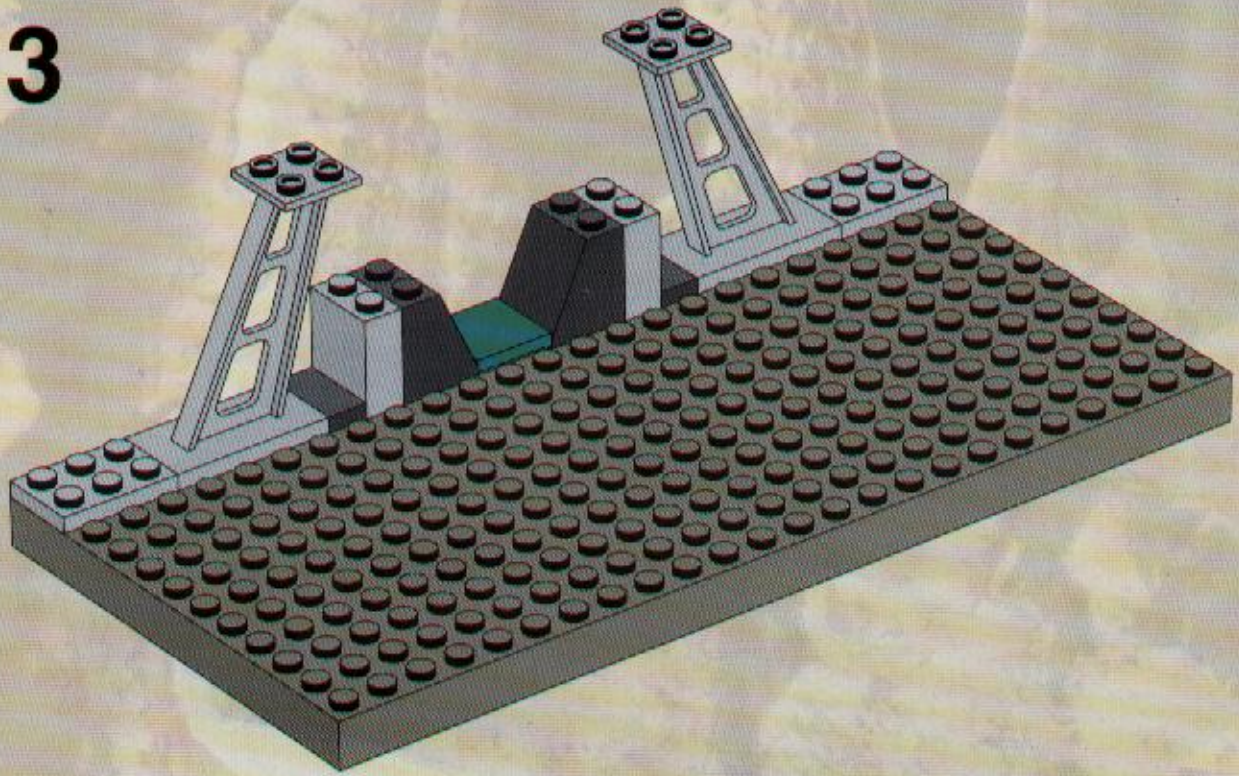

4

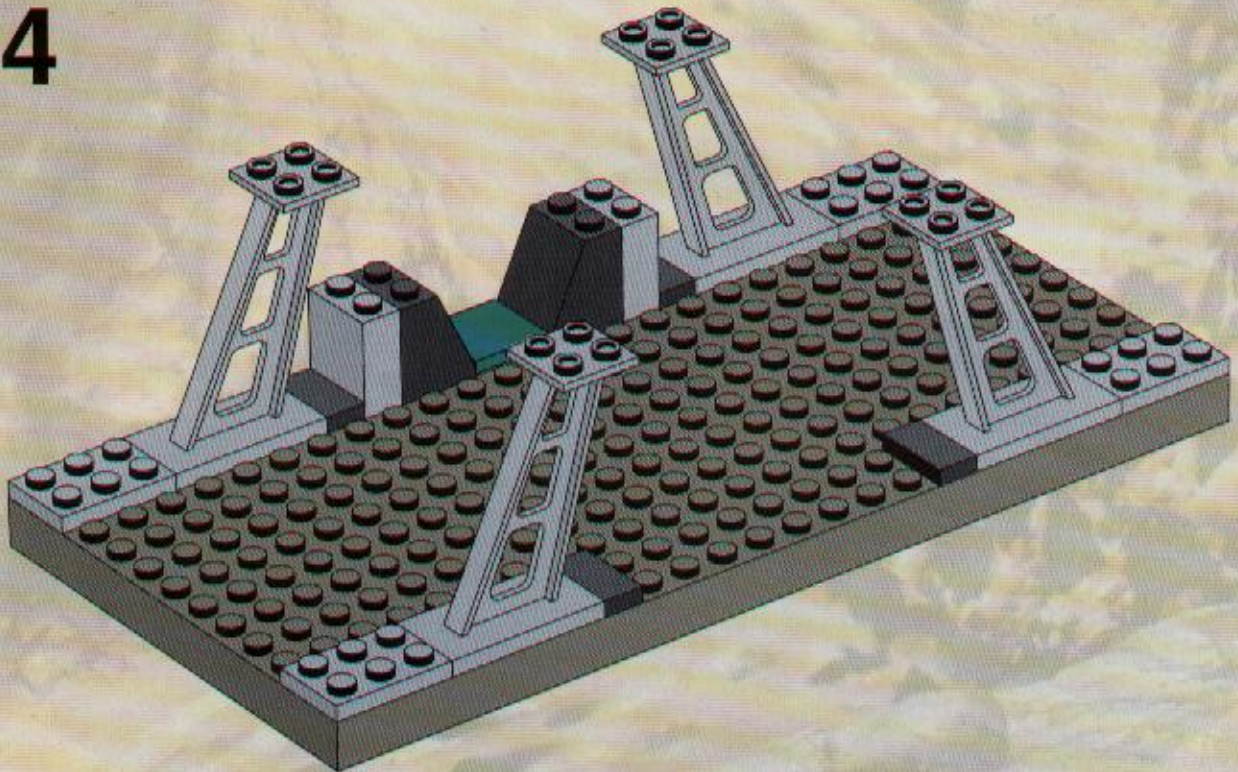

5

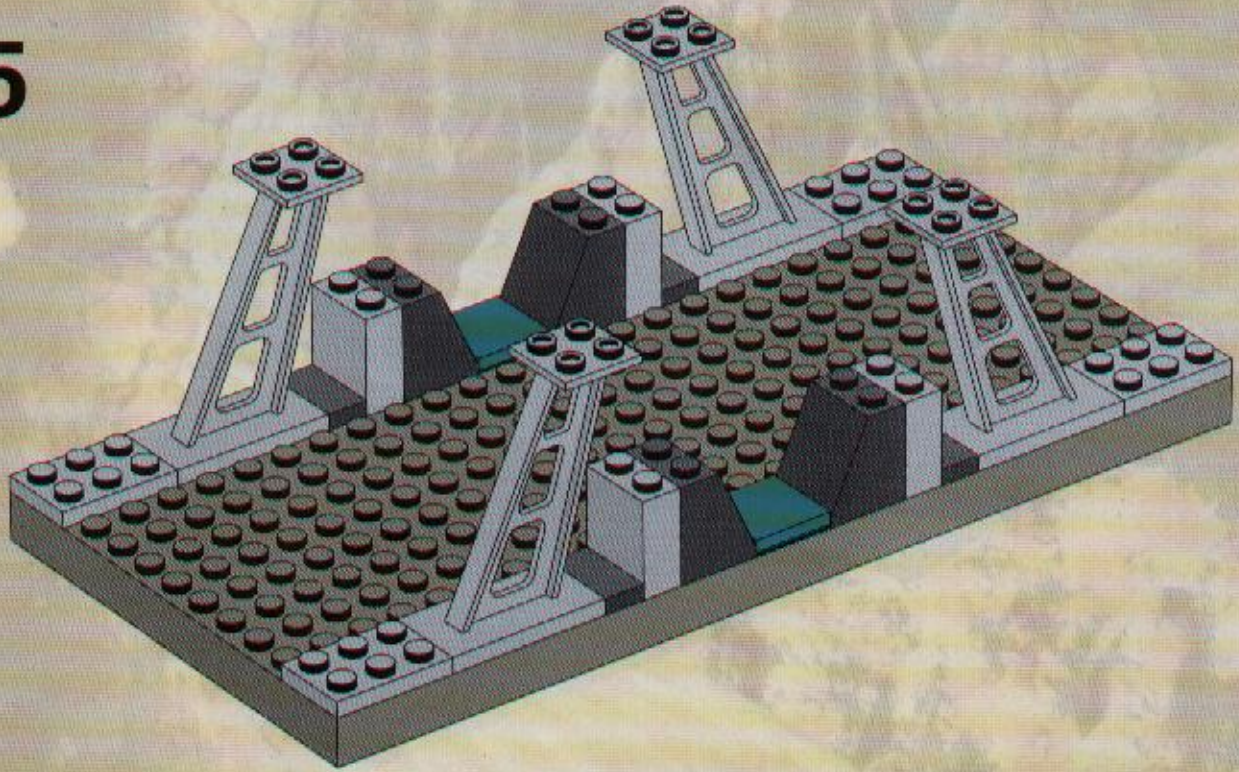

6

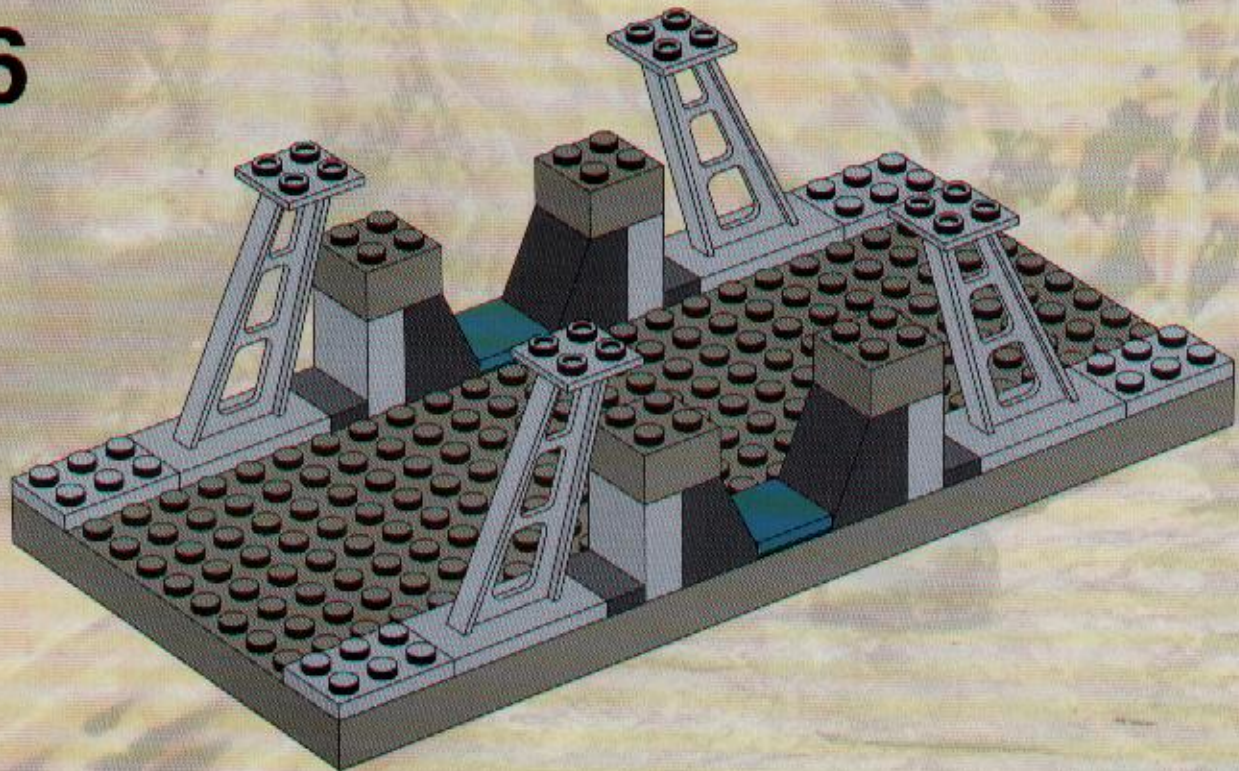

9

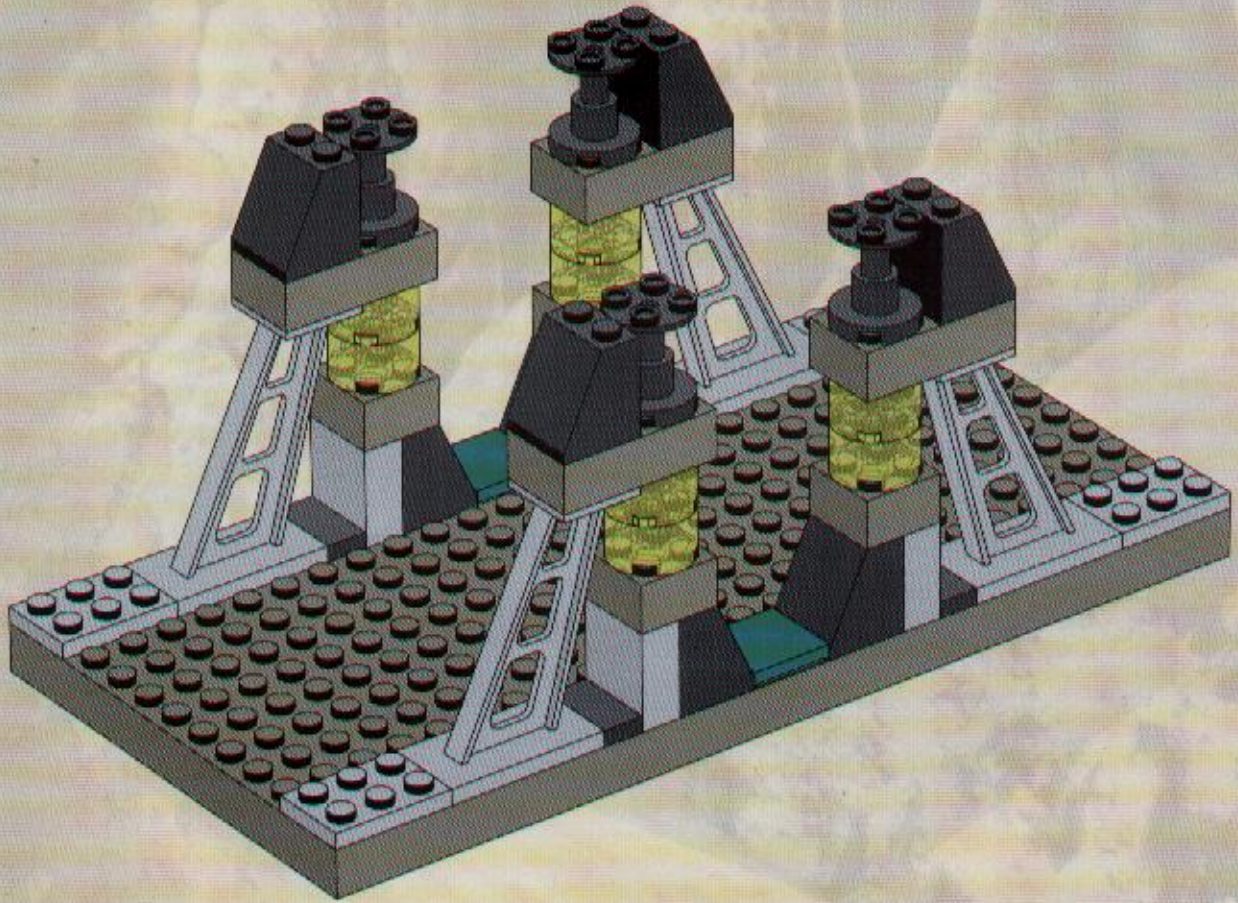

10

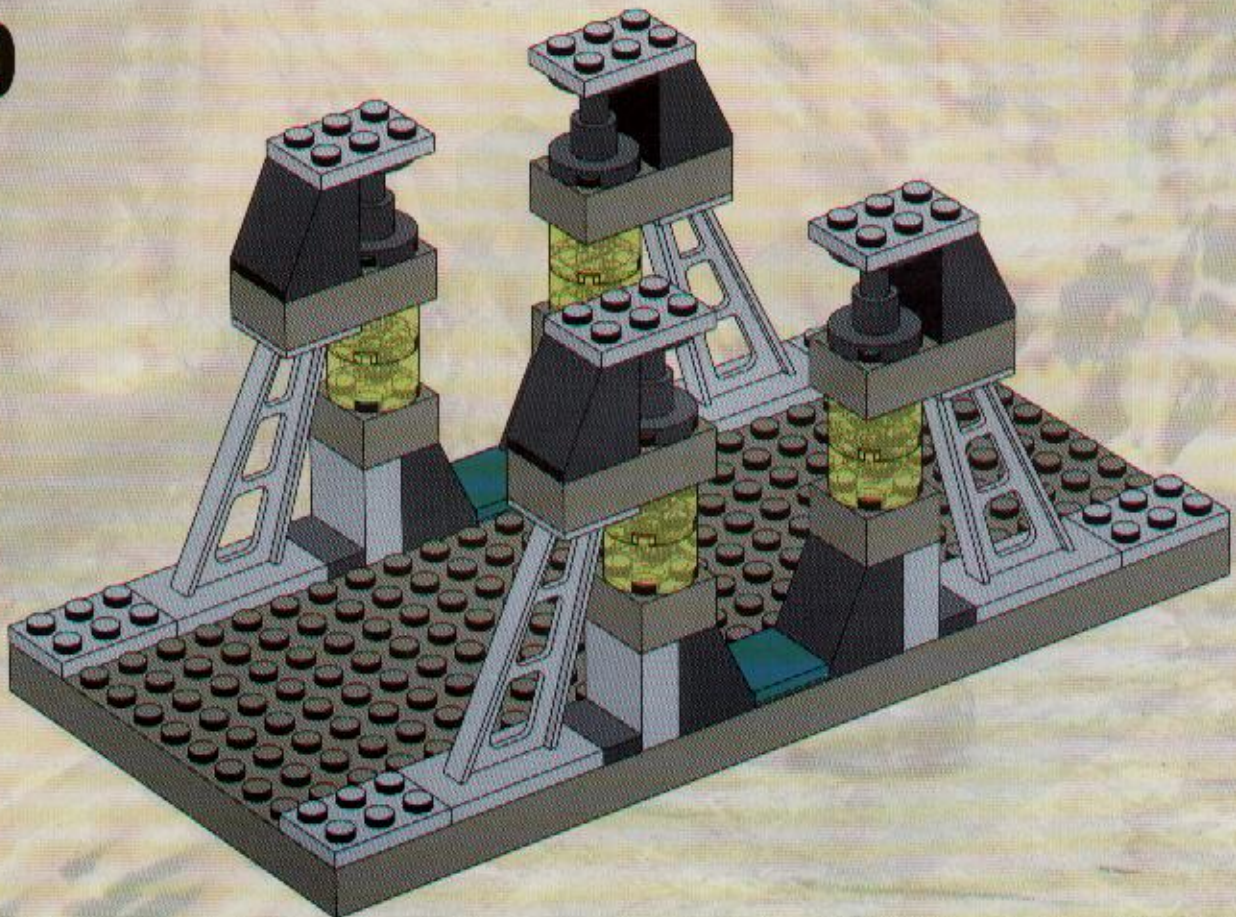

11

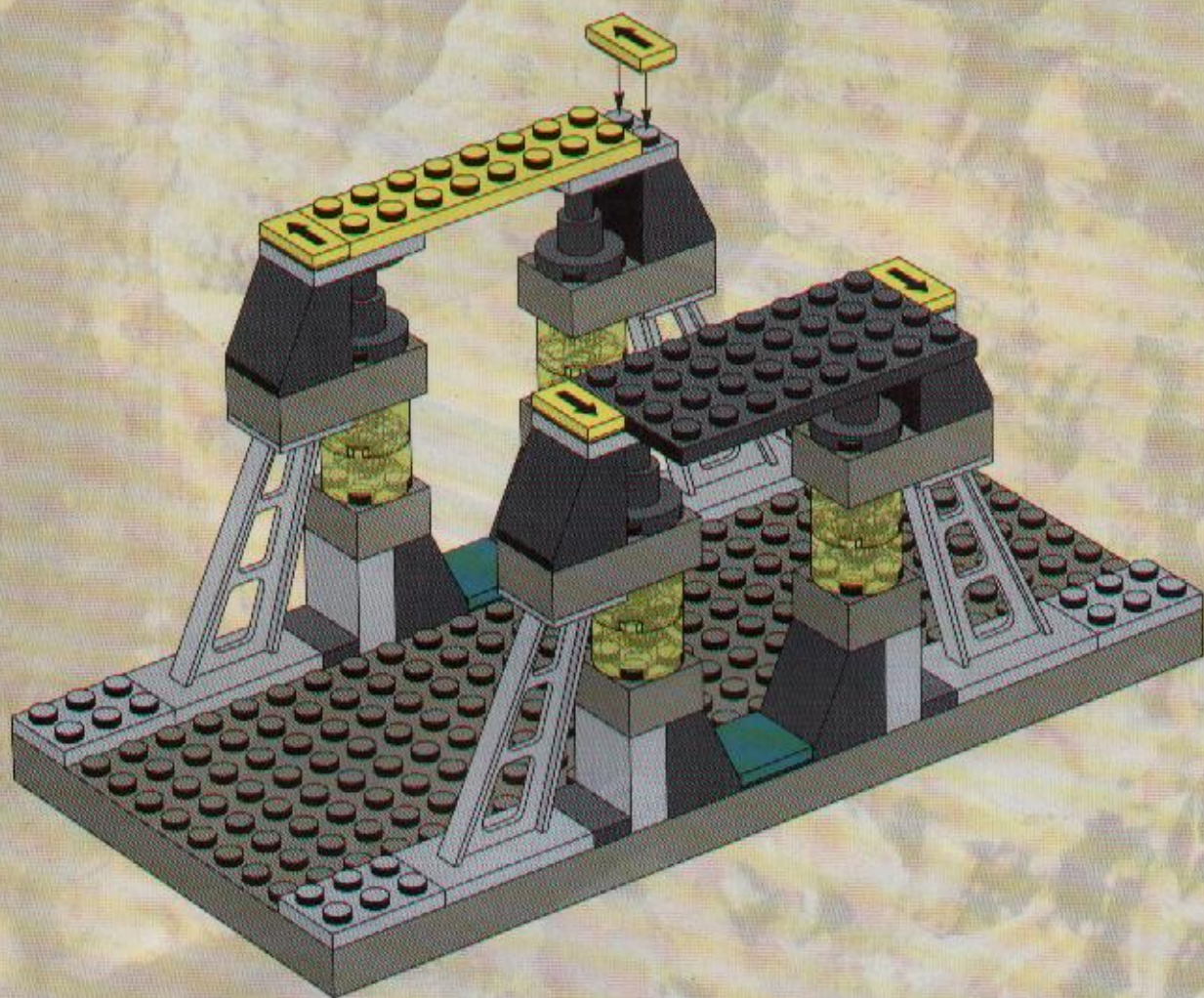

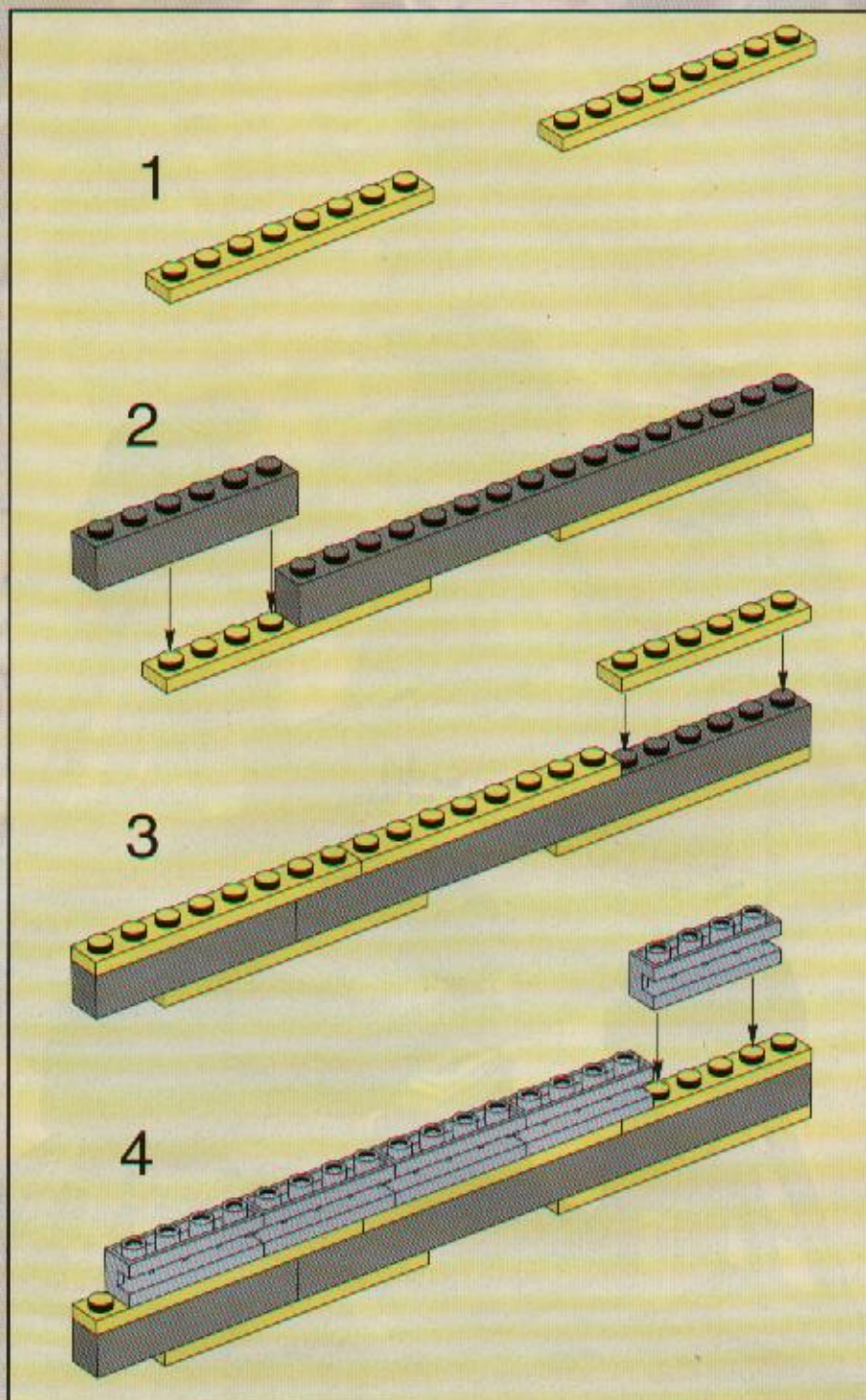

12

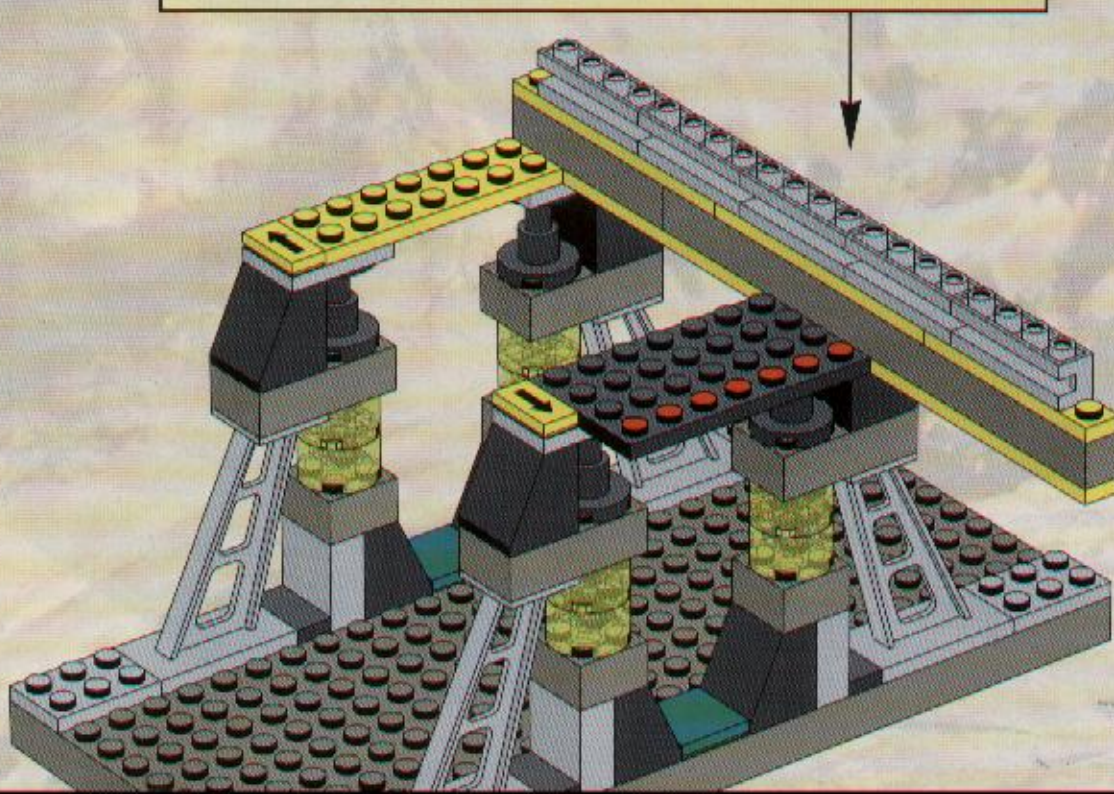

13

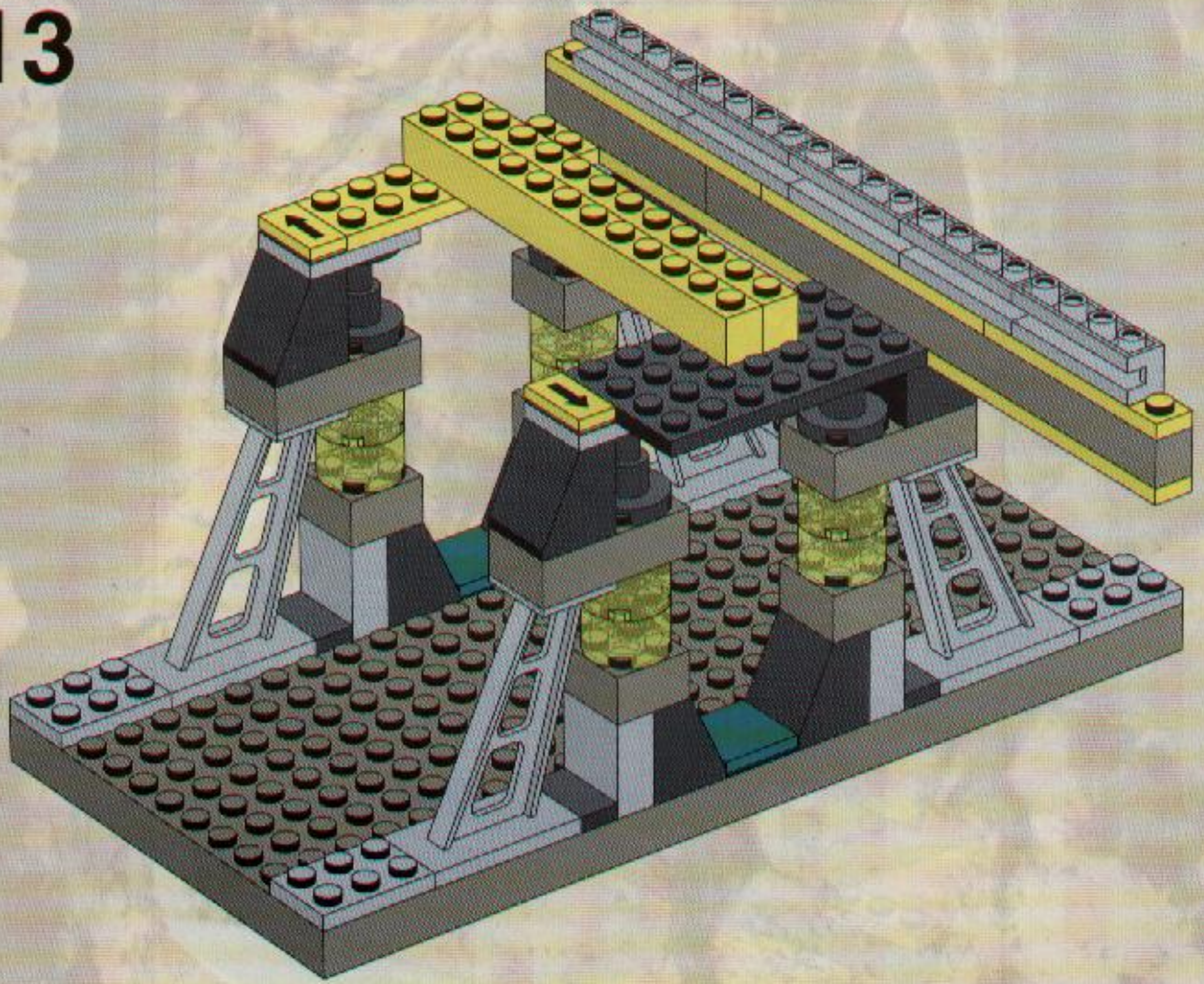

14

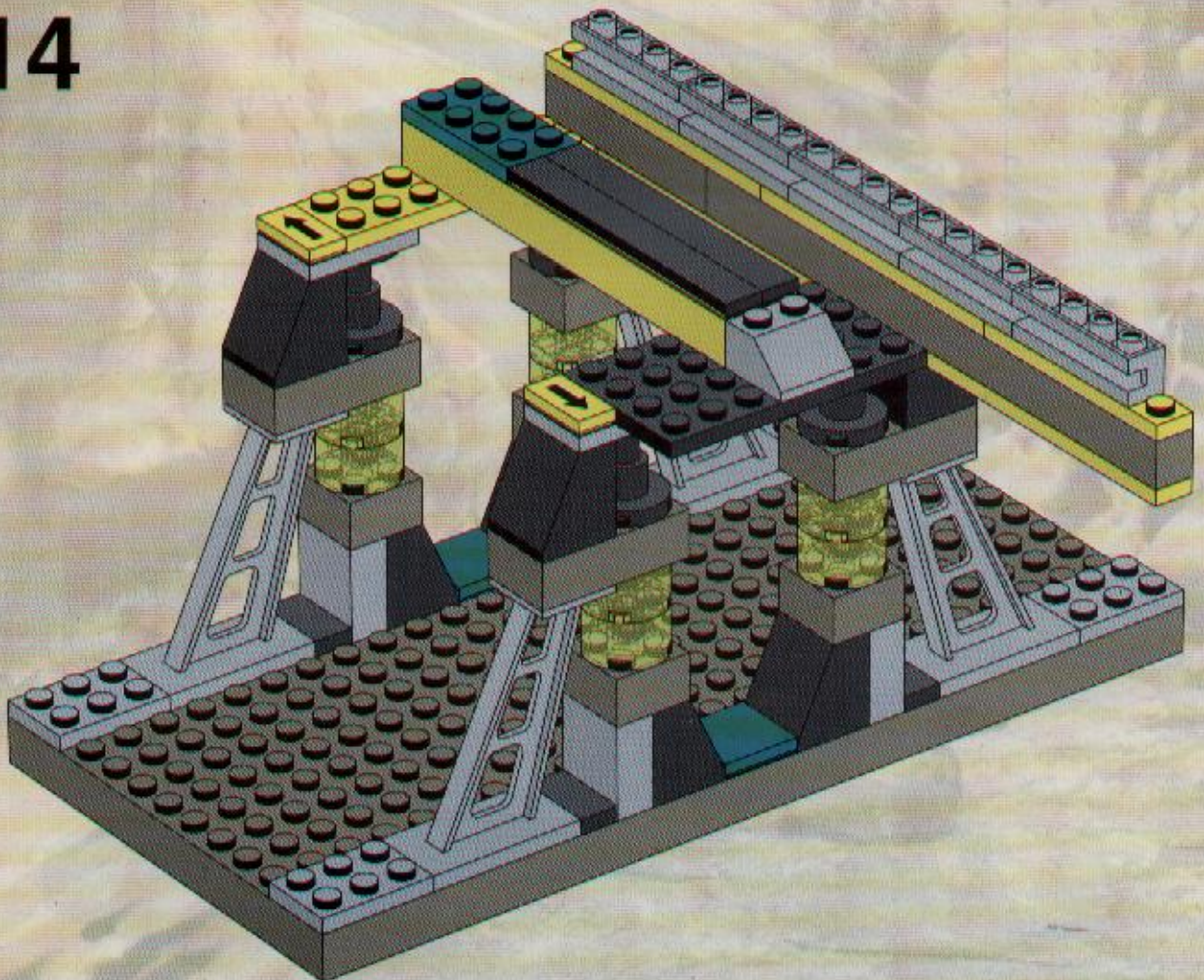

16

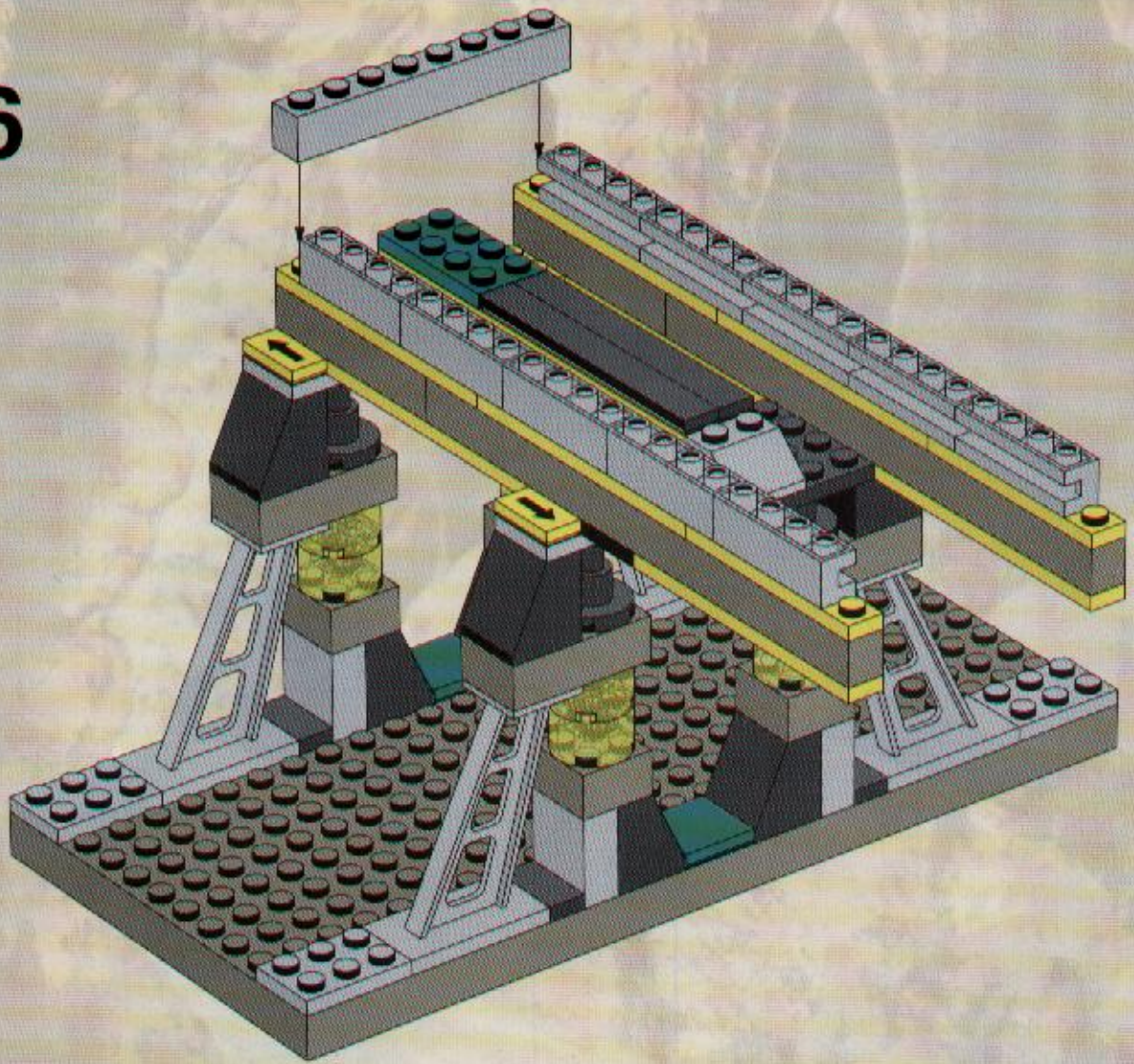

17

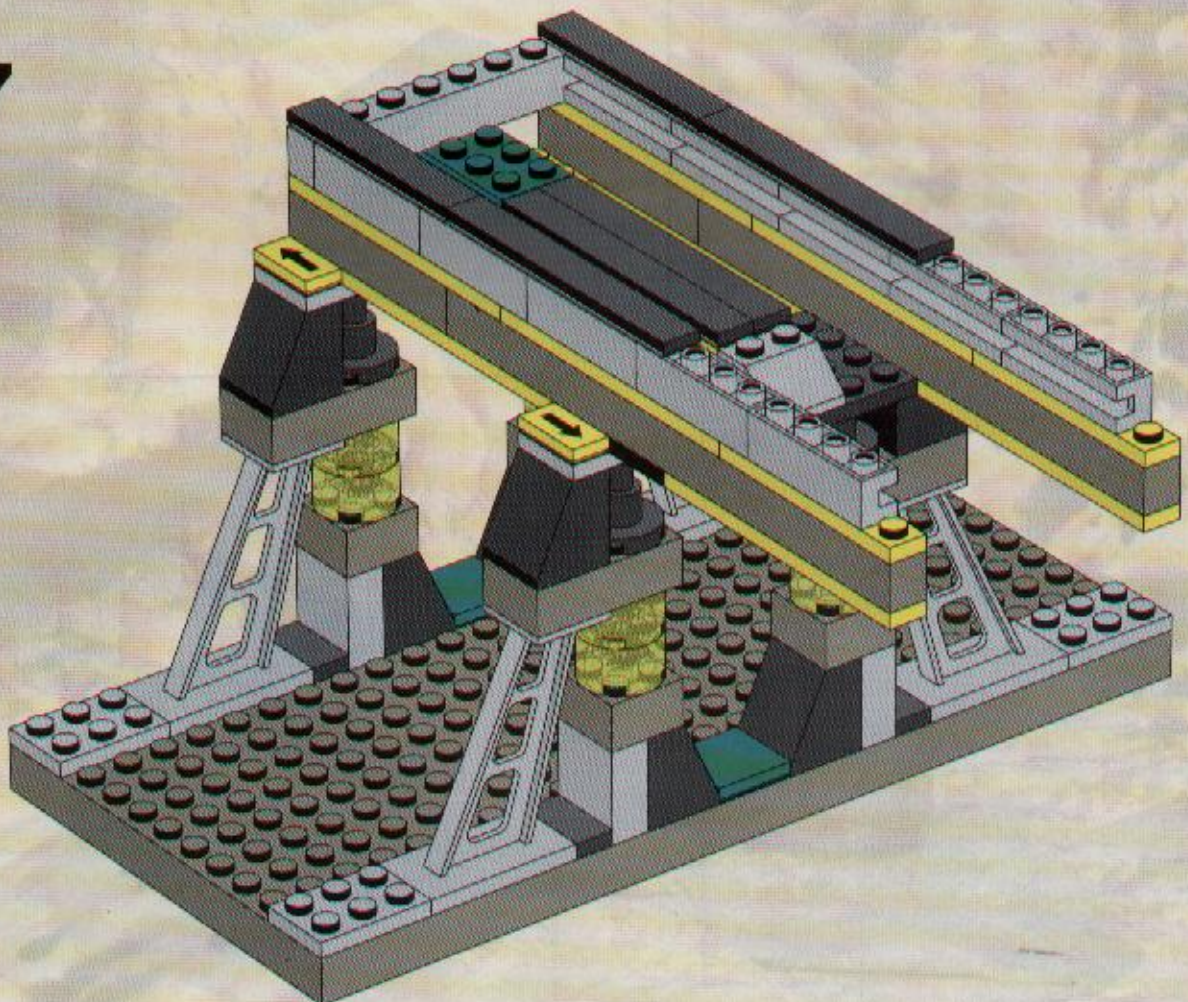

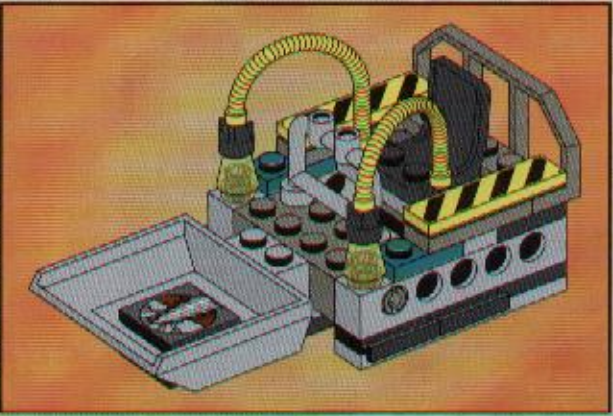

1



2



3

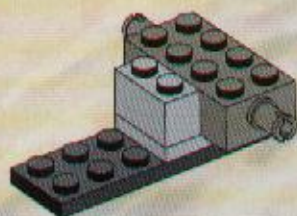

4

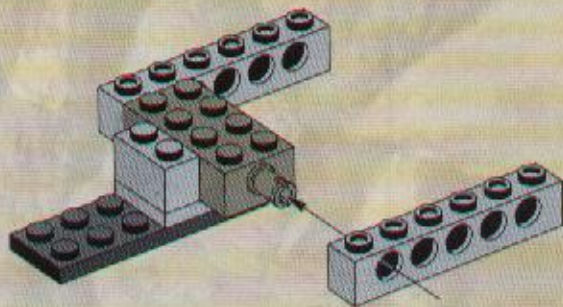

1

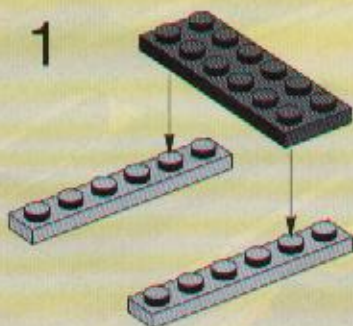

2

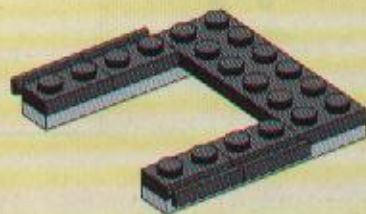

5

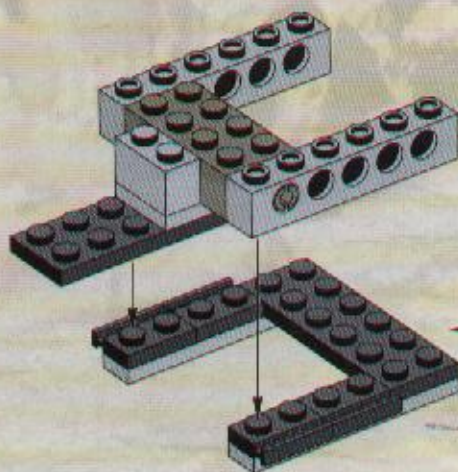

6

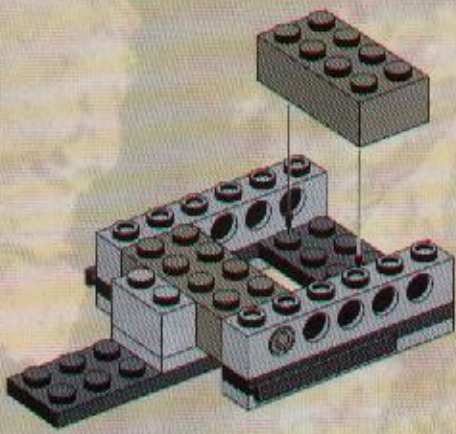

9

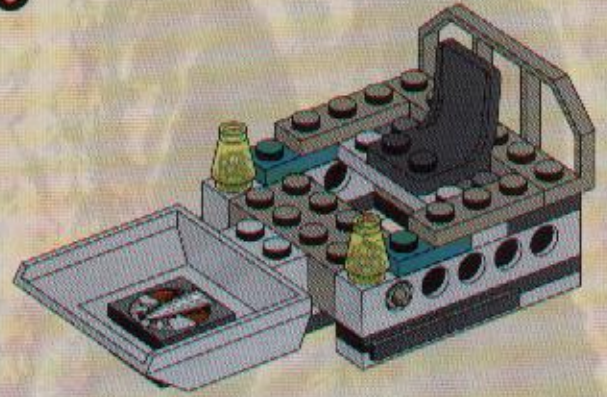

7

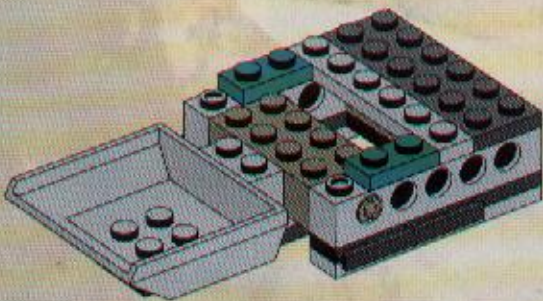

10

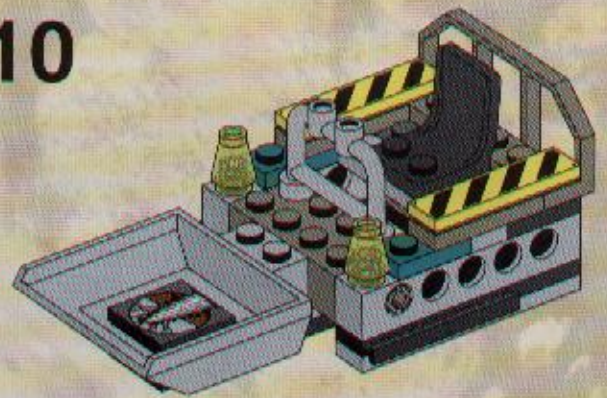

8

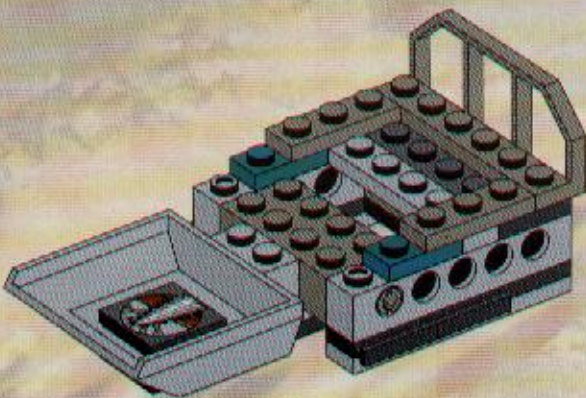

11

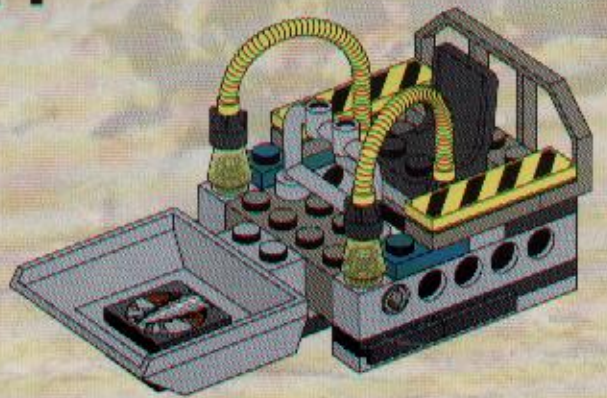

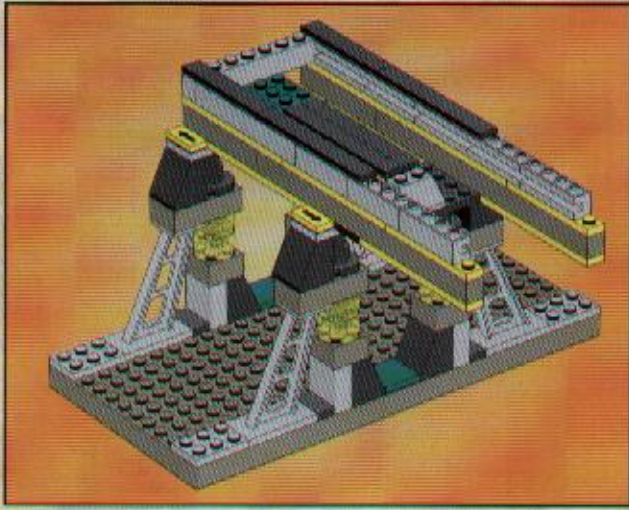

+

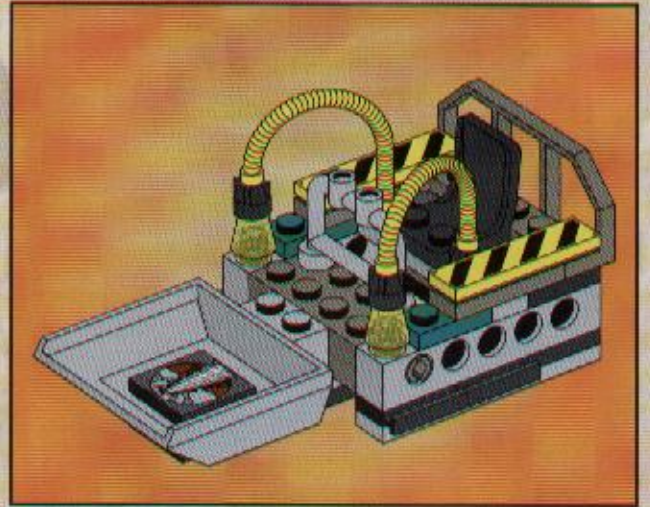

18

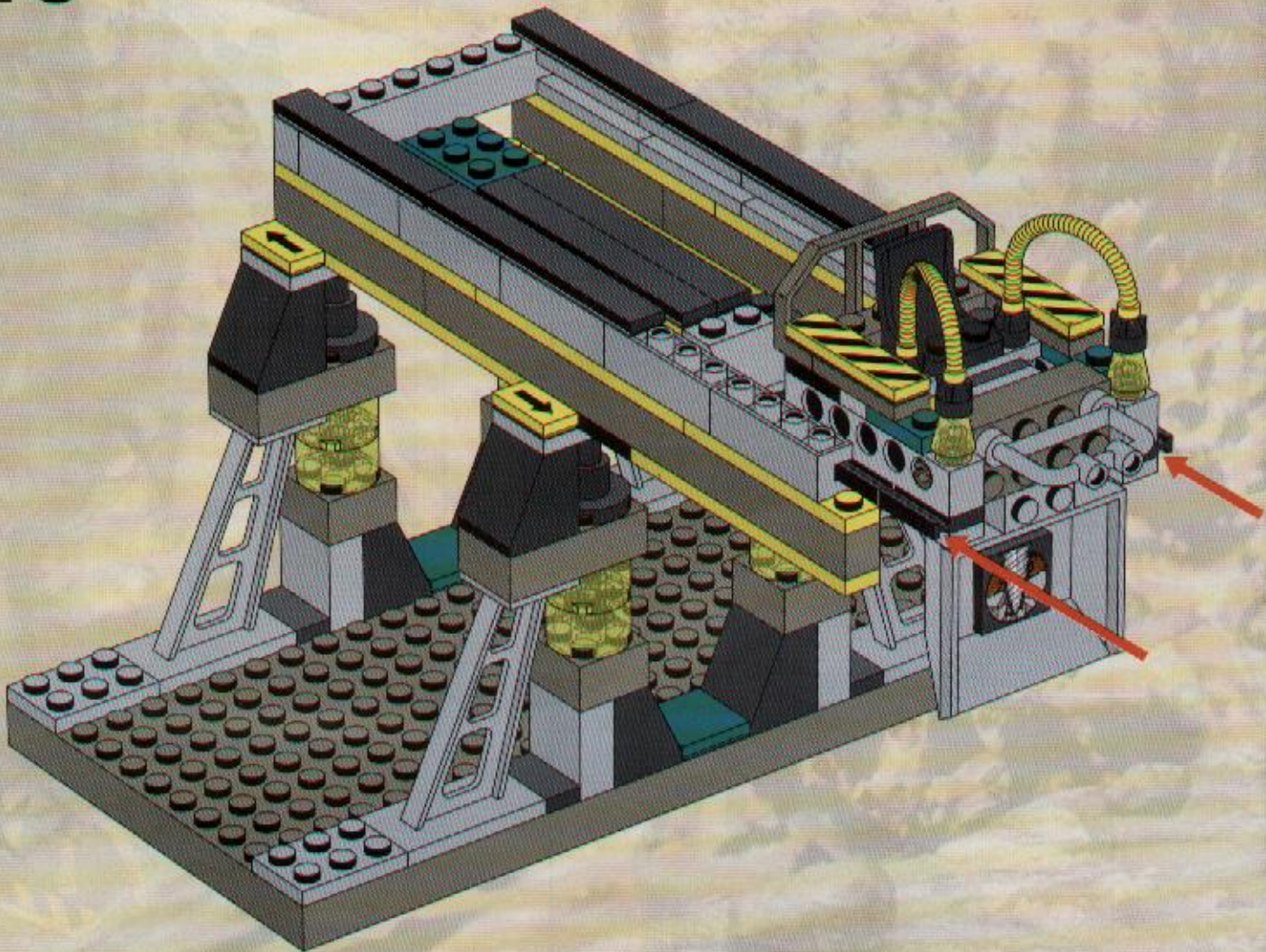

19

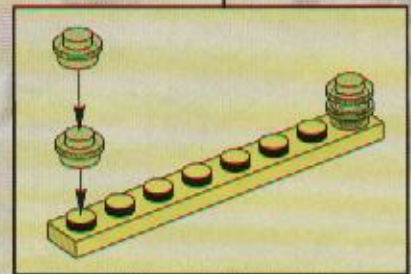
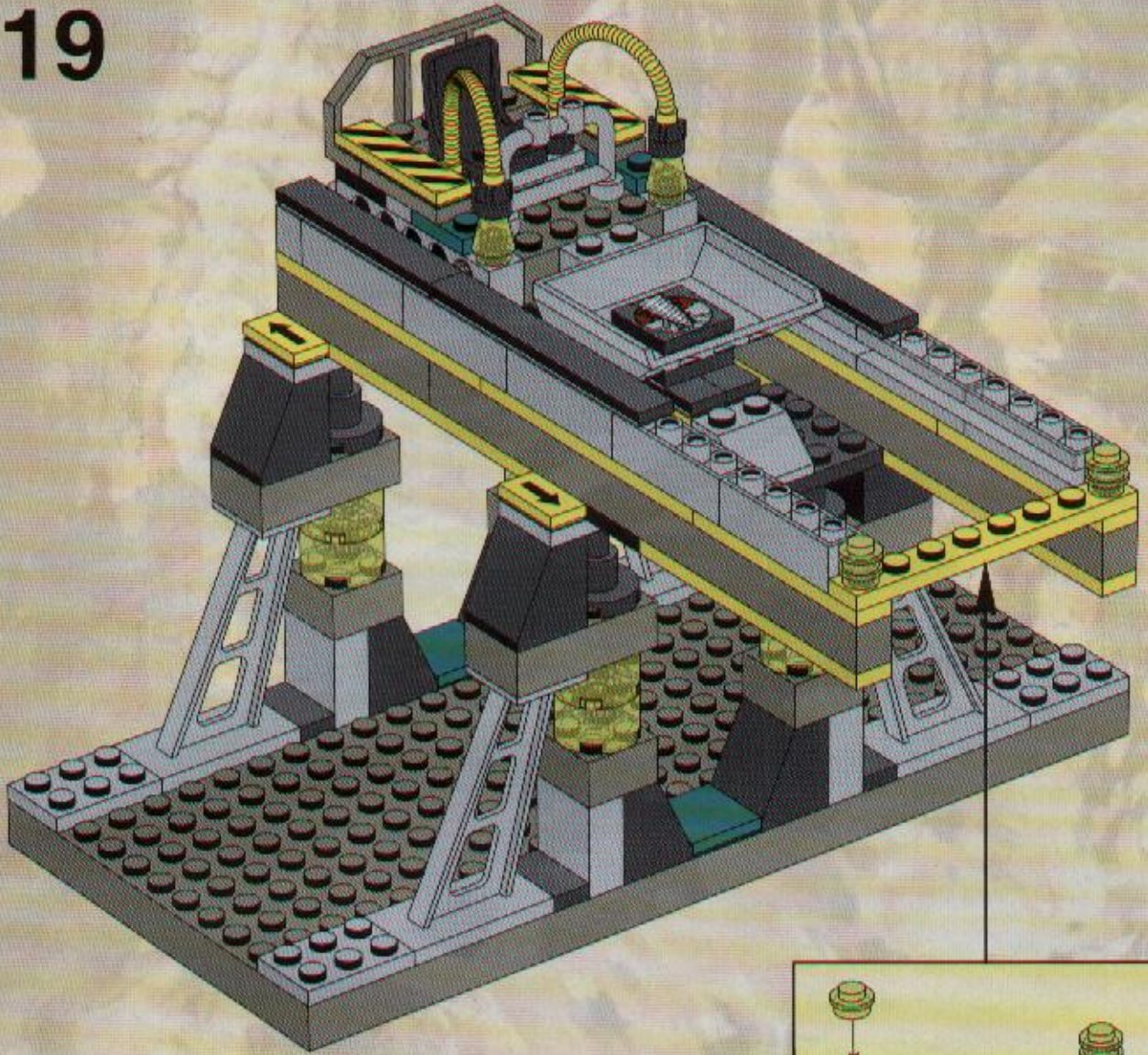

20

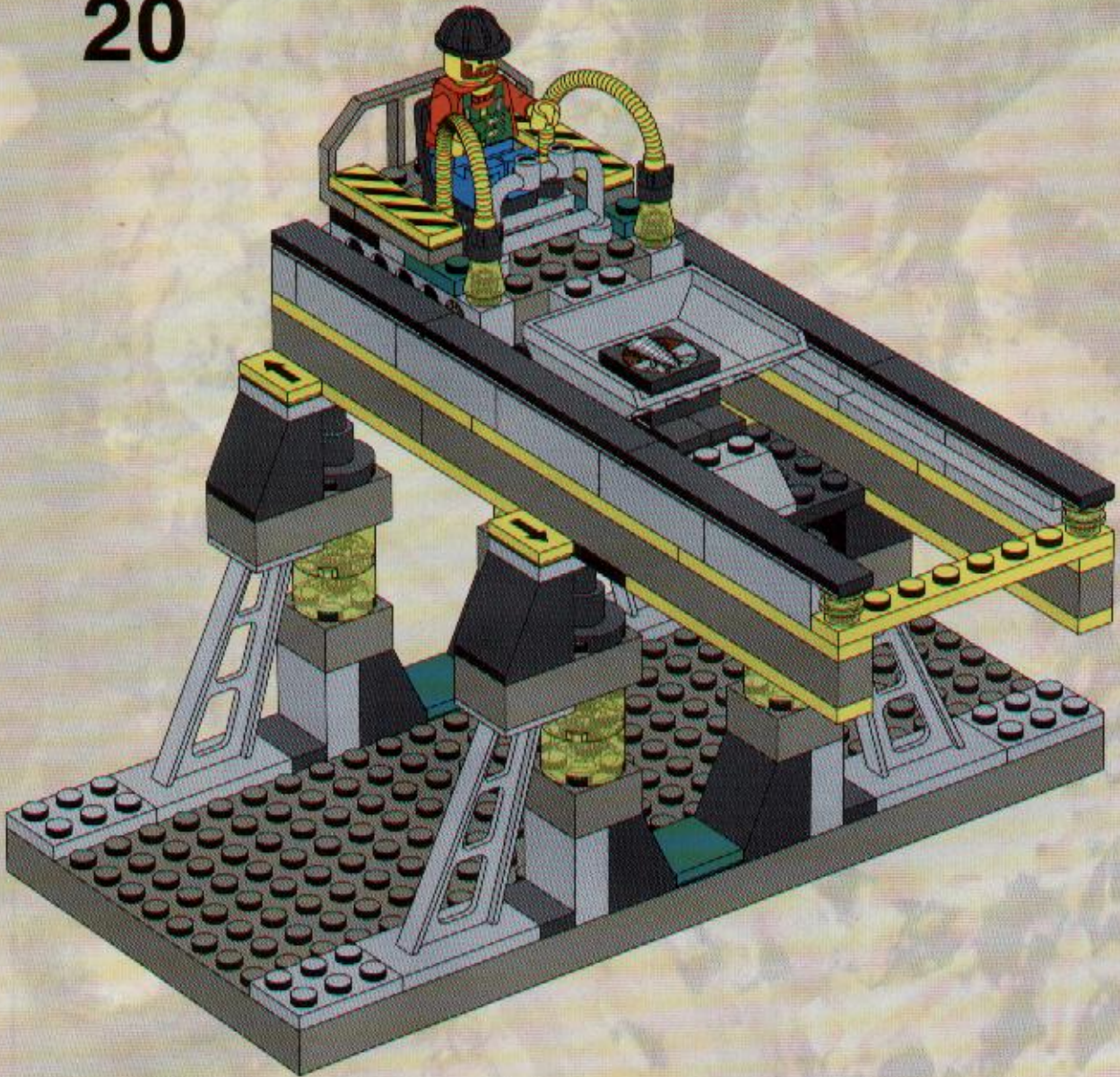



1

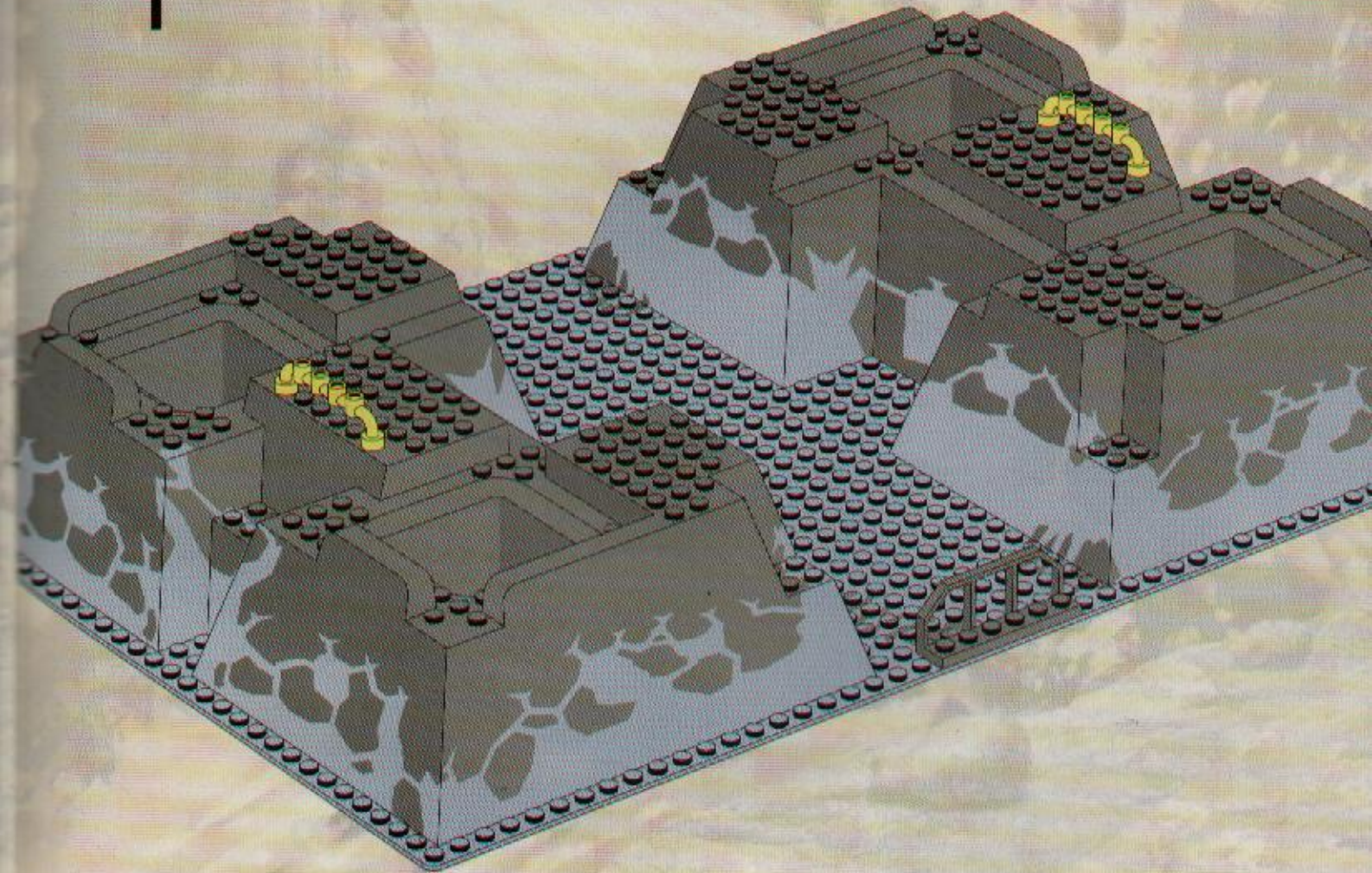

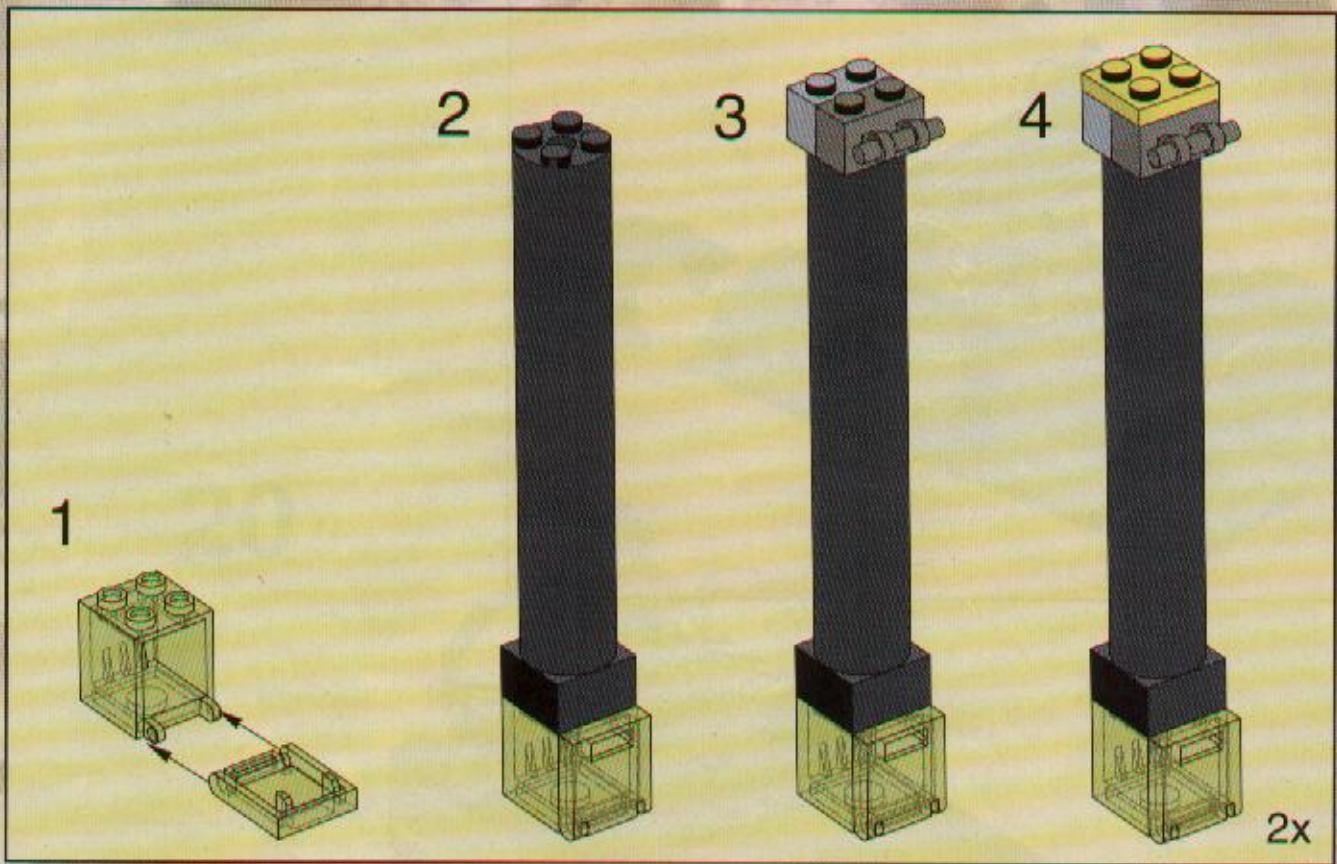

2

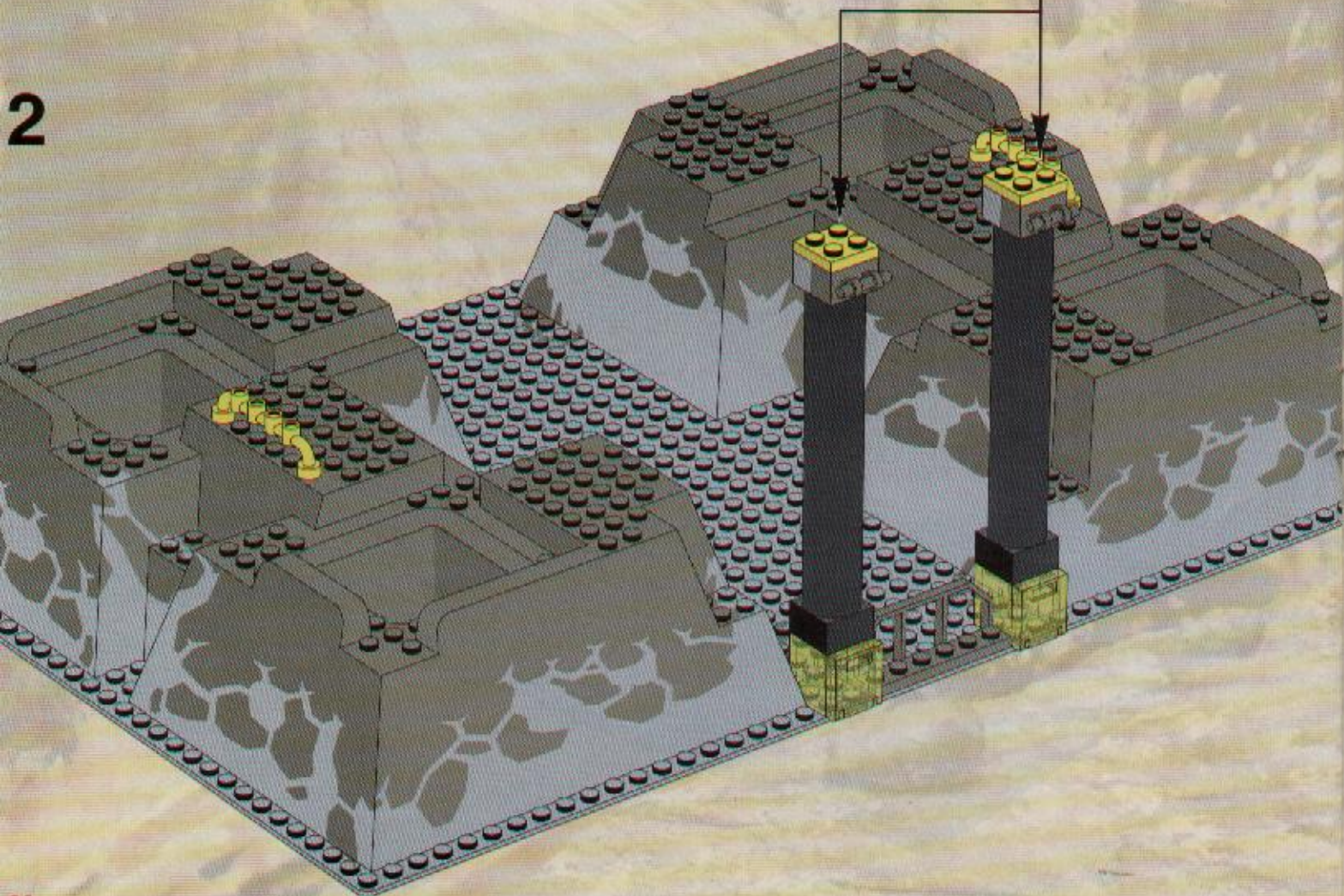

3

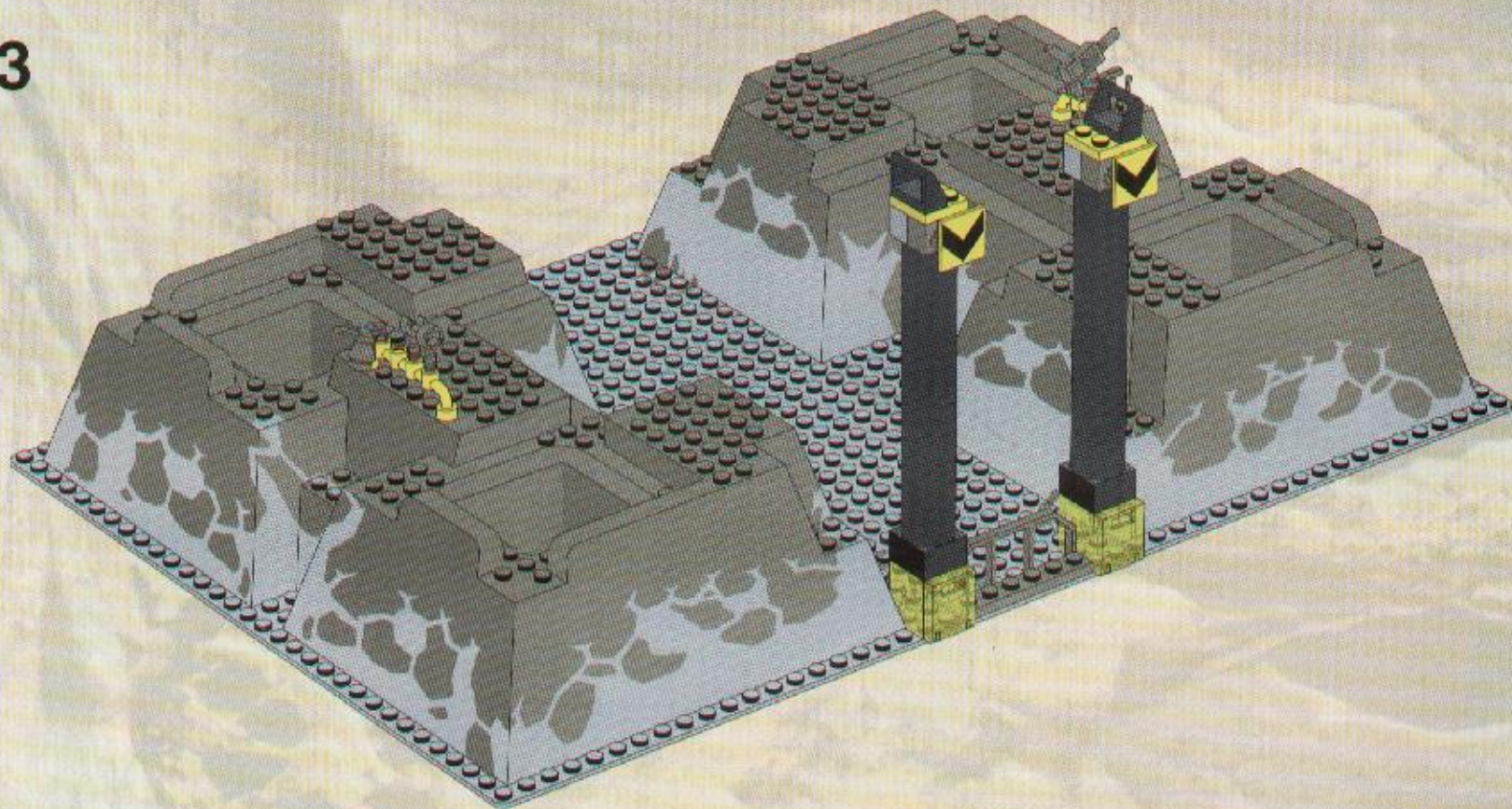

21

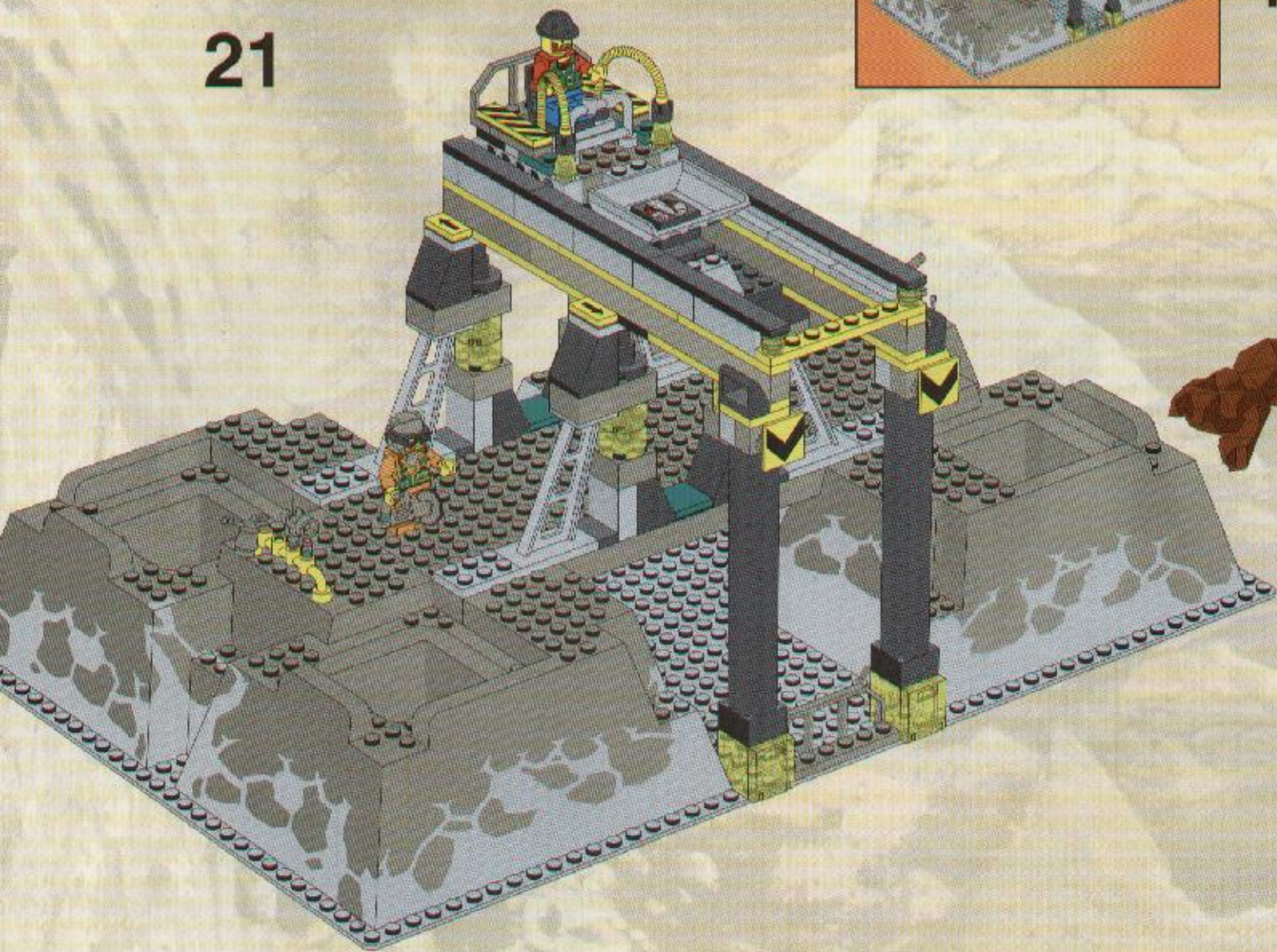

+





+



+



+



+

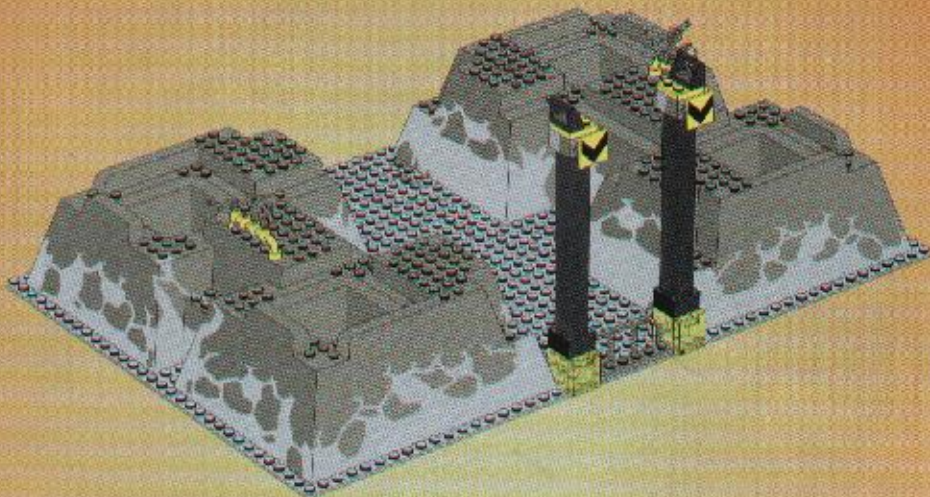

+

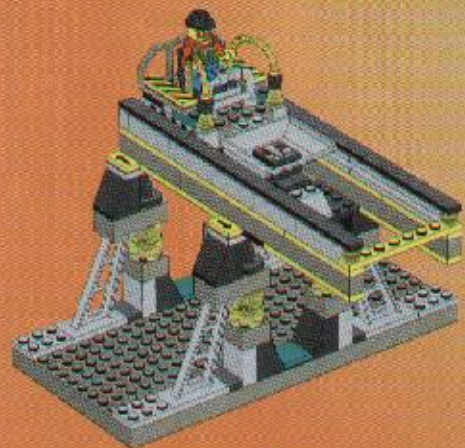

+

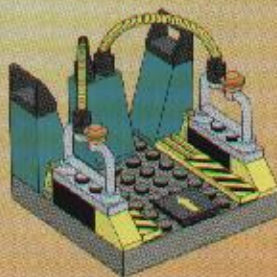

+



22



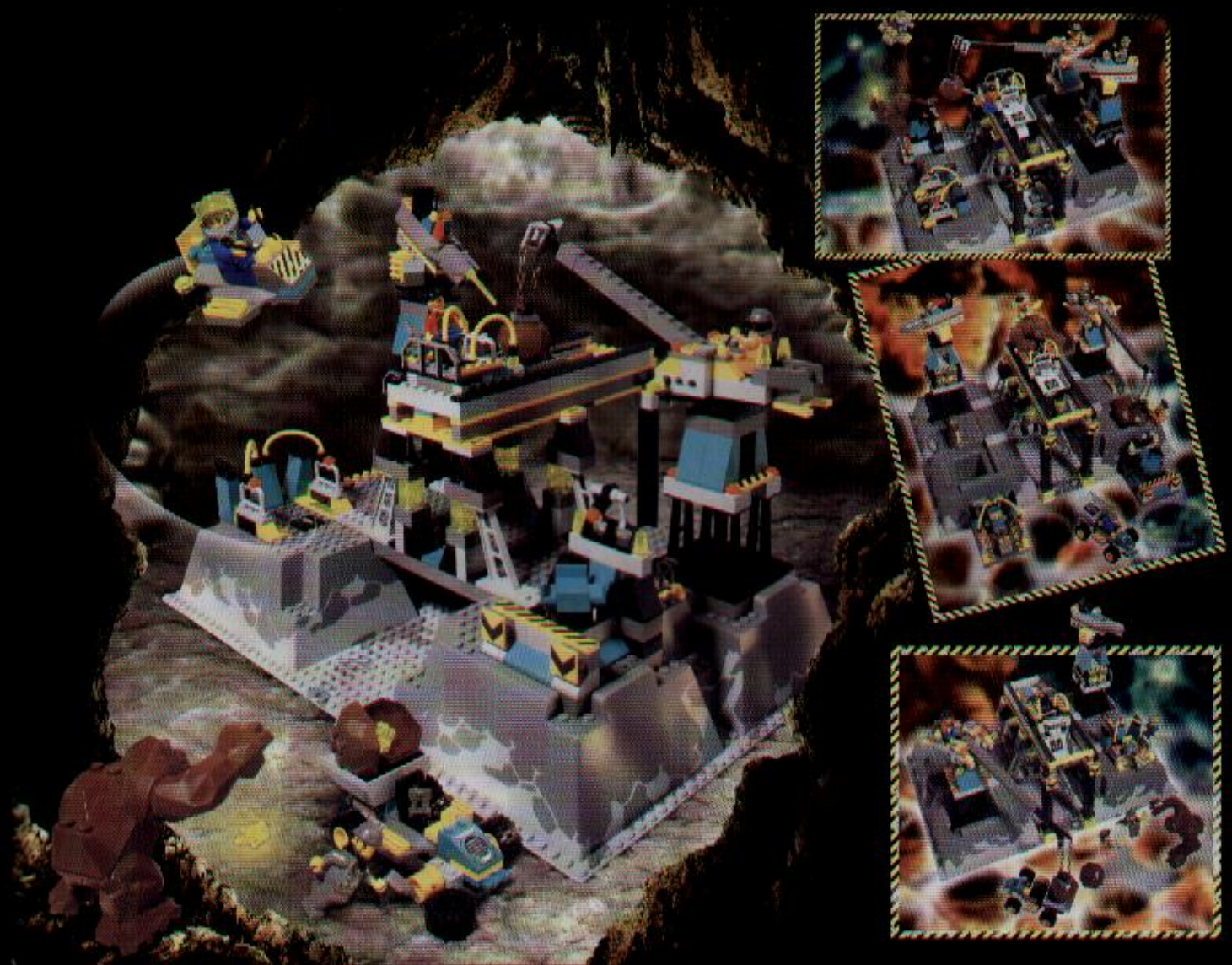





1

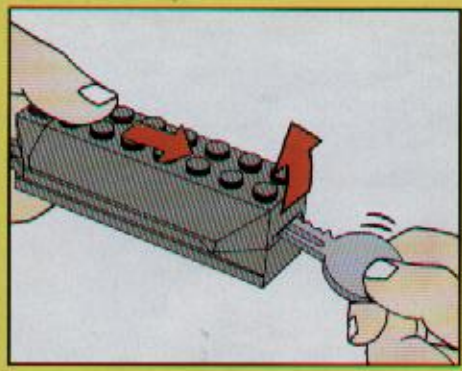

UK **Instructions for use of battery box**
Never mix different types of batteries or old and new batteries in one battery box. Always remove the batteries from the battery box for long-term storage or if they have reached the end of their life. Liquid leaking from dead batteries will damage the battery box. Rechargeable batteries can be used but power may be reduced. Do not recharge the batteries in the battery box.

D **Bedienungshinweise für Batteriekästen**
Benutze niemals verschiedene Batterietypen oder alte und neue Batterien gemeinsam in einem Batteriekasten. Nimm aufgebrauchte Batterien gleich aus dem Batteriekasten. Lagere den Batteriekasten für längere Zeit stets ohne Batterien. Austretende Flüssigkeit aus alten Batterien kann den Batteriekasten beschädigen. Du kannst wiederaufladbare Batterien benutzen. Aber lade sie nicht im Batteriekasten auf. Entsorge verbrauchte und alte Batterien immer über Sammelstellen. Sie gehören nicht in den Hausmüll!

F **Instructions pour l'utilisation du boîtier-piles**
Ne mélangez jamais différents types de piles, ou des anciennes piles avec des neuves. Pensez à enlever les piles du boîtier lorsque vous ne vous en servez pas, et ne les gardez pas trop longtemps, car le liquide provenant de piles usagées peut endommager le boîtier. Vous pouvez utiliser des piles rechargeables, mais ne les rechargez pas dans le boîtier-piles.

I **Istruzioni per l'uso del portapile**
Non utilizzare pile vecchie e nuove nello stesso portapile. Togliere sempre le pile se scariche o se non devono essere utilizzate per lungo tempo. Il liquido che fuoriesce dalle pile scariche danneggia il portapile. E' possibile utilizzare pile ricaricabili. Non ricaricare le pile nel portapile.

NL **Zo gebruikt u de batterijhouder**
Gebruikt u nooit verschillende type batterijen of nieuwe en oude batterijen bij elkaar in een batterijhouder. Als u de batterijhouder langere tijd niet gebruikt, verwijdert u dan de batterijen. Dit geldt ook voor batterijen die leeg zijn. Batterijen die leeg zijn of die lang in de batterijhouder zitten kunnen gaan lekken. Dit veroorzaakt onherstelbare schade en valt niet onder garantie. U kunt oplaadbare batterijen gebruiken. Laad nooit batterijen op in de batterijhouder.

E **Instrucciones para el uso del porta-pilas**
Dentro de una misma caja porta-pilas no mezclar nunca distintos tipos de pilas ni tampoco las nuevas con las ya usadas. Sacar siempre las pilas de la caja porta-pilas cuando no vayan a utilizarse por un tiempo y cambiarlas igualmente cuando estén muy usadas, ya que el líquido que desprendan pueda dañar las conexiones de la caja porta-pilas. Pueden utilizarse pilas recargables, si bien no deben recargarse dentro de la caja porta-pilas.

DK **Batteriforretning**
Brug aldrig forskellige typer batterier sammen, eller nye og gamle batterier i samme batteriboks. Tag altid batterierne ud af batteriboksen, hvis du ikke skal bruge den i længere tid, eller hvis batterierne er brugt op. Væske fra batterierne kan ødelægge batteriboksen. Man kan anvende genopladelige batterier. Genoplad aldrig batterierne i batteriboksen.

FIN **Paristokotelon käyttöohje**
Erityyppisiä tai uusia ja vanhoja paristoja ei pitäisi koskaan käyttää samanaikaisesti. Poistakaa paristot aina paristokotelosta mikäli ne ovat loppuunkäytetyt tai mikäli ette käytä paristokoteloita pitkään aikaan. Nestevuodot loppuunkäytetyistä paristoista vahingoittavat paristokoteloita. Voitte käyttää myös akkuja. Älkää kuitenkaan laadako akkuja paristokotelossa.

S **Instruktioner till batteriboxen**
Blanda inte olika typer av batterier och inte heller nya och gamla batterier i samma batteribox. Ta ut batterierna ur boxen om du inte skall använda den på länge, eller om batterierna är slut. Läckande vätska från gamla batterier skadar batteriboxen. Laddningsbara batterier kan användas. Ladda inte upp batterierna i batteriboxen.

P **Instruções para utilização da Caixa de Pilhas**
Não misturar nunca pilhas de tipos diferentes ou pilhas novas e velhas na mesma caixa de pilhas. Retirar sempre as pilhas da caixa no caso de armazenagem prolongada ou se elas já estiverem gastas. O líquido vertido pelas pilhas gastas danificará a caixa de pilhas. Podem ser utilizadas pilhas recarregáveis. Não recarregue as pilhas na caixa.

日本語 **電池ケース使用上のご注意**
異なる種類の電池や、古い電池と新しい電池を混ぜて使用することはお避けてください。電池の寿命が切れた場合、または長期で使用する場合は、ケースから電池を抜いてください。切れた電池から液が漏れて、電池ケースを損傷することになります。充電式電池も使用できますが、パワーは弱くなる場合があります。なお、電池ケースの中で充電しないようご注意ください。

中文 **電池盒使用說明**
切勿在同一個電池盒內同時使用不同類型的電池或混合新舊電池。需要長期儲存電池或者電池已經用盡的話，請把電池從電池盒內取出。從舊電池漏出來的液體會損壞電池盒。您可以使用充電式電池，但它們的電力比較弱。進行充電時，請勿把電池留在電池盒內。

عربي **تعليمات استعمال صندوق البطارية**
يجب عدم خلط أنواع مختلفة من البطاريات، أو خلط البطاريات القديمة مع الجديدة في صندوق بطارية واحد. كما يجب دائما مراعاة إزالة البطاريات من صندوق البطارية، عند حفظها وعدم استعمالها لمدة طويلة أو عند انتهاء فعاليتها. كما وأنه يجب الأخذ في الاعتبار أن تسرب السائل من البطاريات القديمة التي انتهت فعاليتها يؤدي إلى تلف صندوق البطارية. يمكن استعمال البطاريات التي يعاد شحنها، إلا أن ذلك قد يؤدي إلى تقليل وانخفاض الطاقة. يجب عدم إعادة شحن البطاريات في صندوق البطارية.

한국어 **전원저 막스 사용법**
전원저 막스에는 알카라인 전선지와 일반 전선지를 함께 사용하지 마시고, 오래 된 전선지와 새 전선지도 함께 사용하지 마십시오. 전원저 막스 수명이 다한 중이나 사용하지 않을 때에는 항상 전원저 막스로부터 전선지를 제거하여 주십시오. 수명이 다한 전선지에서 액체가 나오면 전원저 막스를 상해시킬 수 있습니다. 즉전지는 사용이 가능하나 전력은 약해질 수 있습니다. 전선지를 전원저 막스에서 충전하지 마십시오.

TH **วิธีการใช้ถ่านไฟฉาย**
อย่าใช้แบตเตอรี่ที่รวมกันชนิดอื่น หรือใช้แบตเตอรี่ที่รวมกันแบบเคมีใหม่กับถ่านแบบเคมี หรือ ถ่านถนอมกับถ่านทุกทรง เมื่อไม่ใช้ไฟฉายเป็นระยะเวลานาน หรือเมื่อแบตเตอรี่หมดอายุ น้ำจืดที่รั่วออกจากแบตเตอรี่ที่หมดอายุ จะทำให้กล่องแบตเตอรี่เสียหายได้ สามารถใช้แบตเตอรี่ที่ชาร์จไฟได้ แต่ถ่านไฟฉายถนอมห้ามชาร์จแบตเตอรี่ในกล่องใช้ถ่านไฟฉาย

H **Utastások az elemtartó használatához**
Soha ne használj egyszerre különböző fajta elemeket vagy használt és új elemeket egy elemtartóban. Ha sokáig nem használod az elemeket vagy ha már lemerültek, vedd ki őket az elemtartóból. Az elhasznált elemekből kiáramló folyadék károsíthatja az elemtartót. Feltölthető elemeket természetesen használhatsz, de élettartamuk rövidebb lehet. Soha ne töltsd fel az elemeket a elemtartóban.

GR **Οδηγίες χρήσεως του κουτιού μπαταρίας**
Ποτέ μην αναμιγνύετε διαφορετικούς τύπους μπαταριών ή νέες με παλιές μπαταρίες στο ίδιο κουτί. Όταν τις αποθηκεύετε για πολύ χρόνο ή όταν οι μπαταρίες έχουν χαλάσει, απομακρύνετε τις πάντοτε από το κουτί μπαταρίας. Υγρό που στάζει από άδεια μπαταρίες θα χαλάσει το κουτί μπαταρίας. Επαναφορτιζόμενες μπαταρίες μπορούν να χρησιμοποιηθούν. Μην επαναφορτίζετε τις μπαταρίες μέσα στο κουτί.

TR **Pil kutusu kullanma talimatı**
Hiçbir zaman değişik tipteki pilleri ve eski ile yeni pilleri birarada kullanmayınız. Motoru uzun süre kullanmayacağınız pilleri kutuda bırakmayınız. Başlangıç pilleri kutudan çıkartınız. Başlangıç pillerinin akması pil kutusuna zarar verebilir. Şarj edilebilen pilleri de kullanabilirsiniz, ancak bu durumda güç azalabilir. Pilleri kutunun içine şarj etmeyiniz.

Cara menggunakan kotak bateri
MAL Jangan campurkan bateri lama dan baru dalam satu kotak bateri. Jika tidak menggunakan motor atau bateri habisannya kuasa, keluarkanlah daripada kotak. Kebocoran daripada bateri yang habis akan merosakkan kotak. Bateri yang boleh dicas boleh digunakan tetapi kuasa tenaganya berkurangan. Jangan sekali-kali memcajak bateri di dalam kotak.

2

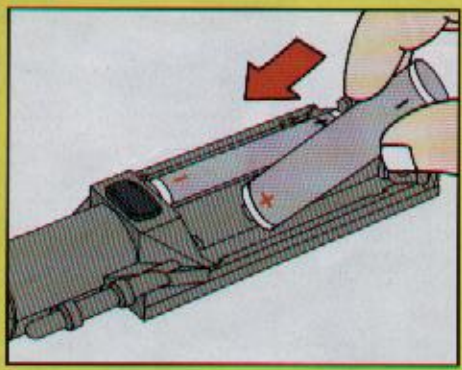

3

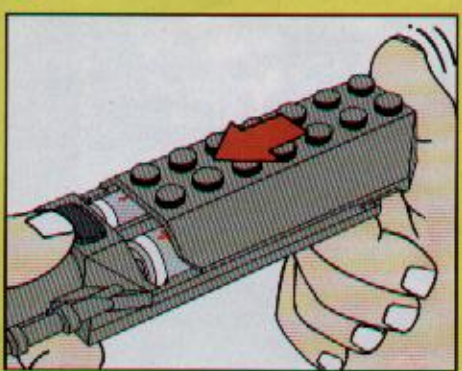

4

