

**LEGO**

**SPIDER-MAN 2**

4860

**4+**



1



2



3





1

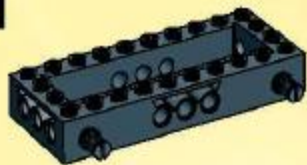

2

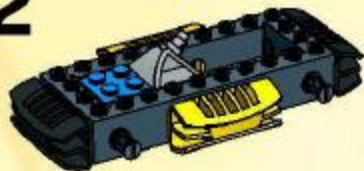

3

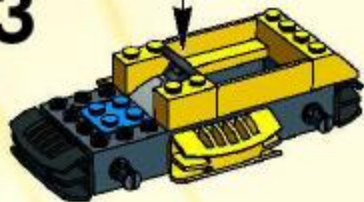

4



5





1



2

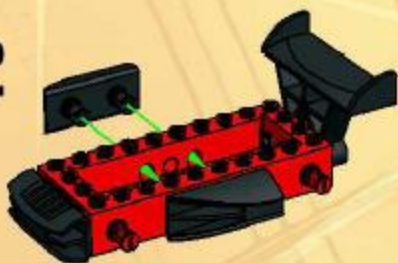

3



4



5





1

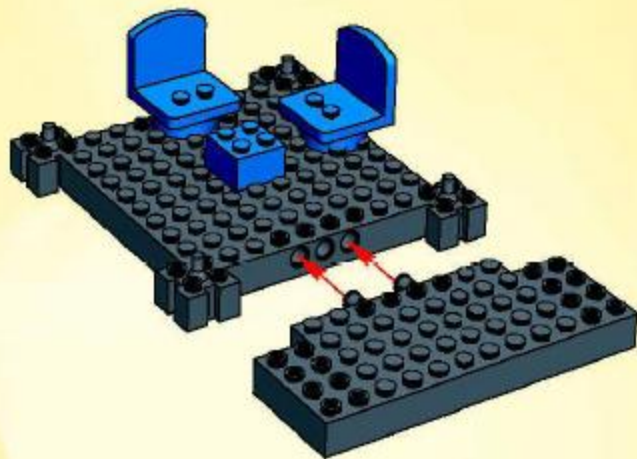

2

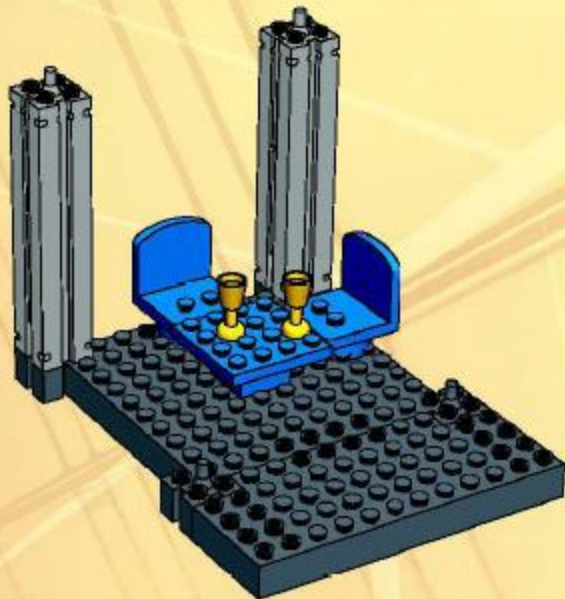

3

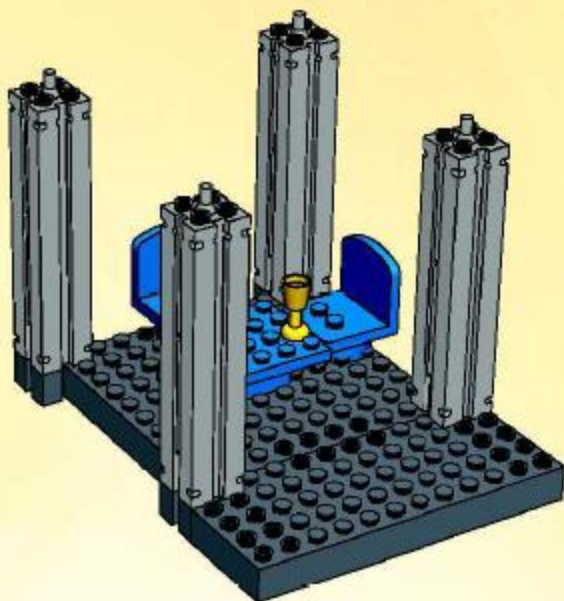

4

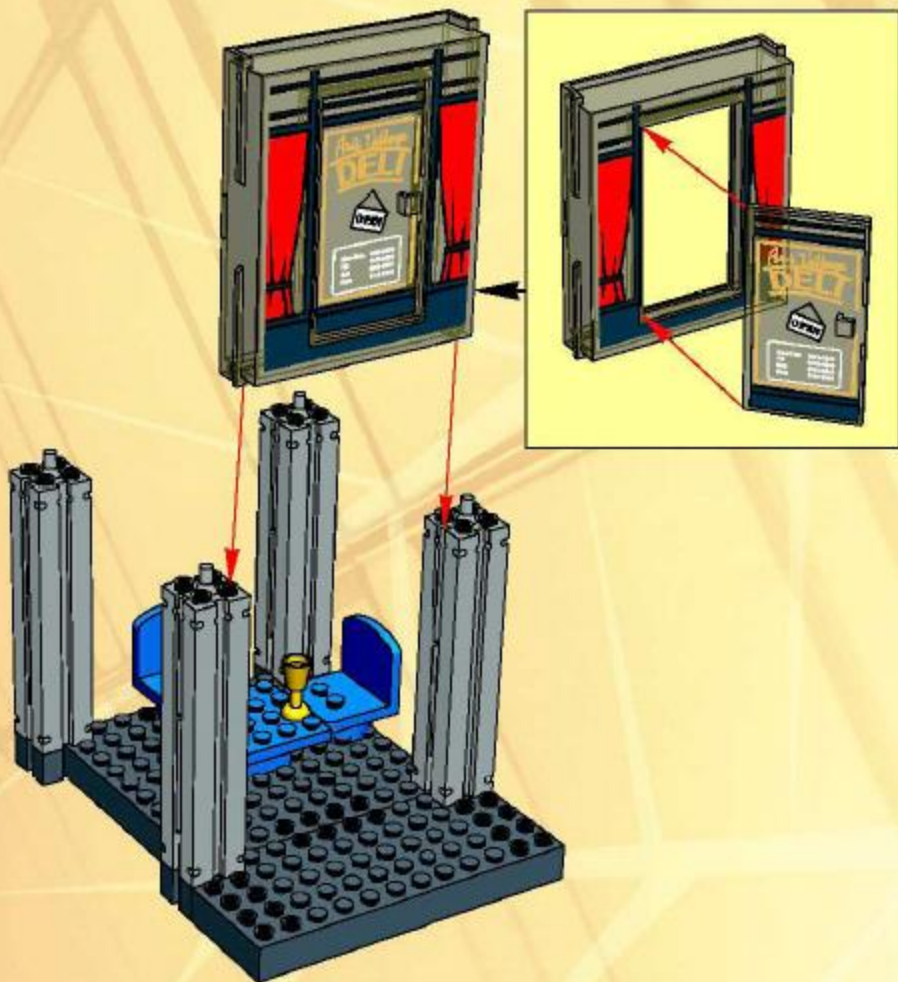



5

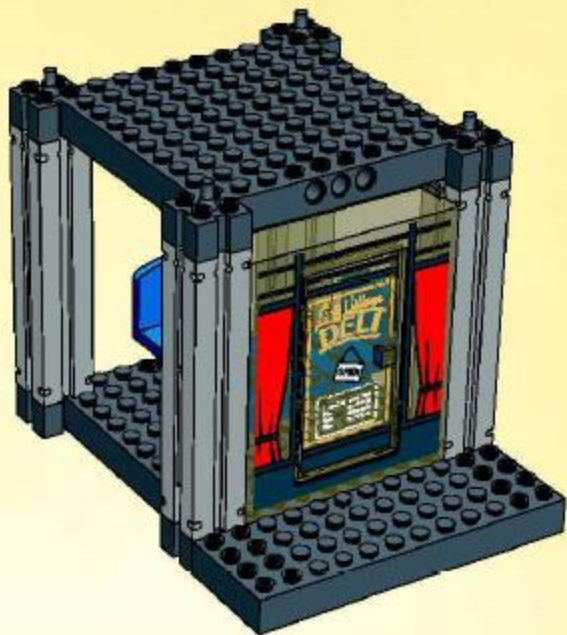

6

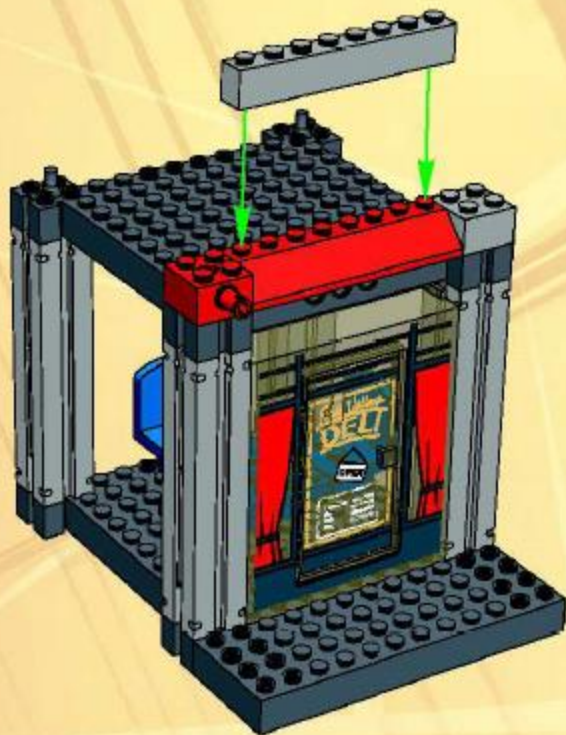

7

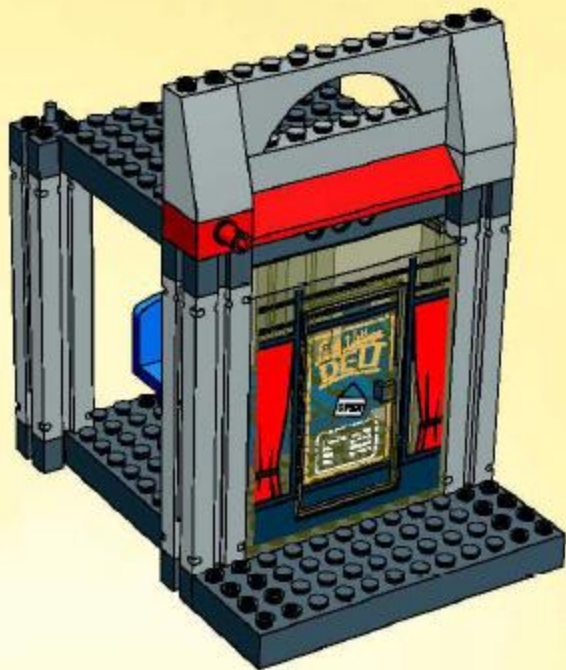

8

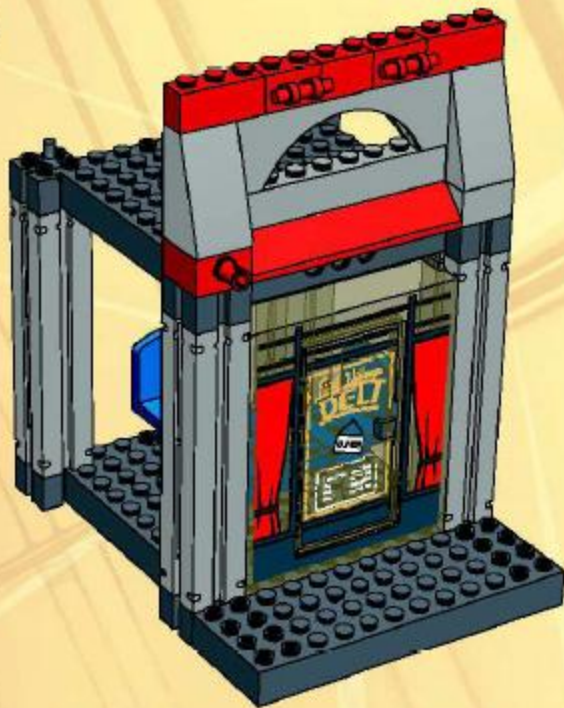

1



2

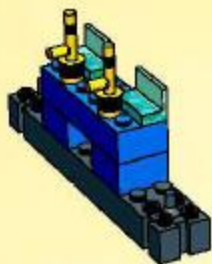

3



4



5



9



10





1

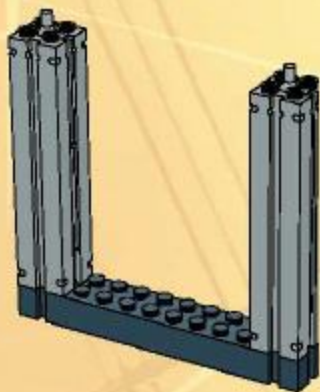

2

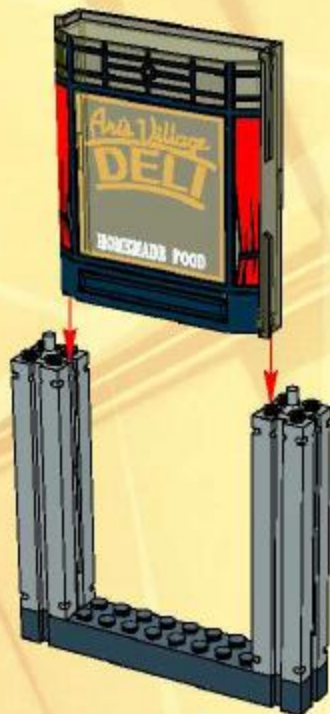



3



4



5



6

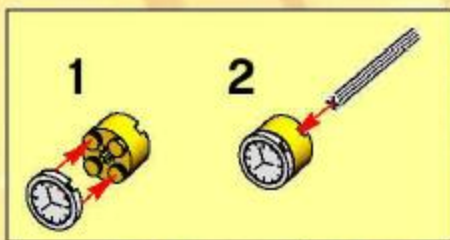

11



12

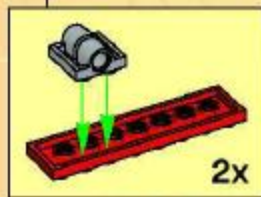

13



14

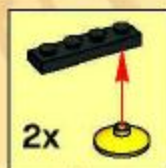

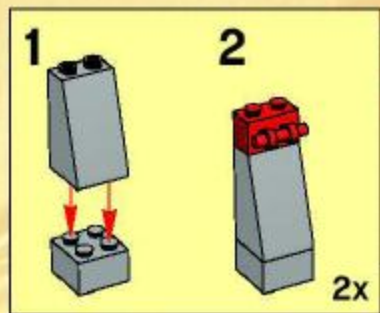

15











# Win! Gagne! Gewinne! 当たります



#### WIN LEGO® PRODUCTS

We would like to know what you think about our new LEGO® product. If you could help us by answering a few questions you are in with a chance of winning an exciting LEGO prize. It will only take you about 3 minutes! Log on to the web address below for further instructions.



#### GAGNE DES PRODUITS LEGO®

Nous aimerions savoir ce que tu penses de ton nouveau produit LEGO®. Si tu veux bien nous aider en répondant à quelques questions, tu recevras peut-être bientôt un fantastique prix LEGO. Et cela ne te prendra que 3 minutes environ! Tu obtiendras davantage d'informations en visitant le site Internet indiqué ci-dessous.



#### GEWINNE LEGO® PRODUKTE

Wir sind sehr an deiner Meinung über dein neues LEGO® Produkt interessiert. Wann du uns den Gefallen tust und ein paar Fragen beantwortest, kannst du einen tollen LEGO Preis gewinnen. Das Ganze dauert nur etwa 3 Minuten! Gehe einfach zu der unten angegebenen Webadresse - dort findest du weitere Informationen.



#### Estimado usuario LEGO®

Al contestar algunas preguntas en Inglés, francés, alemán o japonés, en el sitio [www.acnielsen.aim.dk/lego](http://www.acnielsen.aim.dk/lego), podrás participar en el sorteo de algunos valiosos premios LEGO®.



#### Caro Consumidor da LEGO®

Ao responder a algumas perguntas em Inglês, Francês, Alemão ou Japonês no endereço [www.acnielsen.aim.dk/lego](http://www.acnielsen.aim.dk/lego) irá participar num concurso para ganhar valiosos prémios de LEGO®.



#### Kedves új LEGO® Vásárló!

Ha elértogatsz a [www.acnielsen.aim.dk/lego](http://www.acnielsen.aim.dk/lego) honlapra és ott angol, francia, német vagy japán nyelven megválaszolsz néhány kérdést, akkor névvel veszel egy versenyben, amelyben értékes LEGO® ajándékot nyerhetsz.



#### 投票でレゴ®製品が当たります

英語、フランス語、ドイツ語、または日本語でいくつかの質問に答えると、[www.acnielsen.aim.dk/lego](http://www.acnielsen.aim.dk/lego) のサイトで競争相手に参加し、いくつかの素晴らしい賞品に当たるチャンスがあります。これはわずか3分程度で完了します。詳しくは、以下のウェブアドレスにアクセスしてください。

## [www.acnielsen.aim.dk/LEGO](http://www.acnielsen.aim.dk/LEGO)





4856



4857



4855



4854



4853



4858



4860



MARVEL

SPIDER-MAN

COLUMBIA PICTURES

LEGO and the LEGO logo are trademarks of the LEGO Group. © 2004 The LEGO Group. Spider-Man and all related characters, TM & © 2004 Marvel Characters, Inc. Spider-Man is the name of 2004 Columbia Pictures Industries, Inc. All rights reserved.

4249015