

LEGO

6+

4506

Designer Set



Instructions

Ideas



Quick Build
Schnellbaumodelle
Construction rapide
Costruzione rapida
Snel bouwen
Construcción rápida
Byg hurtigt
Nopeaan rakentamiseen
Bygg snabbt
Construção Rápida
Γρήγορες Κατασκευές
Kísérletezőknek



4



11



16



Experienced Build
Könnernmodelle
Construction normale
Costruzione esperta
Bouwen voor gevorderden
Construcción experta
Byg videre
Kokeneelle rakentajalle
Bygg mer
Construção para Experimentados
Επιδέξιες Κατασκευές
Haladóknak



49



26



34



Advanced Build
Profimodelle
Construction avancée
Costruzione avanzata
Geavanceerd bouwen
Construcción avanzada
Byg avanceret
Taitavaile rakentajalle
Bygg avancerat
Construção Avançada
Εξελιγμένες Κατασκευές
Profiknak



69



60



90



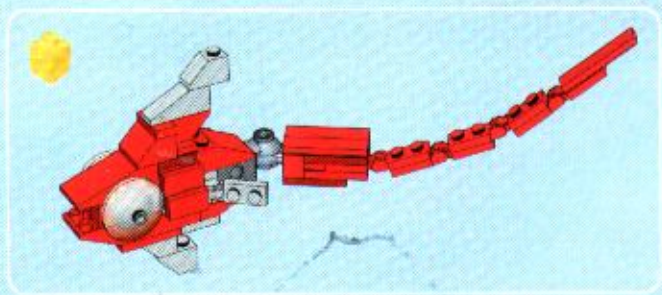

1



2

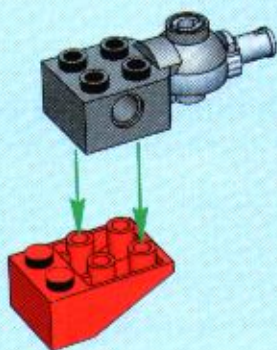

3

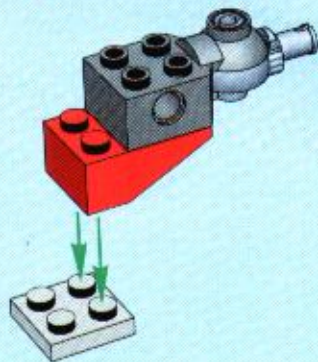

4

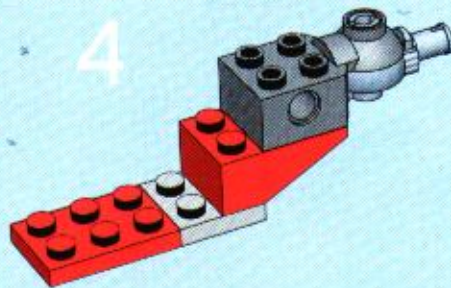

5

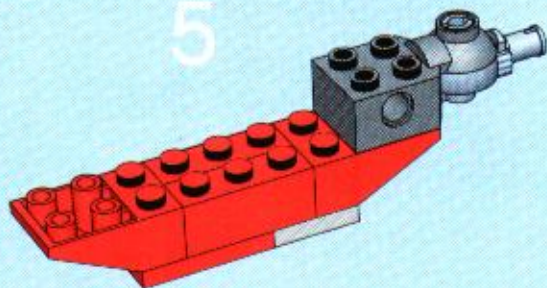

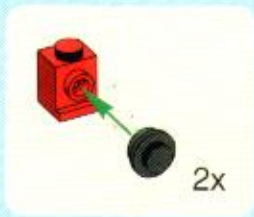

6

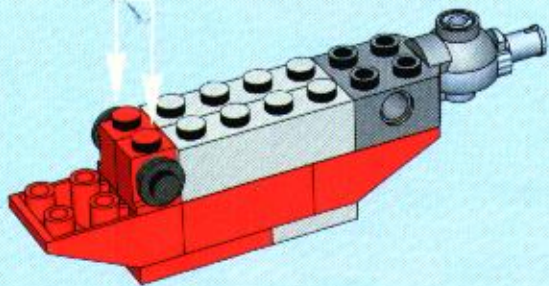

7

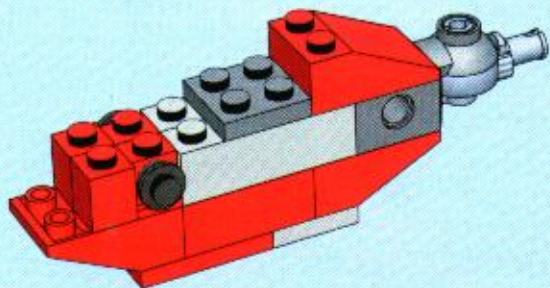

1



2

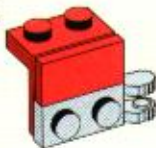

3

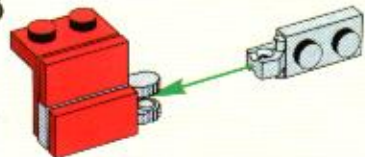

8

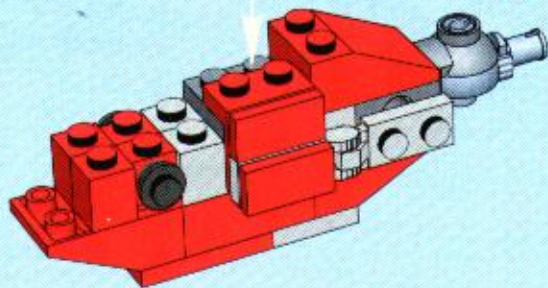

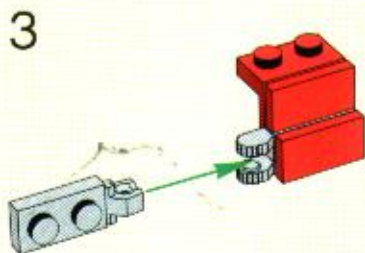

9

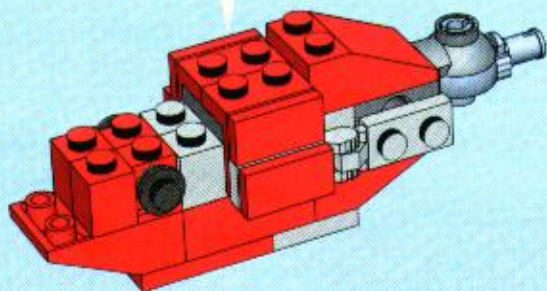

10

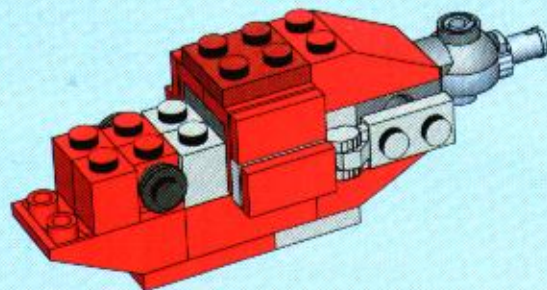

11

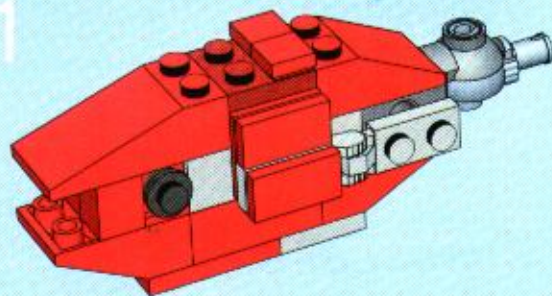

12

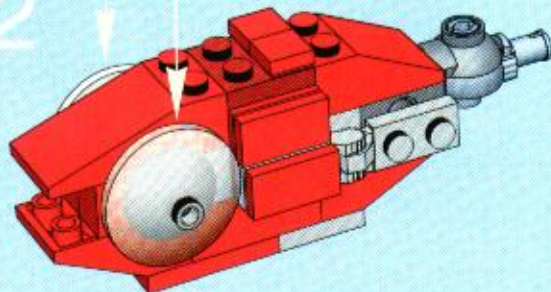

13

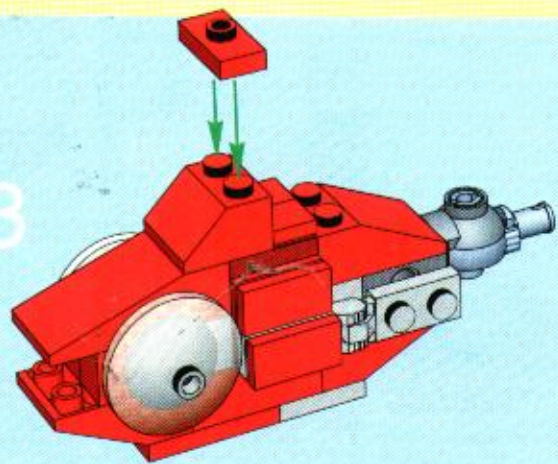

1

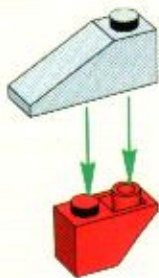

2

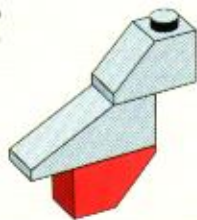

14

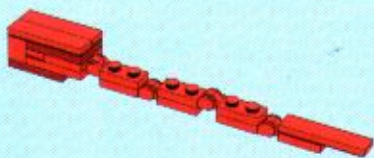
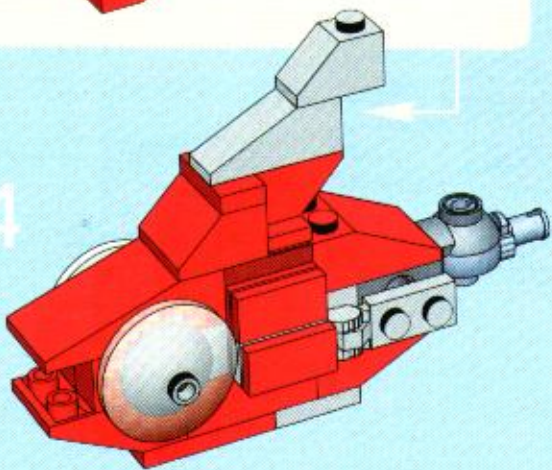

1



2

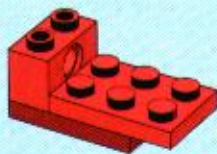

3

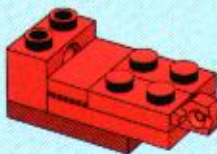

4

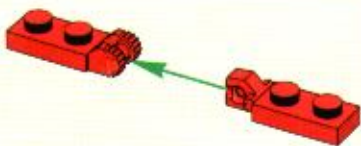
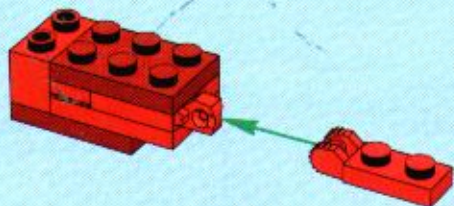

5

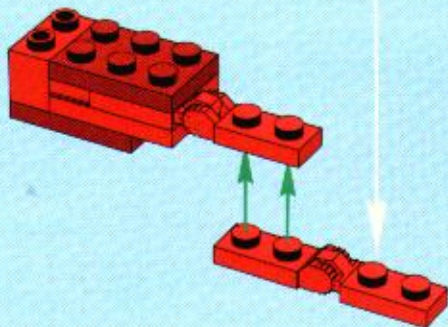

6

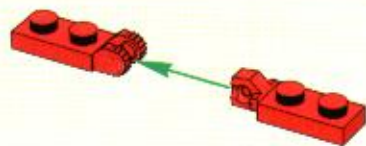
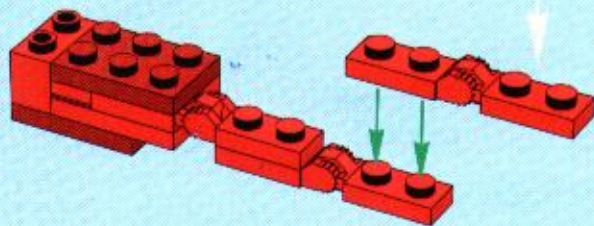

7

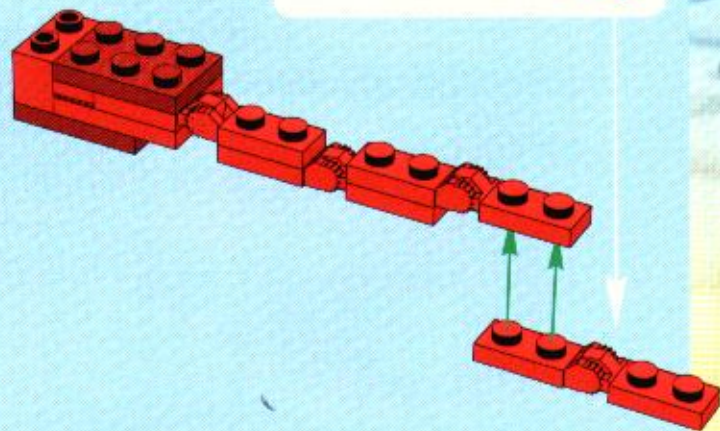

8

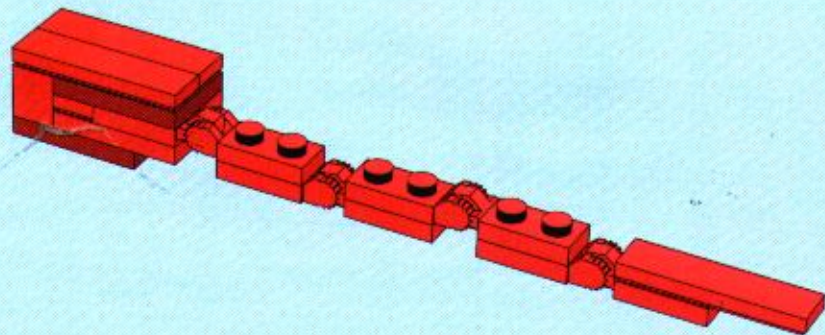

15

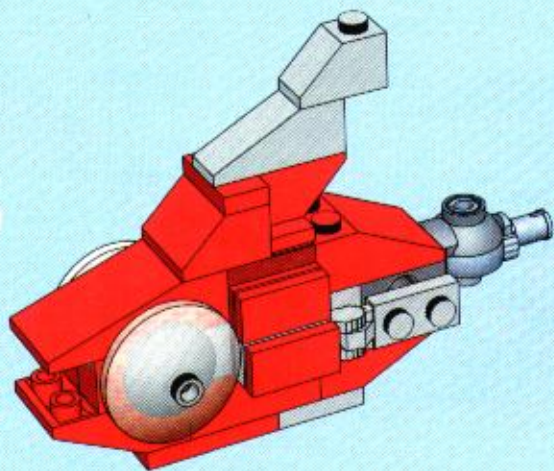

16

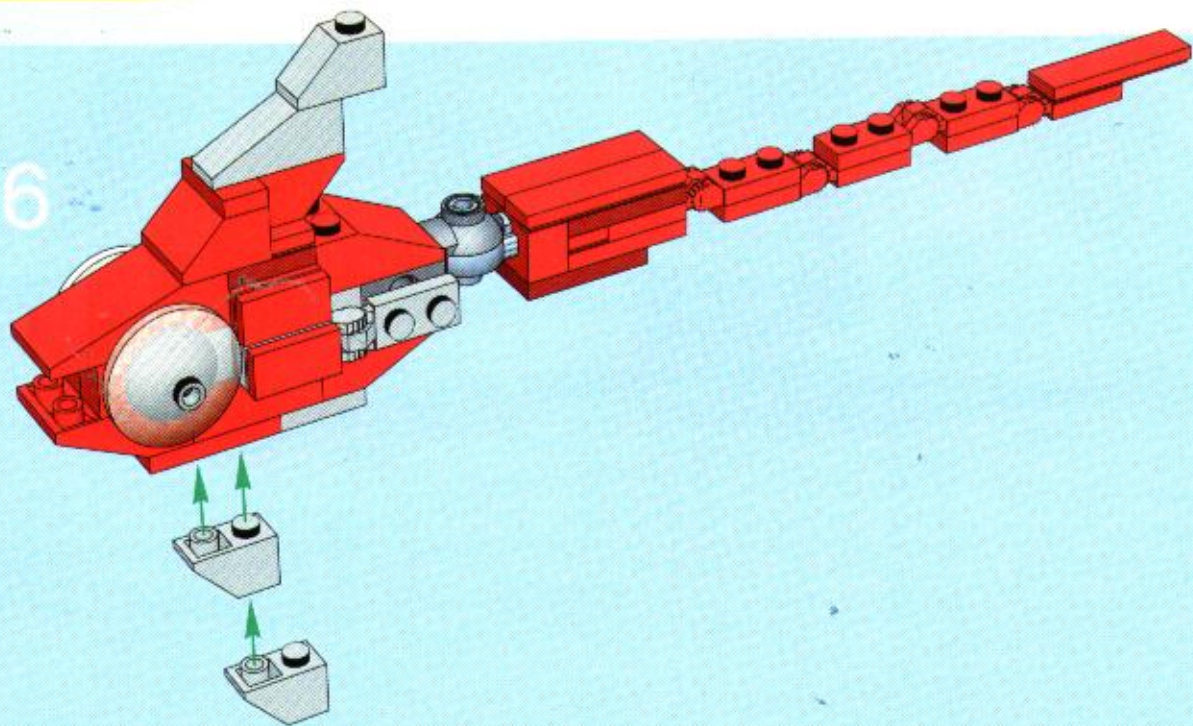

17

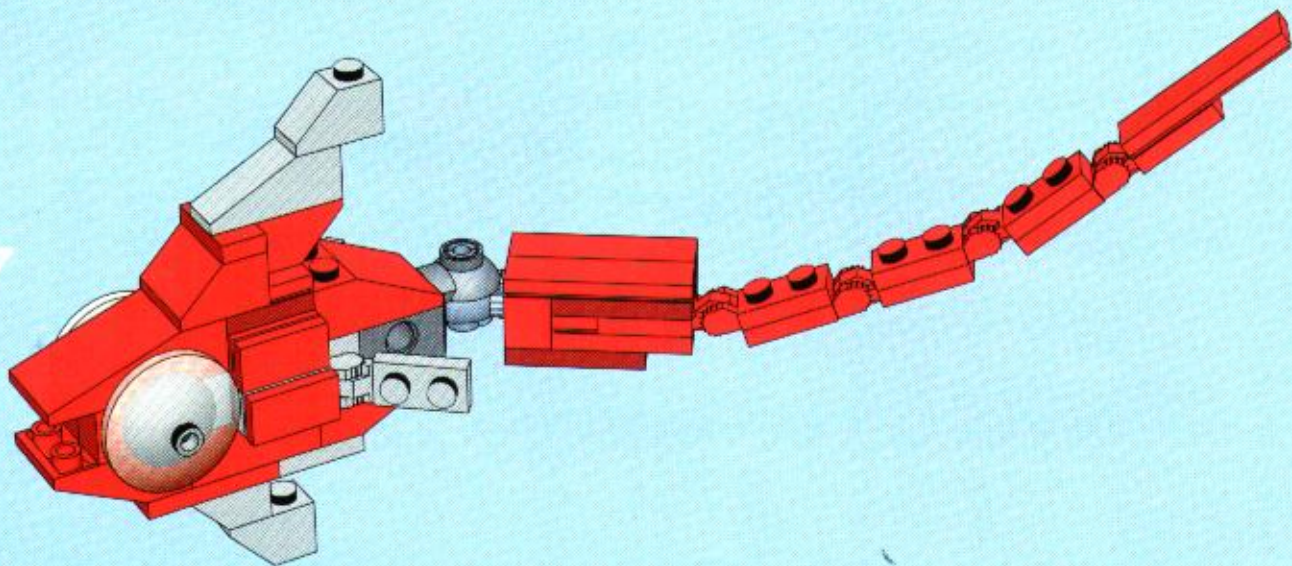

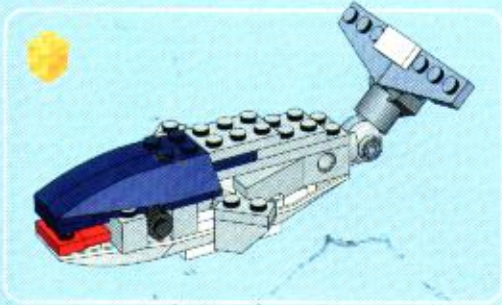

1

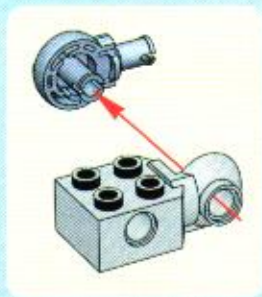
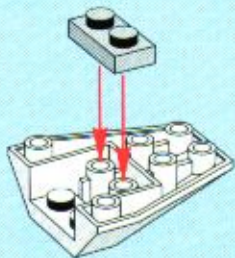

2

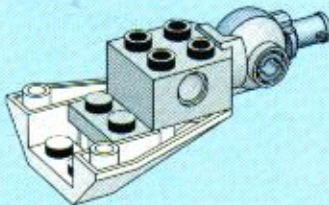

3

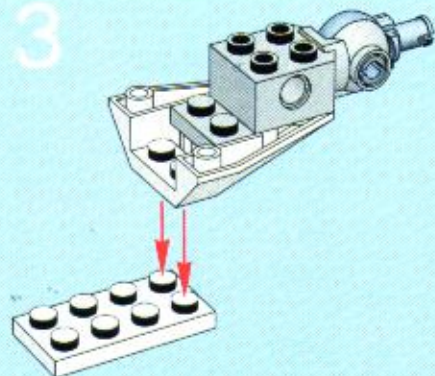

4

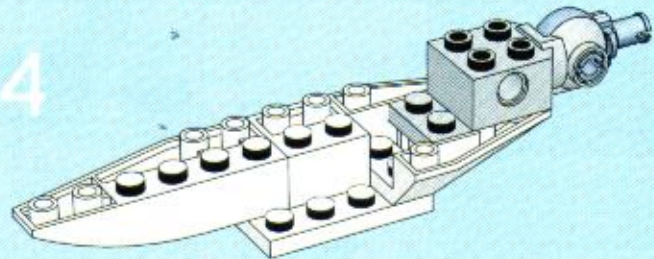

5

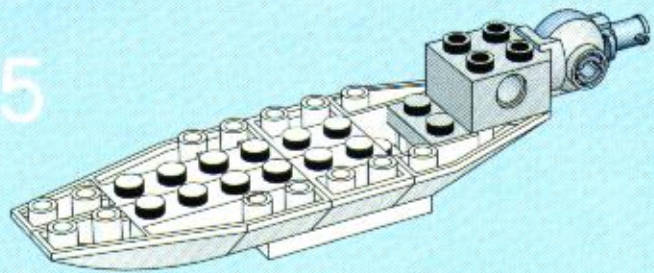

6

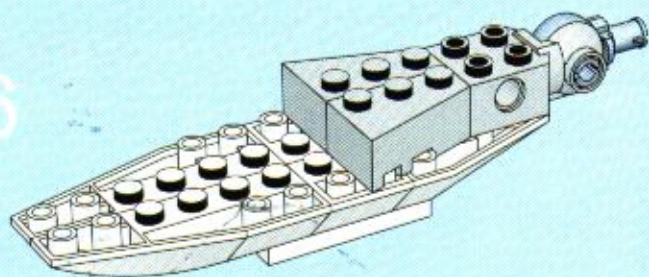

1

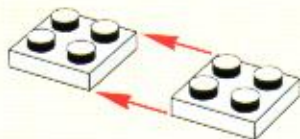

2

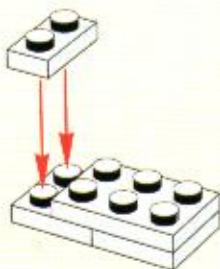

3

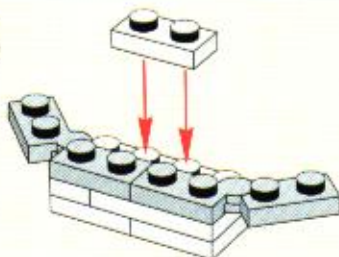

4

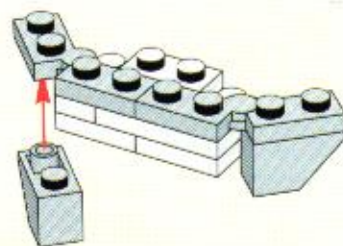

7

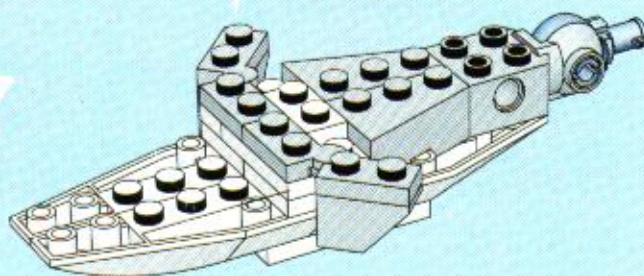

8

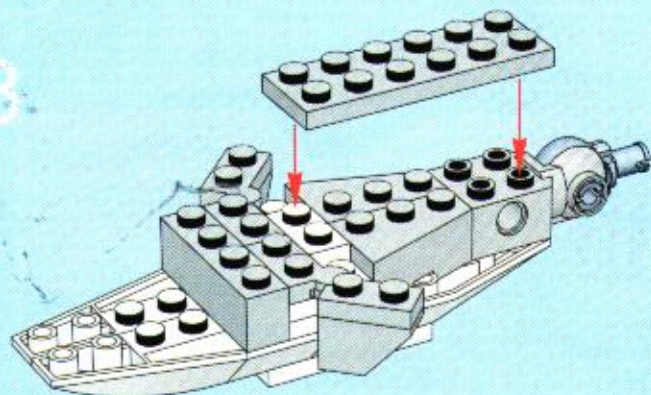

1



2

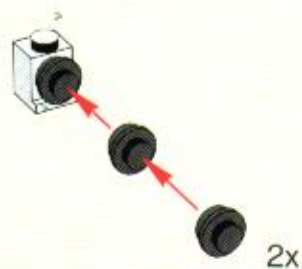

9

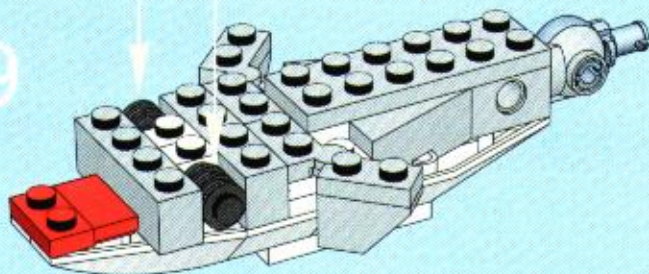

1



2

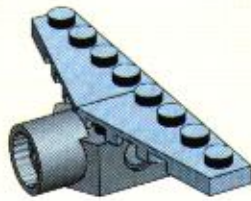

3

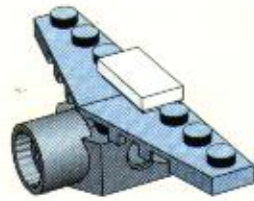

10

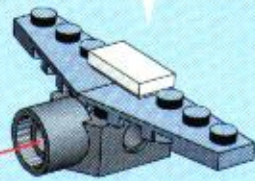
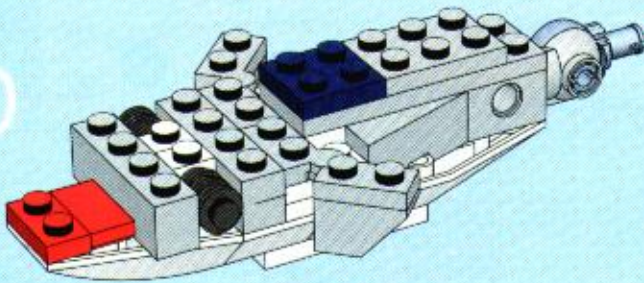

1

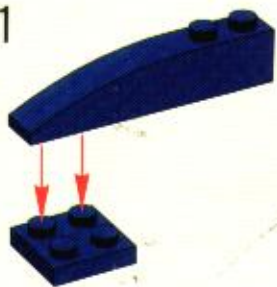

2



11

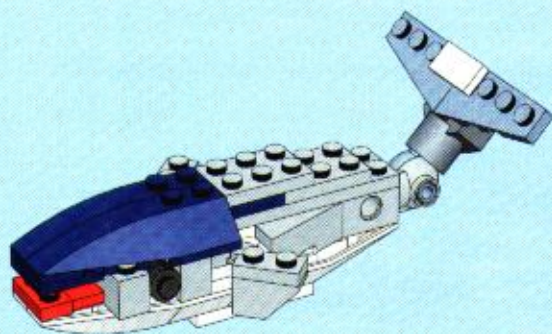
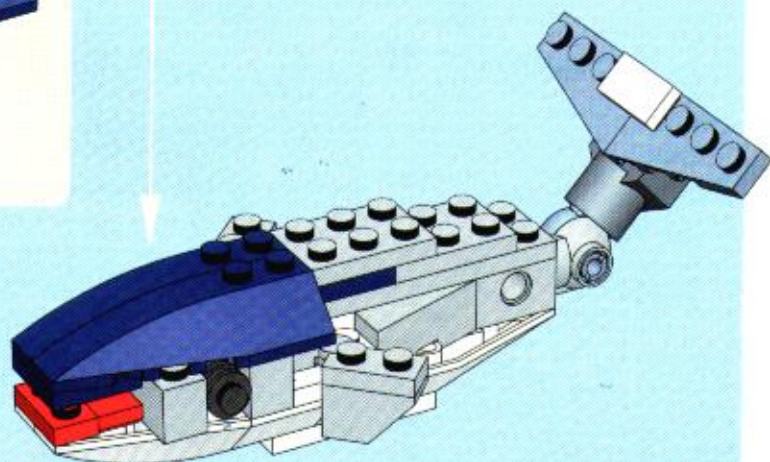

=



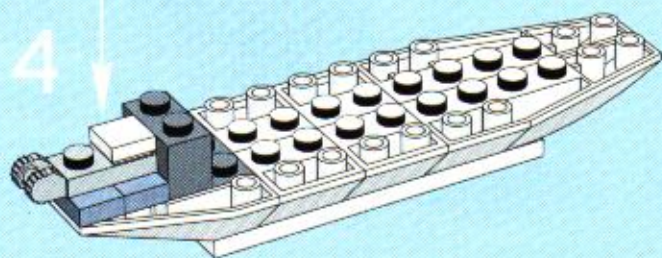
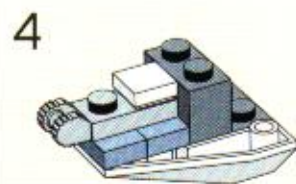
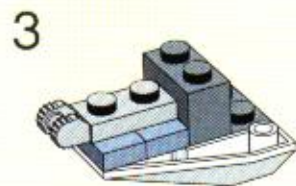
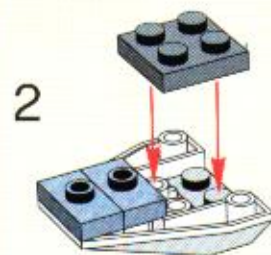
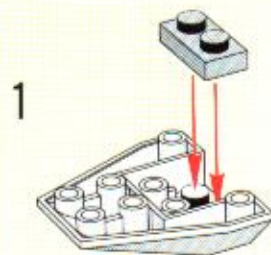
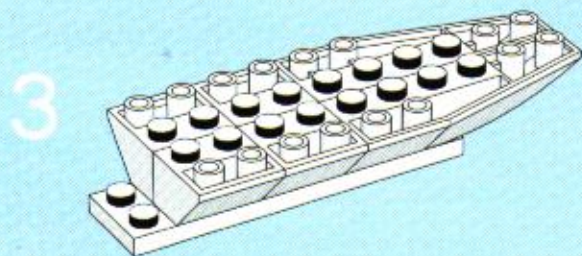
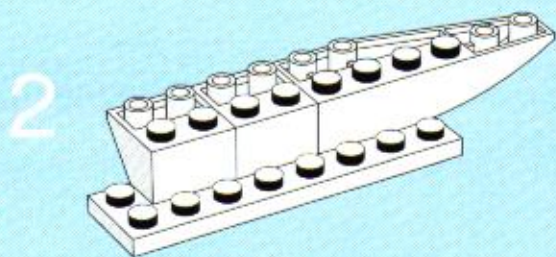
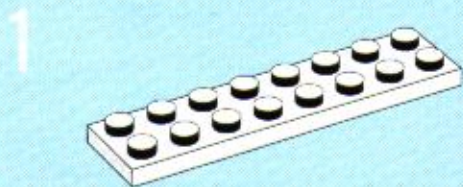
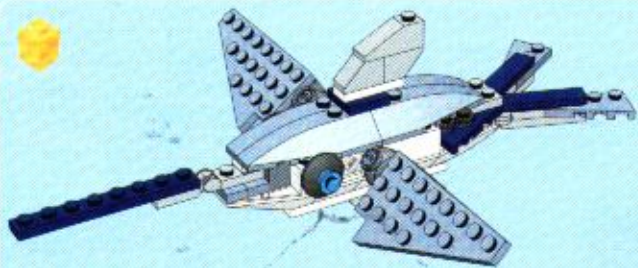

5

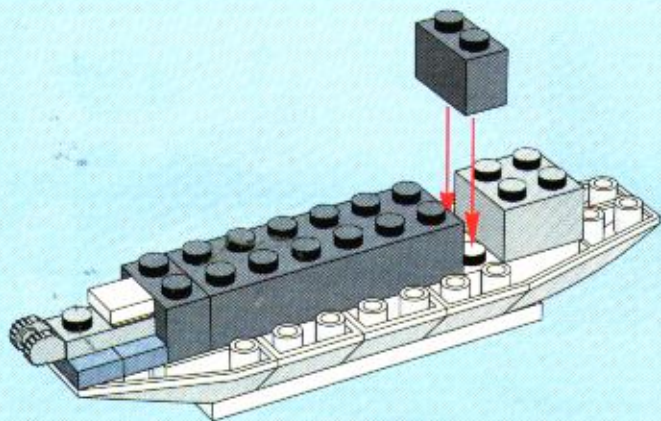

1

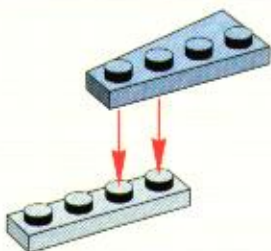

2

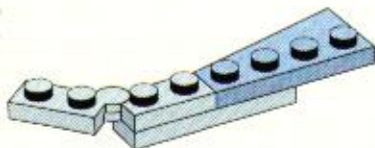

3



6

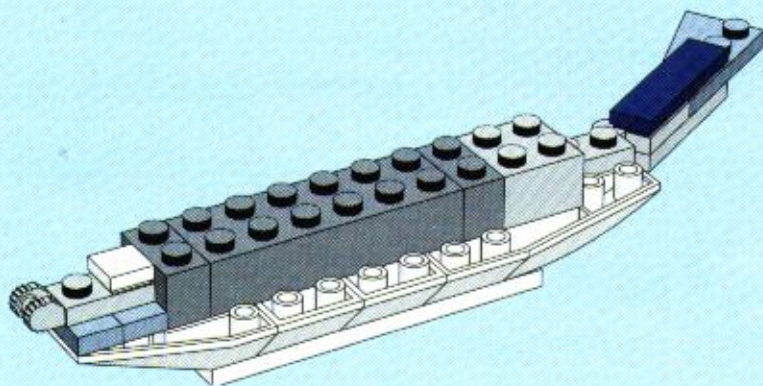

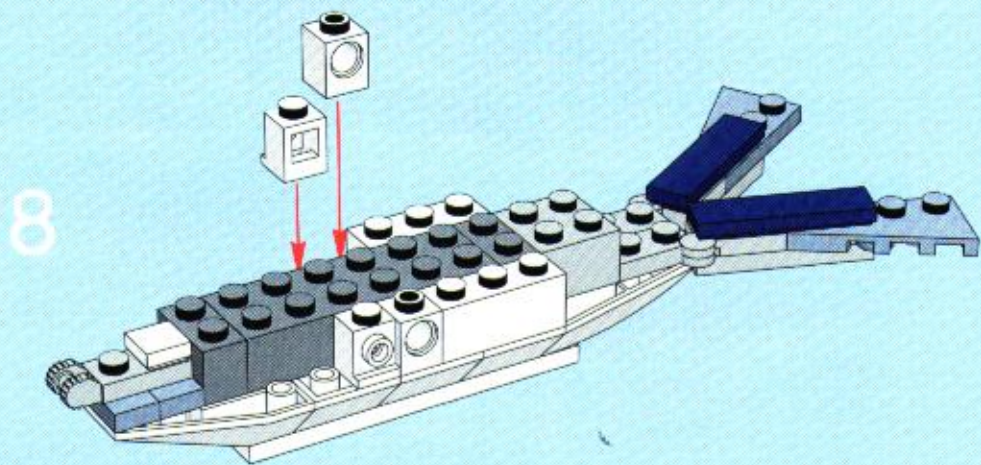
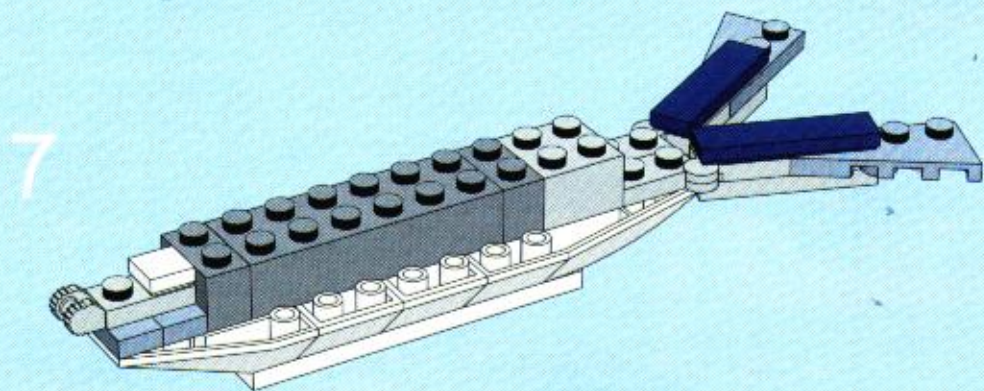
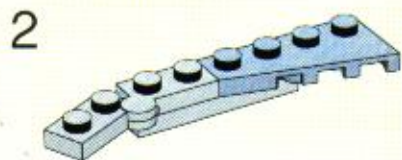
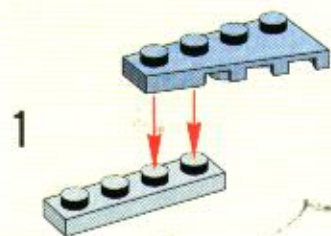

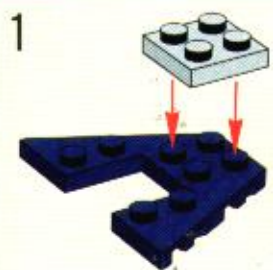

9

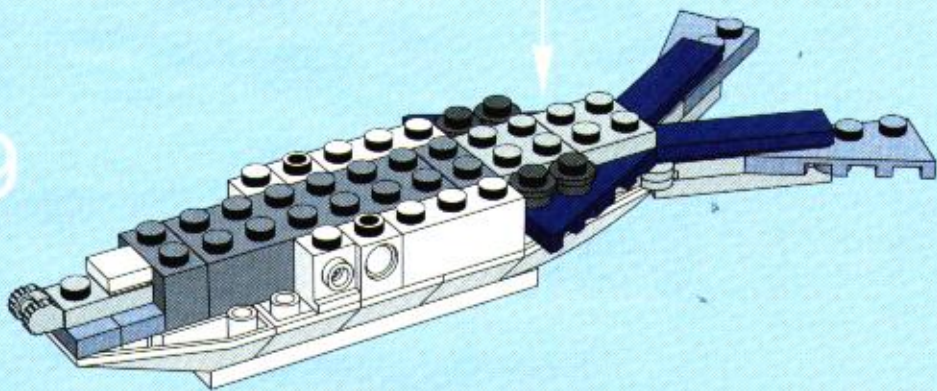

10

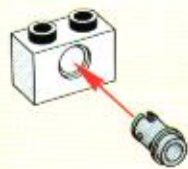

2x

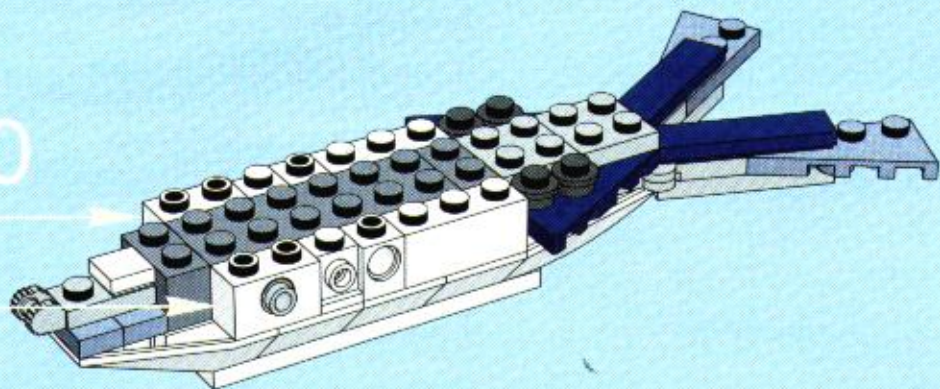



11

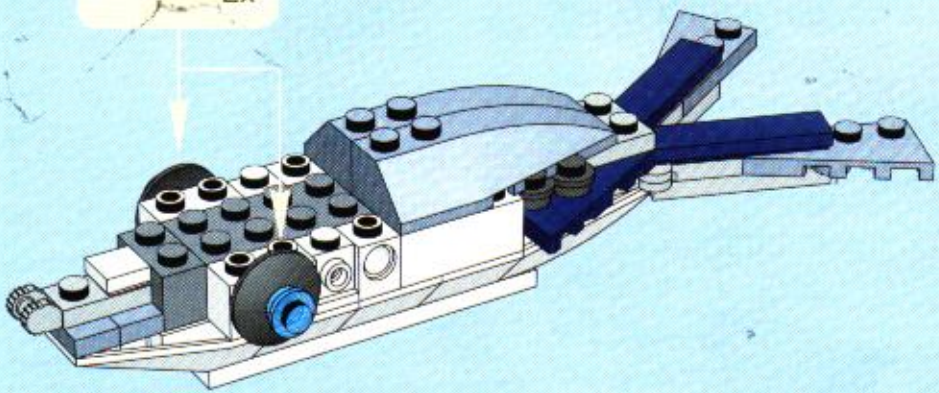

12

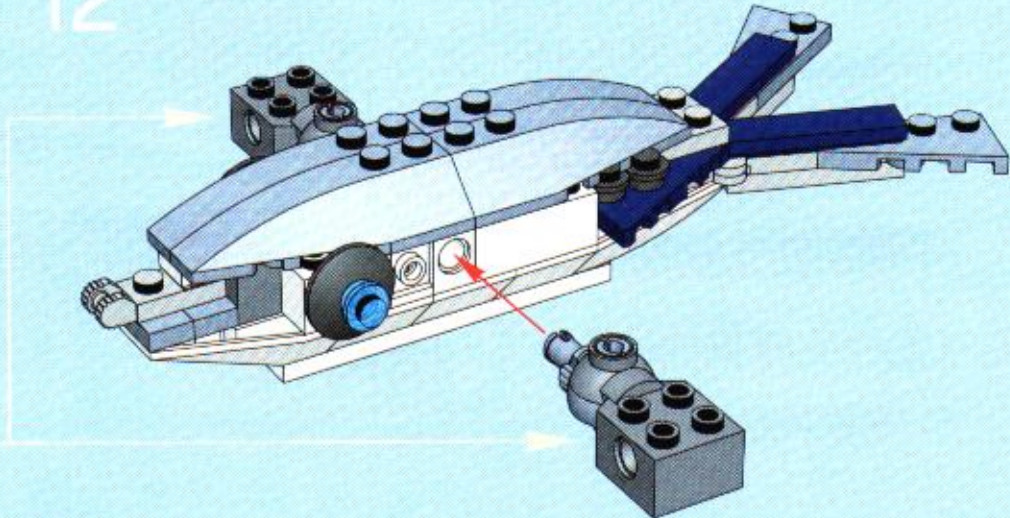
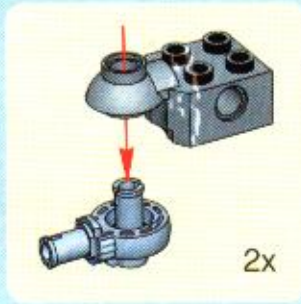

13

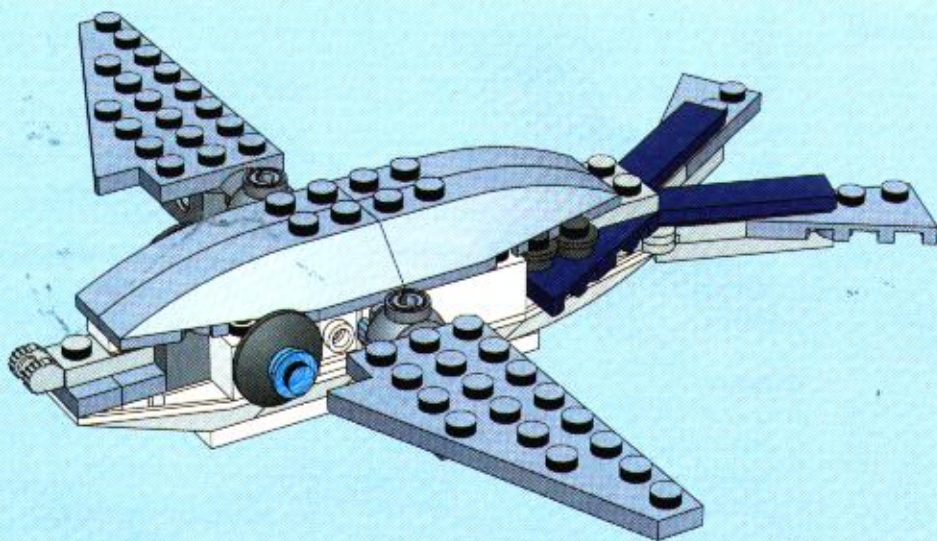

14

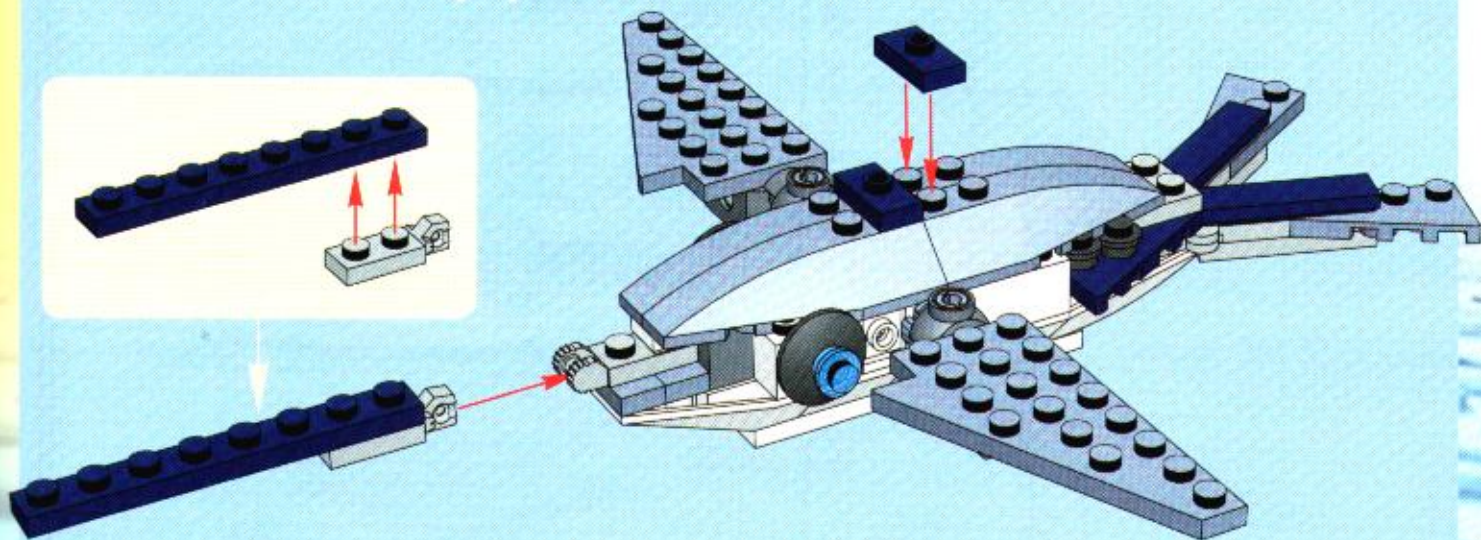

15

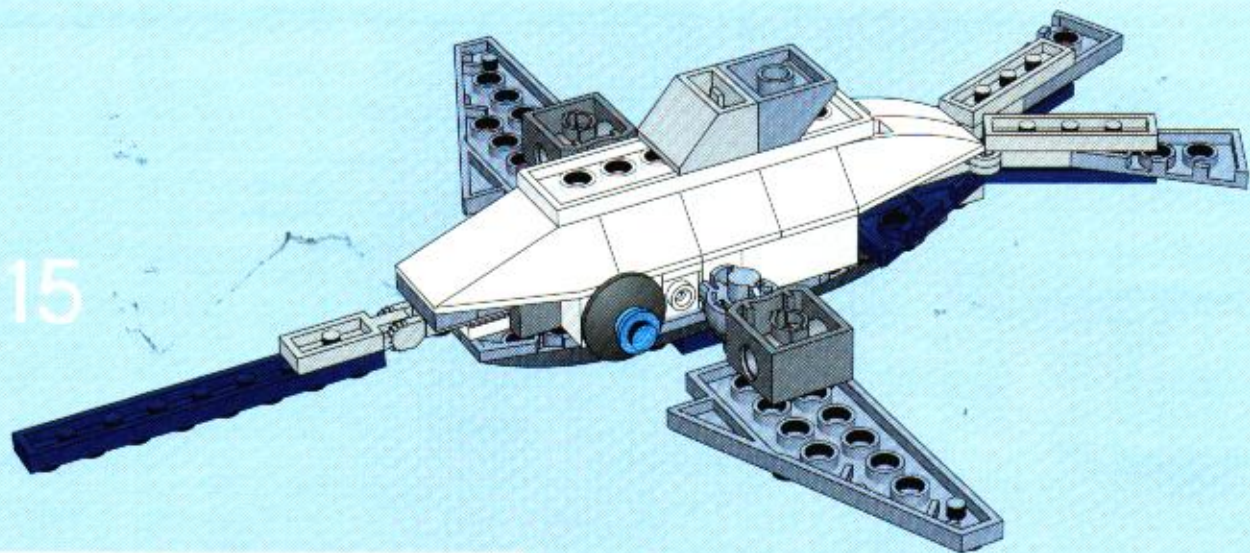

1

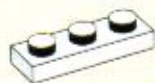

2

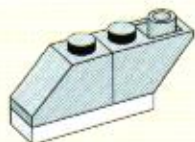

3

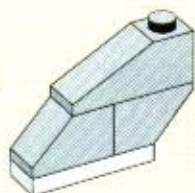

16

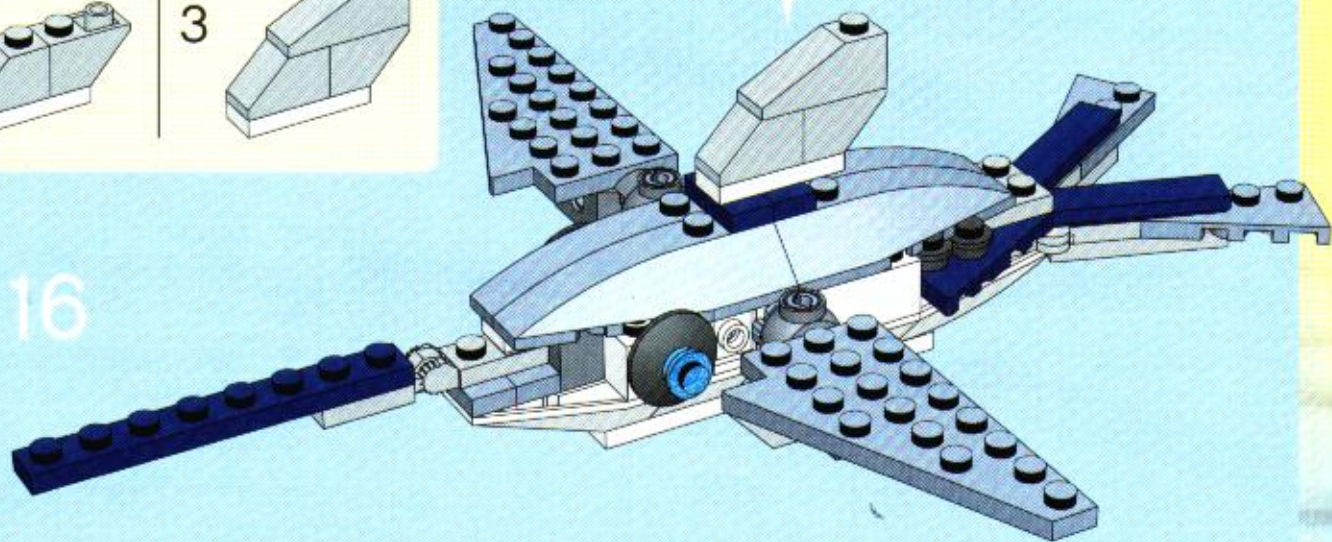

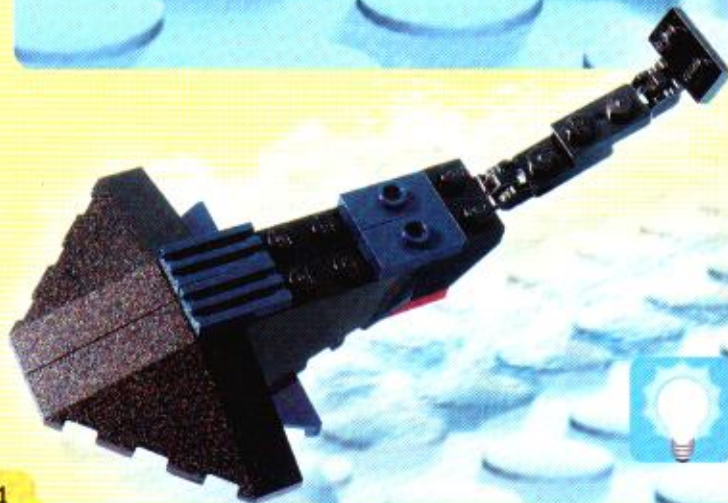
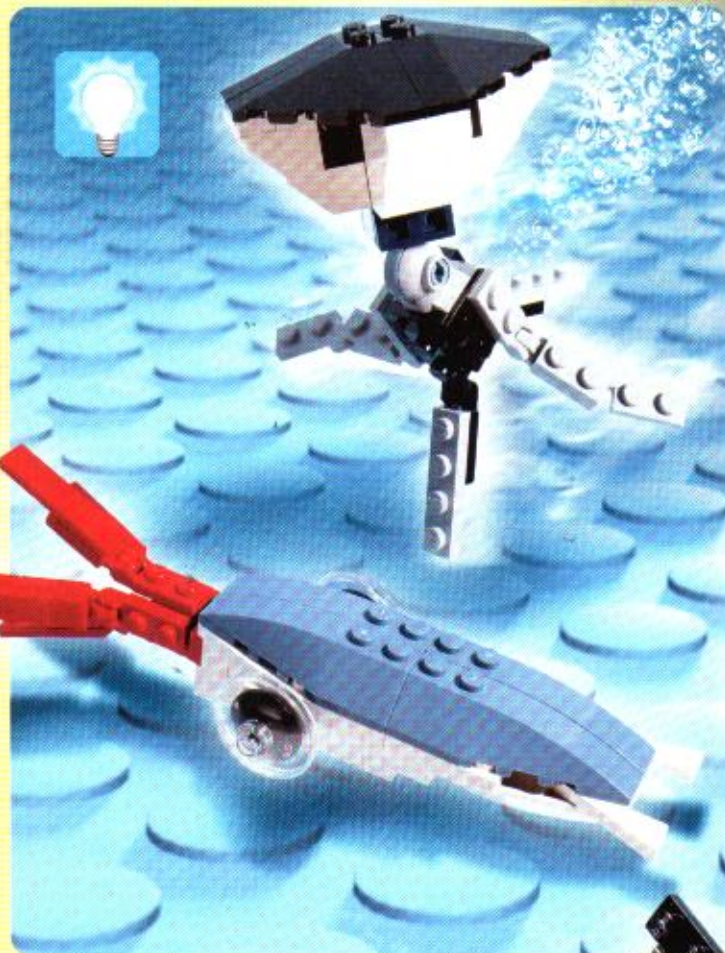

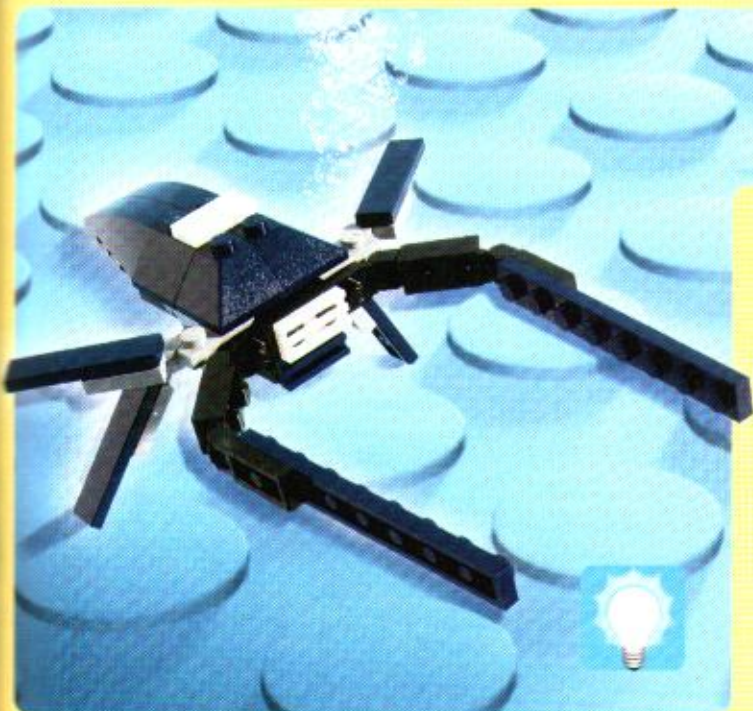

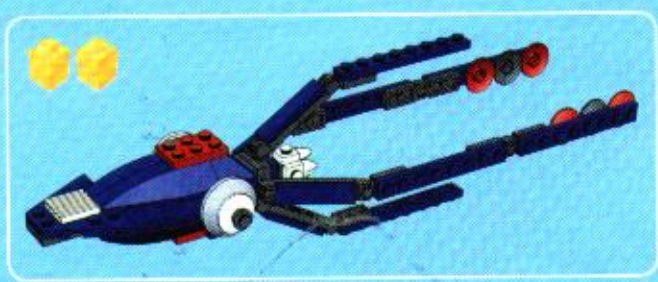

1



2

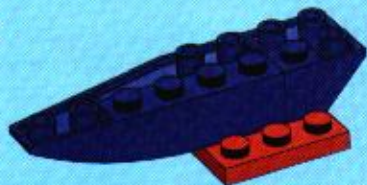

3



4



5

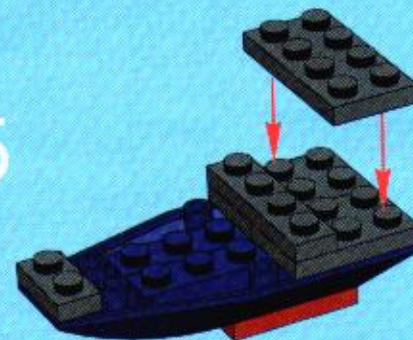

6

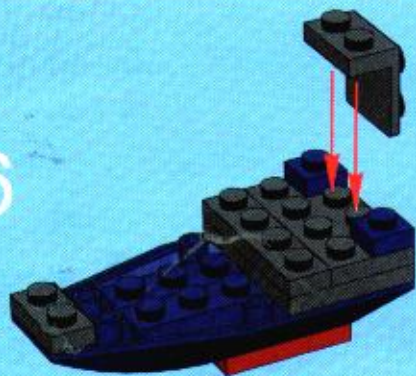

1



2



2x

7

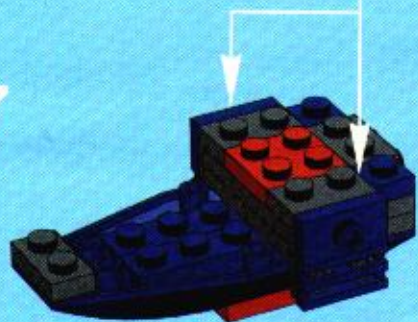

8



1



2



3



9



10

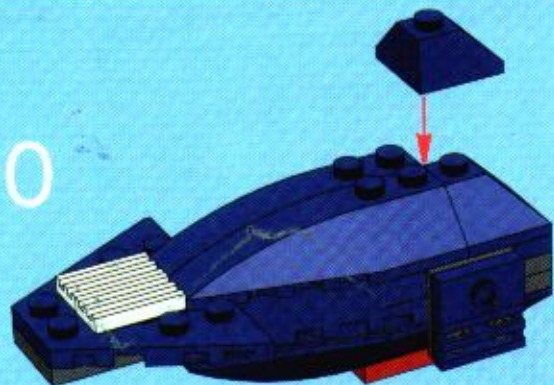

1



2

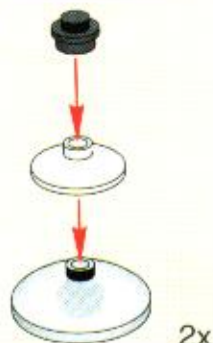

2x

11

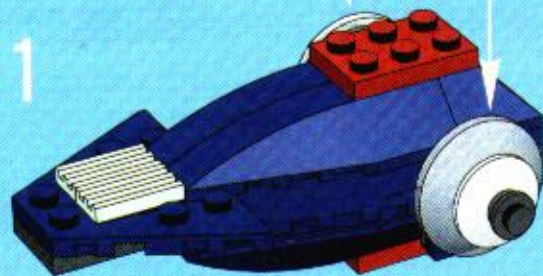

1



2



3



4



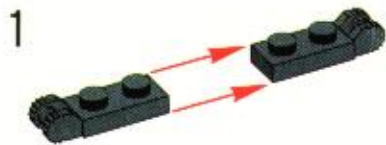

4x

5

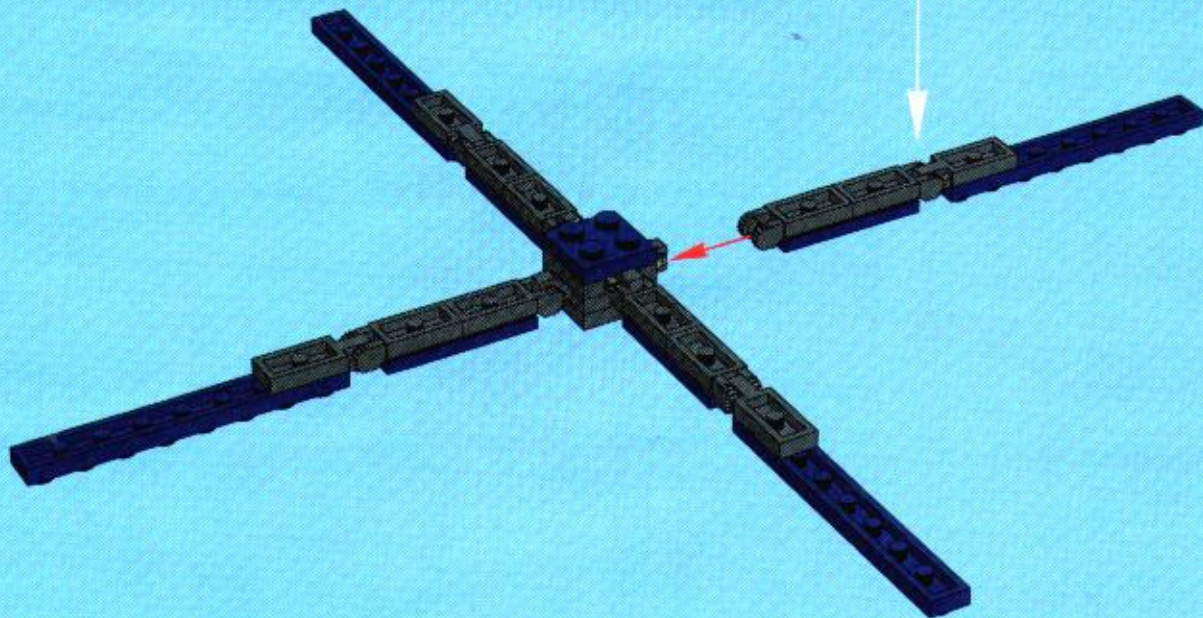

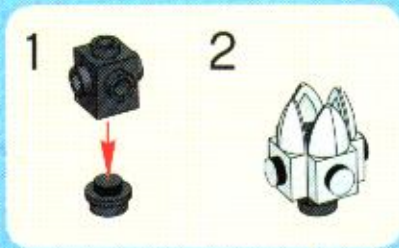

6

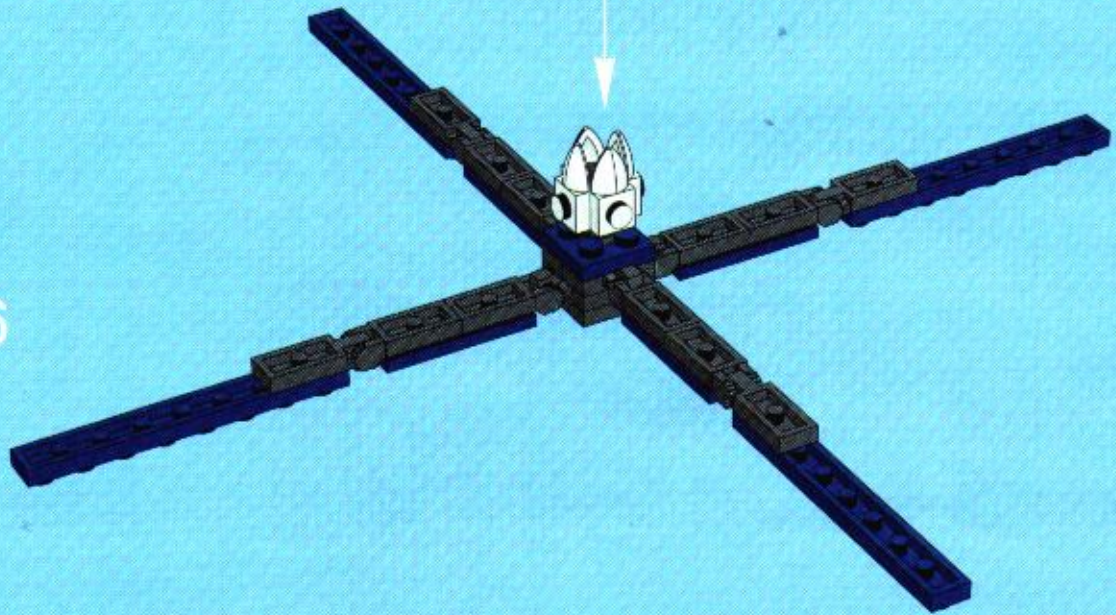

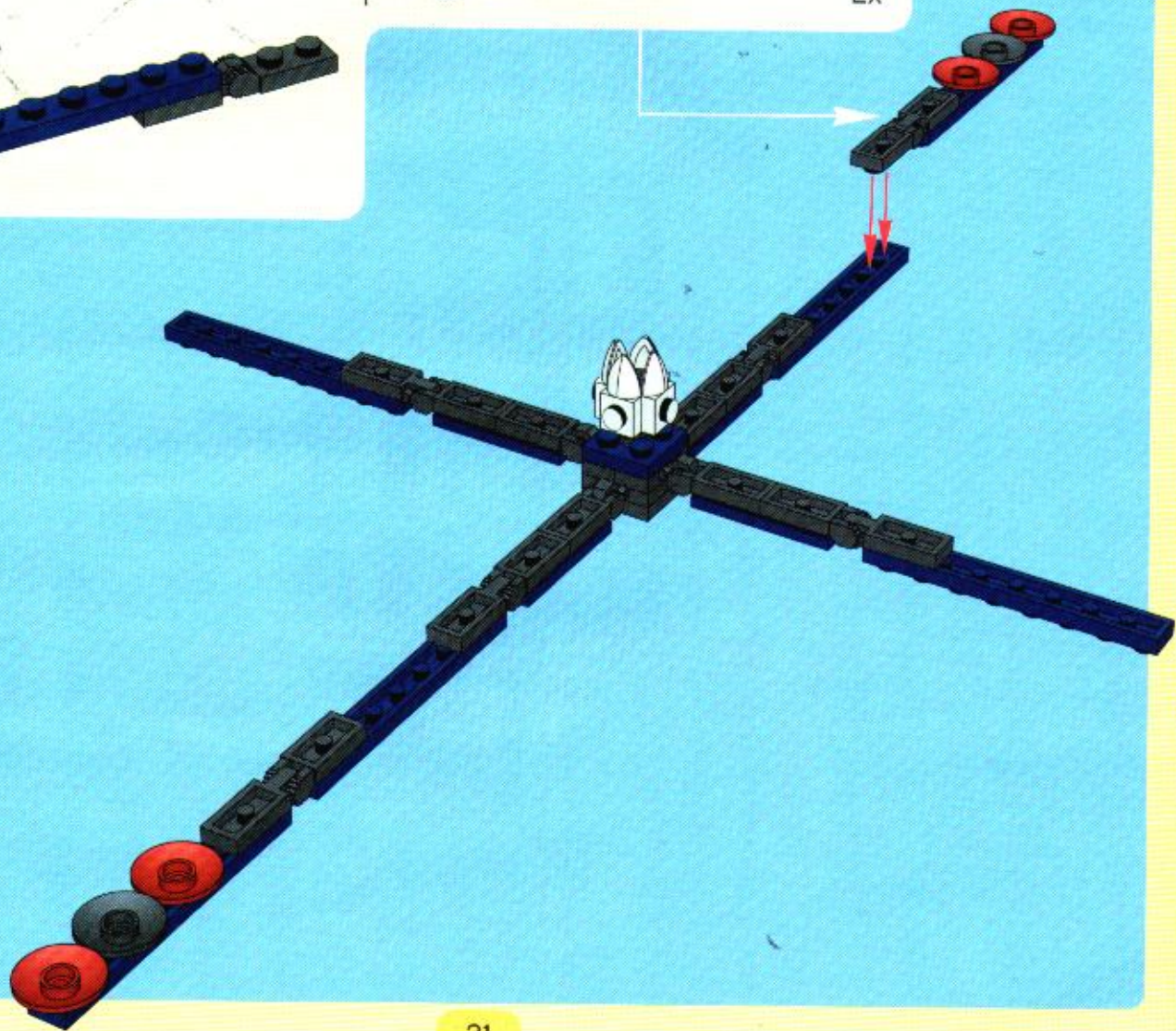
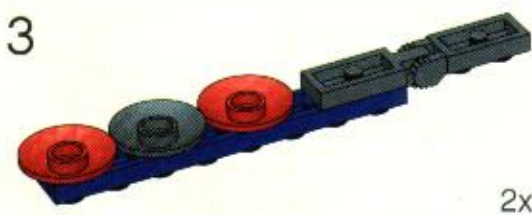

8

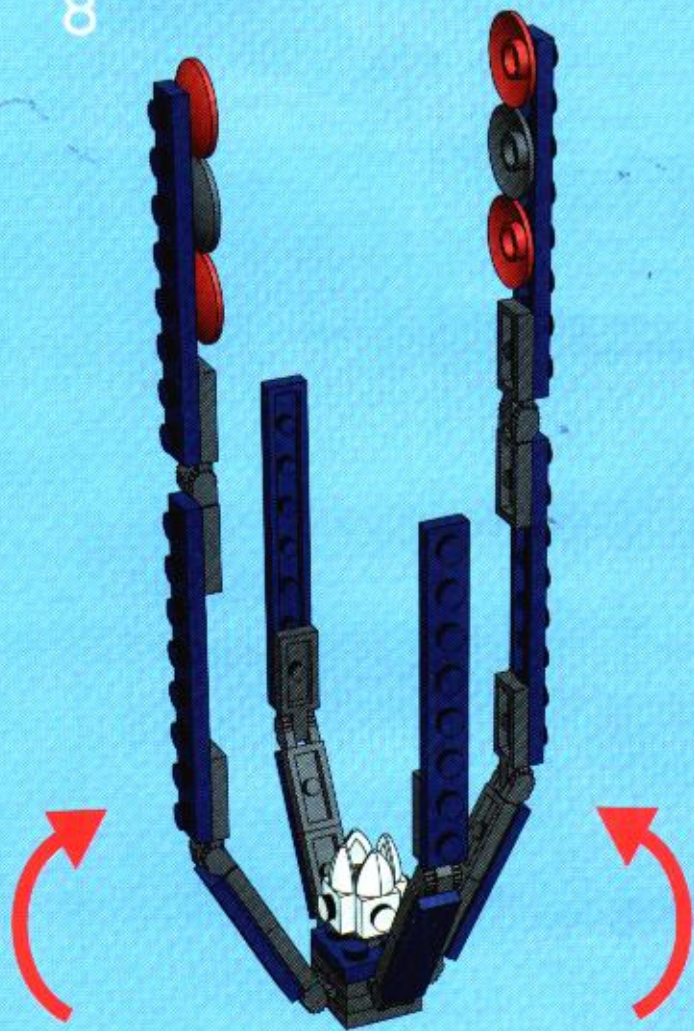

12

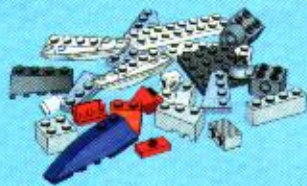
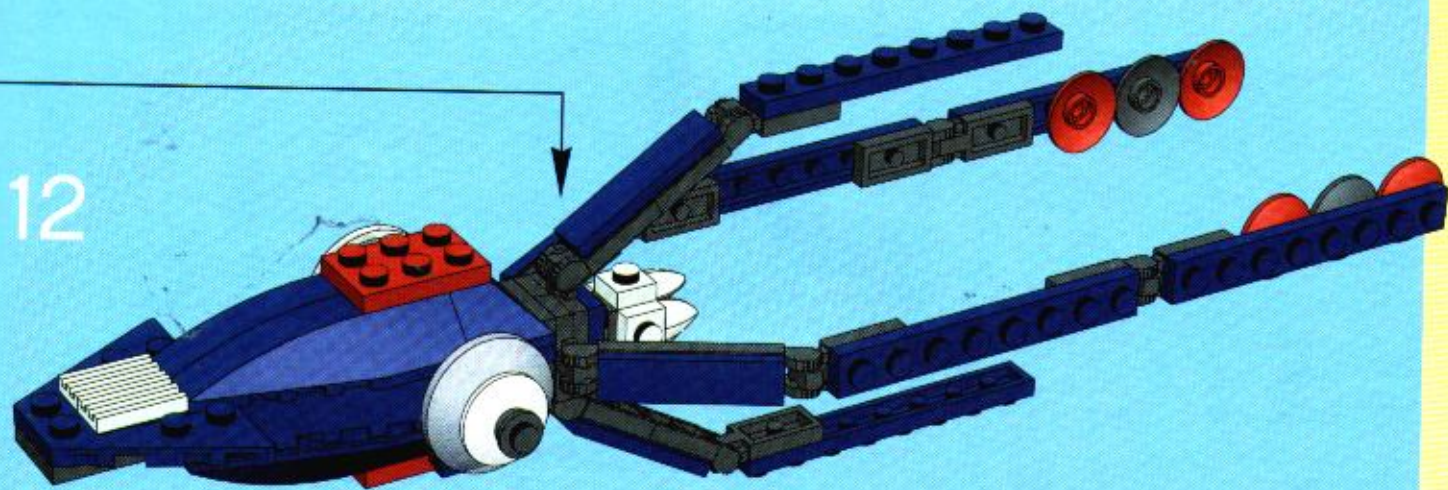

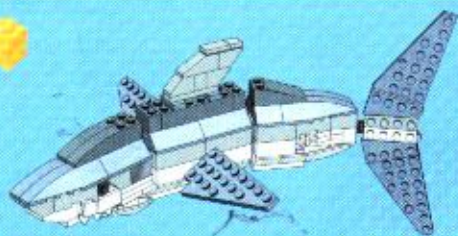

1

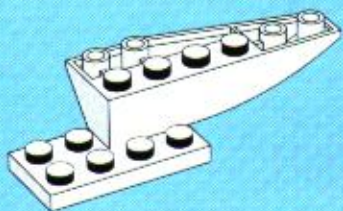

2

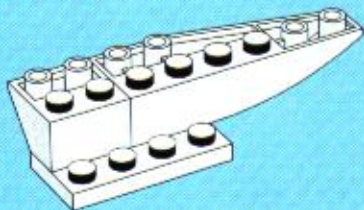

3

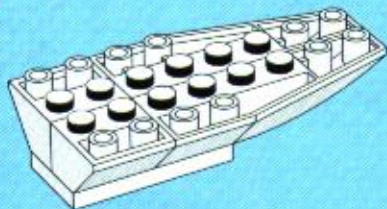

4

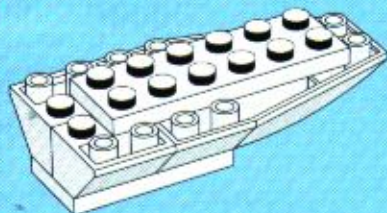

5

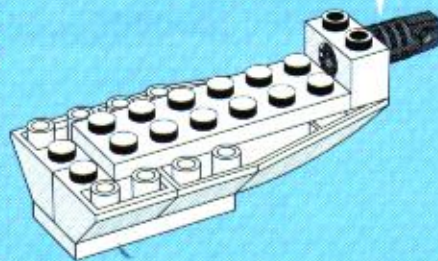

6

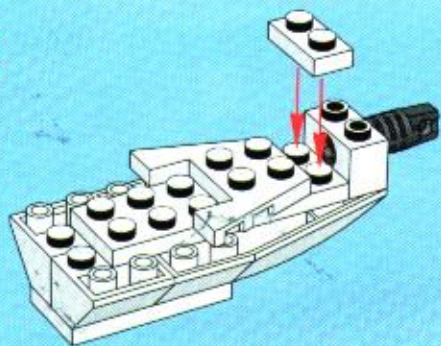

7

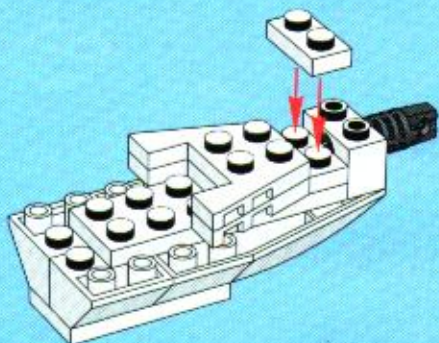

8

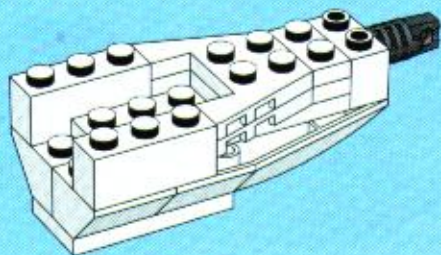

9

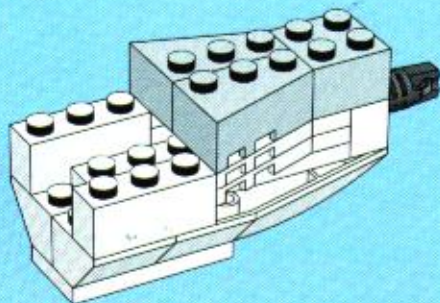

1

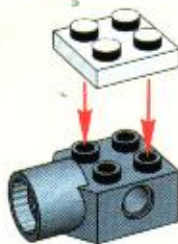

2



10

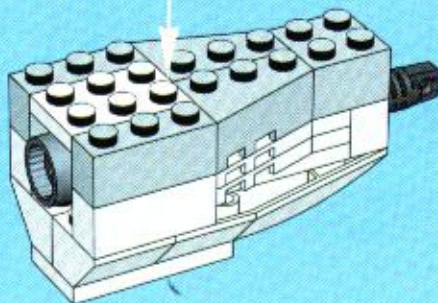

11

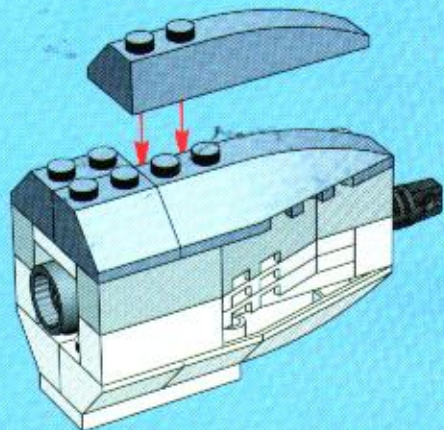

12

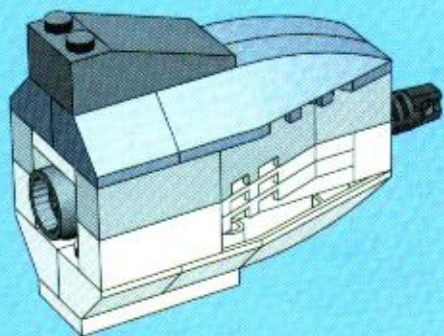

1



2

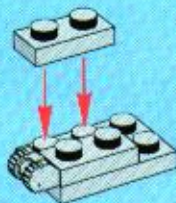

3

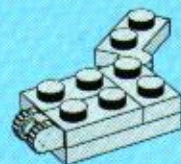

4

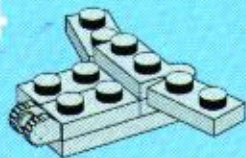

5

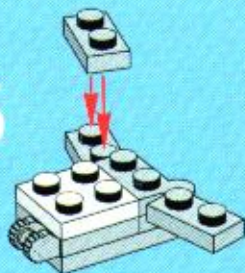

6

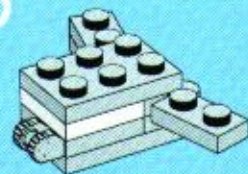

7

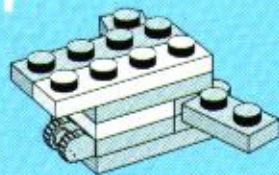

1

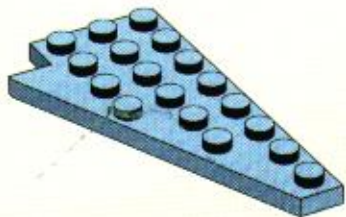

2

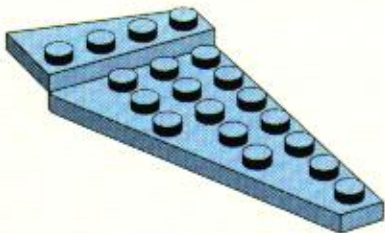

8

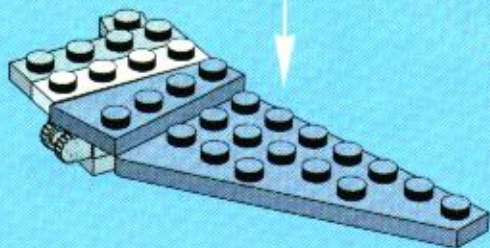

1

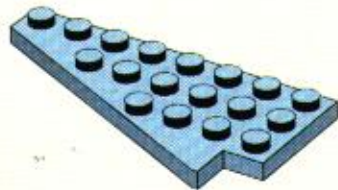

2

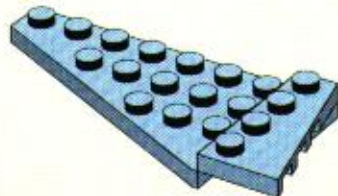

9

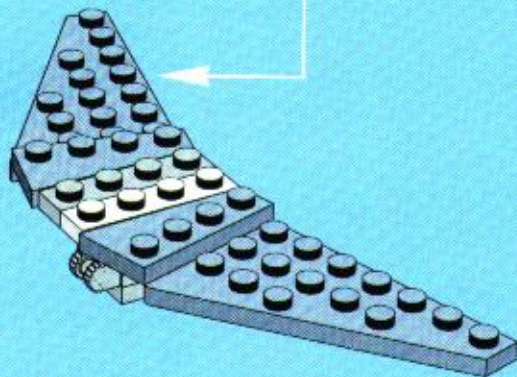

10

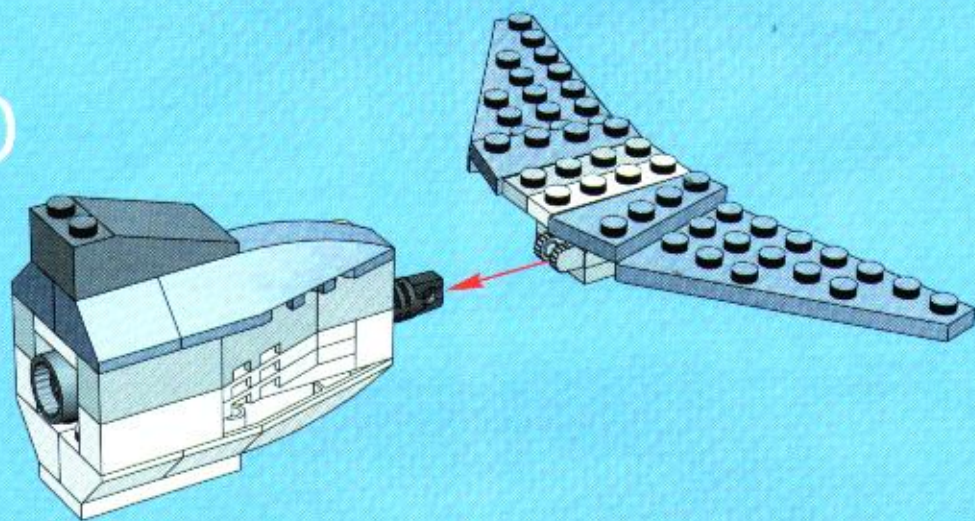

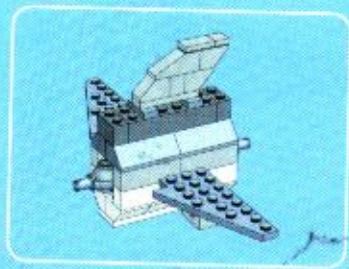

1

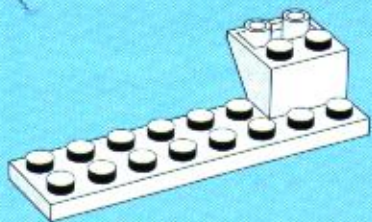

2

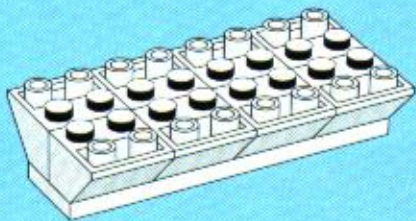

3

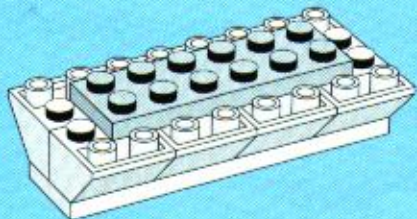

4

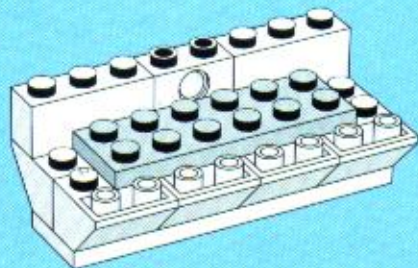

5

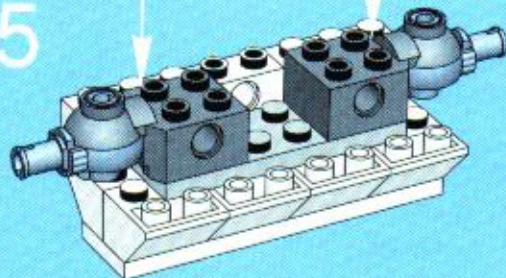

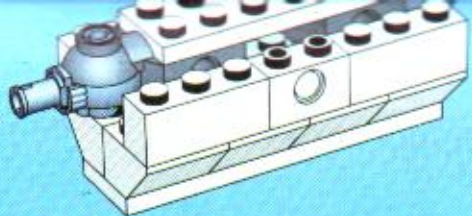

7

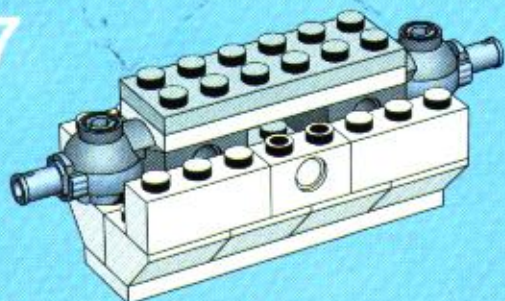

8

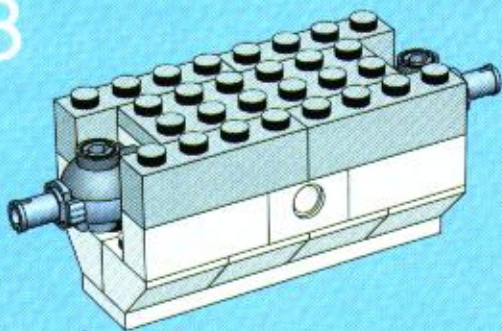

9

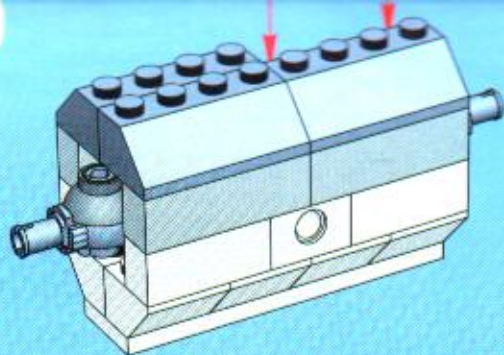

1



2

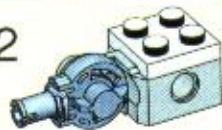

2x

10

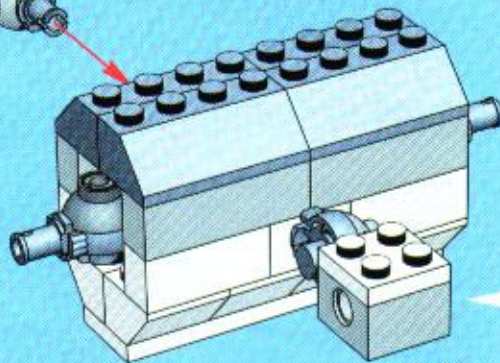

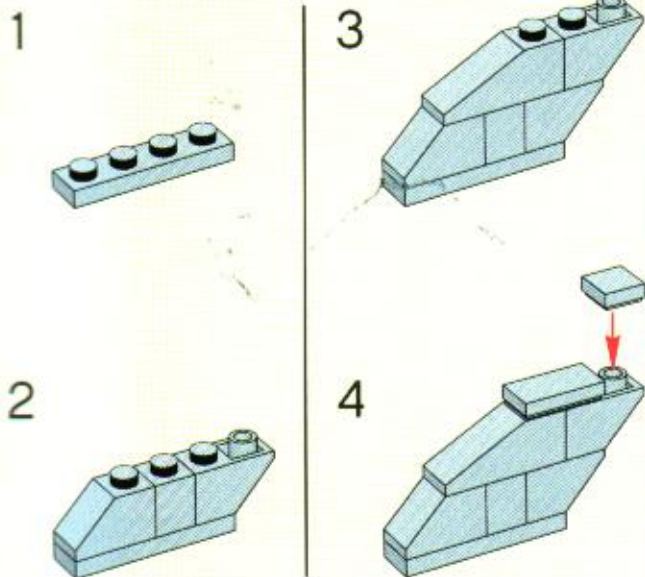

14

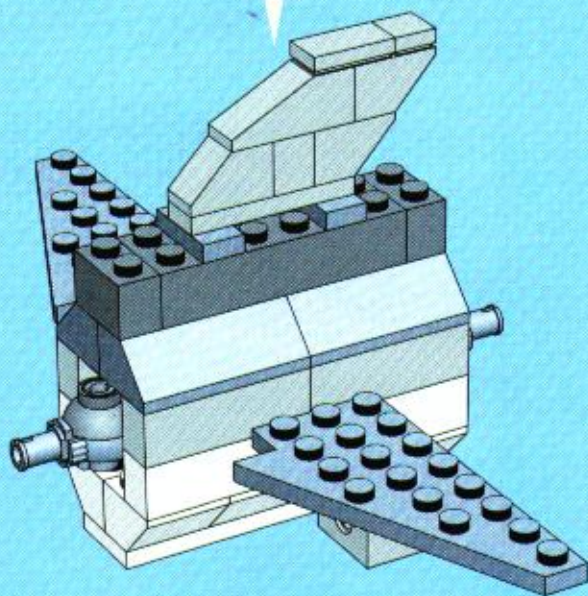

15

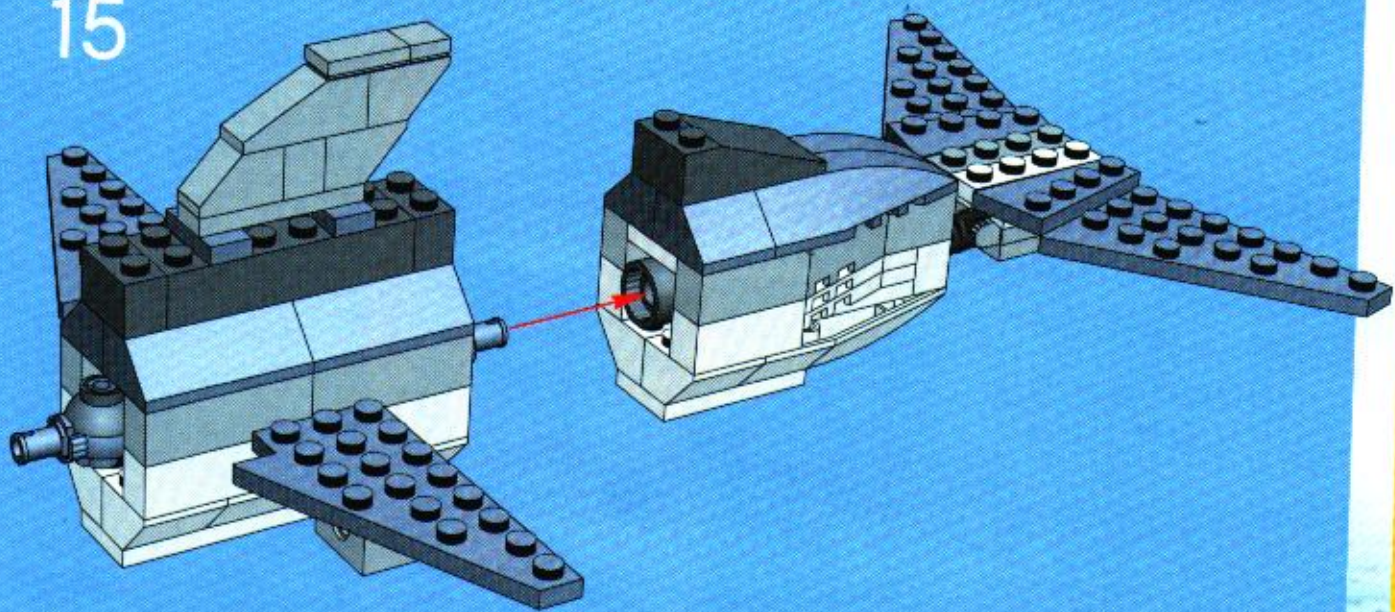

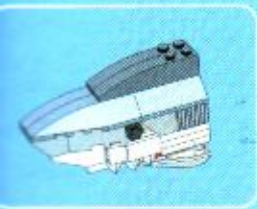

1

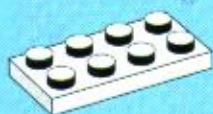

2

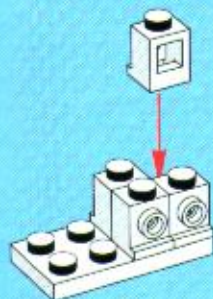

3

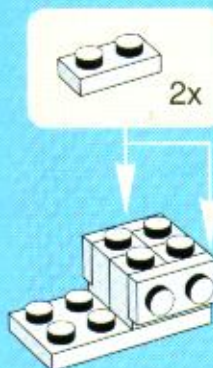

4

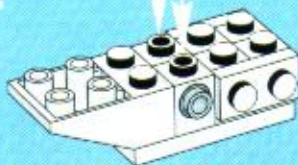

1



2



5

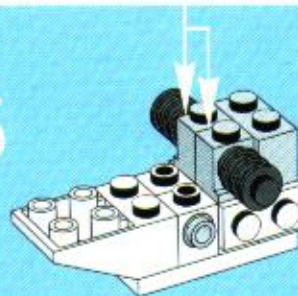

6

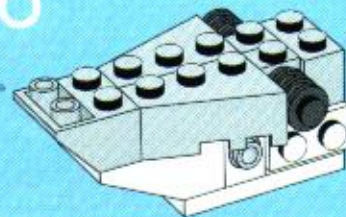

7

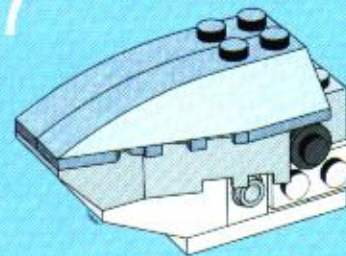

1

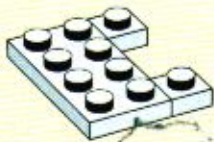

2

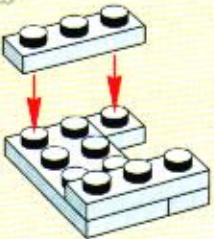

3

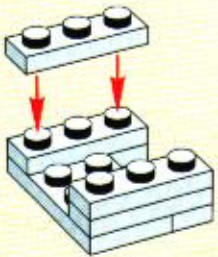

4



5

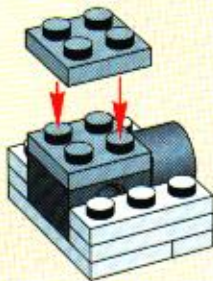

6

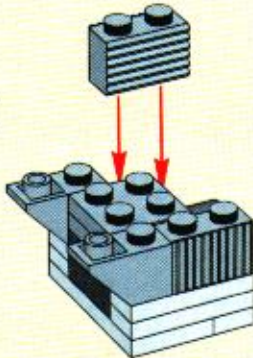

7

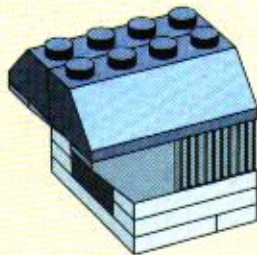

8

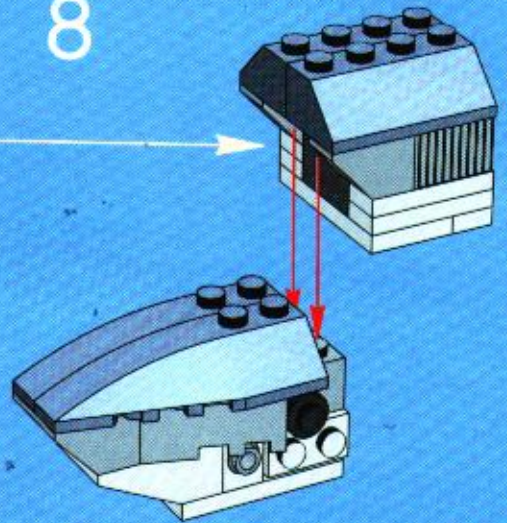

9

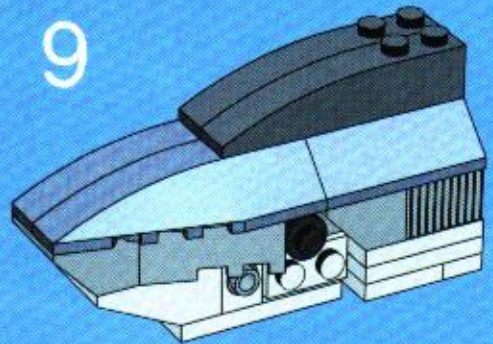

10

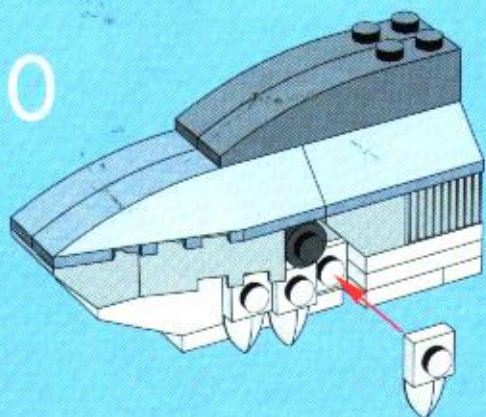

12

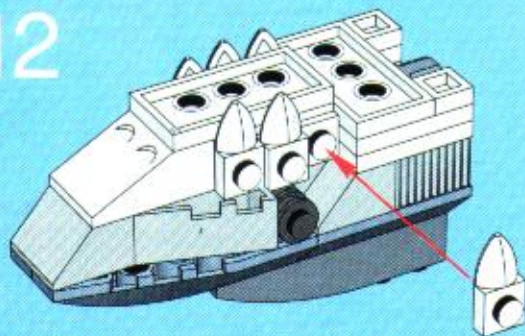

11

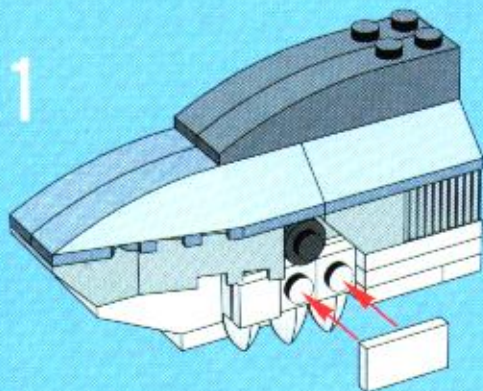

13

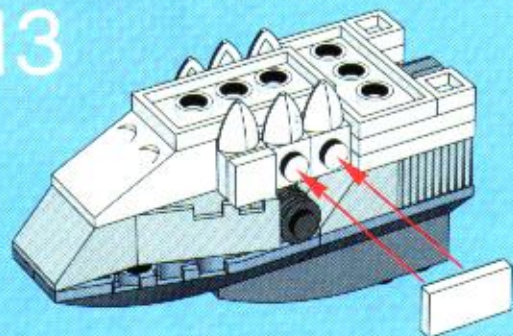

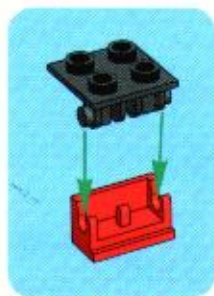
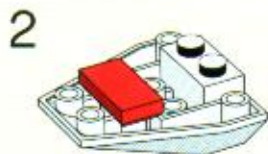
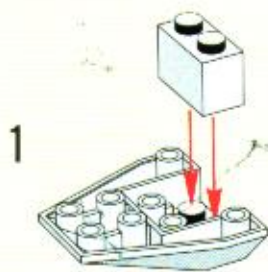

14

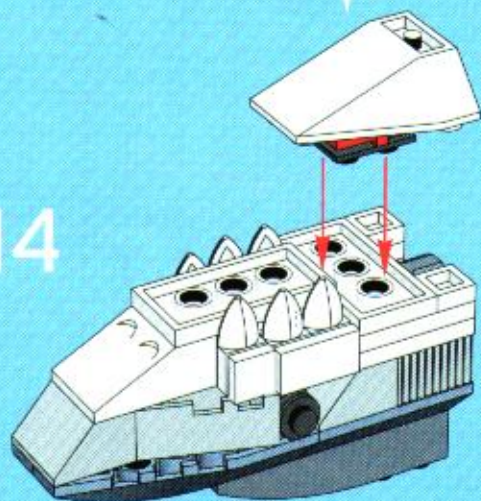

15

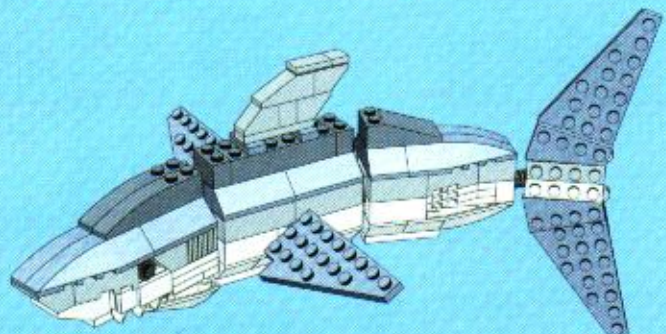
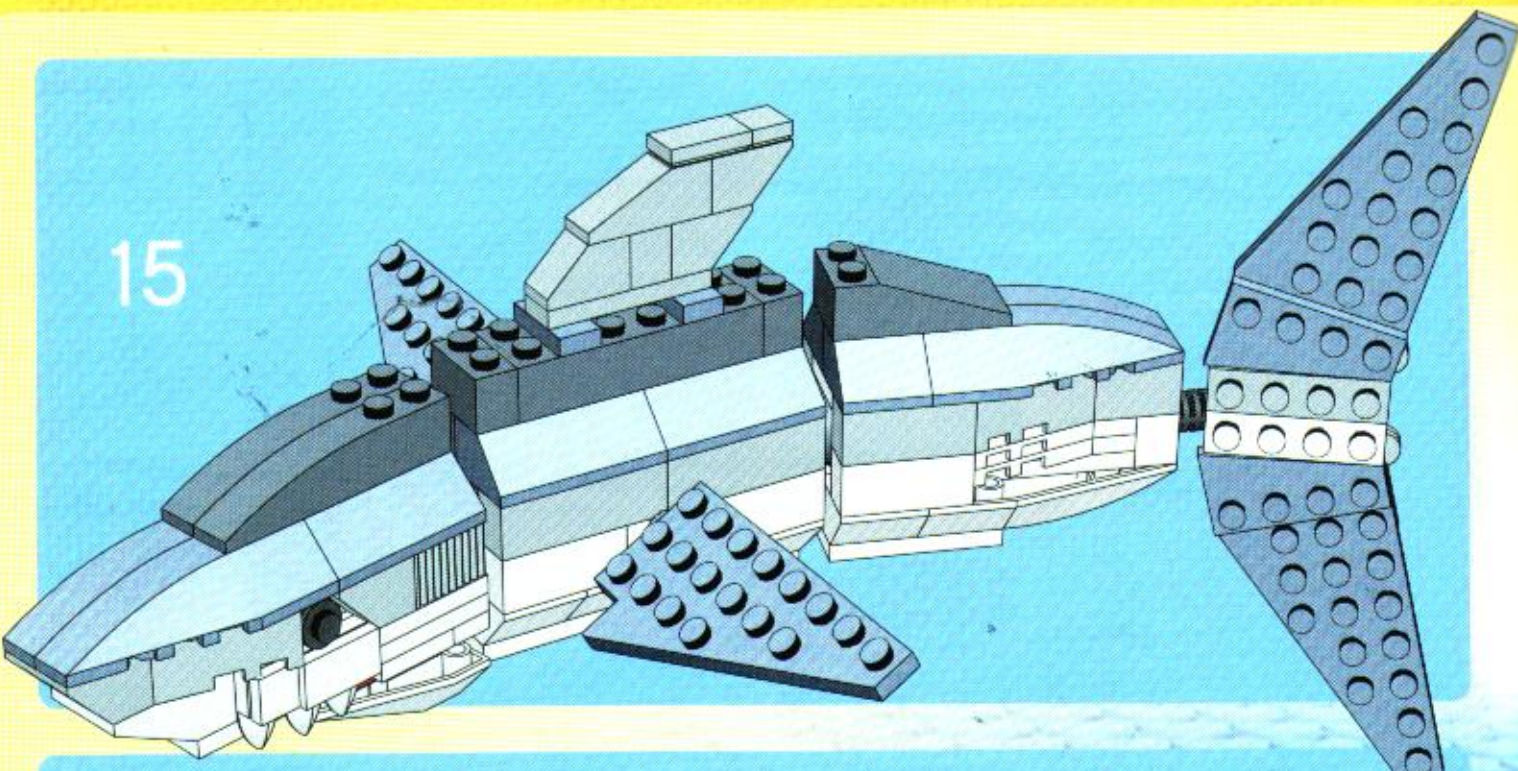

=



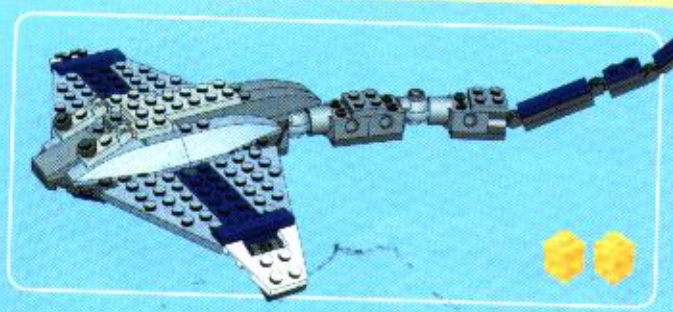

1

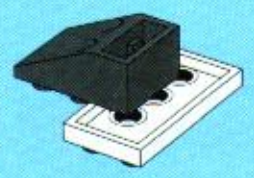

2

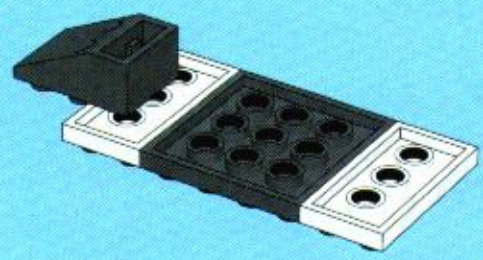

3

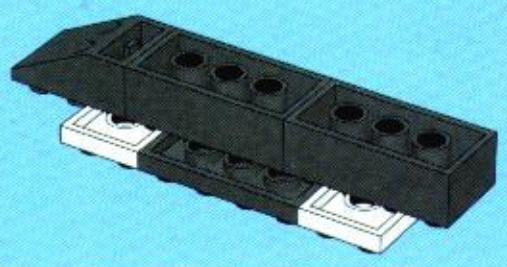

4

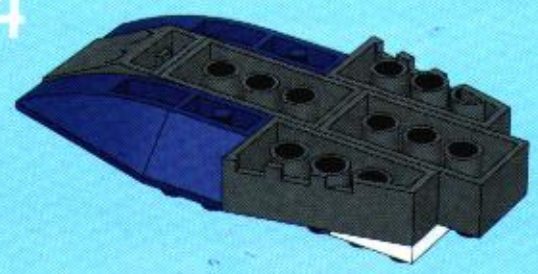

5

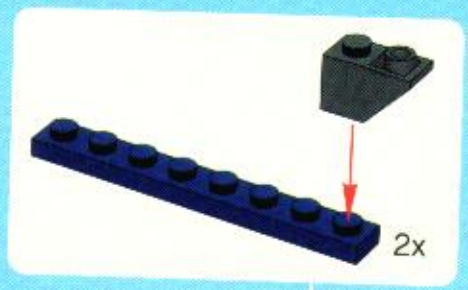
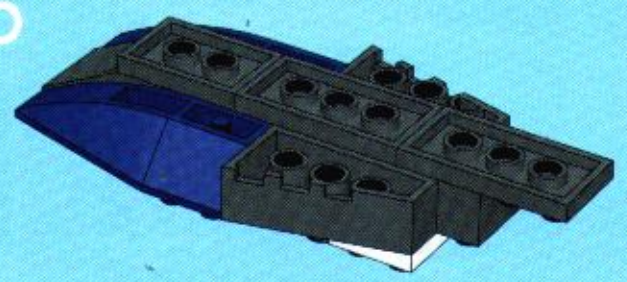

6

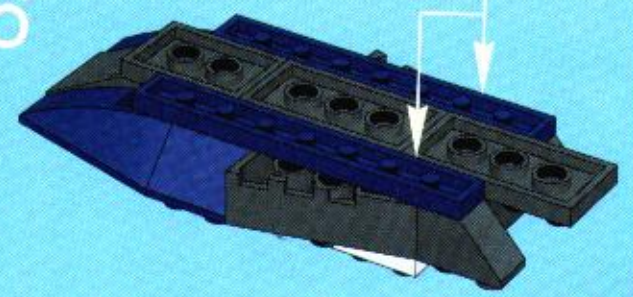

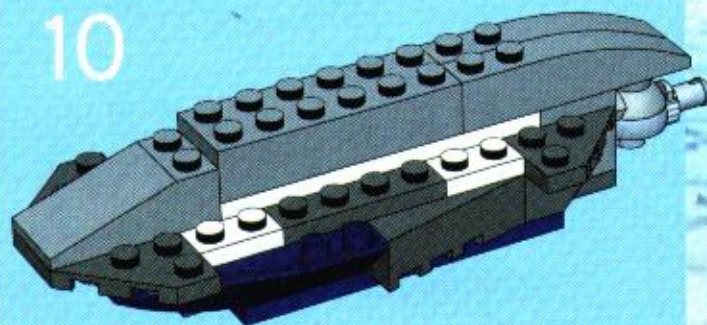
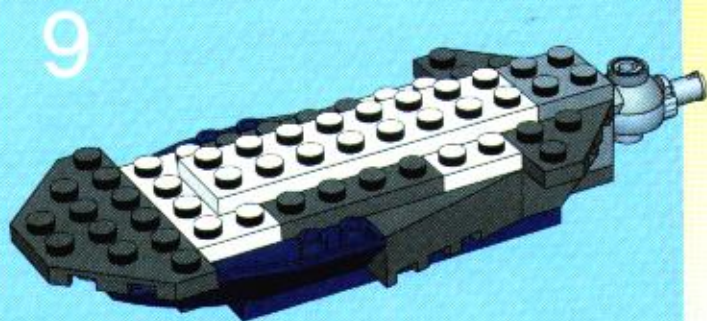
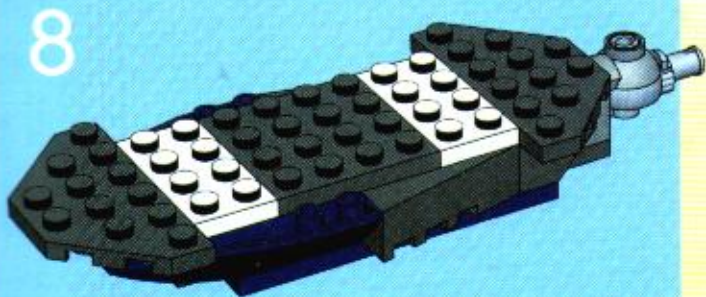
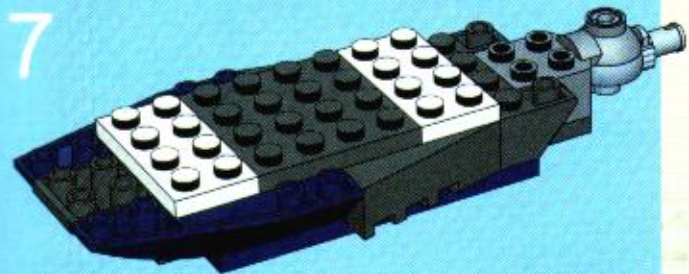
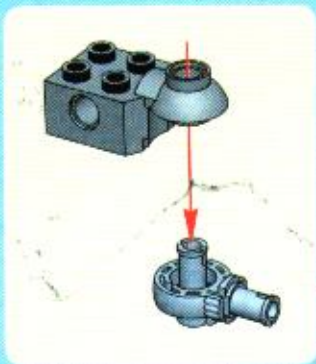

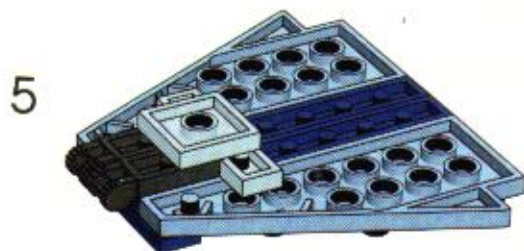
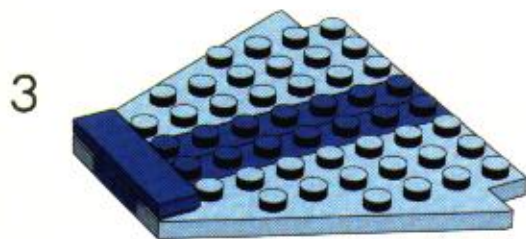

2x

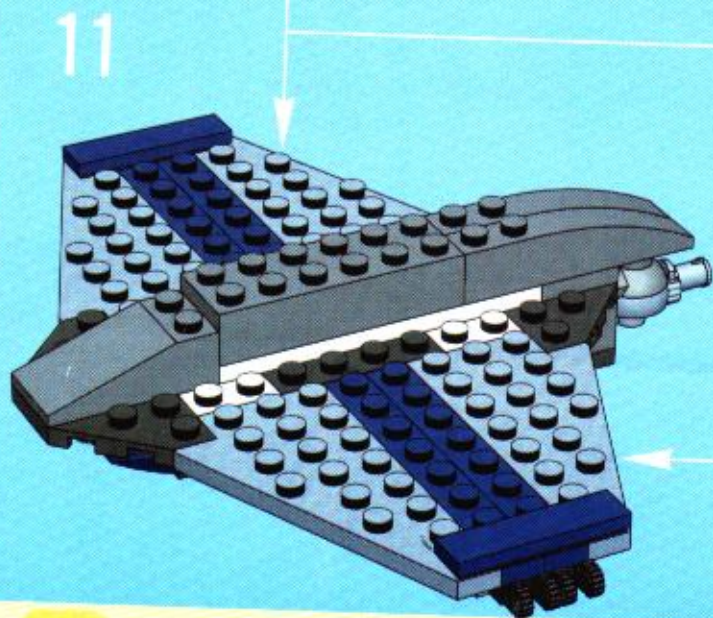

12

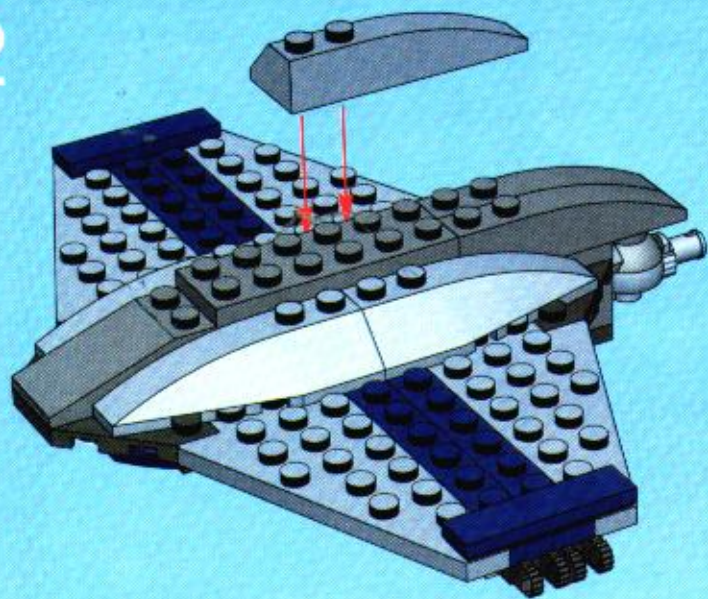

13

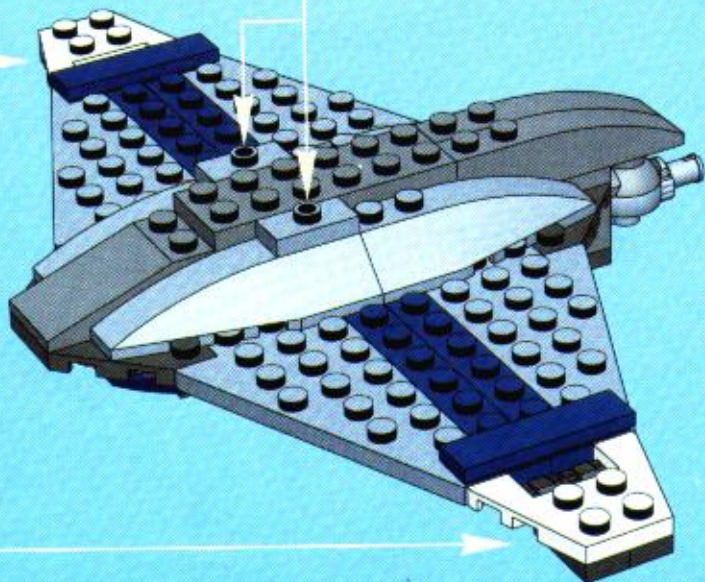

1

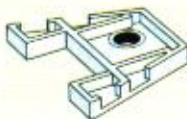

2



2x

1

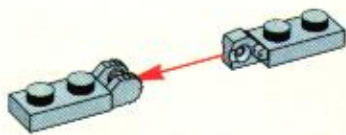

2

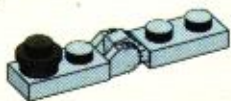

2x

14

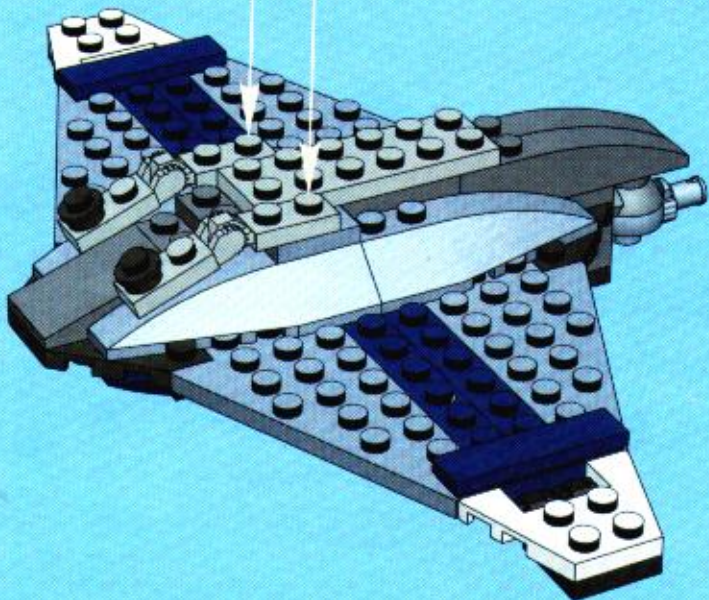

1

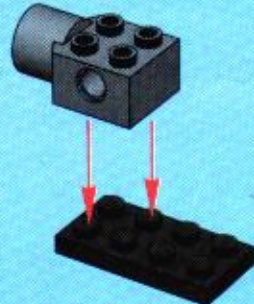

2



3



1

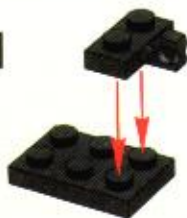

2

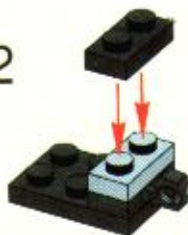

3



4



4

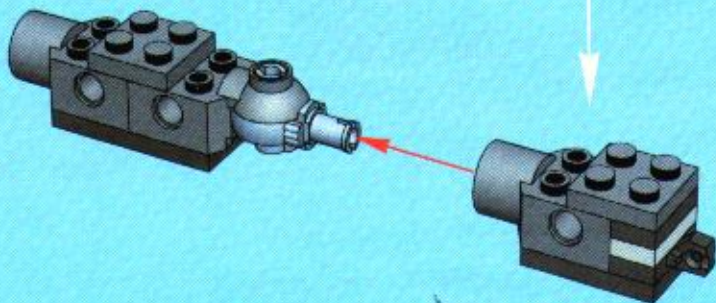



5

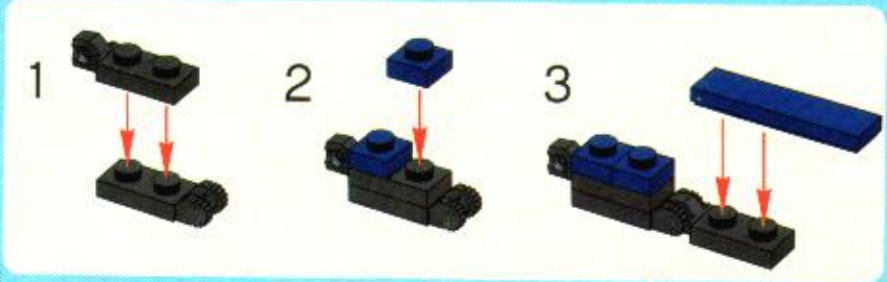
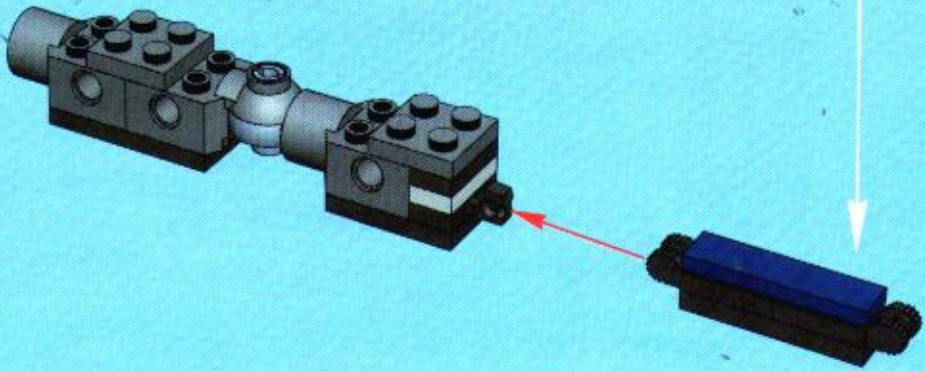

6

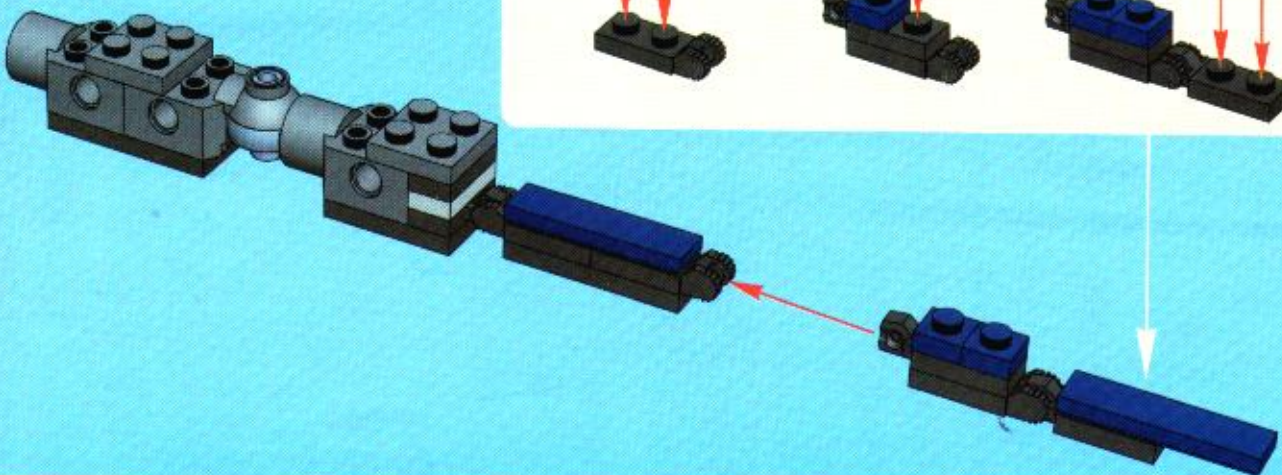

15

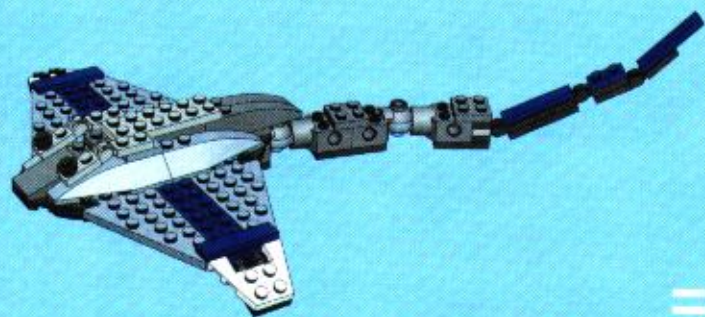
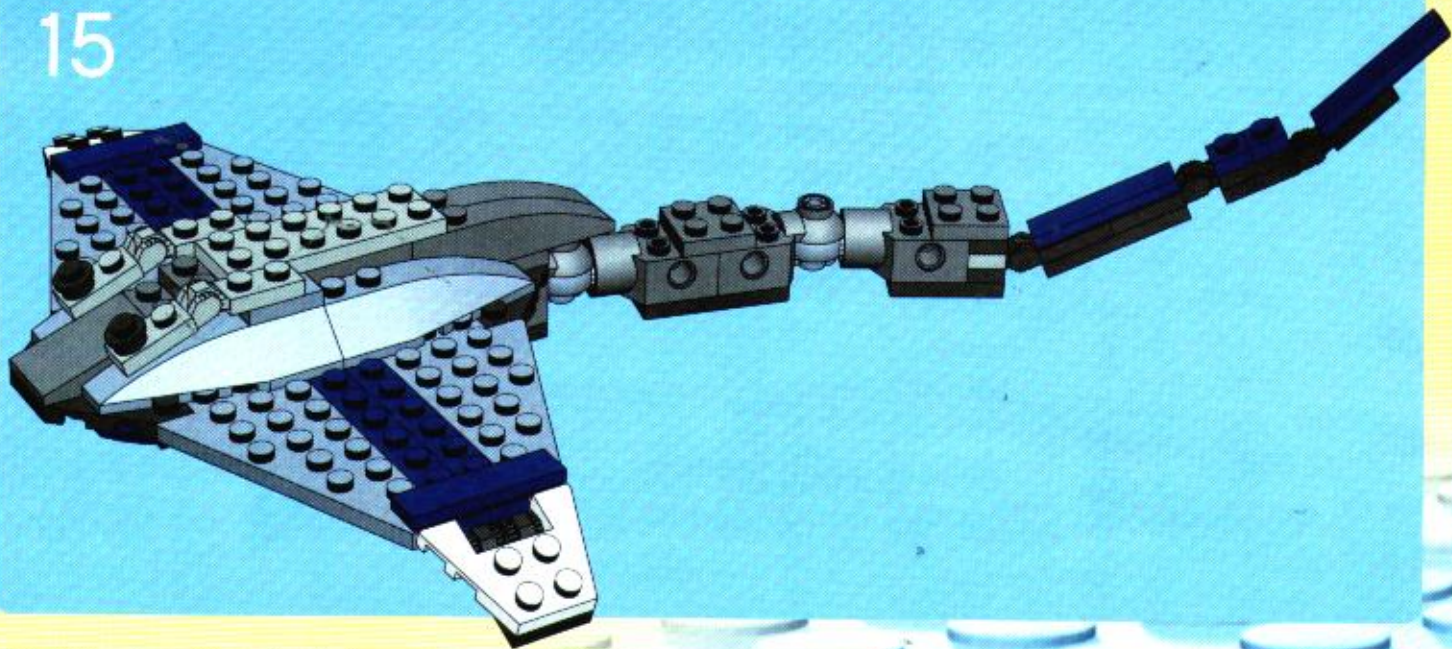

=



11

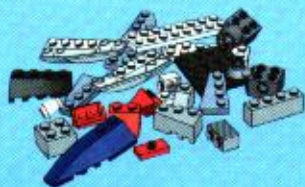





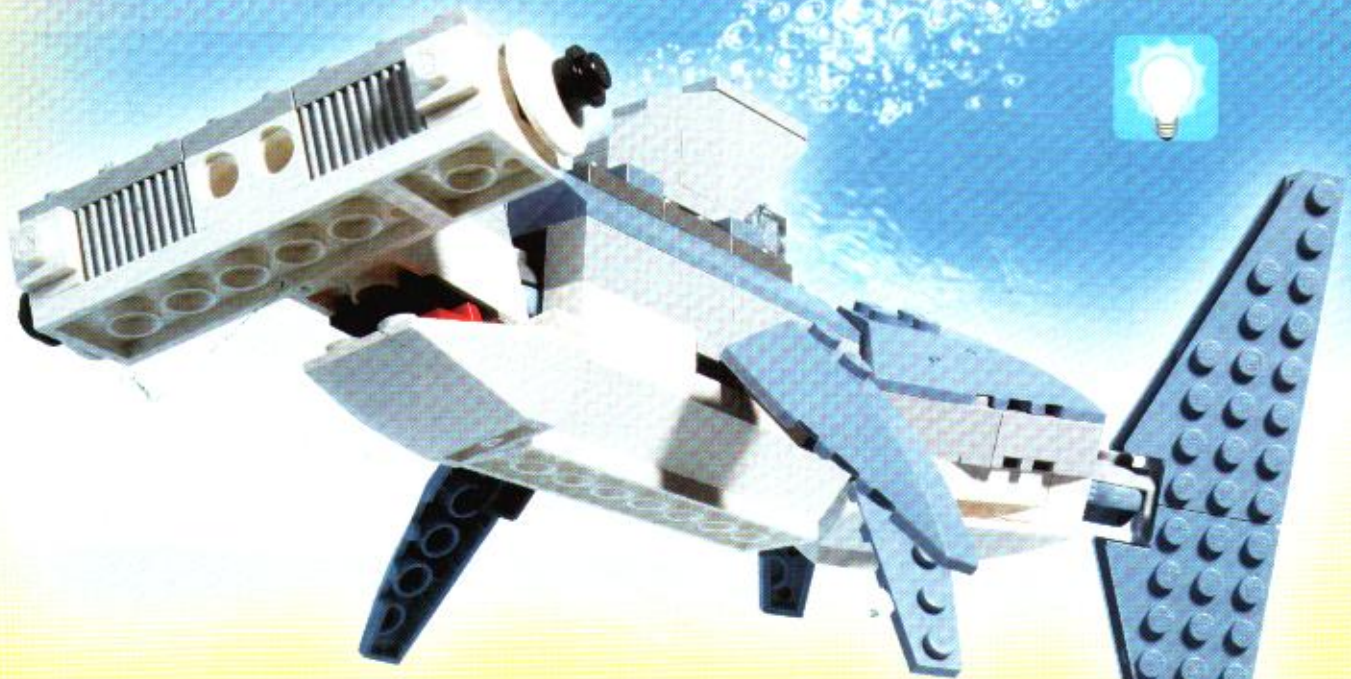

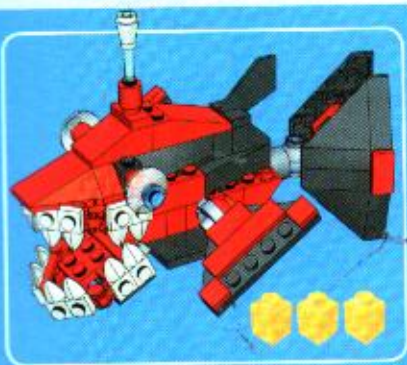

3



5

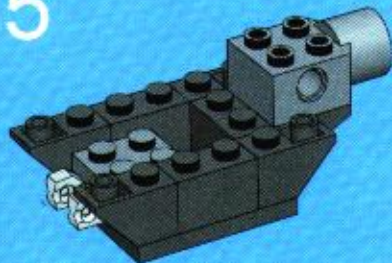

1



6

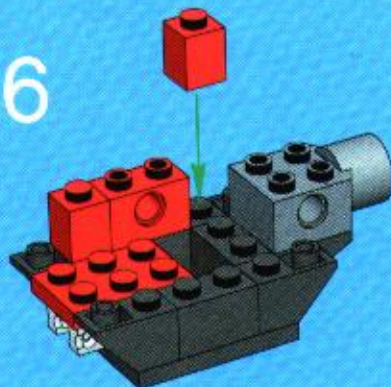

2

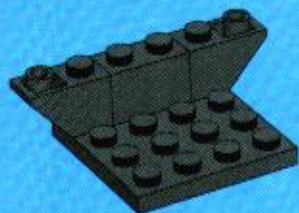

7

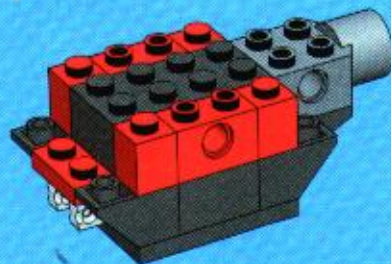

4

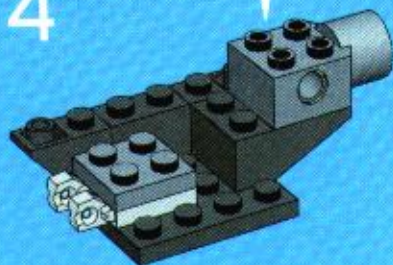

8

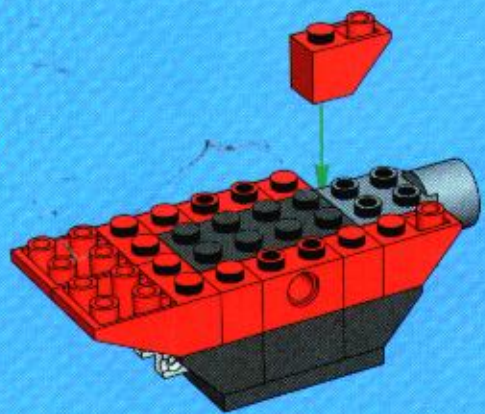

9

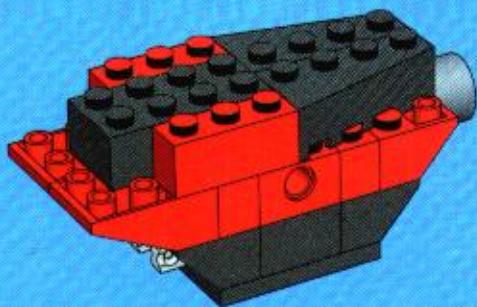

10

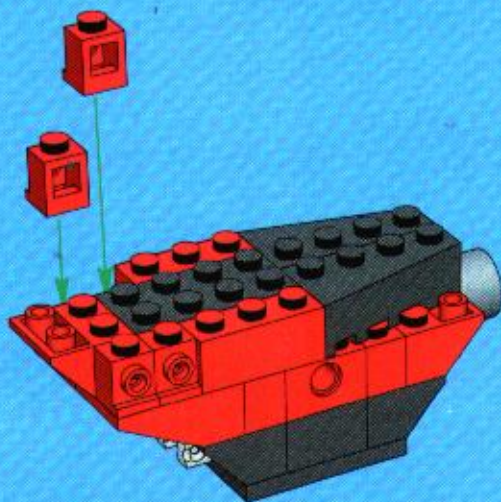

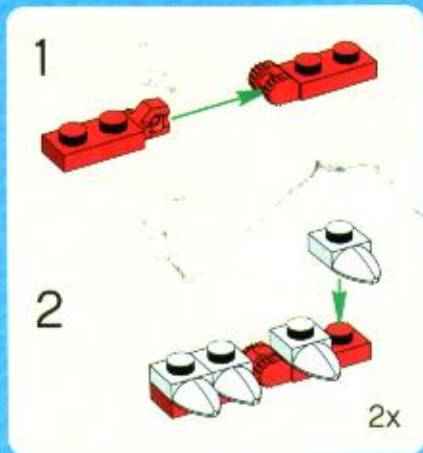

11

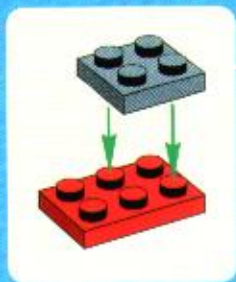
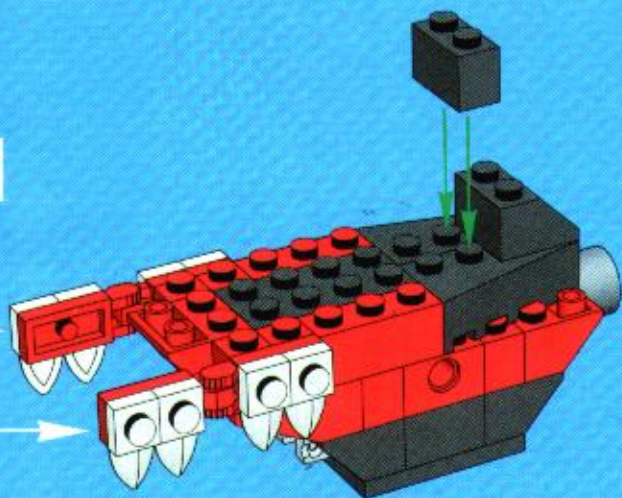

12

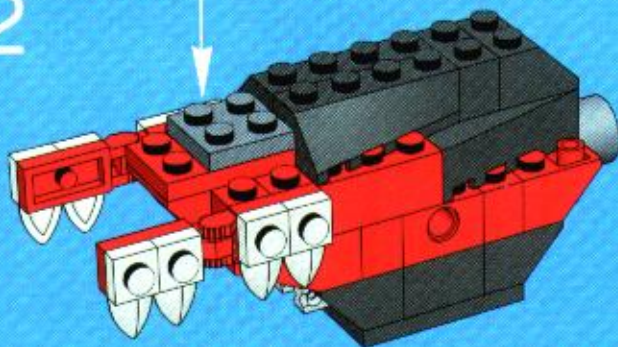

13

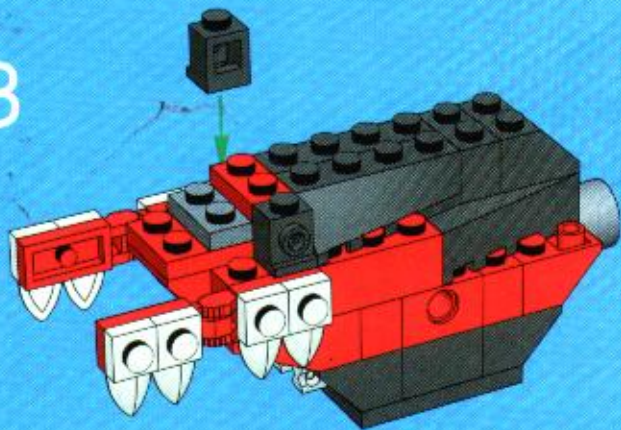

14

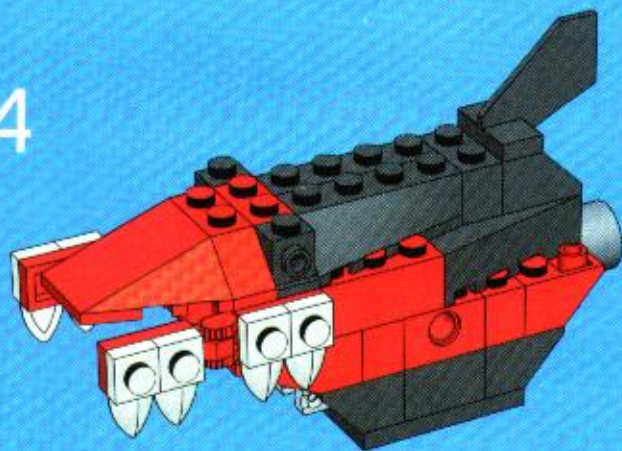

1

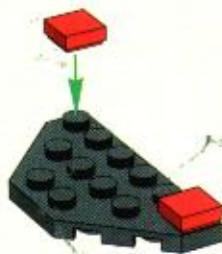

2



3

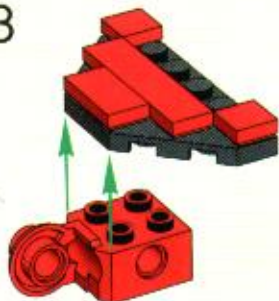

4

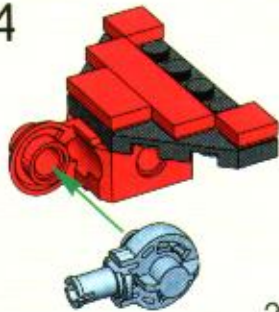

2x

15

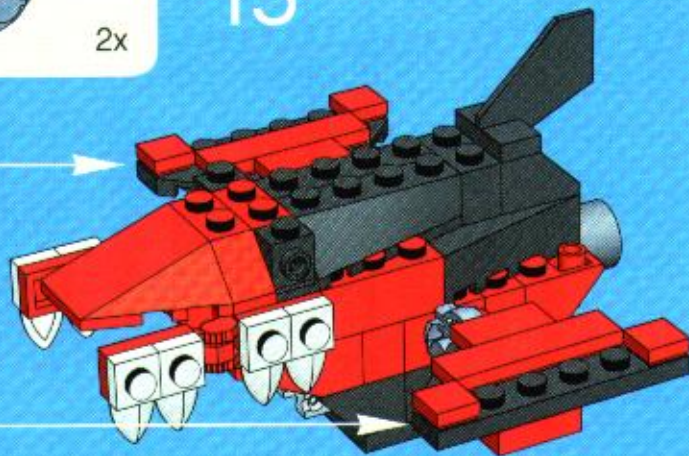

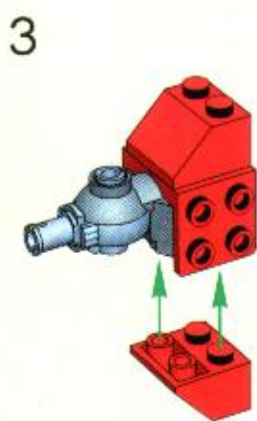
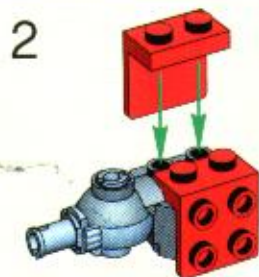
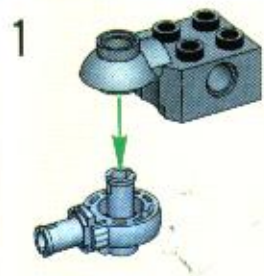

16

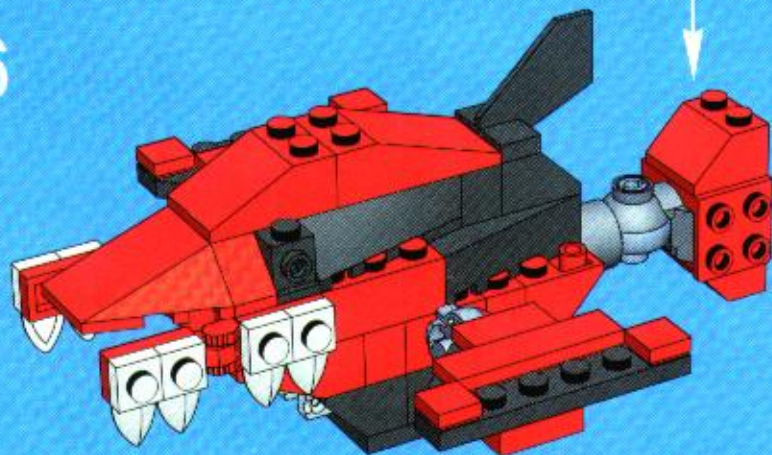

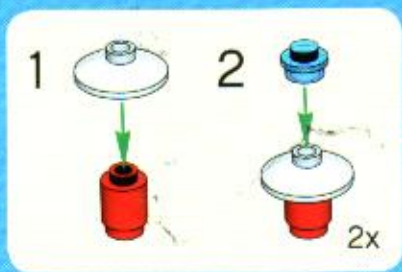

17

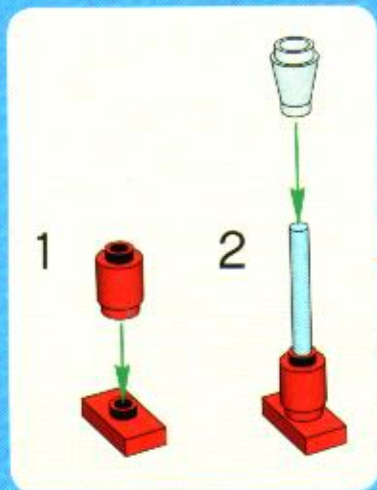
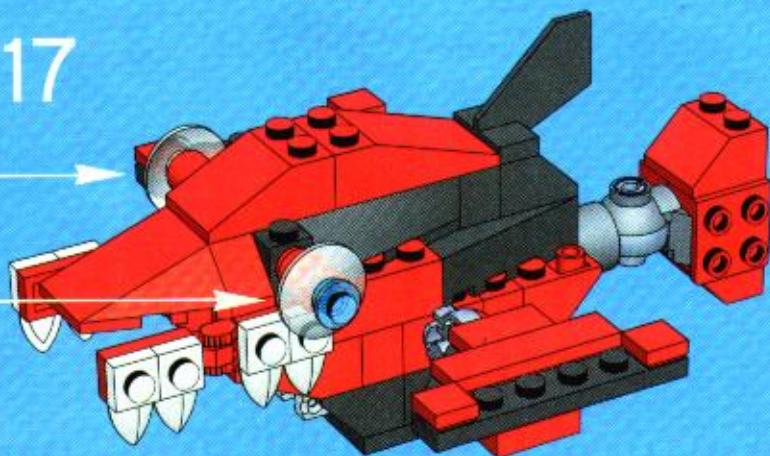

18

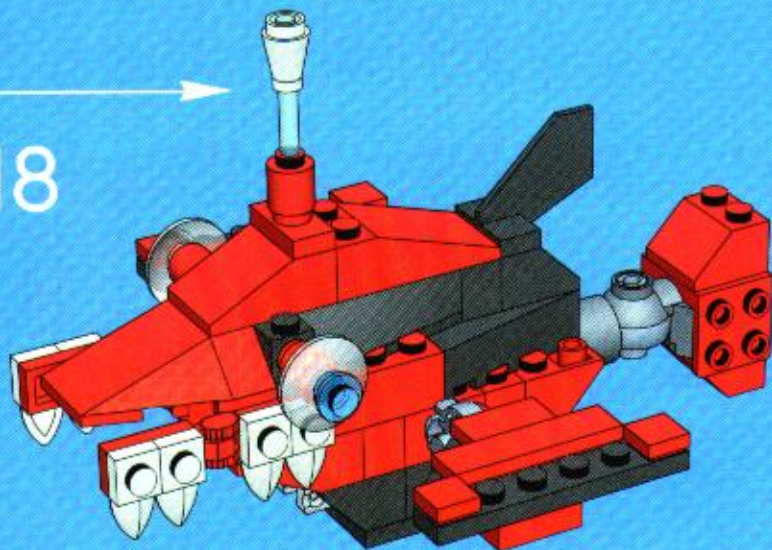

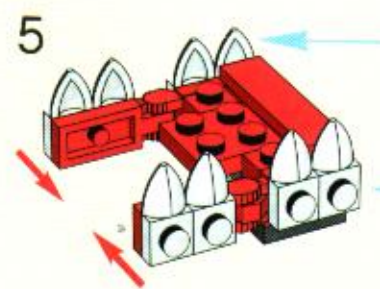
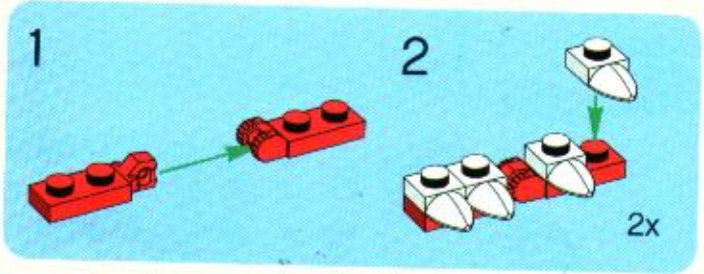
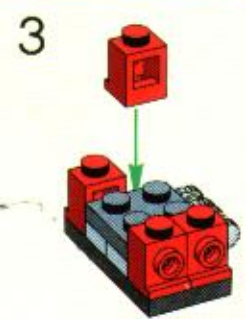
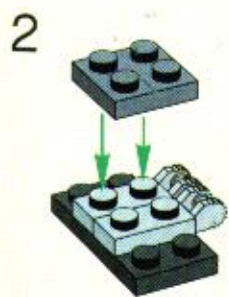

19

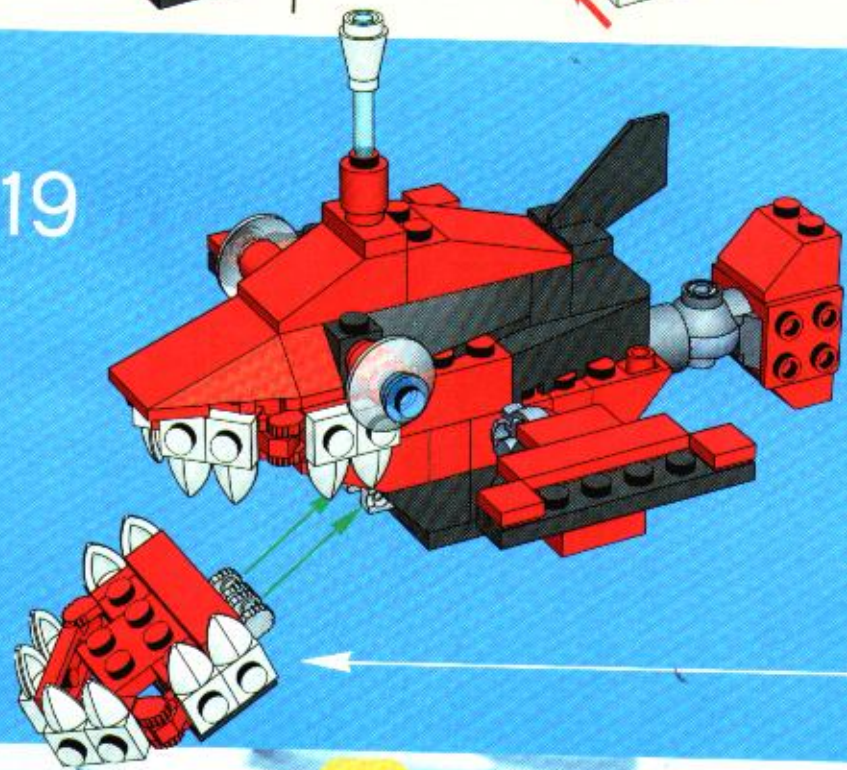

20

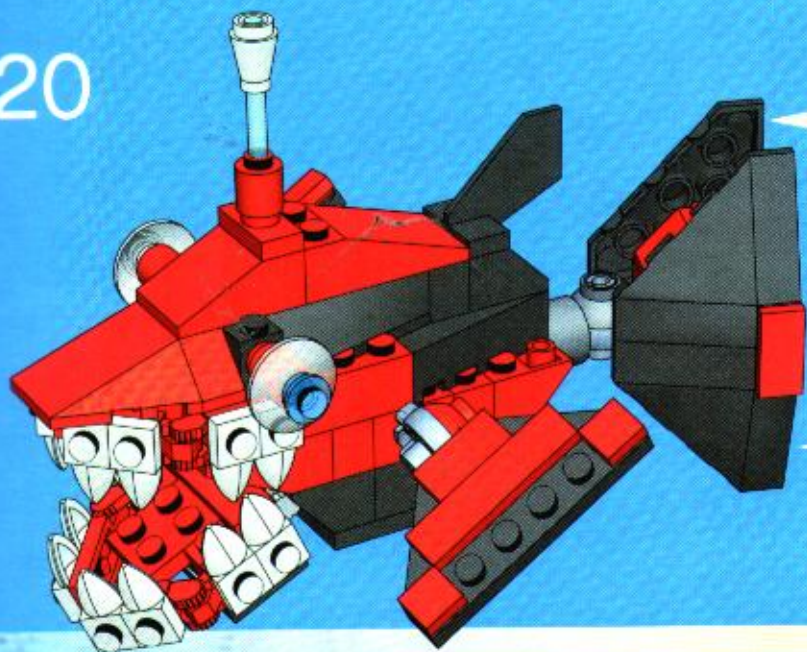

1



2



=





1

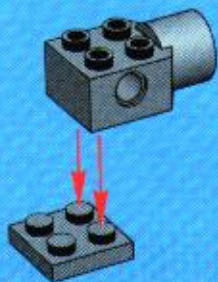

2

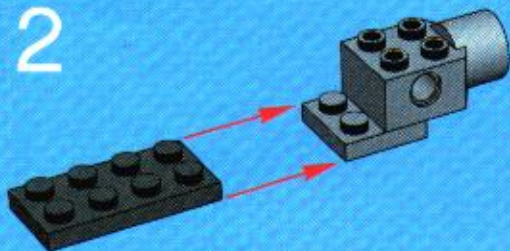

3

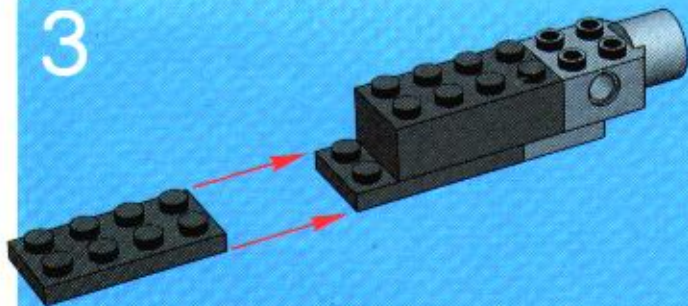

4

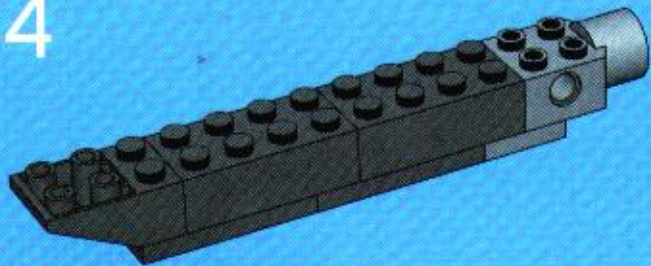

5

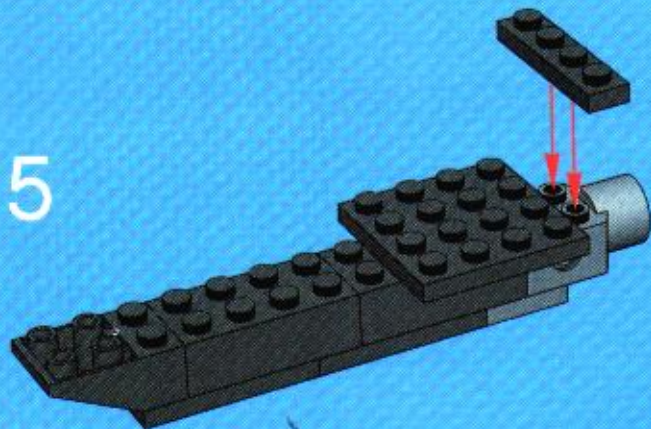

6



7

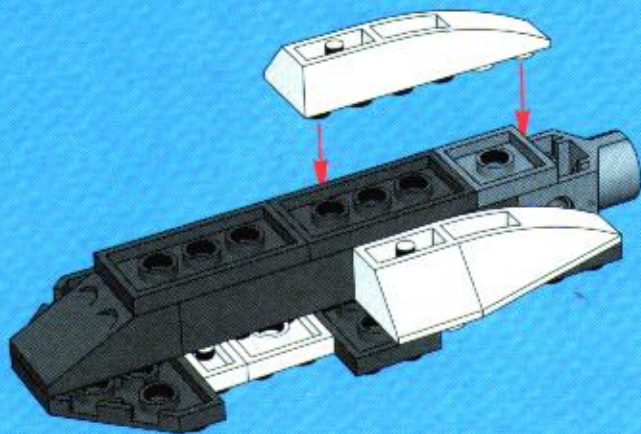

8

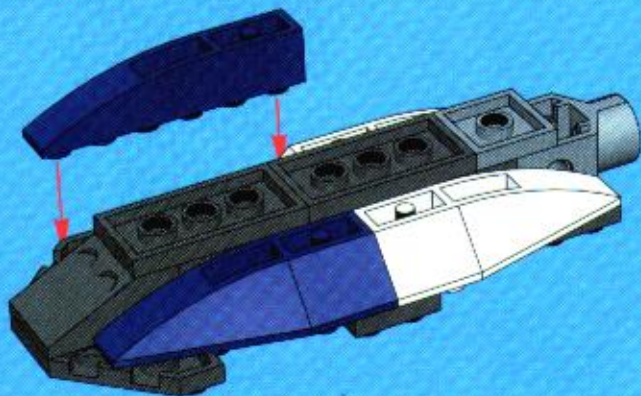

1



2

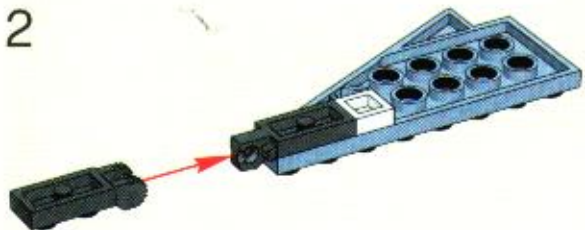

3

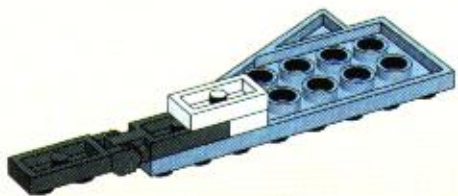

9

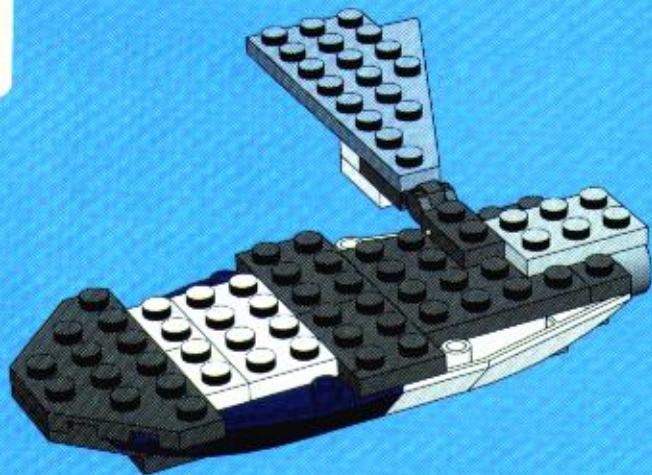

1



2

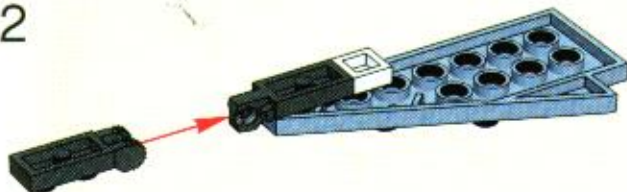

3

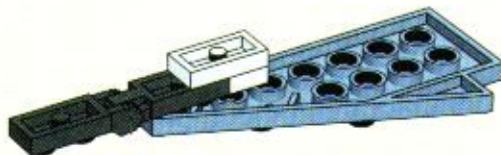

10

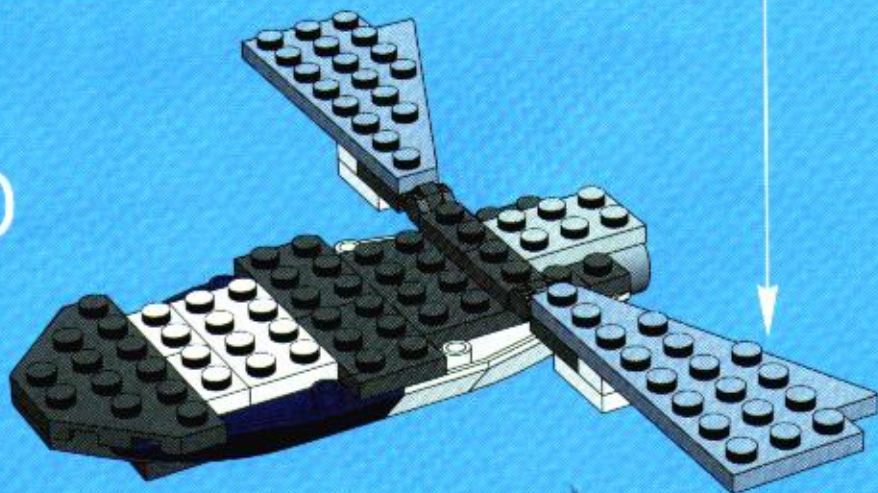

1



2



2x

11

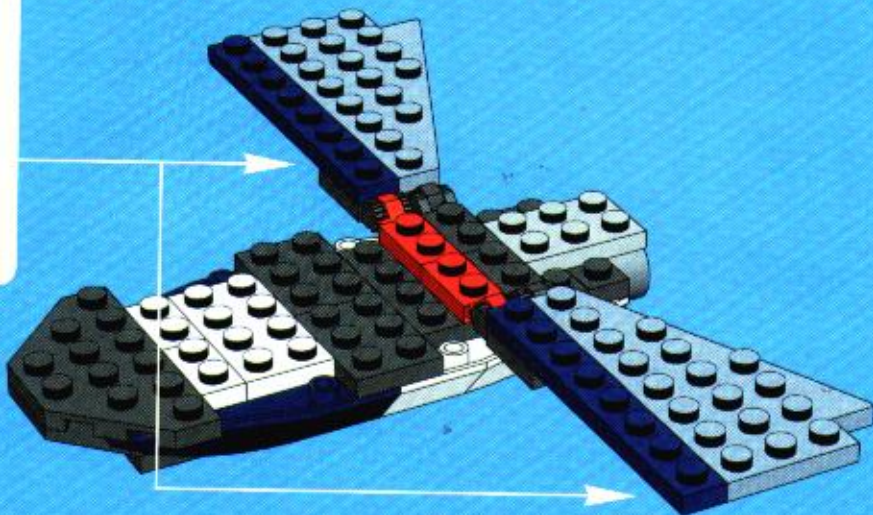

1



2



2x

12

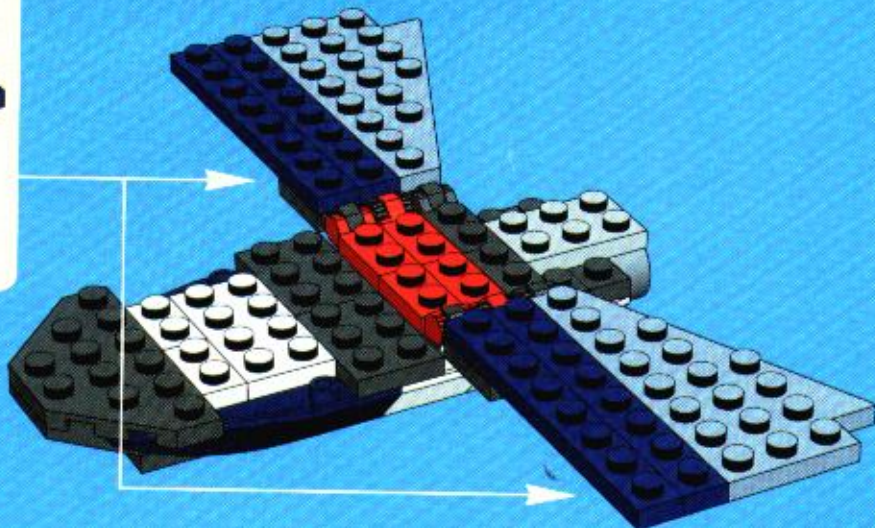

1



2



2x

13

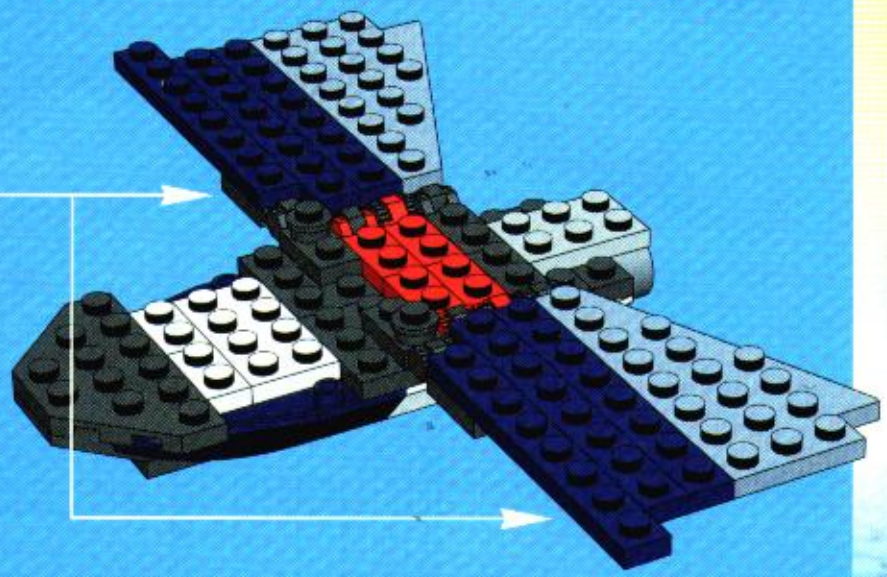

14

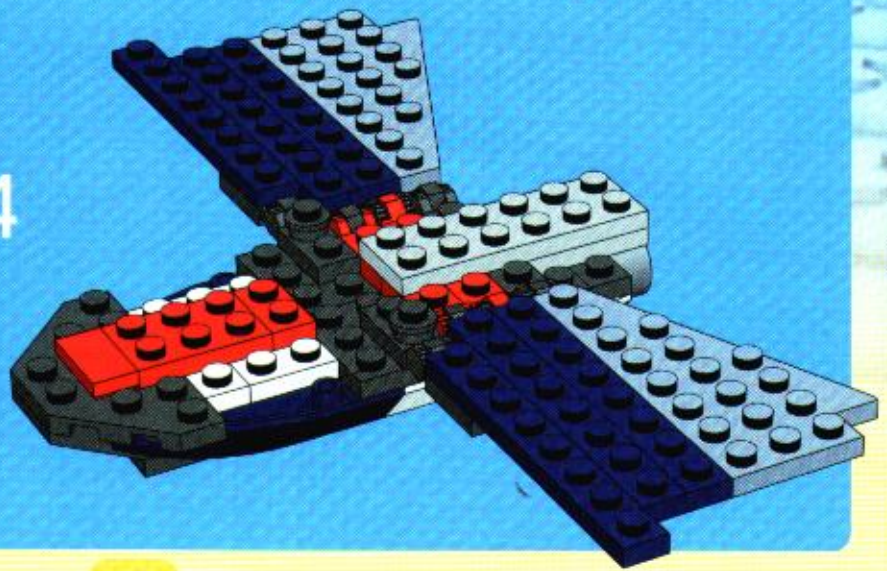

1



2



15

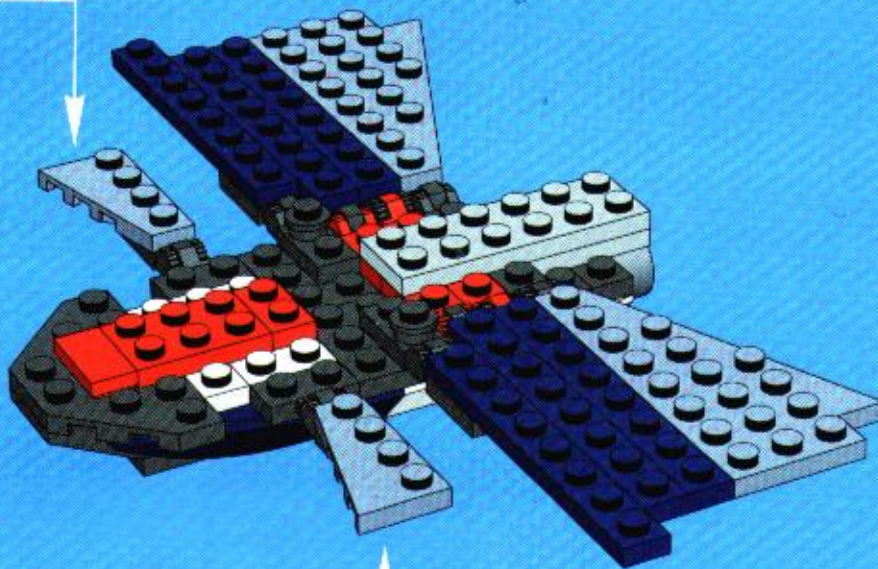

1



2



16

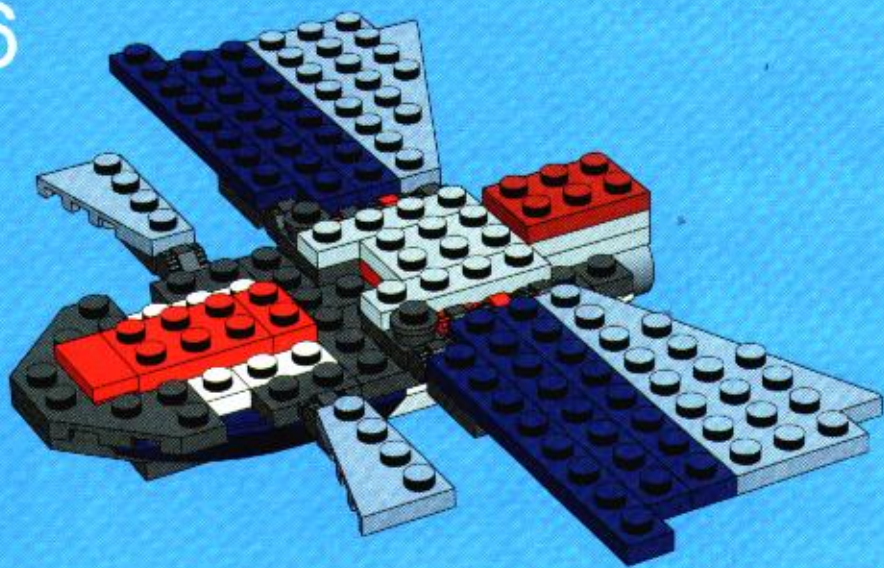

17

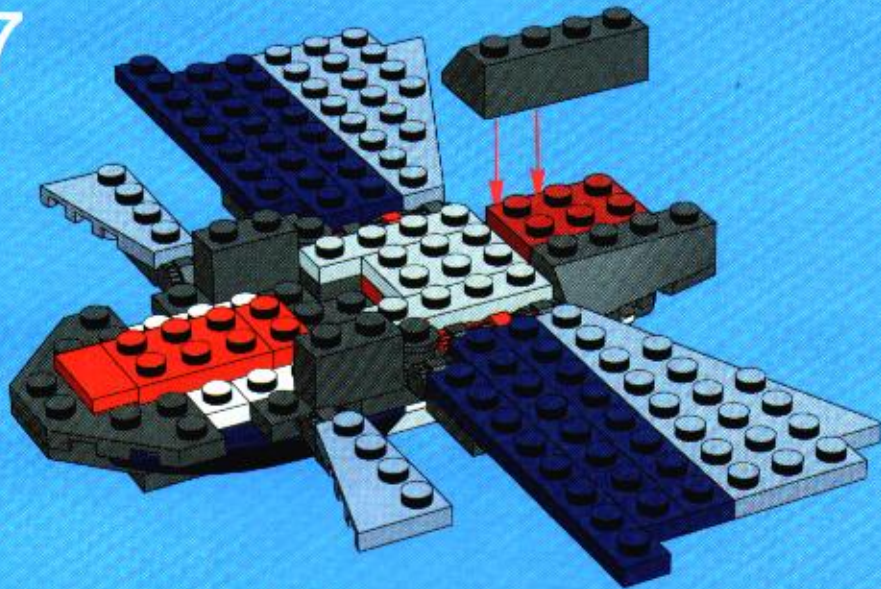

18

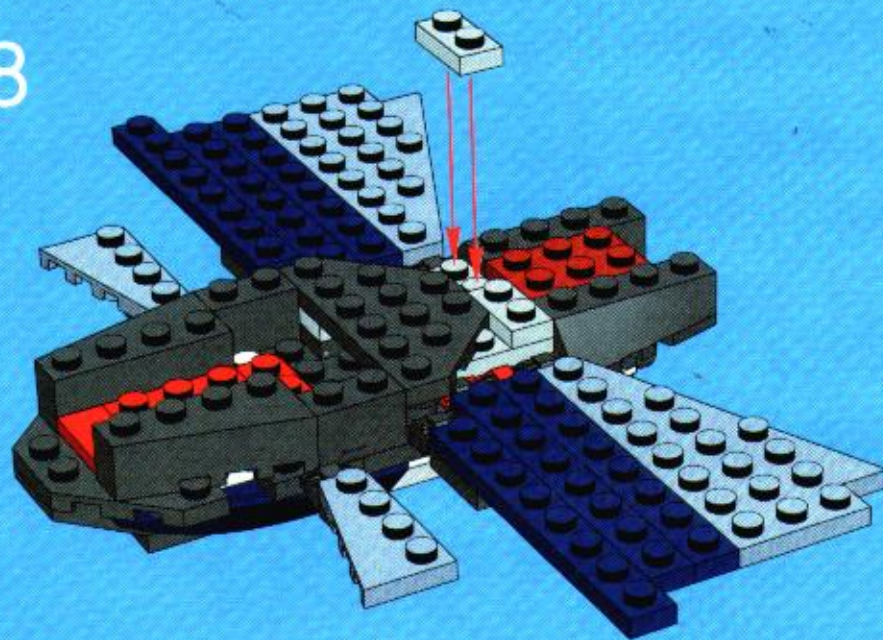

19

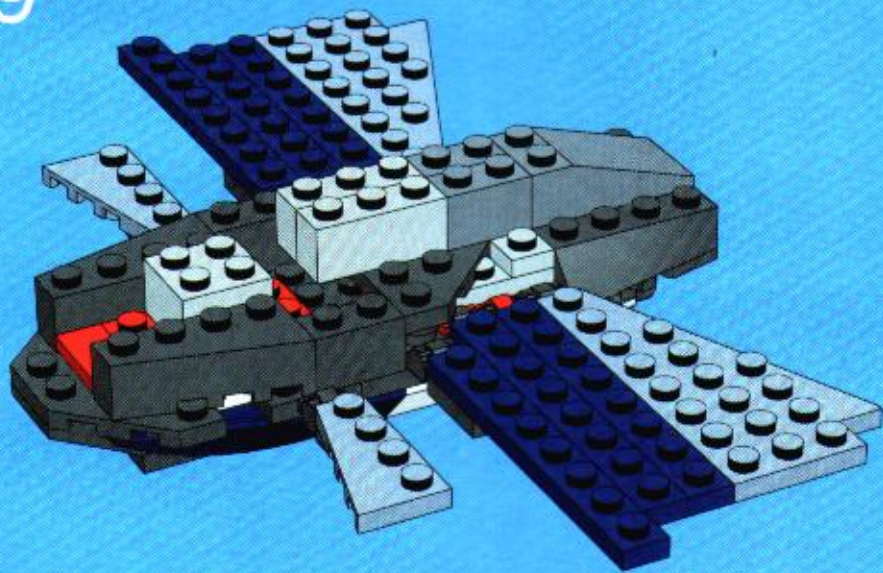

20

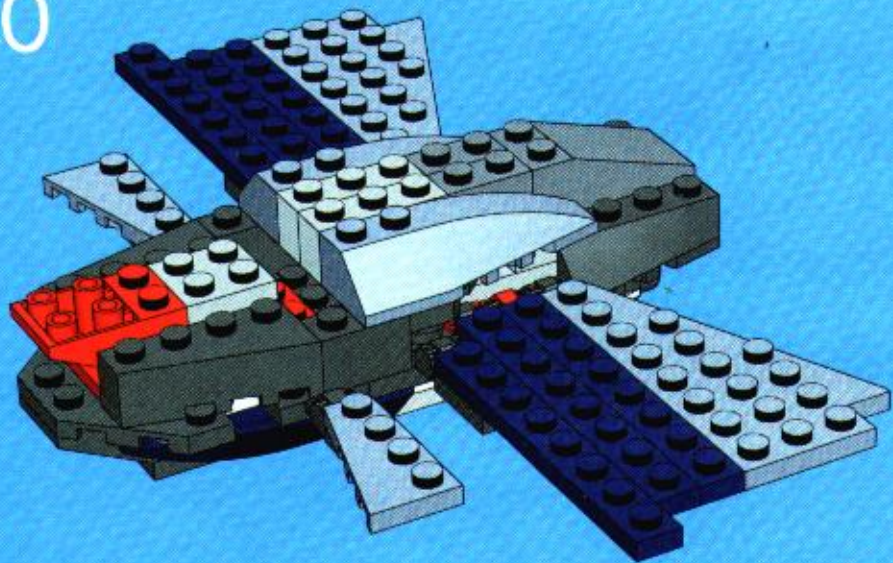

21

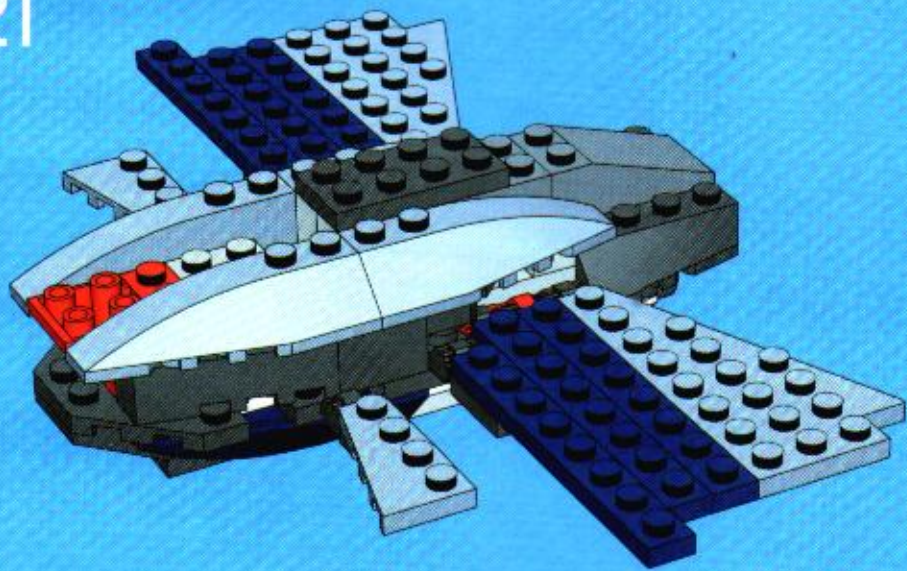

22

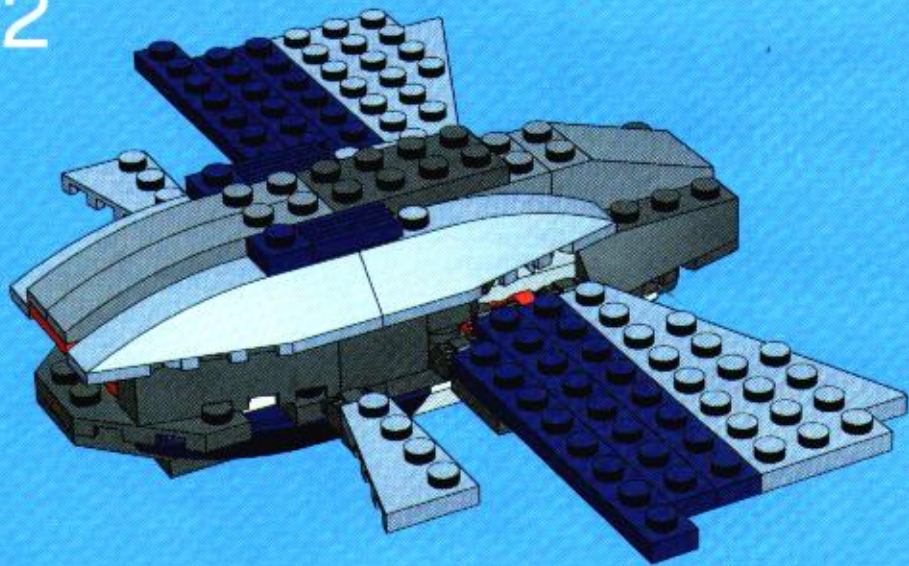

23

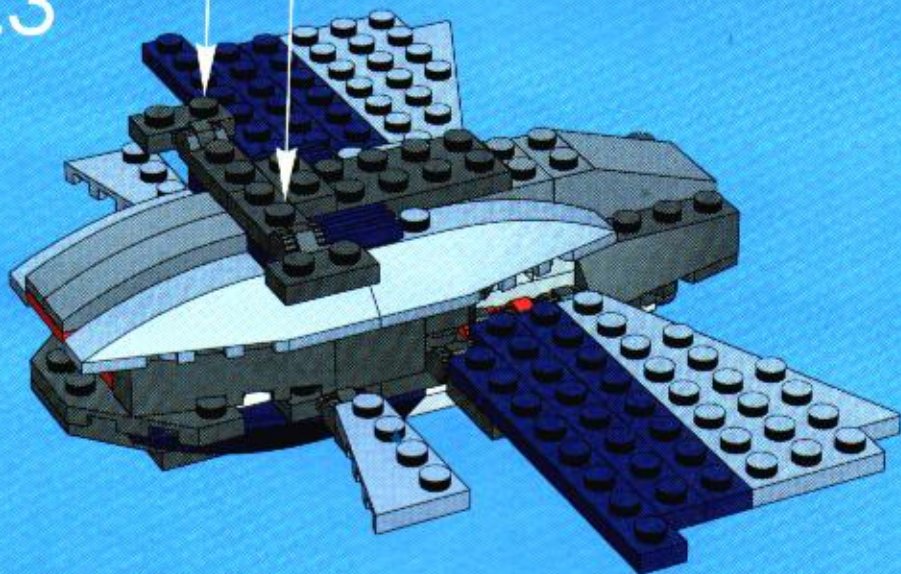
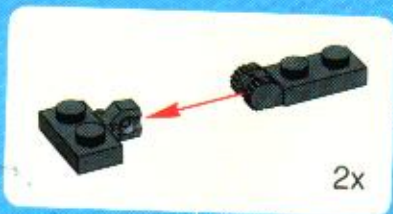

24

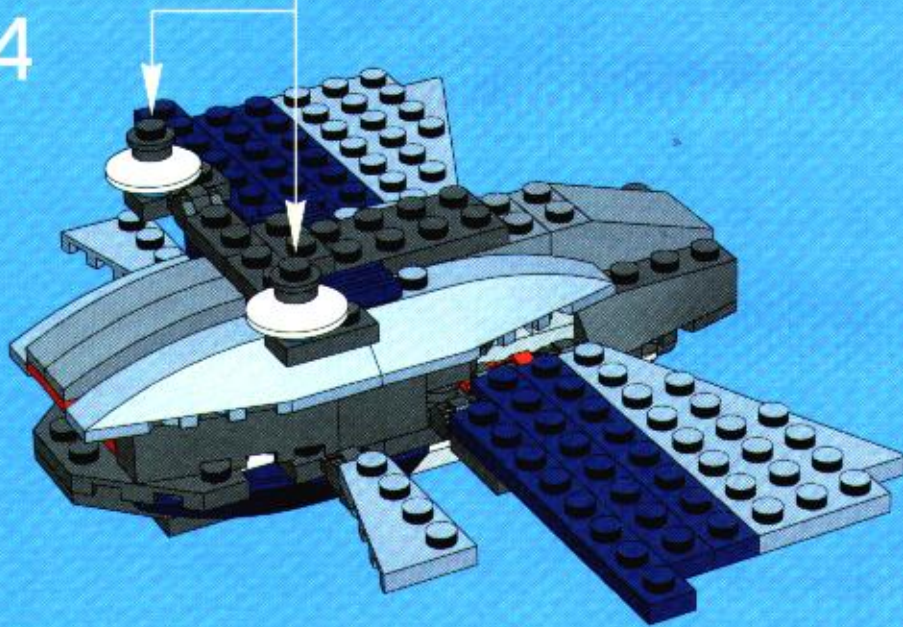
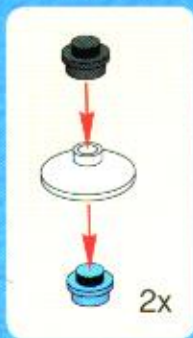



1

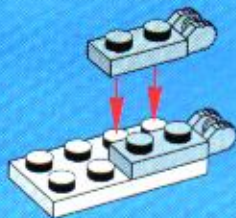

2

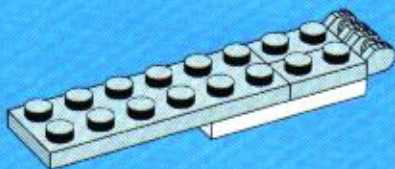

3

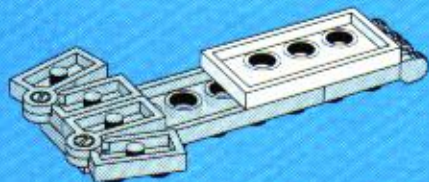

4

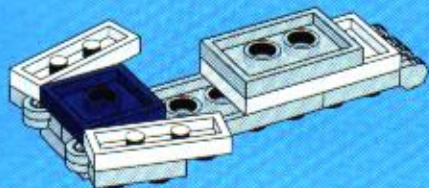

1

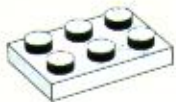

2

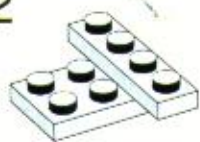

3



4



6

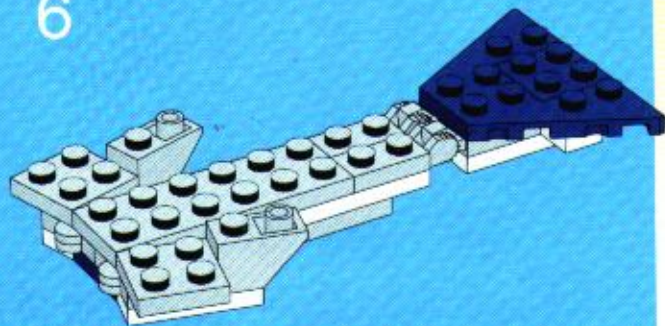

5

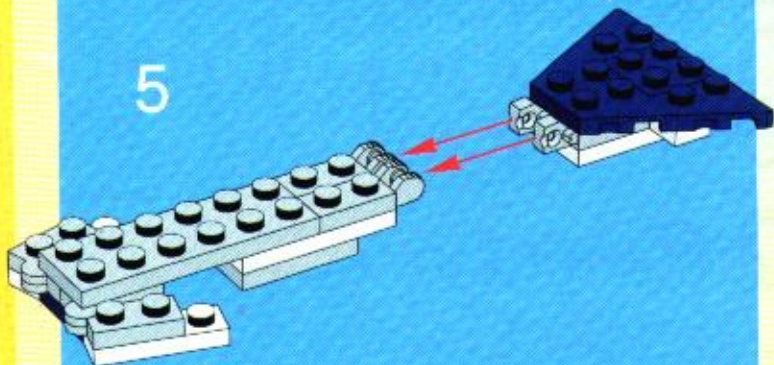

7

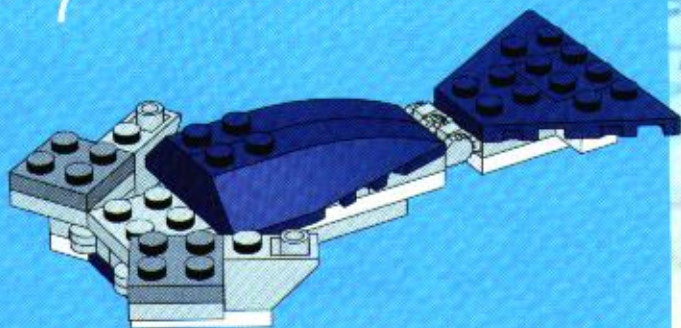

8

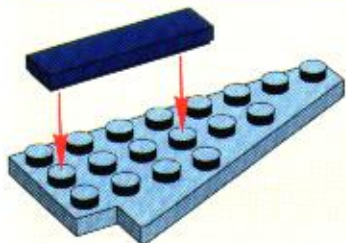
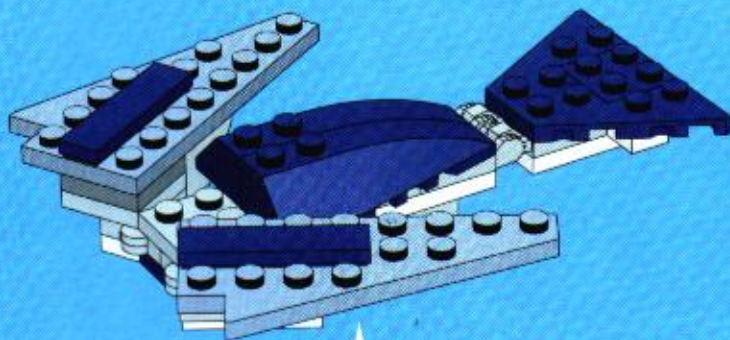
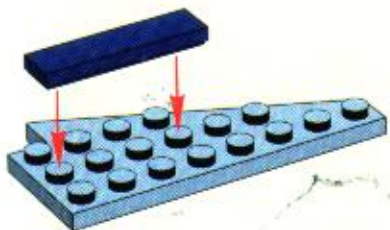

9

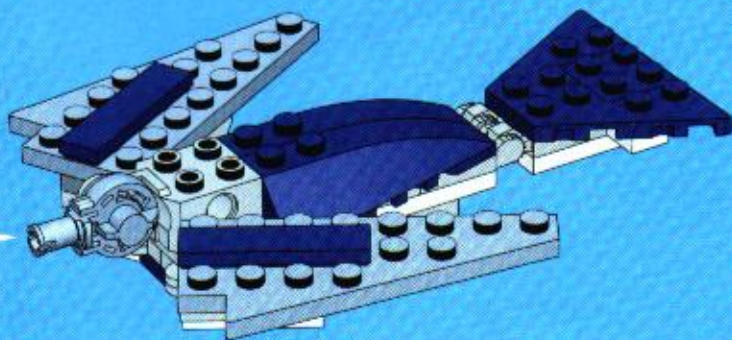
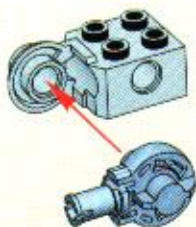

10

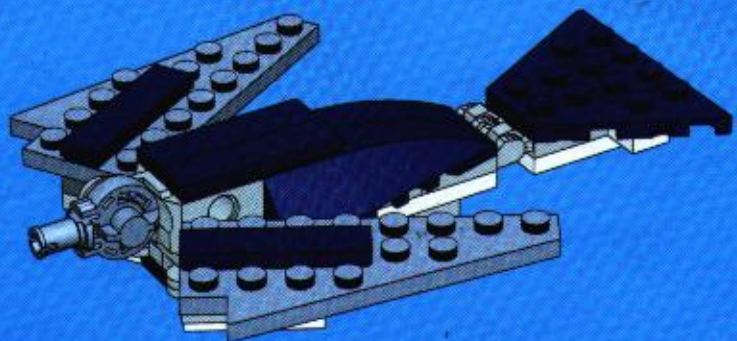

25

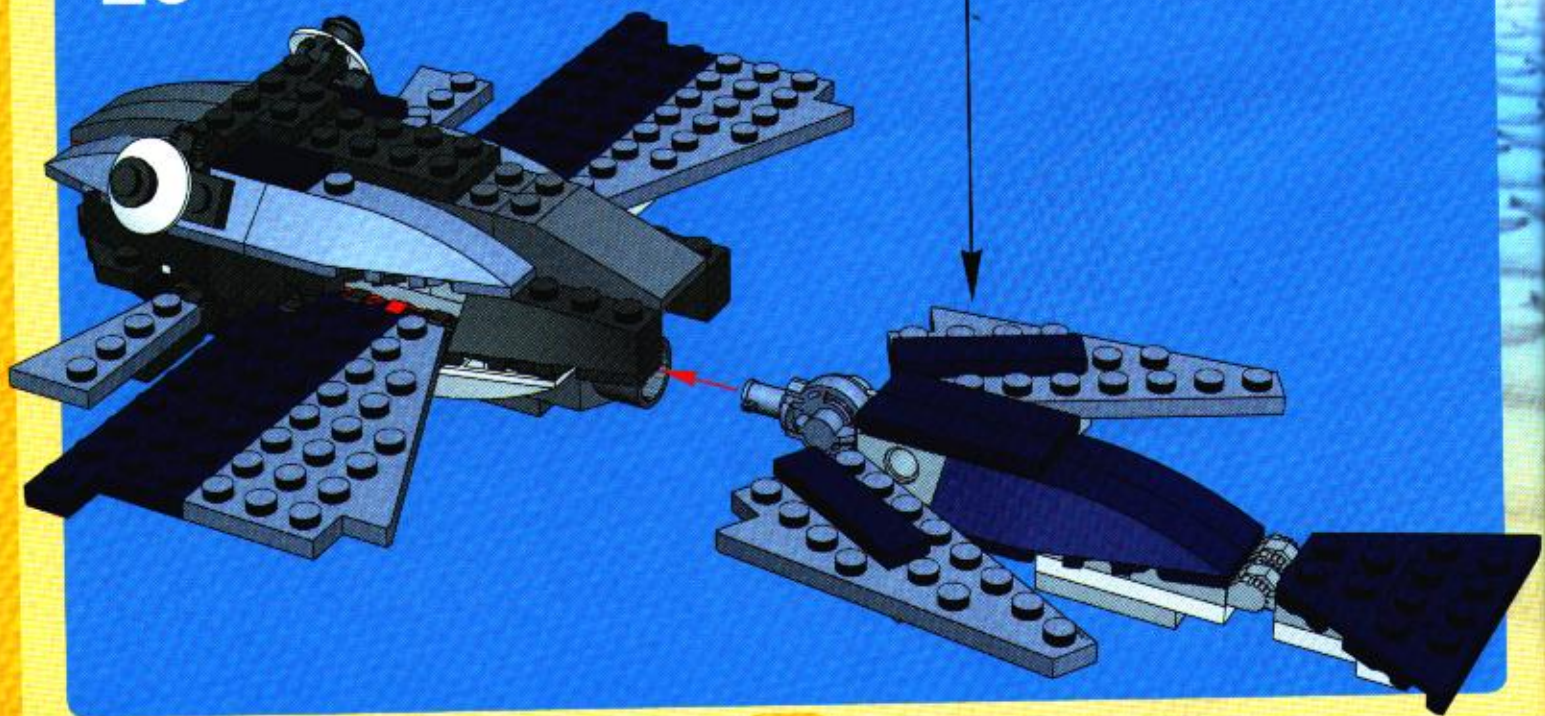

26

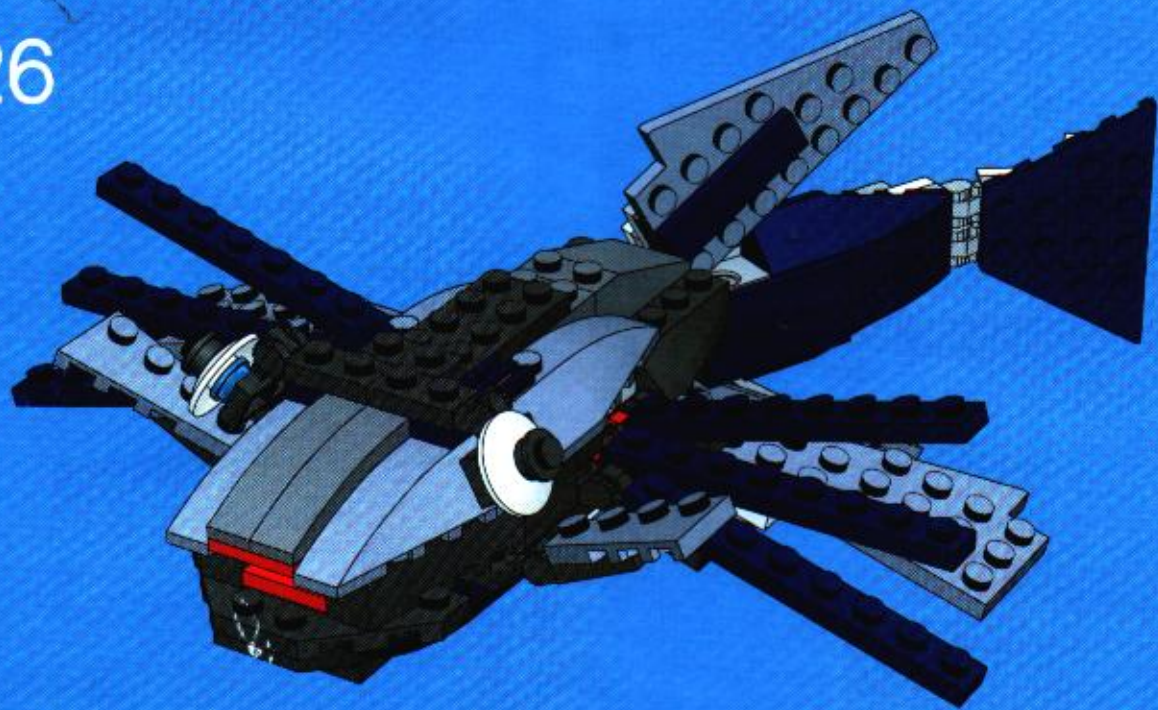



1

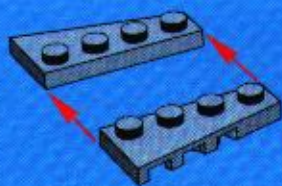

2

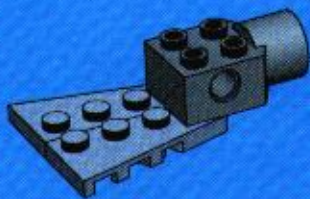

3

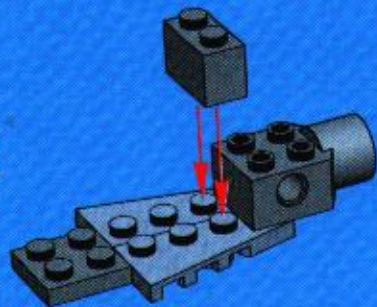

4



5

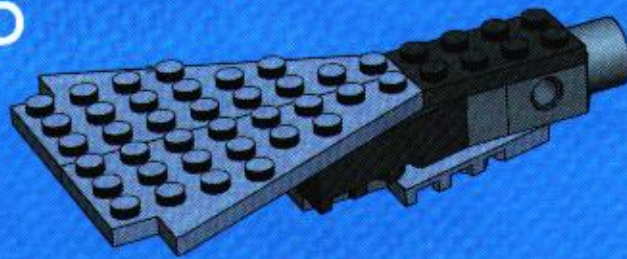

6

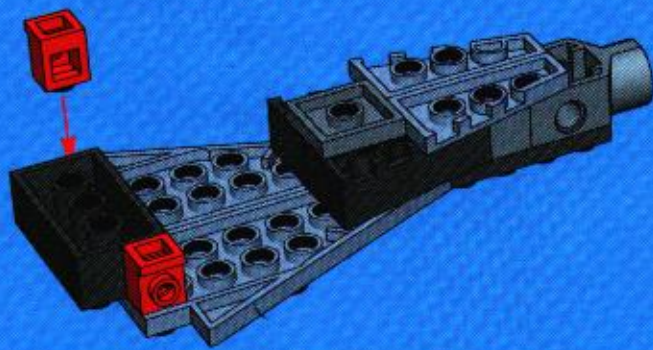

7

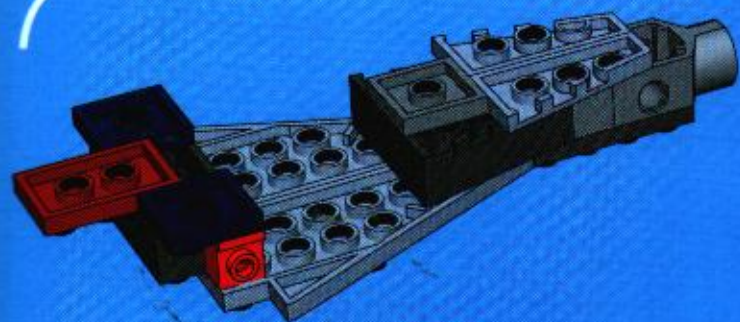

8

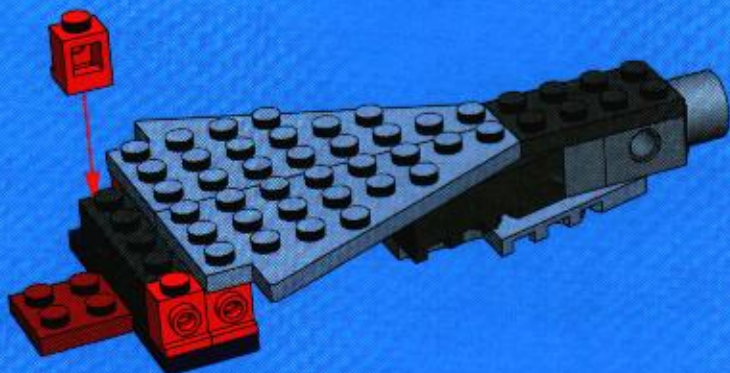

9

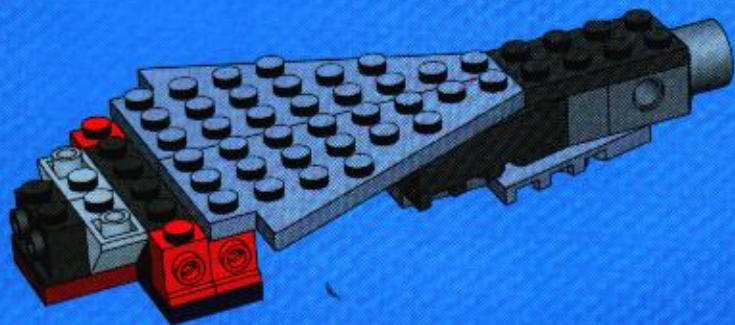

10

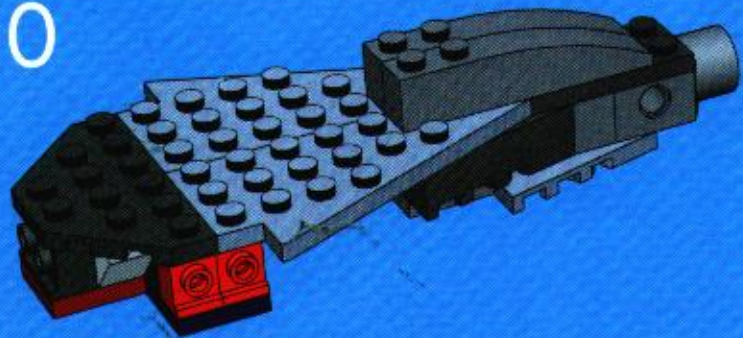

11

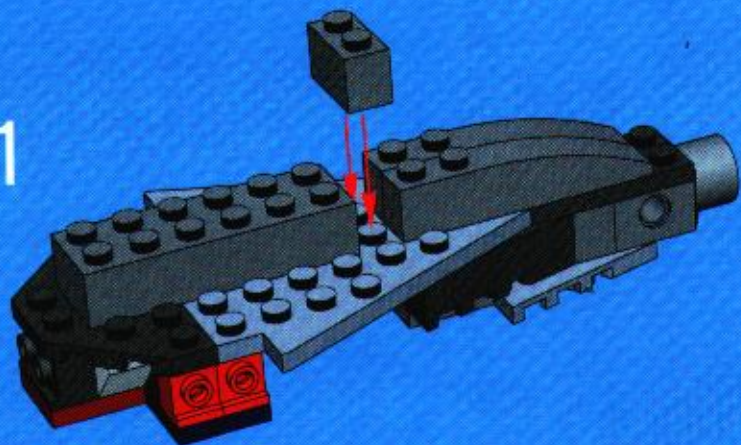

12

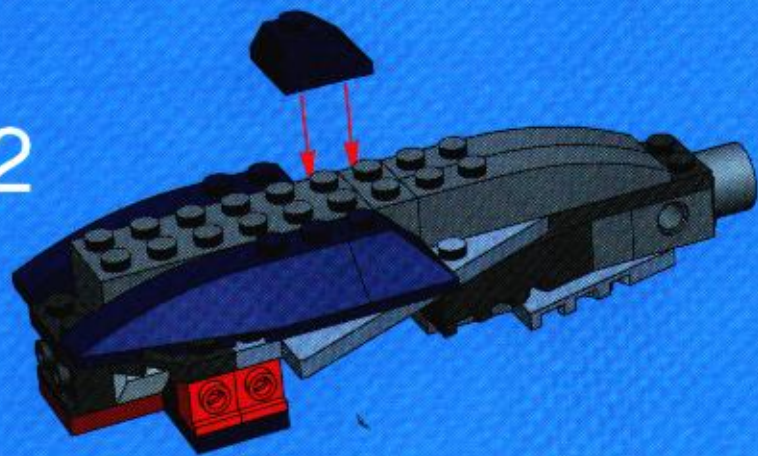

1



2



13

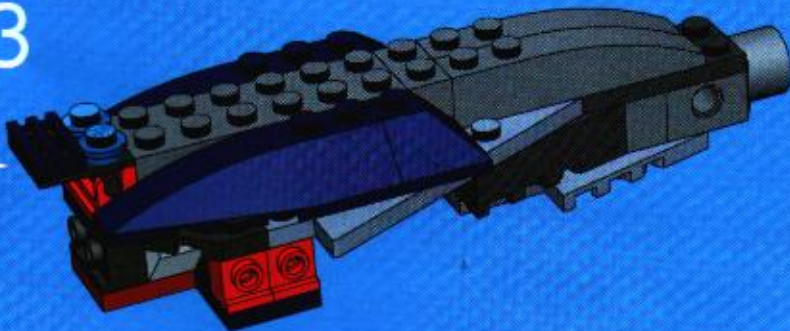

1



2



14

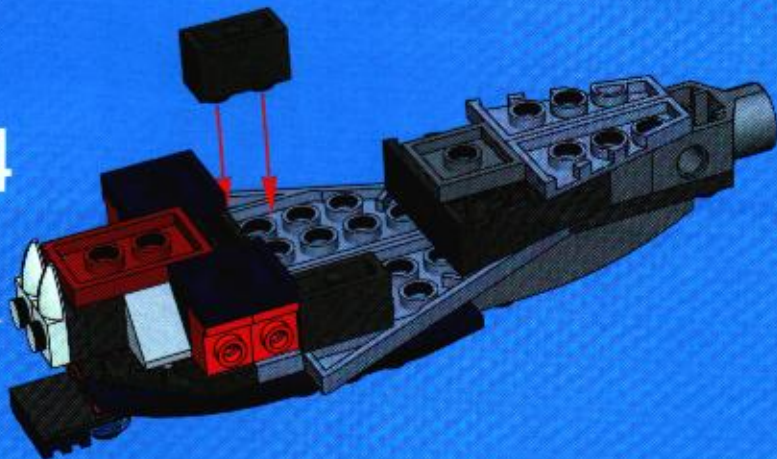

15

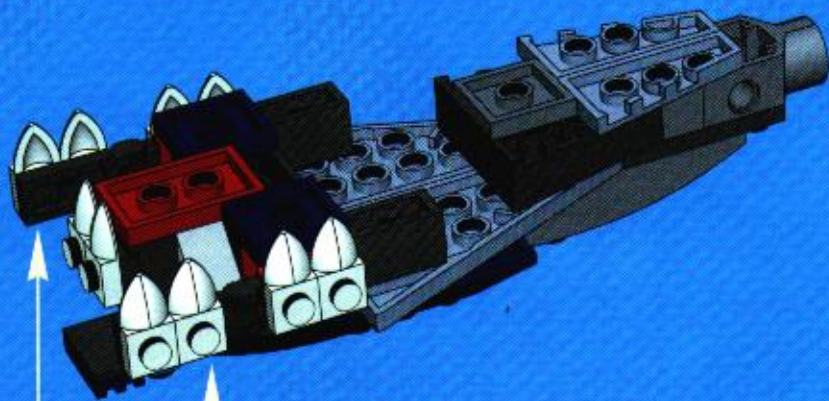

1

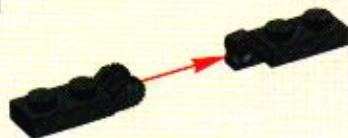

2



2x

16





1



2



3



4



1

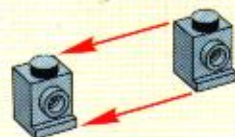

2

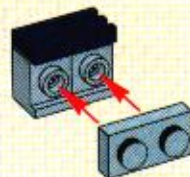

3



5

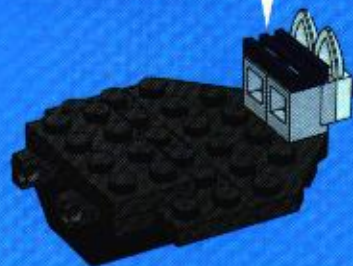

1

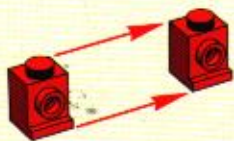

2



2x

6

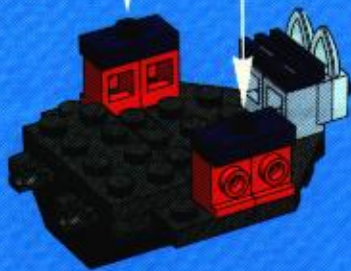

1

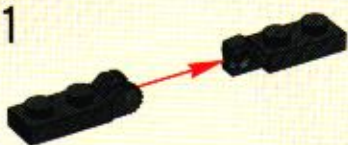

2



2x

7

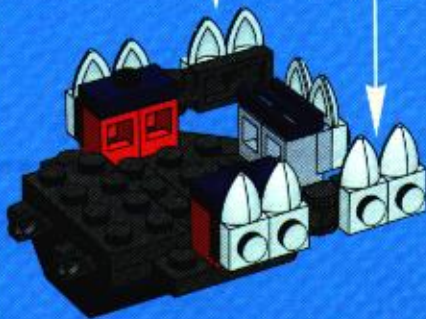

8

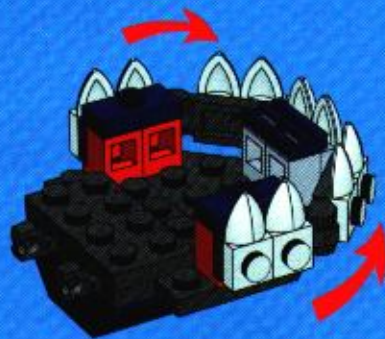

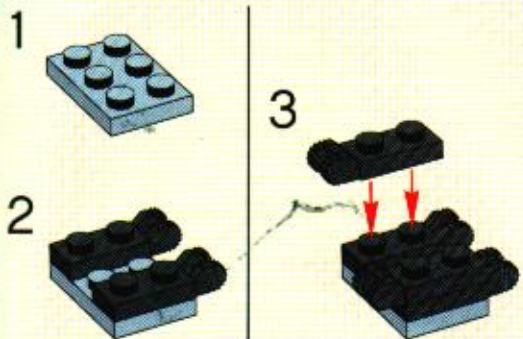

9

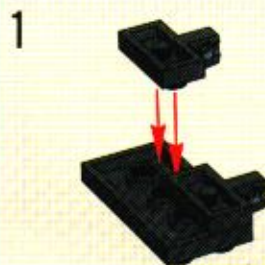
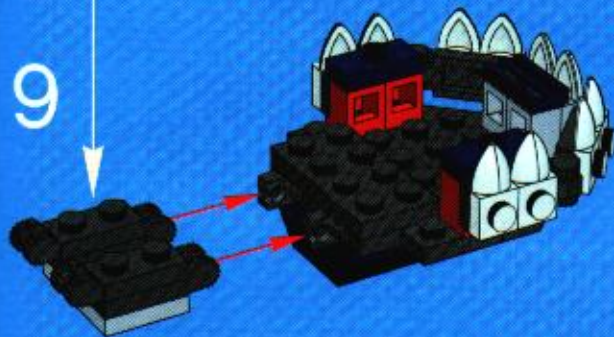

2

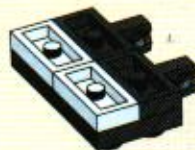

3

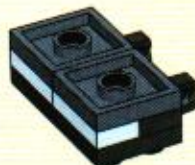

4



5



10

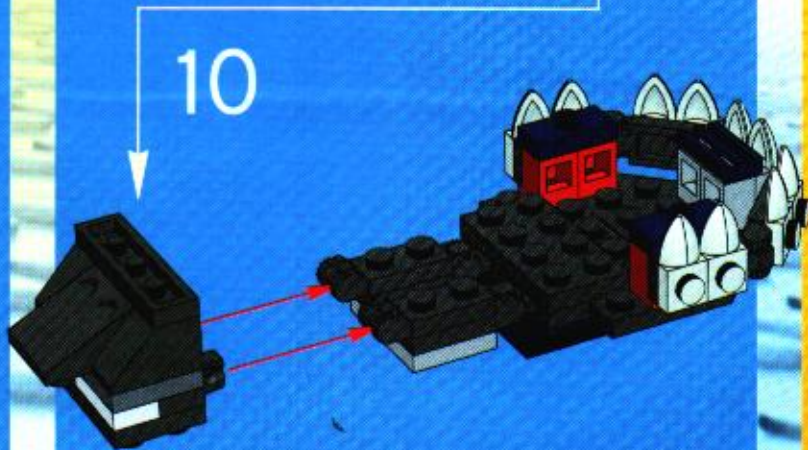

11

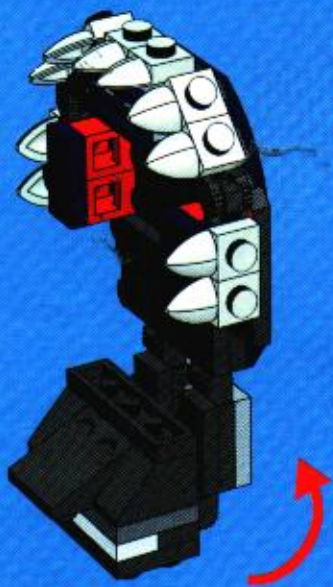

17



18

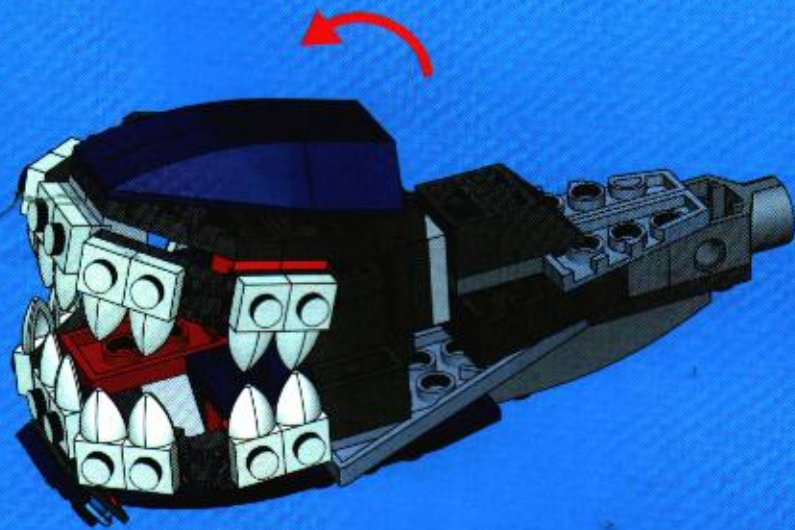

1

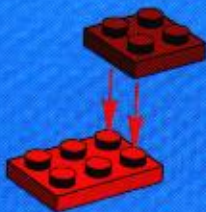

2



3



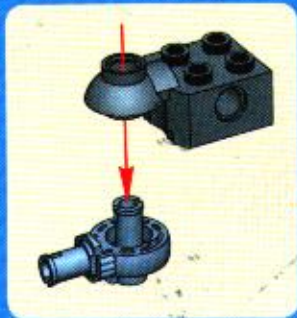

4



5



6

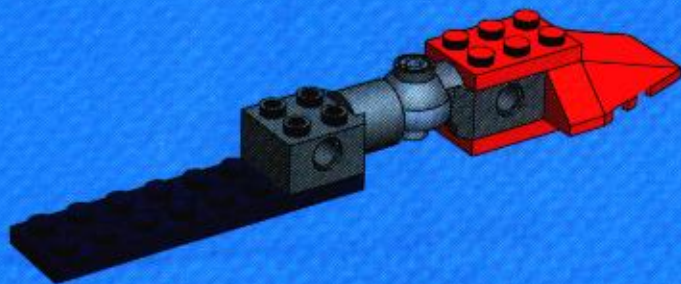

7



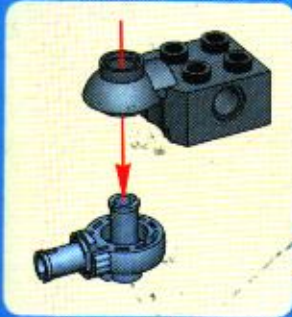

8



9



10



11

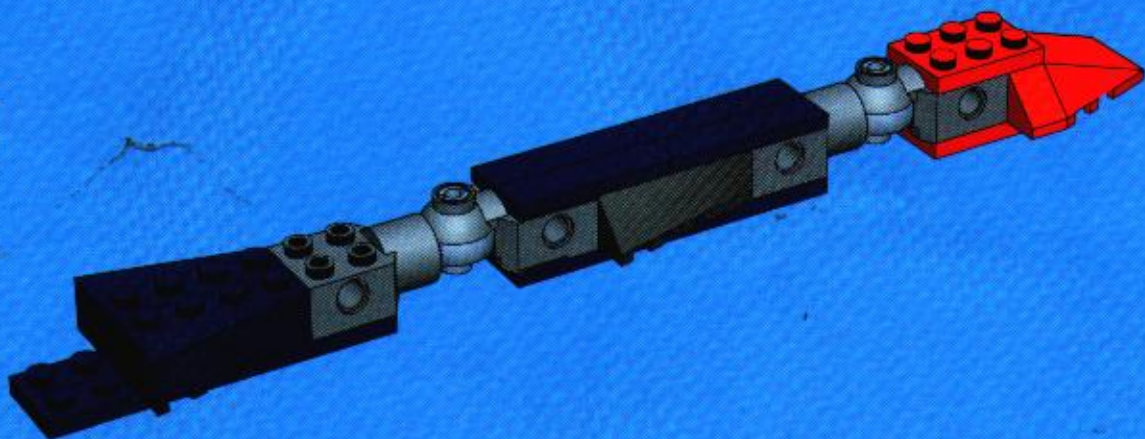

12

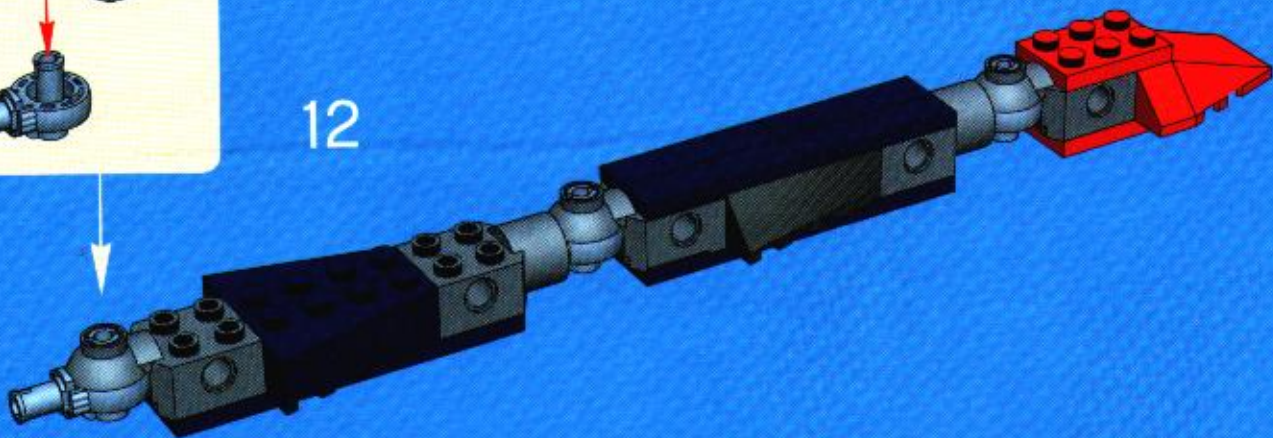

13

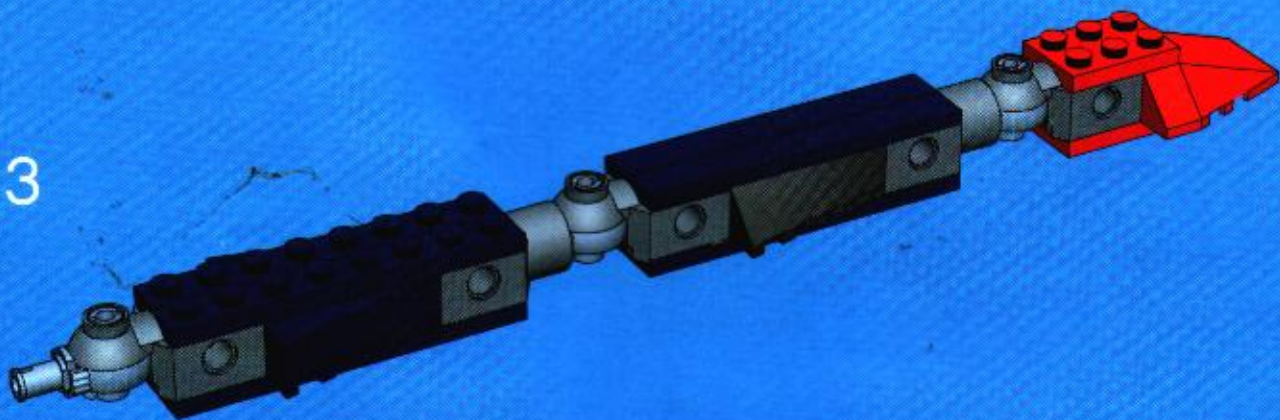

20

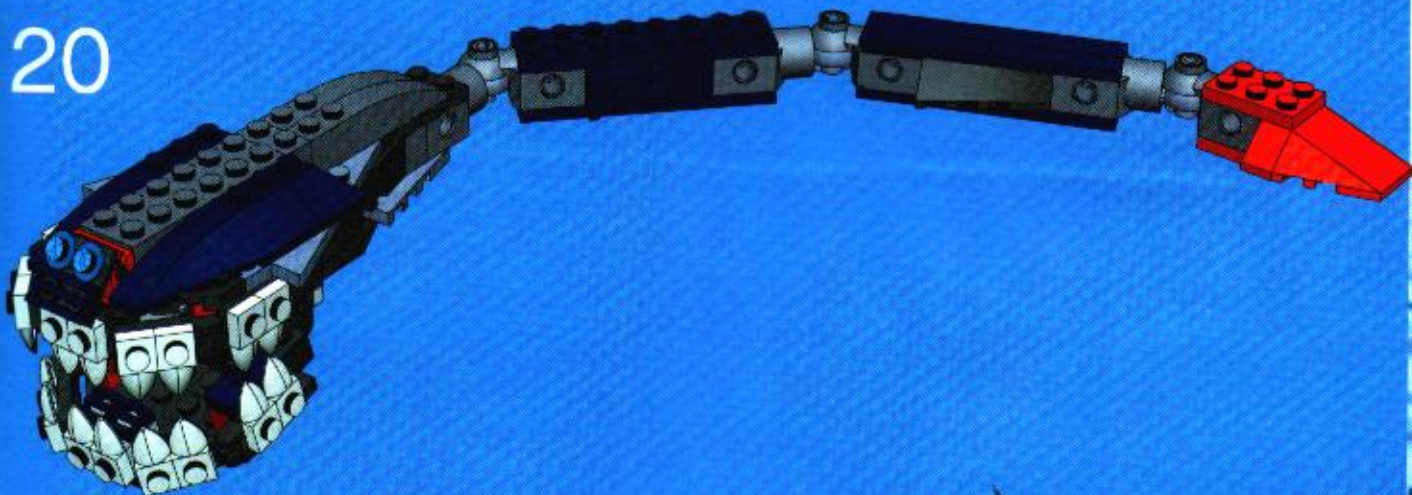

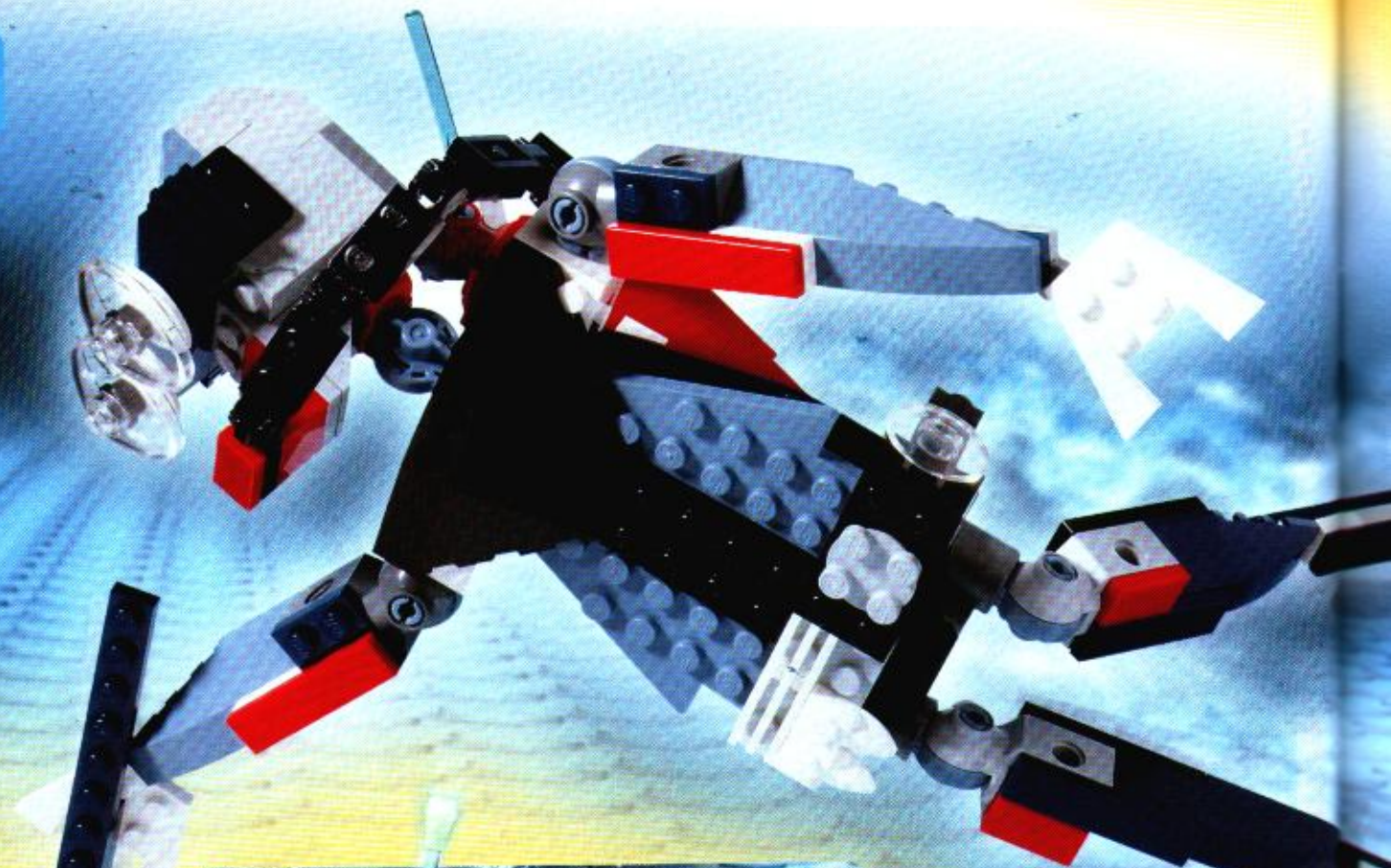

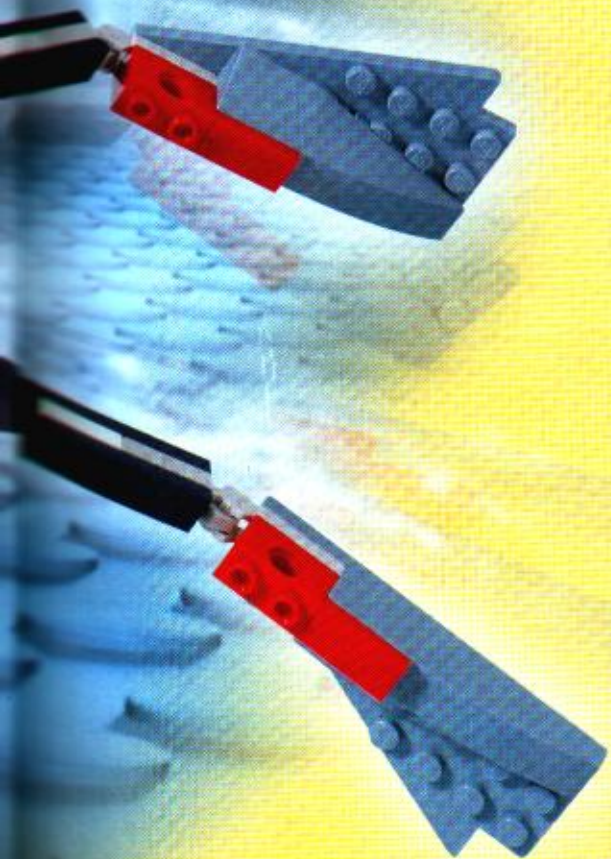

- 4x
- 4x
- 3x
- 8x
- 5x
- 1x
- 1x
- 1x
- 2x
- 2x
- 4x
- 4x
- 3x
- 2x
- 3x
- 2x
- 2x
- 2x
- 2x
- 1x
- 1x
- 1x
- 1x
- 1x
- 1x
- 1x
- 2x
- 4x
- 1x
- 1x
- 2x

- 11x
- 2x
- 1x
- 1x
- 3x
- 3x
- 1x
- 4x
- 6x
- 10x
- 2x
- 1x
- 3x
- 2x
- 1x
- 2x
- 1x
- 2x
- 1x
- 1x
- 1x
- 1x
- 1x
- 1x
- 1x
- 1x
- 4x
- 4x
- 1x
- 1x
- 1x
- 2x
- 1x
- 1x

- 1x
- 1x
- 2x
- 1x
- 2x
- 7x
- 2x
- 6x
- 2x
- 2x
- 2x
- 2x
- 1x
- 1x
- 2x
- 2x
- 1x
- 1x
- 1x
- 2x
- 2x
- 1x
- 1x
- 2x
- 2x
- 1x
- 2x
- 20x
- 2x
- 3x
- 3x
- 3x
- 3x
- 1x
- 1x
- 1x
- 1x
- 1x
- 1x
- 2x
- 2x

- 2x
- 2x
- 2x
- 2x
- 4x
- 1x
- 6x
- 2x
- 2x
- 1x
- 2x
- 2x
- 1x
- 1x
- 1x
- 1x
- 1x
- 1x
- 2x
- 1x
- 2x
- 1x
- 1x
- 1x
- 1x
- 2x
- 1x
- 2x
- 1x
- 2x
- 1x
- 2x
- 1x

- 3x
- 2x
- 2x
- 1x
- 2x
- 4x
- 2x
- 1x
- 1x
- 1x
- 4x
- 1x
- 1x
- 1x
- 2x
- 2x
- 2x
- 2x
- 2x
- 4x
- 2x
- 6x
- 2x
- 4x
- 1x
- 3x
- 4x
- 4x

- 6x
- 1x
- 1x
- 3x
- 2x
- 2x
- 1x
- 10x
- 1x
- 1x
- 1x
- 1x
- 1x
- 1x
- 1x
- 2x
- 2x
- 2x
- 2x
- 2x

Win! Gagne! Gewinne! 当たります



WIN LEGO® PRODUCTS

We would like to know what you think about our new LEGO® product. If you could help us by answering a few questions you are in with a chance of winning an exciting LEGO prize. It will only take you about 3 minutes! Log on to the web address below for further instructions.



Estimado usuario LEGO®

Al contestar algunas preguntas en inglés, francés, alemán o japonés, en el sitio www.acnielsen.aim.dk/lego, podrás participar en el sorteo de algunos valiosos premios LEGO®.



抽選でレゴ®製品が当たります

私たちは、皆さんが思い求めるレゴ®製品についてどんな感想をお持ちか、知りたいと思っています。質問に答えて、楽しいレゴ®製品の抽選に当選しませんか。アンケートの回答には、ほんの少しの労力しかかかりません。詳しくは、以下のウェブアドレスまでアクセスしてください。



GAGNE DES PRODUITS LEGO®

Nous aimerions savoir ce que tu penses de ton nouveau produit LEGO®. Si tu veux bien nous aider en répondant à quelques questions, tu recevras peut-être bientôt un fantastique prix LEGO. Et cela ne te prendra que 3 minutes environ ! Tu obtiendras davantage d'informations en visitant le site Internet indiqué ci-dessous.



Caro Consumidor da LEGO®

Ao responder a algumas perguntas em Inglês, Francês, Alemão ou Japonês no endereço www.acnielsen.aim.dk/lego irá participar num concurso para ganhar valiosos prémios da LEGO®.



GEWINNE LEGO® PRODUKTE

Wir sind sehr an deiner Meinung über dein neues LEGO® Produkt interessiert. Wenn du uns den Gefallen tust und ein paar Fragen beantwortest, kannst du einen tollen LEGO Preis gewinnen. Das Ganze dauert nur etwa 3 Minuten! Gehe einfach zu der unten angegebenen Webadresse - dort findest du weitere Informationen.



Kedves Ifjú LEGO® Vásárló

Ha ellátogatasz a www.acnielsen.aim.dk/lego honlapra és ott angol, francia, német vagy japán nyelven megválaszolsz néhány kérdést, akkor részt veszel egy versenyben, amelyben értékes LEGO® díjakat nyerhetsz.

www.acnielsen.aim.dk/LEGO



LEGO

Designer Set



4505



4508



4507

©2004 The LEGO Group.

4248529



www.LEGO.com/create