

The LEGO logo is displayed in its characteristic white font with a yellow outline, set against a red square background.The word "SPORTS" is written in a bold, red, stylized font with a slight shadow effect, positioned horizontally across the top of the image.The number "3440" is printed in a large, white, sans-serif font in the upper right corner of the advertisement.A white rectangular box containing a warning symbol (a triangle with an exclamation mark) and the text: "WARNING: CHOKING HAZARD. Toy contains small parts and a small ball. Not for children under 3 years."The product number "4195750" is printed in a small, black, sans-serif font in the bottom left corner.The NBA logo, featuring a silhouette of a basketball player in a red jersey, is positioned to the left of the word "NBA" in a large, bold, red, sans-serif font.



3432



3427



3430



3431



3428



3429



3433

3560



3561



3562



3563



3564



3565



3566



3567



⚠️ AVERTISSEMENT : RISQUE D'ÉTOUFFEMENT.
Le jouet contient des petites pièces ainsi qu'une petite boule.
Il ne convient pas aux enfants de moins de 3 ans.

⚠️ ADVERTENCIA: PELIGRO DE ASFIXIA.
Juguete que contiene partes pequeñas y una pelota pequeña.
No recomendado para niños menores de 3 años.

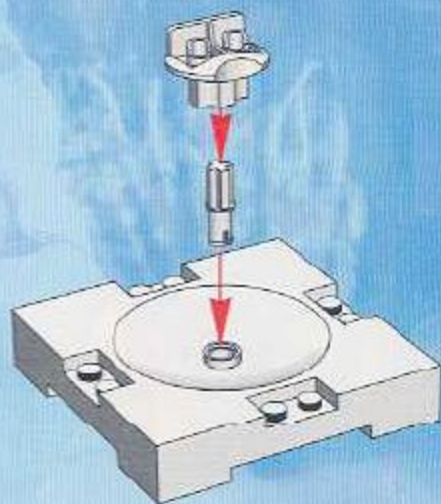

2

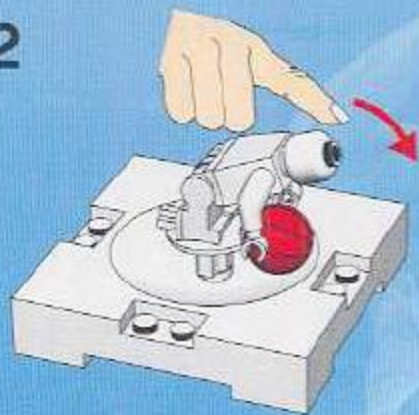

3

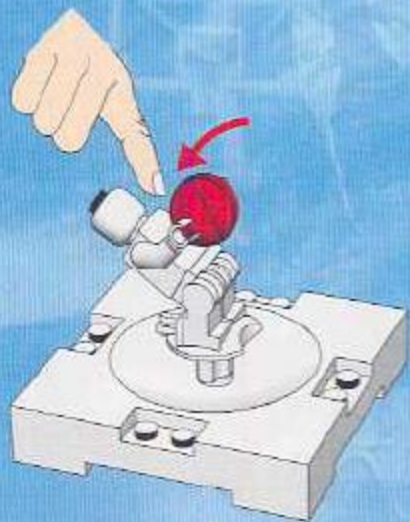

4

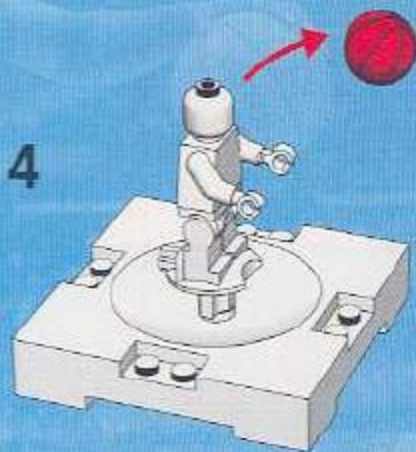

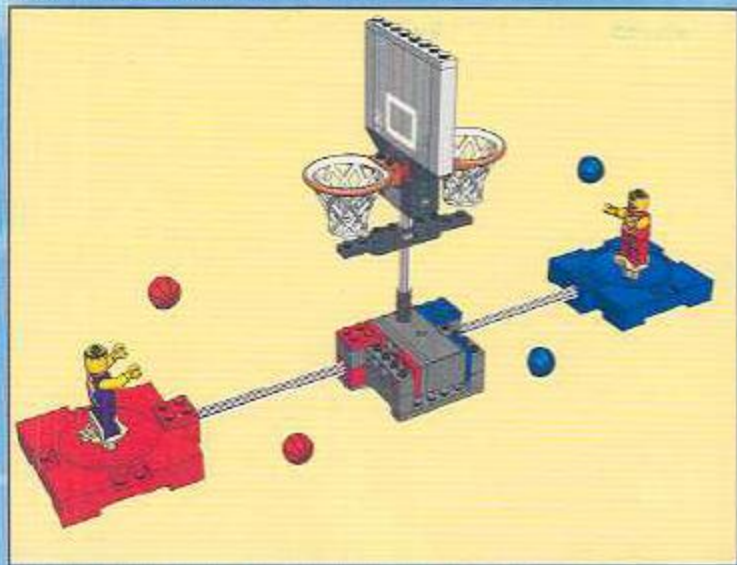

1



2

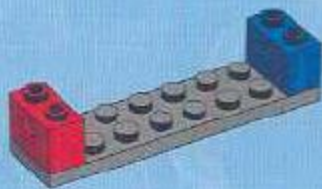

3

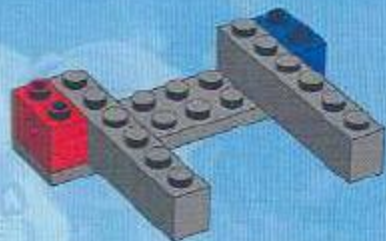

4

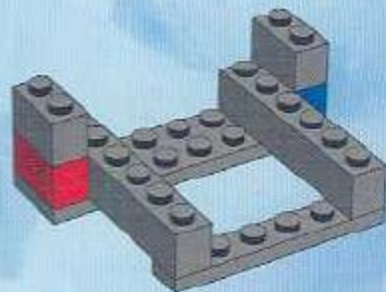

1

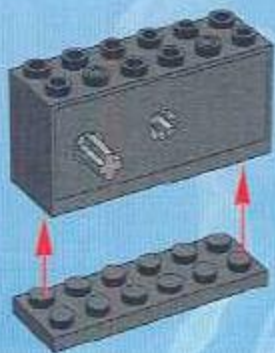

2

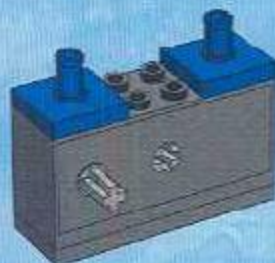

3

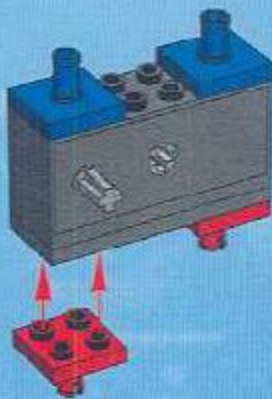

4

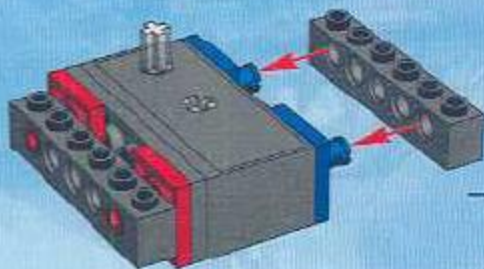

5

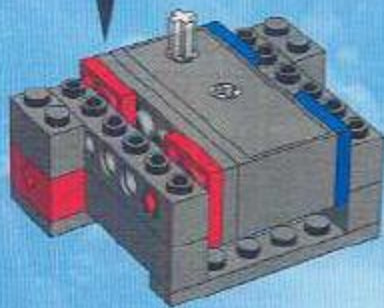

6

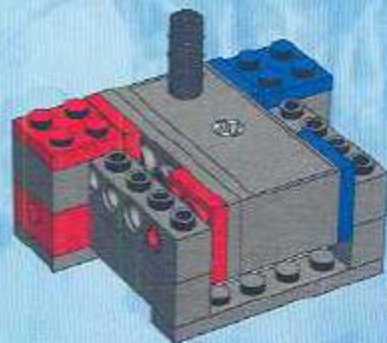

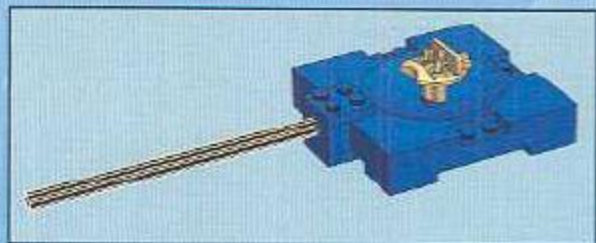

1

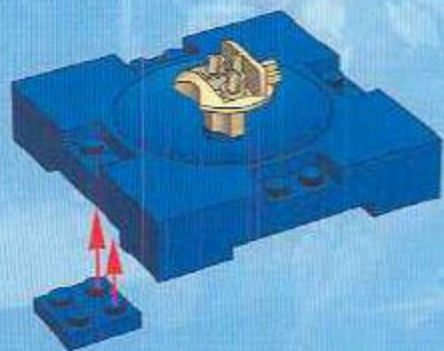

2

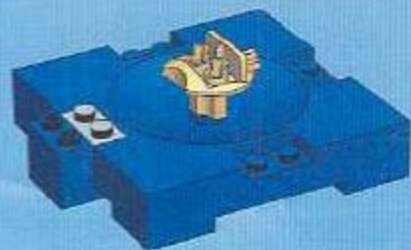

3

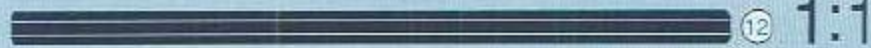
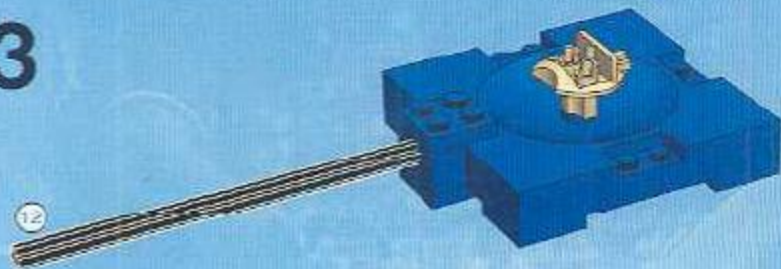

7

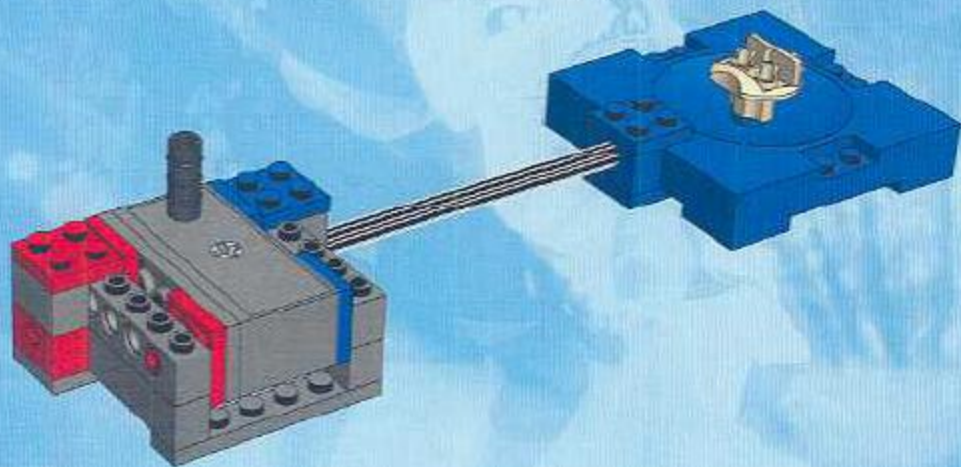

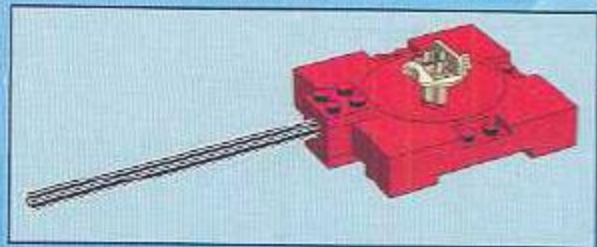

2

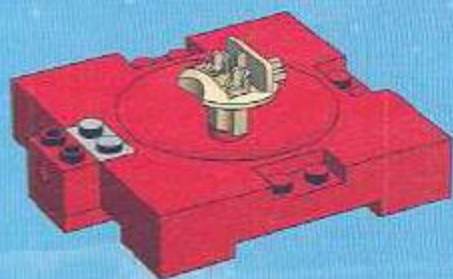

3

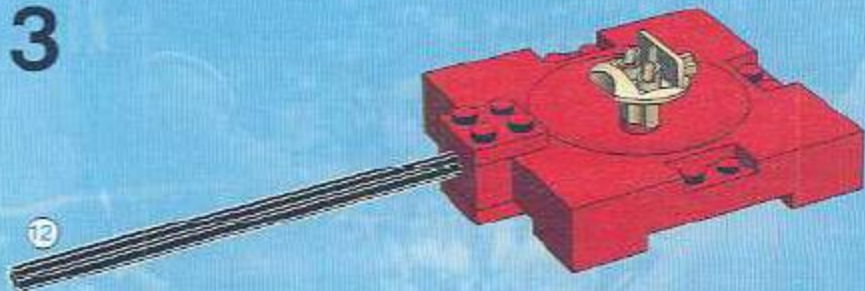

8

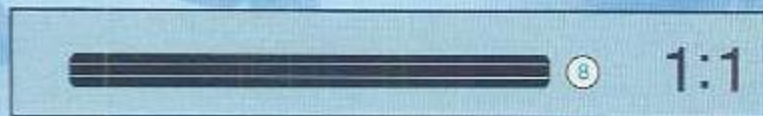
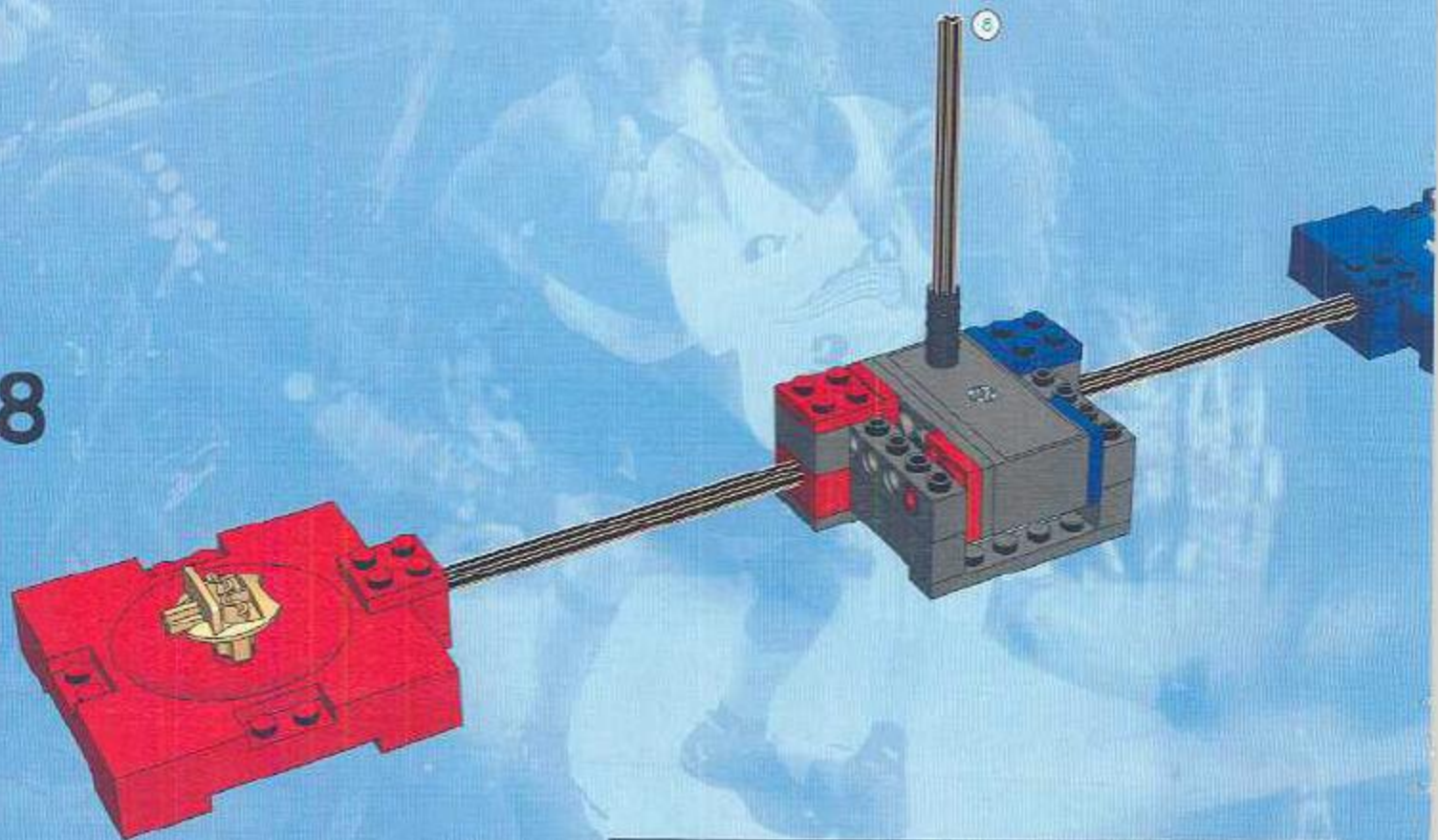

1



2

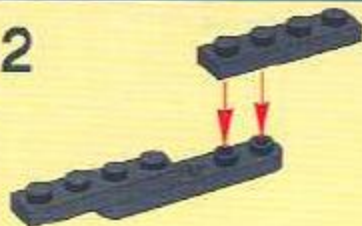

3



9

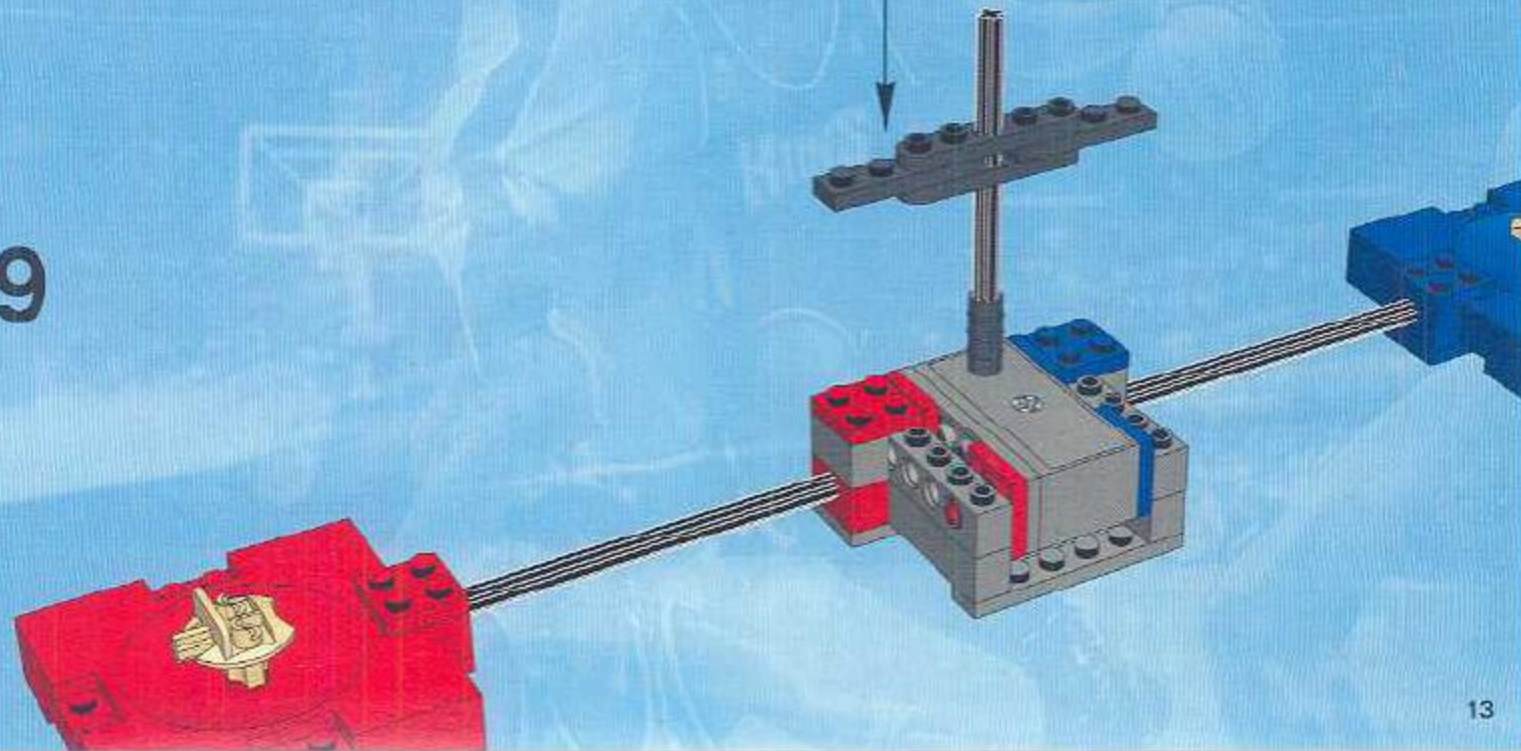



1

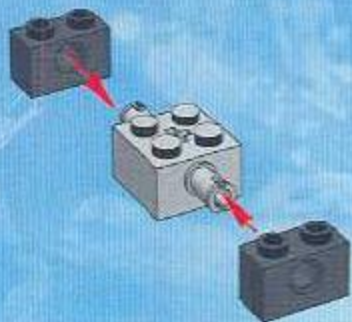

2



3



4



5



6

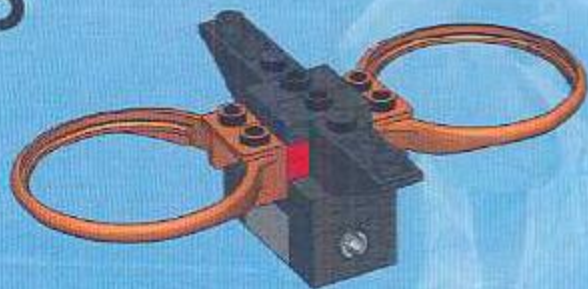

7



8

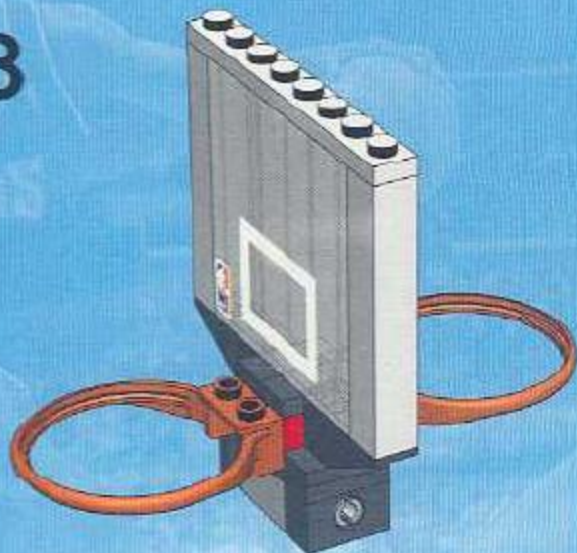

9



10

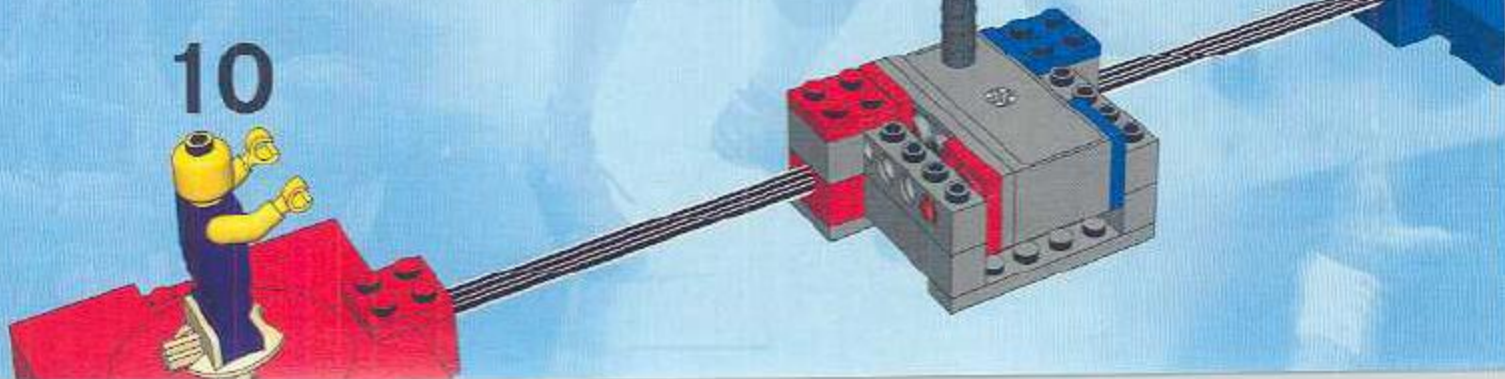

11

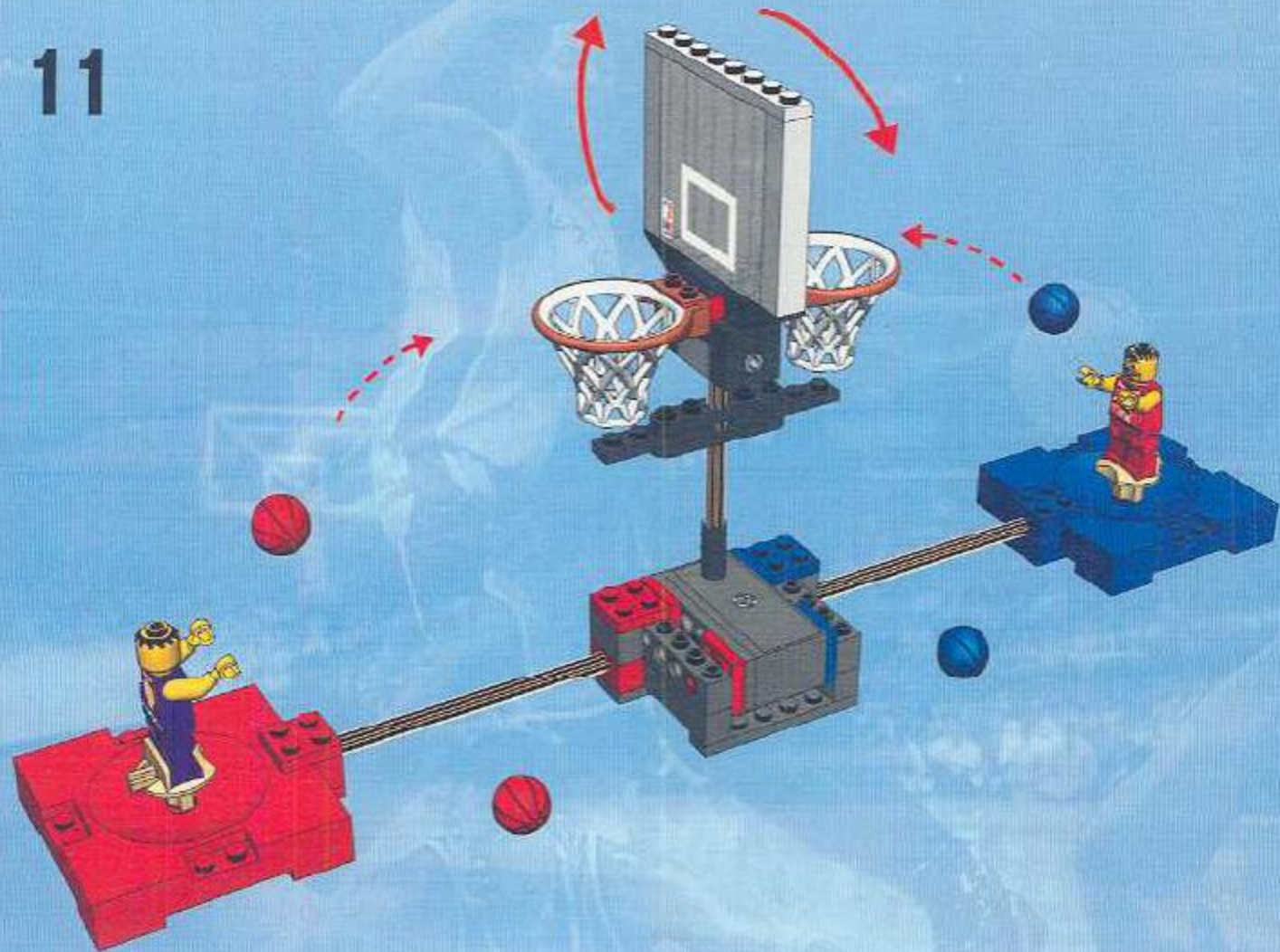



LEGO



www.LEGO.com

NBA.COM

NBA





1

3431+3430

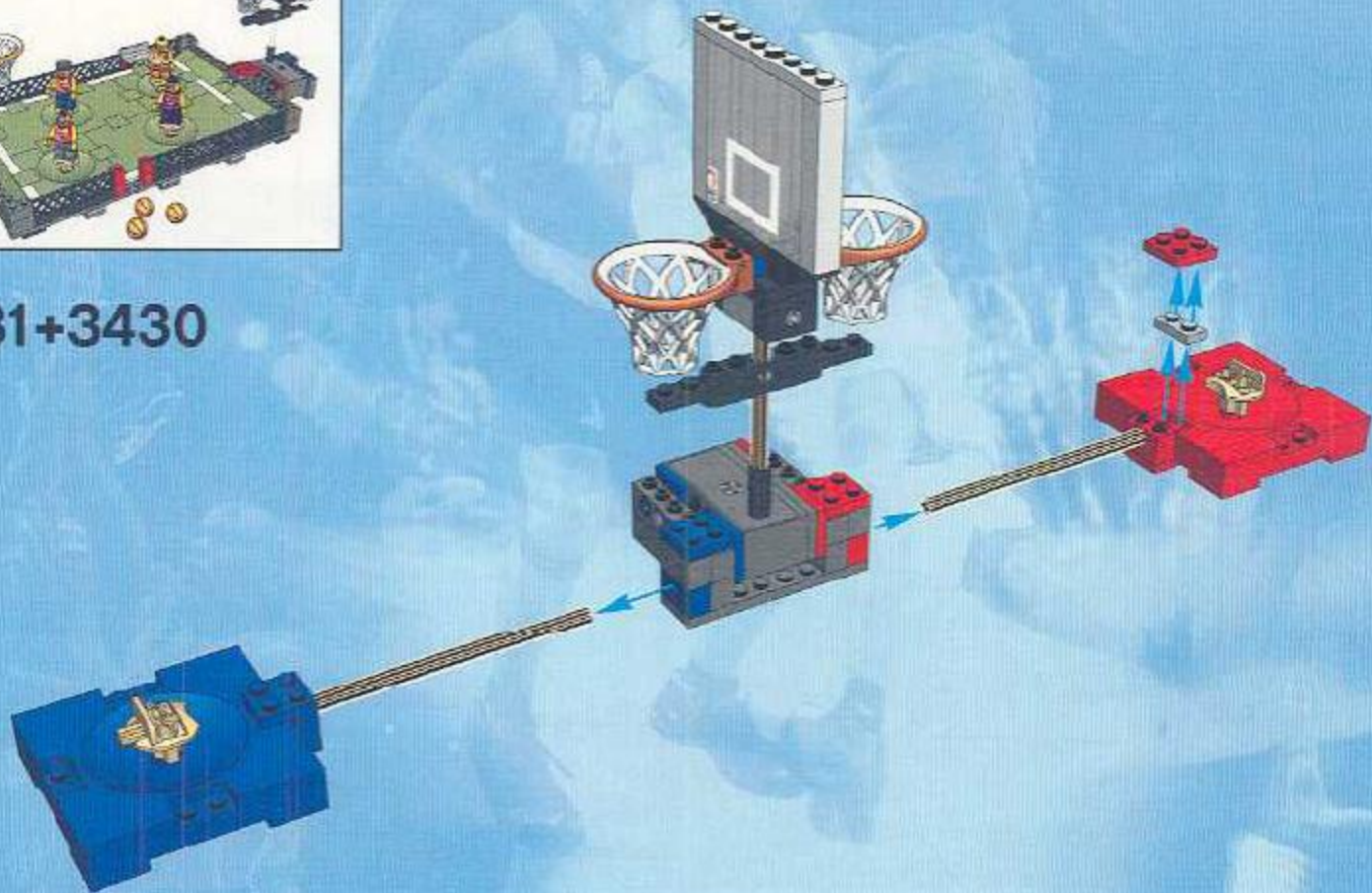

2



3



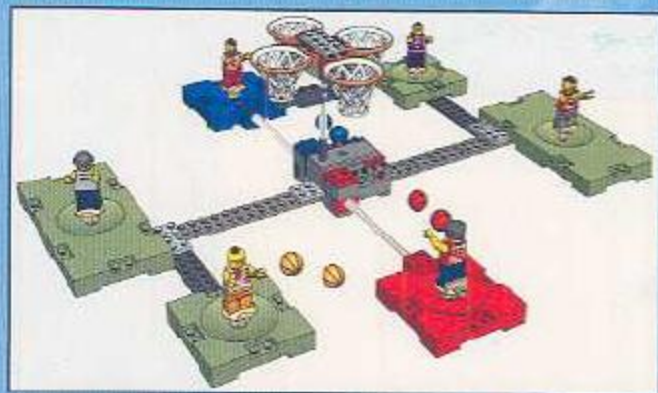

1

3431+3430

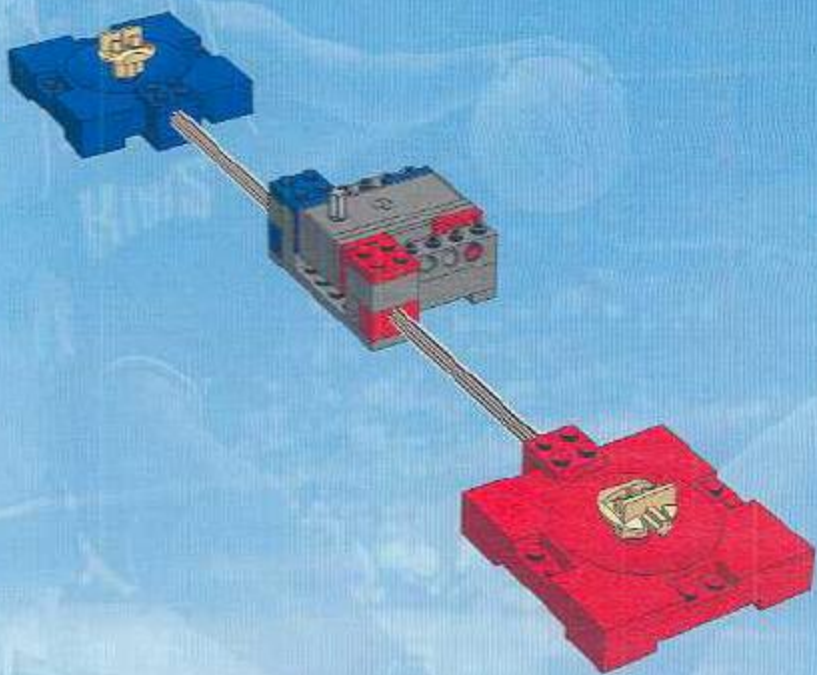

1

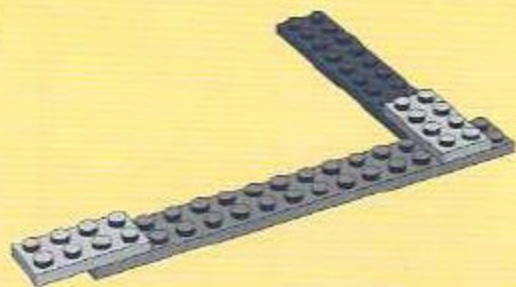

2

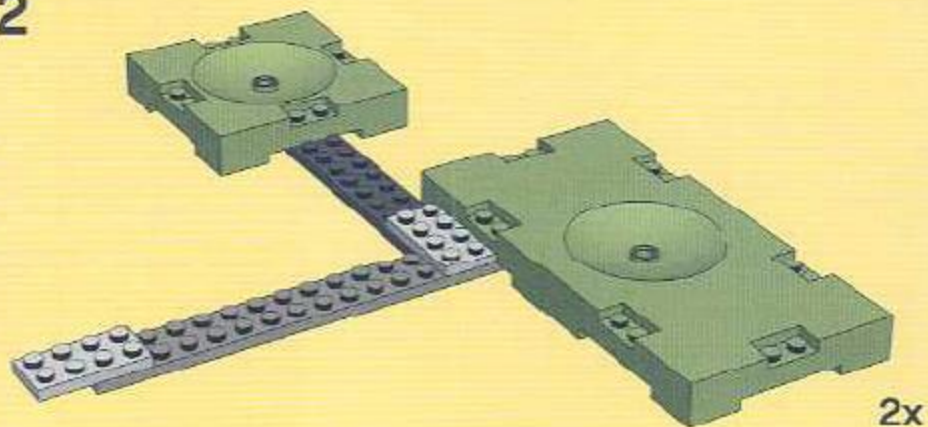

2x

2



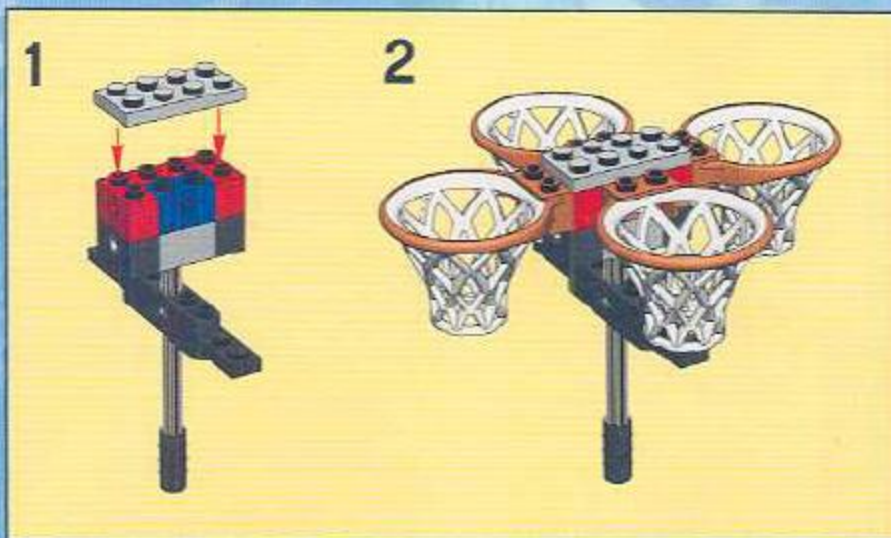

3

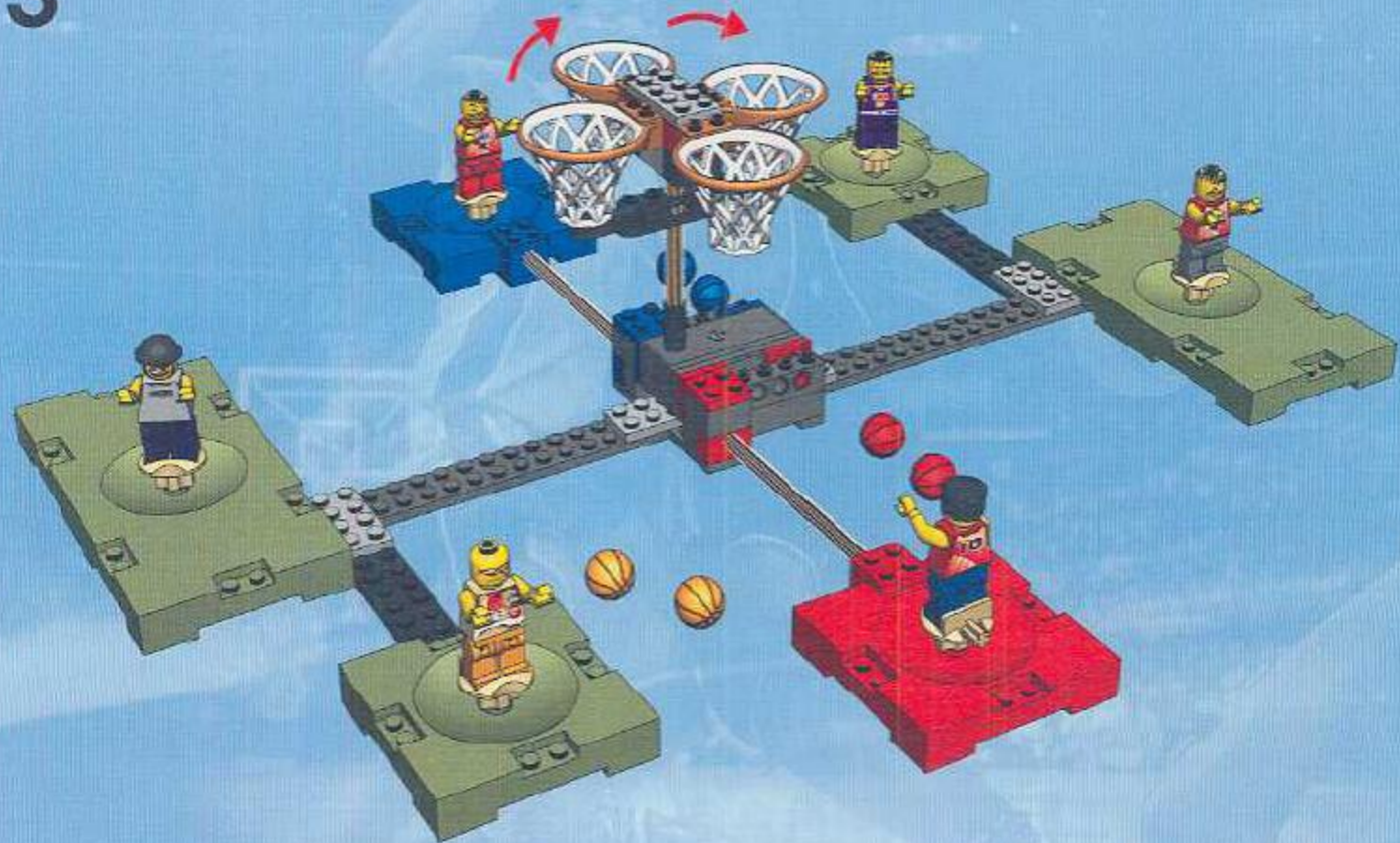

LEGO

SPORTS

adidas, the adidas logo and the three stripe trademark are registered trademarks of the adidas-Salomon group, used with permission. Ferrovio and the Trigon logo are trademarks of the adidas-Salomon group, used with permission.

adidas, le logo adidas et la marque aux trois bandes sont des marques déposées du groupe adidas-Salomon, utilisées avec sa permission. Ferrovio et le logo Trigon sont des marques déposées du groupe adidas-Salomon, utilisées avec sa permission.

adidas, el logotipo adidas y el símbolo de tres bandas son marcas registradas del grupo adidas-Salomon y se utilizan con autorización. Ferrovio y el logotipo Trigon son marcas registradas del grupo adidas-Salomon y se utilizan con autorización.

SPALDING is a trademark of/est une marque de commerce de/és una marca registrada de Spalding Sports Worldwide, Inc. or/ou Lisco Sports, Inc. a Spalding affiliate/une filiale de Spalding/un afiliado de Spalding/Spalding Sports Worldwide.

NBA identifications depicted are the exclusive property of NBA Properties, Inc. and/or the NBA Member Teams, and are used with permission.

Les identifications NBA reproduites sont la propriété exclusive de NBA Properties, Inc. et/ou des équipes membres de la NBA, et sont reproduites sous autorisation.

Las identificaciones retratadas de la NBA son propiedad exclusiva de NBA Properties, Inc. y/o de los miembros de los equipos de la NBA, y son usadas

LEGO and the LEGO logo are trademarks of/est une marque de commerce de/son marcas registradas de LEGO Group.



www.LEGO.com

