



DREAMZZZ

40657





 **FR**
DONNEZ
OU
RECYCLEZ

 OU  OU 

ASSOCIATION MAGASIN DÉCHÈTERIE

Adresses sur quefairedemesdechets.fr



LEGO.com/sustainable-packaging



BUILDER



Apple and the Apple logo are trademarks of Apple Inc., registered in the U.S. and other countries and regions. App Store is a service mark of Apple Inc. Google Play and the Google Play logo are trademarks of Google LLC. Tencent and the Tencent logo are trademarks of Tencent Inc.

Q [LEGO.com/devicecheck](https://www.lego.com/devicecheck)

EN Ask parents' permission before going online | **DE** Eltern um Erlaubnis bitten, bevor du online gehst | **FR** Demande l'autorisation d'un parent avant d'aller en ligne | **IT** Chiedi il permesso ai tuoi genitori prima di andare online | **ES** Pídeles permiso a tus papás antes de conectarte a Internet | **PT** Peça autorização aos pais antes de acederes online | **ZH** 上网前应先征得父母的同意 | **PL** Poproś rodziców o zgodę, zanim wejdiesz do Internetu | **CS** Než půjdeš na internet, požádej rodiče o svolení | **SK** Skôr než pôjdeš na internet, vypýtaj si povolenie od rodičov | **HU** Kérj szülői engedélyt, mielőtt online csatlakoznál! | **RO** Cere permisiunea părinților înainte de a te conecta online | **BG** Поискайте разрешение от родител, преди да влезете онлайн | **LV** Pirms došanās tiešsaistē palūdz atļauju vecākiem | **ET** Enne Interneti kasutamist küsi vanematelt luba | **LT** Prieš prisijungdami prie interneto, atsilkauskite tėvų





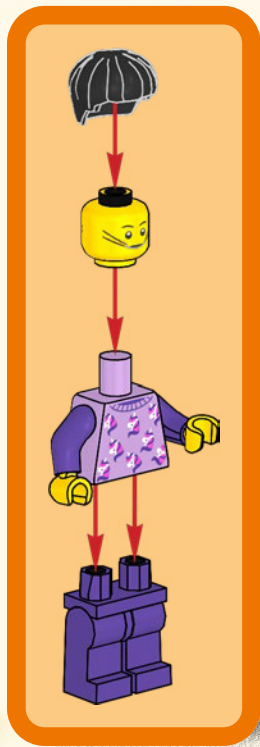





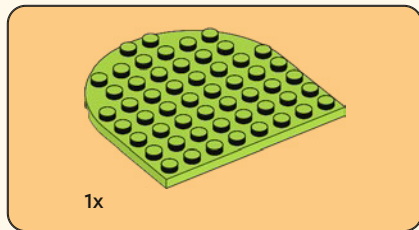
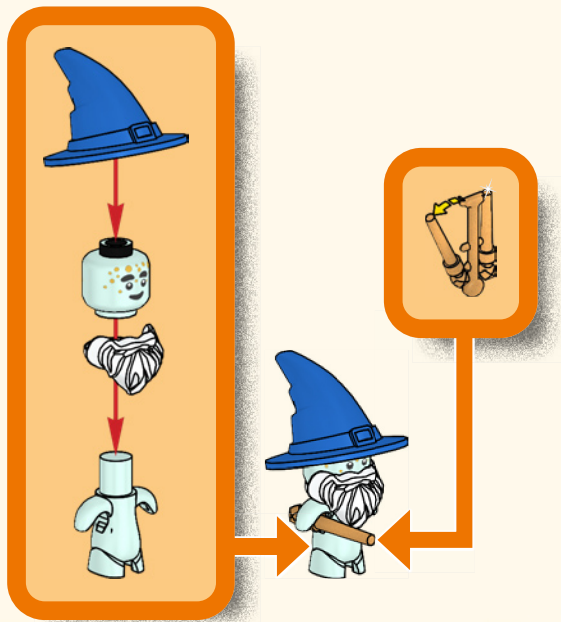

1

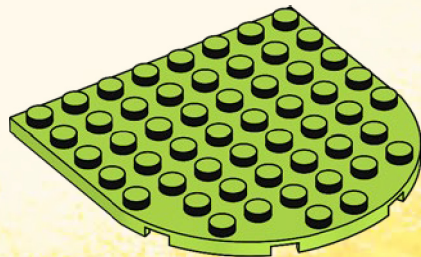



2

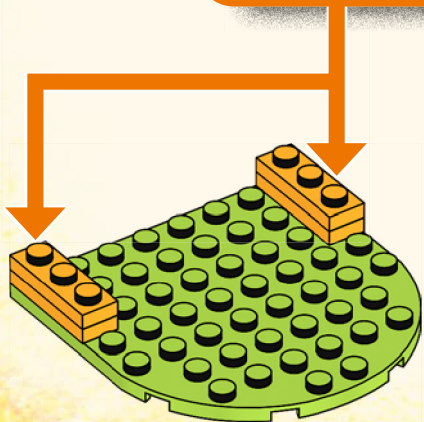
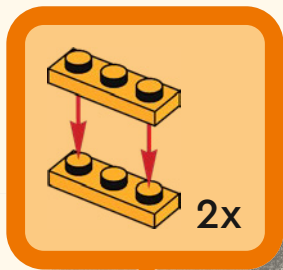

3

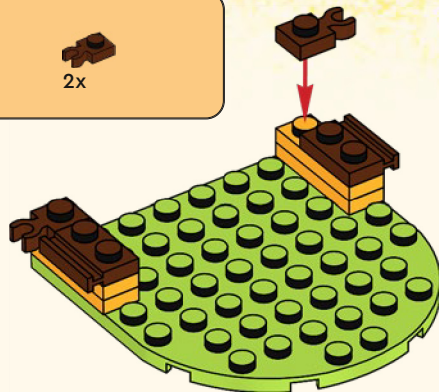

4

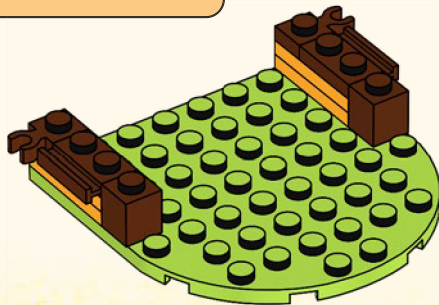



4x



2x

5

1



2



2x

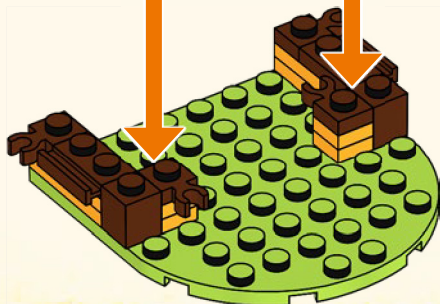

2x



2x

6

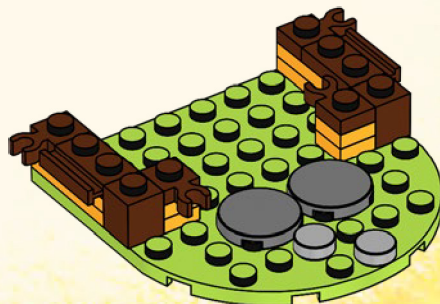

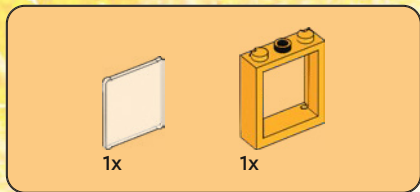

7

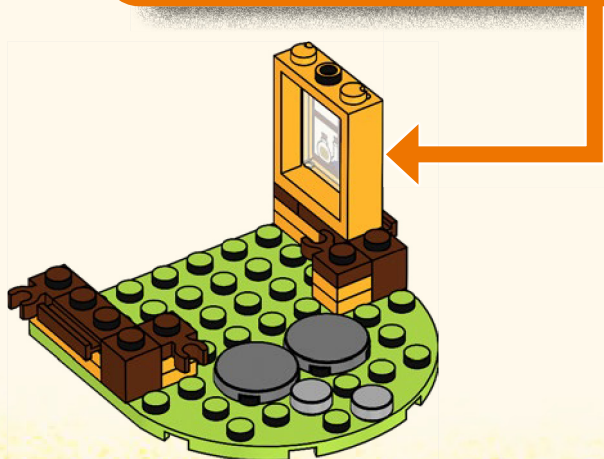
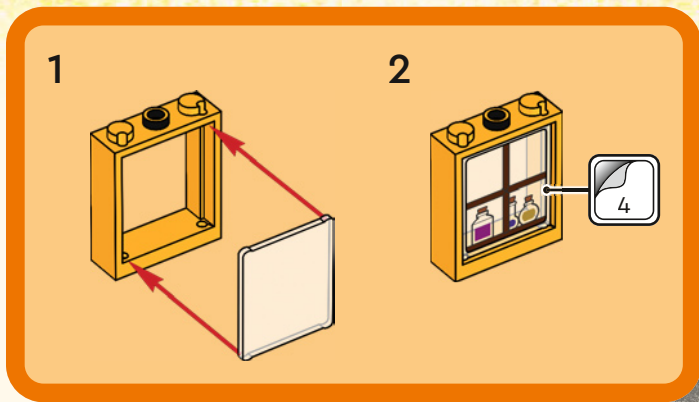

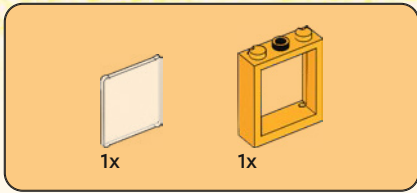

8

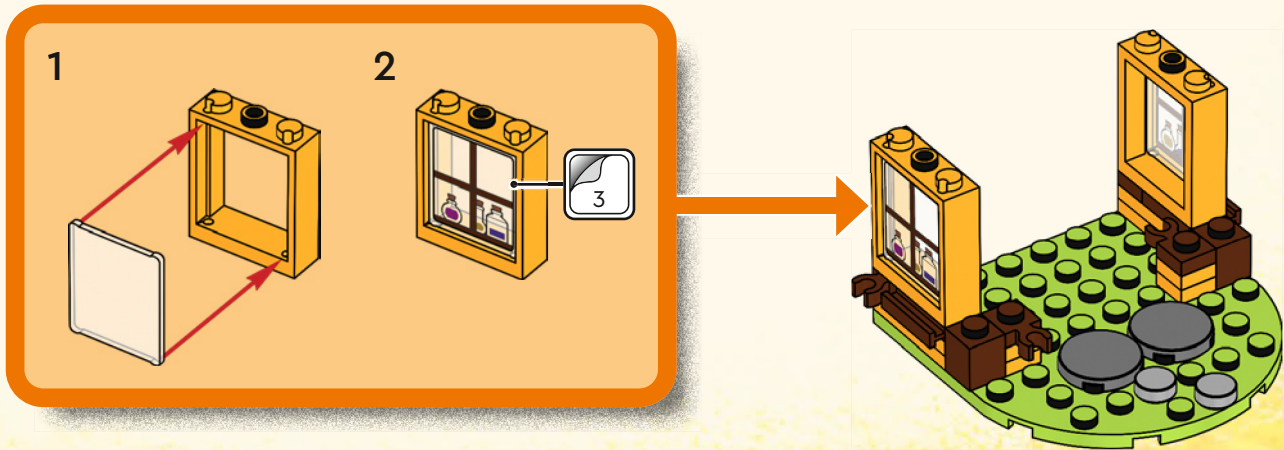



9

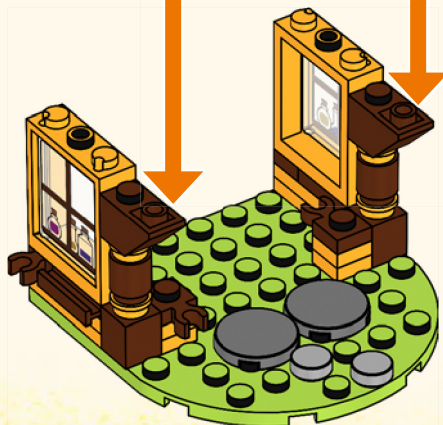
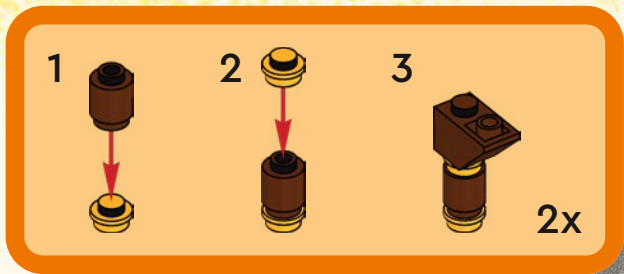



2x



4x



2x

10

1



2



3



2x

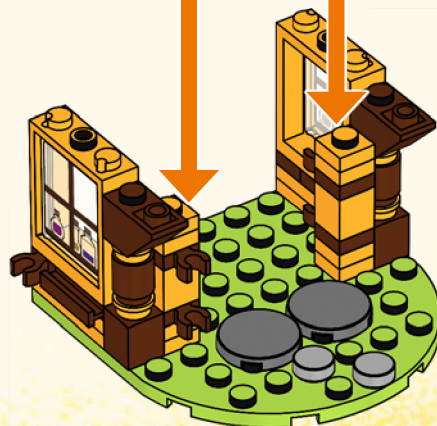

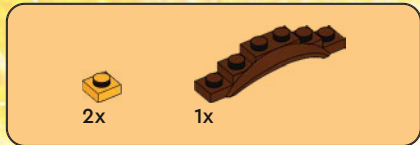

11

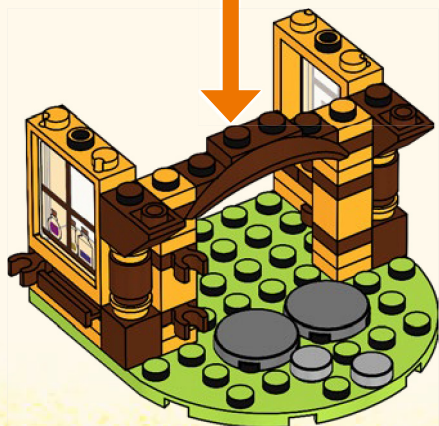
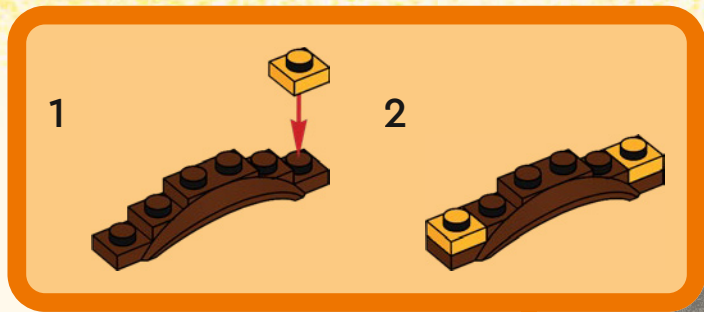



2x

12

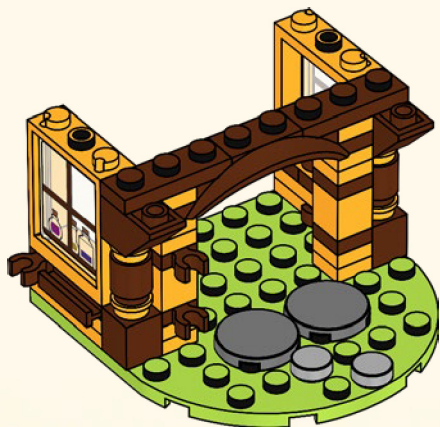

1x



2x

13





2x



2x

14

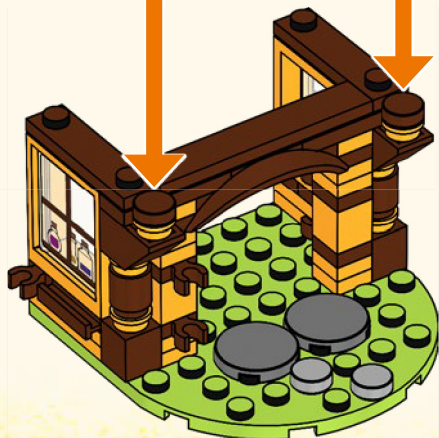
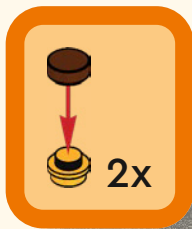

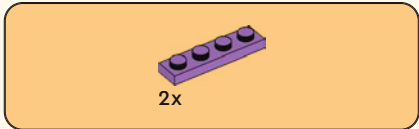

15

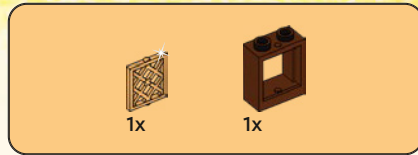
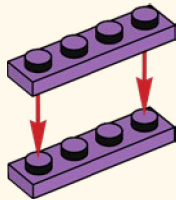

16

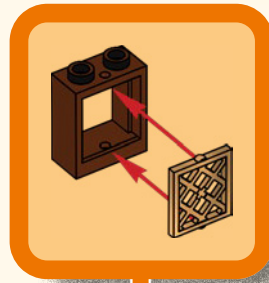



17

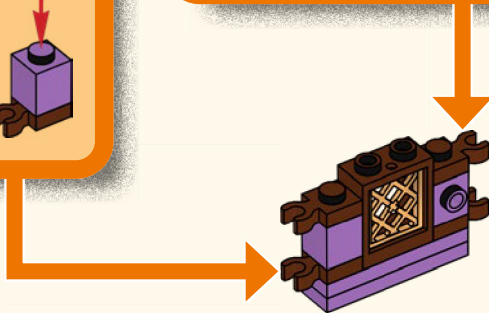
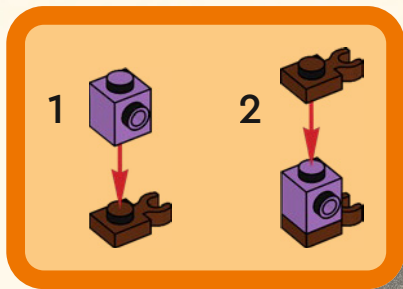
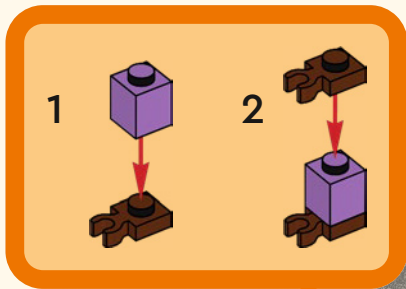



18

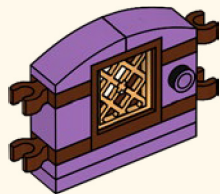

19

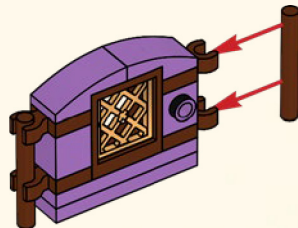



1x

20

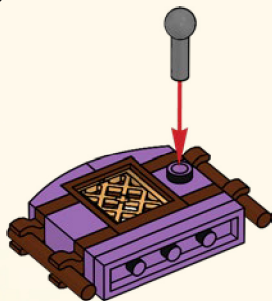

21

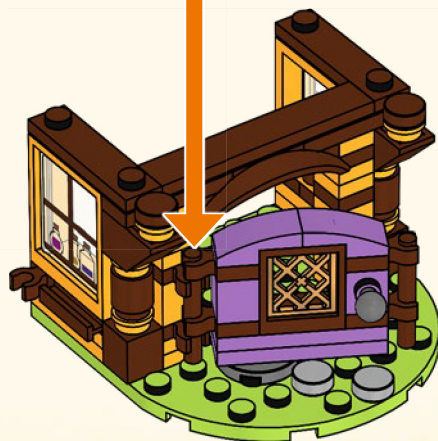



1x

22

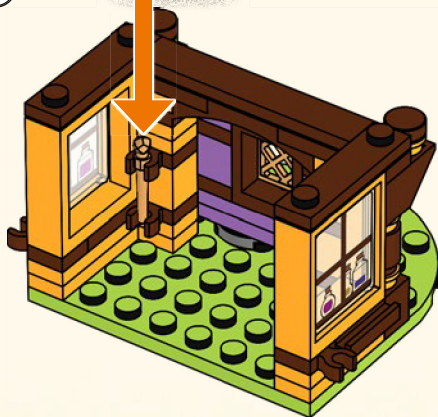

1x



1x

23





1x

24



24



1x



1x

25





2x



1x

26

1



2



2x

27

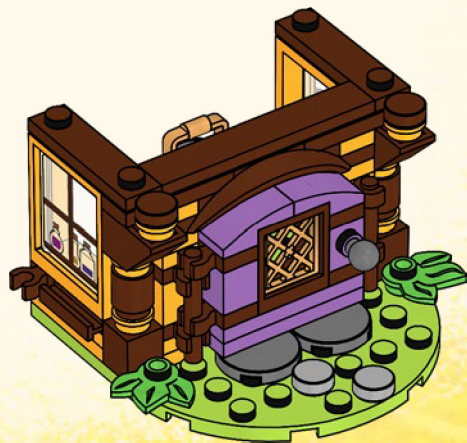

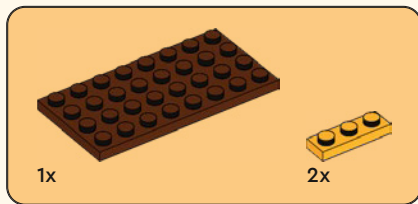
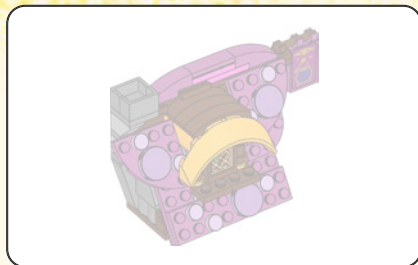

1

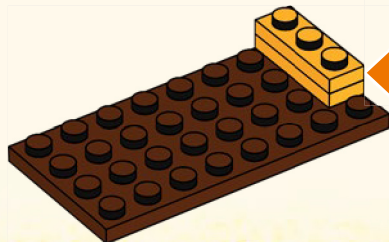
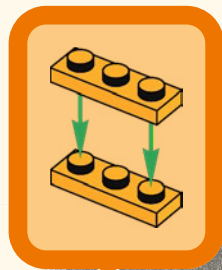



2x

2

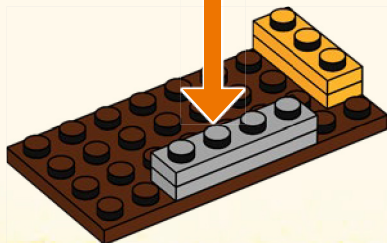
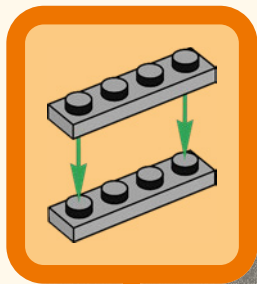

2x



2x

3

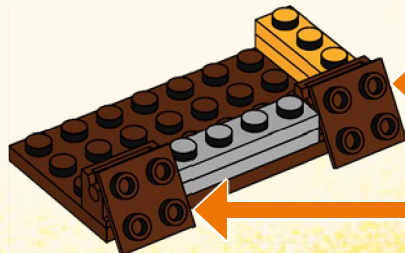

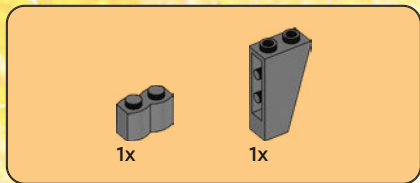

4

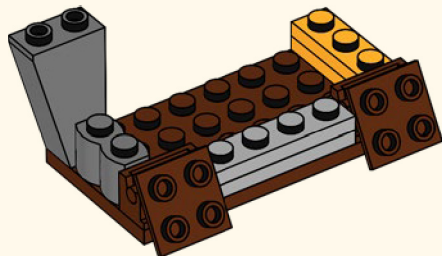



5

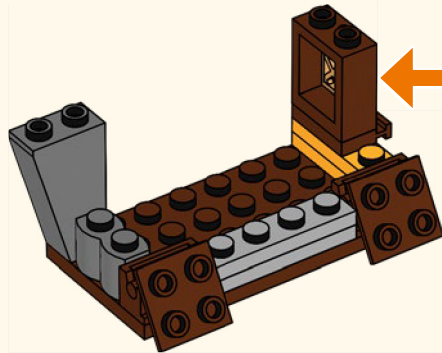
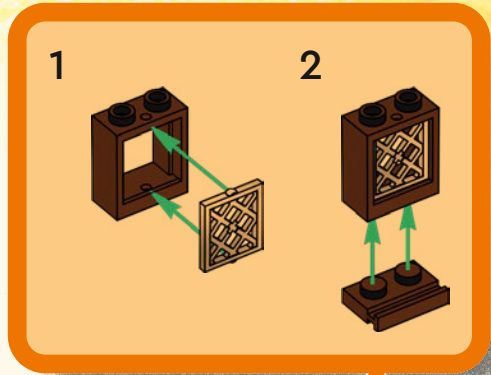



1x



1x

6

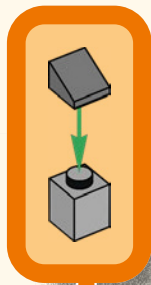
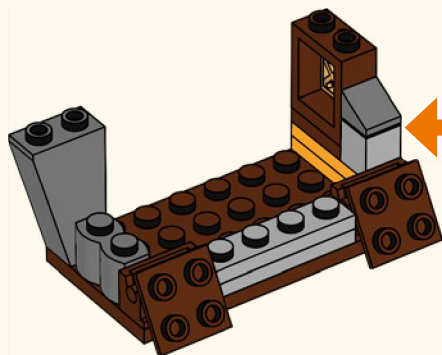



1x



1x



1x

7

1

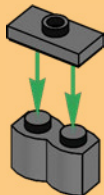

2

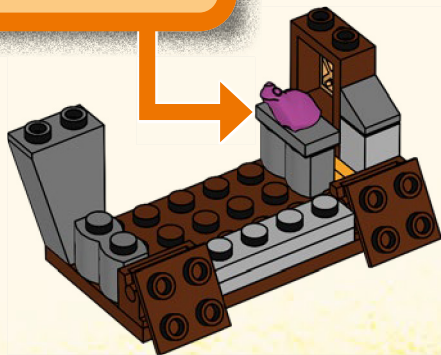



1x



1x



1x



1x

8

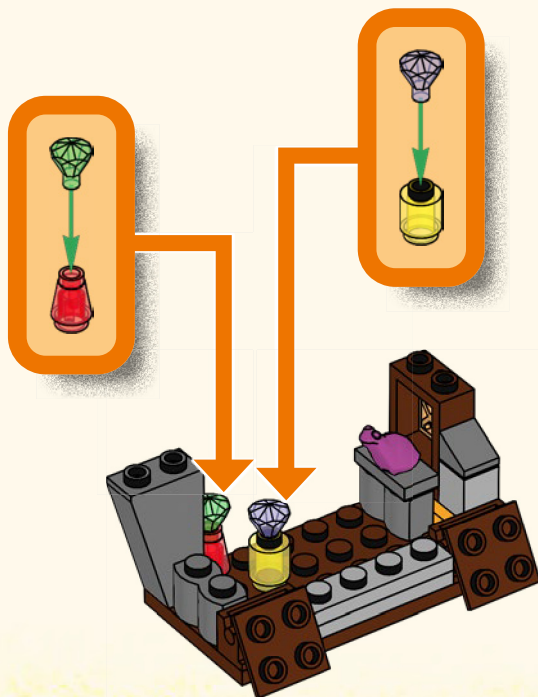

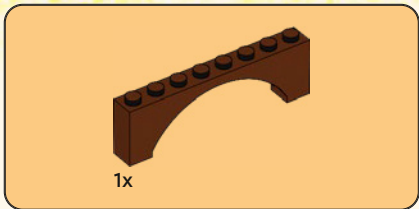

9

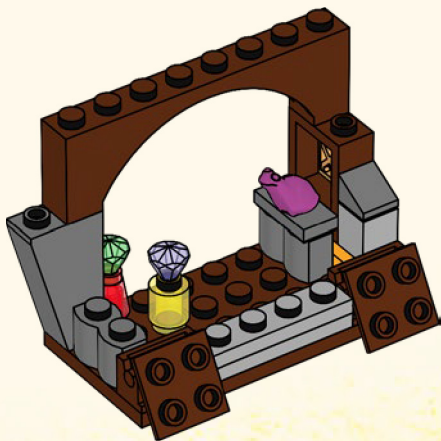



2x



1x

10

1

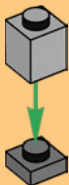

2

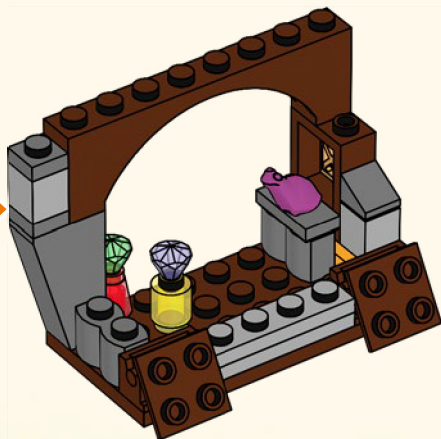
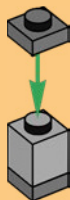

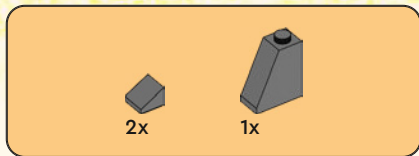

11

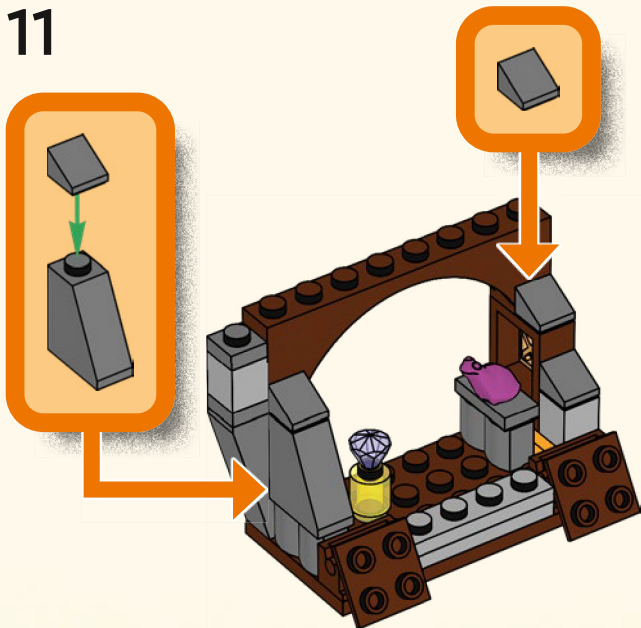

12

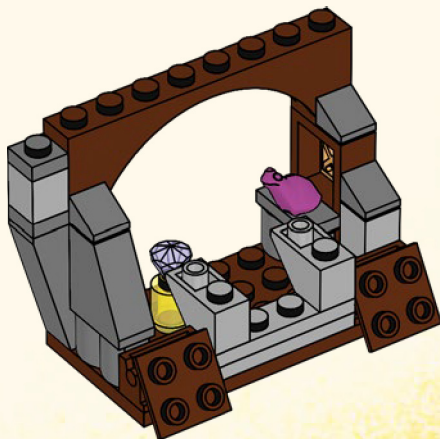

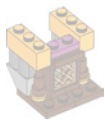

2x

13

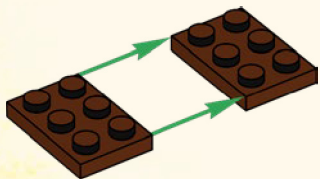

1x



1x

14





2x



2x

15

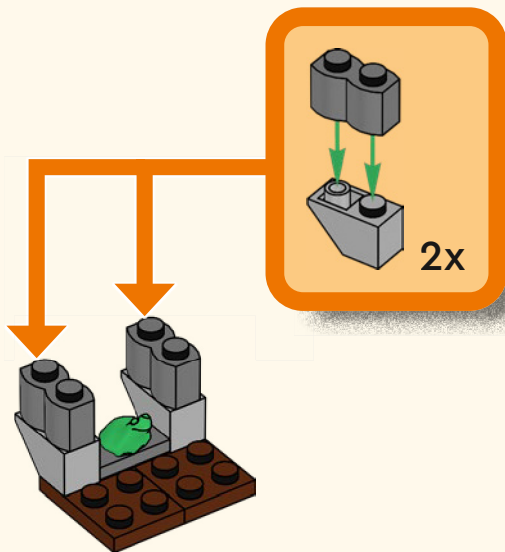

1x



1x

16

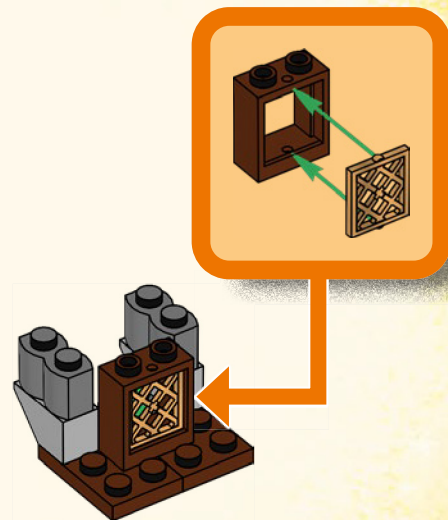



2x



2x

17

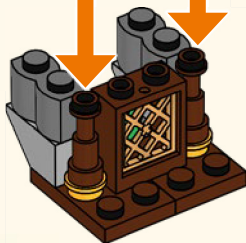

1x



1x

18

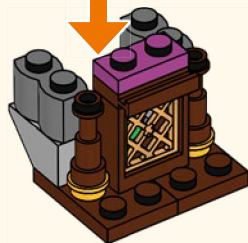

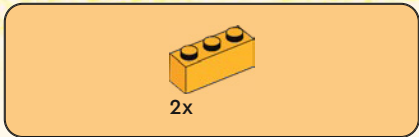

19

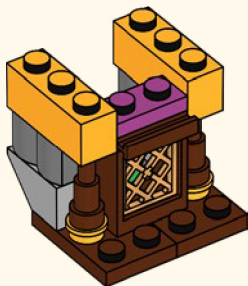

20

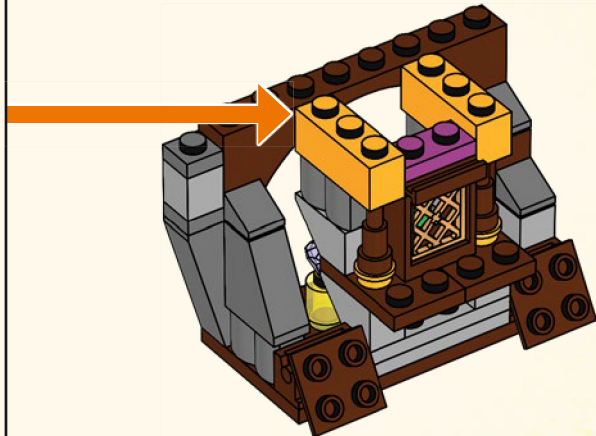



21

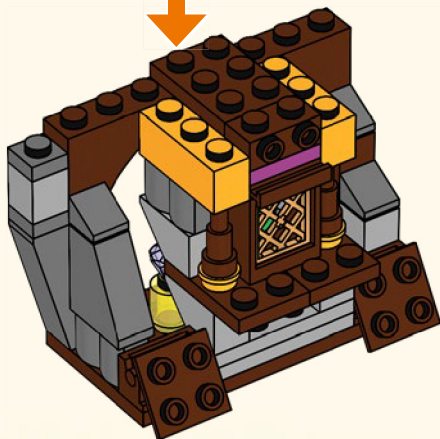



3x

22

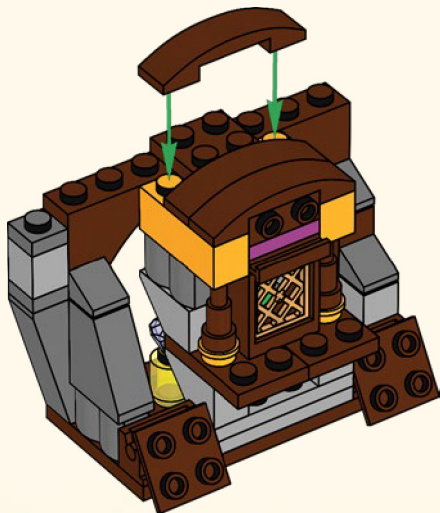

1x

23

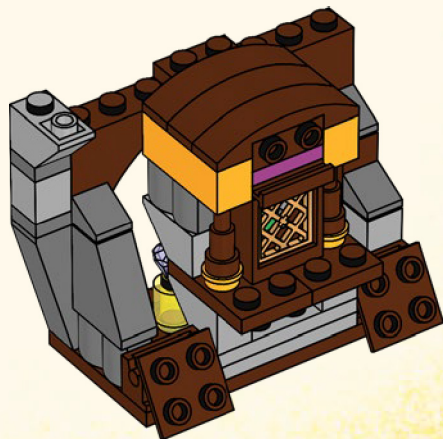

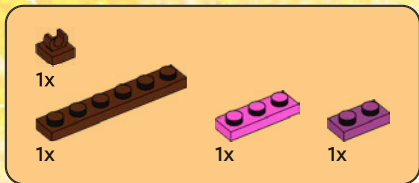

24

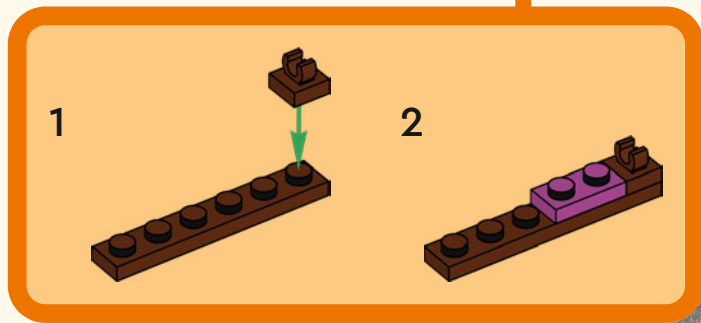
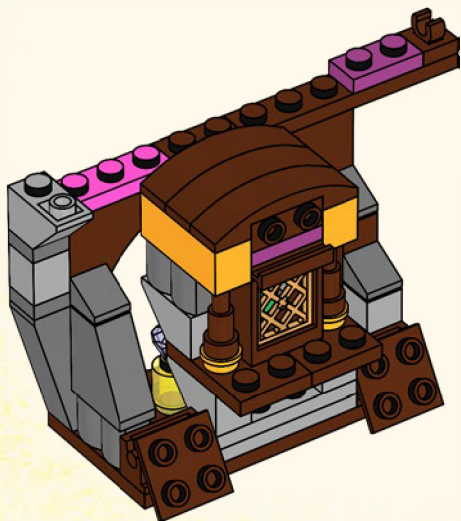



25

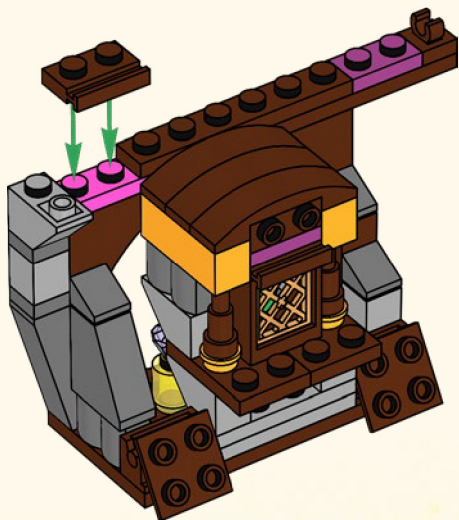



1x



1x



1x

26

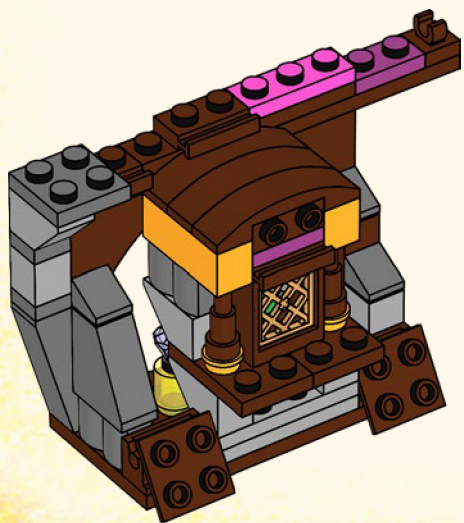

2x

27

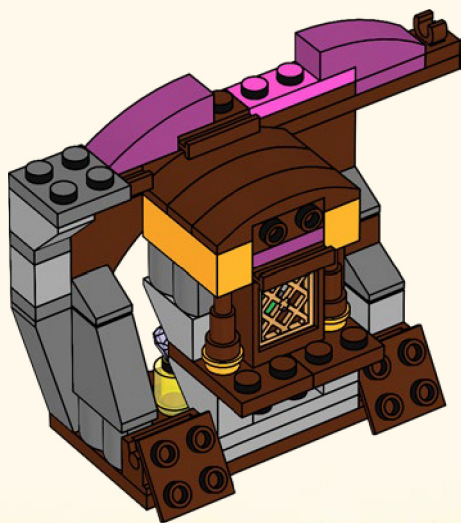



1x



1x

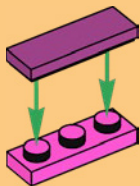

28

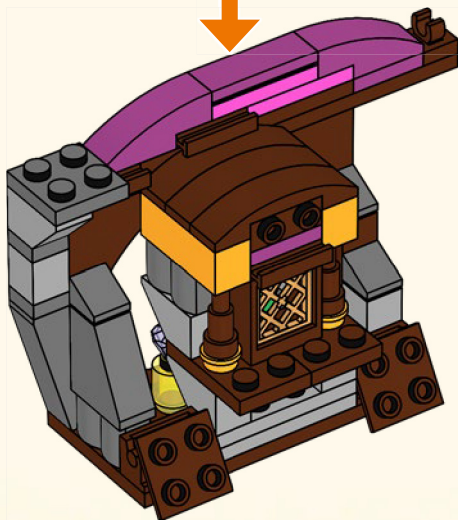

2x

29

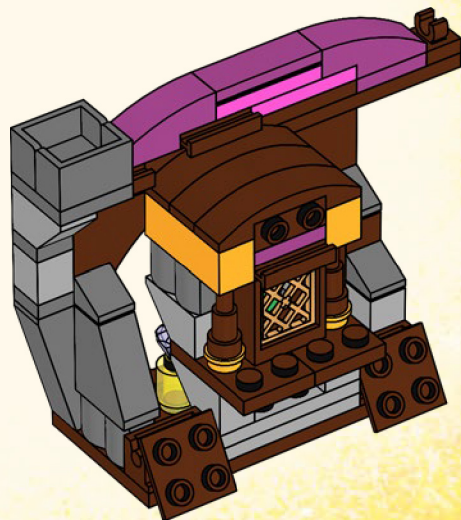

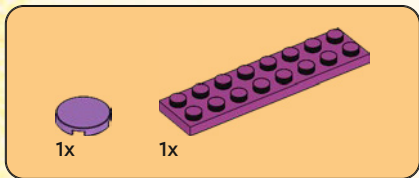
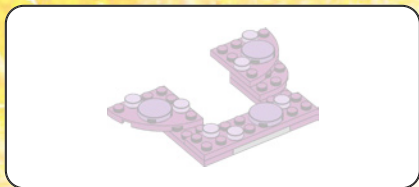

30

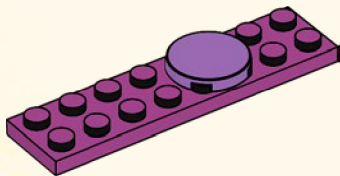

31

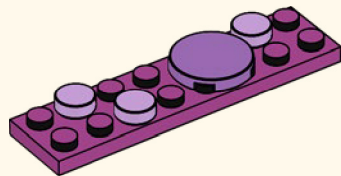



2x

32

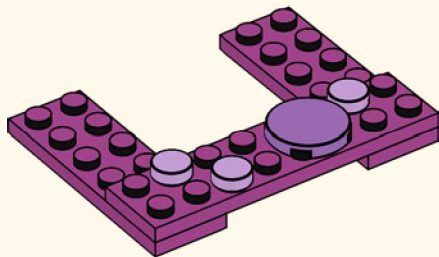

1x

33

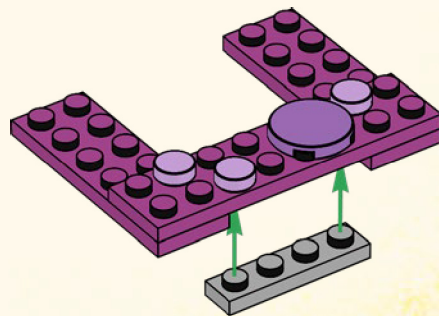



1x

34

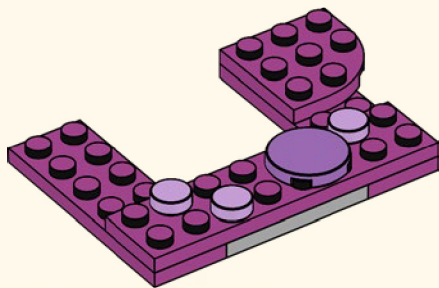

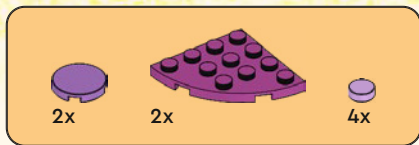

35

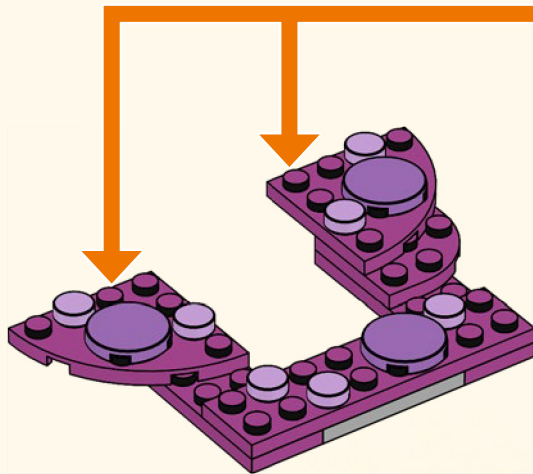
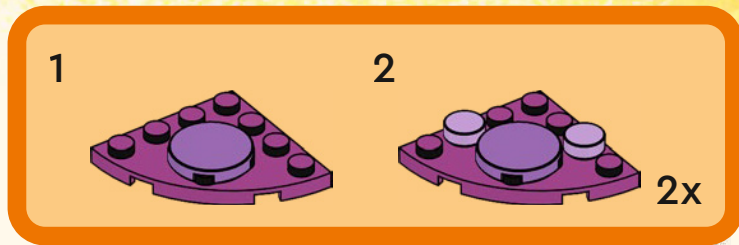

36

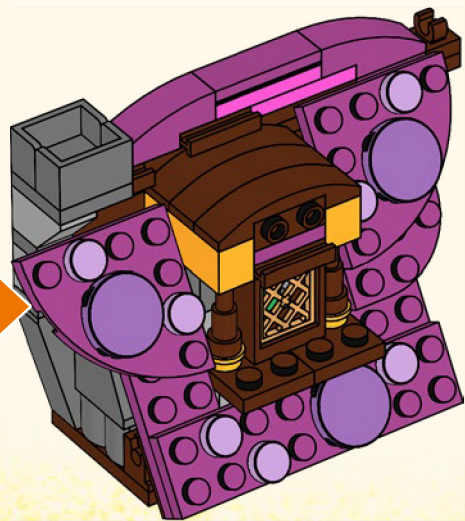

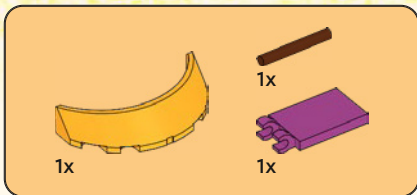

37

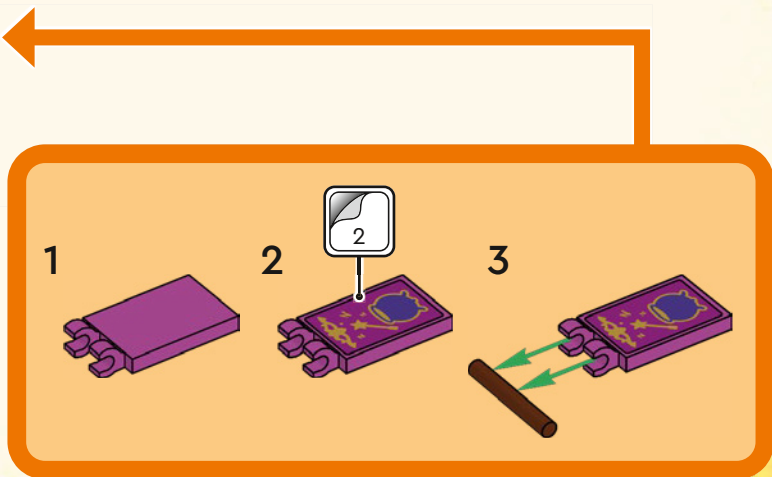
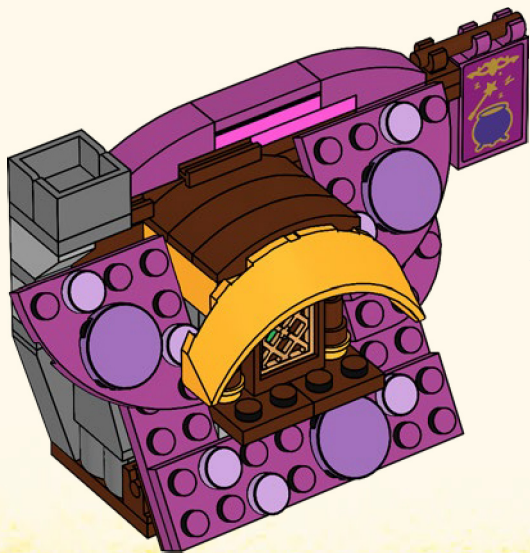



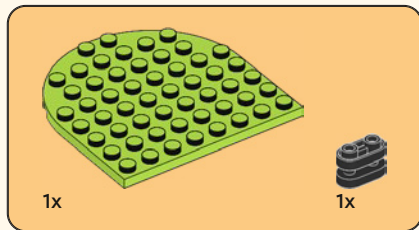
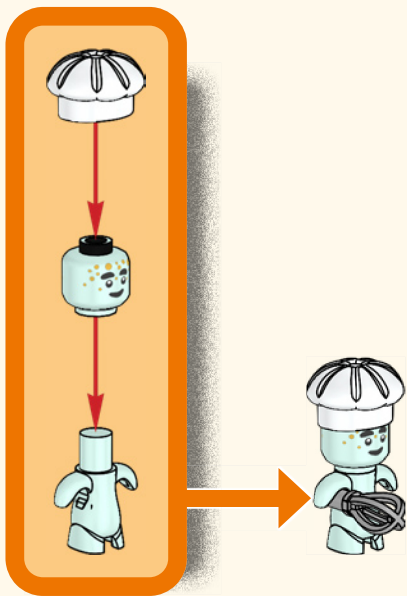

1

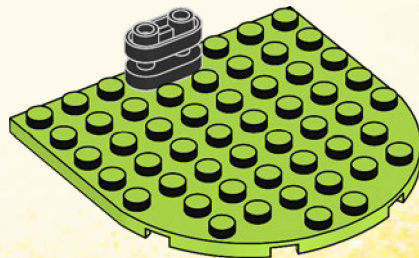



1x

2

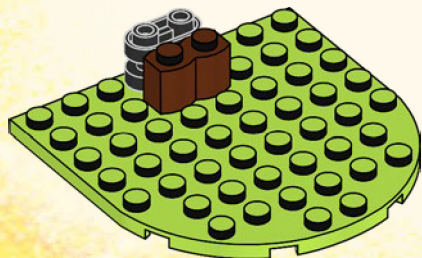

1x



1x

3

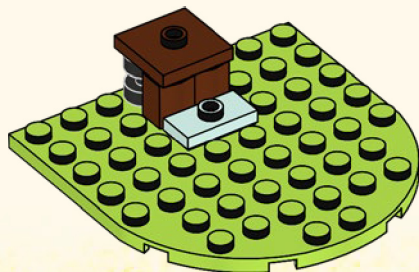

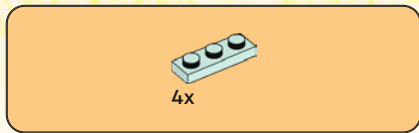

4

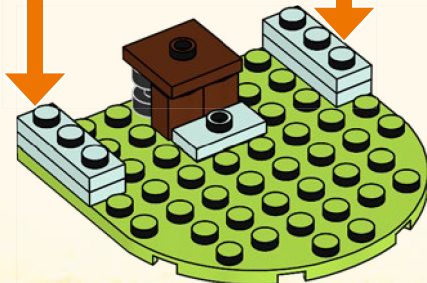
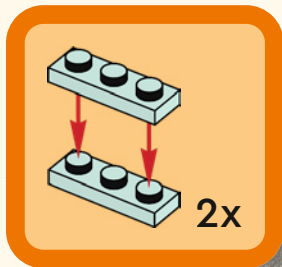

5

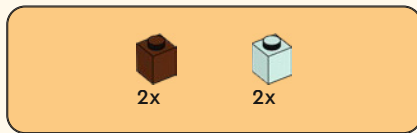
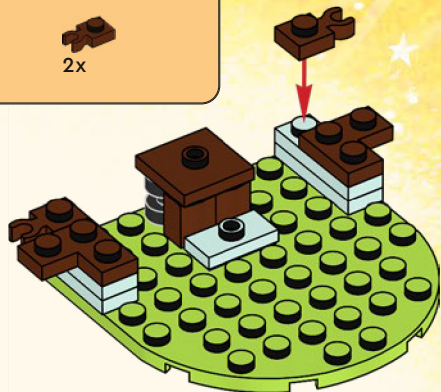

6

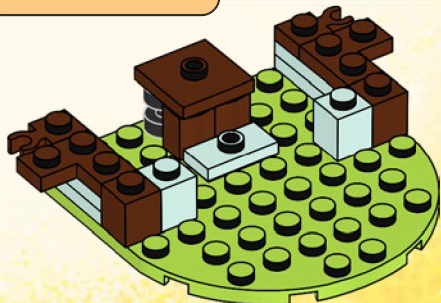



1x



2x

7

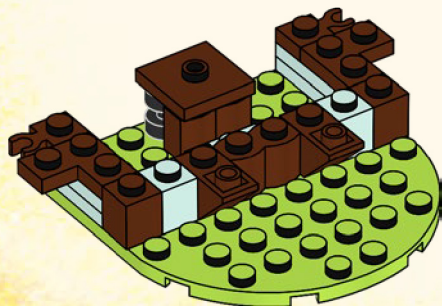

2x



3x

8

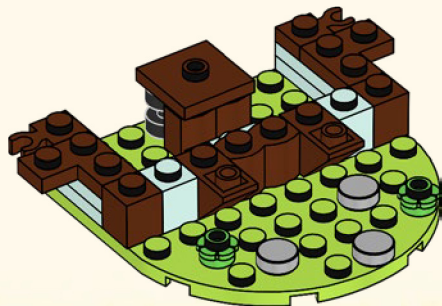



4x

9

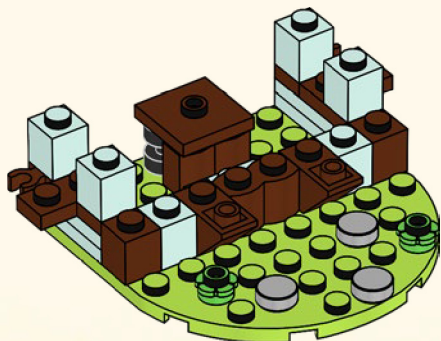

2x



2x

10

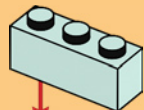
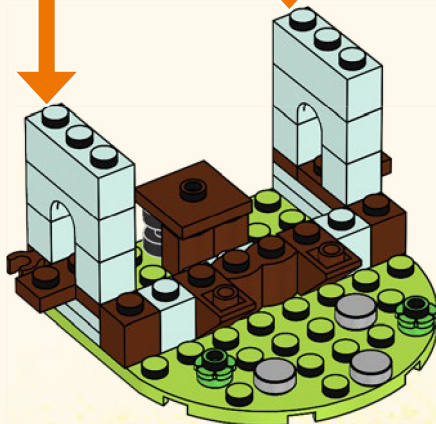

2x



11

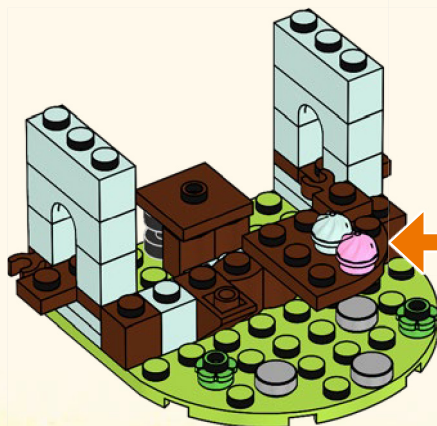
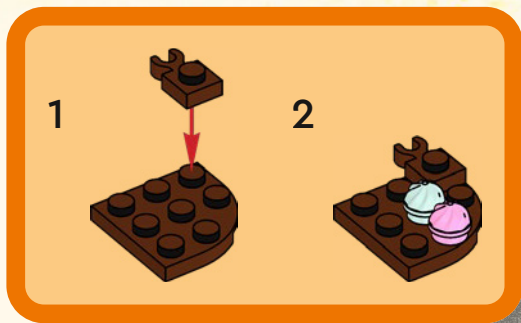



12

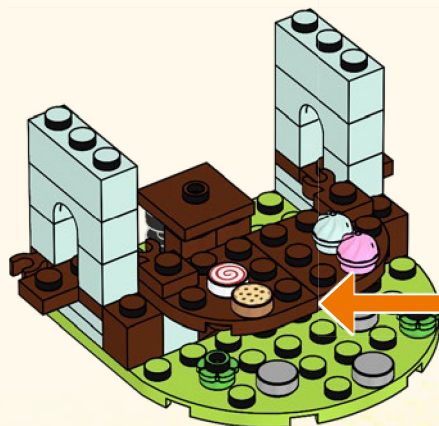
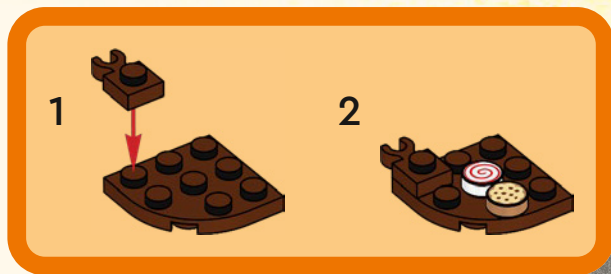

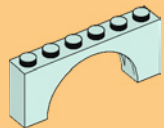

1x

13

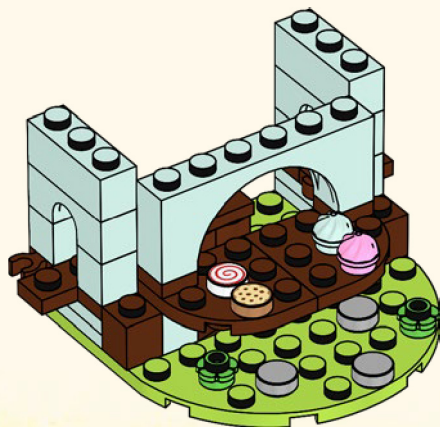



14

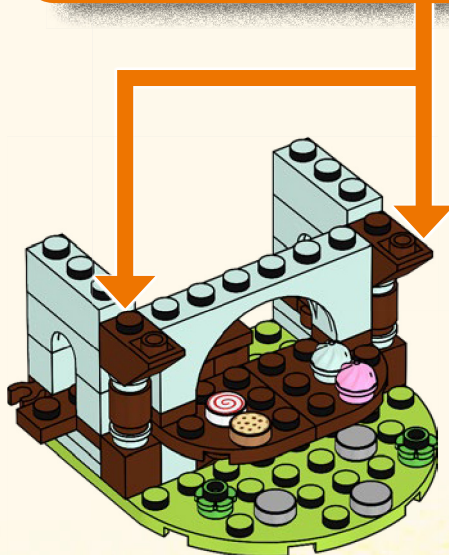
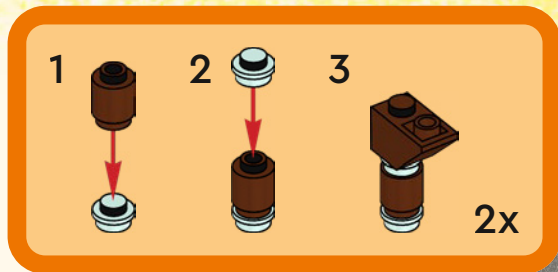



2x



1x

15

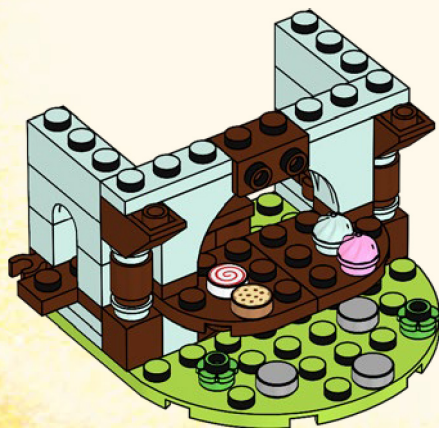

1x



2x

16

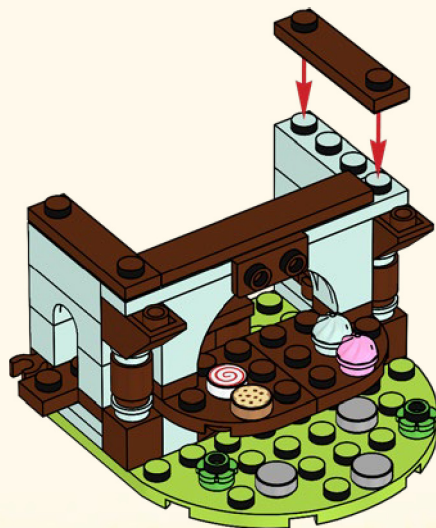



17

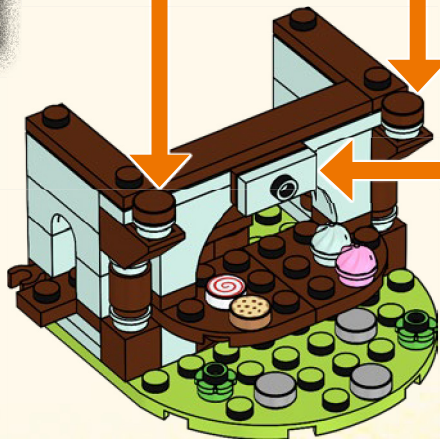
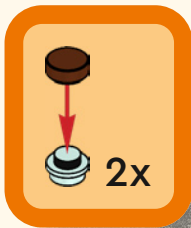

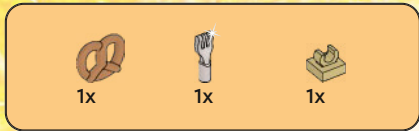

18

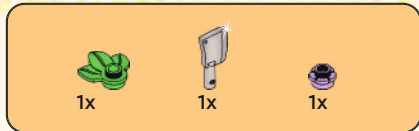
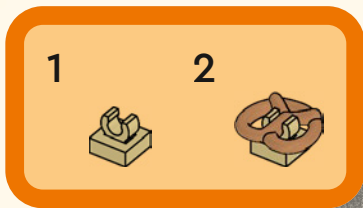
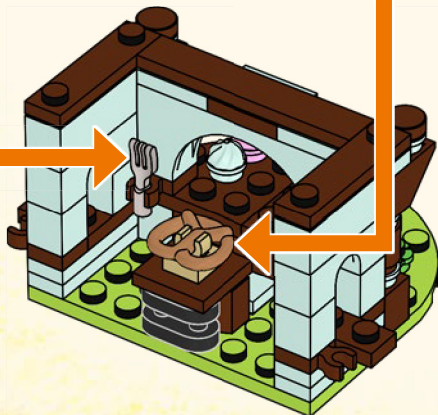

19

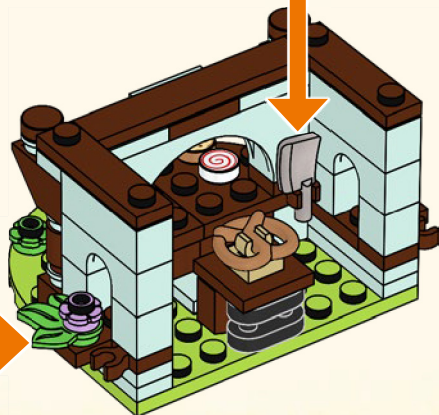
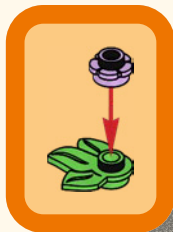



1x



1x



1x

20

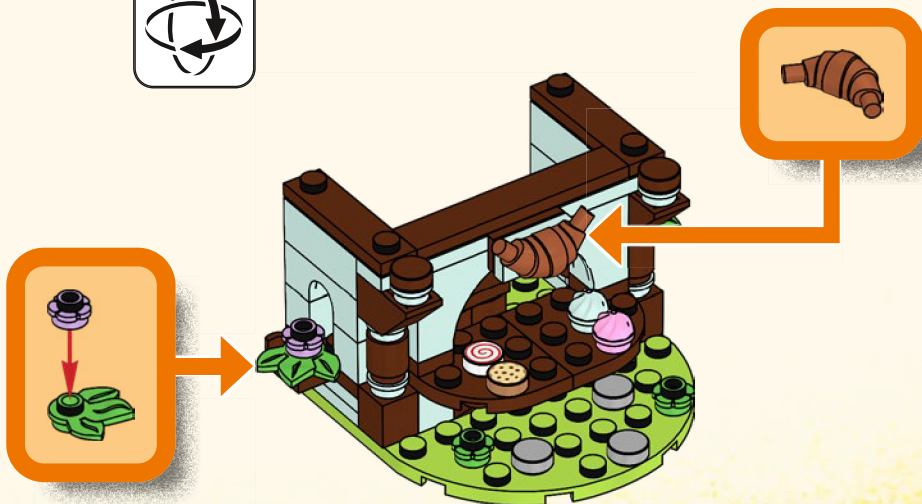

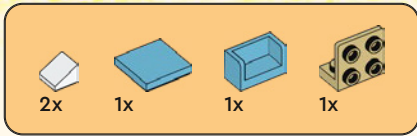

2

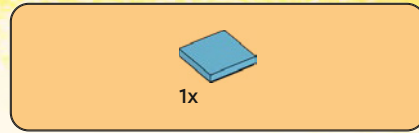
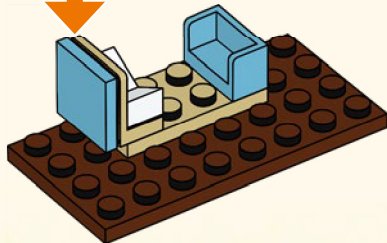
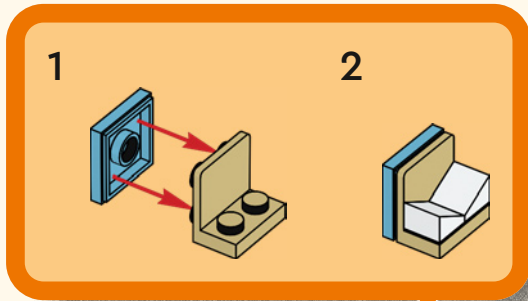

3

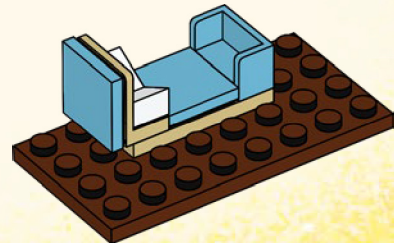



1x



1x

4

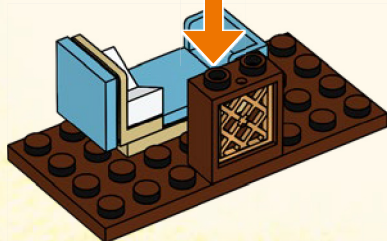

2x

5

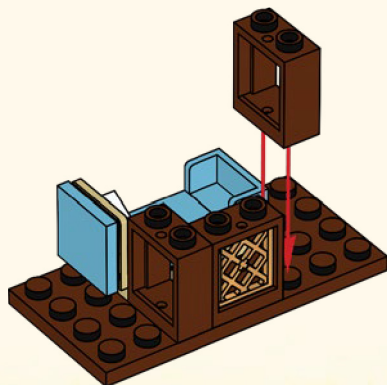



6

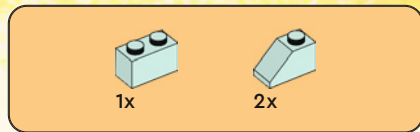
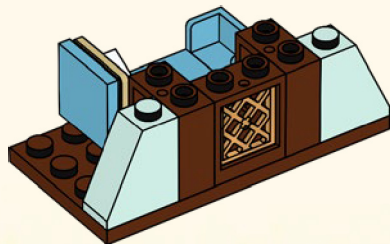

7

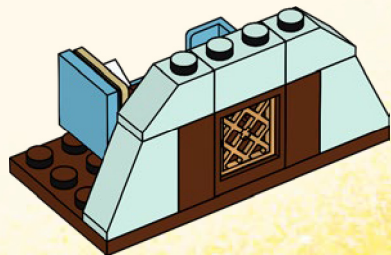



2x

8

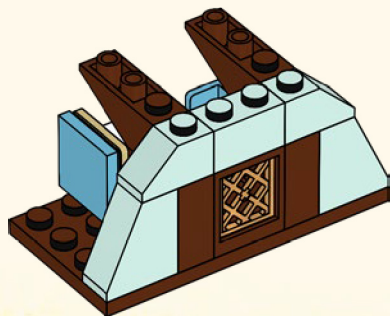

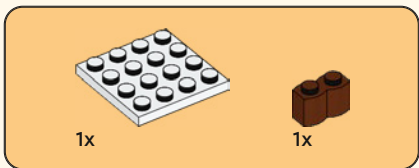
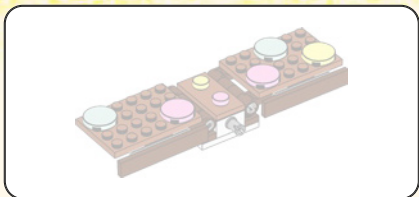

9

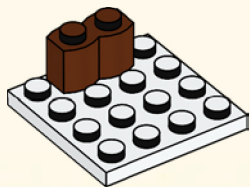

10

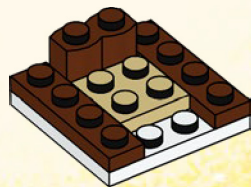



4x

11

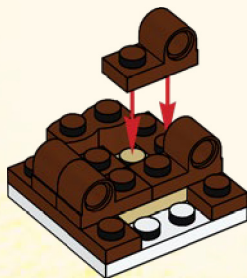

1x



1x



1x

12

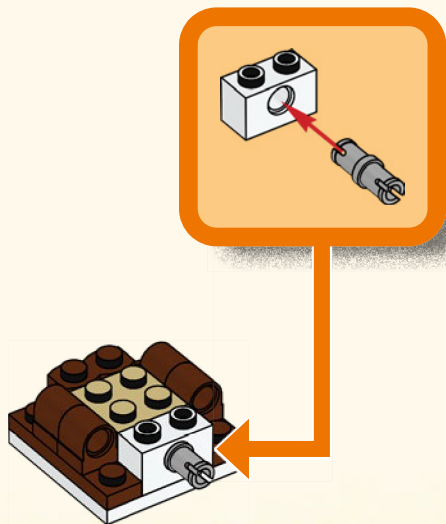

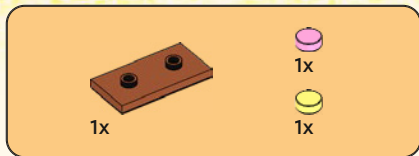

13

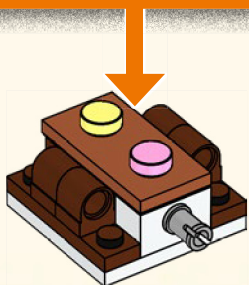
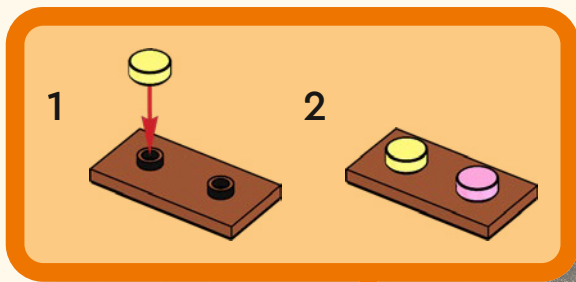

14

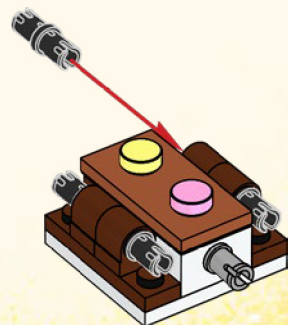



4x

15

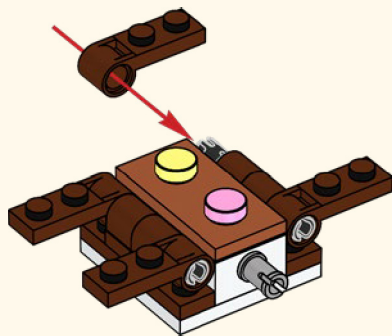

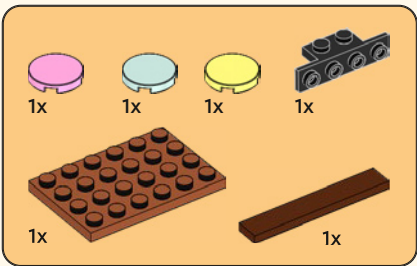

16

1

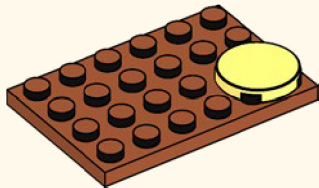

2

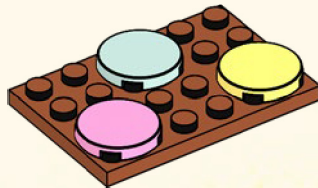

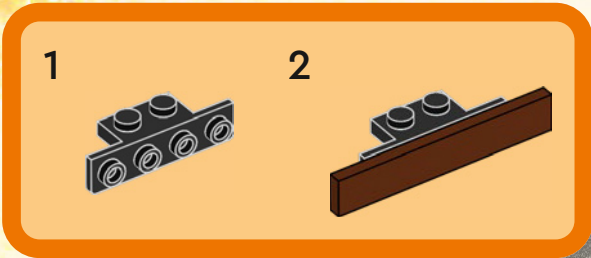

3

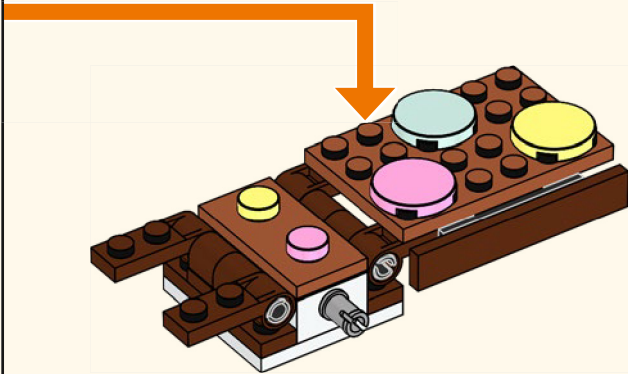
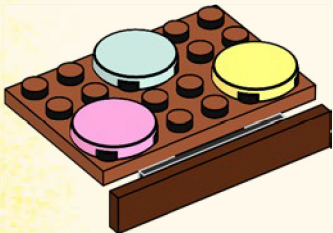

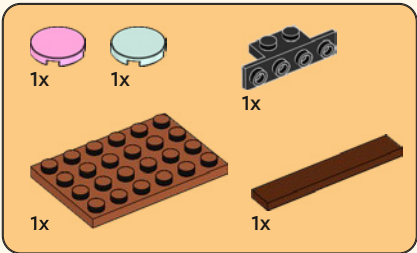

17

1

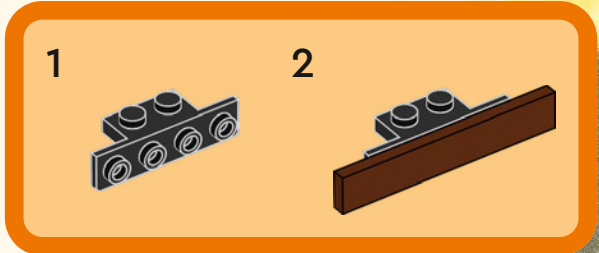
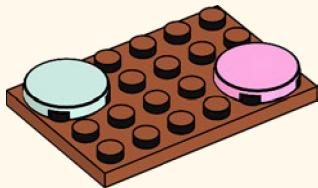

2

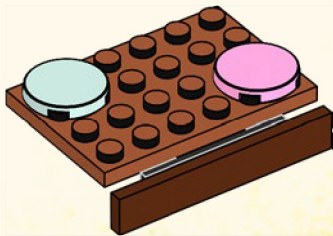

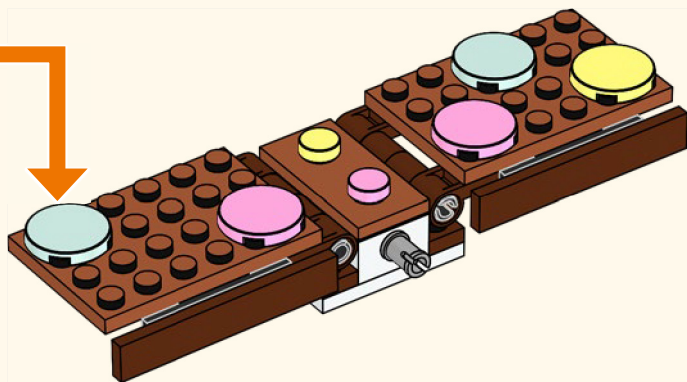

18





19

1

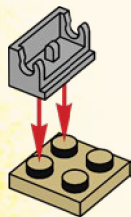

2

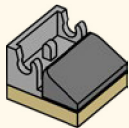

3

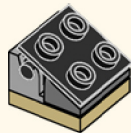

4

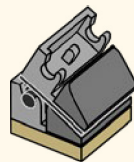

5

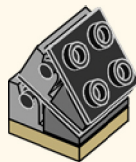

6

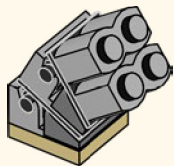

7

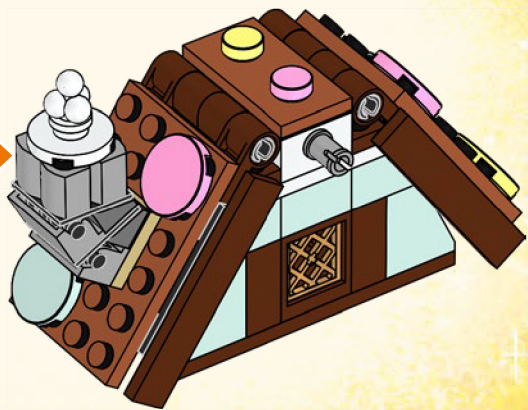
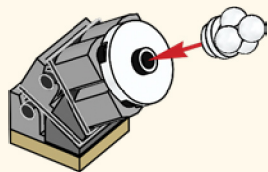



20

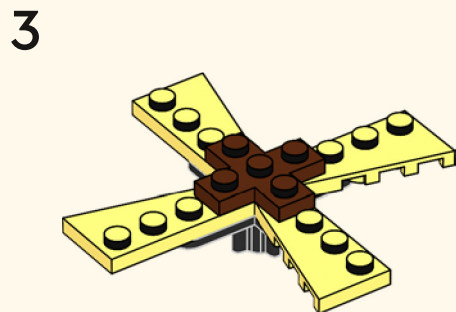
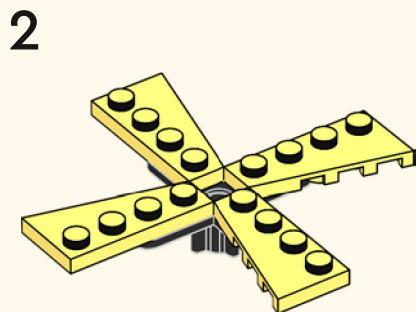
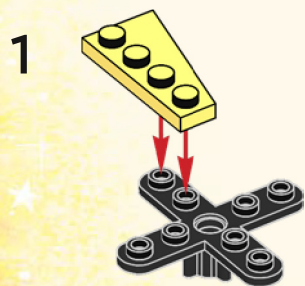

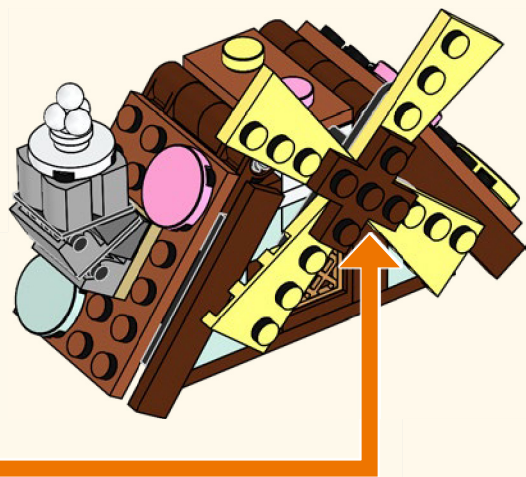



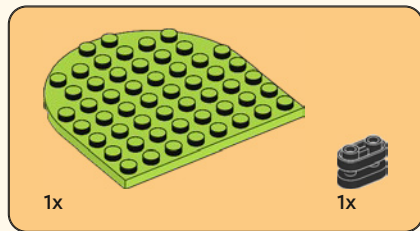
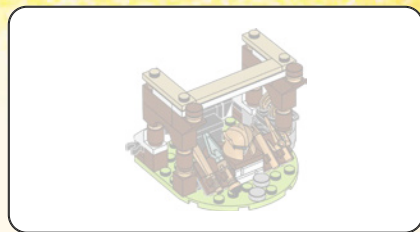
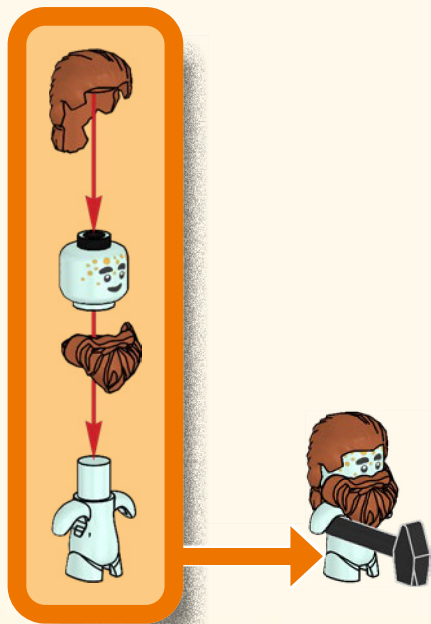

1

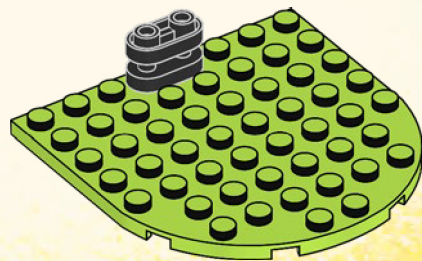



1x



1x

2

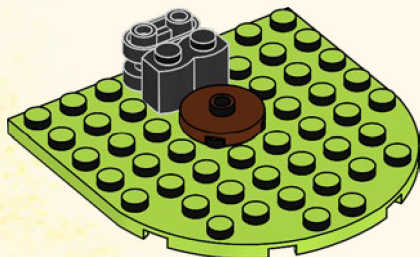

1x

3

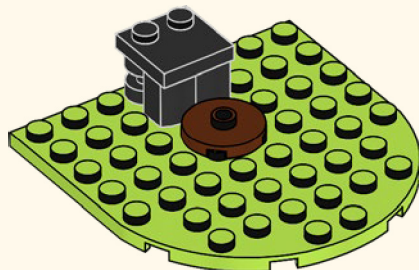



4

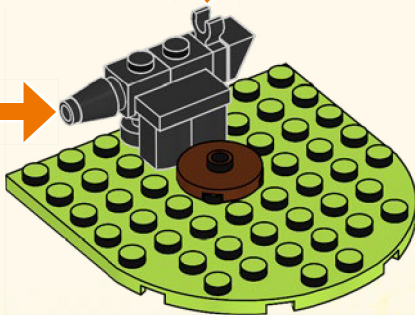
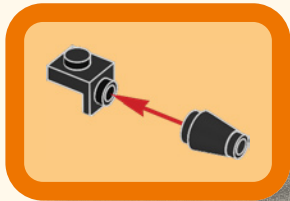
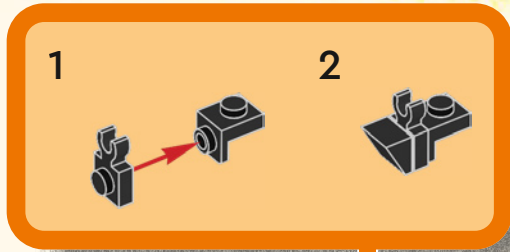

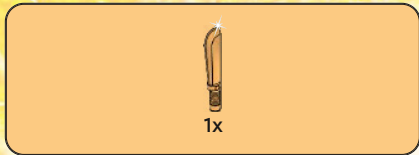

5

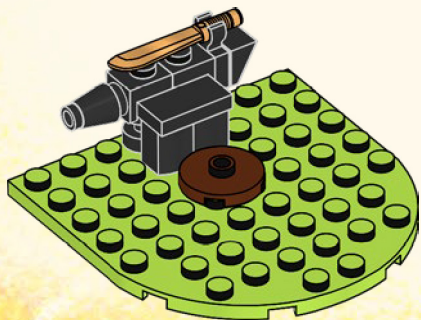

6

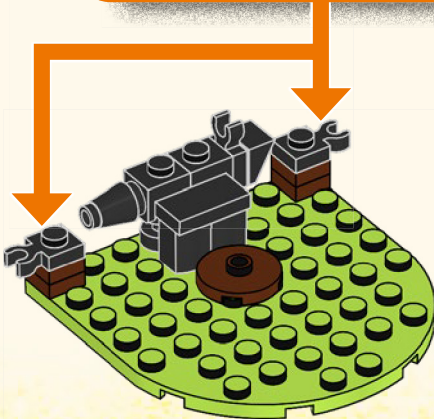
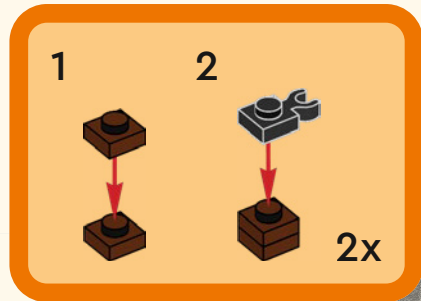



2x



1x

7

1

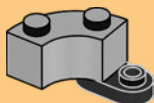

2

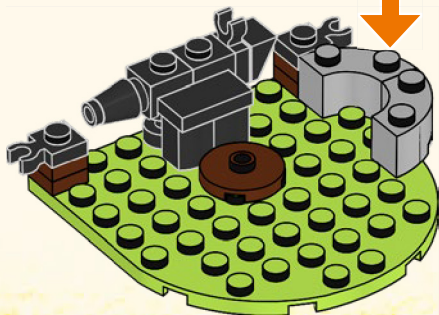
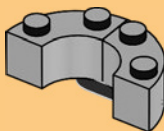

1x



1x

8

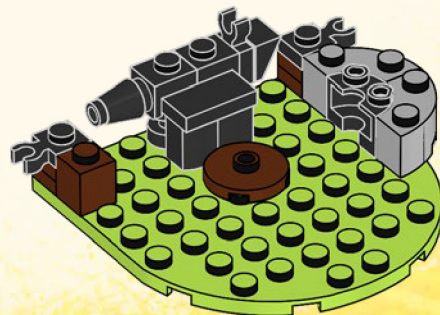



1x



1x



2x

9

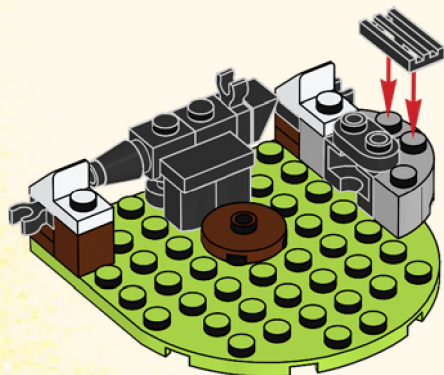

1x



2x



1x

10

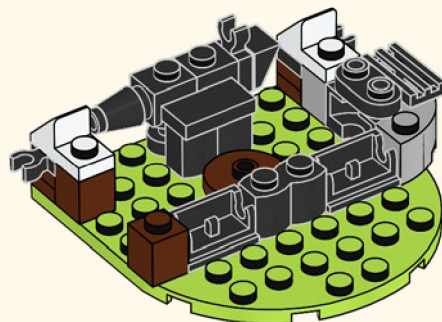



11

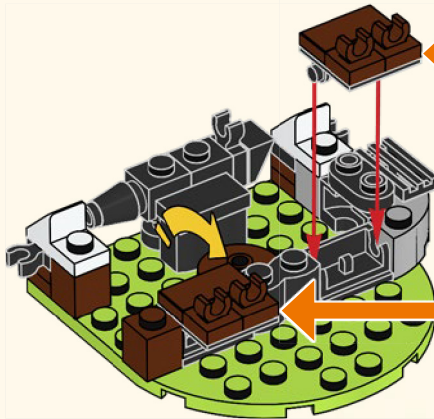
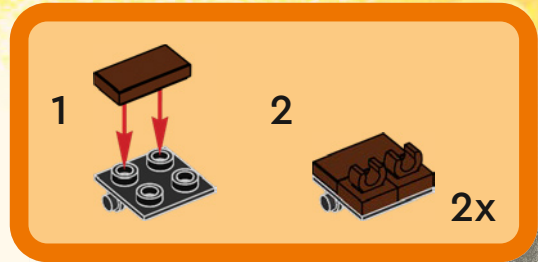



1x

12

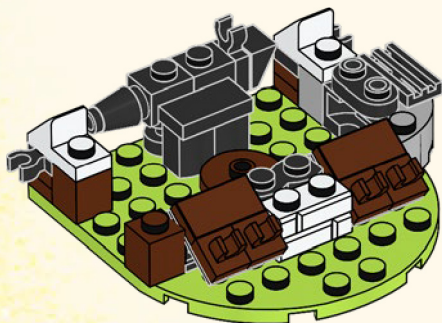

2x



1x



2x

13

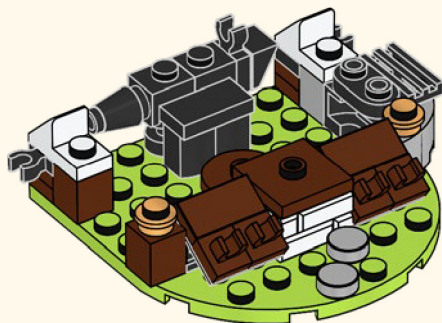



1x



2x

14

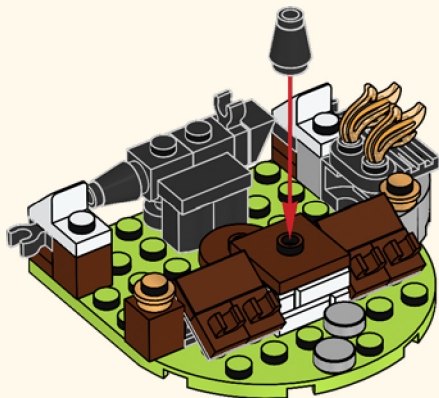

4x



4x

15

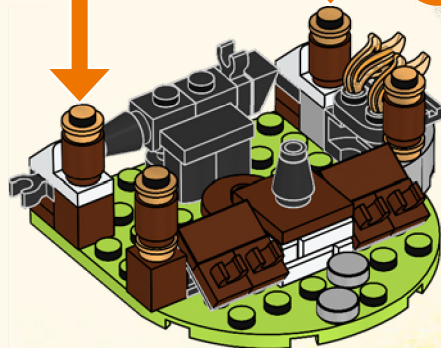

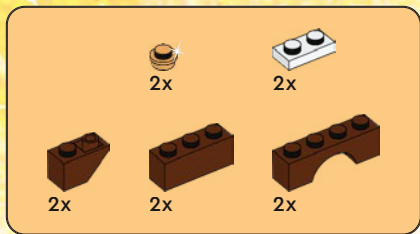

16

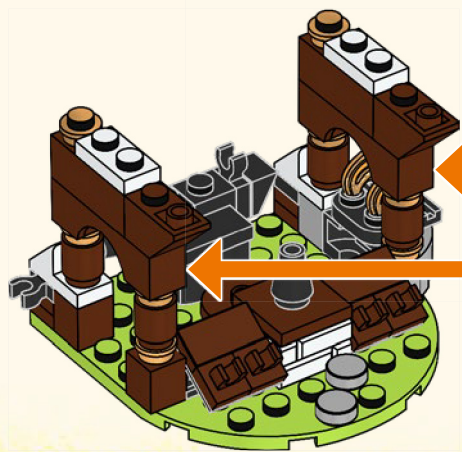
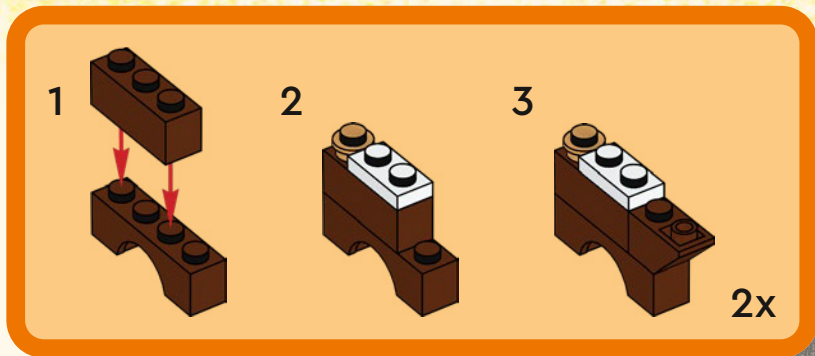

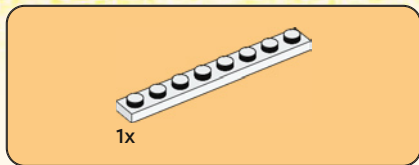

17

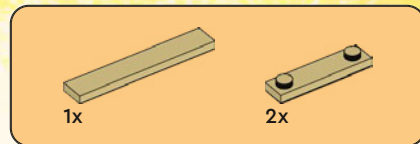
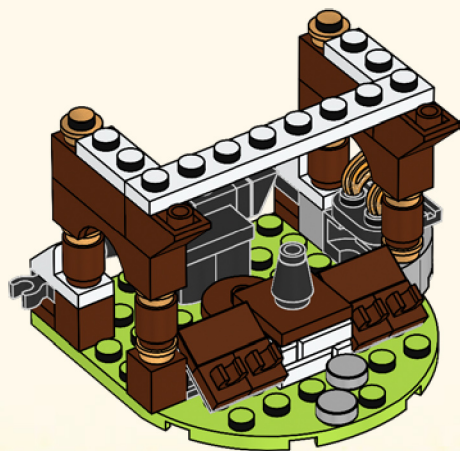

18

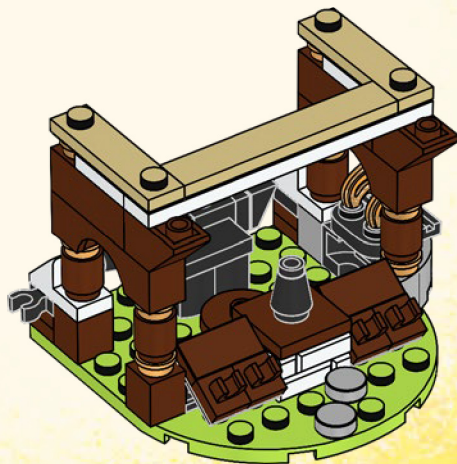



2x



2x

19



2x

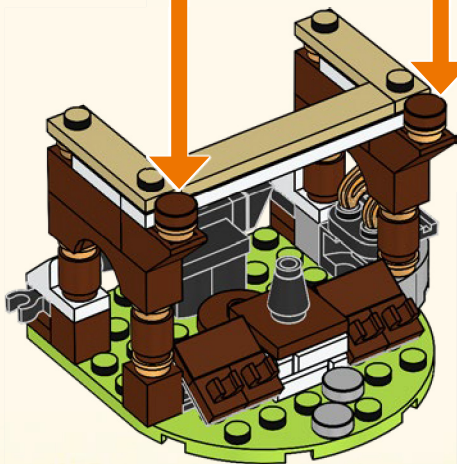



20



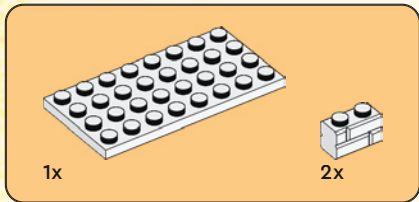
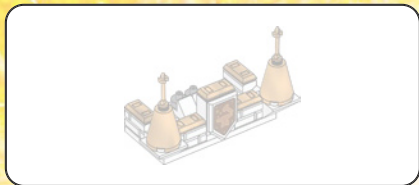

1

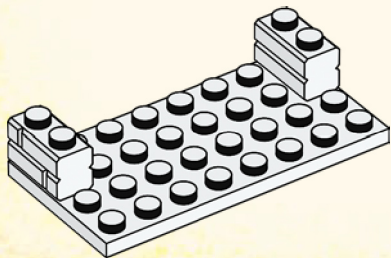

2

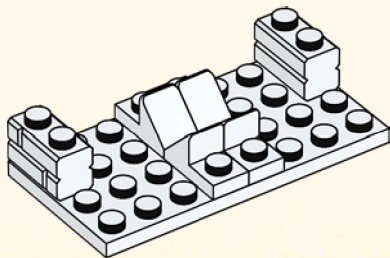



2x



2x

3



2x

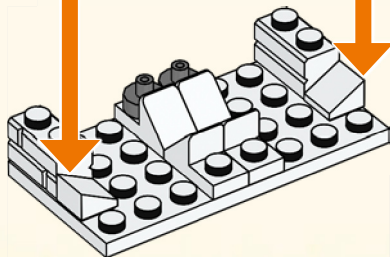

2x

4

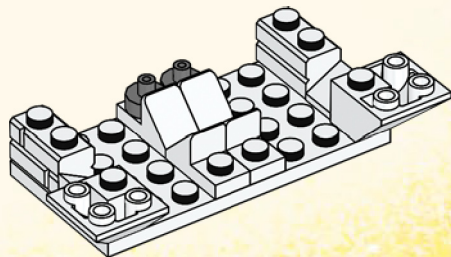

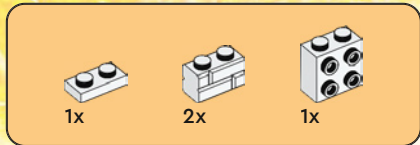

5

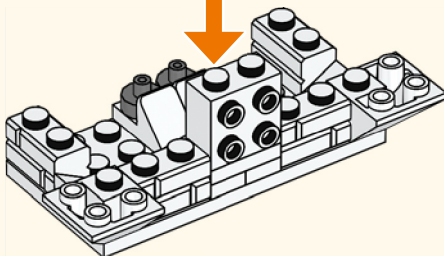
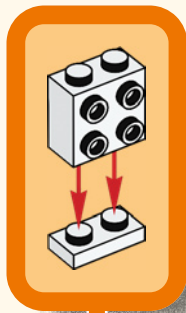



5x

6

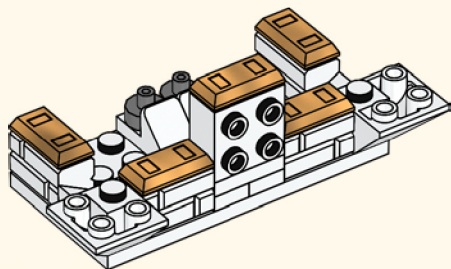

1x

7

1



2

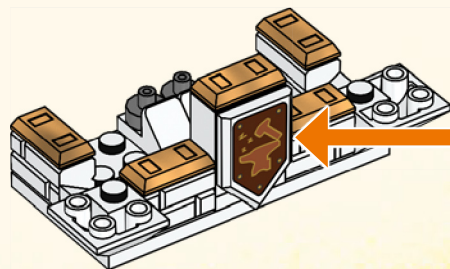

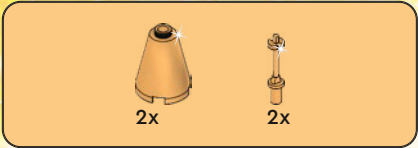

8

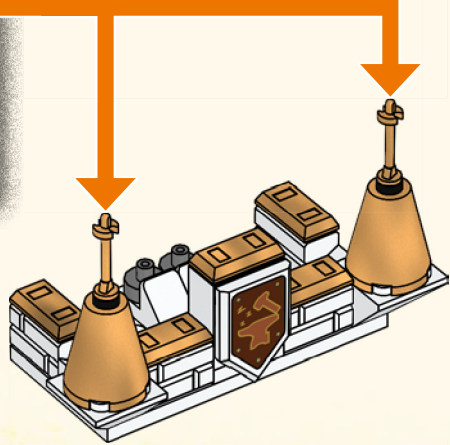
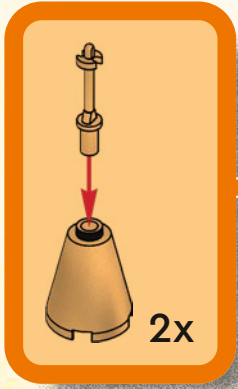

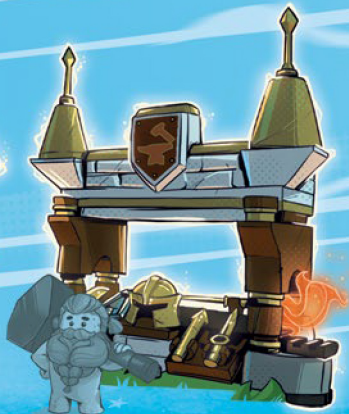
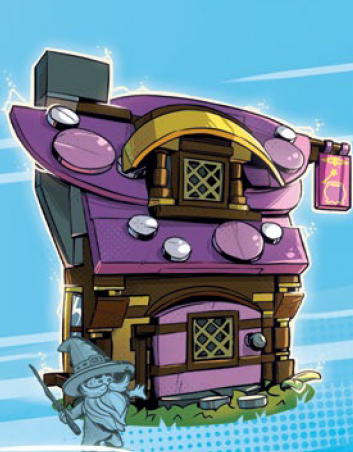



1

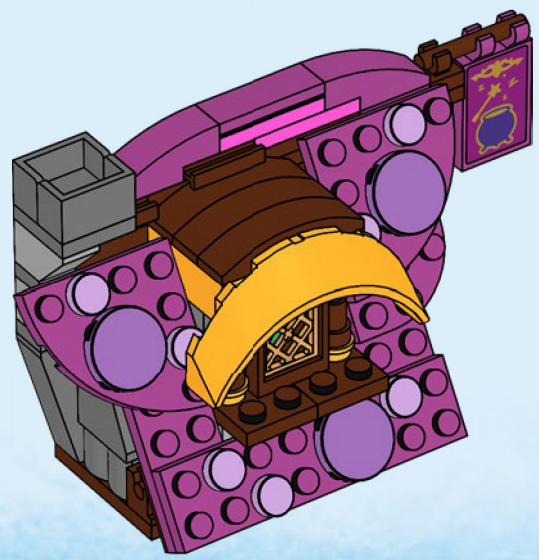

2

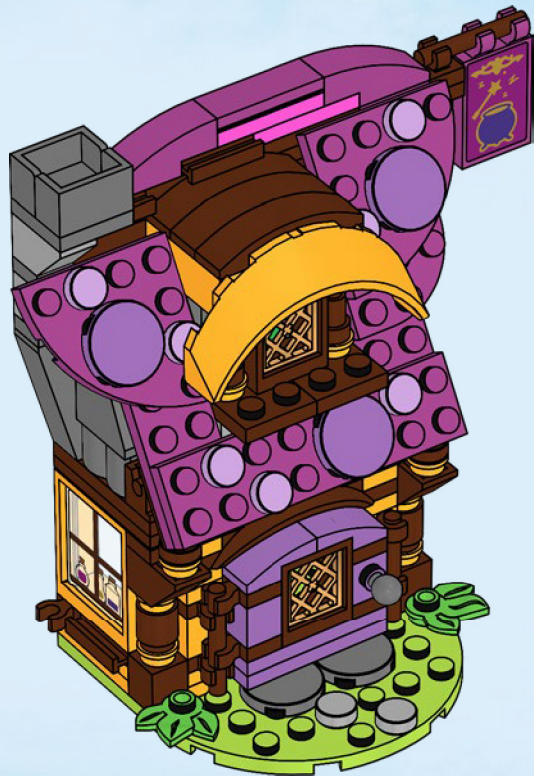

1

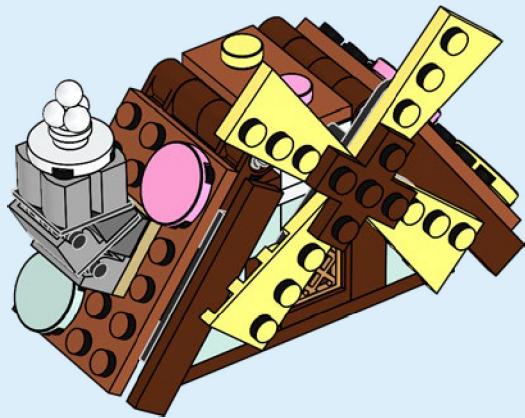

2



1

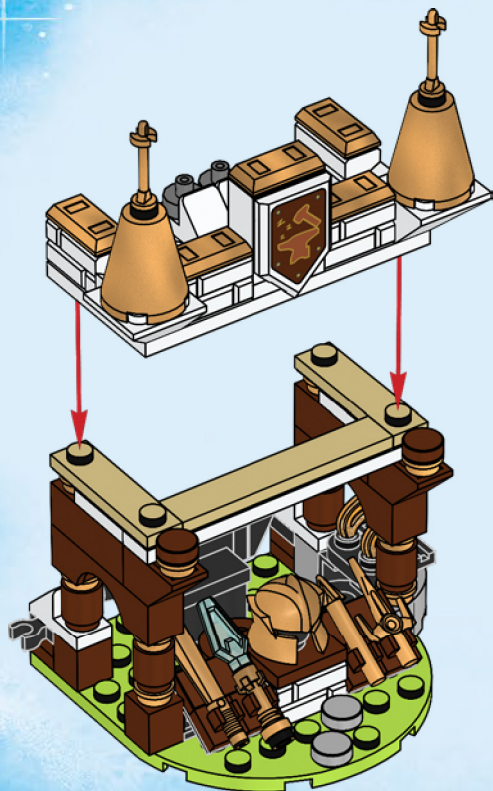

2

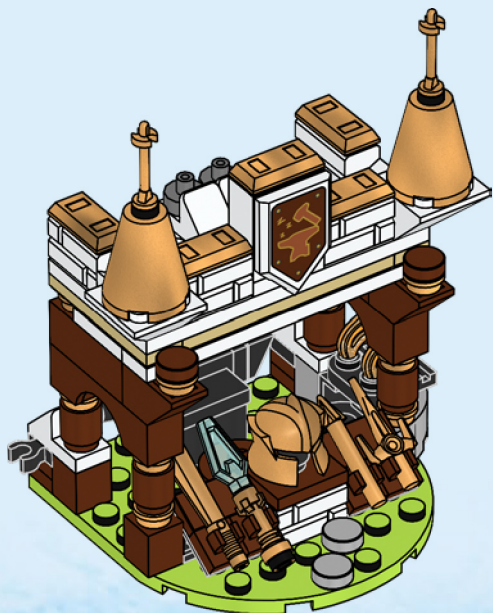





1

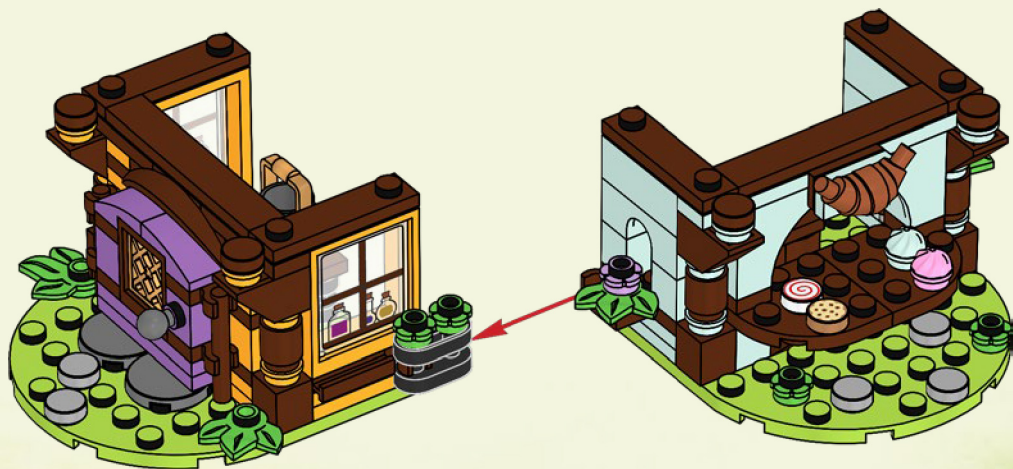

2

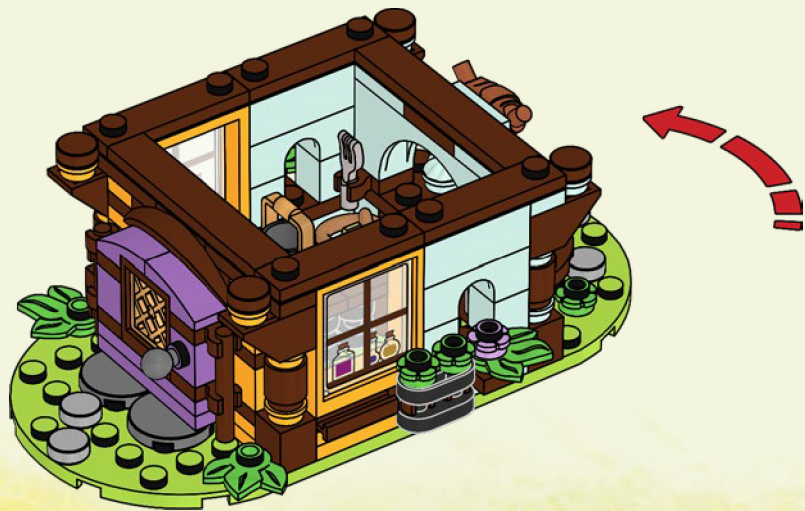

3

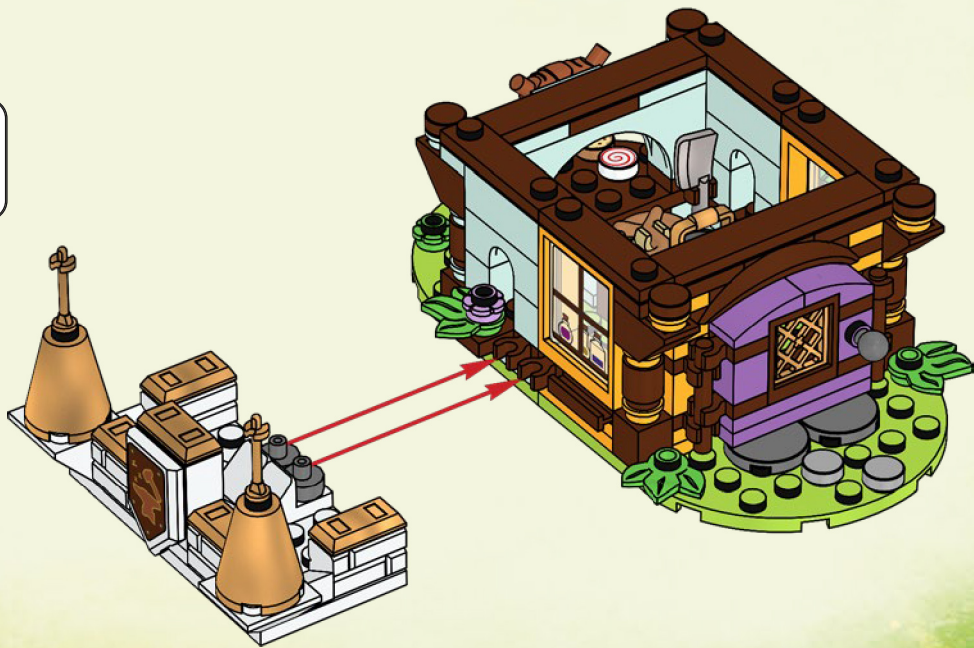

4

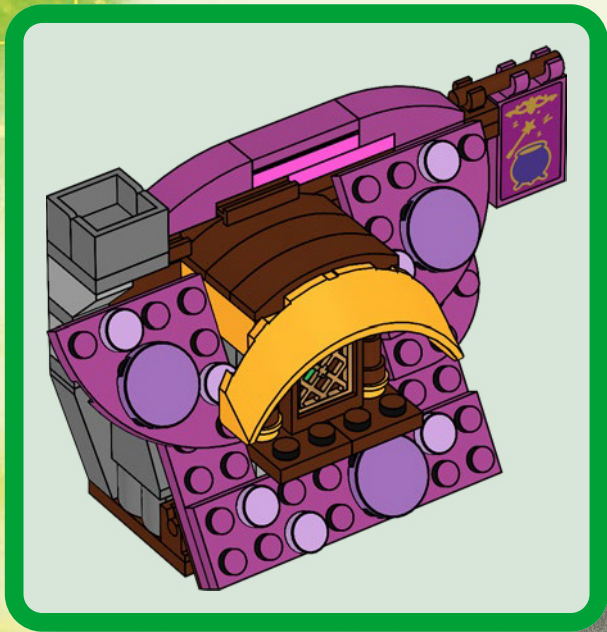

5



6







DREAMZZZ



40657+71456





40657+71459



40657+71461

Watch series online
Schau dir die Serie online an
Regarde la série en ligne
Guarda la serie online
Mira la serie en Internet
Assistir à série online
在线观看
Oglądaj serial w internecie
Sleduj seriál online
Pozri si seriál online
Nézd a sorozatot online
Vizionează serialul online
Гледайте сериала онлайн
Skaties seriālu tiešsaistē
Vaata sarja veebist
Žiūrėk serialą internetu

LEGO

DREAMZZZ

WATCH
SERIES
ONLINE 



[LEGO.com/DREAMZZZ](https://www.lego.com/DREAMZZZ)

 1x 6411552	 1x 6218823	 3x 4114084	 1x 6405102	 1x 6192346	 1x 6288614	 1x 6395622
 1x 6458475	 2x 6138740	 2x 6257600	 4x 6447759	 1x 452226	 2x 6426644	 2x 6103415
 4x 4504369	 1x 6245249	 1x 4114309	 2x 6210270	 2x 6168620	 2x 6278710	 1x 6211410
 1x 4610044	 1x 4243812	 1x 4157277	 1x 6308032	 1x 6324143	 1x 6337596	 2x 6037650
 1x 6174310	 1x 346001	 1x 6408141	 3x 6330189	 1x 6171101	 1x 6247799	 1x 6112979
 1x 6093053	 1x 303501	 1x 6434205	 4x 6279875	 4x 6206150	 1x 6434368	 1x 6360042
 1x 370001	 1x 6152409	 2x 4529236	 2x 4644456	 4x 6182261	 1x 6238674	 2x 6222803
 5x 6152409	 1x 6360078	 1x 4504382	 2x 393726	 1x 6145153	 1x 6247788	 2x 6186656
 6x 6069002	 1x 6174925	 2x 6299338	 1x 241226	 1x 6290250	 3x 6252480	 1x 6251299
 3x 302301			 4x 4124096	 1x 6424035		



1x
6372781



7x
6284071



2x
4211389



1x
4211807



2x
4550325



5x
4211437



2x
4211469



2x
4567448



3x
4211445



8x
4211183



6x
6284586



6x
4211242



5x
6348057



4x
4221744



14x
6337003



1x
6102360



3x
4211180



6x
6382102



2x
6186045



8x
4211222



4x
6138664



2x
4211151



2x
6310449



1x
6443654



6x
4645103



3x
6428805



3x
4565394



2x
6167644



2x
4211257



1x
6146301



4x
6415991



2x
4211152



2x
4211195



1x
6050918



2x
4211220



2x
4283660



3x
4211189



4x
6257604



3x
4658005



2x
4211190



2x
6177697



2x
4221590



4x
4211204



1x
6299945



1x
6313665



2x
4211207



8x
6331261



2x
6061685



10x
6073040



6x
6073042



2x
6061688



2x
6407954



1x
6418392



2x
6271752



3x
4504378



2x
4210719



1x
6364352



2x
4567887



2x
6056296



1x
4211094



5x
4211095



2x
6092572



1x
6013658



2x
6275131



1x
4500975



3x
6404150



1x
6284587



1x
6424008



2x
6092768



1x
6343806



1x
6133845



4x
6296533



1x
4586410



2x
6292254



2x
6321757



1x
6162580



1x
6003147



10x
4523159



1x
6342086



4x
6295686



1x
6245278



1x
6291401



2x
6092672



5x
6207933



1x
6270135



1x
6287854



1x
6359941



1x
6361354



1x
6363149



1x
6363146



6x
6382504



1x
6249118



3x
6434212



6x
6236576



3x
6435594



2x
6096948



1x
6022032



2x
6097303



2x
6163294



2x
6273887



6x
6325961



2x
6356089



2x
6295228



1x
6325976



2x
6314353



2x
6060857



1x
6248486



1x
6125776



1x
4651903



3x
6062386



7x
6322820



2x
6214235



2x
6136331



1x
6443370



2x
4619524



 [LEGO.com/service](https://www.LEGO.com/service)

YOU COULD
WIN



Scan this QR code or go to
LEGO.COM/PRODUCTFEEDBACK and give
us your short feedback about this LEGO® set
for a chance to win a cool LEGO prize.

Terms and Conditions apply*



EN: YOU COULD WIN. Terms and Conditions apply* **DE: Du könntest GEWINNEN.** Es gelten die Teilnahmebedingungen* **FR: Tu pourrais GAGNER.** Des conditions s'appliquent* **IT: Potresti VINCERE tu.** Termini e condizioni sono applicabili* **ES: Puedes GANAR.** Aplican términos y condiciones* **PT: Poderá GANHAR.** Aplicam-se termos e condições* **ZH: 轻松获奖. 条款和条件适用*** **PL: Szansa na WYGRANĄ.** Obowiązują warunki korzystania* **CS: Máte šanci VYHRÁT.** Platí všeobecné smluvní podmínky* **SK: Máte šancu VYHRAŤ.** Platia všeobecné zmluvné podmienky* **HU: TE IS NYERHETSZ.** Felhasználási feltételek érvényesek* **RO: Ai putea CÂȘTIGA.** Se aplică termenii și condiții* **BG: Можете да СПЕЧЕЛИТЕ.** Има определени правила и условия* **LV: Tu vari LAIMĒT.** Ir spēkā noteikumi un nosacījumi.* **ET: Sul on võimalus VÕITA.** Kehtivad tingimused* **LT: Jūs galite LAIMĖTI.** Taikomos sąlygos*

*[LEGO.com/productfeedback-terms](https://www.lego.com/productfeedback-terms)