



MONKIE KID 悟空小侠

80040





 **FR**
DONNEZ
OU
RECYCLEZ

 OU  OU 

ASSOCIATION MAGASIN DÉCHÈTERIE

Adresses sur quefairedemesdechets.fr



LEGO.com/sustainable-packaging



BUILDER



Apple and the Apple logo are trademarks of Apple Inc., registered in the U.S. and other countries and regions. App Store is a service mark of Apple Inc. Google Play and the Google Play logo are trademarks of Google LLC. Tencent and the Tencent logo are trademarks of Tencent Inc.

EN Ask parents' permission before going online | **DE** Eltern um Erlaubnis bitten, bevor du online gehst | **FR** Demande l'autorisation d'un parent avant d'aller en ligne | **IT** Chiedi il permesso ai tuoi genitori prima di andare online | **ES** Pídeles permiso a tus papás antes de conectarte a Internet | **PT** Pede autorização aos pais antes de acederes online | **JA** オンラインになる前に ほか者の方のきよかをもらおう | **ZH** 上网前应先征得父母的同意 | **KO** 온라인 접속 전에 보호자 동의가 필요합니다 | **RU** Спроси разрешения у родителей, прежде чем заходить в интернет | **PL** Poproś rodziców o zgodę, zanim wejdziesz do Internetu | **CS** Než půjdeš na internet, požádej rodiče o svolení | **SK** Skôr než pôjdeš na internet, vypýtaj si povolenie od rodičov | **HU** Kérj szülői engedélyt, mielőtt online csatlakoznál! | **RO** Cere permisiunea părinților înainte de a te conecta online | **BG** Поискайте разрешение от родител, преди да влезете онлайн | **LV** Pirms došanās tiešsaistē palūdz atļauju vecākiem | **ET** Enne Interneti kasutamist küsi vanematelt luba | **LT** Prieš prisijungdami prie interneto, atsklauskite tėvų

Q [LEGO.com/devicecheck](https://www.lego.com/devicecheck)

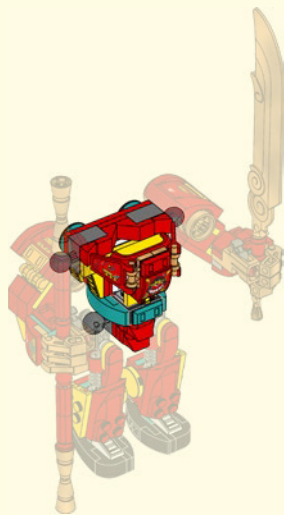

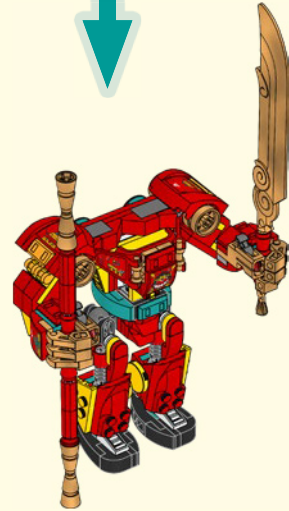
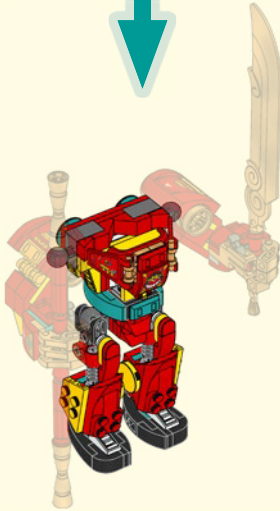

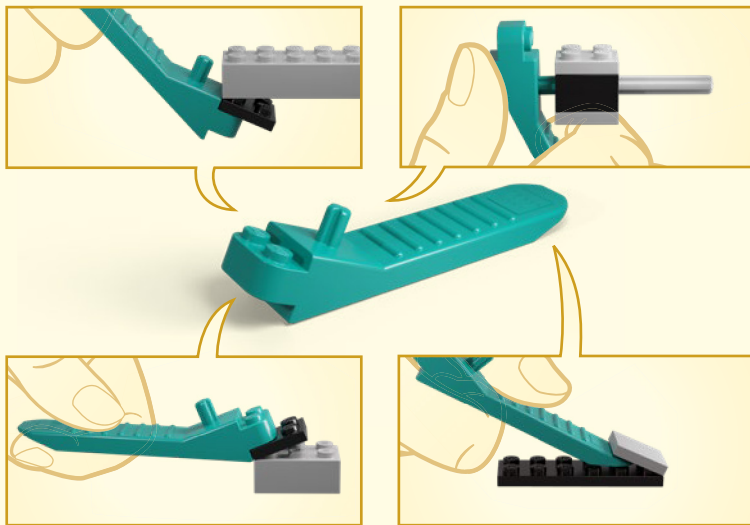





1

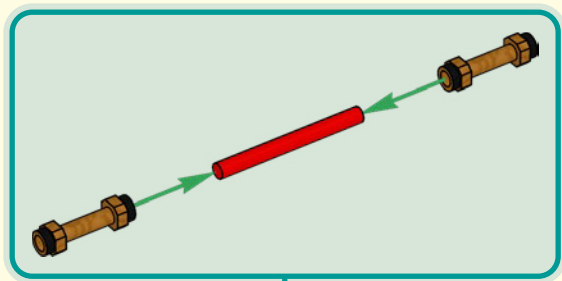

2



MONKIE KID



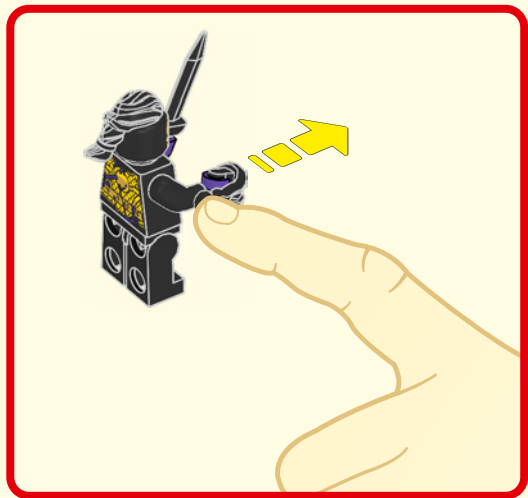
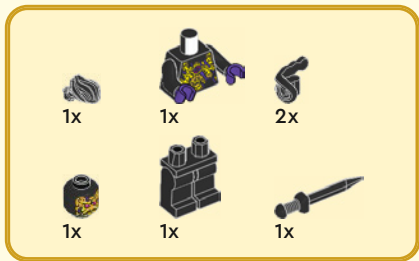

1

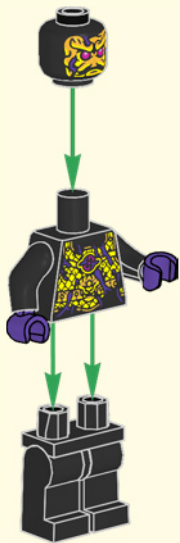

2





1x

1

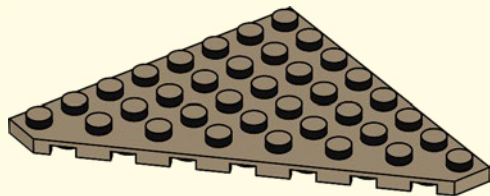

1x



1x

2

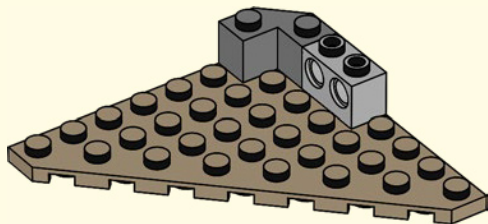



1x



2x

3

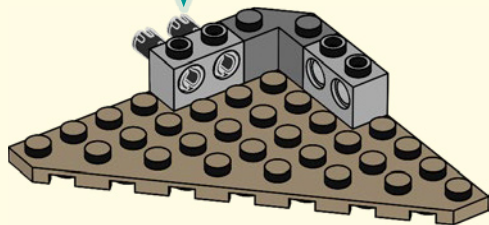
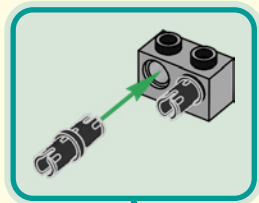

1x



1x

4

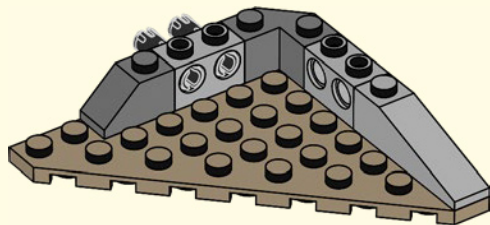



2x

5

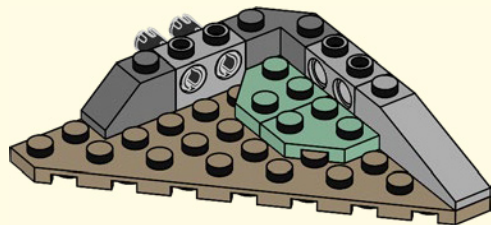

1x



2x

6

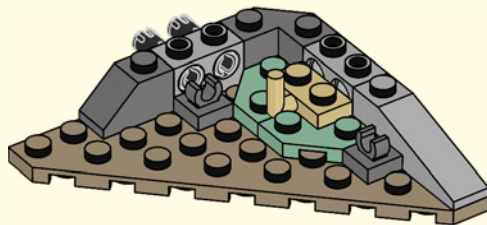



1x

7

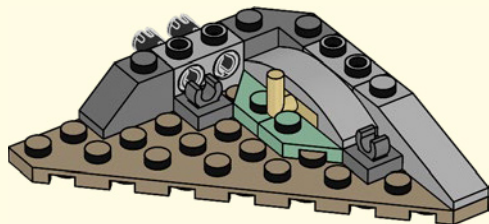

2x

8

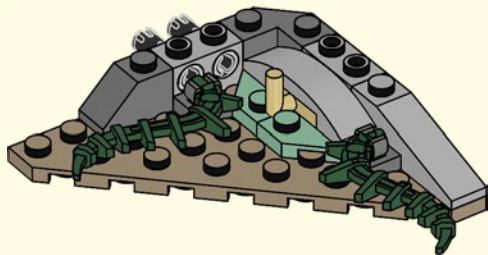



2x

9

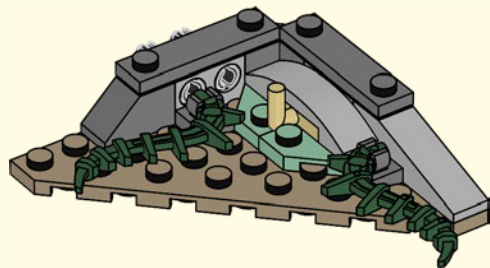

1x



1x

10

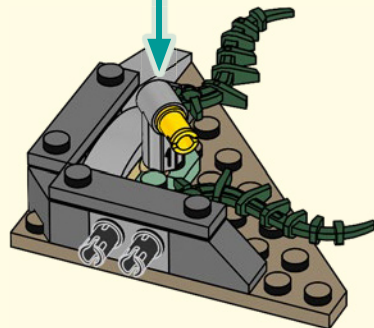
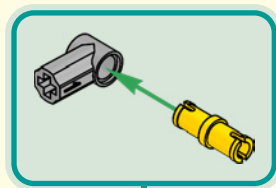

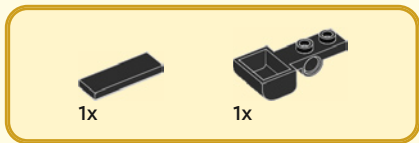

11

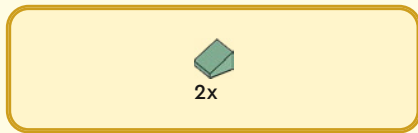
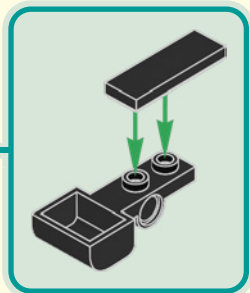
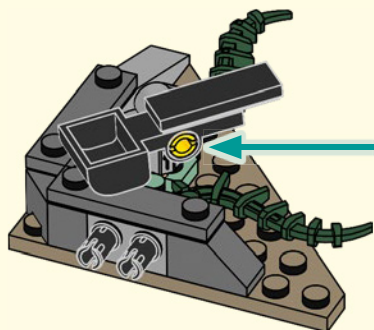

12

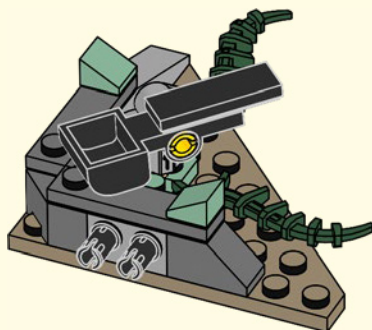



3x

13

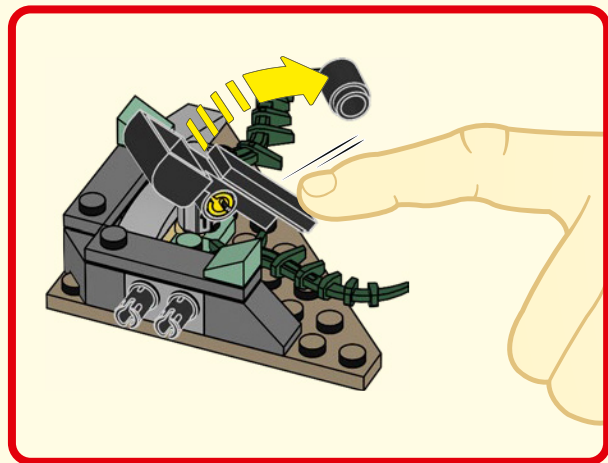



1x

2x

1

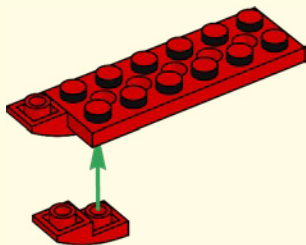



1x

2

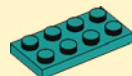
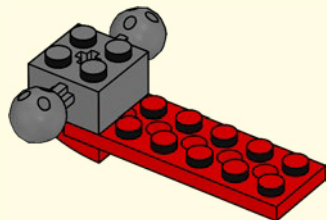

1x

3

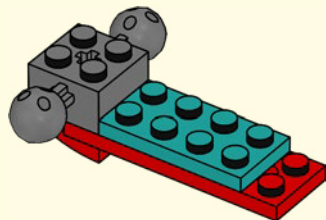



1x



1x

4

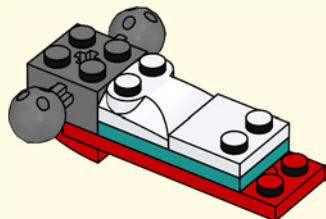

2x



2x

5

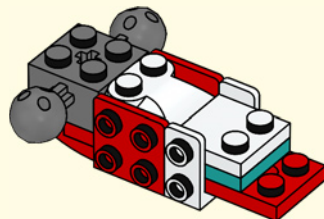

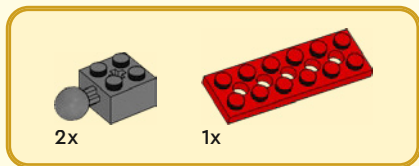

6

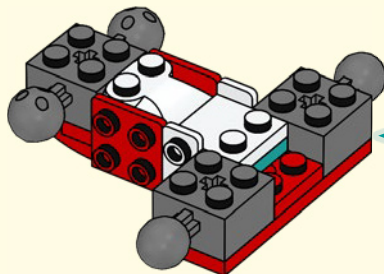
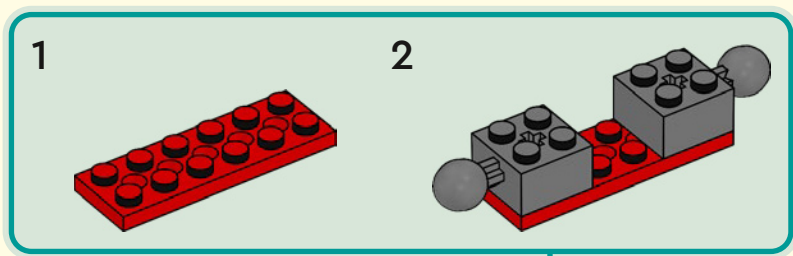



1x

7

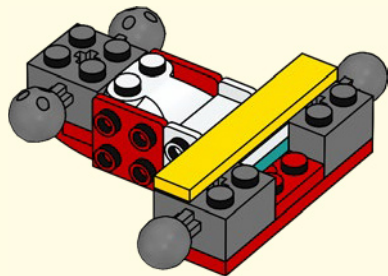

2x



2x

8

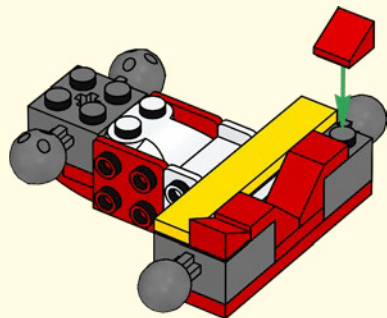



2x

9

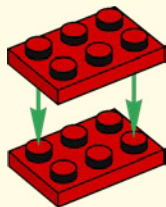

2x

10

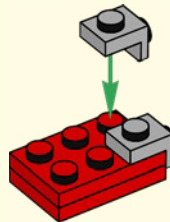



2x



1x

11

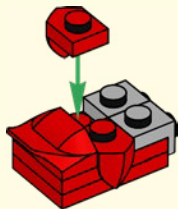

1x

12

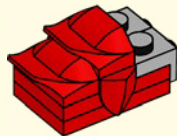



1x

13

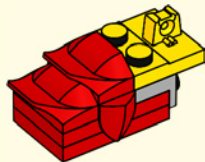

2x

14

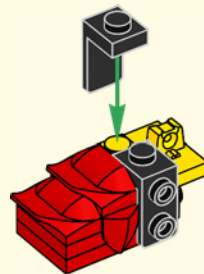



1x

15



16

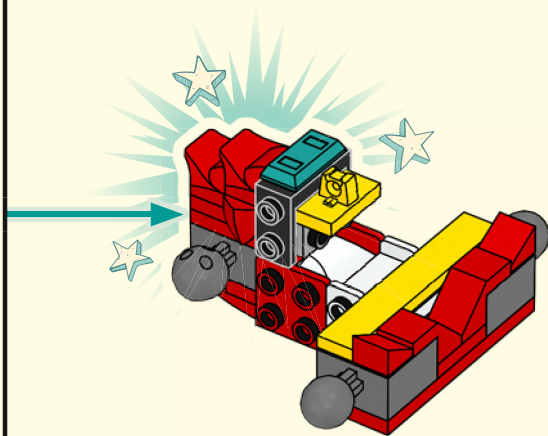



17

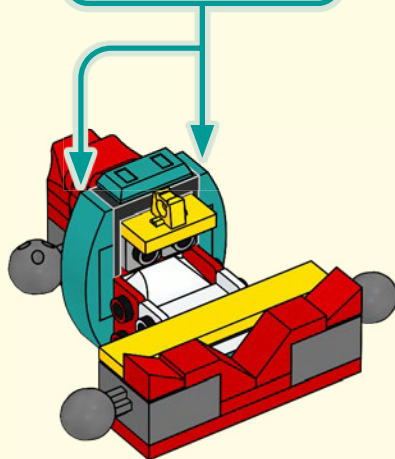
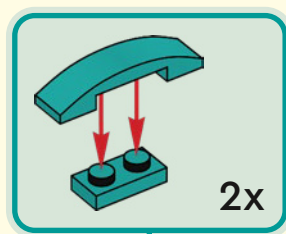



1x



1x

18

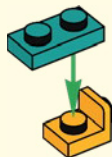

1x

19





2x

20

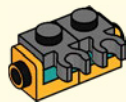

1x

21

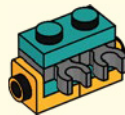



2x

22



1x



2x



1x

23

1

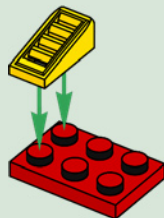

2

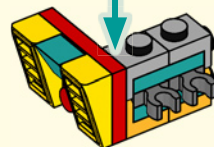
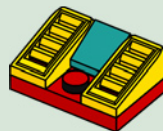

24

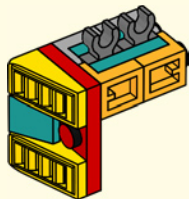

25

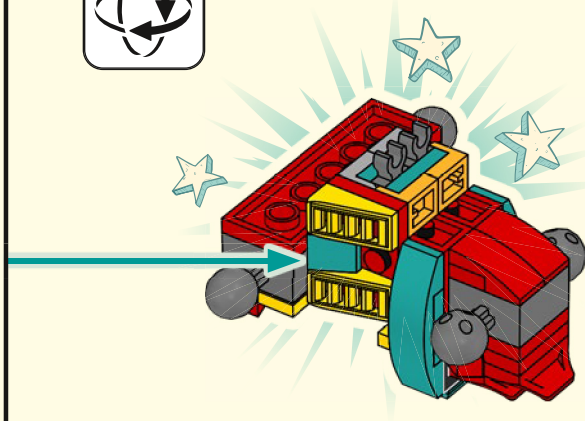



26

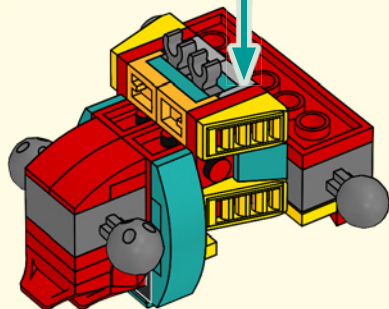
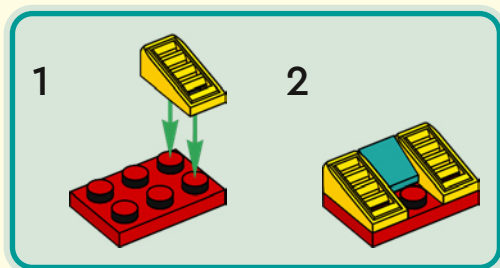

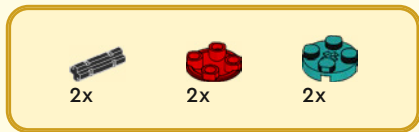

27

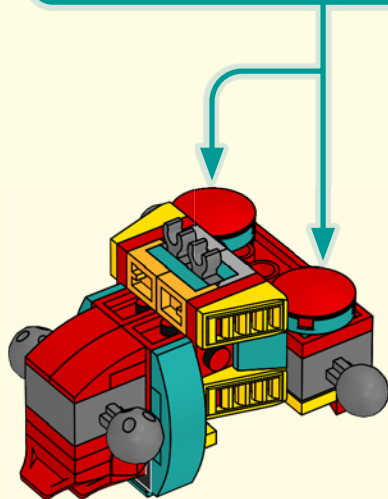
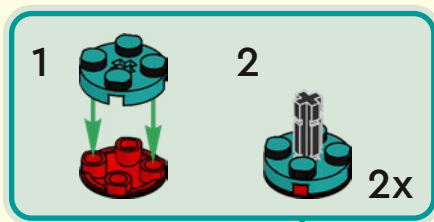



1x



1x

28

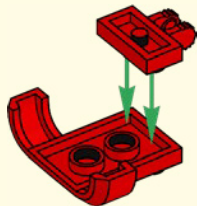

1x

29



30

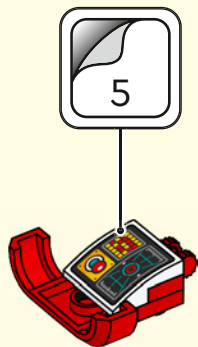

31





1x

32

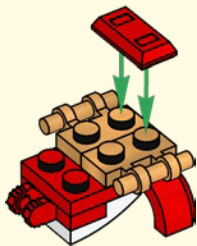

1x

33





34

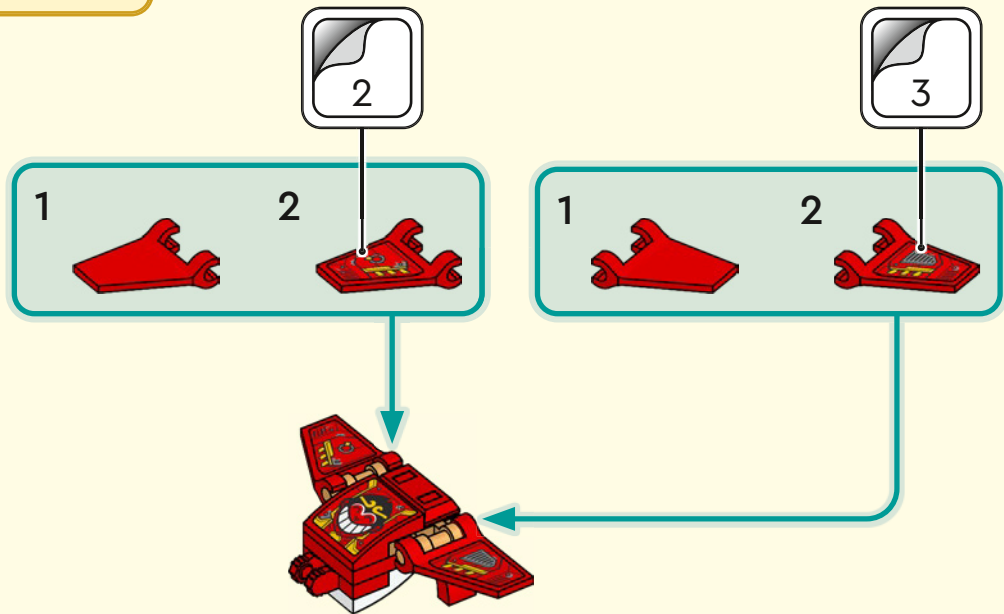

35

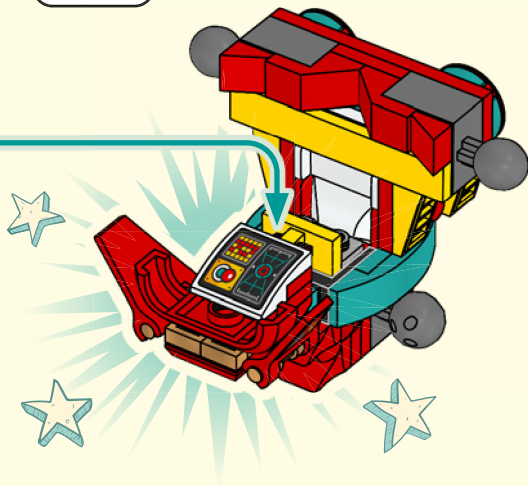

36

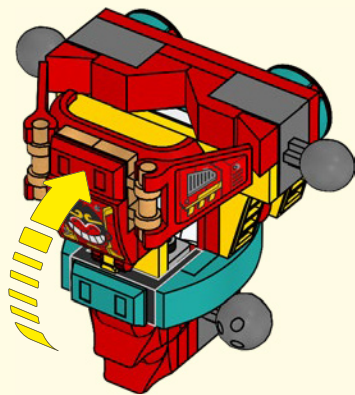

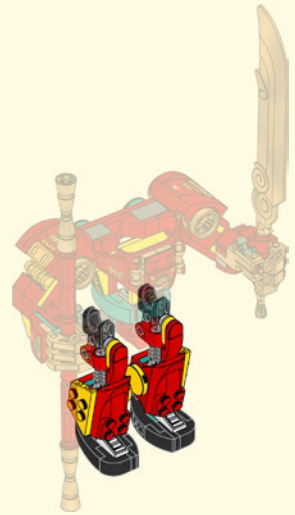



37

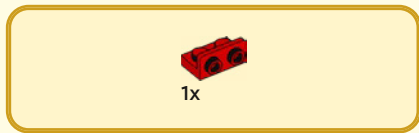
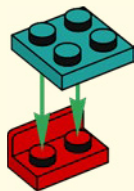

38





1x

39

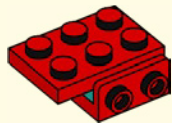

1x



2x

40

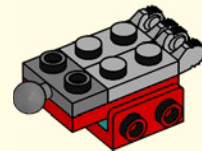



1x

41

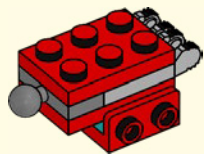

2x

42

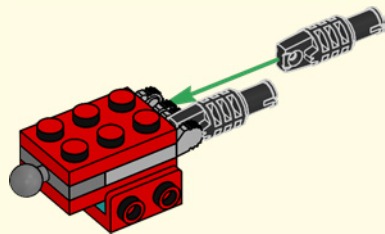

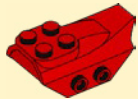

1x

43

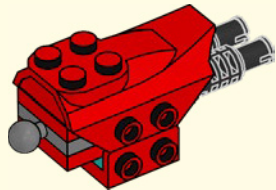

1x

44

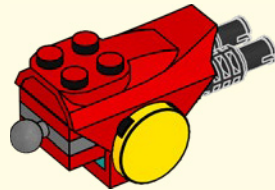



1x

45

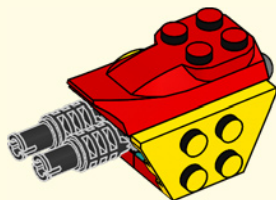

1x

46

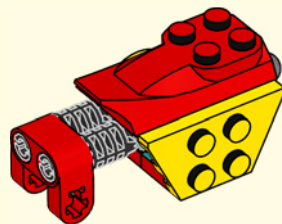



1x



1x

47

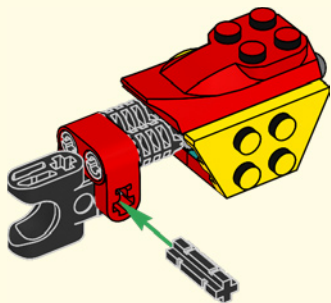

1x

48

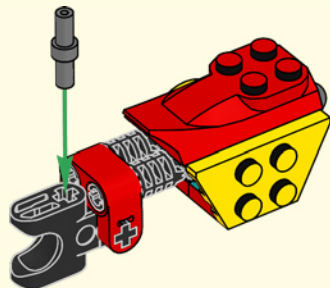



1x

49

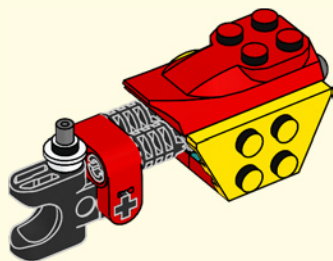

1x



1x



1x

50

1

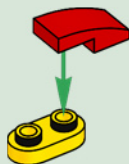

2

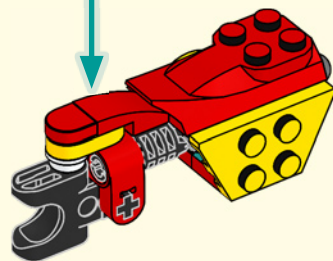



1x



1x

51

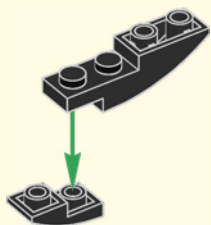

1x



1x

52

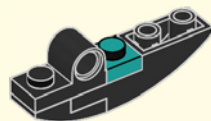



1x

53

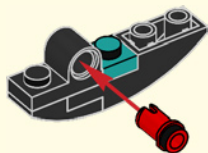

1x



1x

54

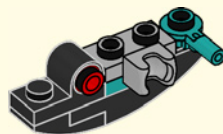



1x

57

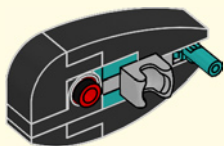

1x



1x



1x

58

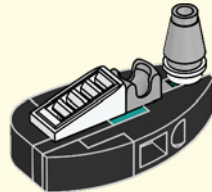
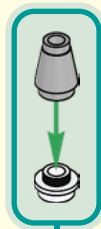

59

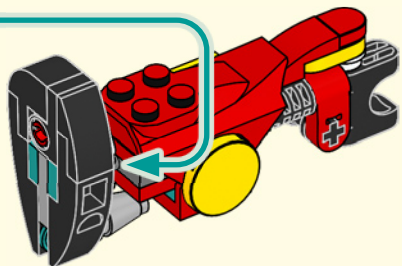

60

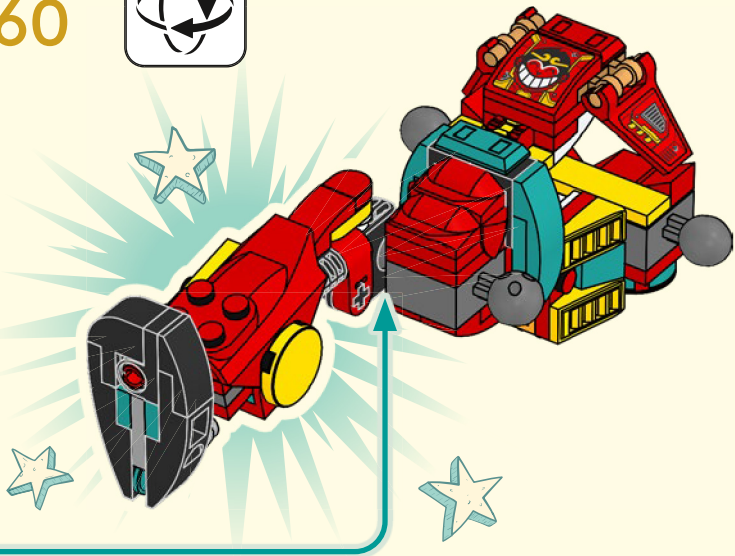

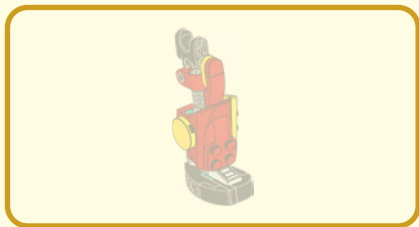

61

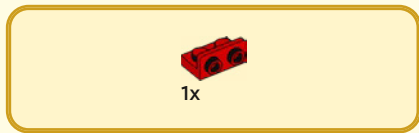
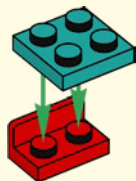

62

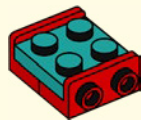



1x

63

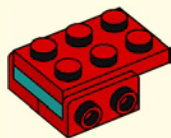

1x



2x

64

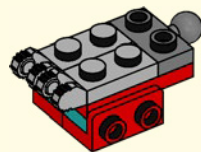



1x

65

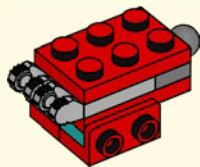

2x

66

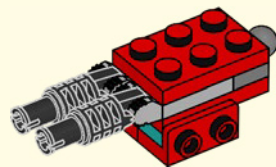



1x

67

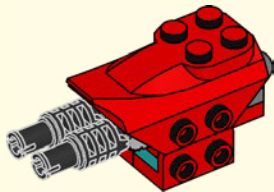

1x

68

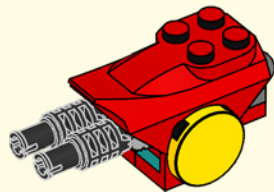



1x

69

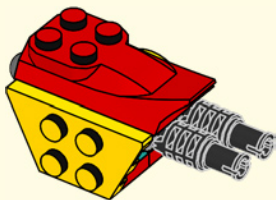

1x

70

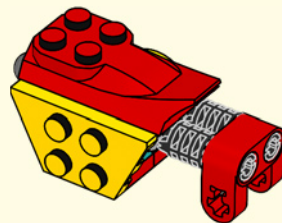



1x



1x

71

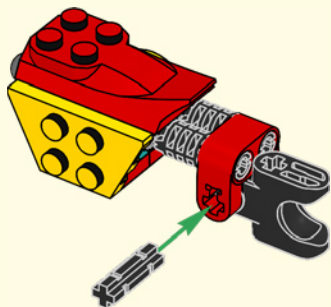

1x

72

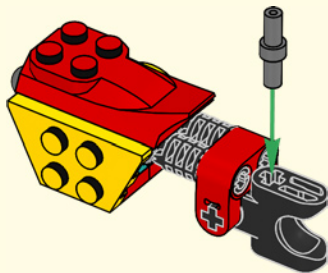



1x

73

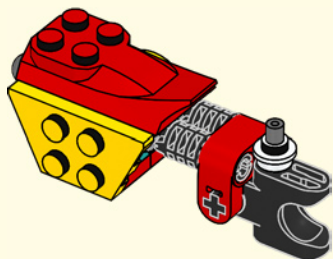

1x



1x



1x

74

1



2

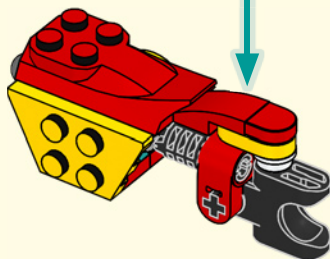



1x



1x

75

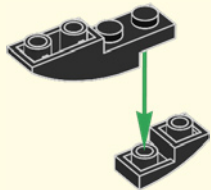

1x



1x

76

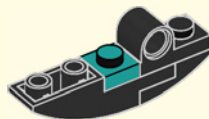



1x

77

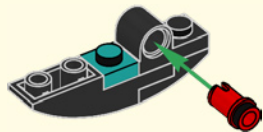

1x



1x

78

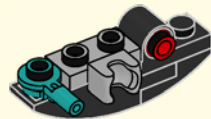



1x

79

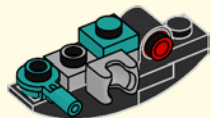

1x

80

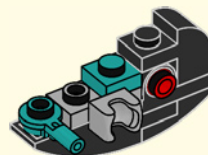



1x

81

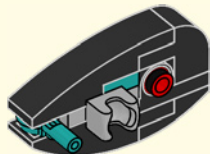

1x



1x



1x

82

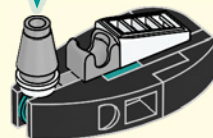
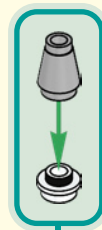

83

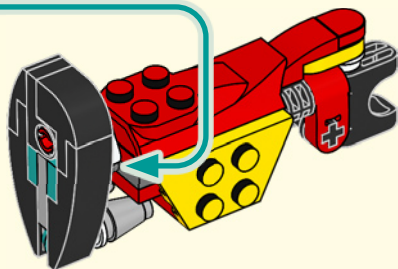

84

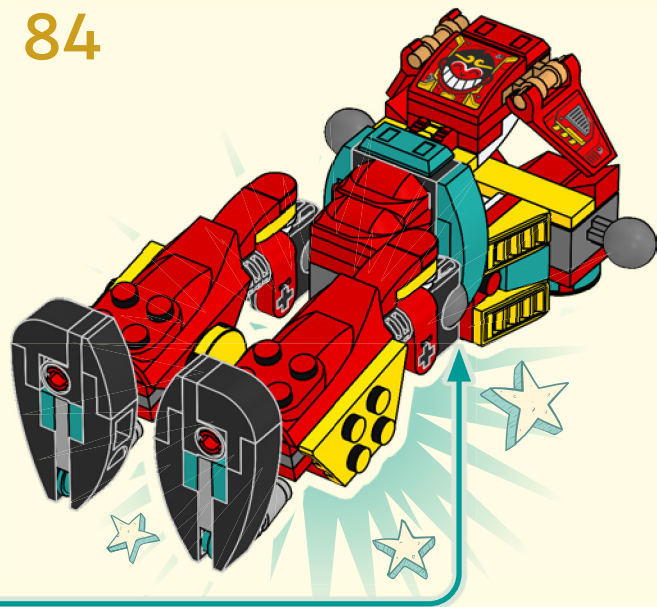



1x

85

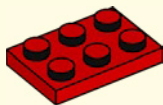

1x



1x

86

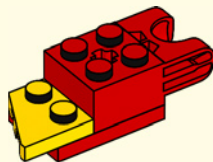



1x

87

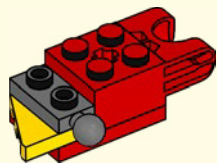

2x

88

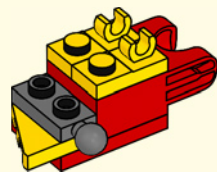



2x

89

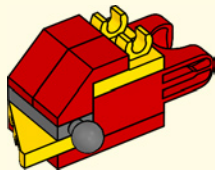

90

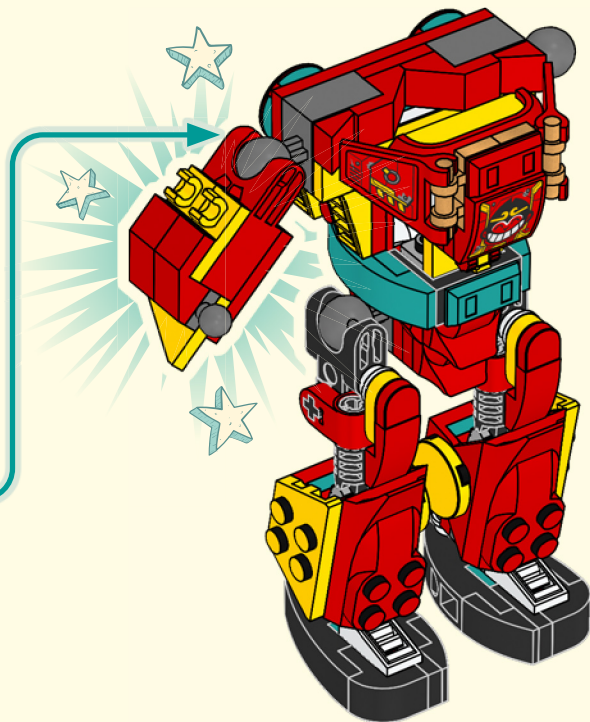



1x



1x

91

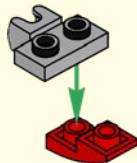

1x



1x

92

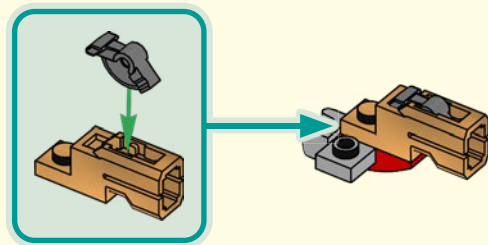



1x



1x

93

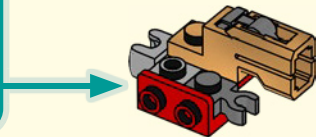
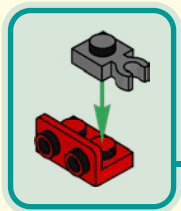

1x

94

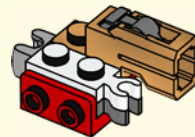



1x

95

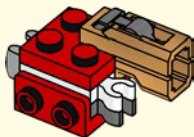



1x



1x

96

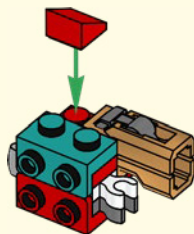

1x

97





1x



1x

98

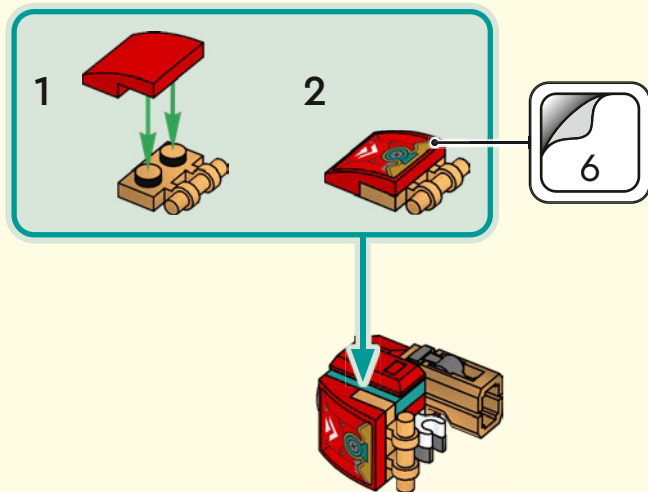



3x

99



100

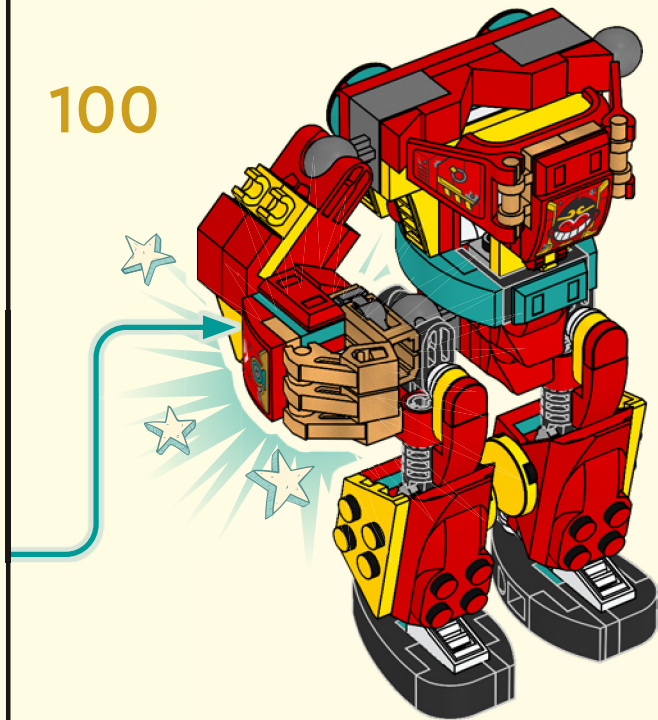



1x

101

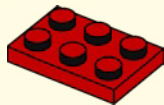

1x



1x

102

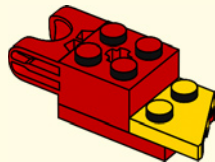



1x

103

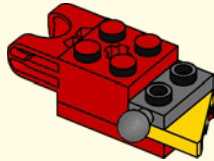

2x

104

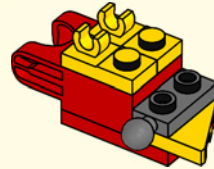



2x

105

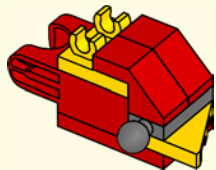

106

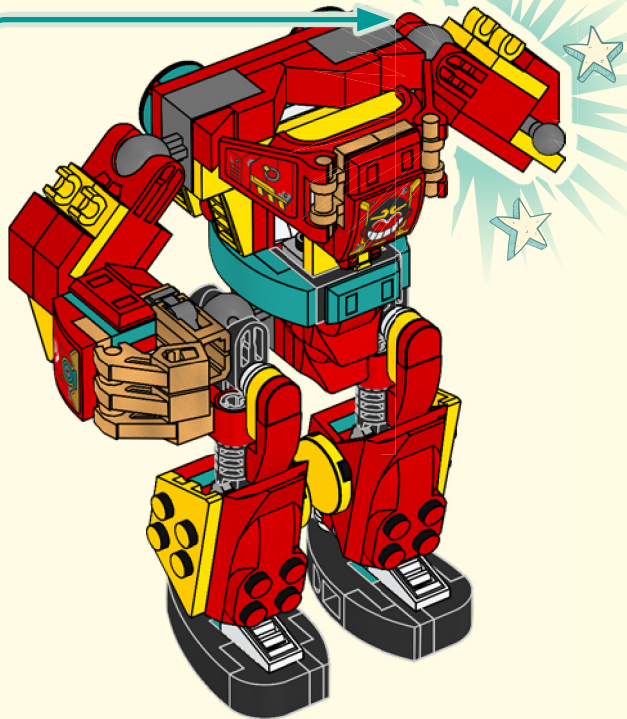



1x



1x

107

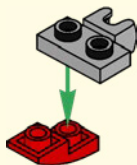

1x



1x

108

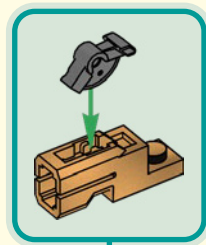



1x



1x

109

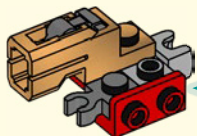
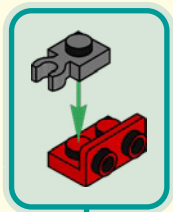

1x

110

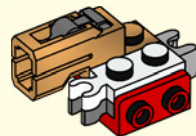



1x

111



1x



1x

112

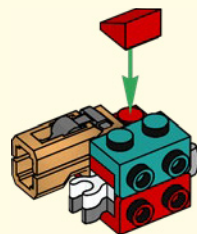



1x

113

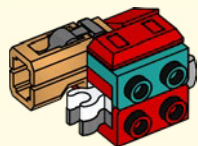



1x



1x

114

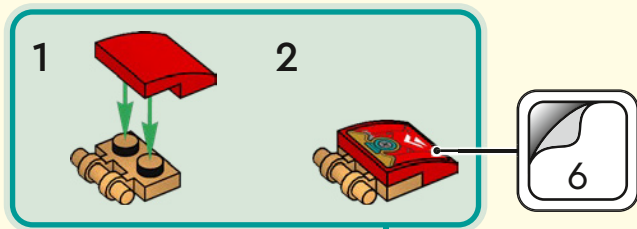

3x

115



116

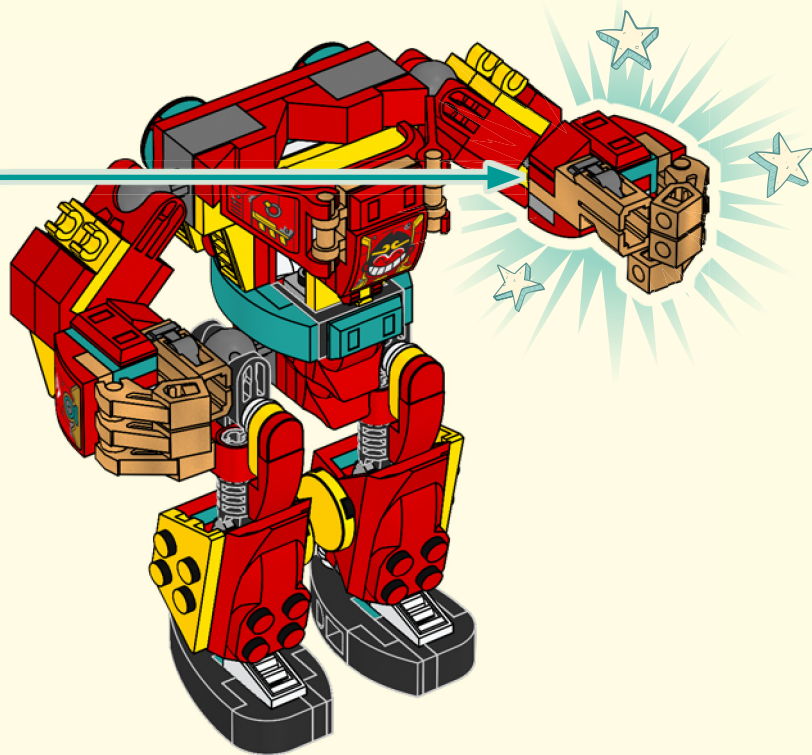



2x



2x



2x



4x



4x



2x

117

1

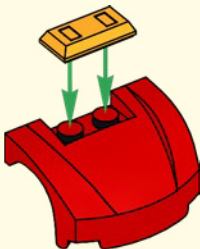

2

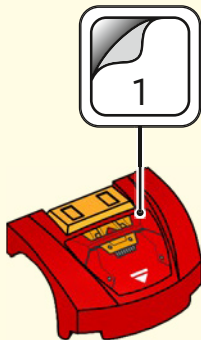

3

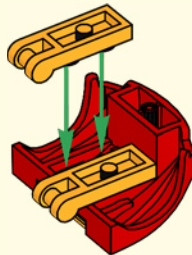

4

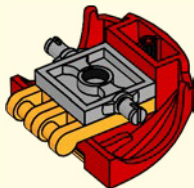

5

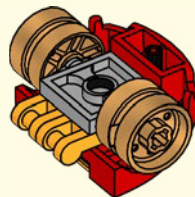

2x

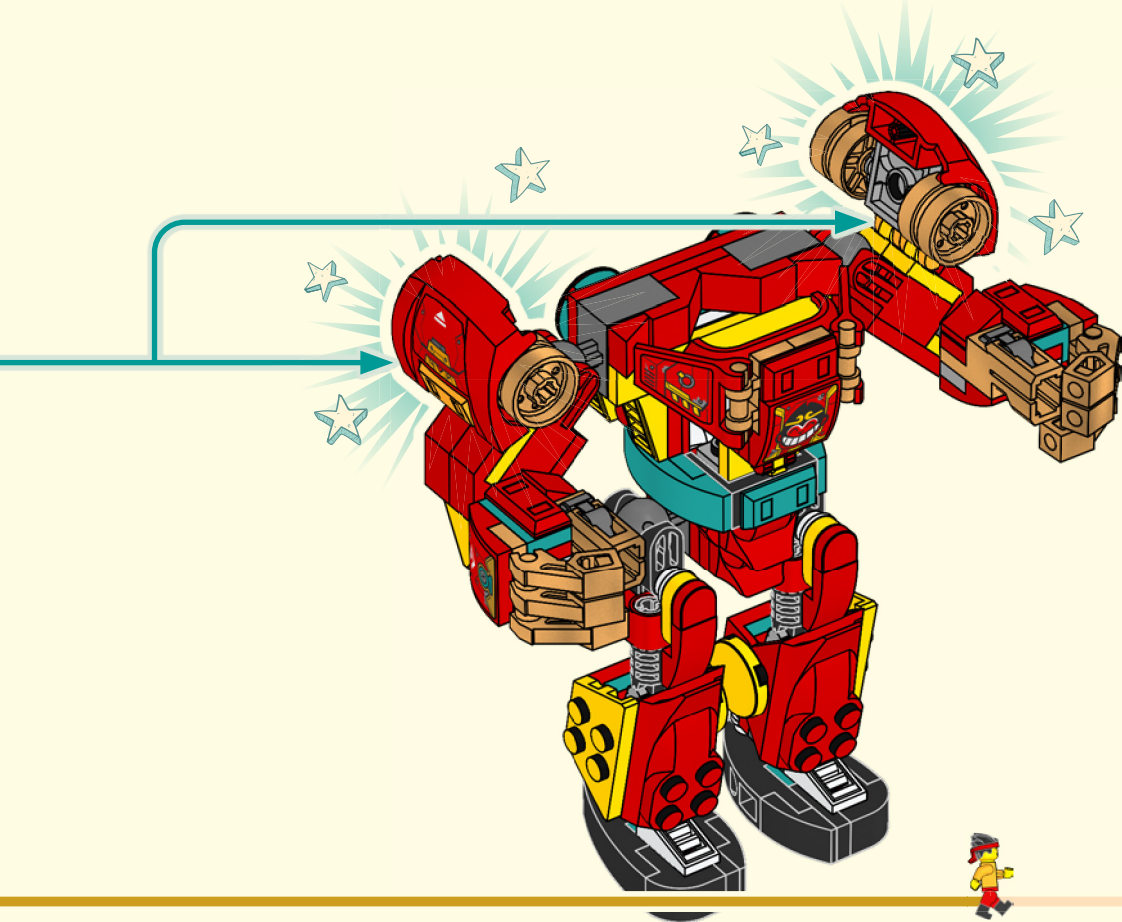

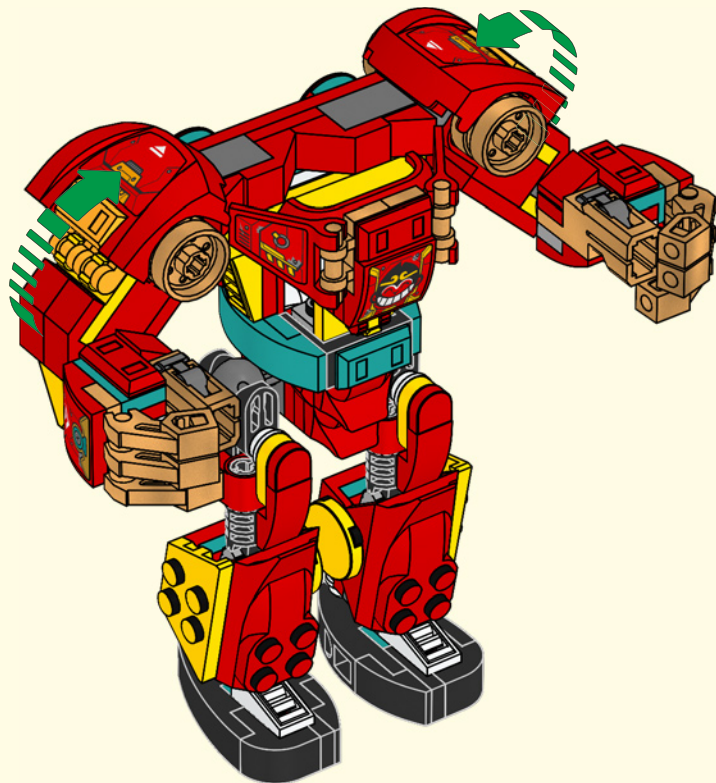

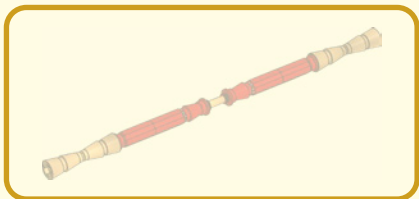

119

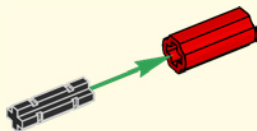

120

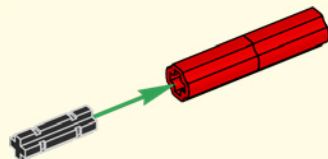



1x



1x

121

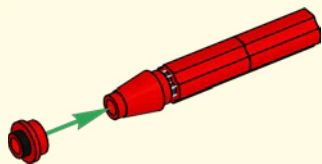

1x

122

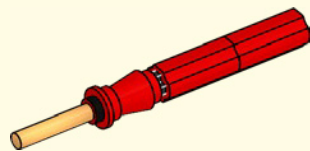



2x



2x



1x



1x

123

1

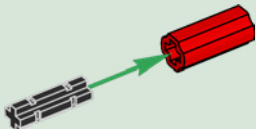

2

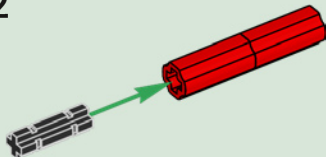

3

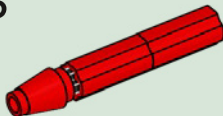

4

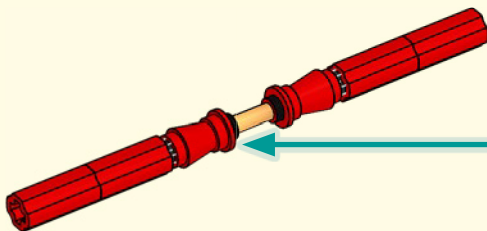
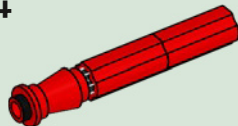



2x



1x



1x

124

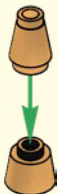

1x

125

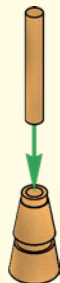



1x



1x



1x

126

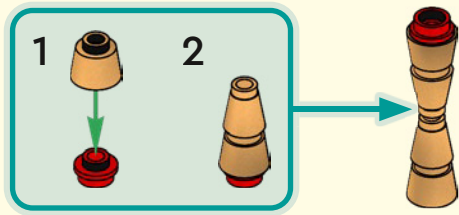

1x

127

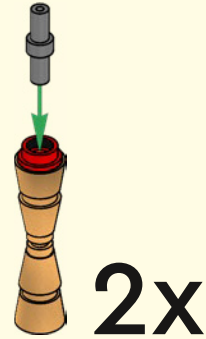

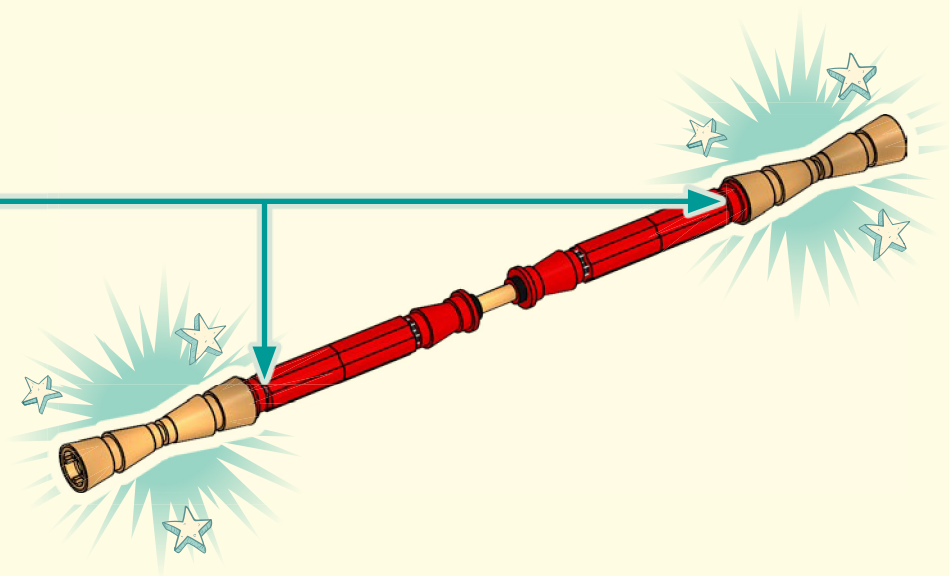

129

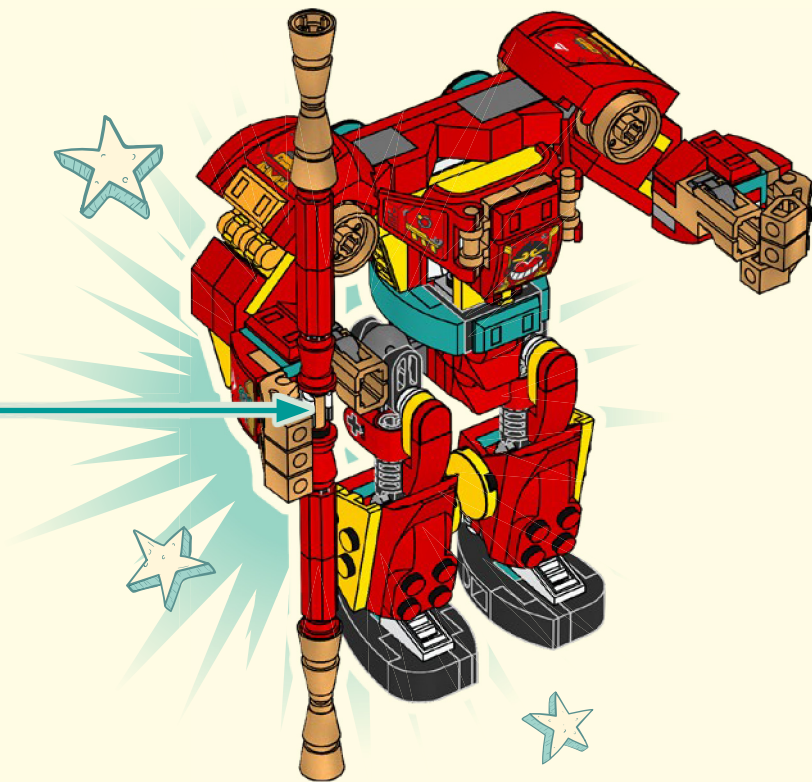

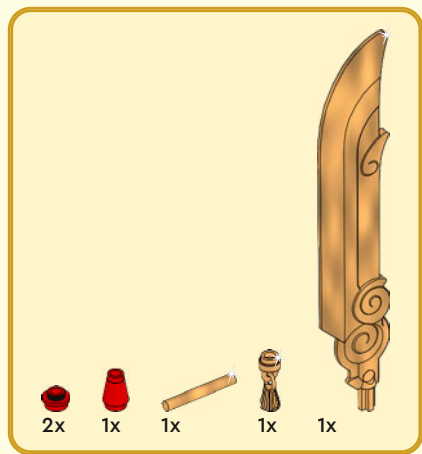

130

1

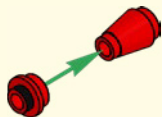

2

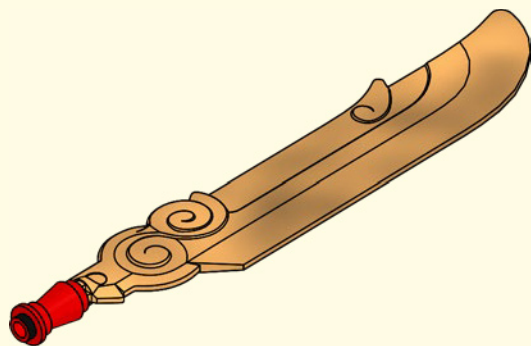

3

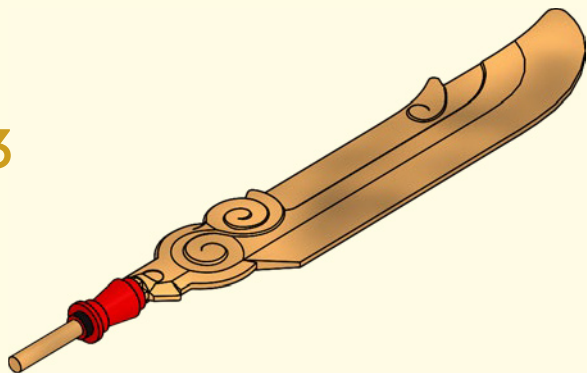

4

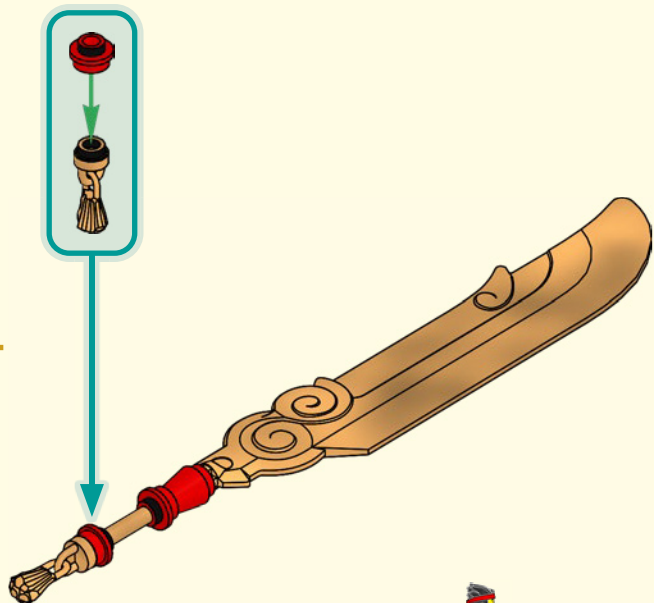

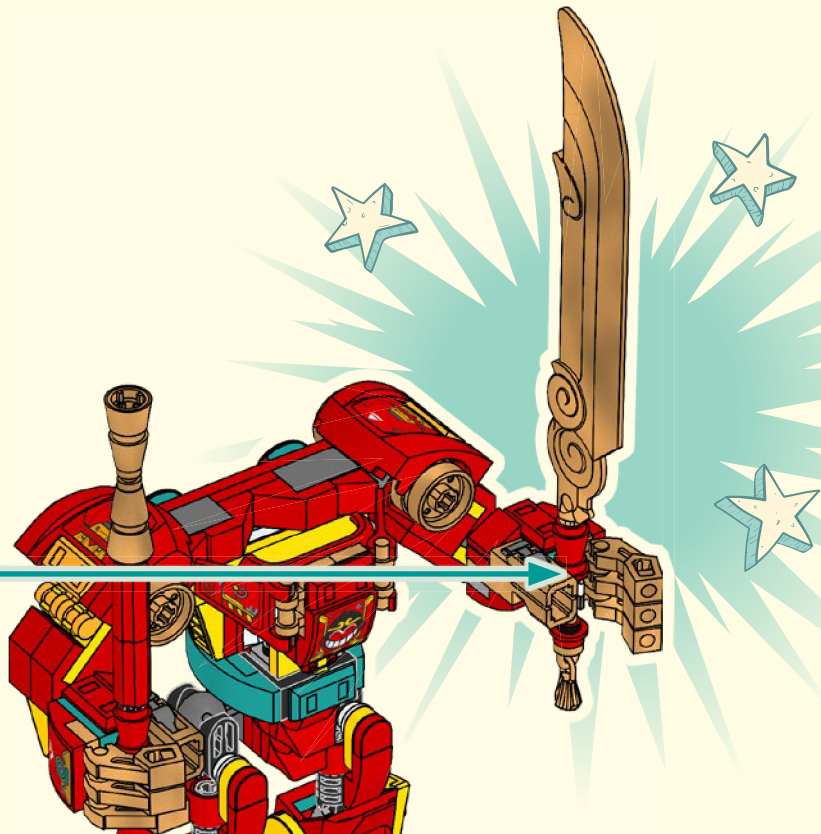

4x

131

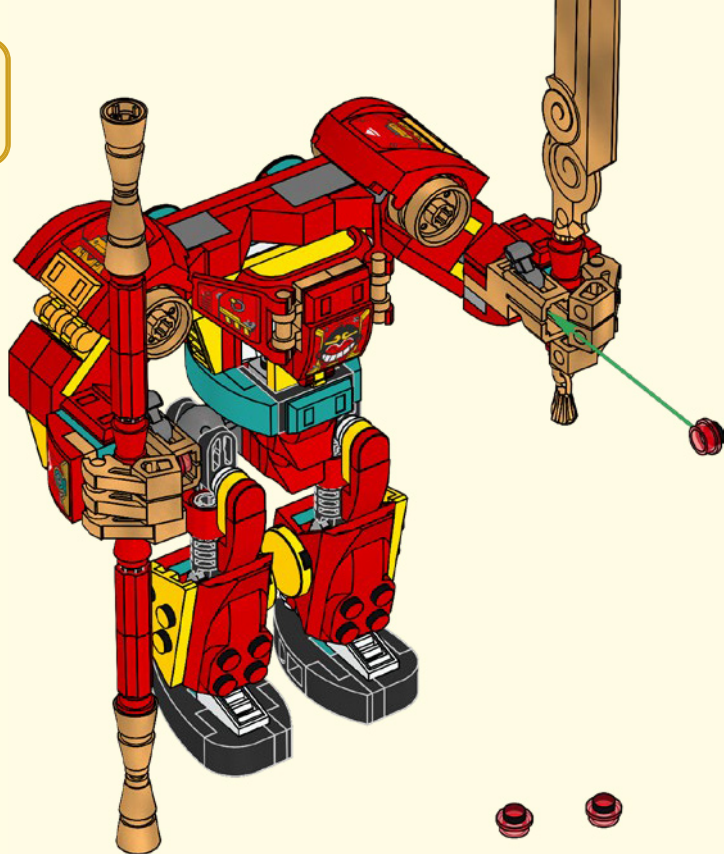

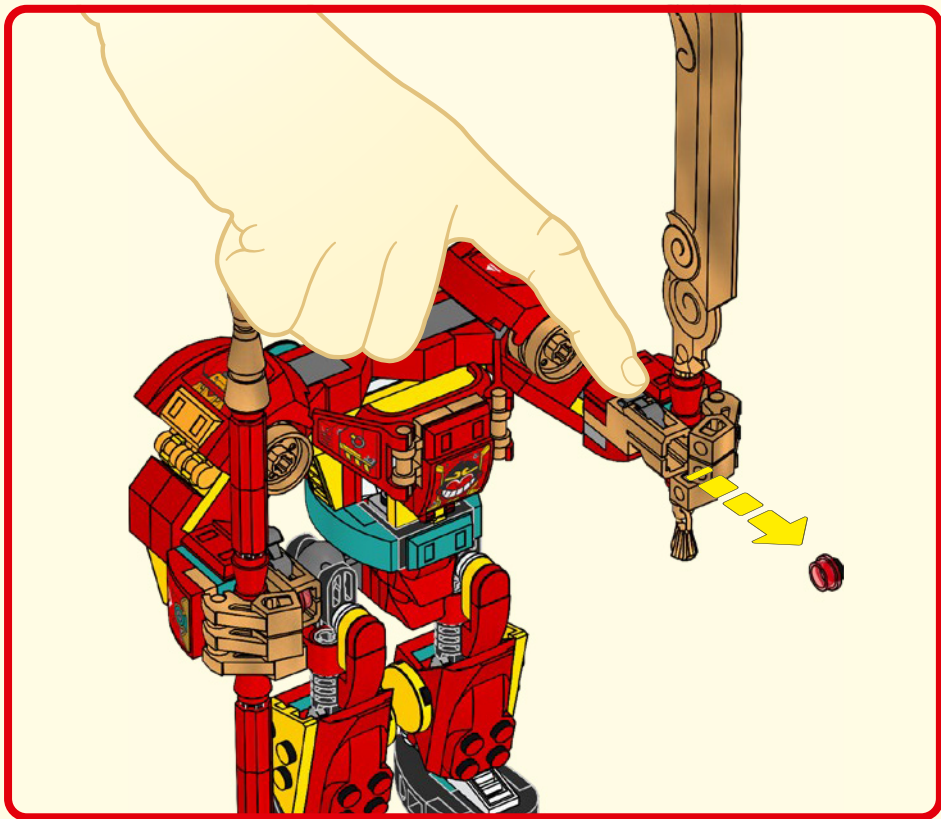

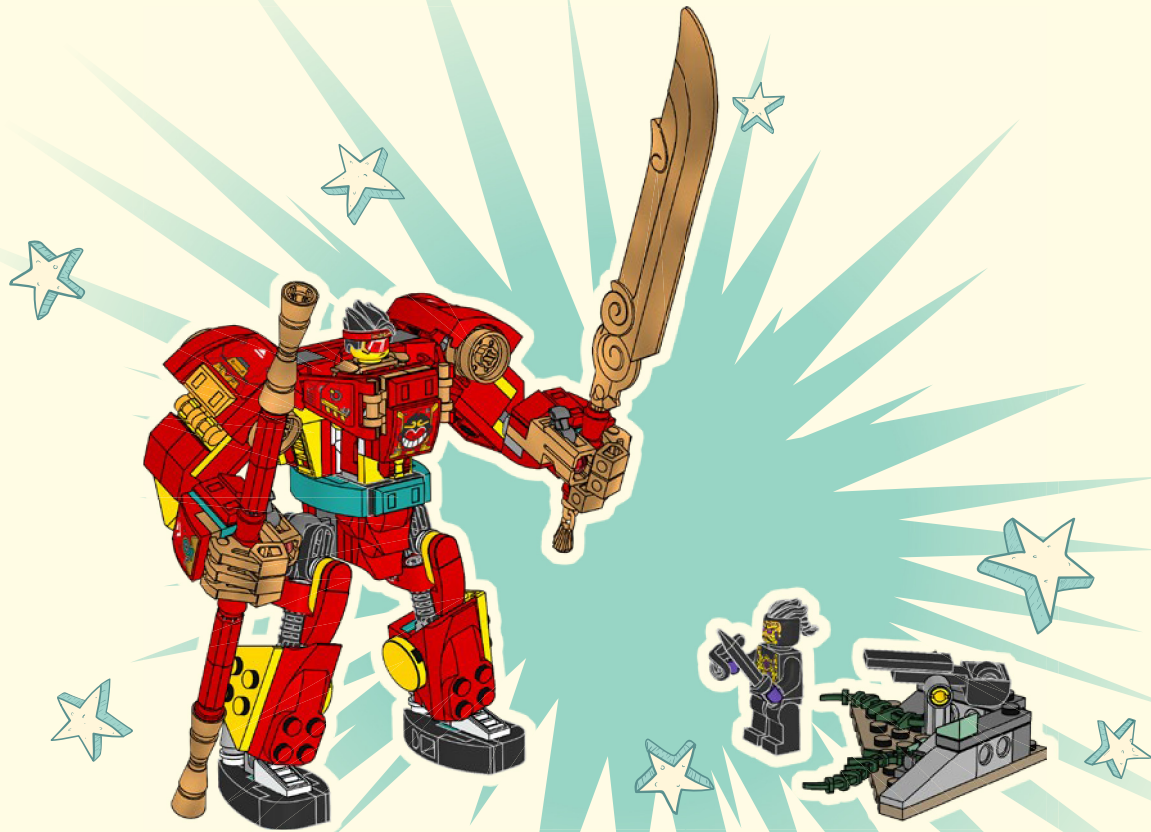



MONKIE KID 悟空小侠



COMBINE 80040+80041

Combine 80040 + 80041
Kombinierbar mit 80040 und 80041
Combinez les sets 80040 et 80041
Combina 80040 + 80041
可将 80040 和 80041 组合玩乐
Объедините наборы 80040 + 80041
Połącz 80040 + 80041

Zkombinujte stavebnice 80040 a 80041
Skombinujte stavebnice 80040 a 80041
Kombinálđ a 80040-es és 80041-es szettel!
Combină 80040 + 80041
Комбинируйте 80040 + 80041
Savieno komplektus 80040 un 80041
Sobita kokku komplektid 80040 ja 80041
Sujunkite 80040 + 80041





MONKIE KID 悟空小侠



80040



80043



80045



80041

**COMBINE
80036+80044**



COMBINE 80036 + 80044 / KOMBINIERBAR MIT 80036 UND 80044 / COMBINEZ LES SETS 80036 ET 80044 / COMBINA 80036 + 80044 / 可将 80036 和 80044 组合玩乐 / ОБЪЕДИНИТЕ НАБОРЫ 80036 + 80044 / POŁĄCZ 80036 + 80044 / ZKOMBINUJTE STAVEBNICE 80036 A 80044 / SKOMBINUJTE STAVEBNICE 80036 A 80044 / KOMBINÁLD A 80036-OS ÉS 80044-ES SZETTTEL! / COMBINÁ 80036 + 80044 / КОМБИНИРАЙТЕ 80036 + 80044 / SAVIENO KOMPLEKTUS 80036 UN 80044 / SOBITA KOKKU KOMPLEKTID 80036 JA 80044 / SUJUNKITE 80036 + 80044

4x 6168642	2x 6258973	2x 6375708	1x 6296954	1x 6132609	3x 306226	2x 6114987	1x 6225386
2x 6337079	2x 6378120	4x 6186398	10x 302121	2x 6248971	2x 6422913	2x 6184784	4x 6208450
2x 6023804	4x 4504379	1x 6266205	2x 6406930	1x 6132201	1x 6417491	4x 6271542	4x 6213778
2x 6372037	2x 6224467	6x 6275178	2x 6078279	2x 6078279	1x 6422914	2x 6338289	2x 6278172
1x 6218822	2x 4278275	2x 6001806	1x 6170382	1x 6331822	2x 6380236	1x 6424050	2x 6333124
4x 4513174	4x 4513174	6x 6089698	2x 6422923	4x 4540384	1x 6303189	1x 4558170	2x 6210400
1x 4494474	1x 6366646	2x 6365503	2x 6371695	4x 6360077	2x 6279875	1x 6349964	1x 6391344
1x 6210385	2x 6349275	2x 242021	2x 4582843	1x 6410523	8x 4109810	1x 6037746	4x 6213777
1x 6261357	3x 6394880	3x 6105976	2x 6371695	2x 4260192	1x 9339	2x 6037746	2x 6249418
6x 6223427	2x 6029946	1x 6375861	1x 6366649	1x 663624	1x 6147050	2x 6039869	2x 6249390
3x 4529234							



2x
6249299



1x
6338181

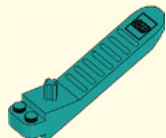

1x
6254100



1x
6395743



2x
6369999



2x
4652205



2x
6233984



2x
6249235



2x
6236454



4x
6248671



2x
4529241



1x
6296859



4x
6248078



4x
6043656



2x
4211541



4x
6267048



2x
6408022



1x
4622803



1x
6013497



2x
6344022



2x
6360675



4x
6350724



4x
6296892



2x
6039479



1x
4211135



2x
6123814



1x
4624186



2x
4497253



2x
6257592



1x
6065816



1x
6274711



4x
4529247



4x
6173139



6x
6262192

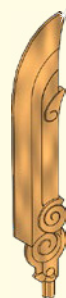

1x
6408777



4x
6279731



4x
6268401



4x
6093529



1x
6303532



2x
6345949



2x
6294553



[LEGO.com/service](https://www.lego.com/service)



YOU COULD
WIN



Scan this QR code or go to
LEGO.COM/PRODUCTFEEDBACK and give
us your short feedback about this LEGO® set
for a chance to win a cool LEGO prize.

Terms and Conditions apply*



DE: Du könntest GEWINNEN. Es gelten die Teilnahmebedingungen* **FR: Tu pourrais GAGNER.** Des conditions s'appliquent* **IT: Potresti VINCERE tu.** Termini e condizioni sono applicabili* **ES: Puedes GANAR.** Aplican términos y condiciones* **PT: Poderá GANHAR.** Aplicam-se termos e condições* **JA: プレゼント付き! 利用規約が適用されます*** **ZH: 轻松获奖. 条款和条件适用*** **KO: 상품의 주인이 되어보세요. 소정의 약관이 적용됩니다*** **RU: Вы можете ВЫИГРАТЬ.** Действуют положения и условия* **PL: Szansa na WYGRANĄ.** Obowiązują warunki korzystania* **CS: Máte šanci VYHRÁT.** Platí všeobecné smluvní podmínky* **SK: Máte šancu VYHRAŤ.** Platia všeobecné zmluvné podmienky* **HU: TE IS NYERHETSZ.** Felhasználási feltételek érvényesek* **RO: Ai putea CÂȘTIGA.** Se aplică termenii și condițiile* **BG: Можете да СПЕЧЕЛИТЕ.** Има определени правила и условия* **LV: Tu vari LAIMĒT.** Ir spēkā noteikumi un nosacījumi.* **ET: Sul on võimalus VÕITA.** Kehtivad tingimused* **LT: Jūs galite LAIMĖTI.** Taikomos sąlygos*
*LEGO.com/productfeedback-terms

LEGO and the LEGO logo are trademarks of the LEGO Group. ©2023 The LEGO Group.

6501854