

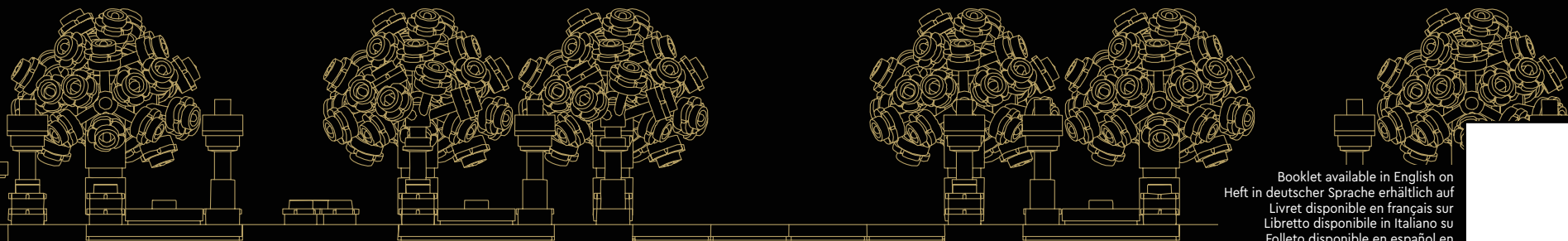

# Eiffel tower

Book 1



Booklet available in English on  
Heft in deutscher Sprache erhältlich auf  
Livret disponible en français sur  
Libretto disponibile in italiano su  
Folleto disponible en español en  
如需中文版手册, 请访问

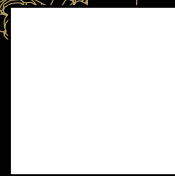



LEGO.com/sustainable-packaging



FR  
**DONNEZ**  
OU  
**RECYCLEZ**



ASSOCIATION

OU



MAGASIN

OU



DÉCHÈTERIE

Adresses sur [quefairedemesdechets.fr](http://quefairedemesdechets.fr)

# Eiffel tower

The Eiffel tower (La tour Eiffel) is the striking, iron lattice structure located on the Champ de Mars in the French capital. It's named after the engineer, Gustave Eiffel, whose company designed and built the tower as the impressive entrance to the 1889 Exposition Universelle, or World's Fair. Rising 324 m (1,063 ft.) into the air, it's one of the most recognisable structures in the world and an iconic symbol of both the city of Paris and France.



# The original idea

When it was decided to mark the 100-year anniversary of the French Revolution with a World Fair, an official competition was launched to find a suitable centrepiece for the exhibition. From the 107 different projects that were submitted, the committee selected Gustave Eiffel's vision for a 300-m (985 ft.) tall iron tower.

Two of his engineers, Maurice Koechlin and Emile Nouguier, already had an idea for a large pylon with four separated columns of latticework girders coming together at the top. Company architect Stephen Sauvestre then proposed stonework pedestals to dress the legs and decorative arches to link the columns at the first level.

Gustave Eiffel hoped the structure would come to symbolise *"not only the art of the modern engineer, but also the century of Industry and Science in which we are living."*

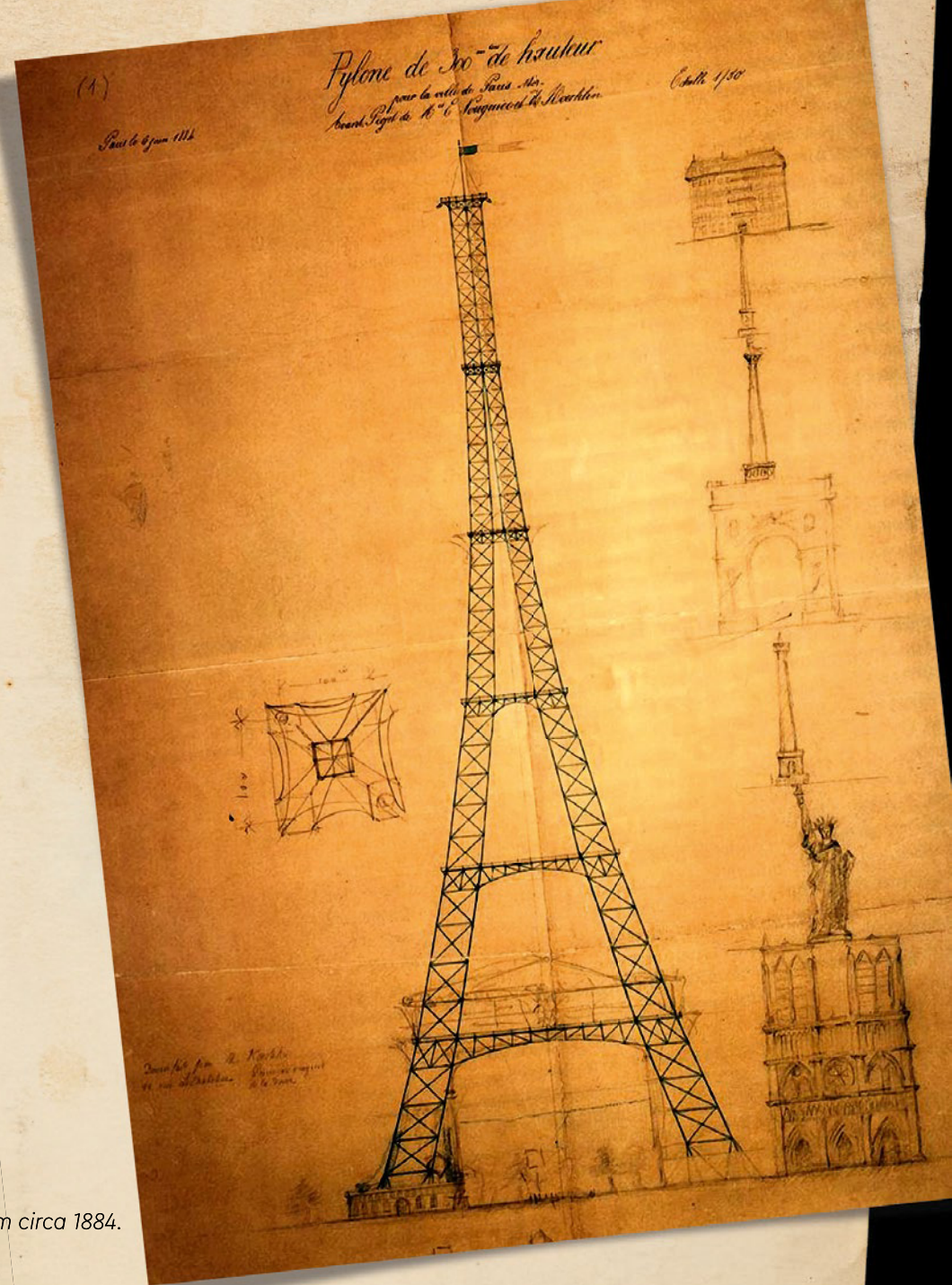

An early sketch of the tower from circa 1884.

# Gustave Eiffel

## (1832 – 1923)

Born on 15 December 1832, in Dijon, France, Gustave Eiffel was an exceptionally gifted engineer and builder. He graduated from the École Centrale des Arts et Manufactures in 1855 and established his own construction company in 1864.

He made his name creating a large and varied number of metal structures, including everything from railway bridges and viaducts to the internal framework for the Statue of Liberty. He and his company were known for their ingenuity and inventiveness, which culminated with the construction of the Eiffel tower.

**“I ought to be jealous of the tower.  
She is more famous than I am.”**

*GUSTAVE EIFFEL*



# Under construction

Gustave Eiffel's company produced over five thousand drawings in preparation for joining the 18,038 individual pieces together to form the tower. Work on the foundations started in January 1887 and the assembly of the tower began on July 1 of that year.

All the elements were prepared in Eiffel's factory located at Levallois-Perret on the outskirts of Paris. The pieces were hauled up by steam cranes, which themselves climbed up the tower as the construction continued.

After two years, two months and five days the structure was completed and in March 1889, Eiffel led a group of government officials and the press to the top of the tallest structure in the world. Since the lifts were not yet in operation, the ascent was made by foot and took over an hour. Here Eiffel unfurled a large Tricolore to the accompaniment of a 25-gun salute.

*Gustave Eiffel constructed and reserved a small flat for himself at the top of the tower to entertain guests. It's now open to the public, complete with period decorations and lifelike mannequins of Eiffel and some of his notable guests.*

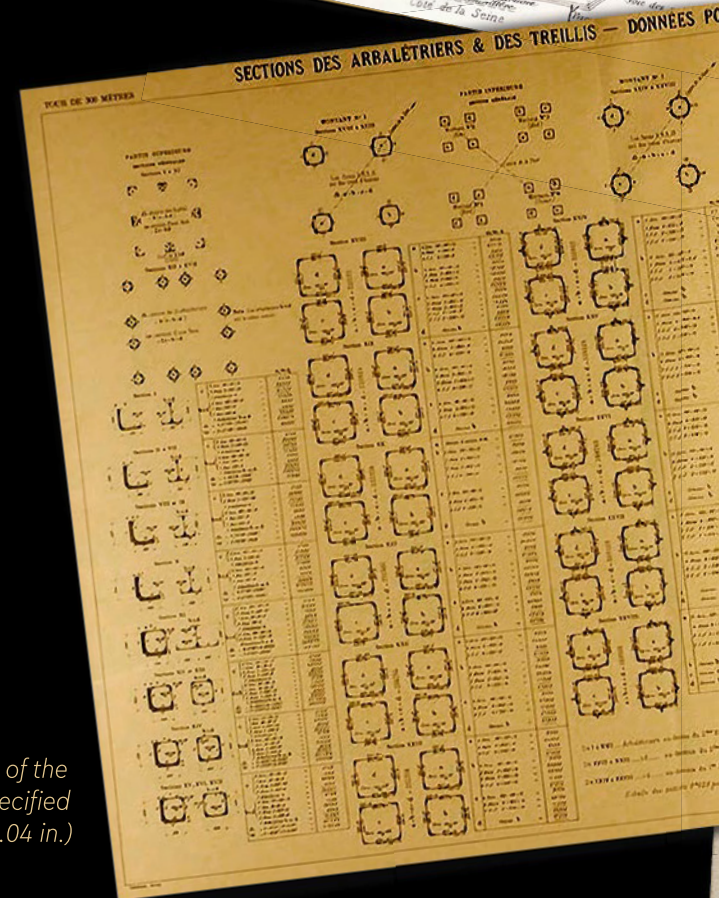
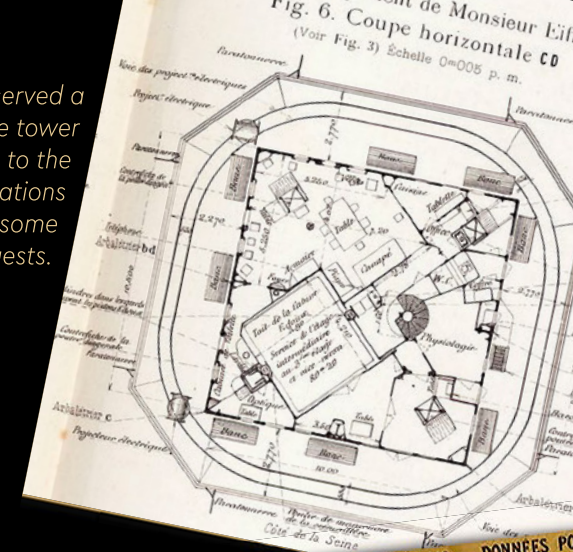

*The position of each of the 2,500,000 rivet holes was specified to within 0.1 millimetre (0.04 in.)*



*The tower as a gateway to the World's Fair.*

# Exposition Universelle 1889

The 1889 World's Fair contained over 61,000 individual exhibitors, 25,000 of whom were from outside France, and covered subjects such as science, technology, industrial engineering and fine arts. The Exposition stretched over two large sites in the city and attracted 32 million visitors in the six months it ran. The Eiffel tower itself proved an immediate success with the public and lengthy queues formed to make the ascent. Tickets cost two francs for the first level, three for the second and five for the top, with half-price admission on Sundays. By the end of the Fair in October 1889, the tower alone had had nearly two million visitors.

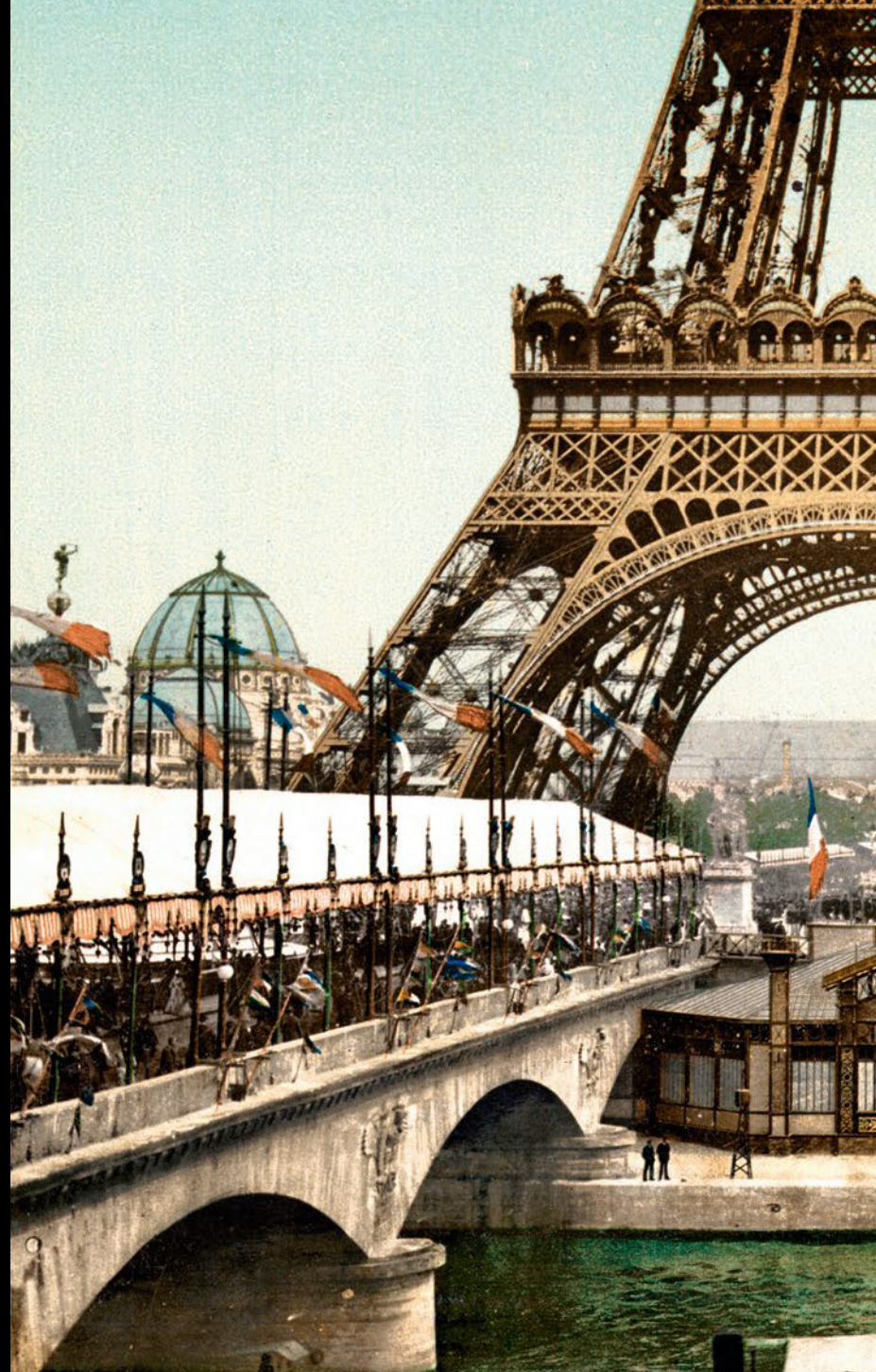





# The tallest structure in the world

Builders, architects and engineers have always had a desire to reach for the stars and create tall buildings. As tools and technologies improved through time, so did the scale and magnitude of these efforts. The Eiffel tower was the first structure in the world to surpass both the 200-meter (656-ft.) and 300-meter (984-ft.) mark in height and became the tallest man-made structure when it was completed in 1889. It would remain so until 1930 when the 319-m (1,046-ft.) tall Chrysler Building in New York, USA, opened.

# From then until now

Eiffel had a permit for the tower to stand for twenty years after which it was to be dismantled. He successfully argued the structure was valuable for communication and scientific purposes and the tower was allowed to stand. A meteorology lab and a small wind tunnel were installed and over 5,000 scientific tests were carried out. With the advent of wireless telegraphy, the top of the tower would be modified to accommodate an ever-growing number of antennas, plus a television mast that extended the height of the tower to 324 meters (1,063 ft.).

Today the Eiffel tower also welcomes more visitors than any other paid monument in the world – an estimated seven million people per year. Some five hundred employees are responsible for its daily operation, ensuring that eager crowds enjoy panoramic views of the city.





“Can one think that because we are engineers, beauty does not preoccupy us or that we do not try to build beautiful, as well as solid and long-lasting structures?”

*GUSTAVE EIFFEL*



**“I was lucky enough to have been on top of the Eiffel tower twice as a boy.”**

ROK ZGALIN KOBE

## From the Design Team

Senior LEGO® Designer, Rok Zgalin Kobe was part of the team that brought this LEGO version of the iconic Eiffel tower to life.

*“My goal was to blend great LEGO execution with the design principles of the original tower. I tried to follow the structural principles of the real tower as closely as the LEGO System would allow. For example, the load-bearing trusses on the model are placed just like on the original. And just like the original structure, the critical stage of LEGO construction is joining the legs at the first level.*

*The biggest challenge of a set this size is to make it stable and buildable, and to translate the final model into the logical flow of a LEGO building instructions guide. To ensure it is easy enough to follow without mistakes, yet still challenging enough to be engaging throughout the building process.*

*I am humbled to play a part in translating one of the most recognisable structures in human history into a LEGO model. I've made smaller versions of the tower before, but this one – the tallest LEGO model to date – is very different scale-wise!”*

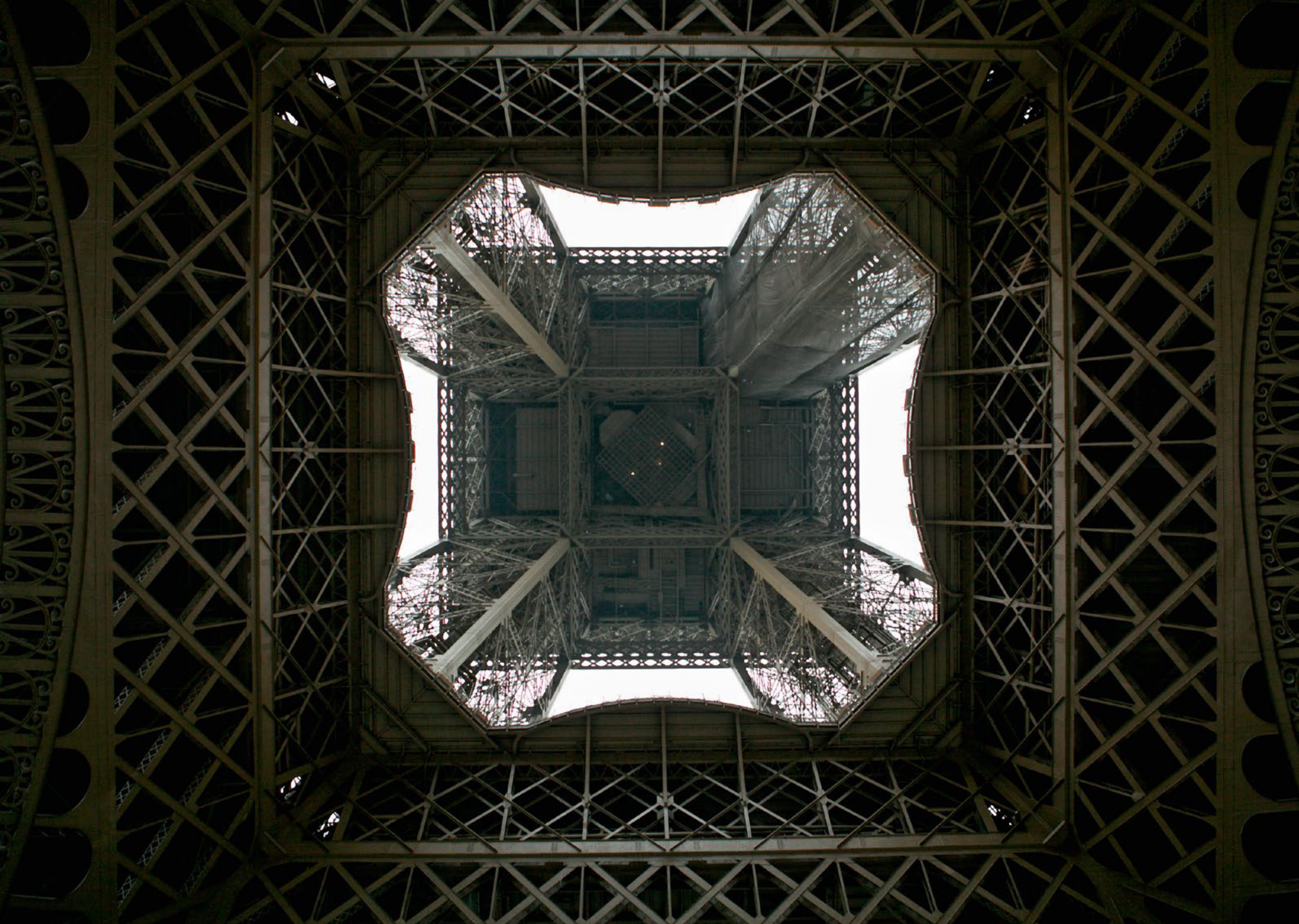

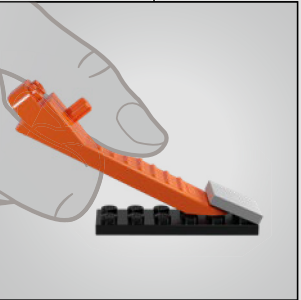
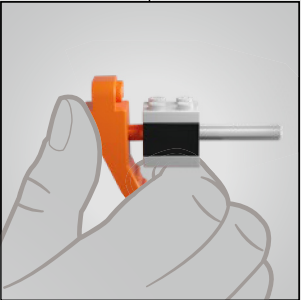
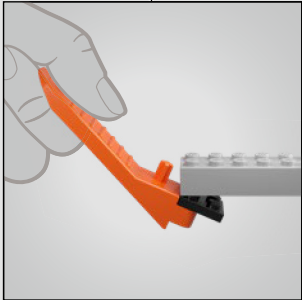
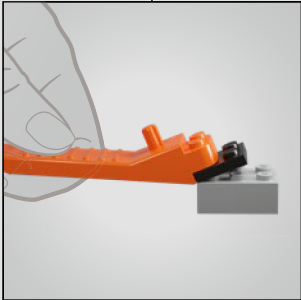
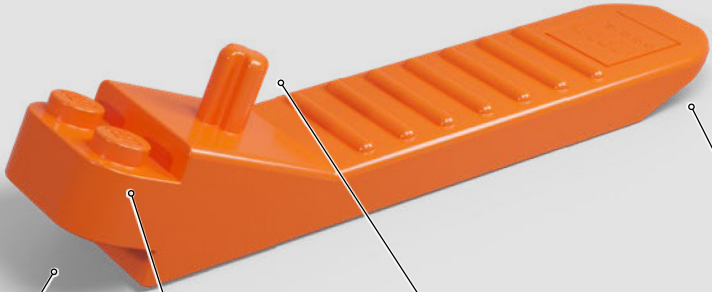

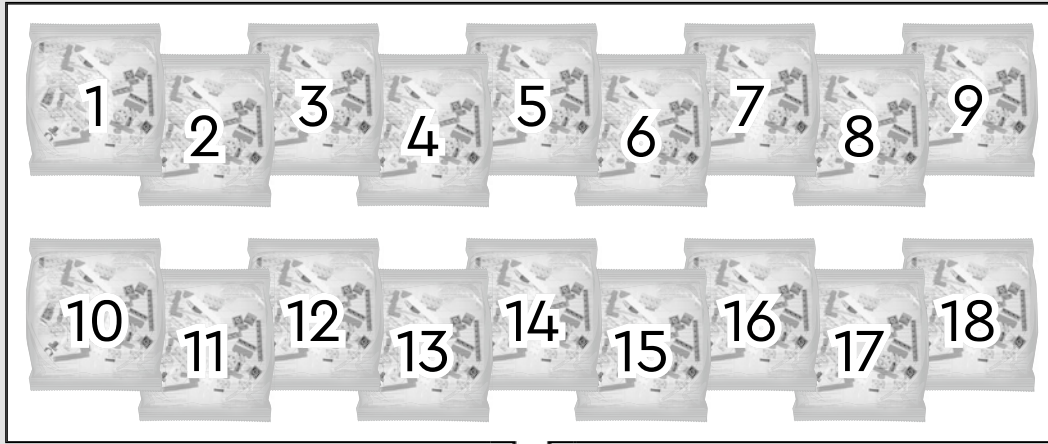



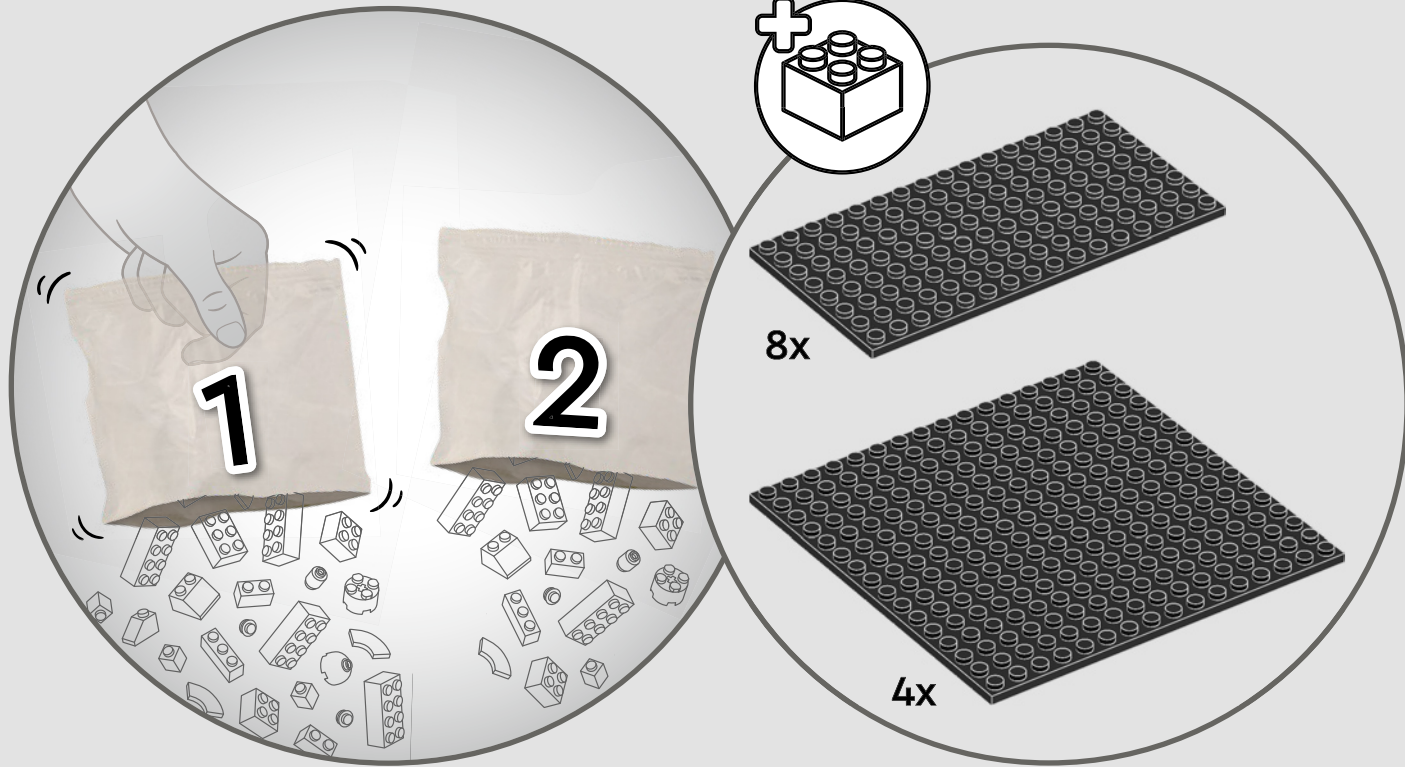



The Eiffel tower cost almost 8 million gold francs, or £1.02 million GBP to build.

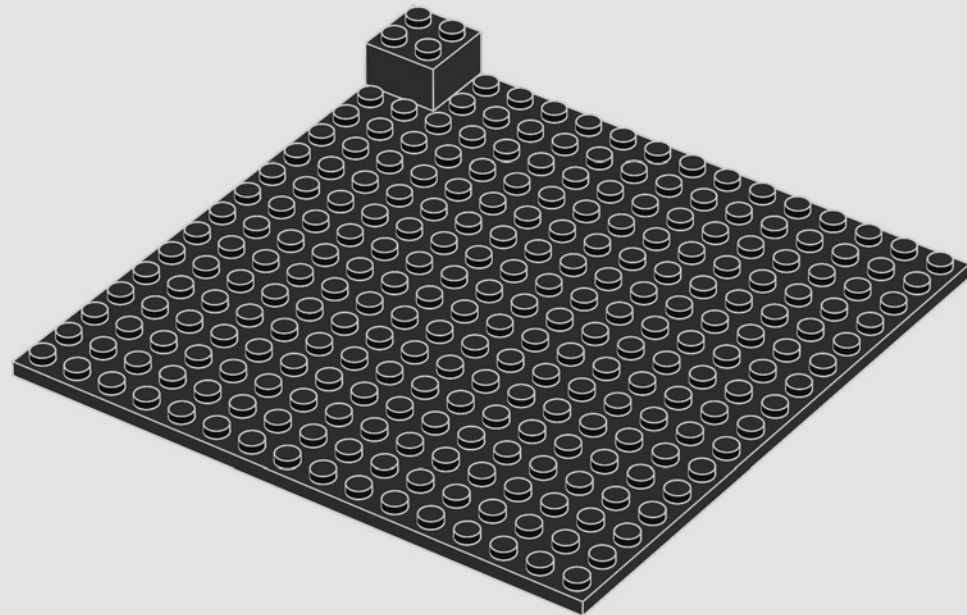
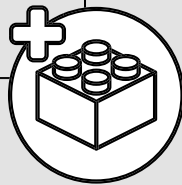
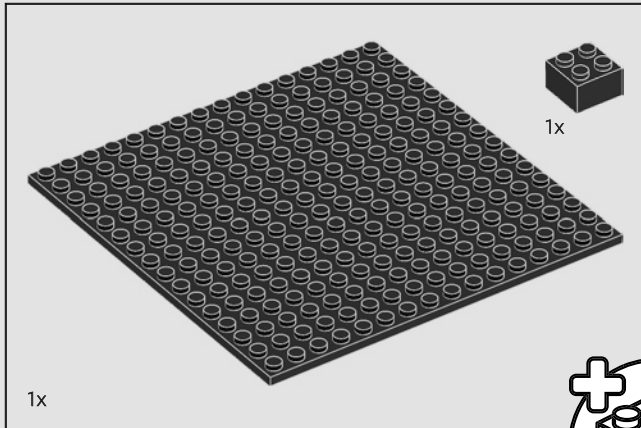
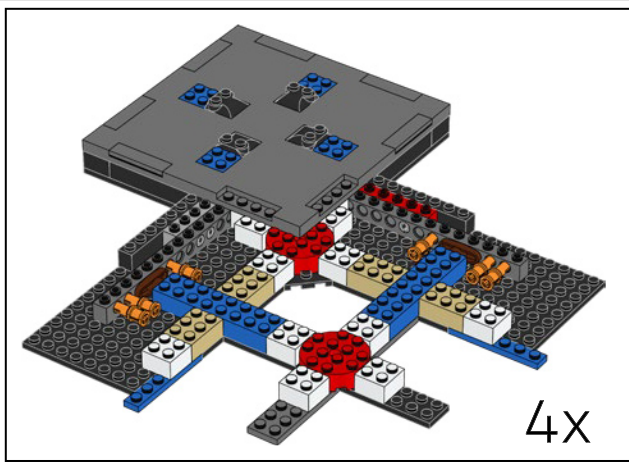

1

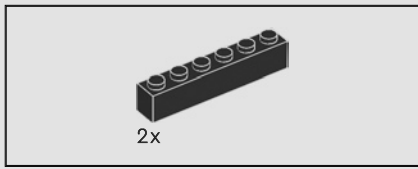

2

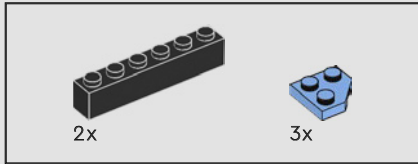
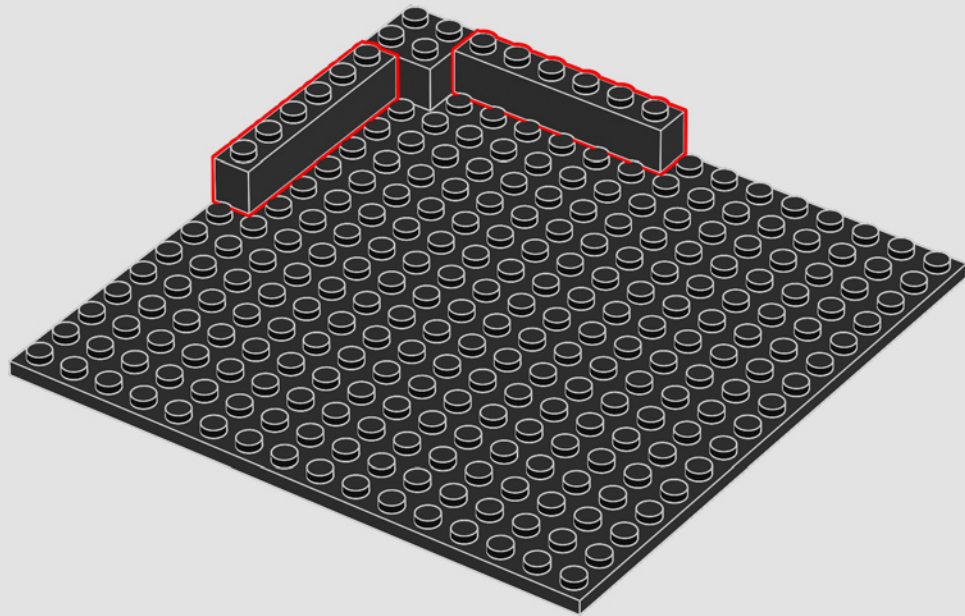

3

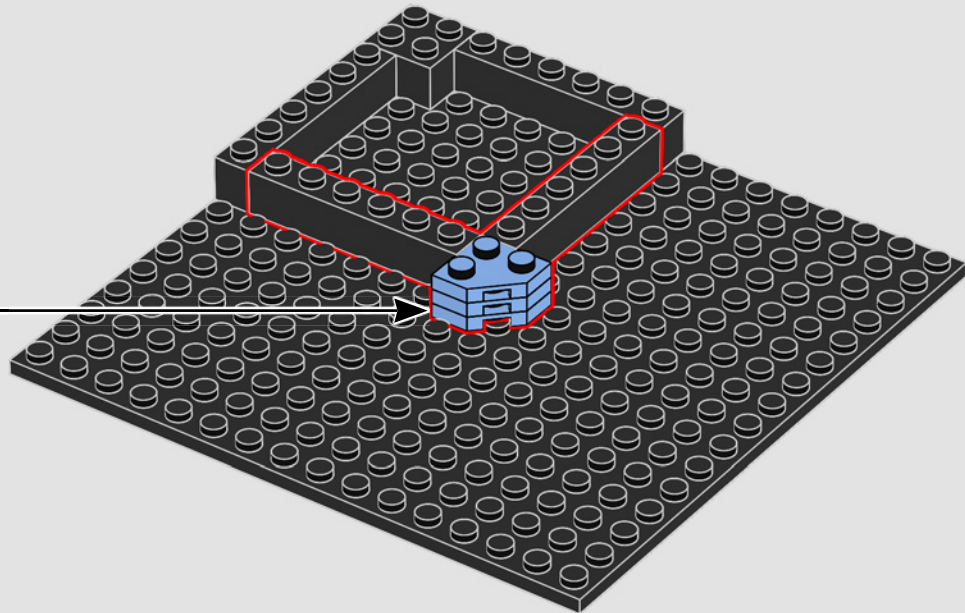
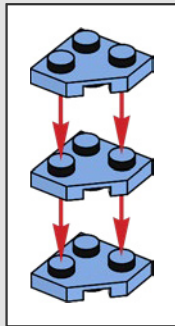

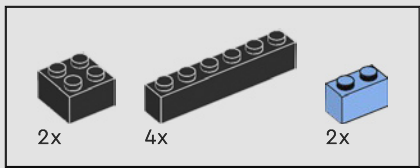

4

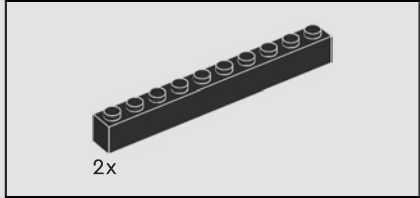
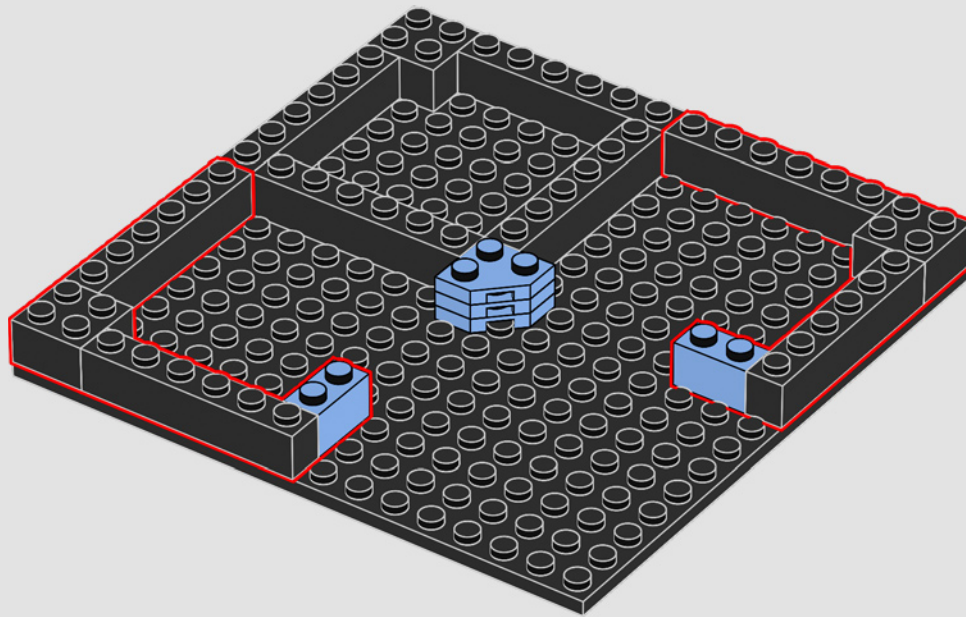

5

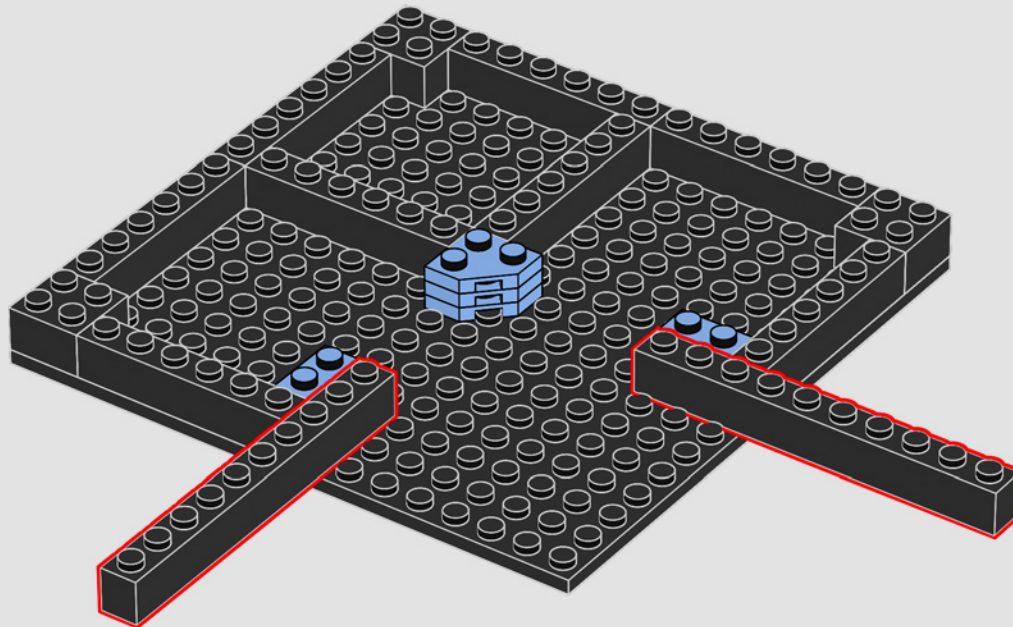

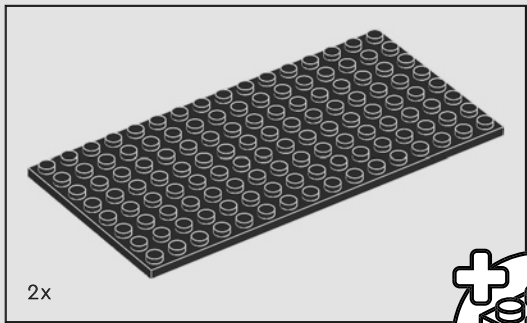

2x

6

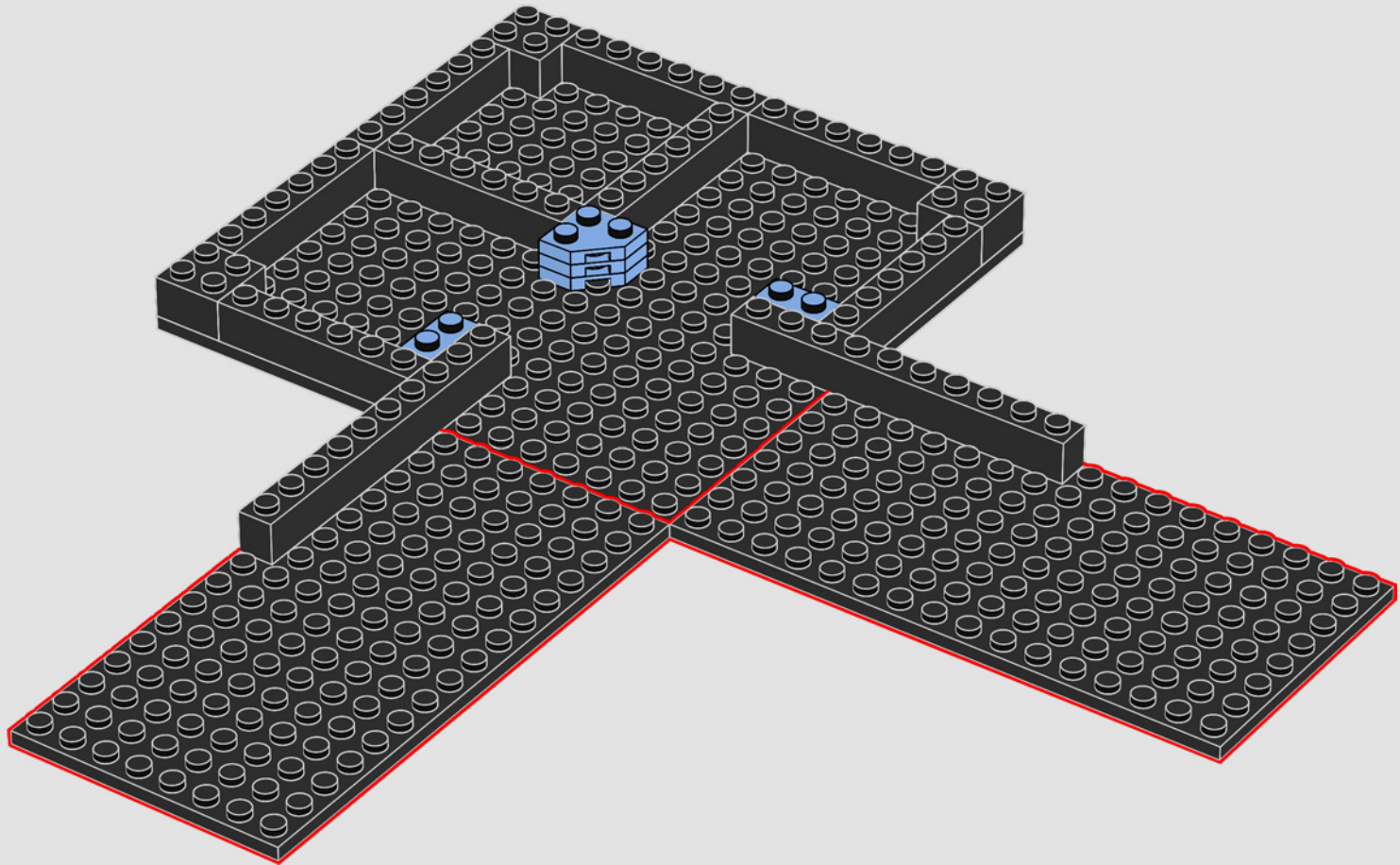
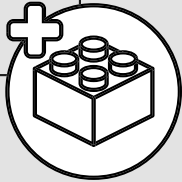

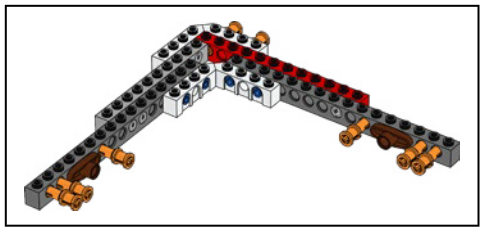

1

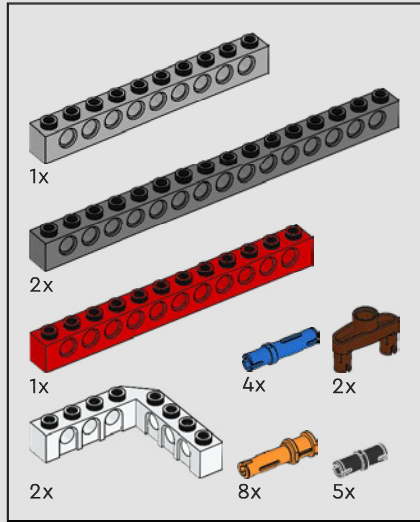
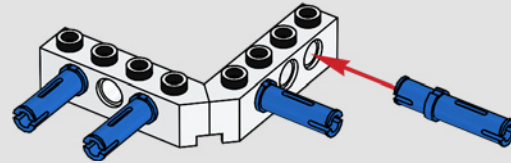

7

2

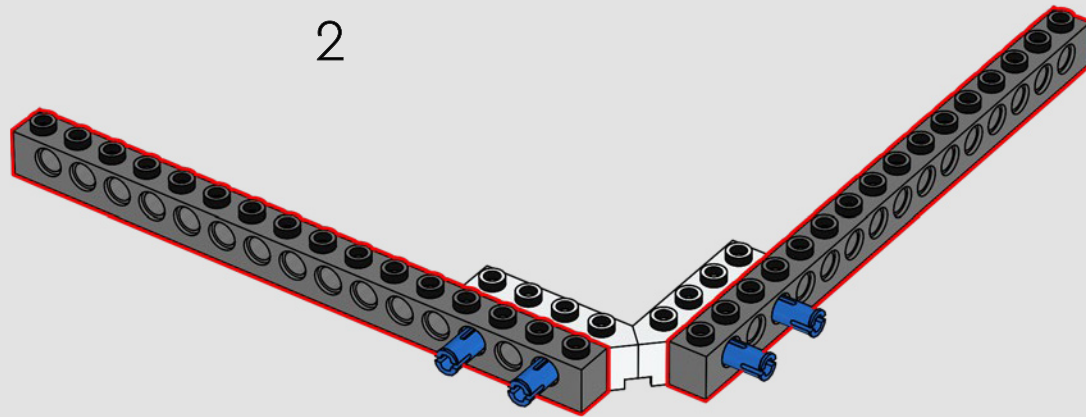

3

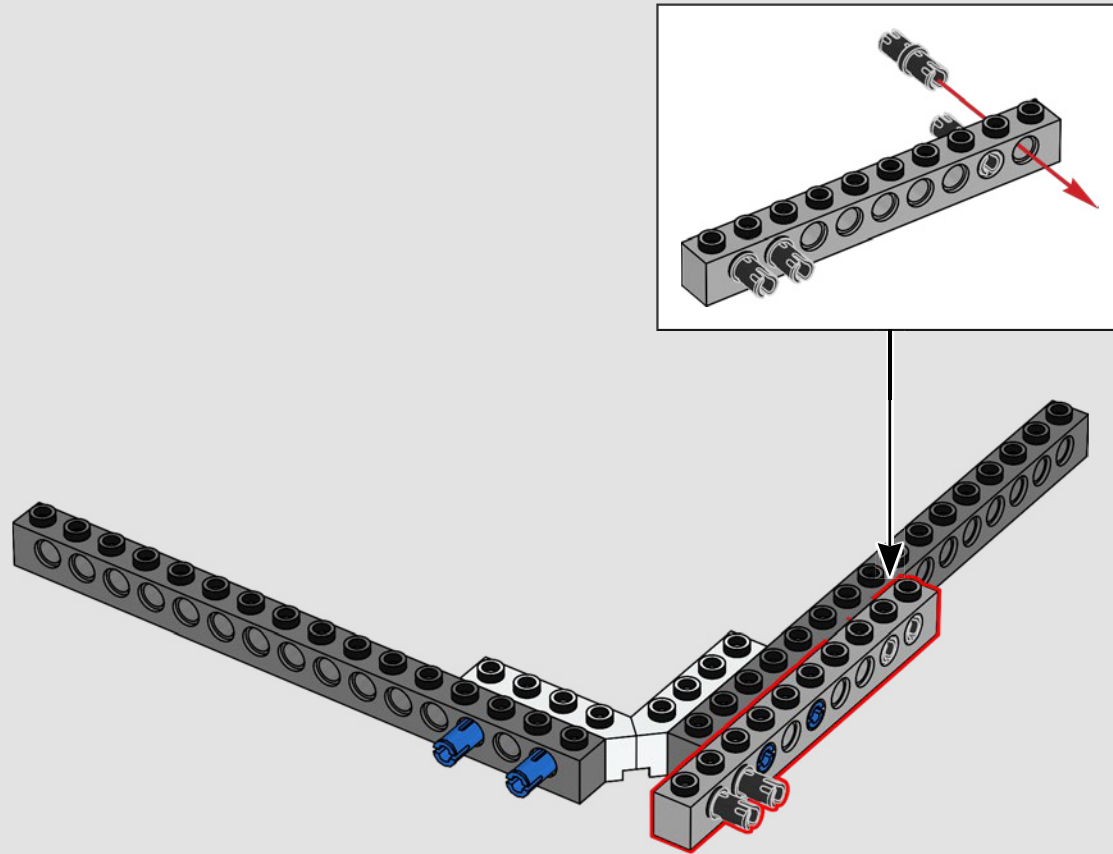

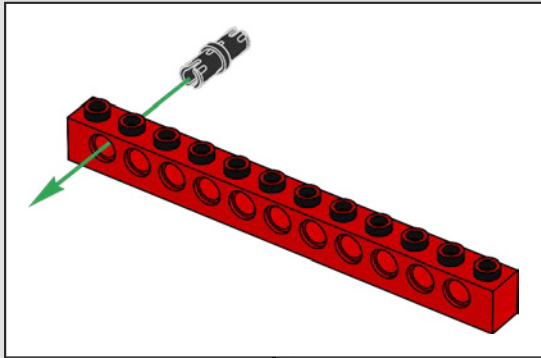

4

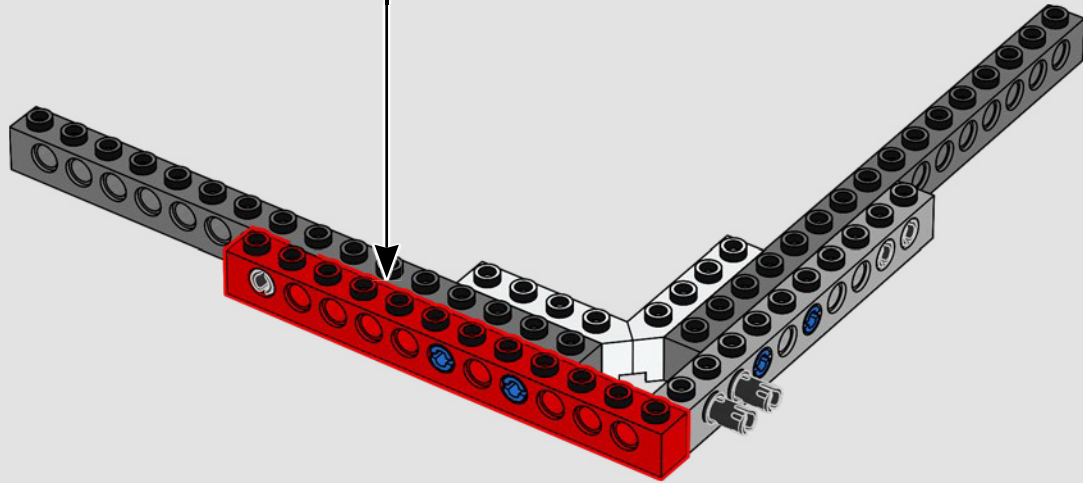



5

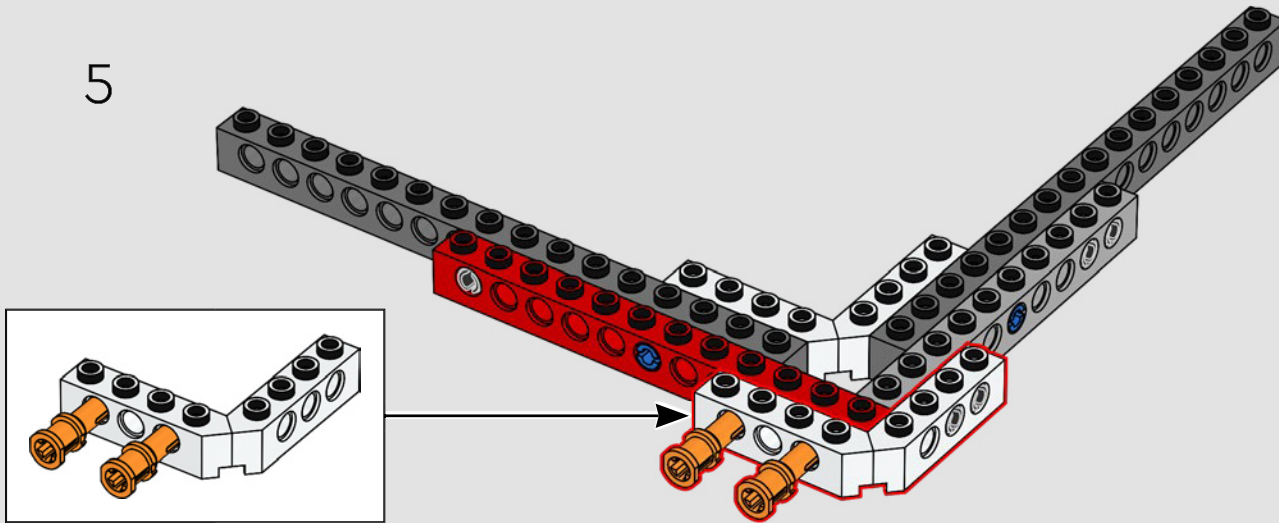

6

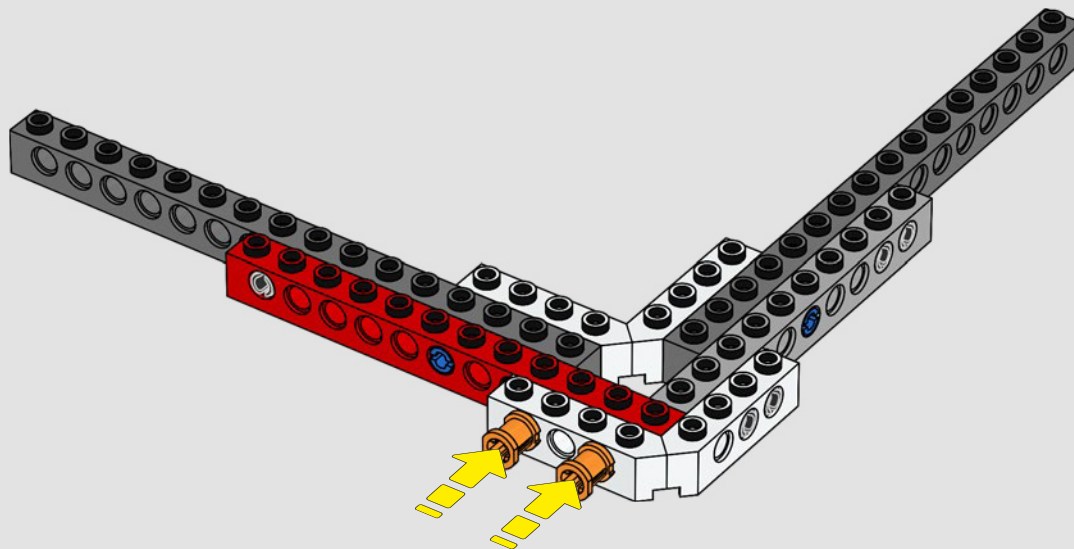



7

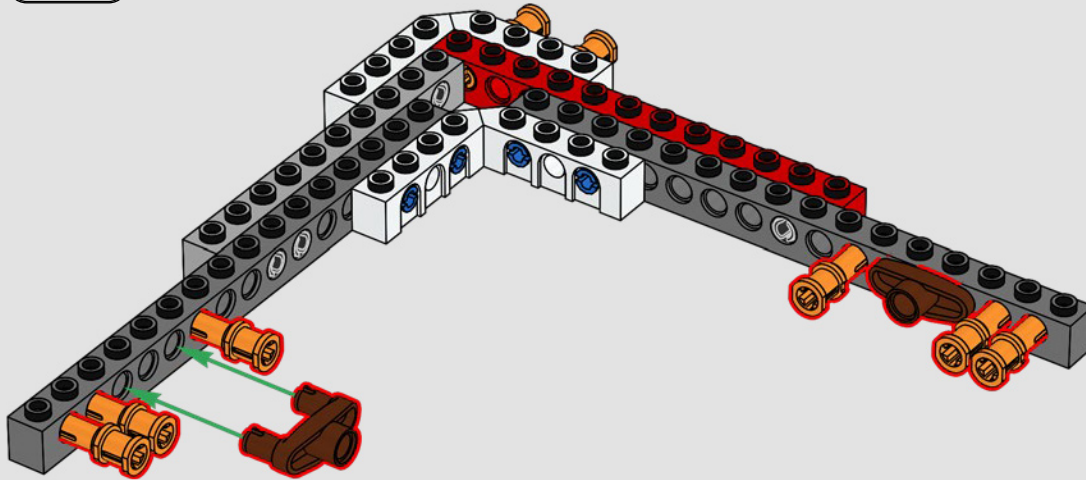

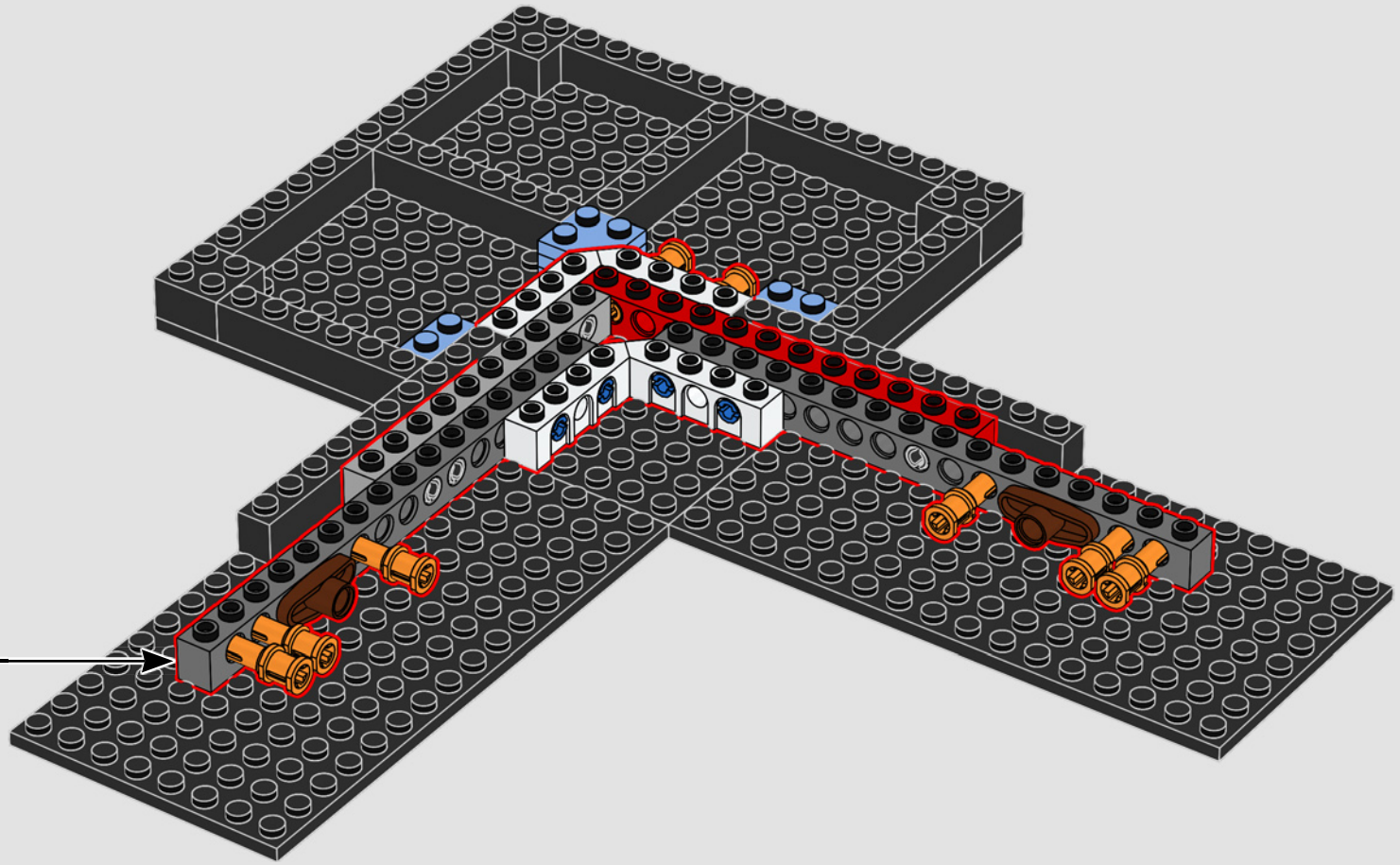



2x

8

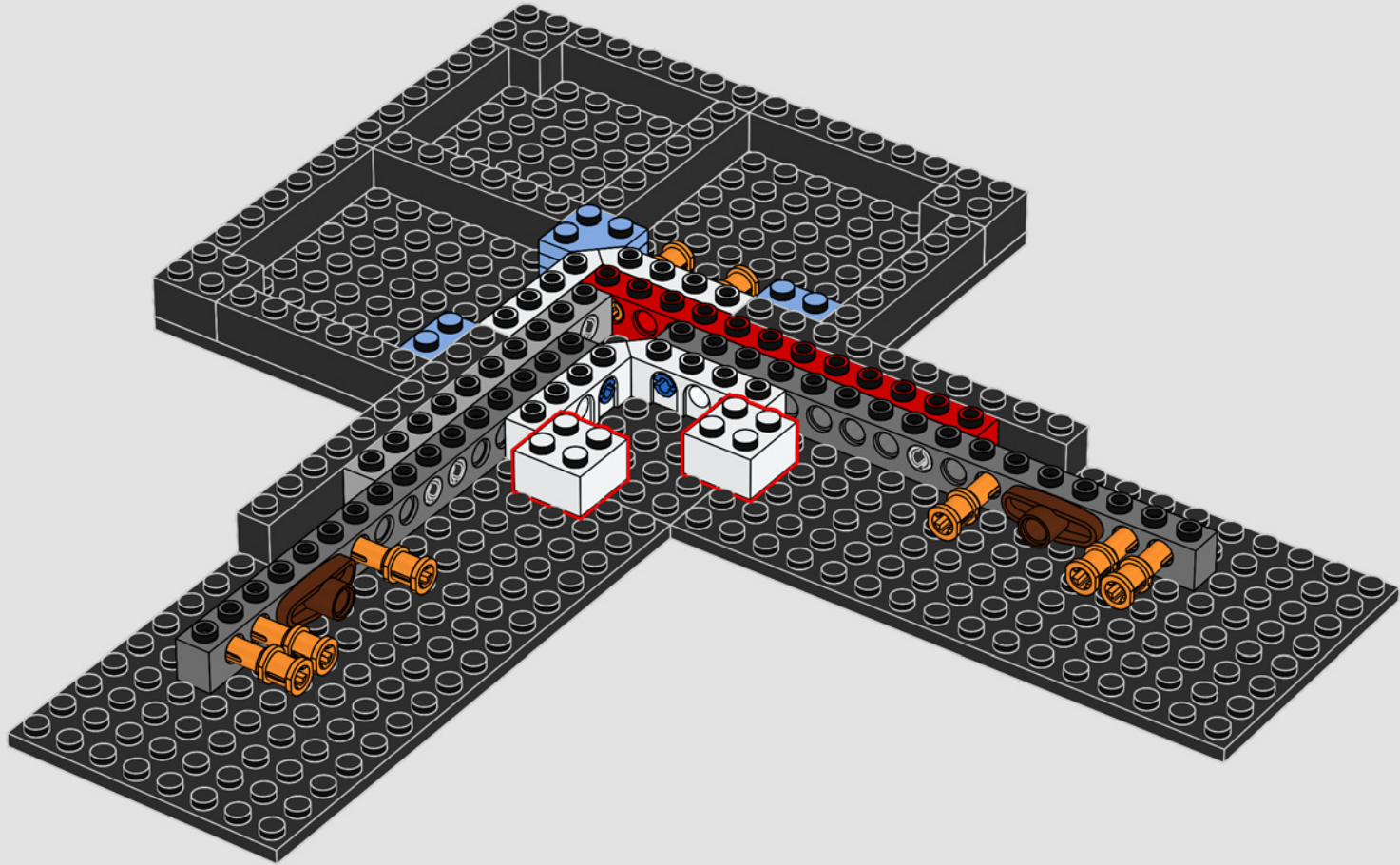

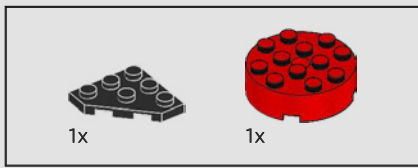

9

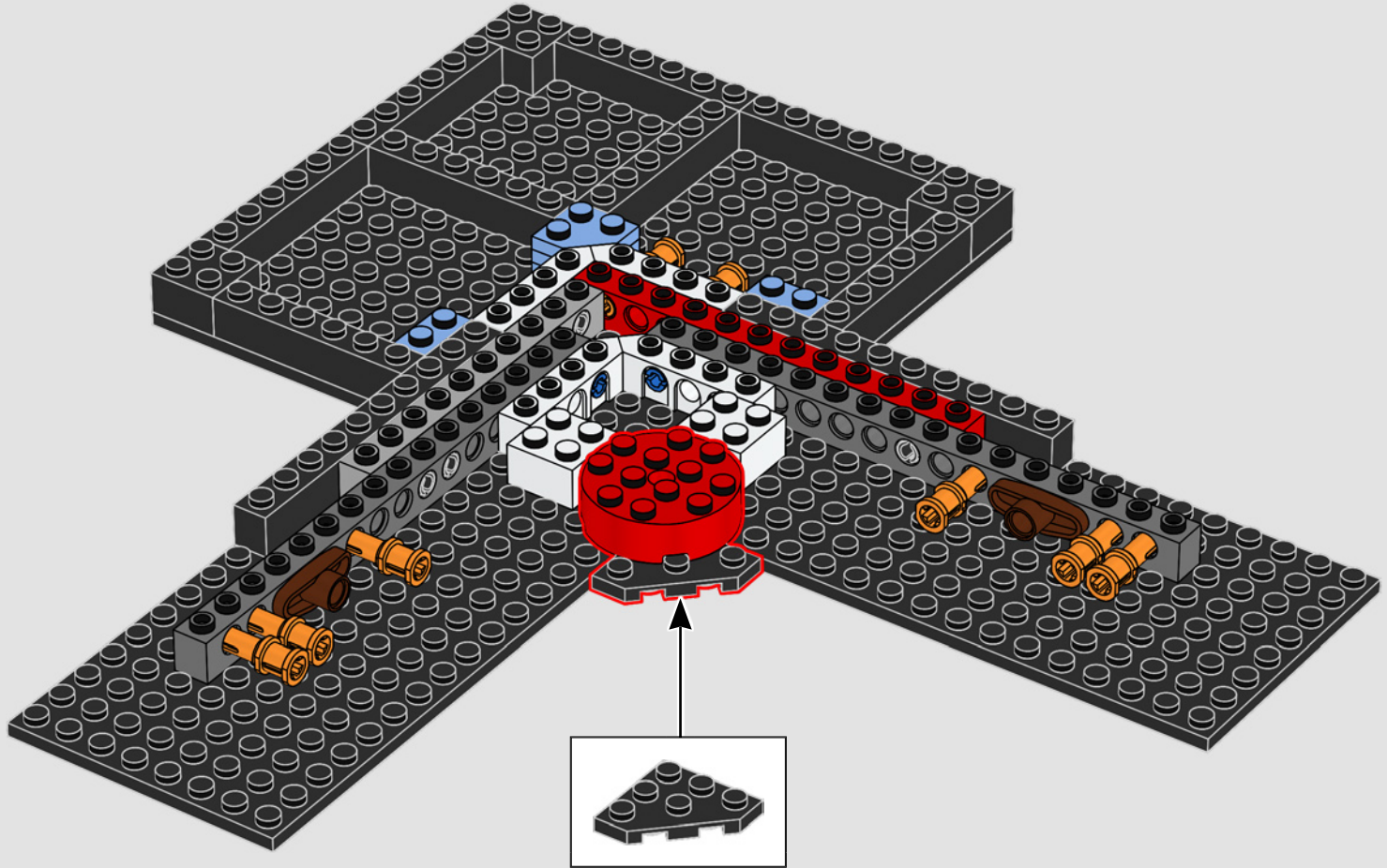

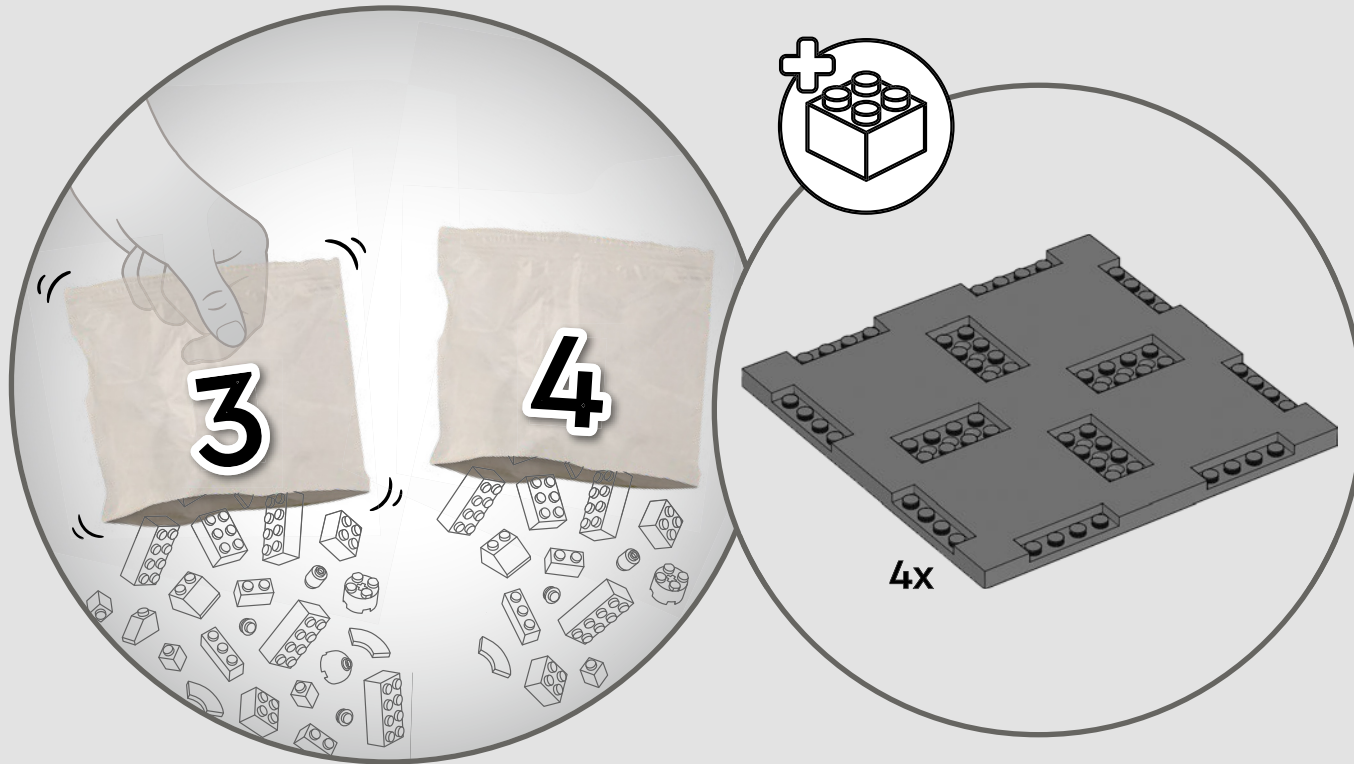

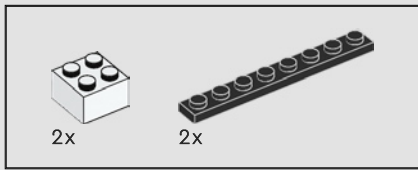

10

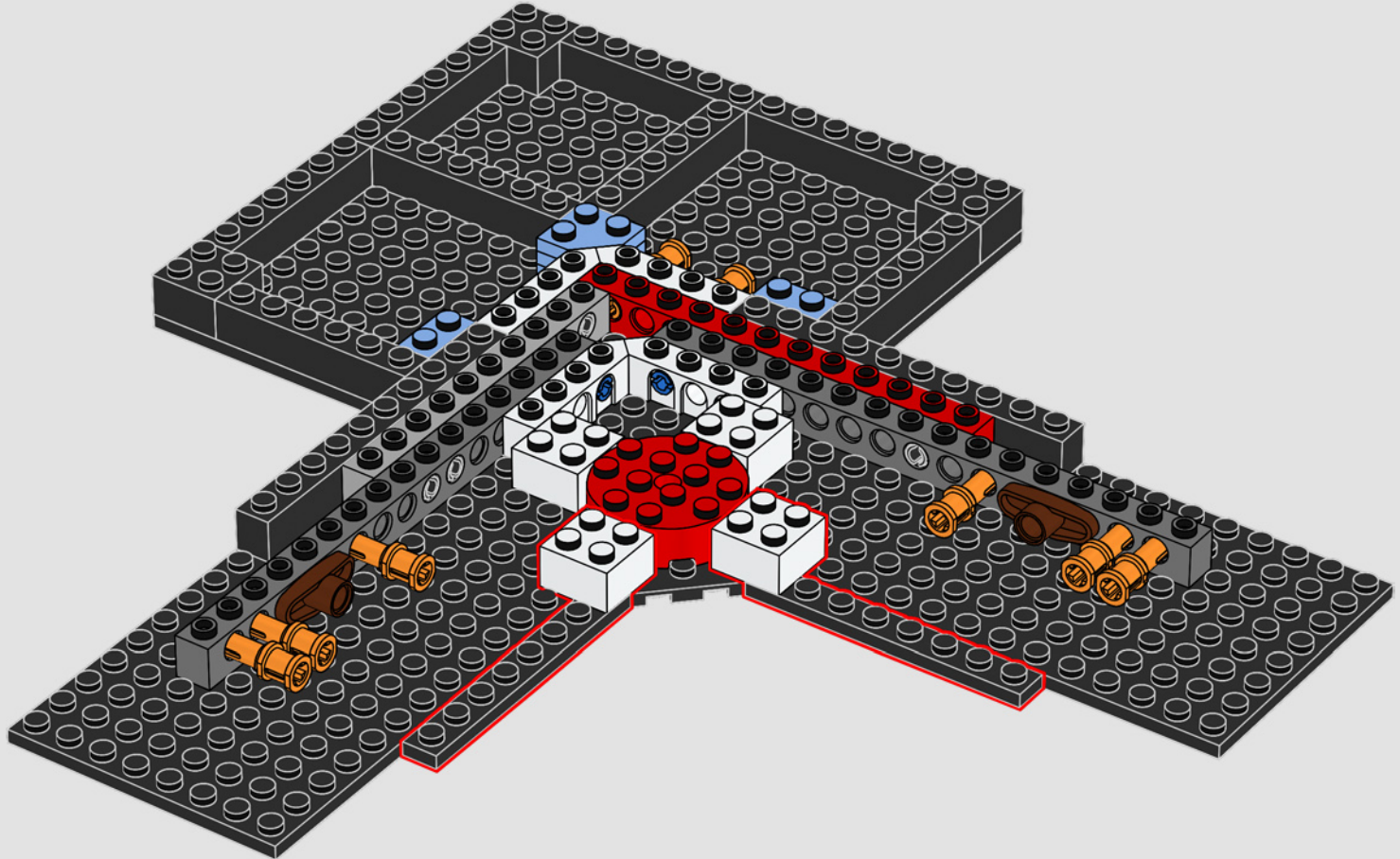

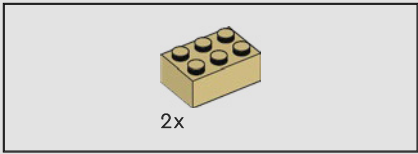

11

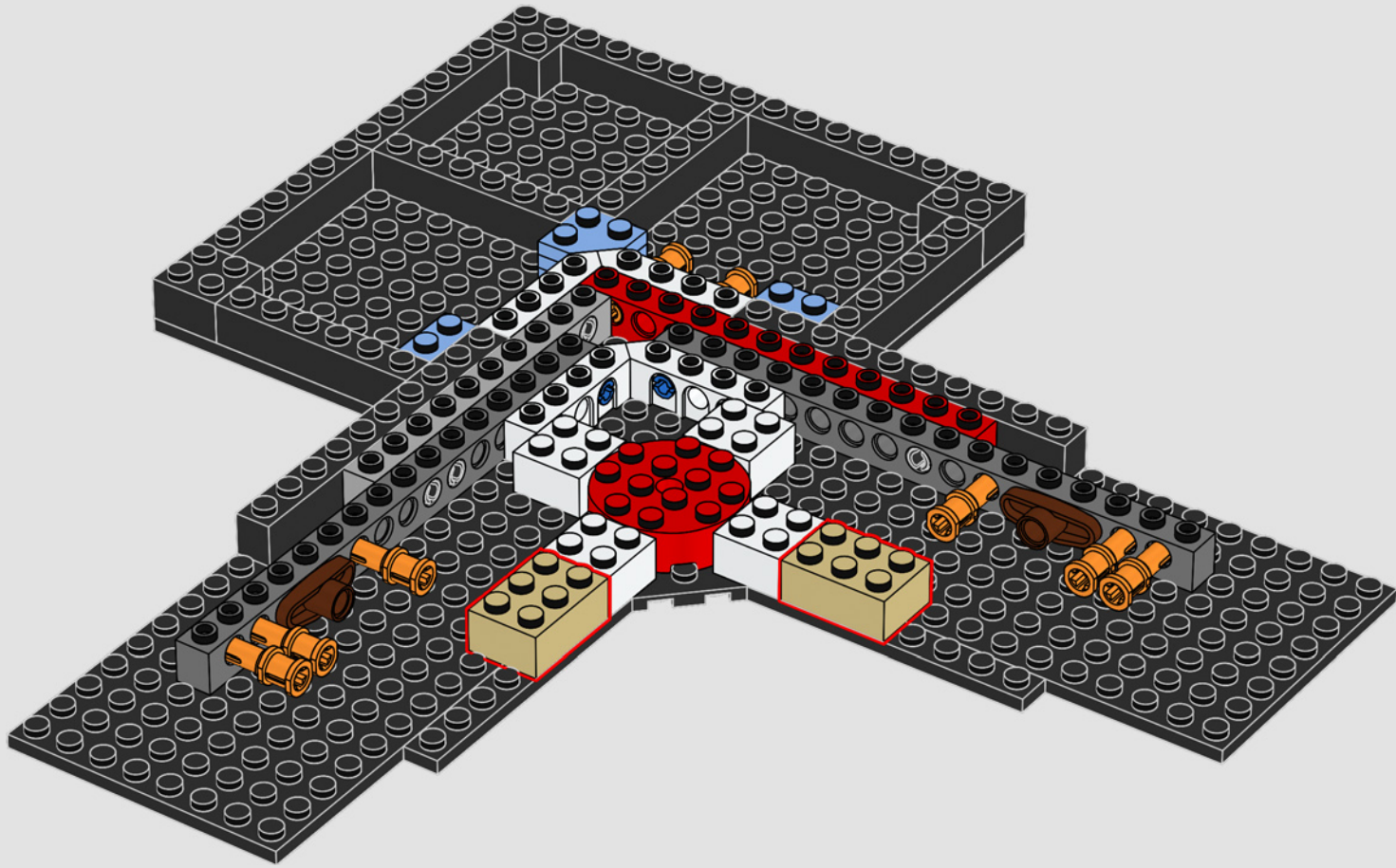



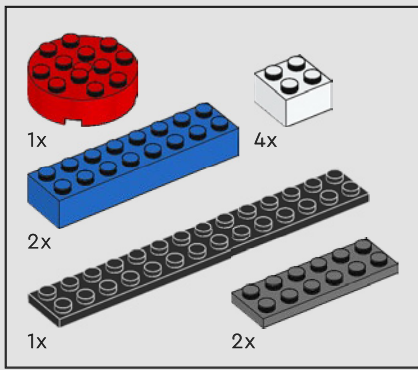

12

1

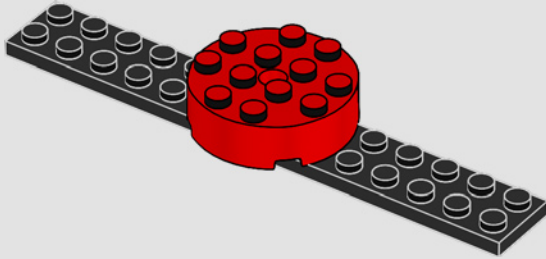

2

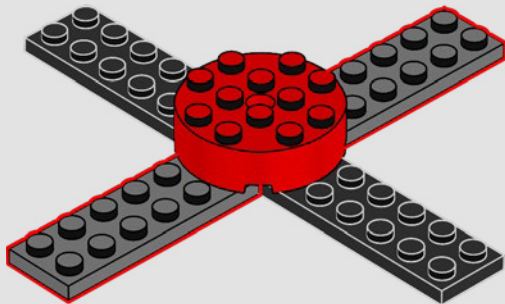

3

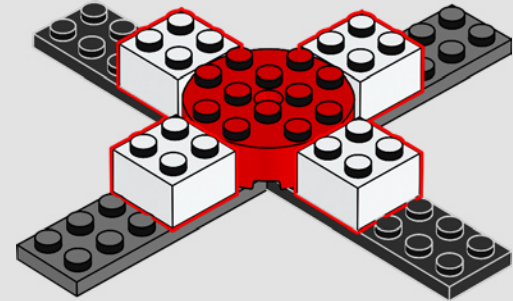

4

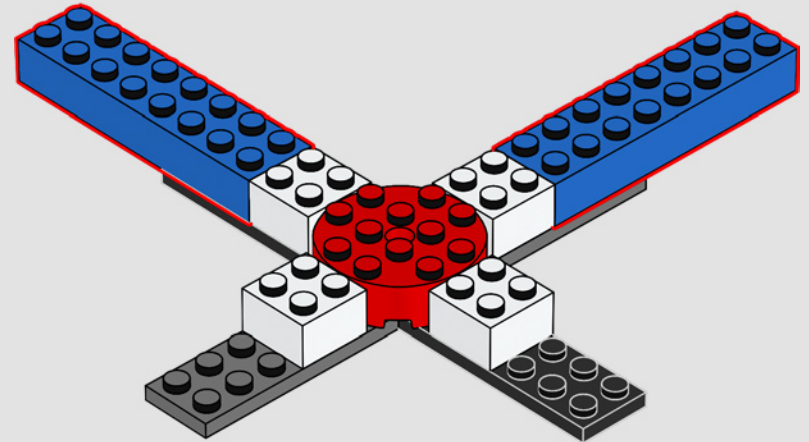

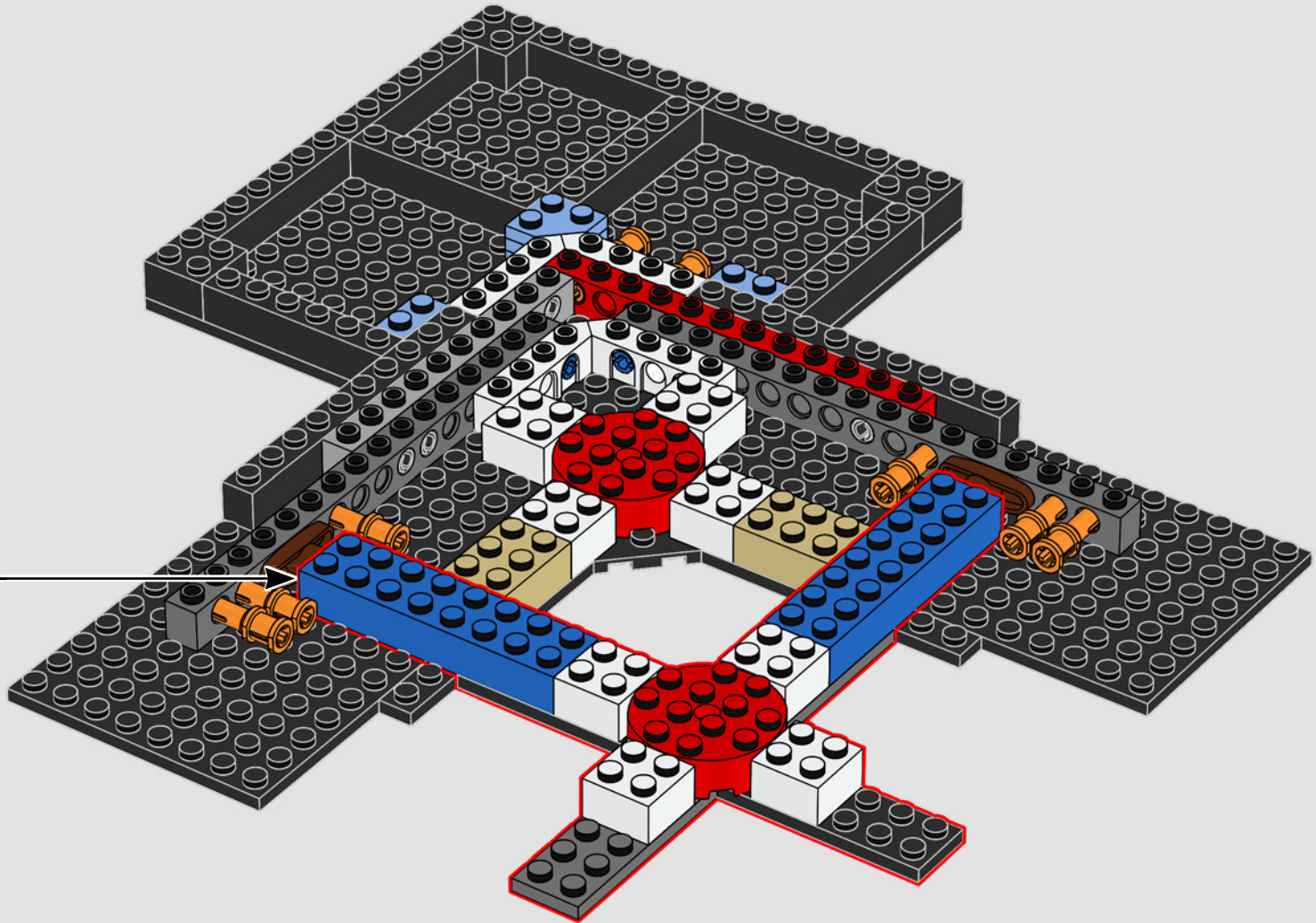

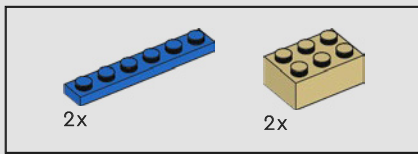

13

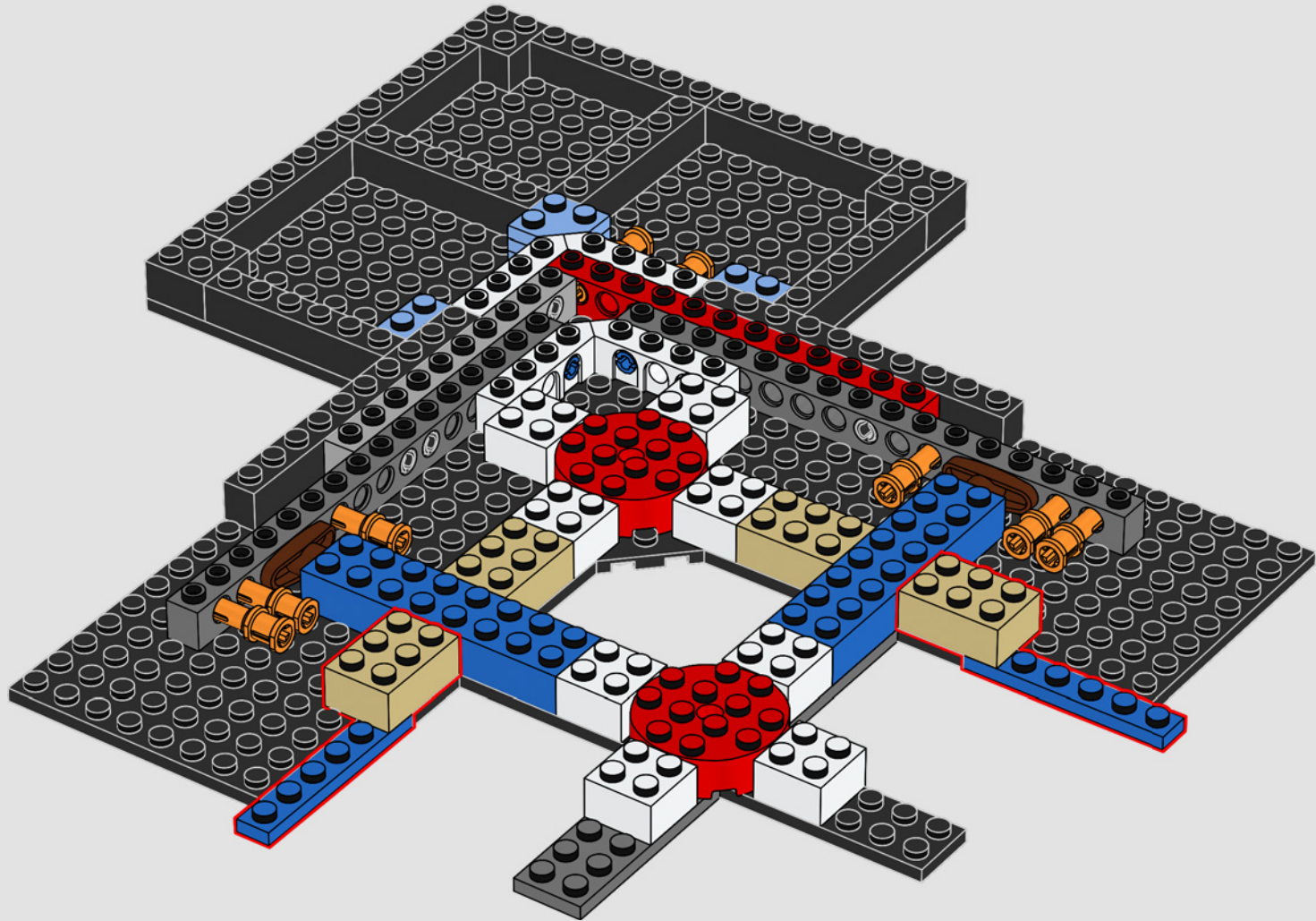

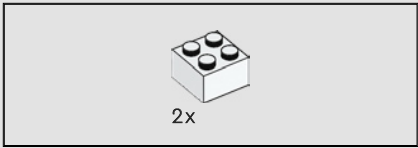

14

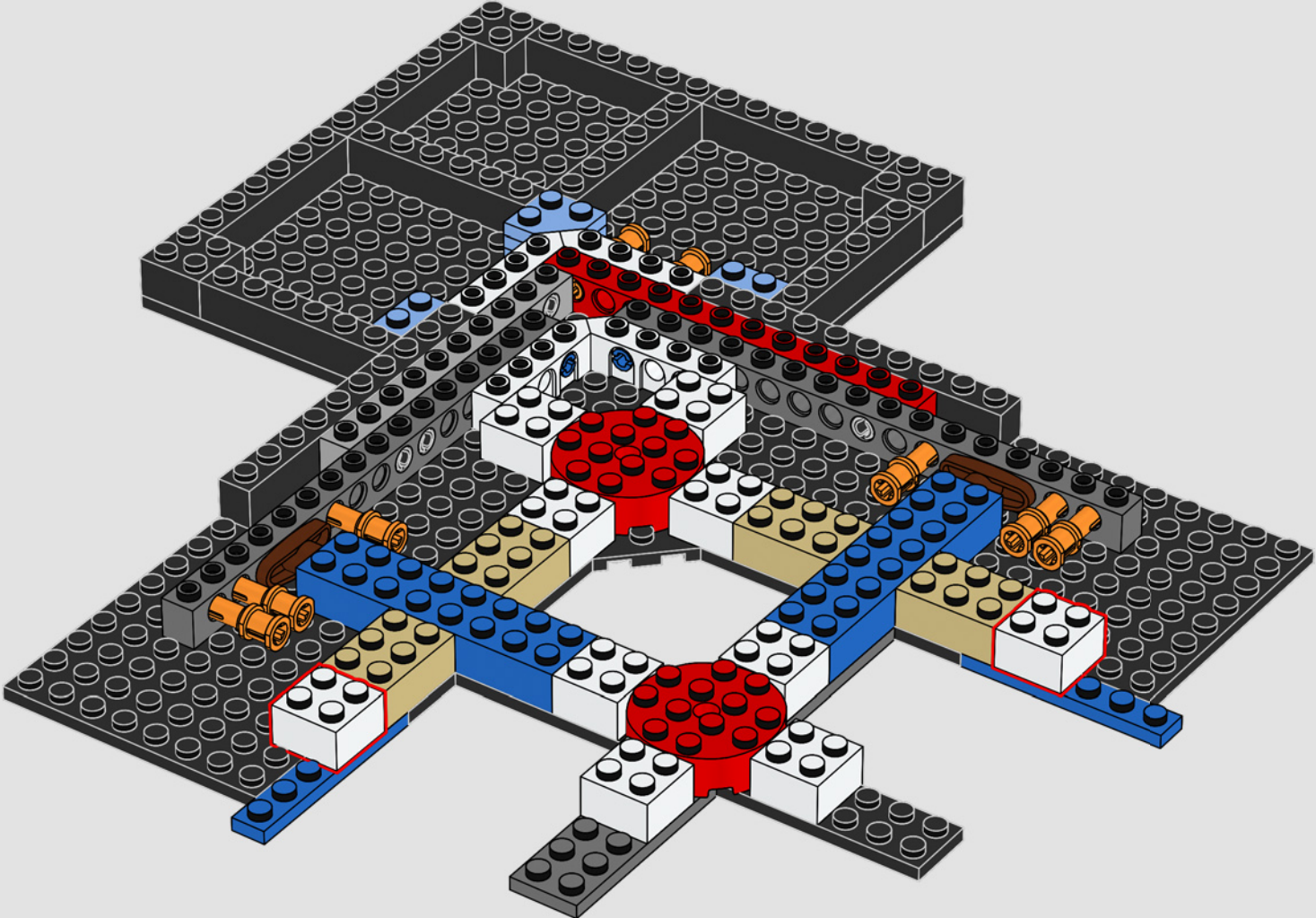

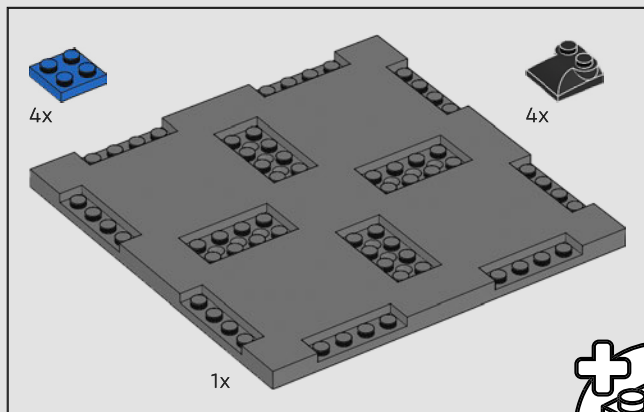

15

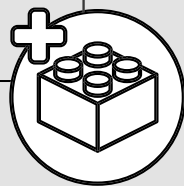

1

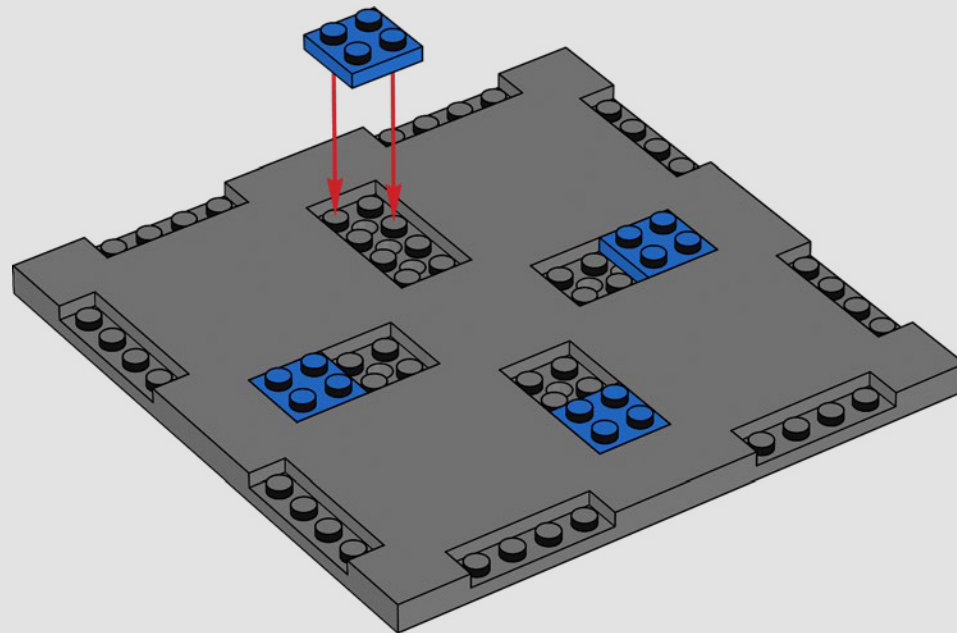

2

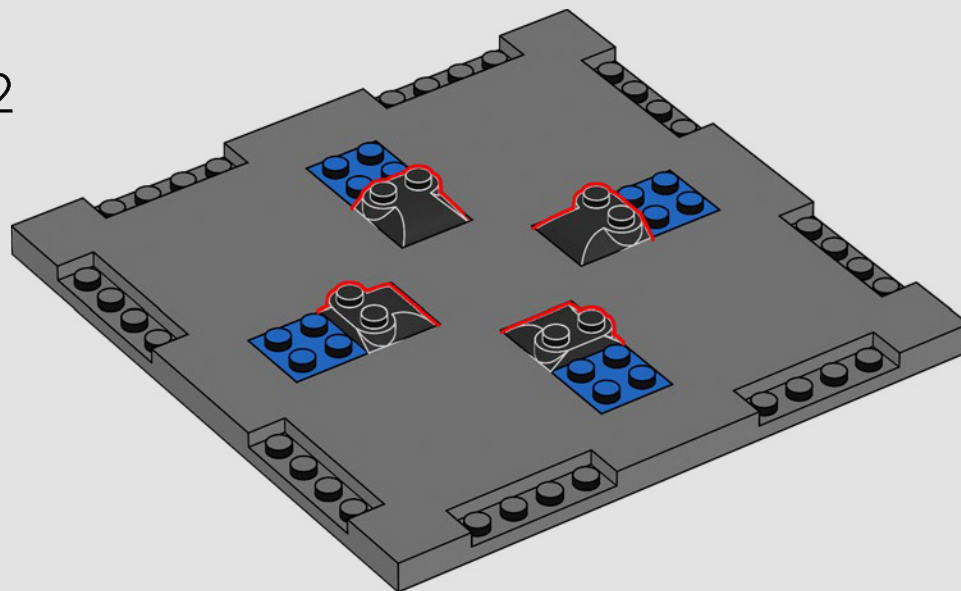

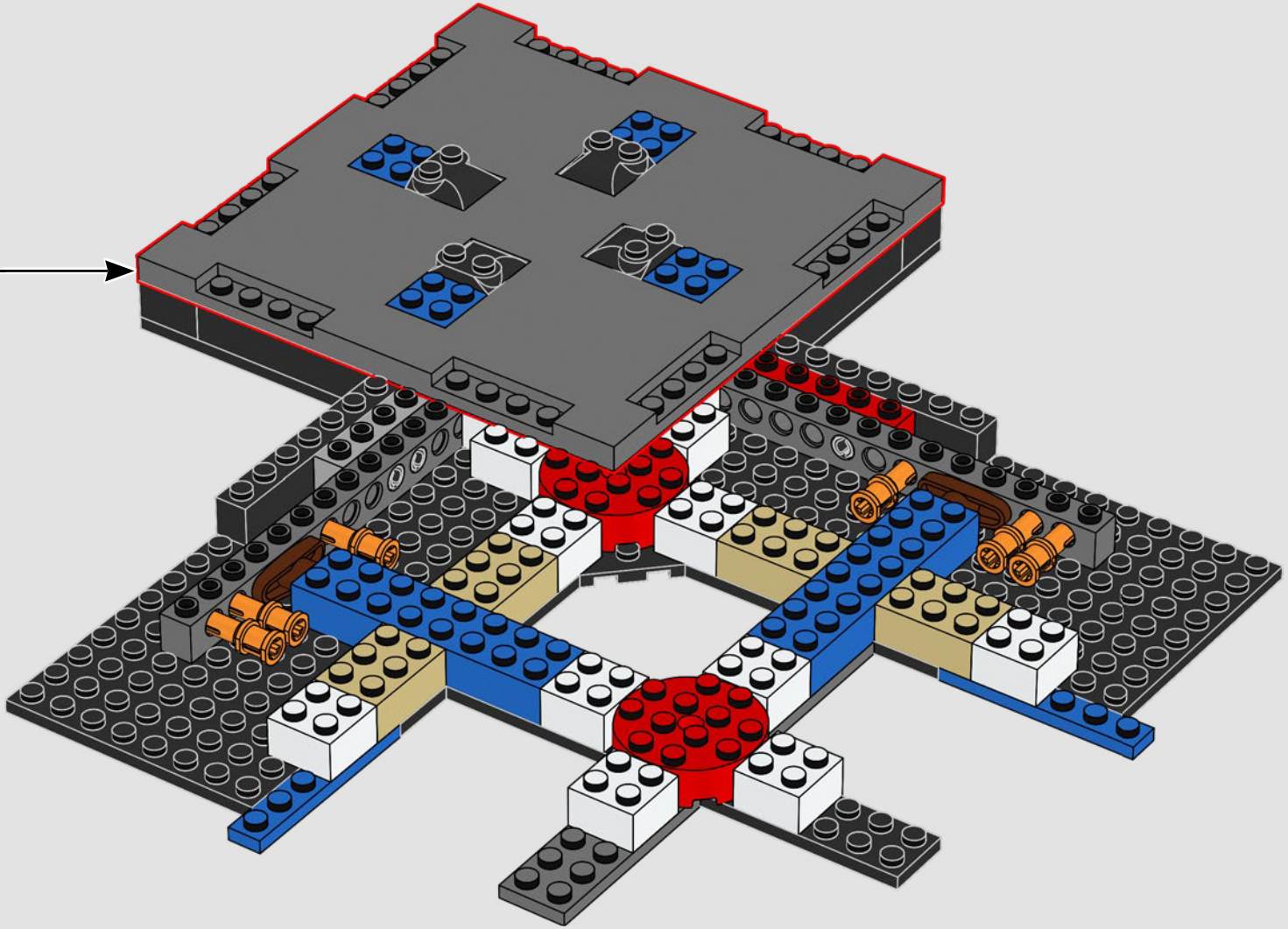

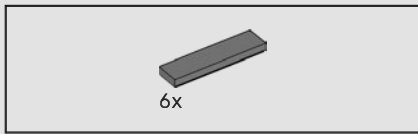

16

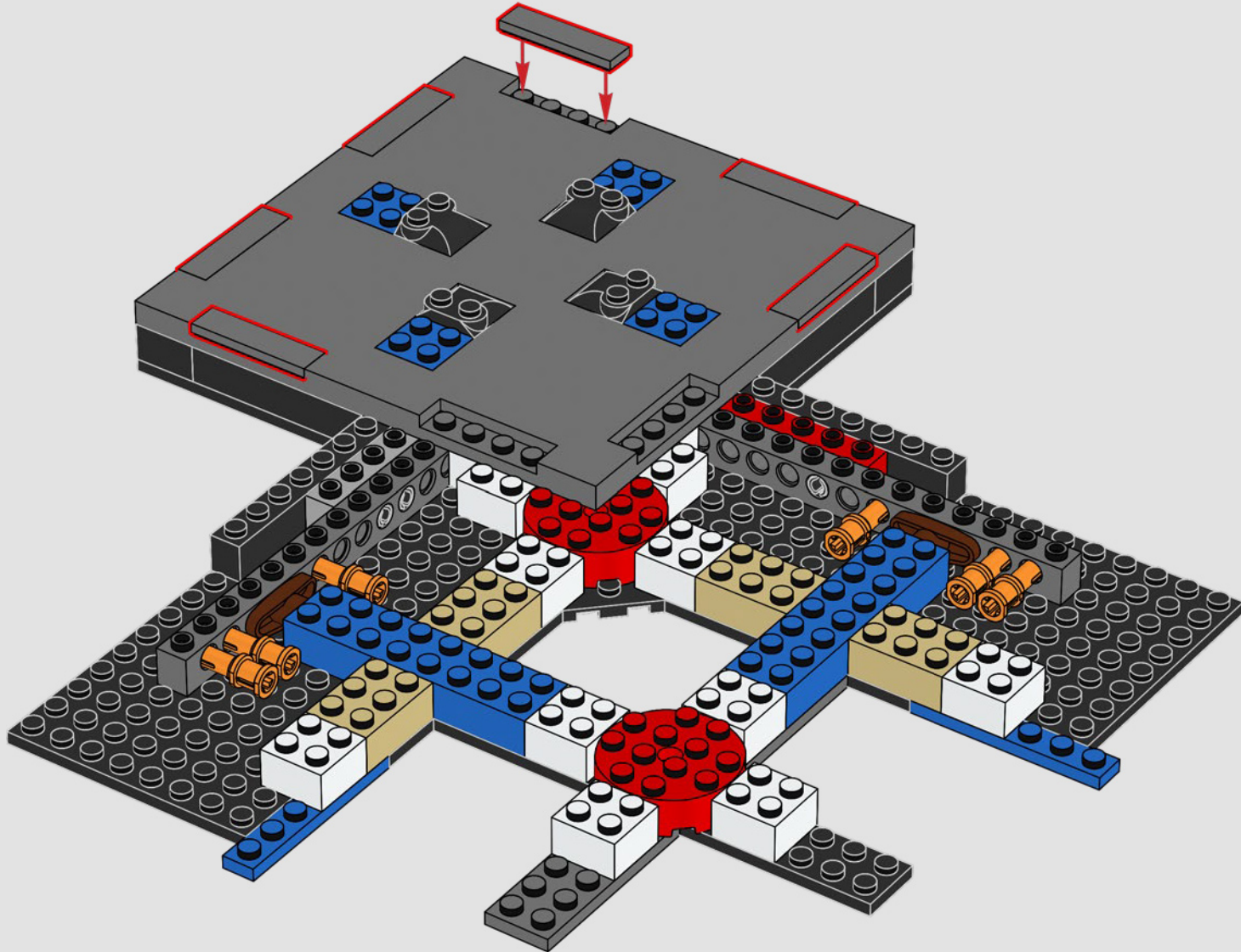

4x

17

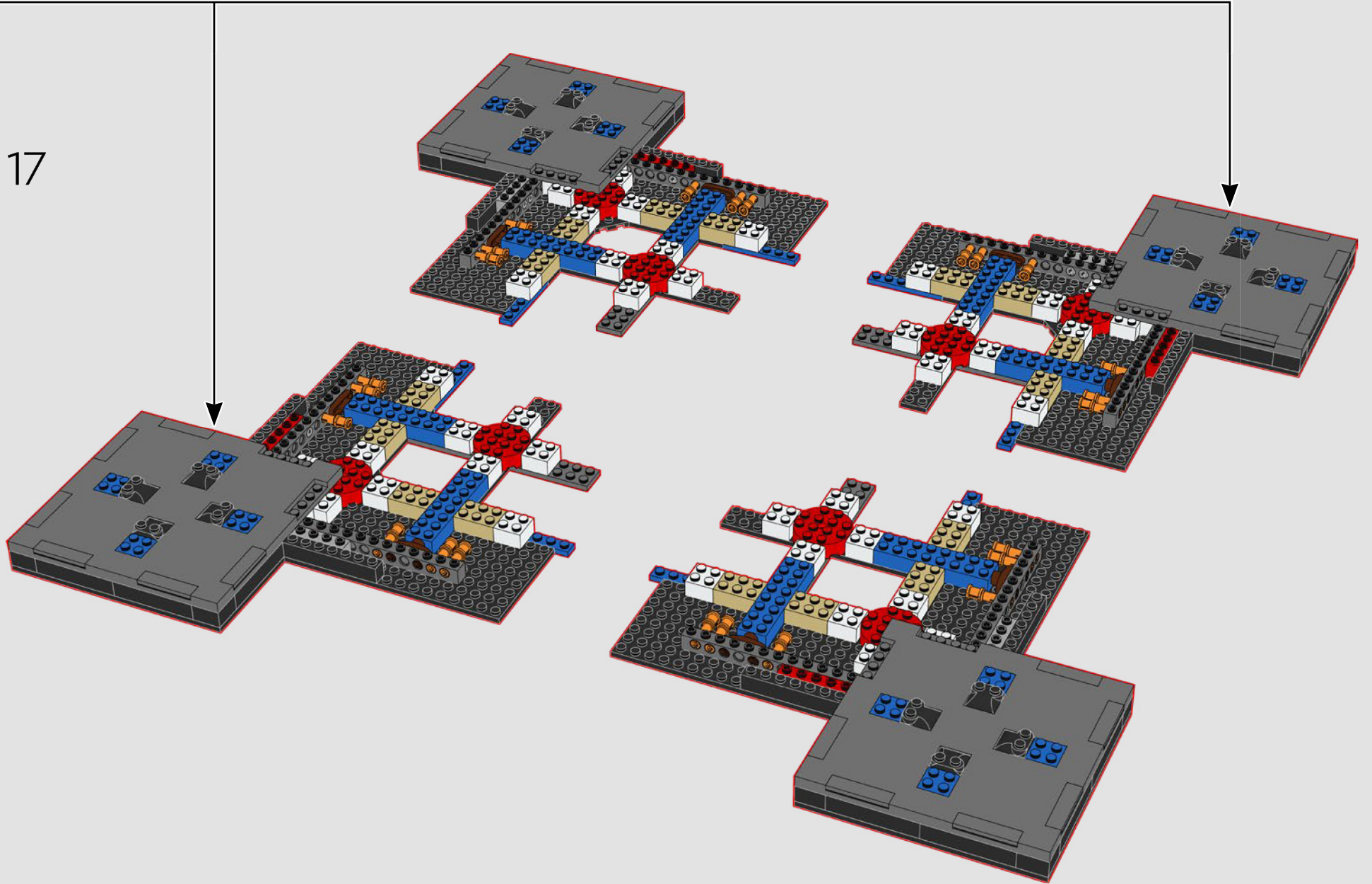





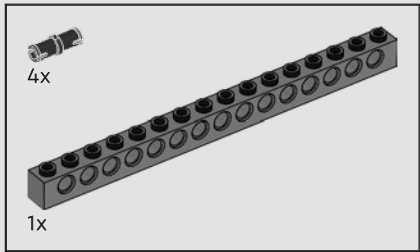
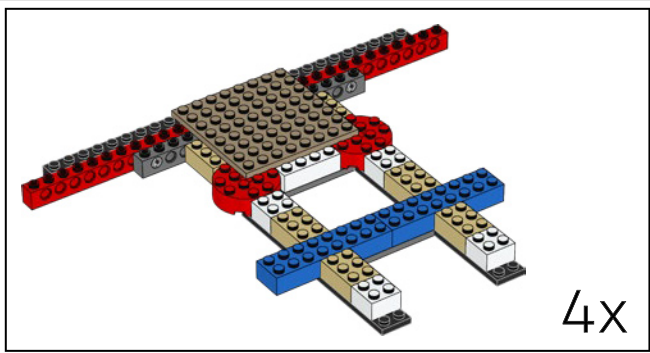

18

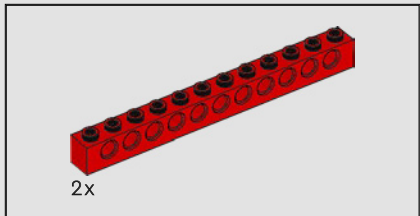
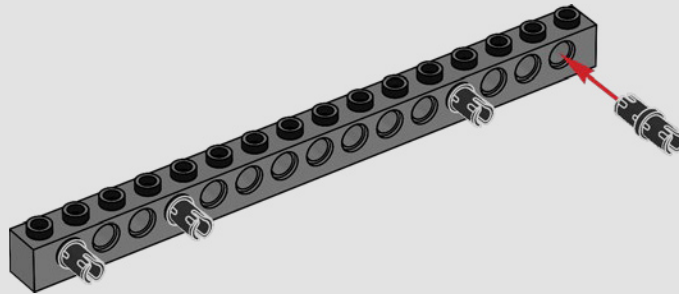

19

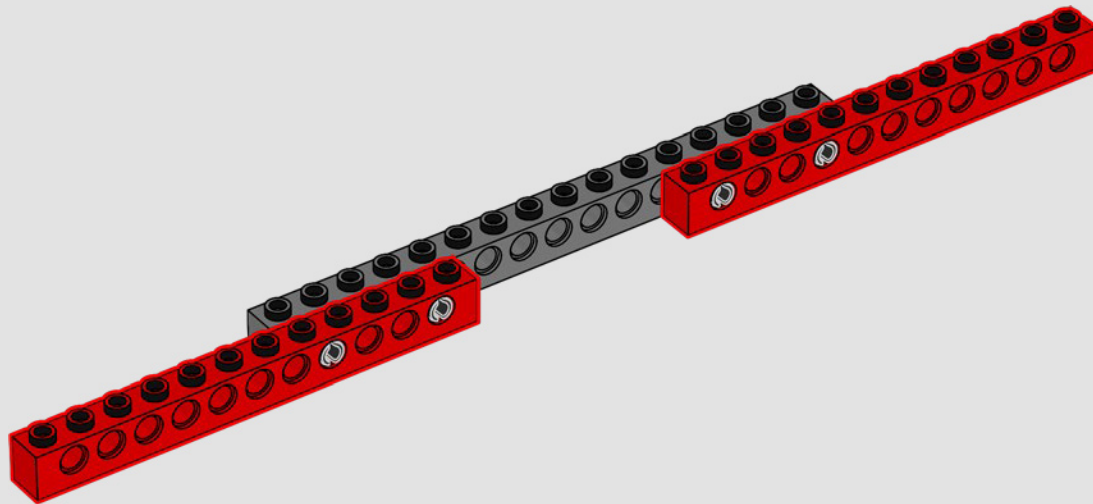

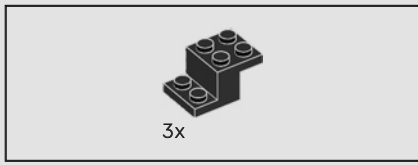

20

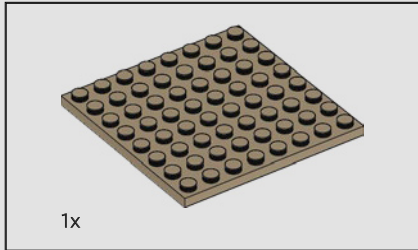
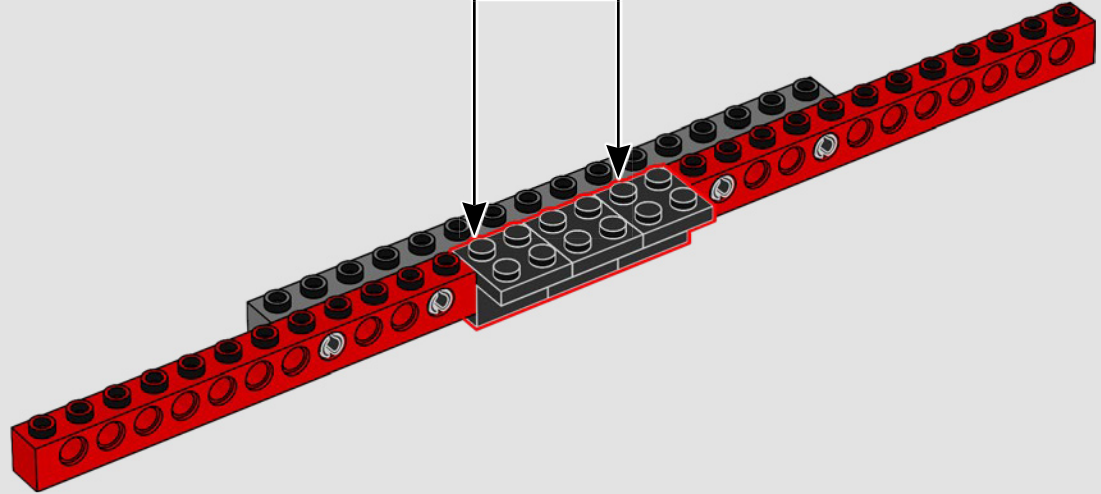
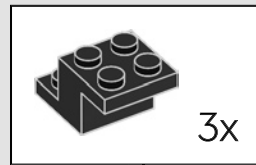

21

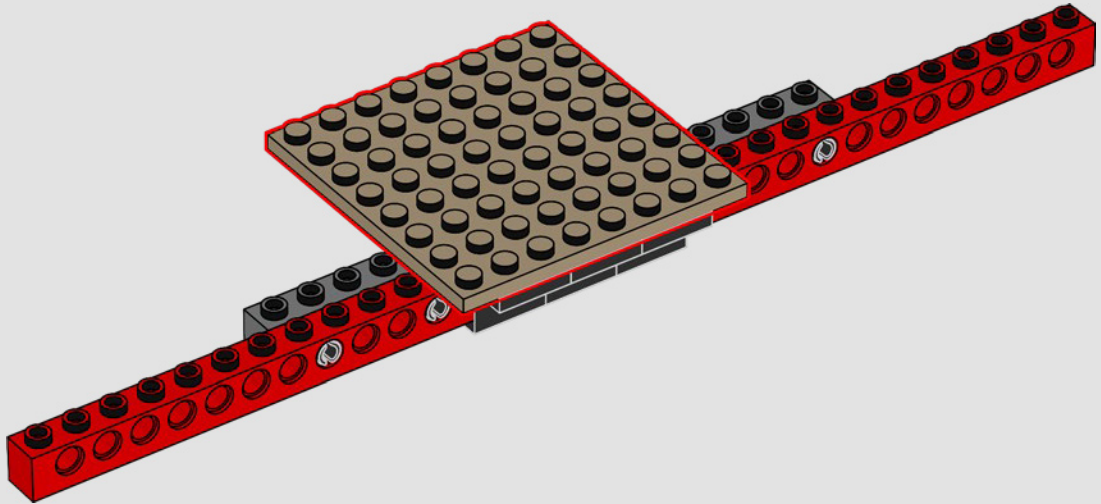



22

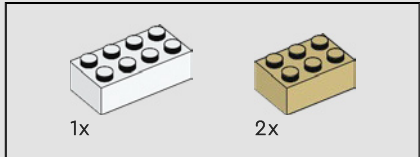
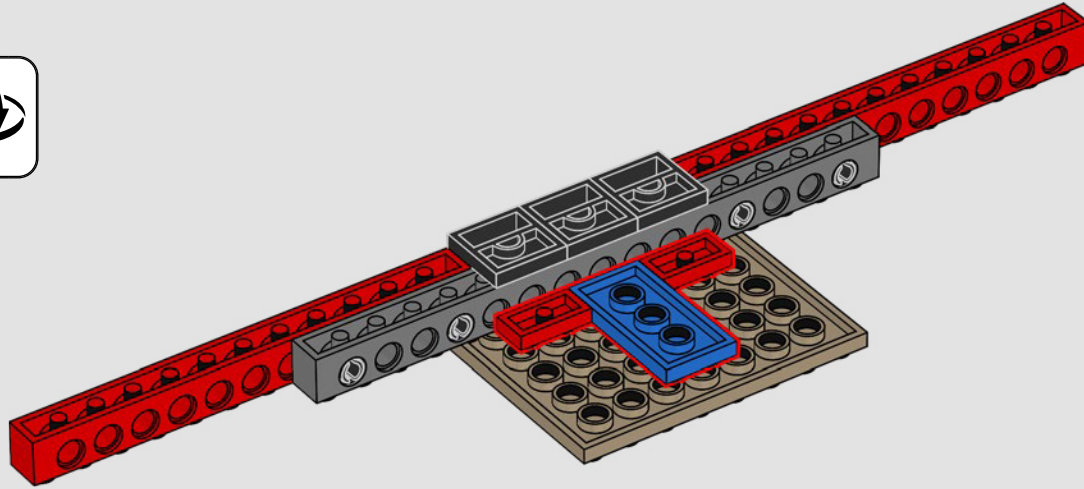

23

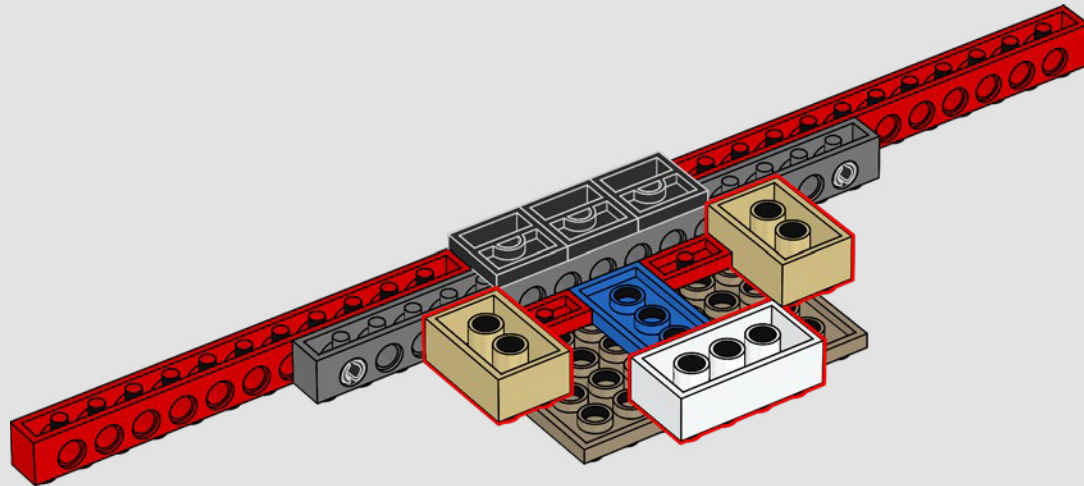



24

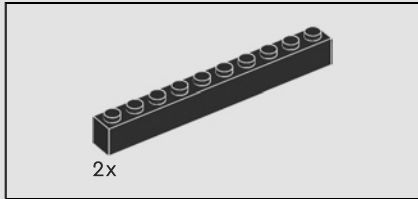
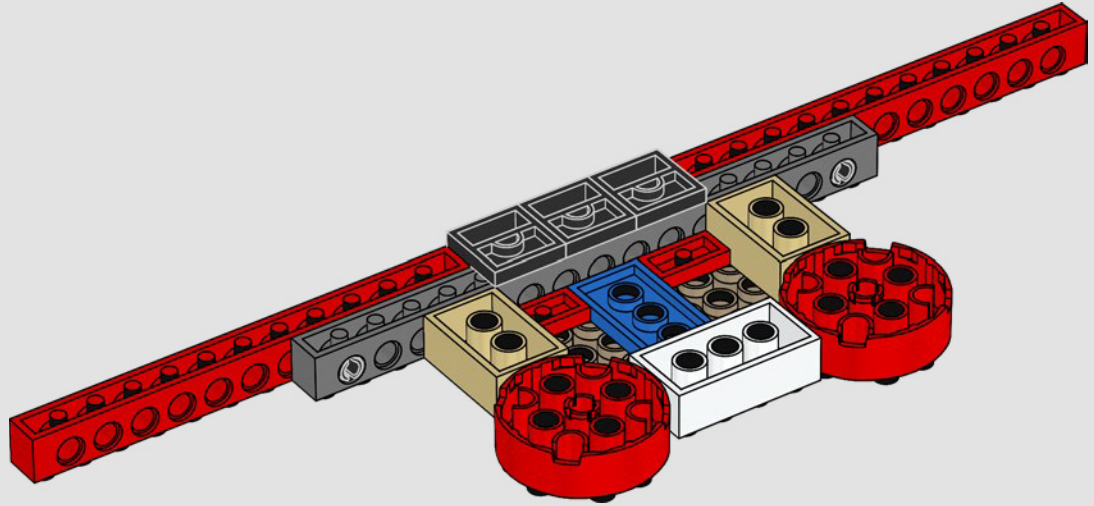

25

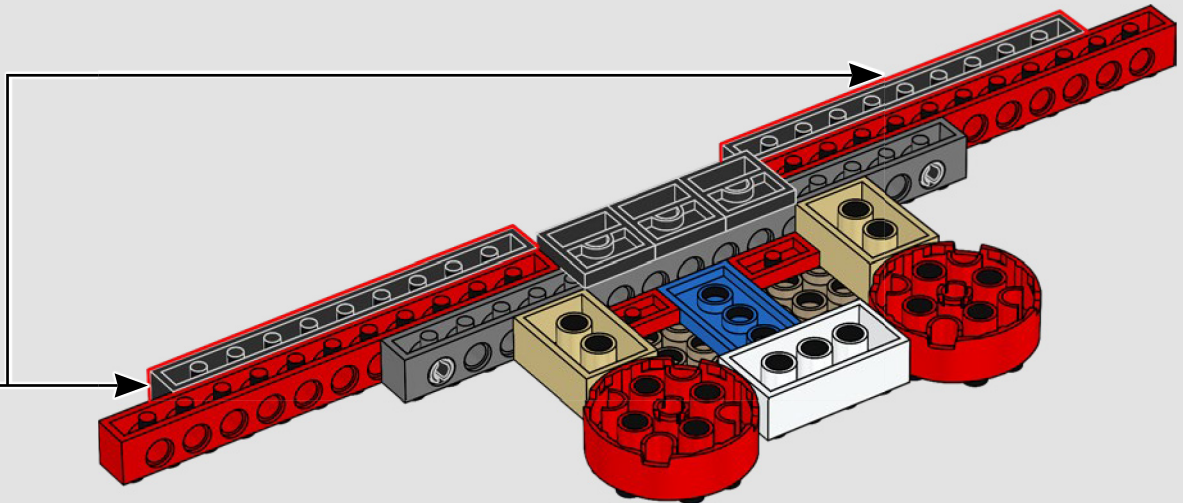
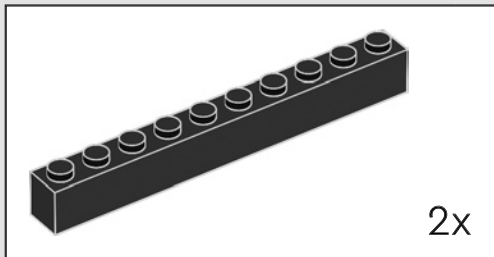

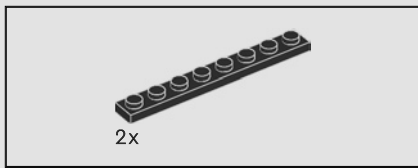

26

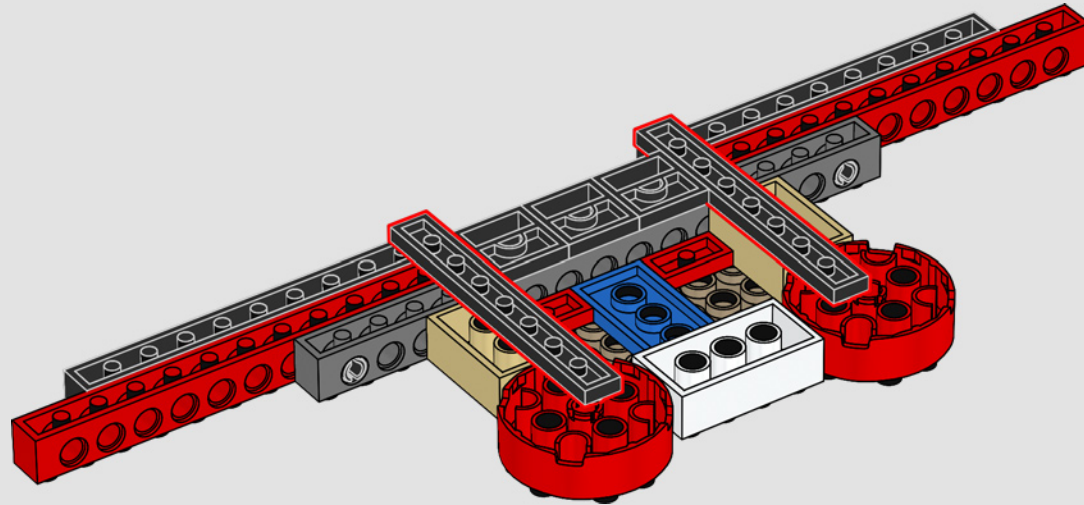

27

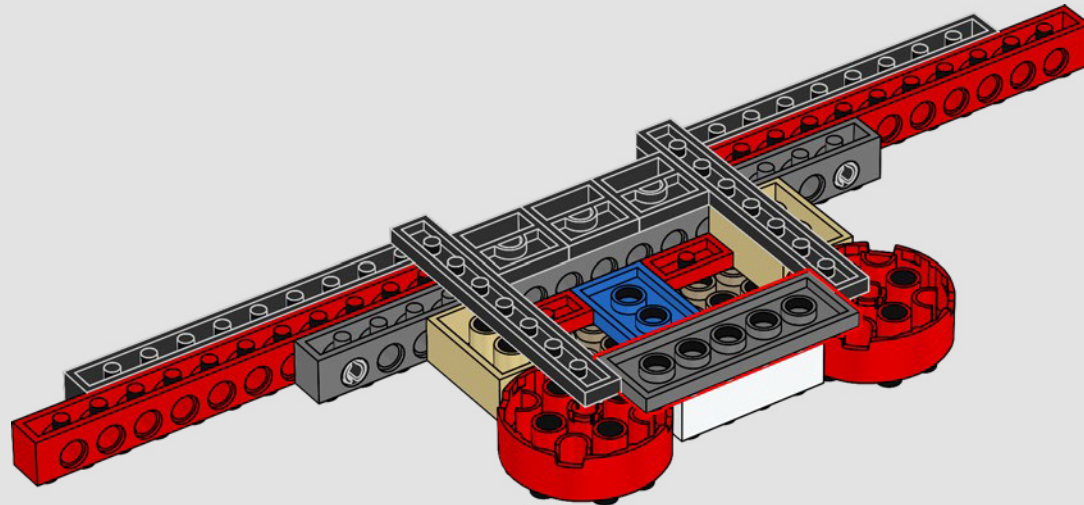

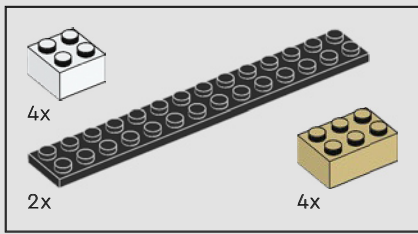

28

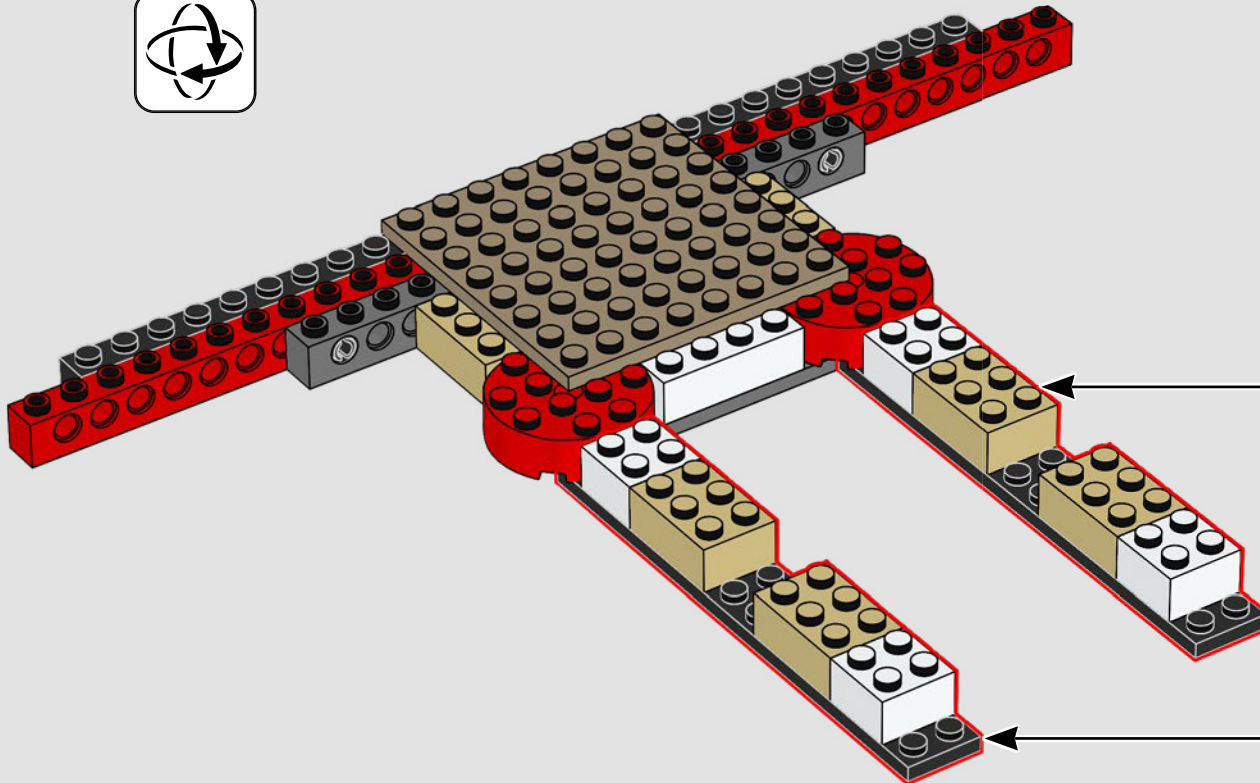
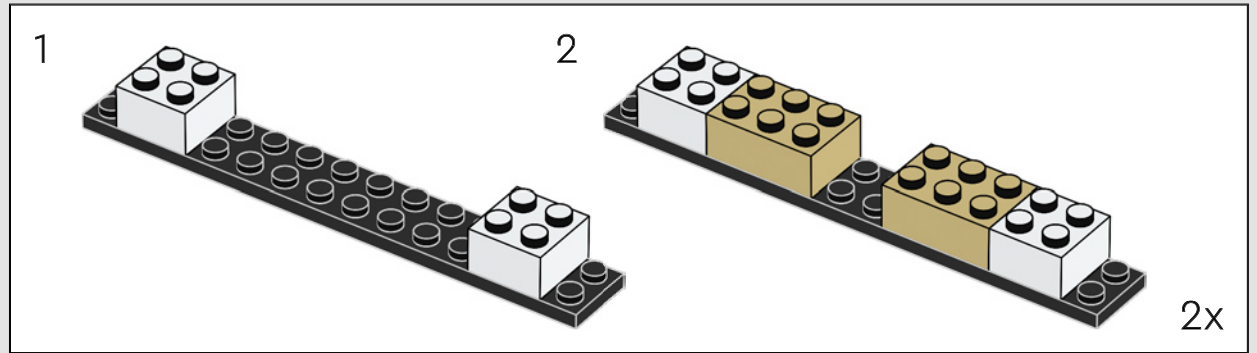

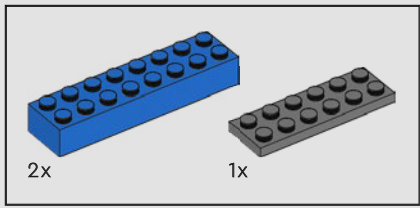

29

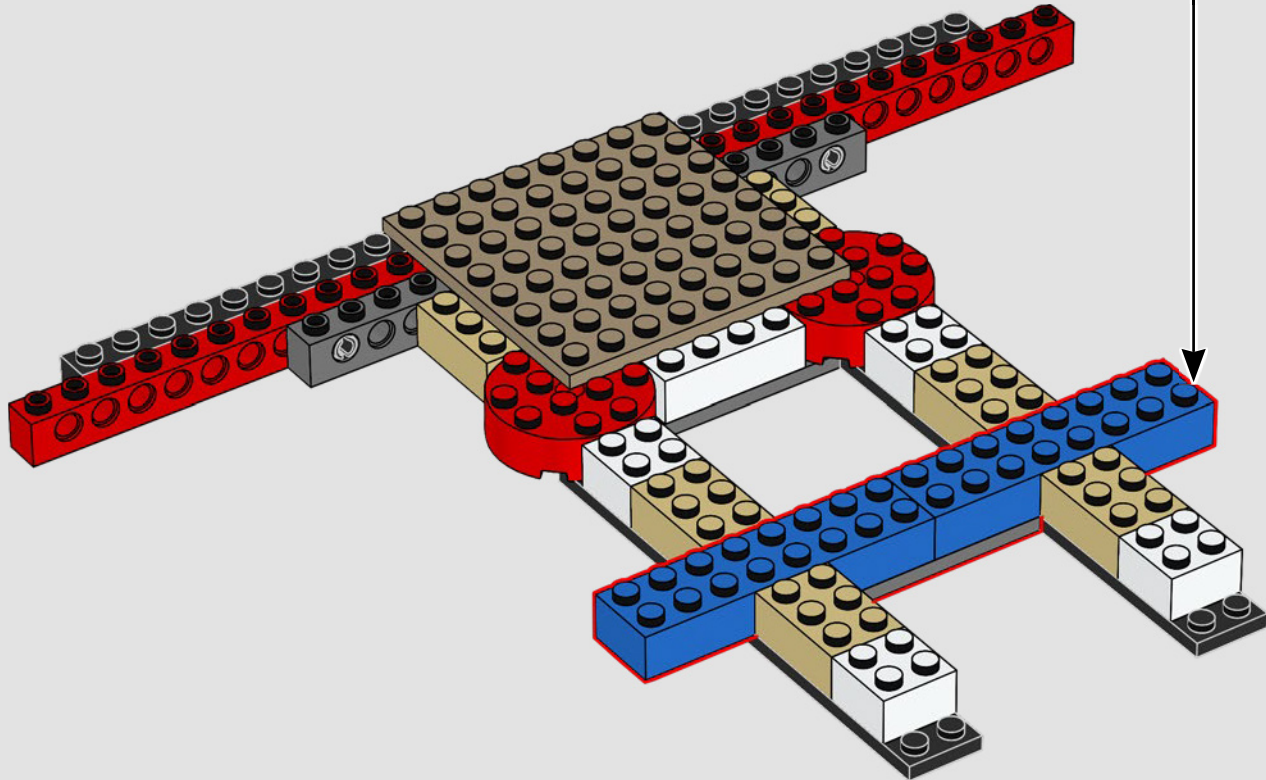
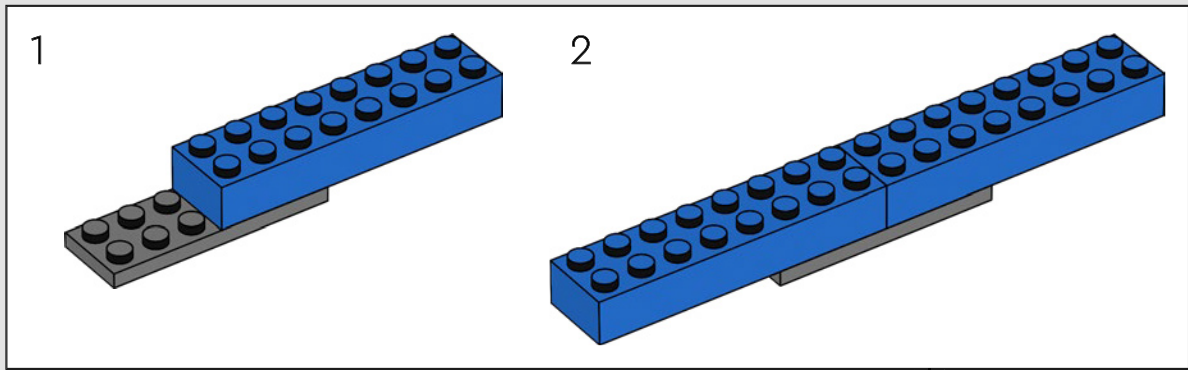



30

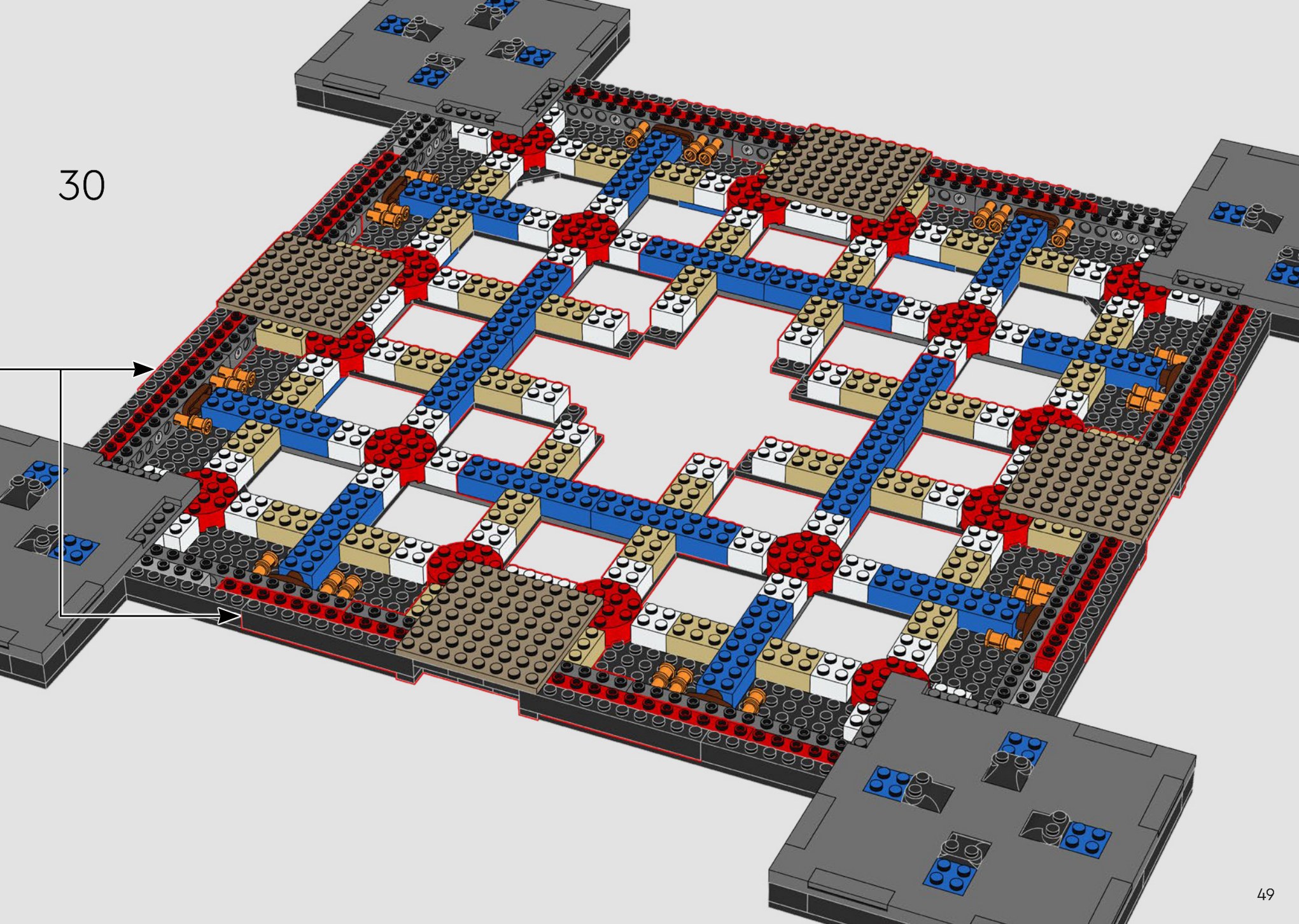

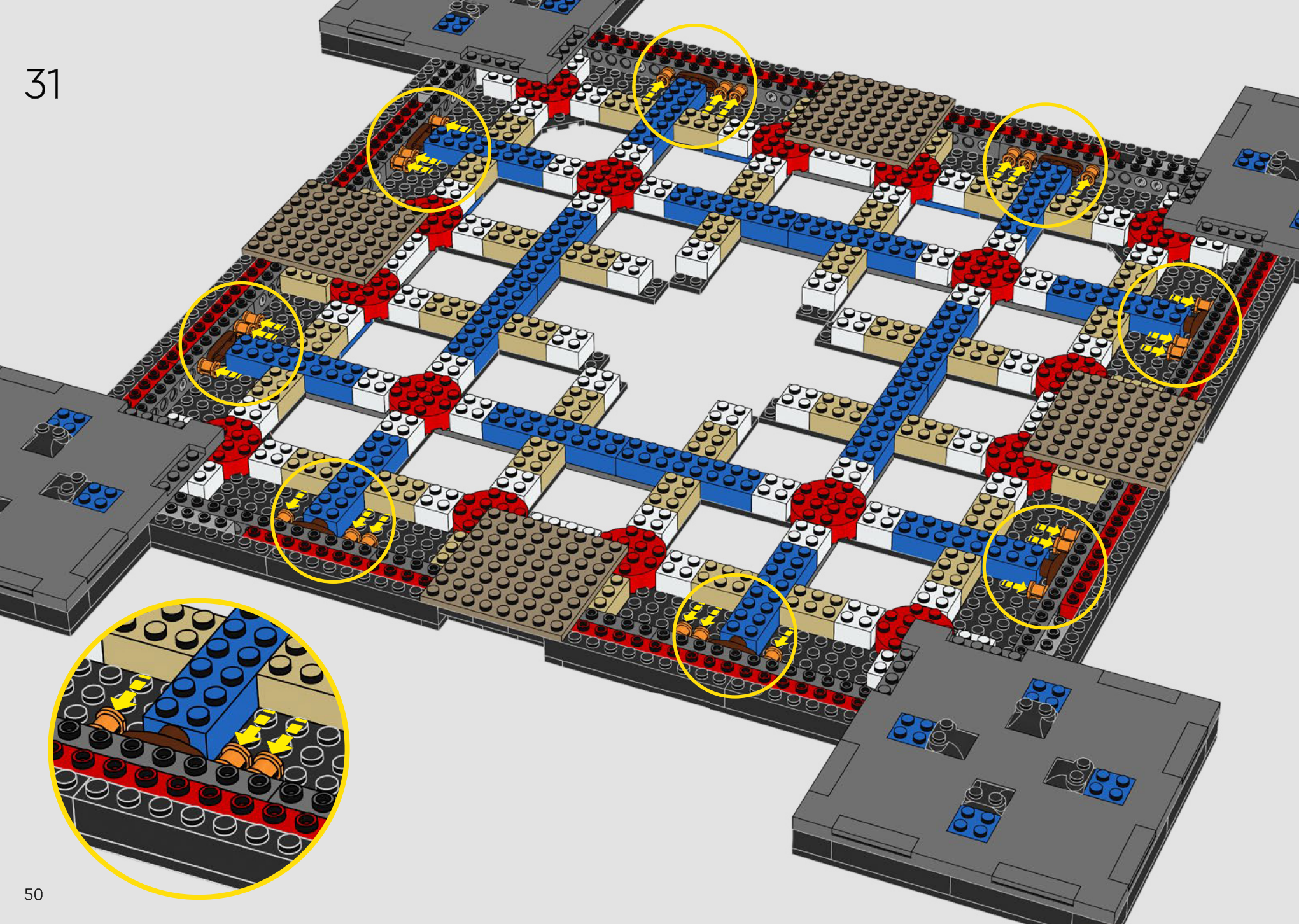

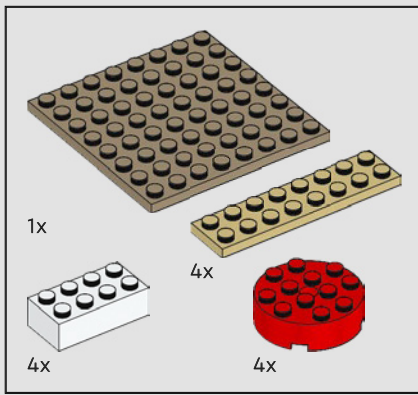

32

1

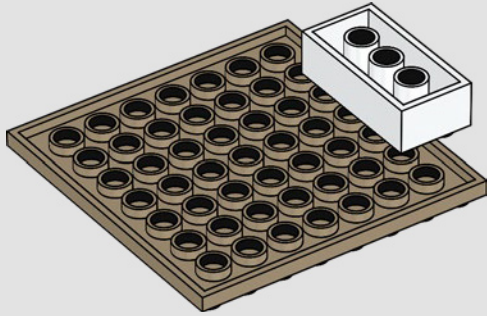

2

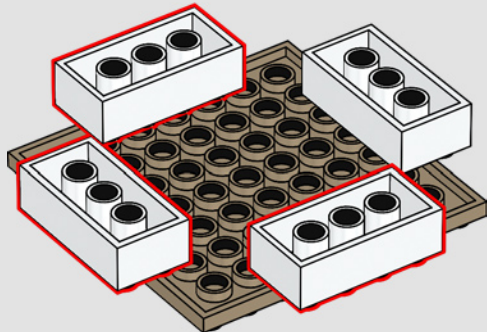

3

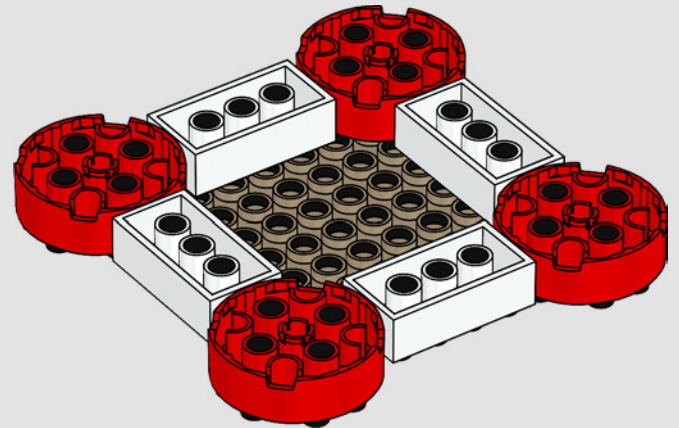

4

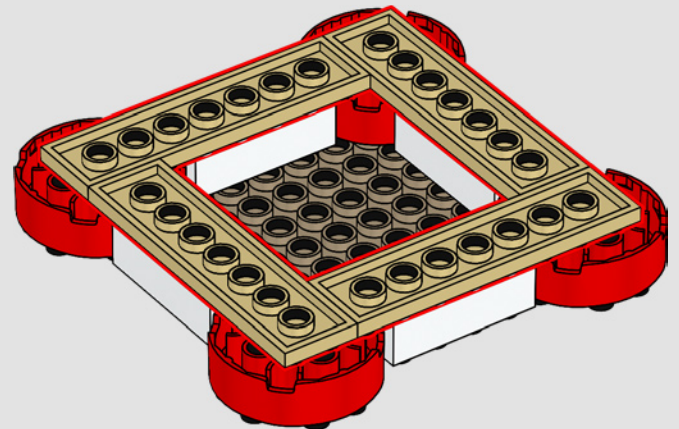

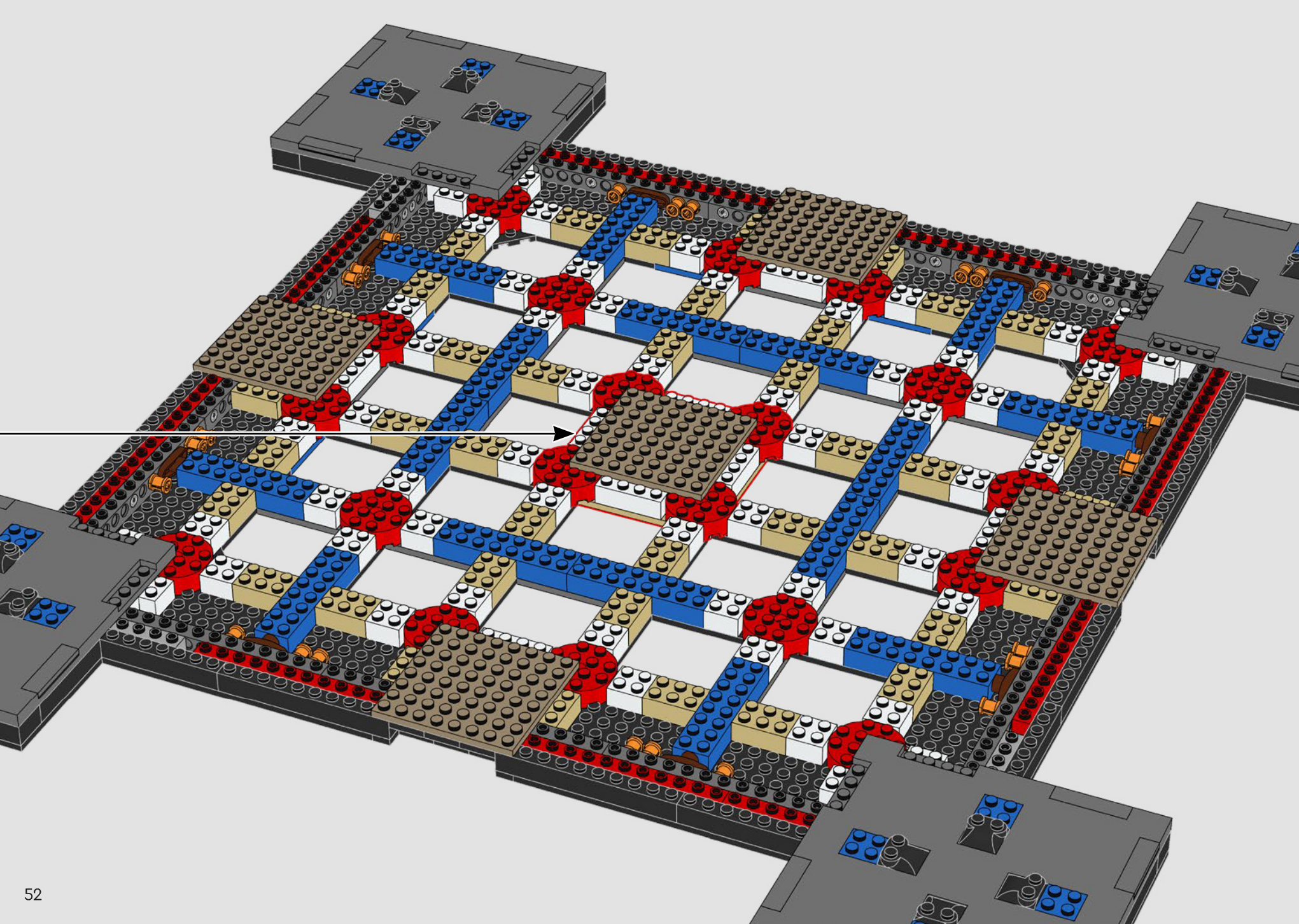

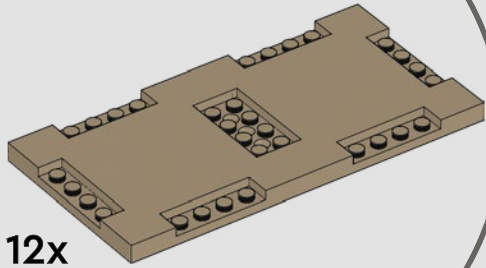
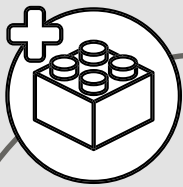

12x

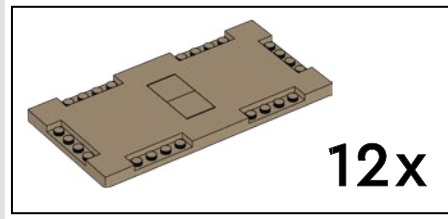

12x

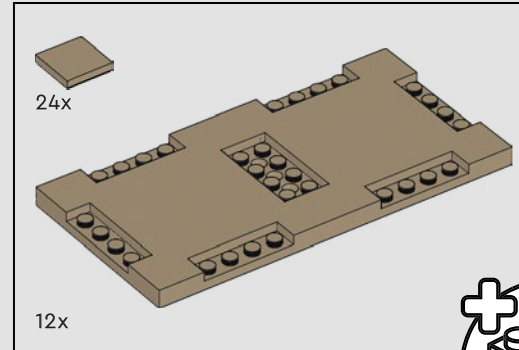

12x

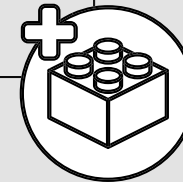

33

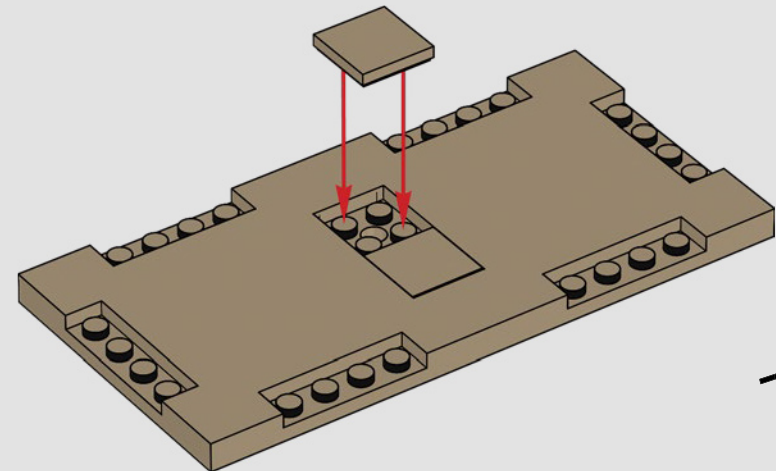
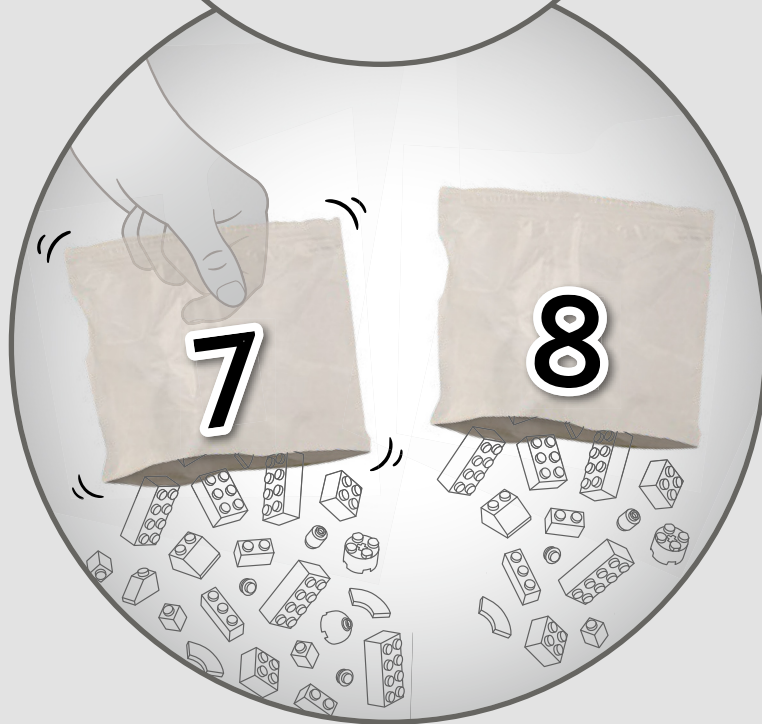

12x

34

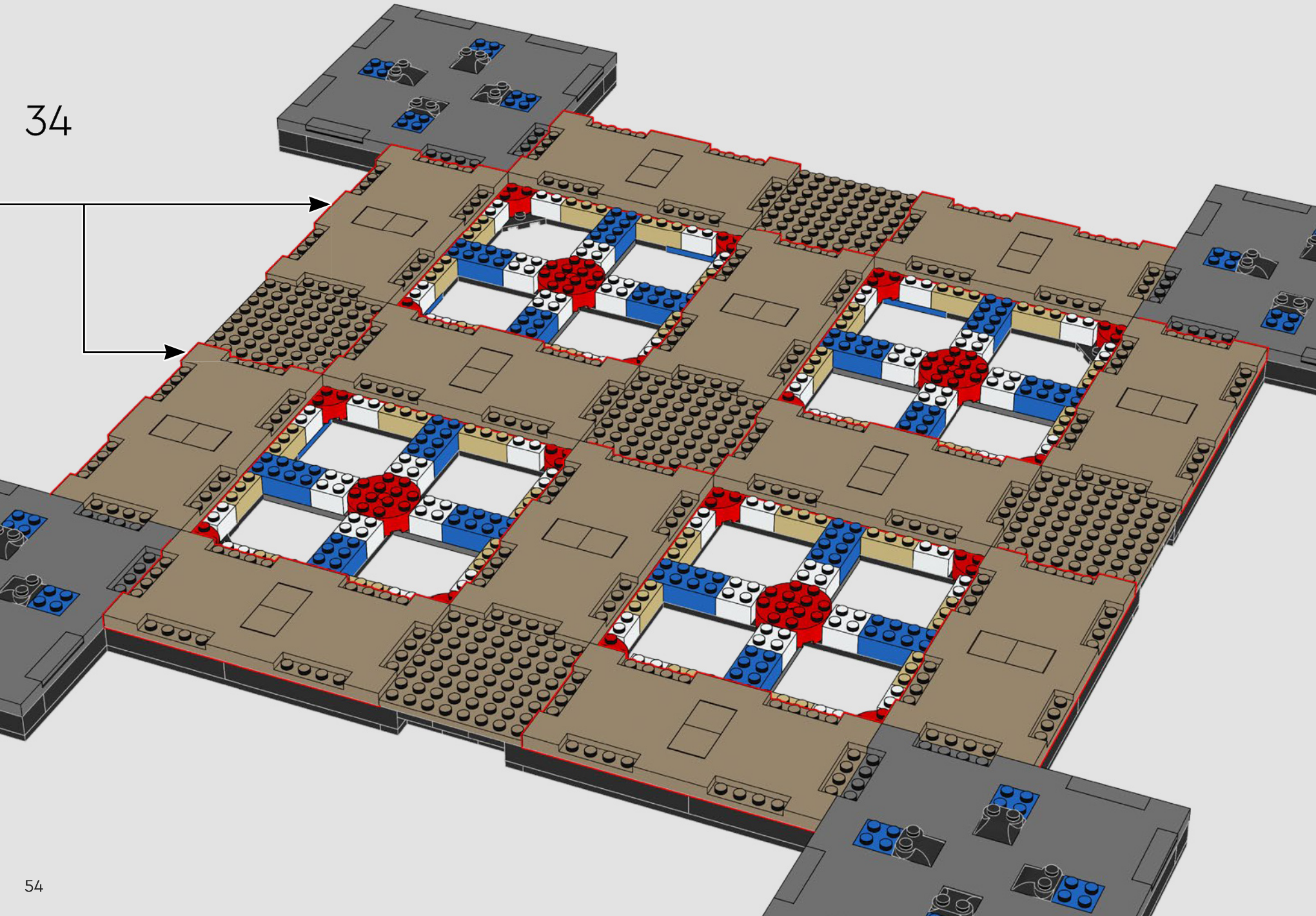

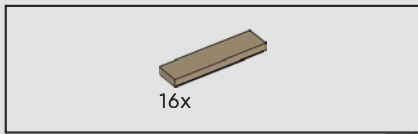

35

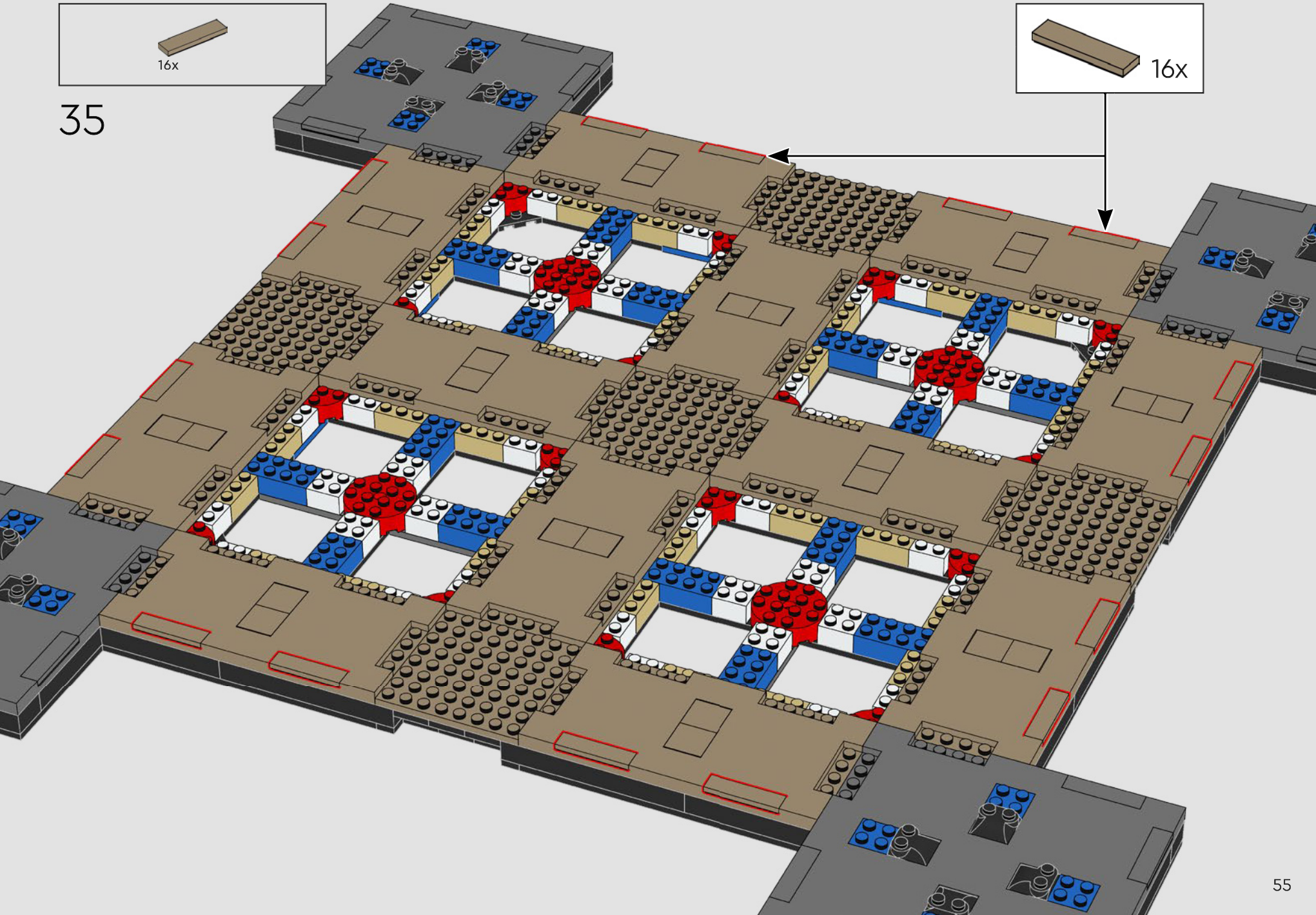
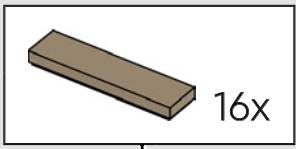

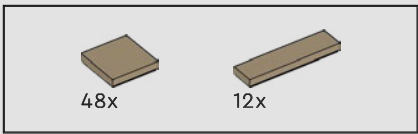

36

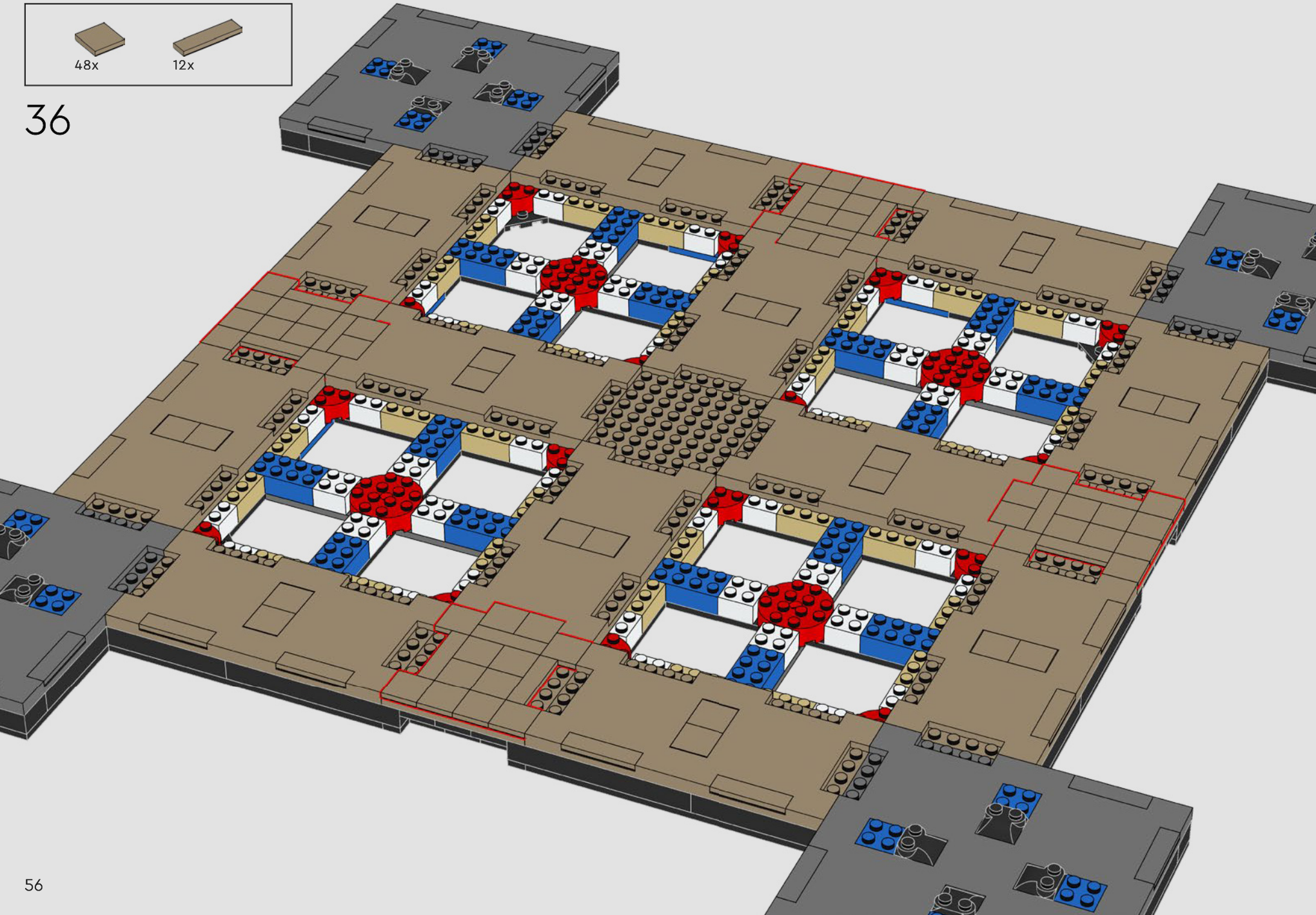



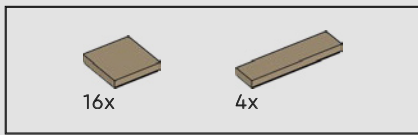

37

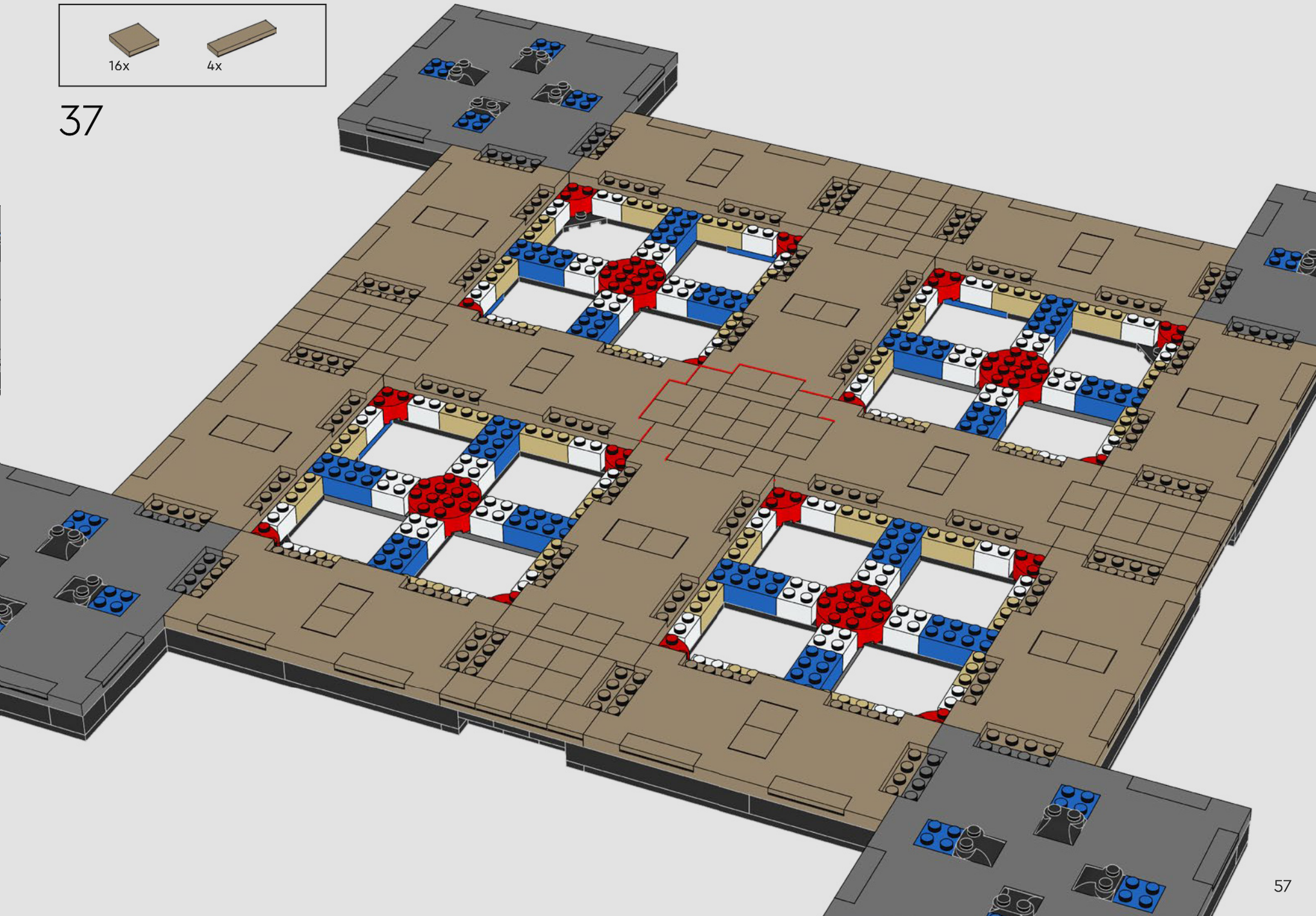



16x

38



16x

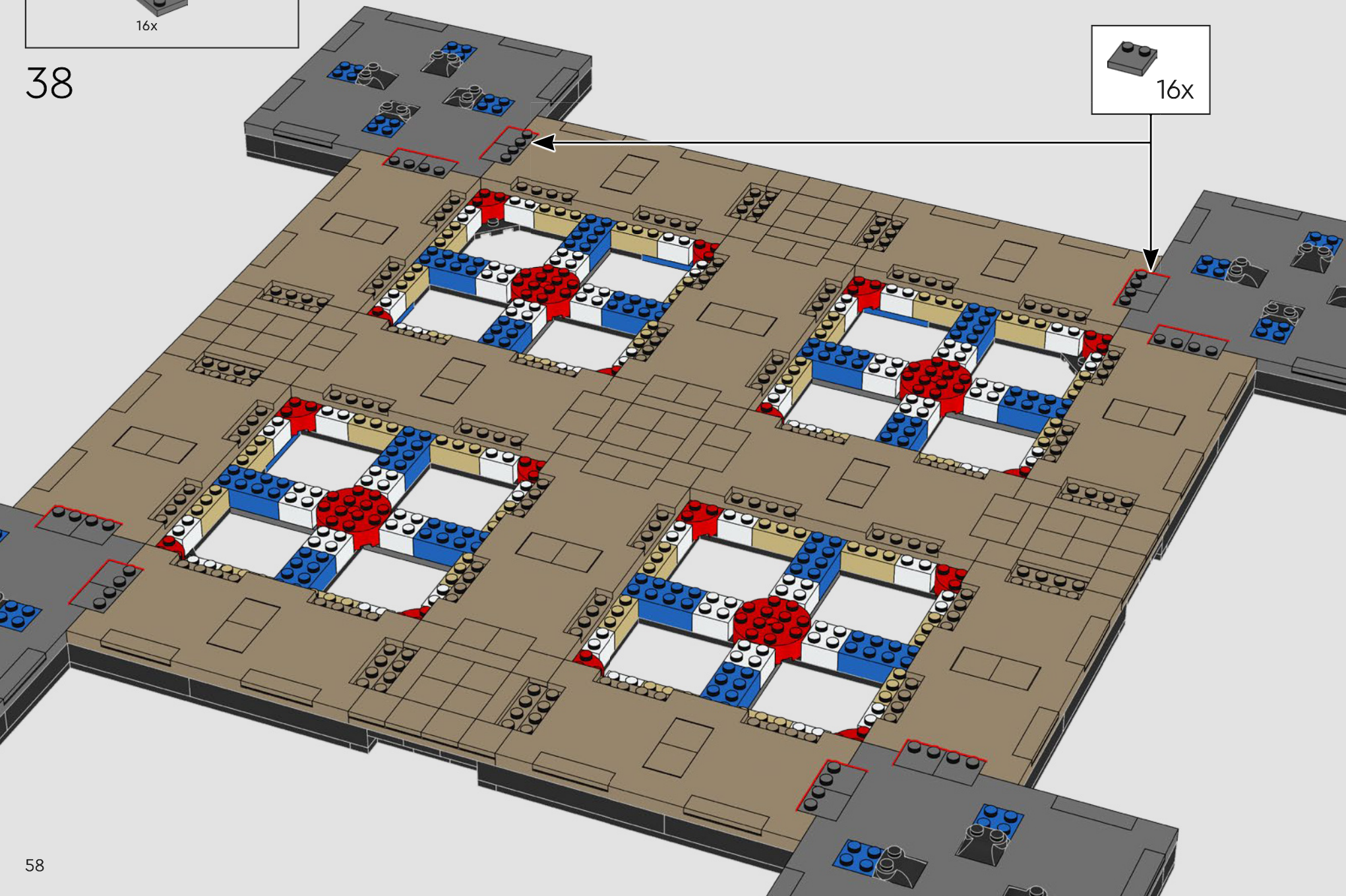

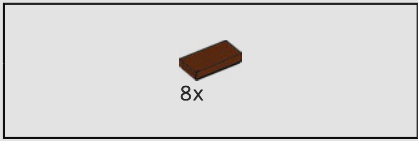

39

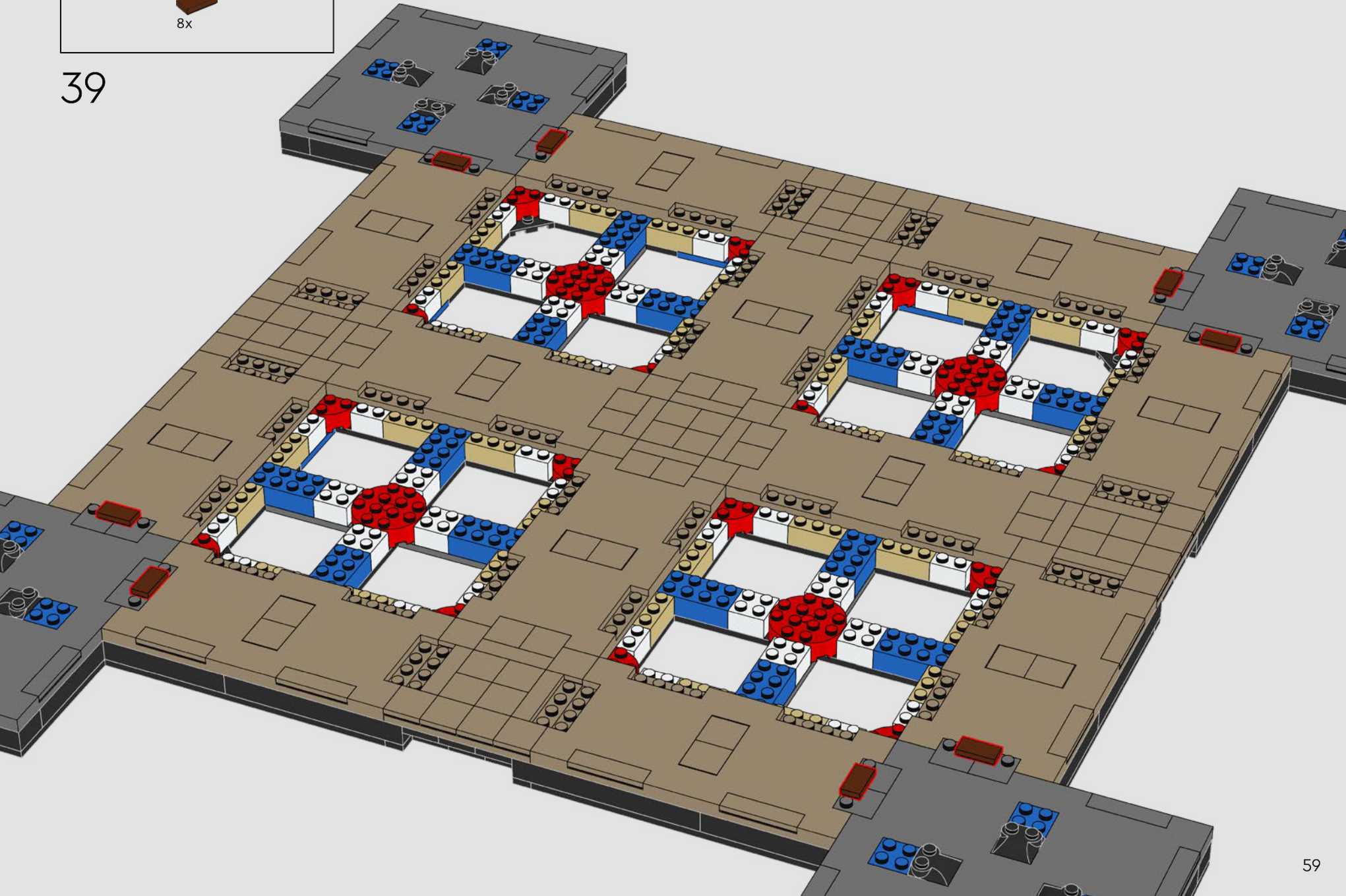

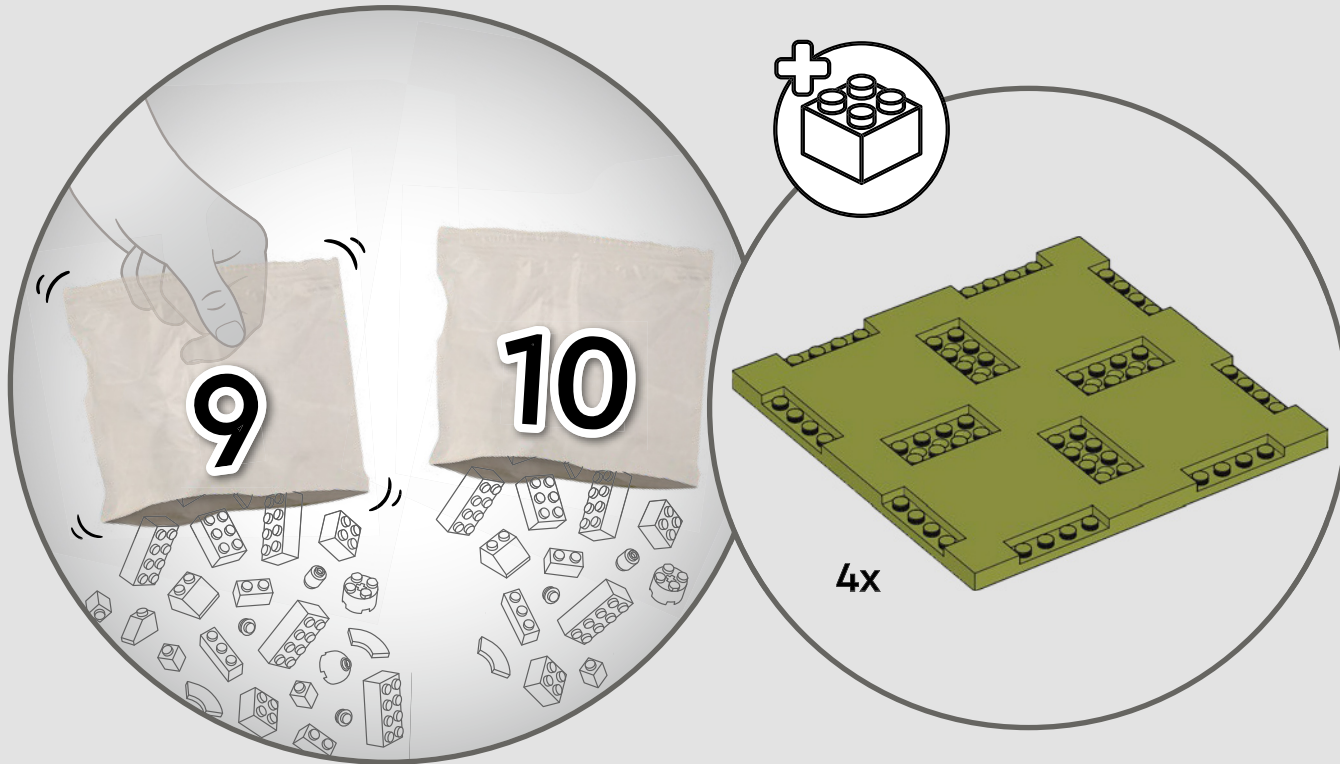

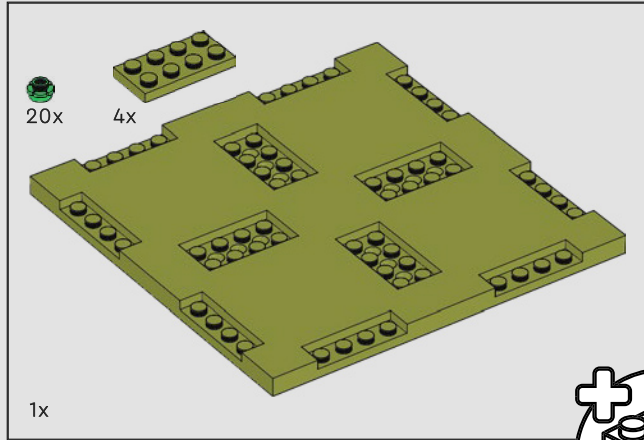
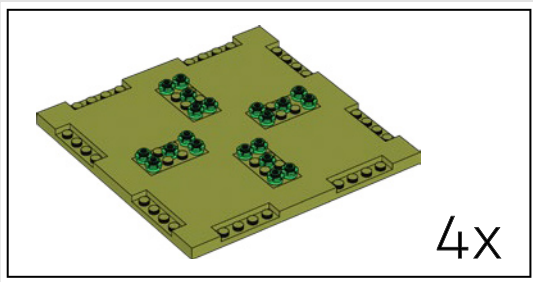

40

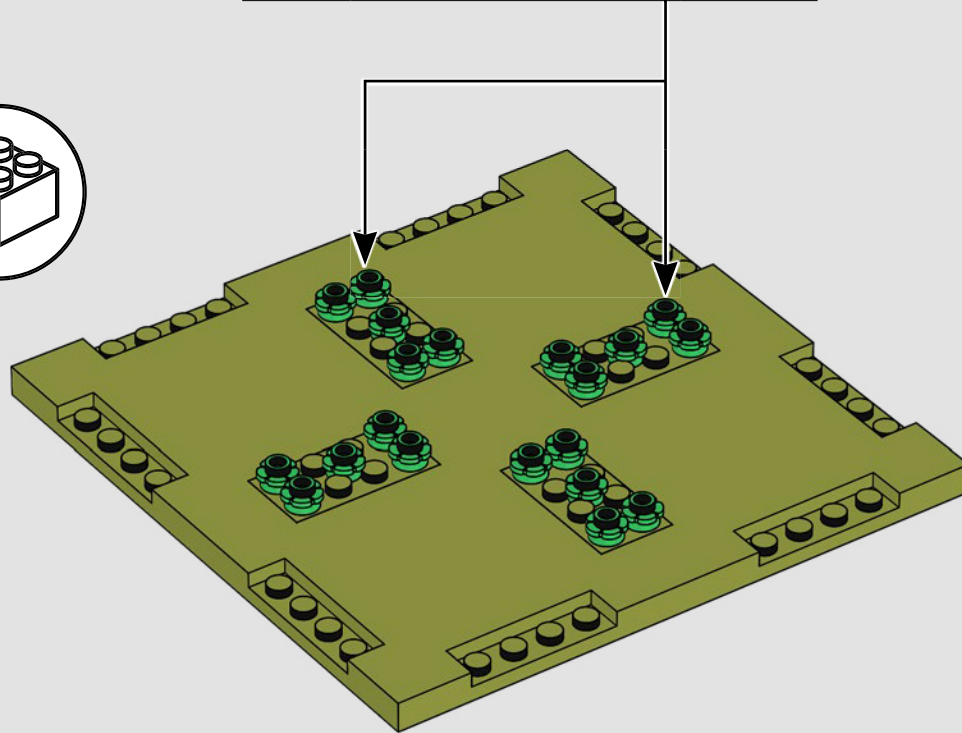
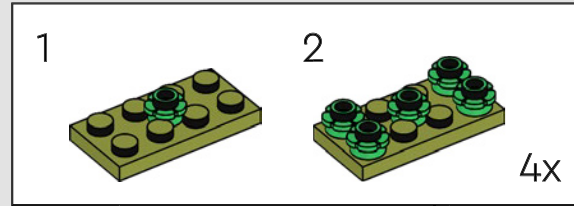
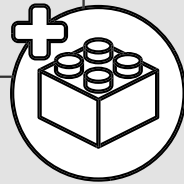

41

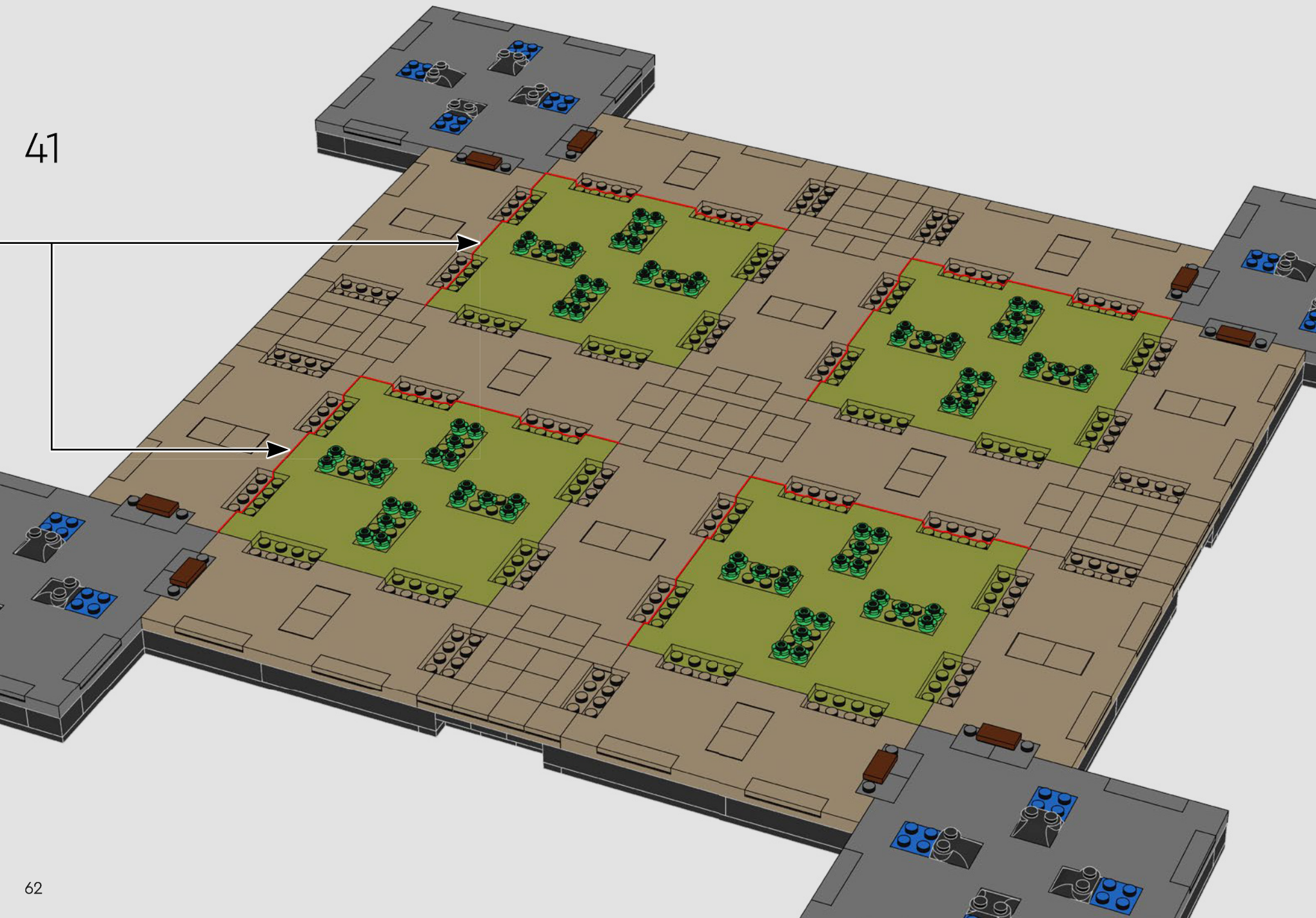

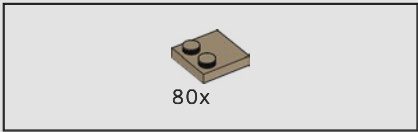

42

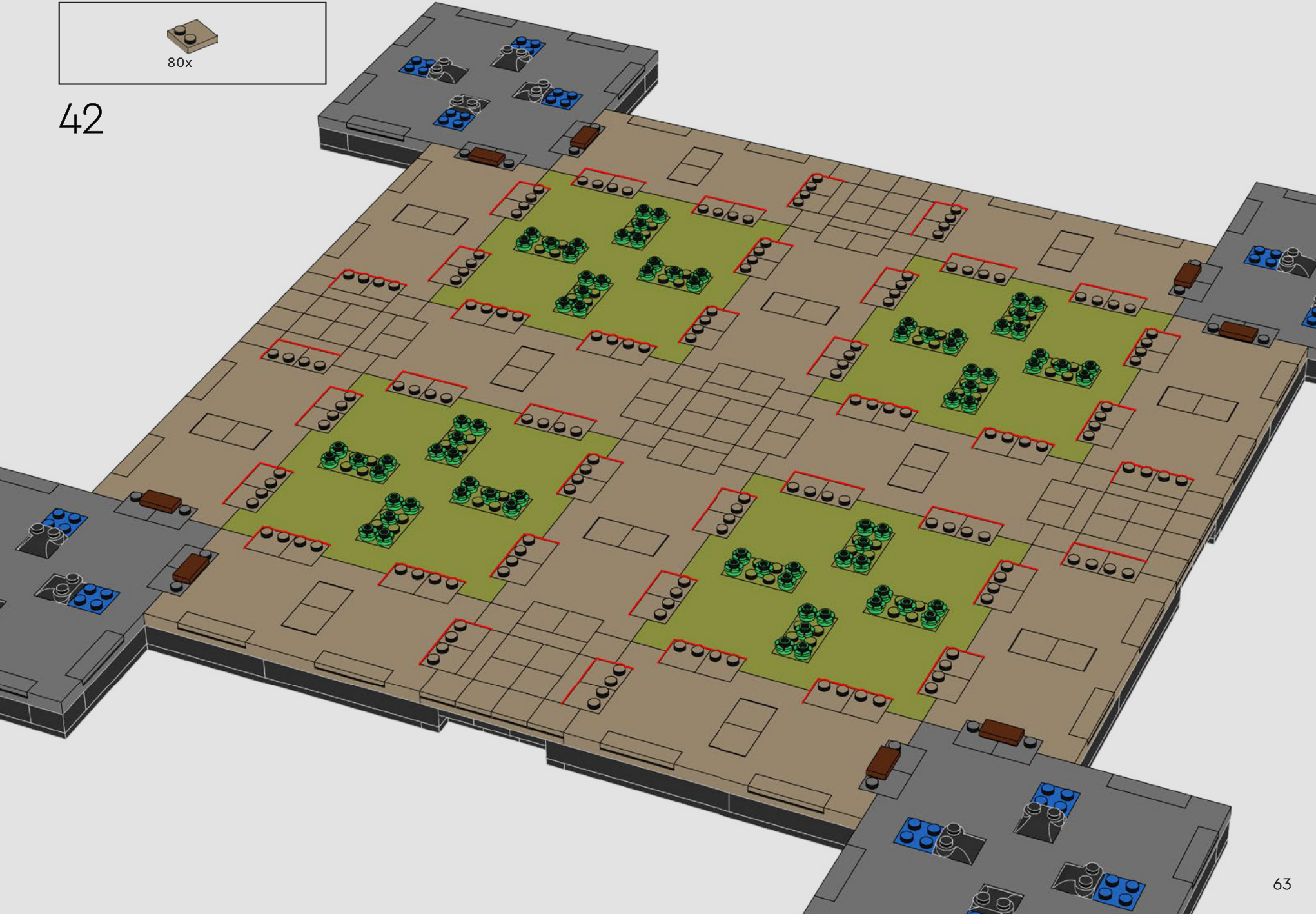



40x

43

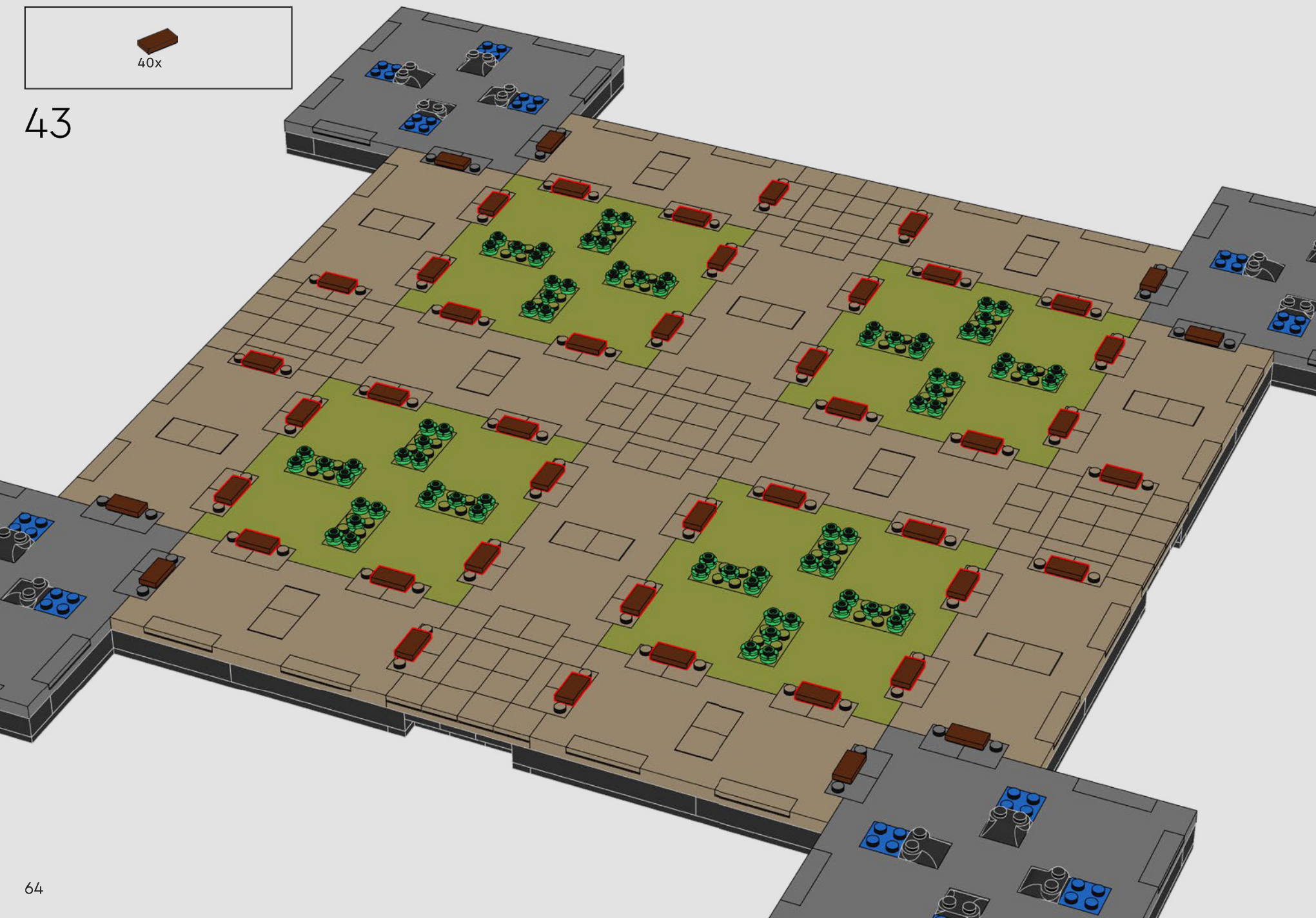



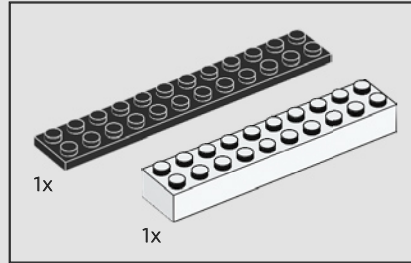
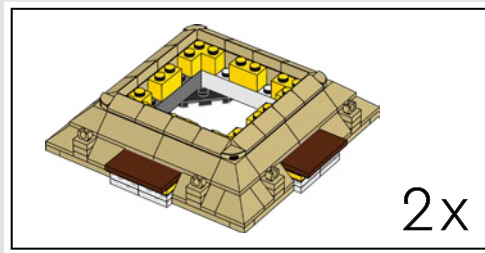

44

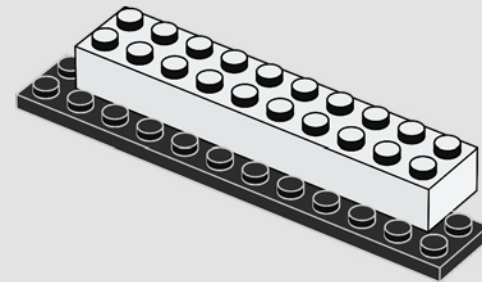

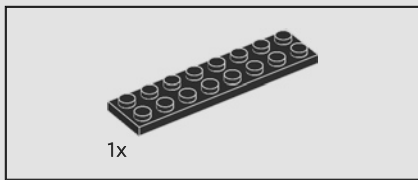

45

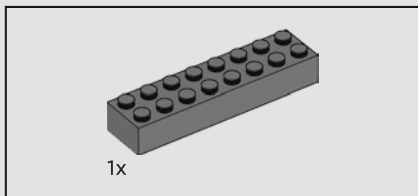
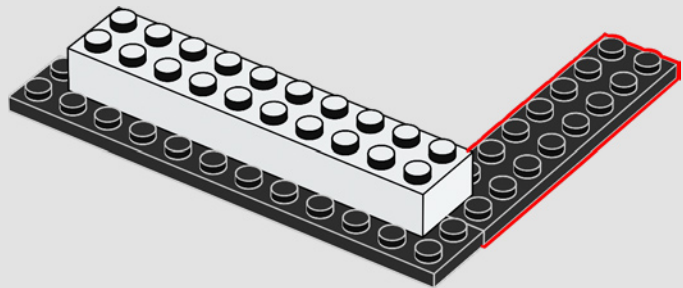

46

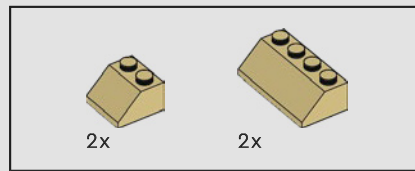
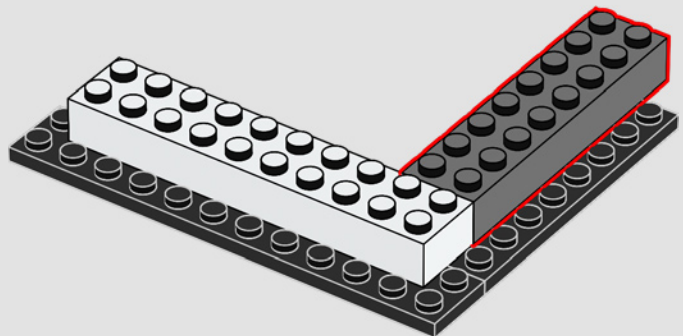

47

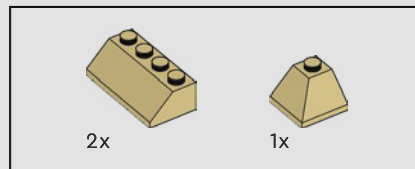
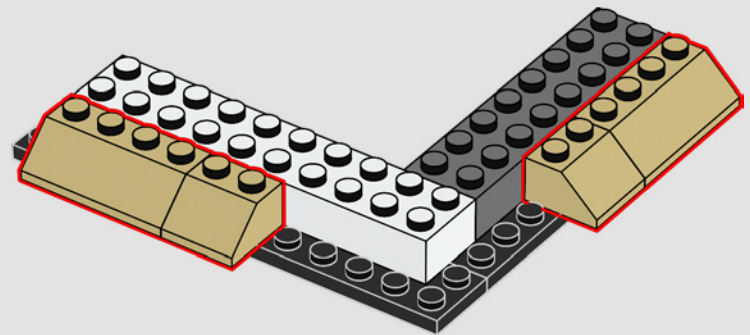

48

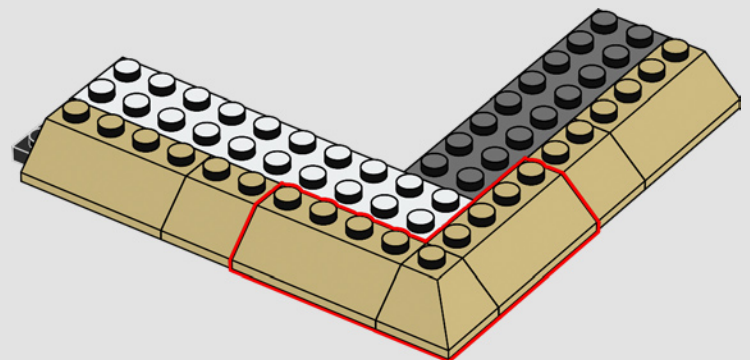

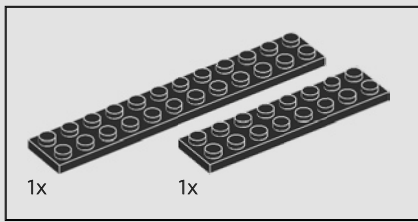

49

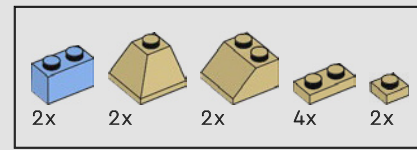
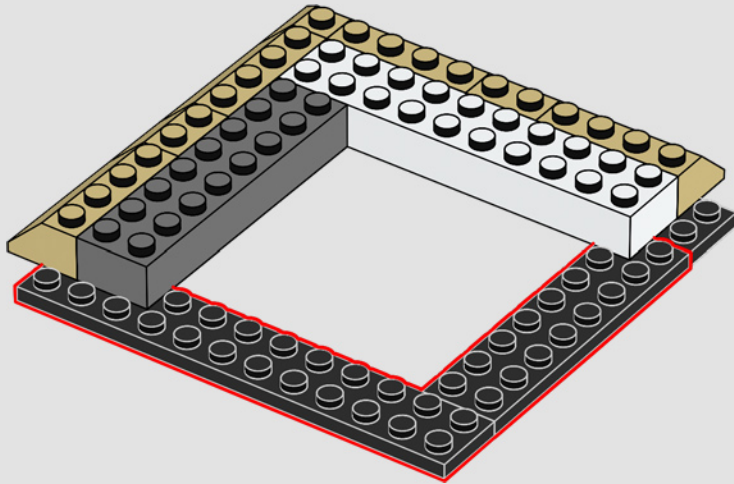

50

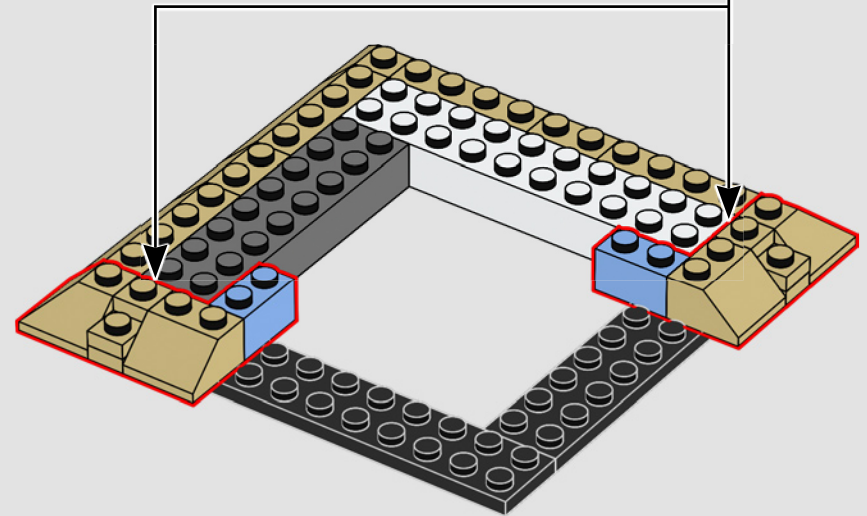
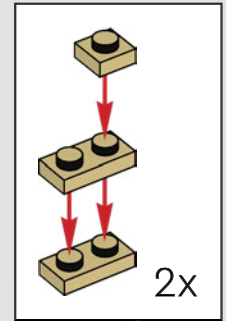

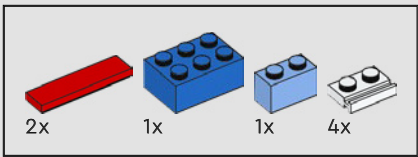

51

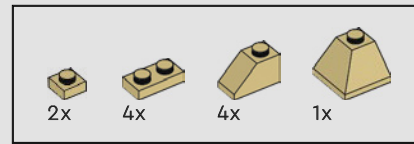
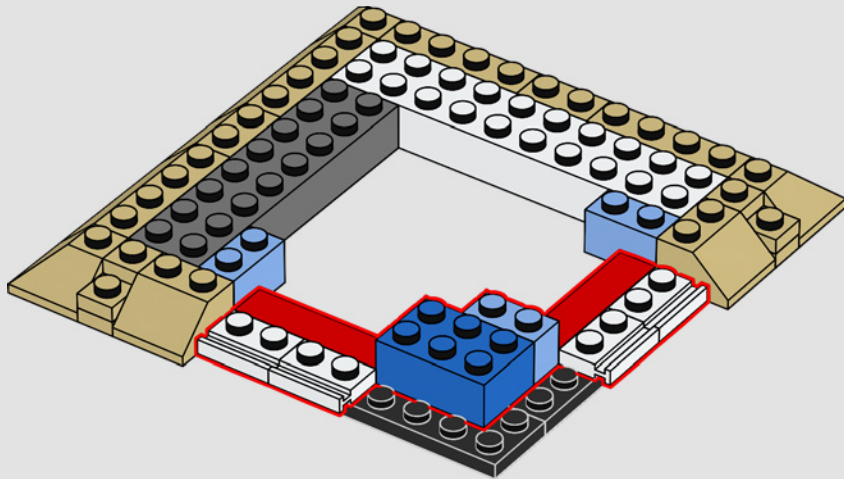

52

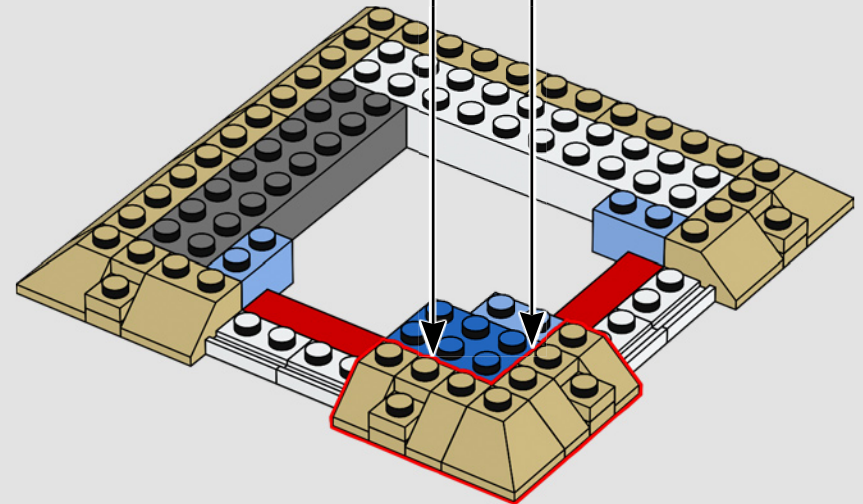
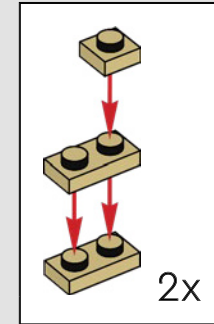

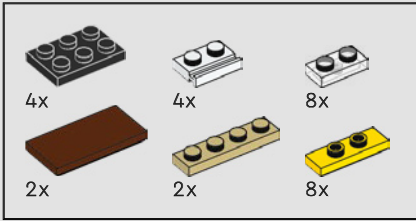
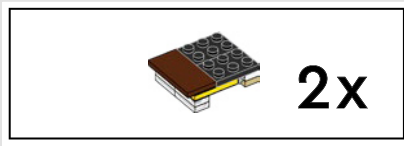

53

1

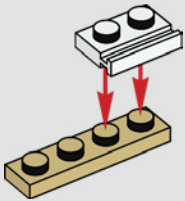

2

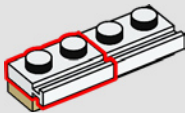

3

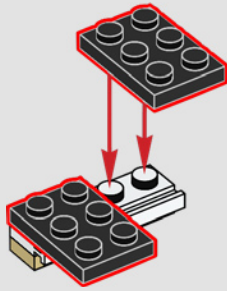

4

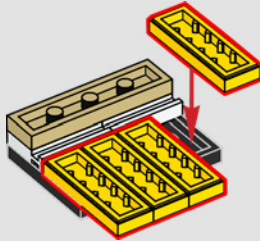

5

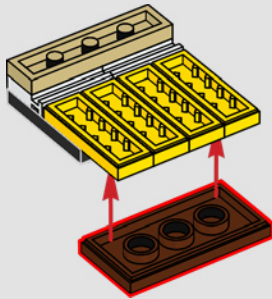

6

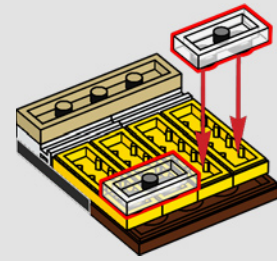

7

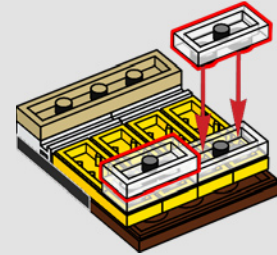

2x

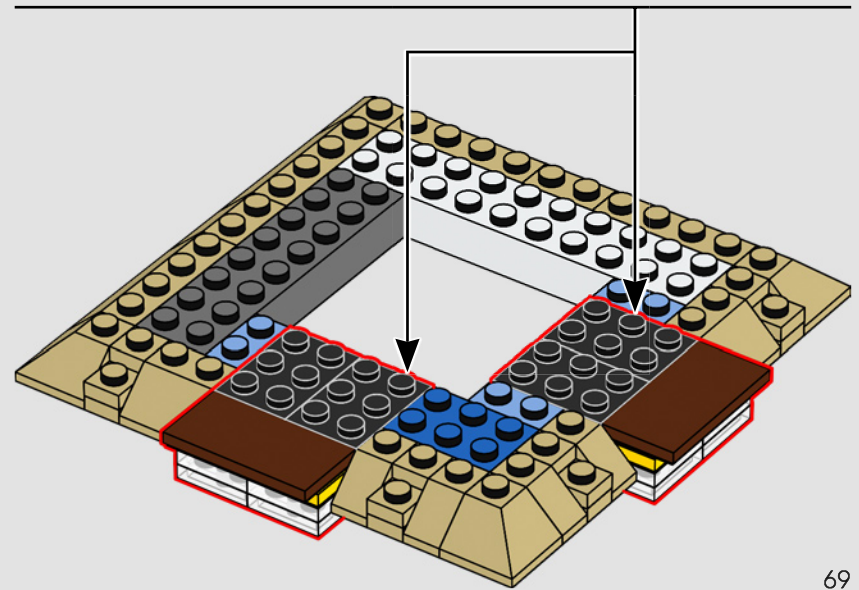

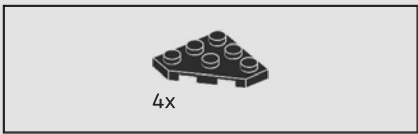

54

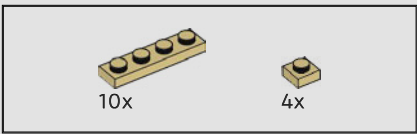
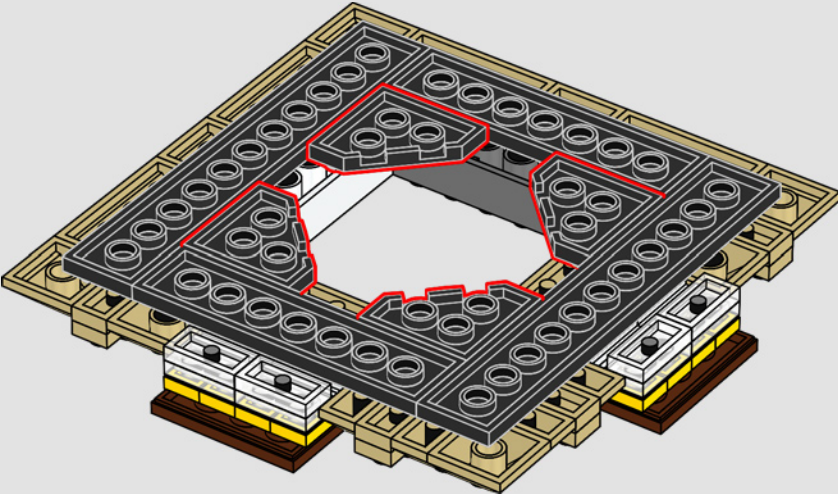

55

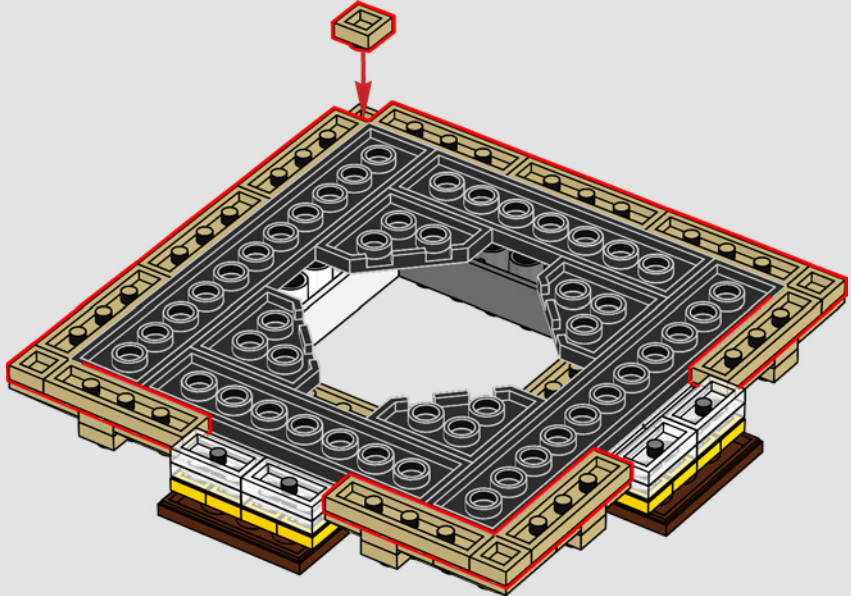

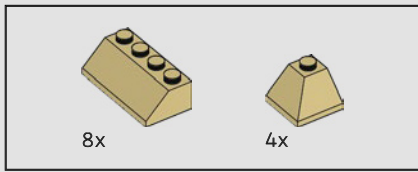

56

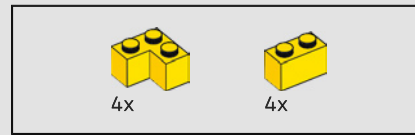
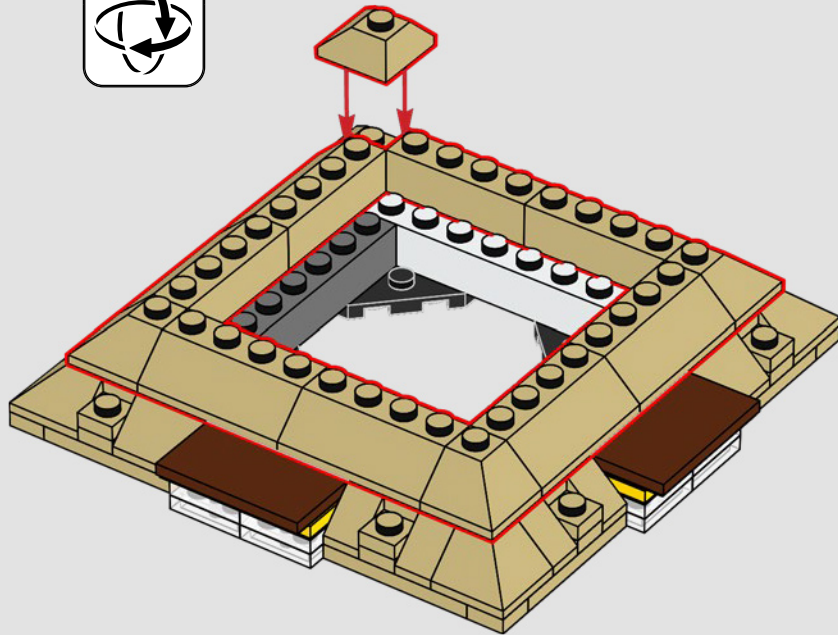

57

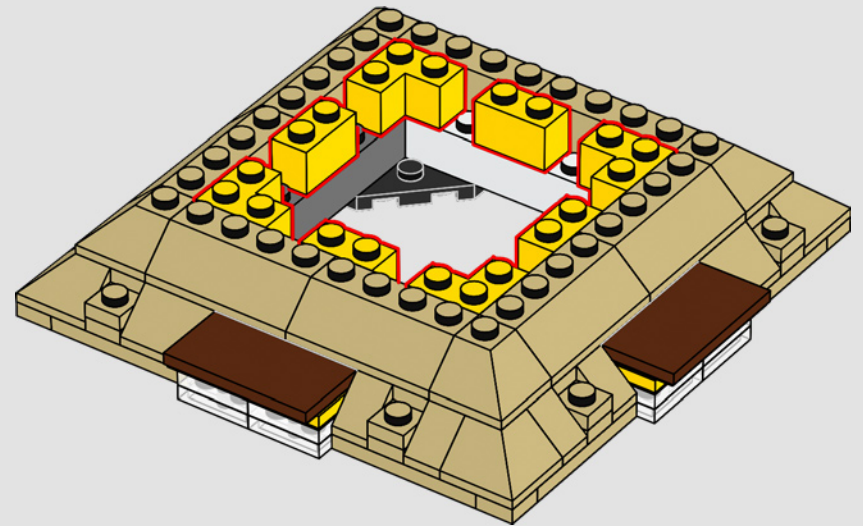



16x

58

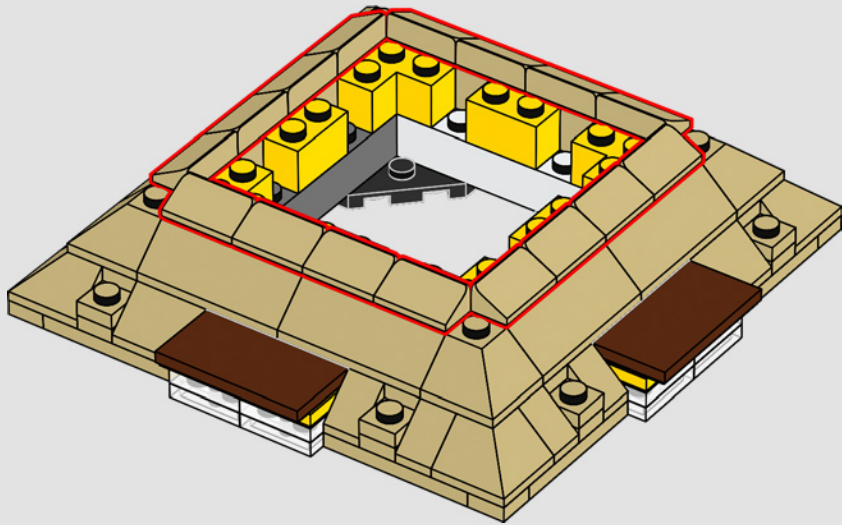

4x



4x

59

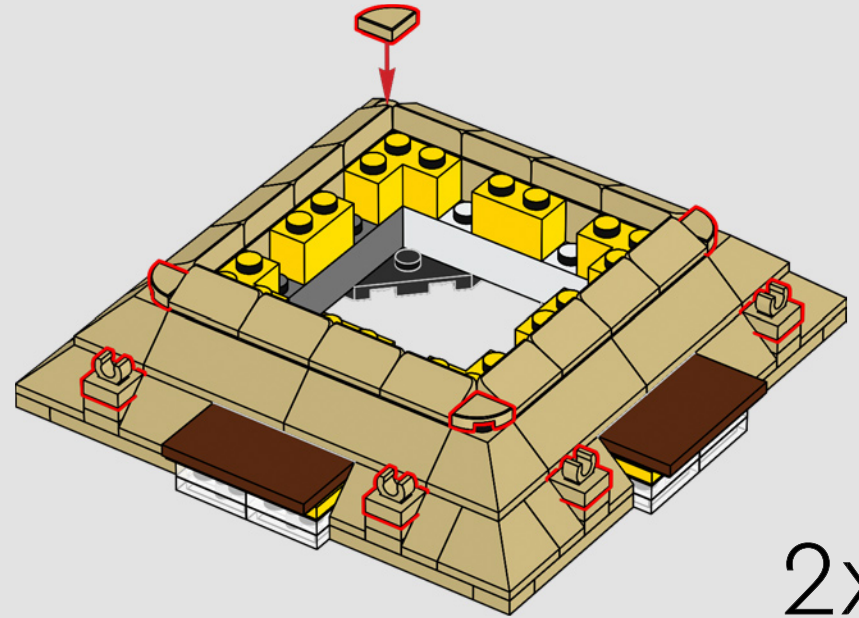

2x



60

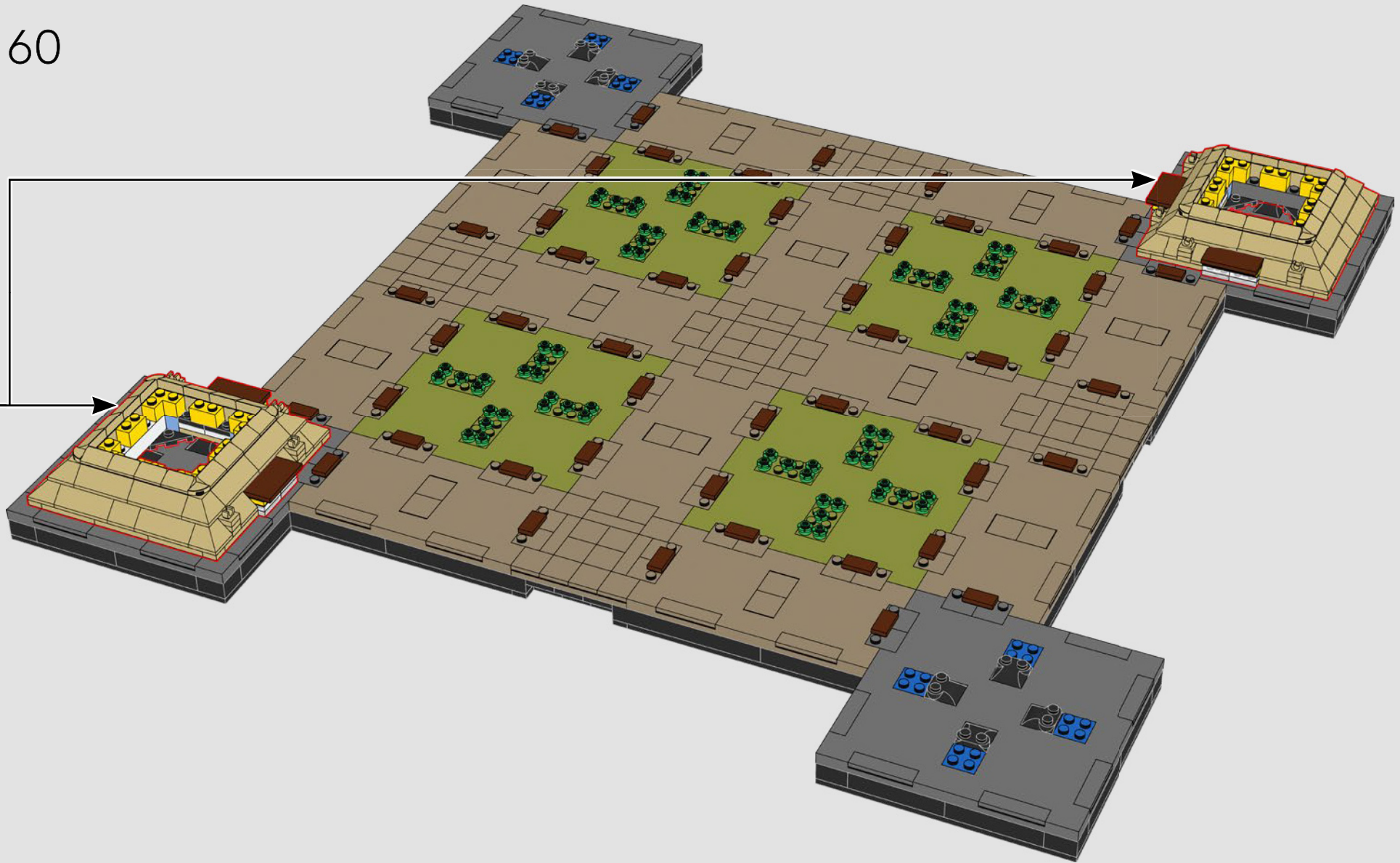

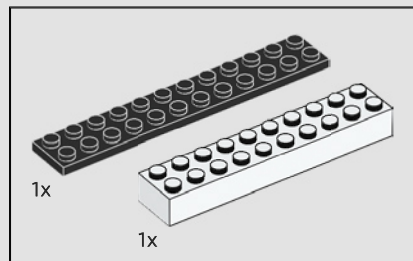
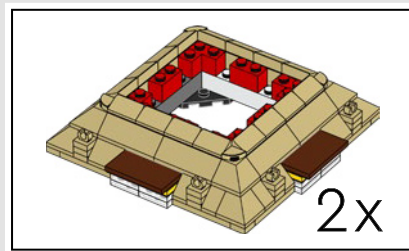

61

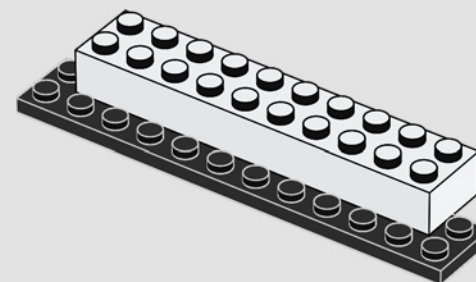

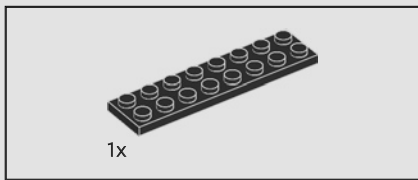

62

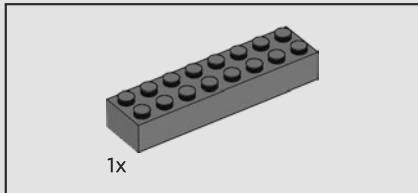
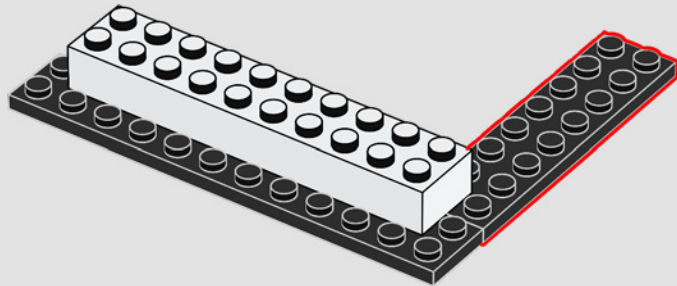

63

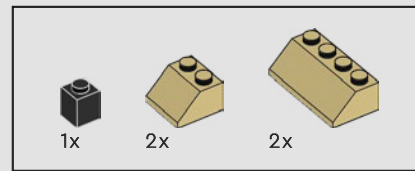
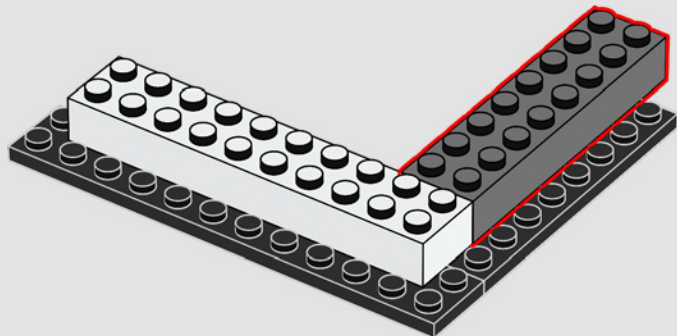

64

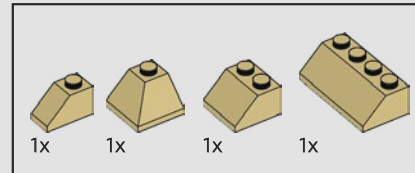
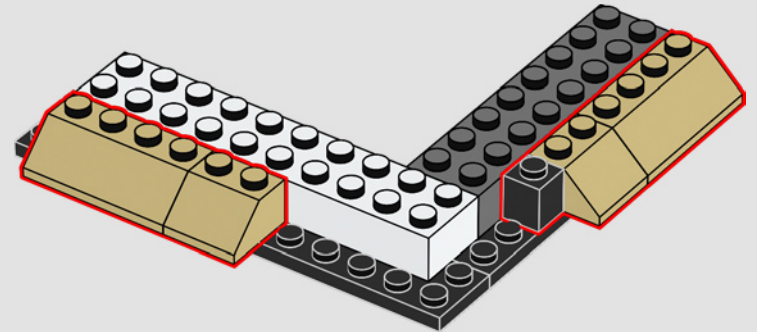

65

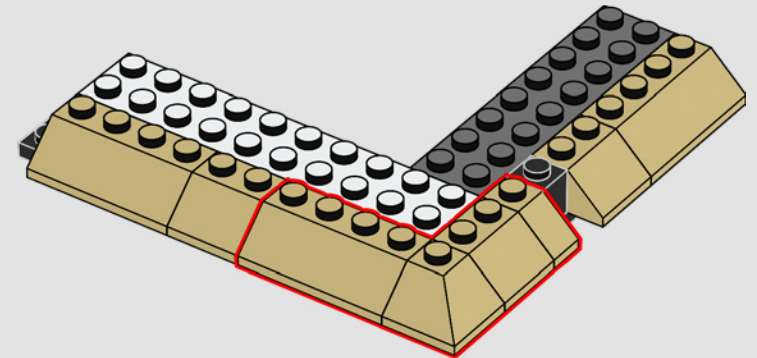

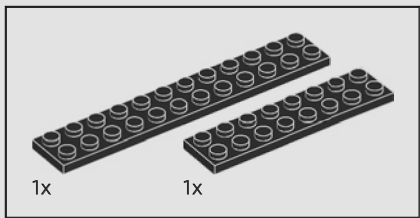

66

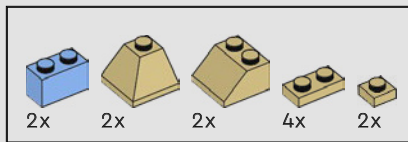
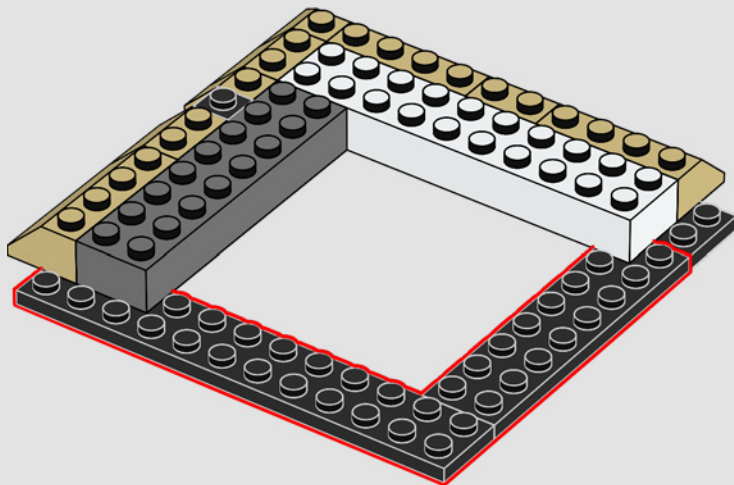

67

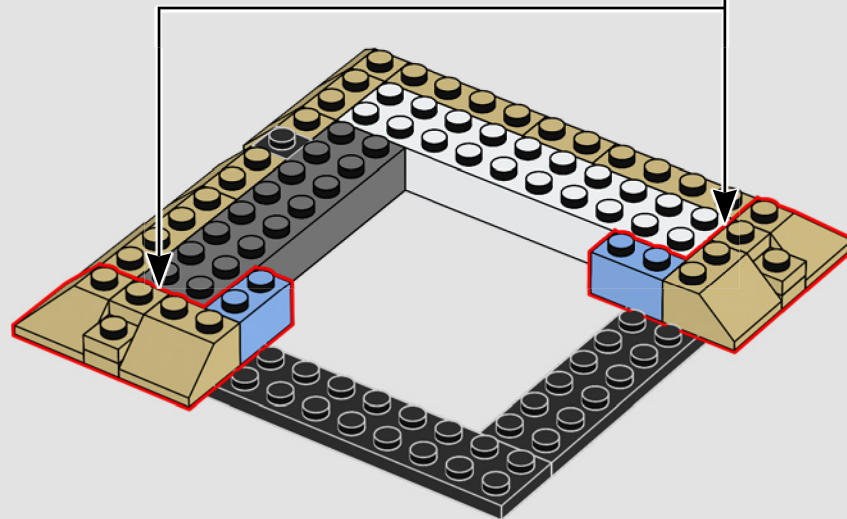
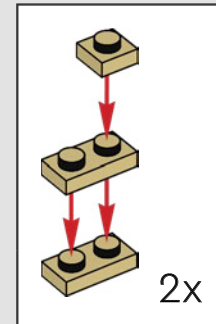

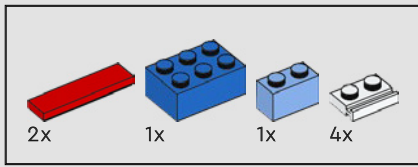

68

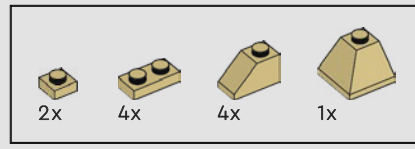
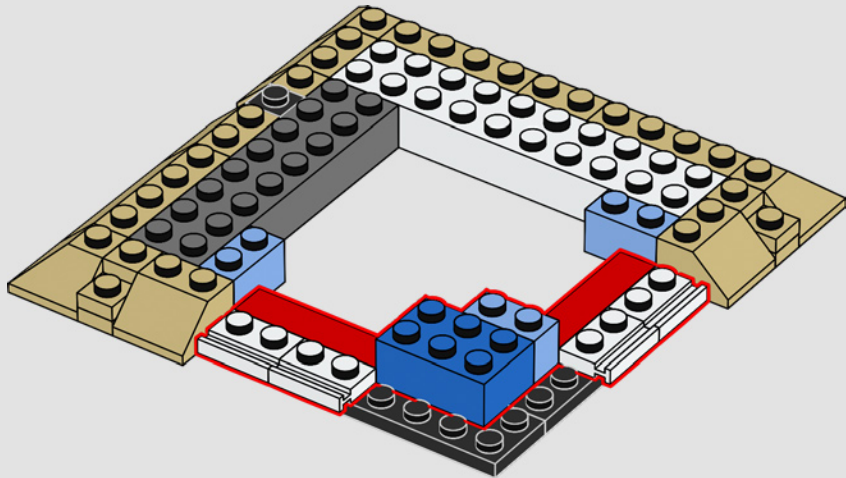

69

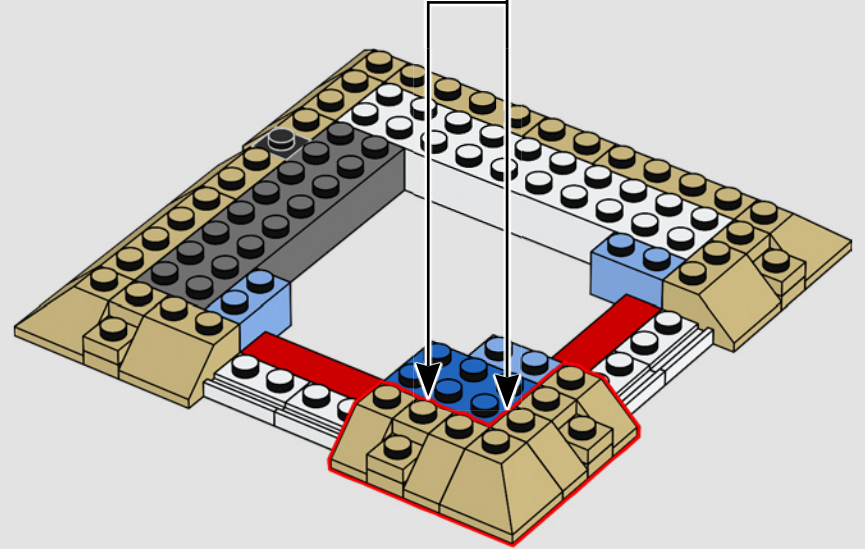
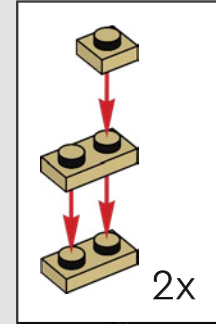

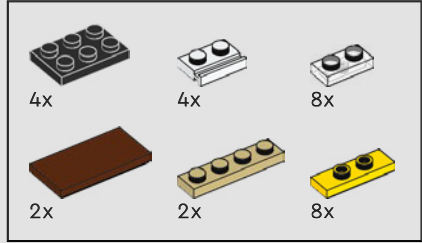

70

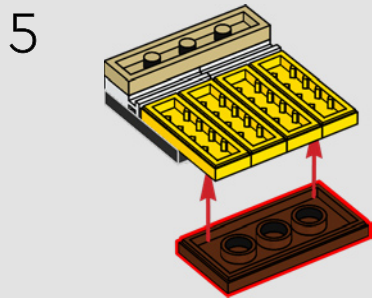
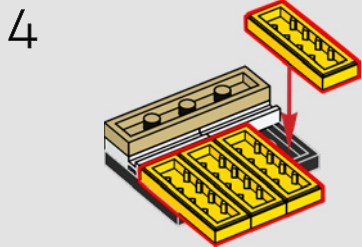
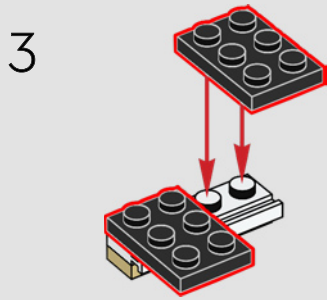
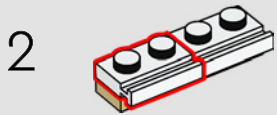
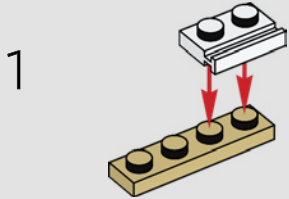

6

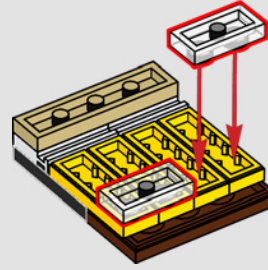

7

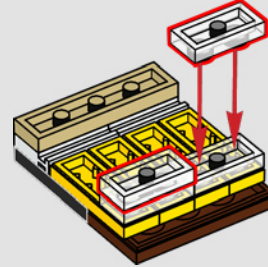

2x

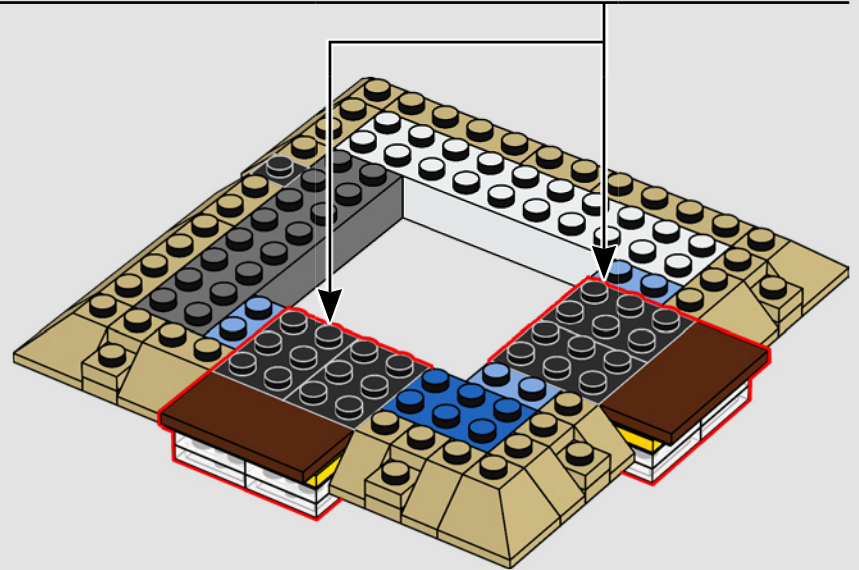

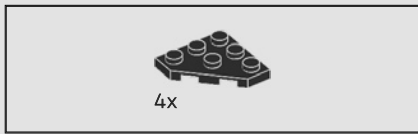

71

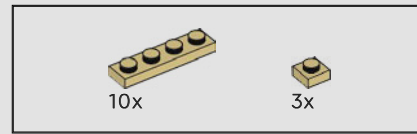
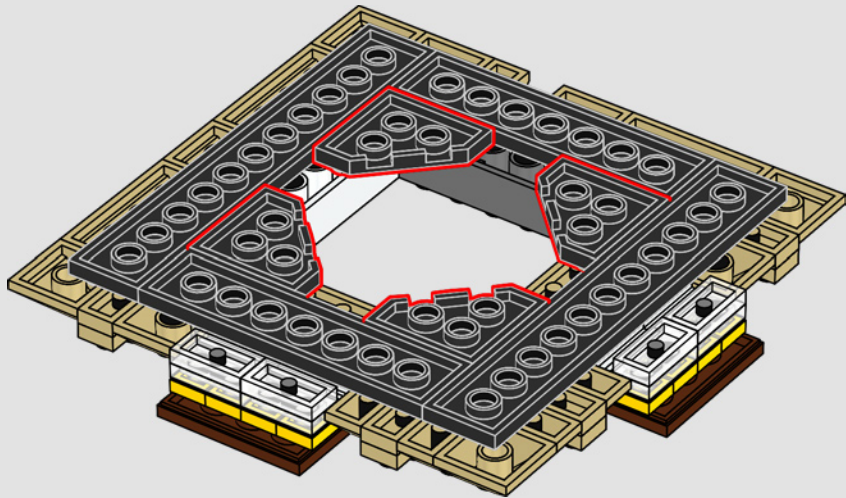

72

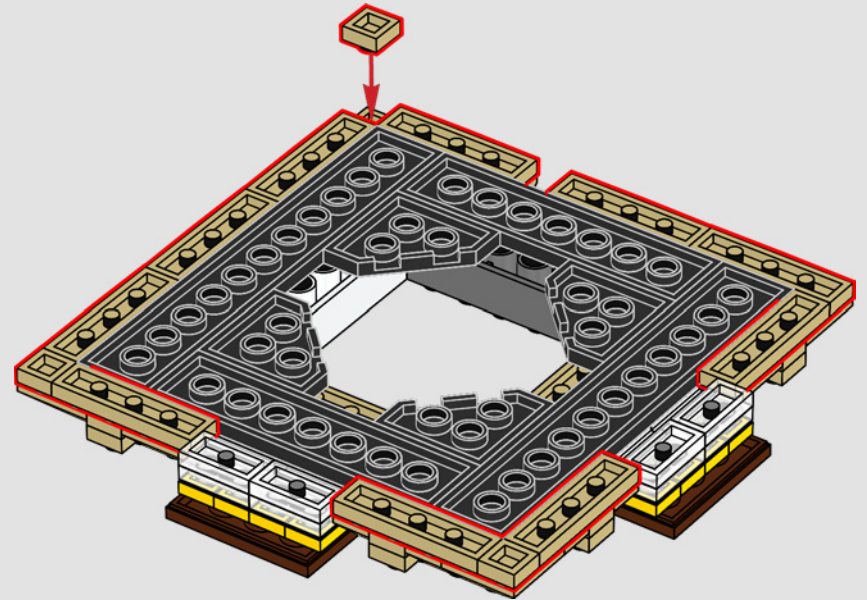

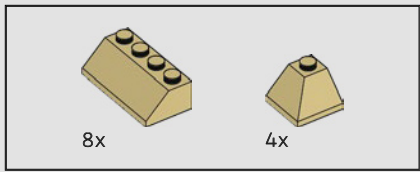

73

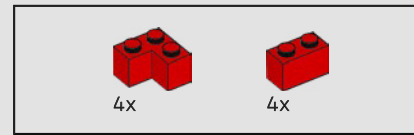
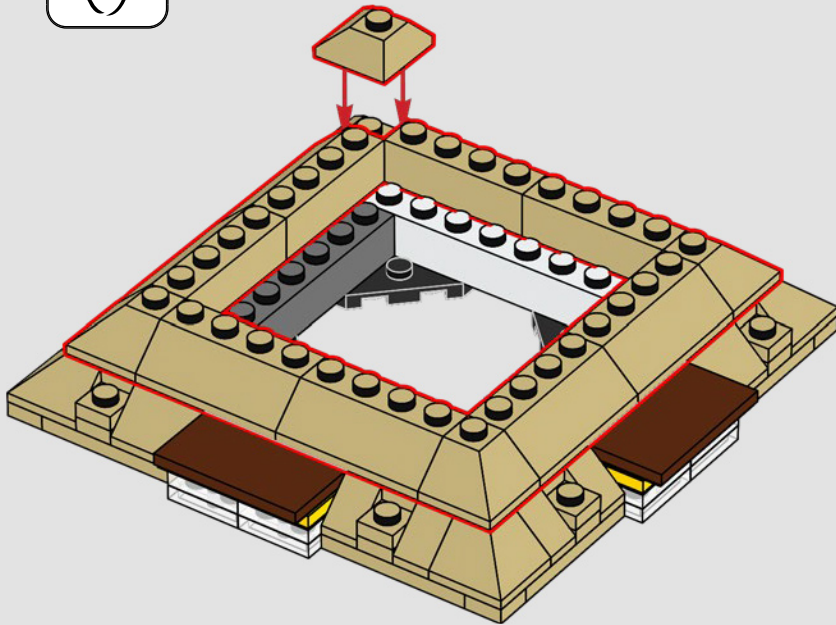

74

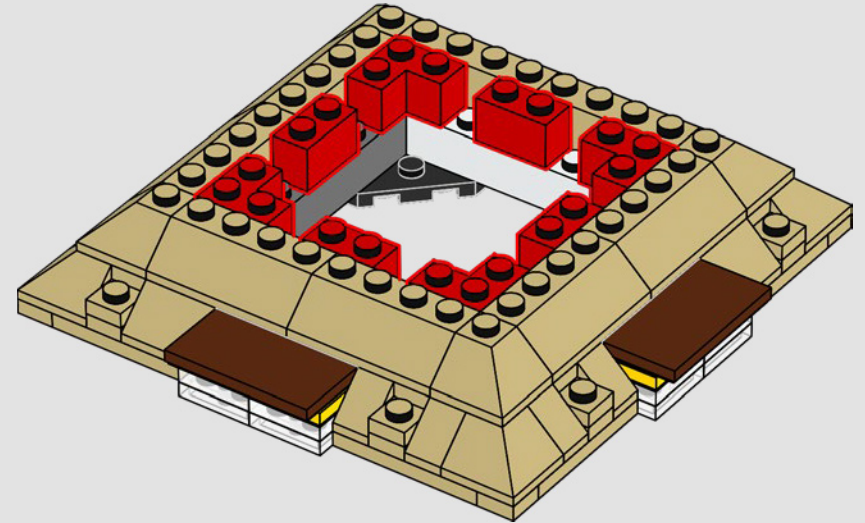



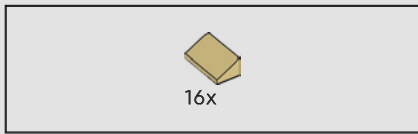

75

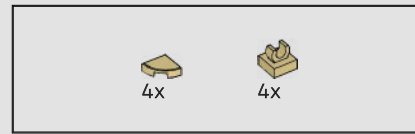
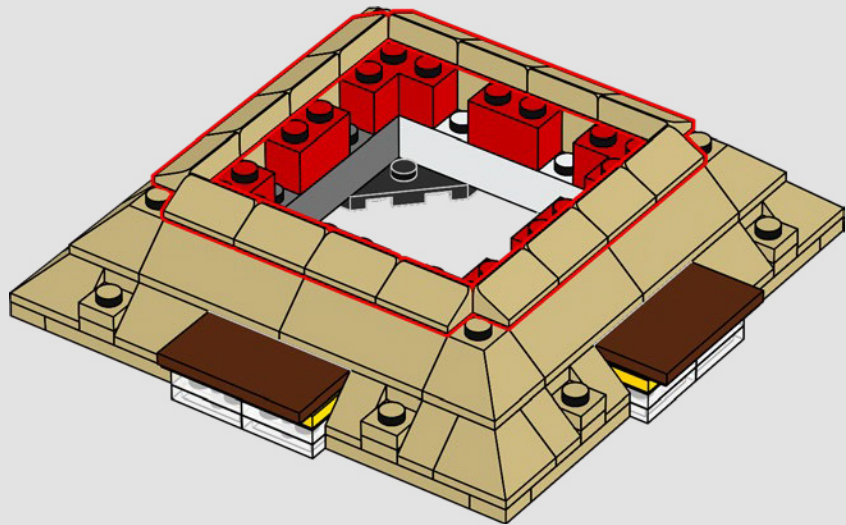

76

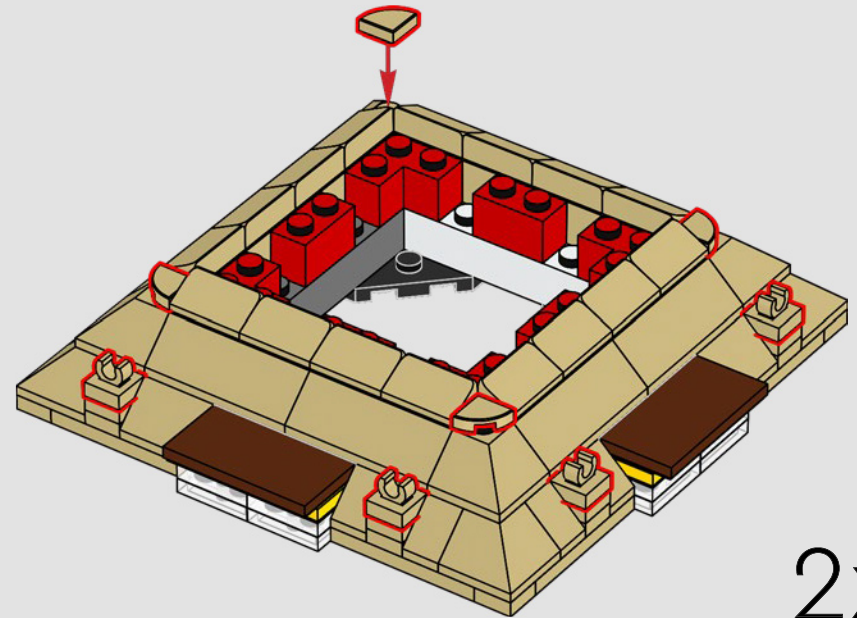

2x

77

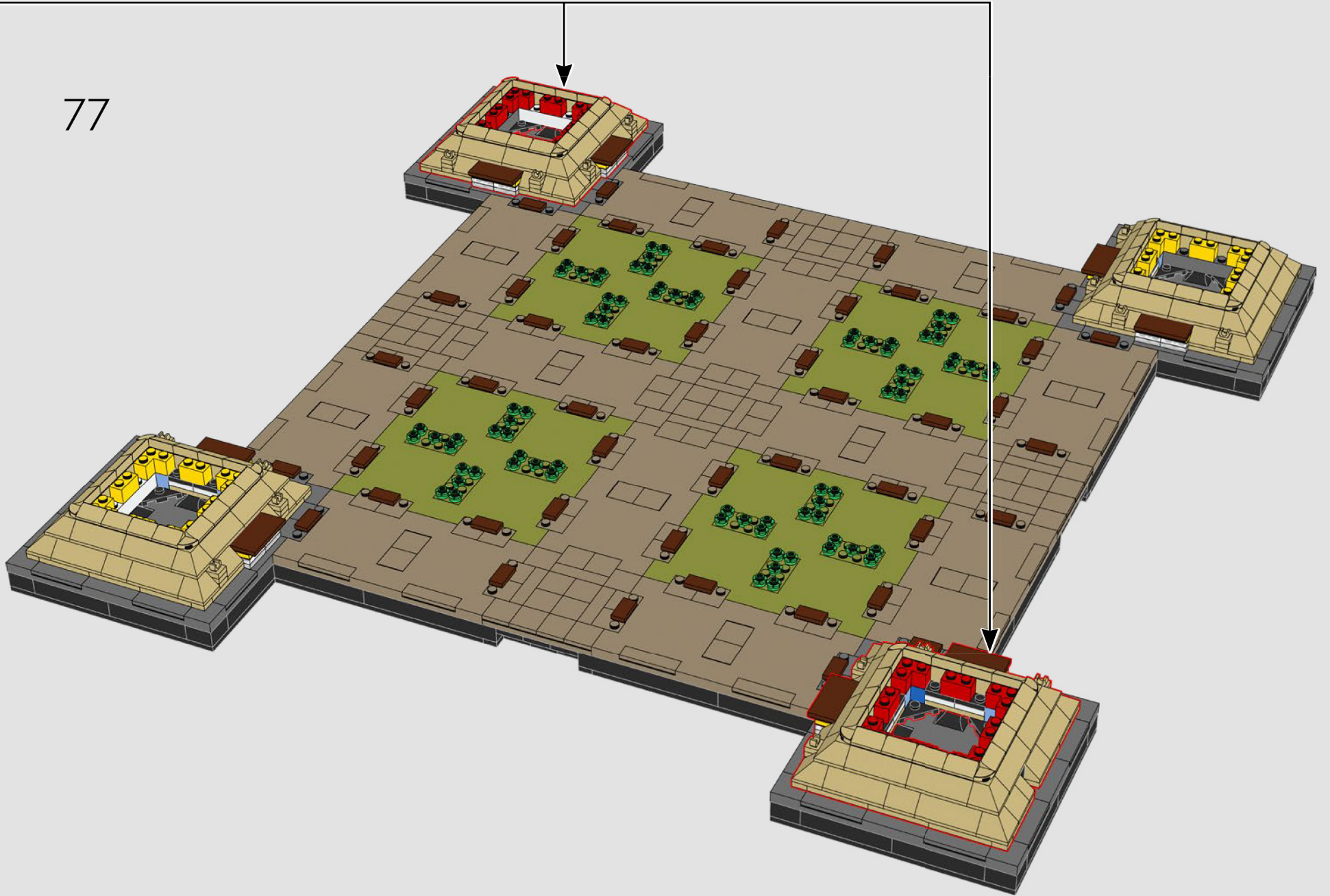



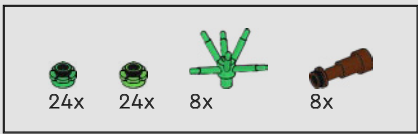

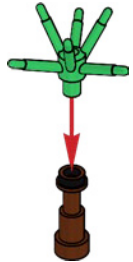

78

1 

2 

3 

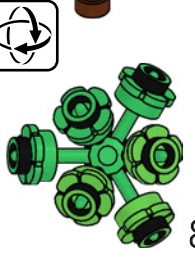
4  8x

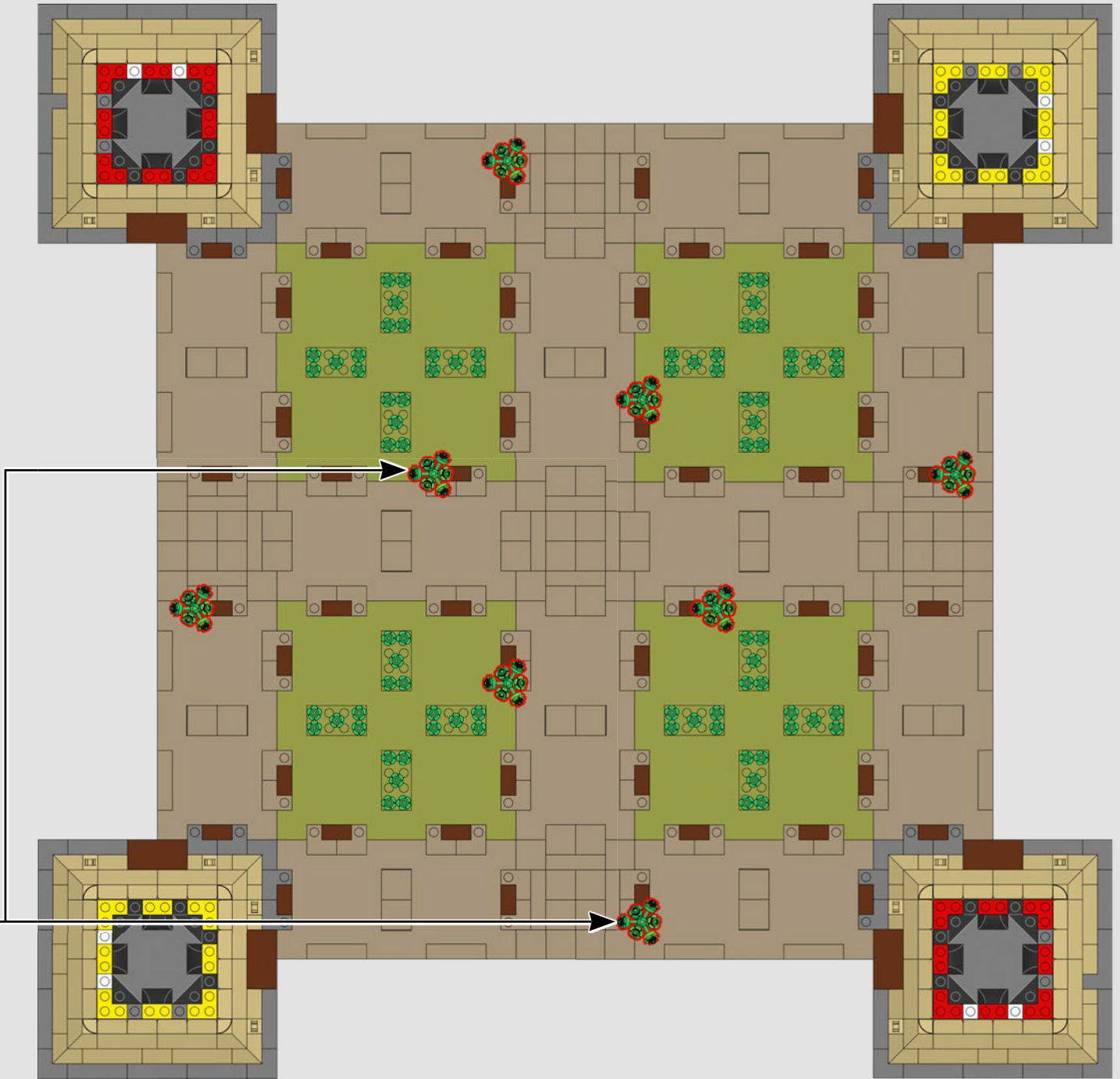

64x

79

1 

2 

 32x

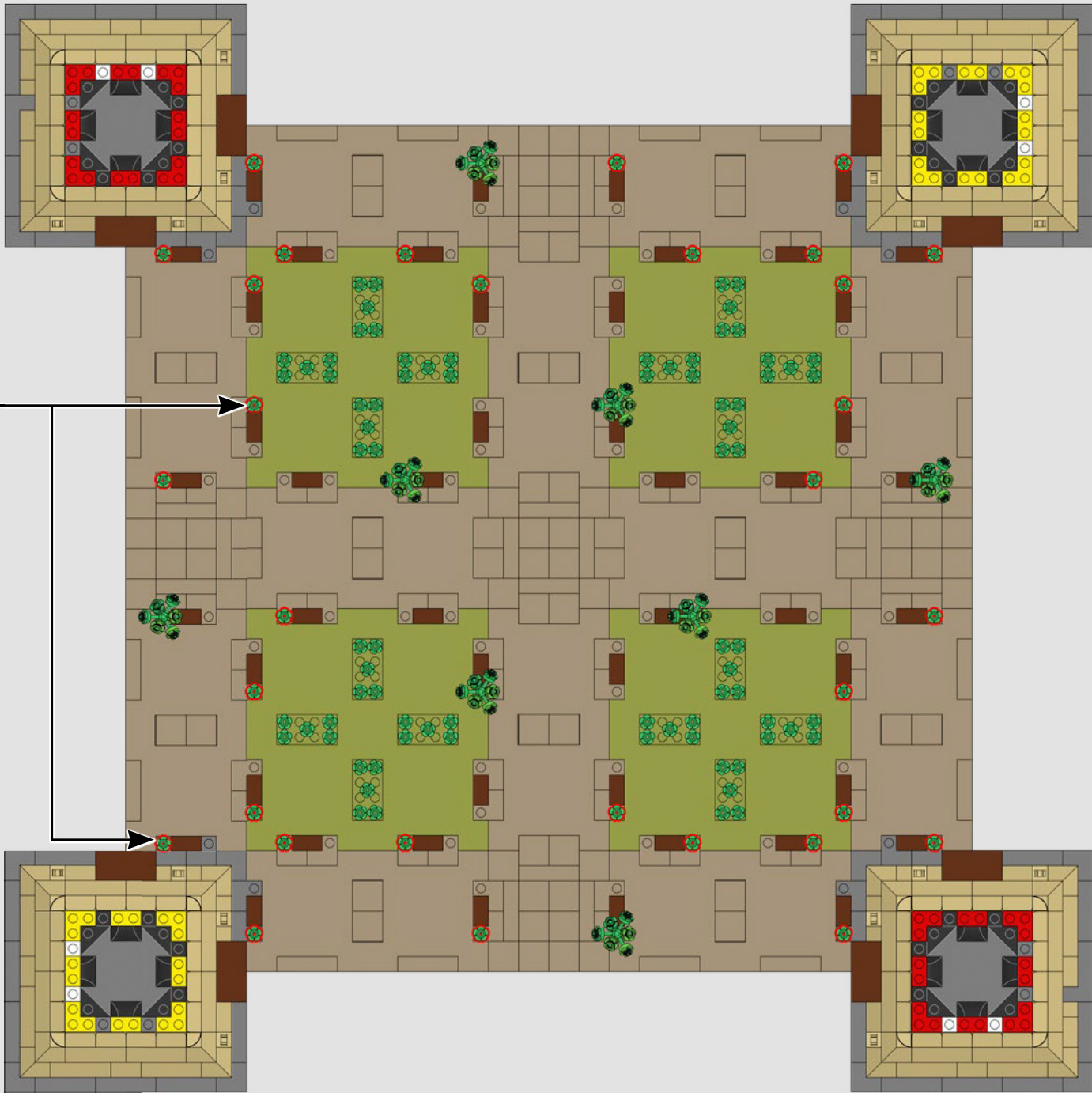



80

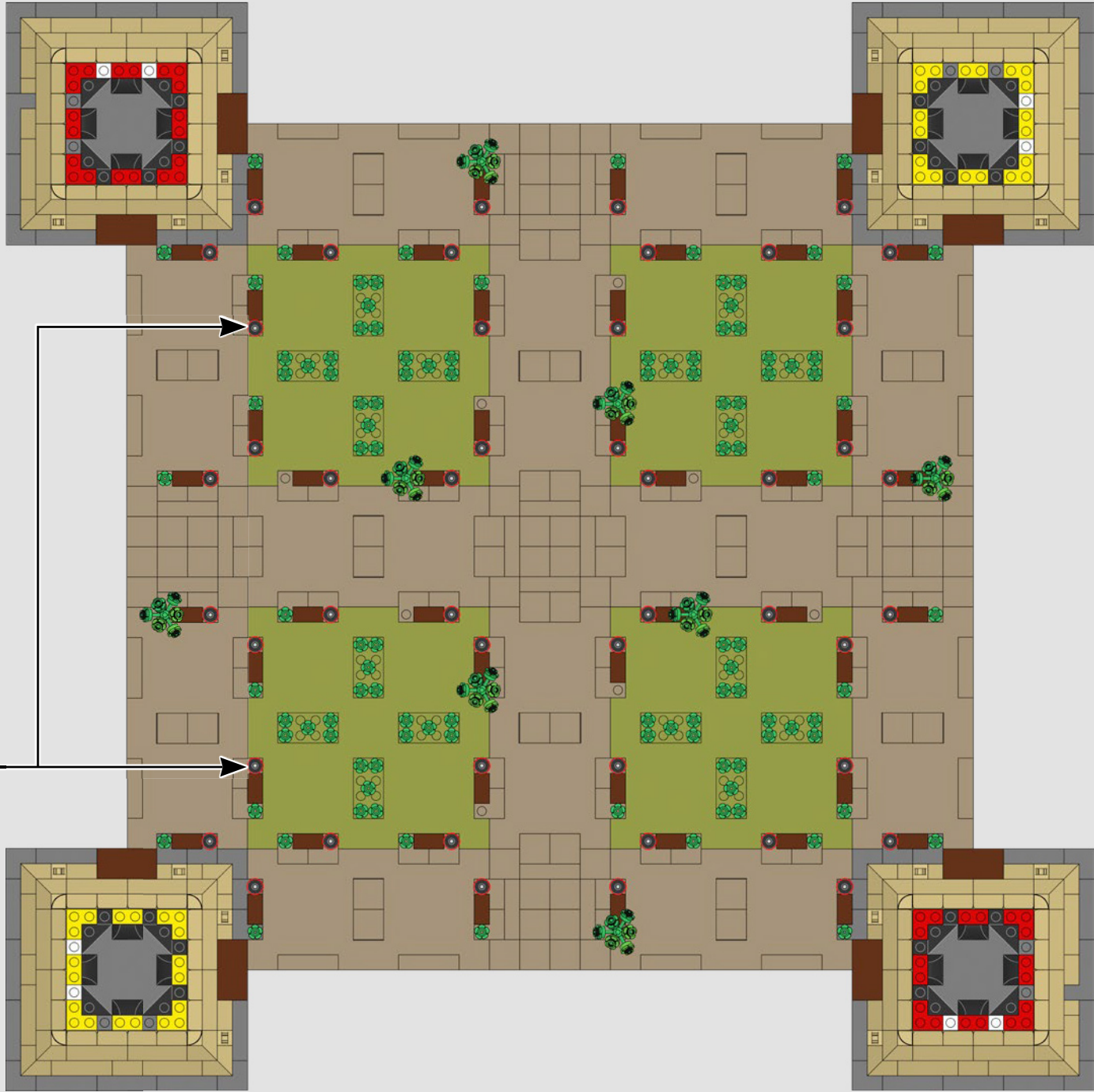
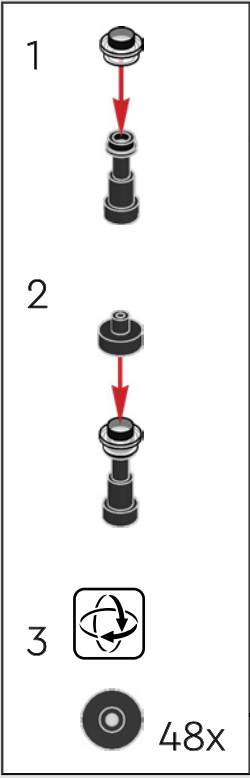



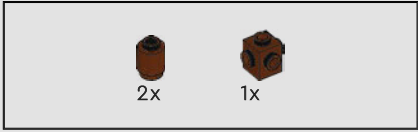
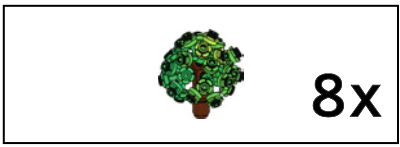

81



82

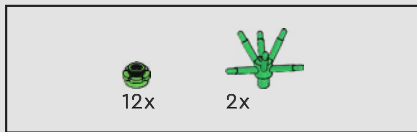
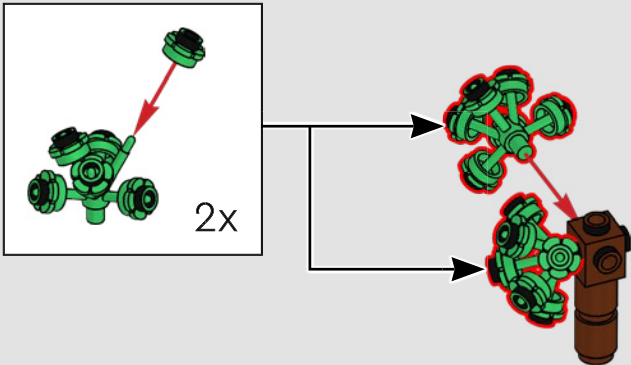

83

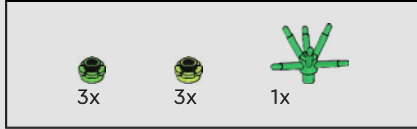
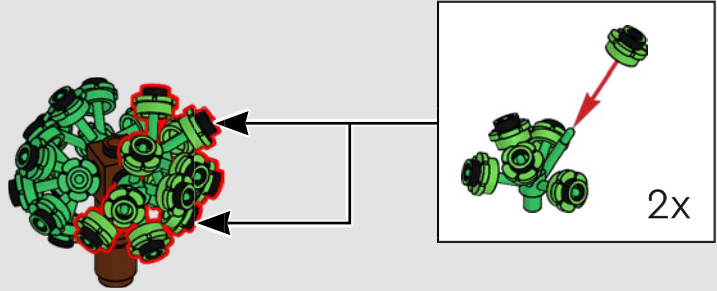

84

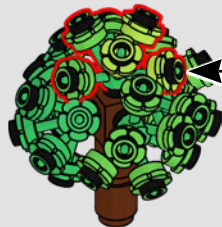
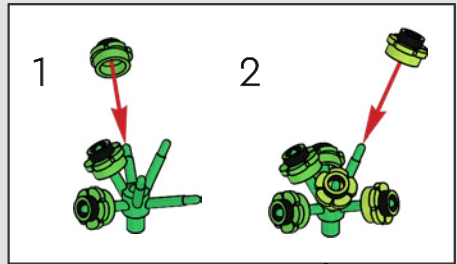



85

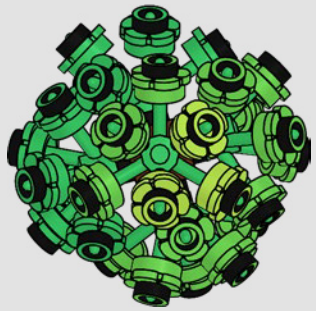

8x

86

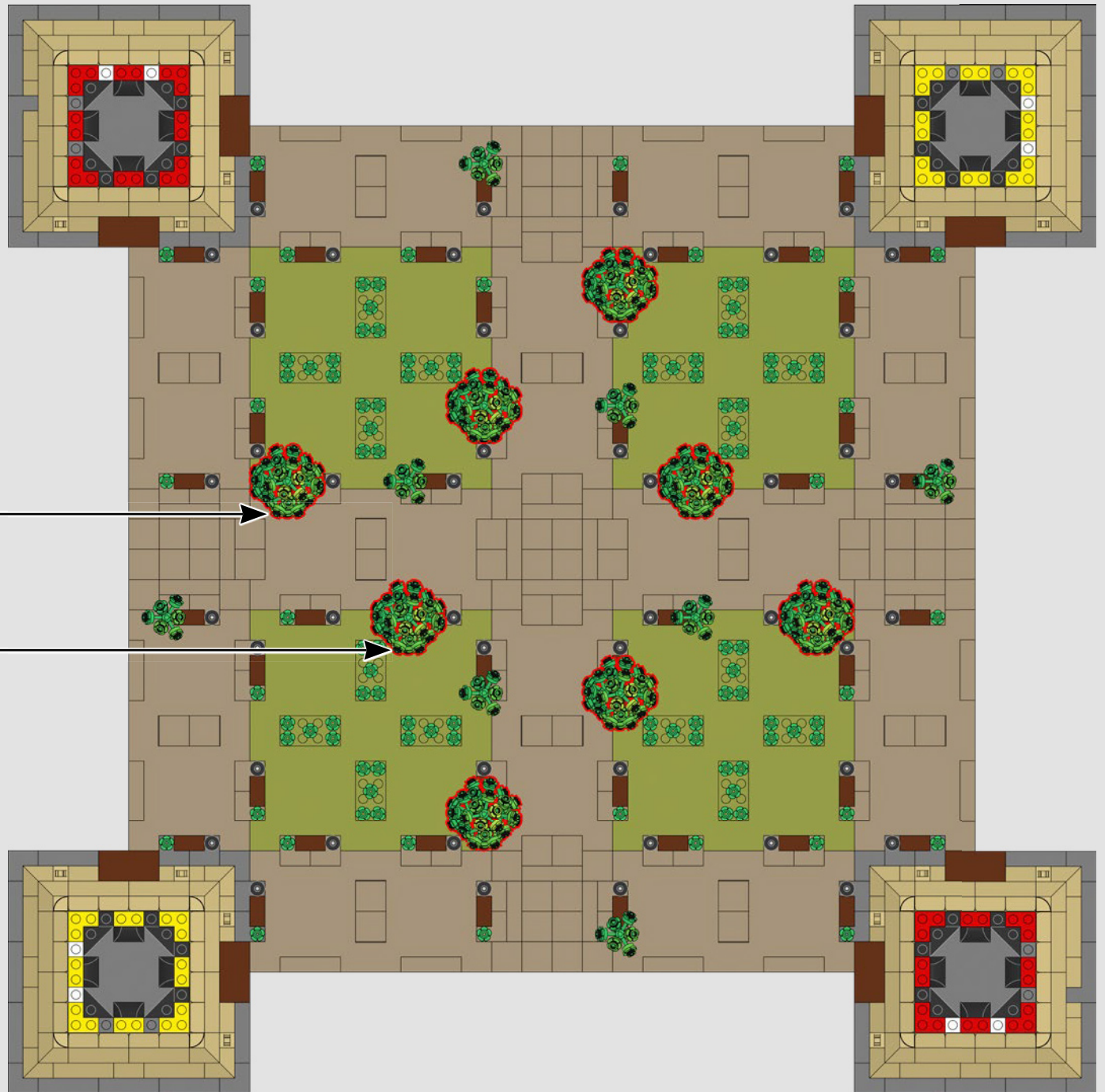



The base of the LEGO® model alludes to the tower's opening in the 19th century, with open, landscaped paths, enlivened with greenery, typical Parisian streetlights and benches.

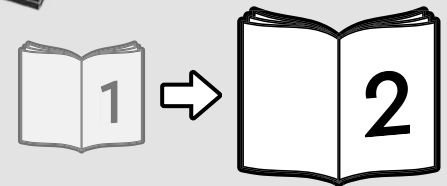



# FEEDBACK AND WIN



## FEEDBACK AND WIN

Your feedback will help shape the future development of this product series.

Please visit:

## FEEDBACK UND GEWINNEN

Dein Feedback trägt zur Weiterentwicklung dieser Produktreihe bei.

Geh auf:

## COMMENTEZ ET GAGNEZ

Vos commentaires nous aideront à concevoir les futurs produits de cette gamme.

Rendez-vous sur :

## COMENTA Y GANA

Tu opinión nos ayudará a dar forma al desarrollo de esta serie de productos en el futuro.

Visita:

## 反馈有奖

您的反馈将有助于我们在今后改进本系列产品。

请访问：

[LEGO.com/productfeedback](https://www.lego.com/productfeedback)

By completing, you will automatically enter a drawing to win a LEGO® set.

Terms & Conditions apply.

Durch Ausfüllen nimmst du automatisch an der Verlosung eines LEGO® Preises teil.

Es gelten die Teilnahmebedingungen.

En envoyant vos commentaires, vous serez automatiquement inscrit(e) à un tirage au sort qui vous permettra de remporter un prix LEGO®.

Offre soumise à conditions.

Al contestar, participarás automáticamente en el sorteo y podrás ganar un set LEGO®.

Sujeto a Términos y Condiciones.

完成我们的反馈调查，即可自动进入抽奖环节，赢取乐高®套装。

适用《条款和条件》。

