



CLASSIC

11018





Page
8



Page
14



Page
26





Page
40



Page
58



Page
30

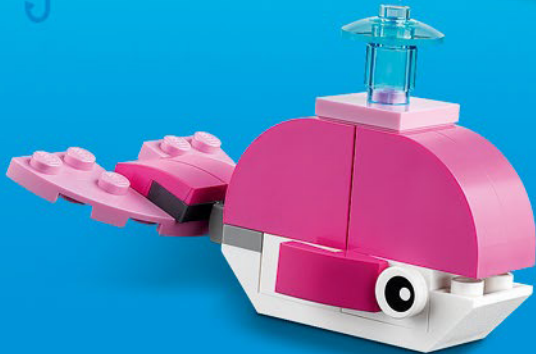

Page
48



Check for compatibility
Kompatibilität prüfen
Vérifier la compatibilité
Controlla la compatibilità
Comprueba tu compatibilidad
Verificar a compatibilidade
Ellenőrizd a kompatibilitást
Pārbaudīt saderību
检查兼容性

LEGO.com/devicecheck





LEGO® Building Instructions



Download on the
App Store



GET IT ON
Google Play



腾讯应用宝
安卓应用商店

Apple and the Apple logo are trademarks of Apple Inc.
Google Play and the Google Play logo are trademarks of Google LLC.
Tencent and the Tencent logo are trademarks of Tencent Inc.

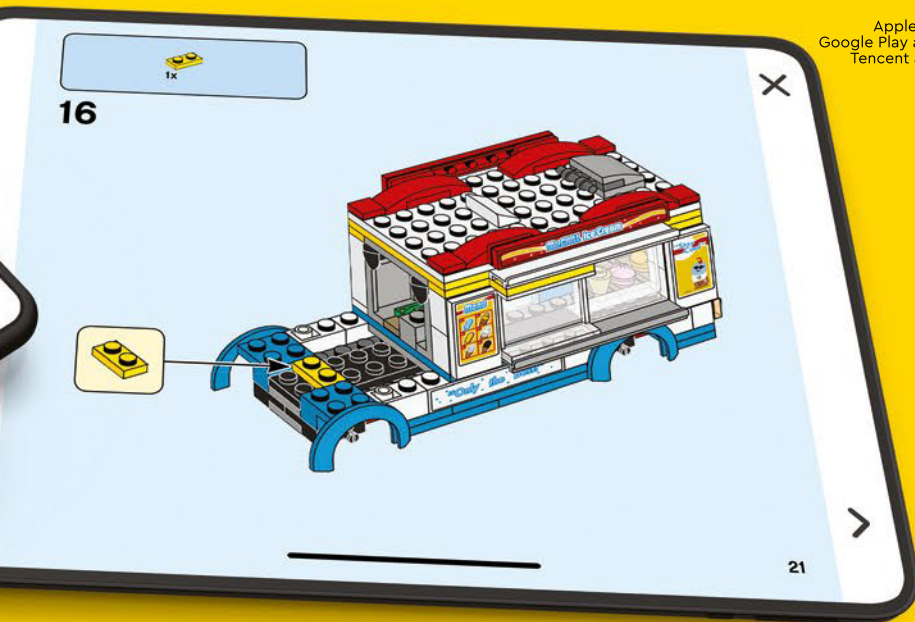



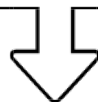
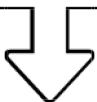
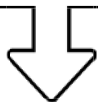

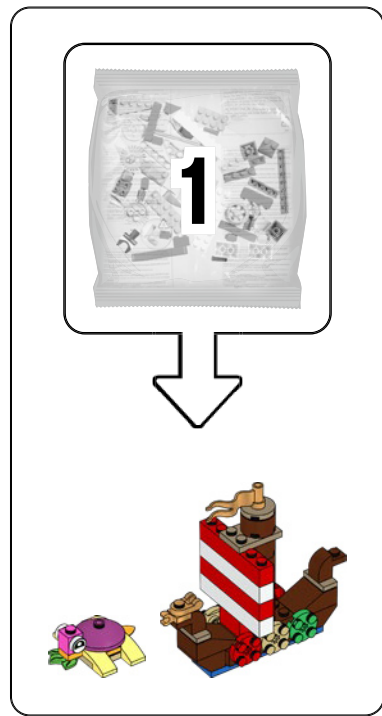

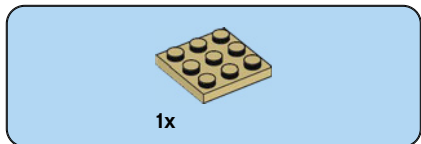

1

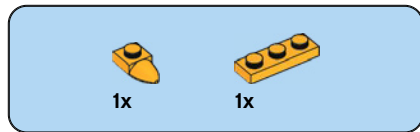
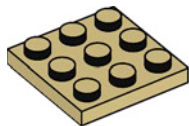

2

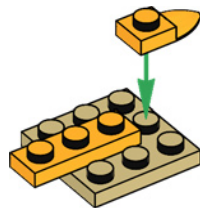



2x

3

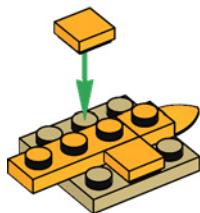



4

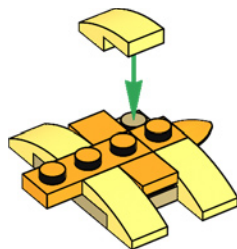

5

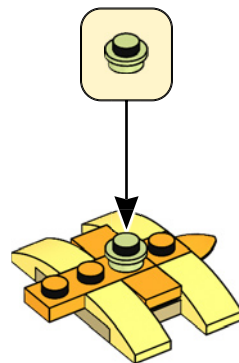

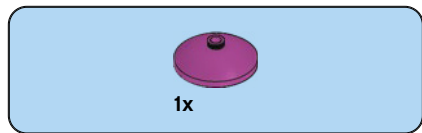

6

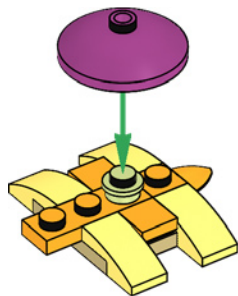



1x

7

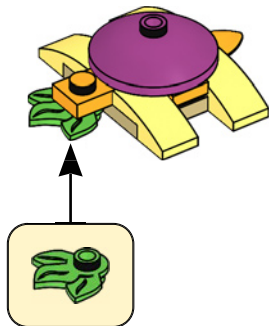

2x



1x

8

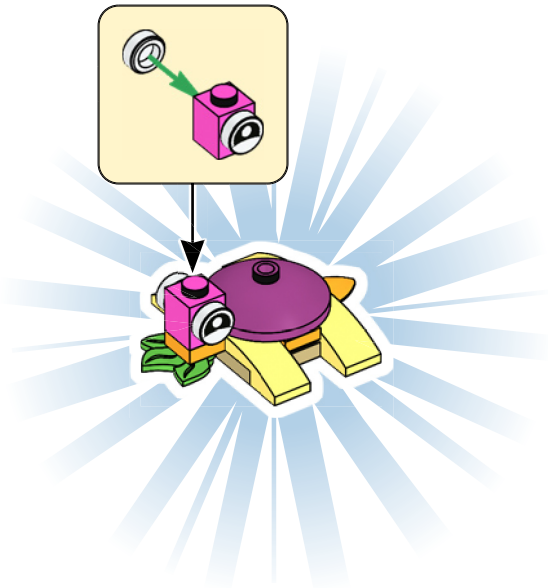

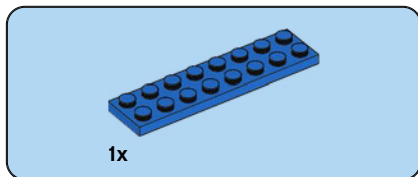

1

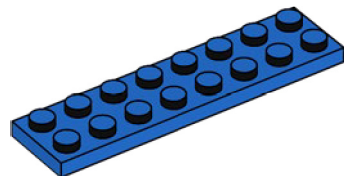

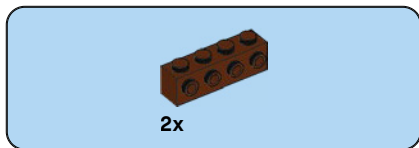

2

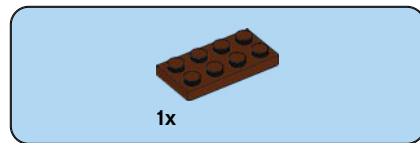
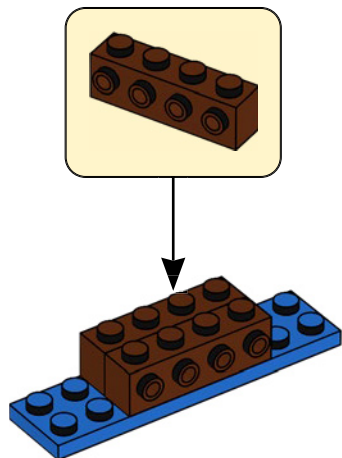

3

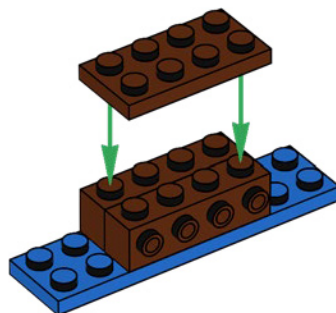



2x

4

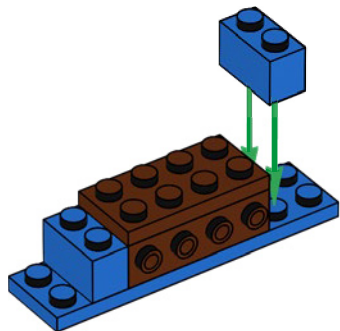

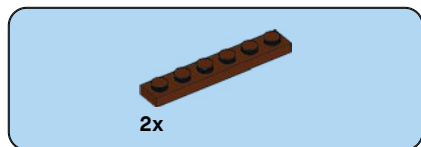

5

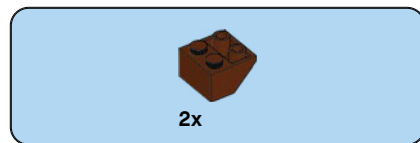
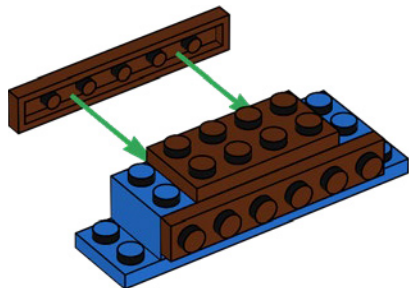

6

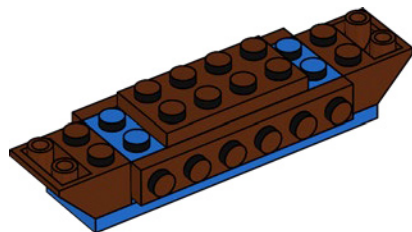

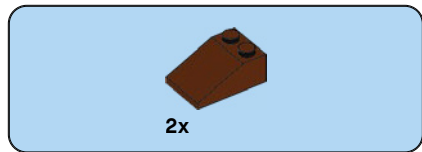

7

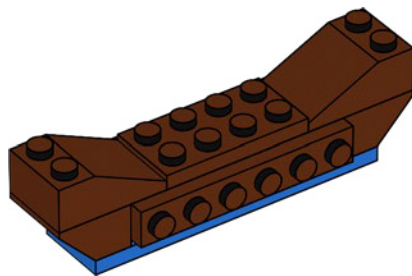



2x

8

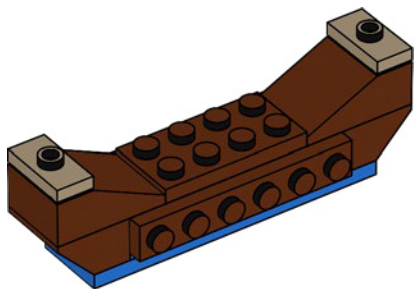

1x



1x



1x

9

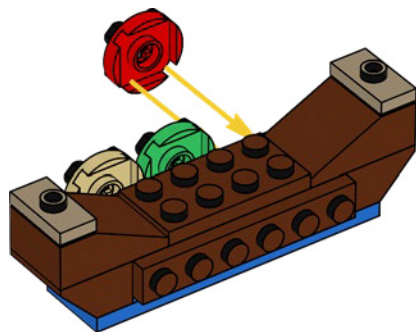



1x



1x



1x

10

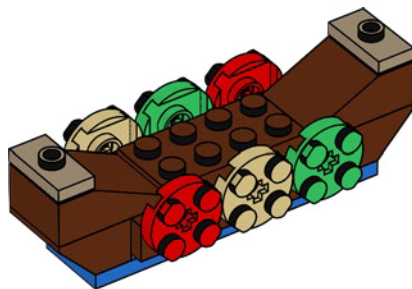

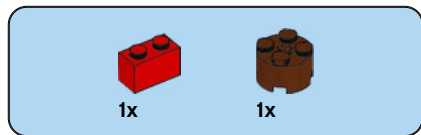

11

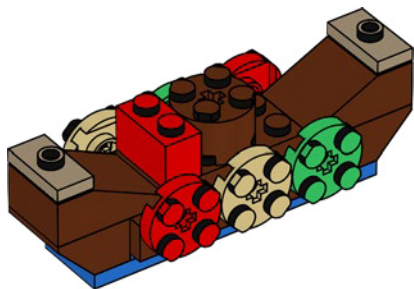

12

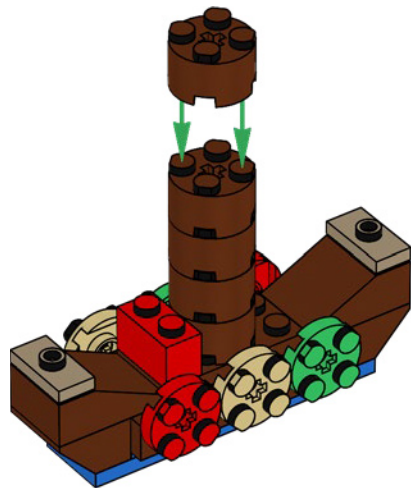

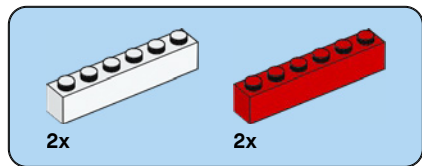

13

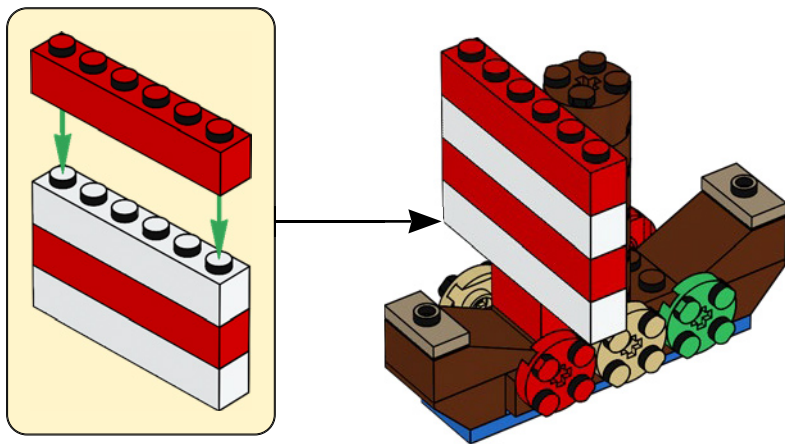

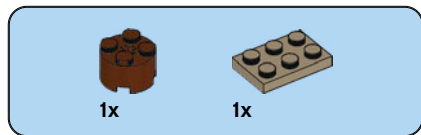

14

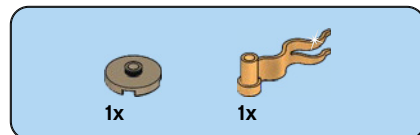
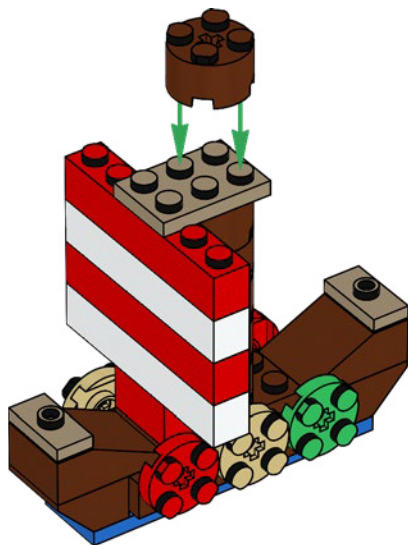

15

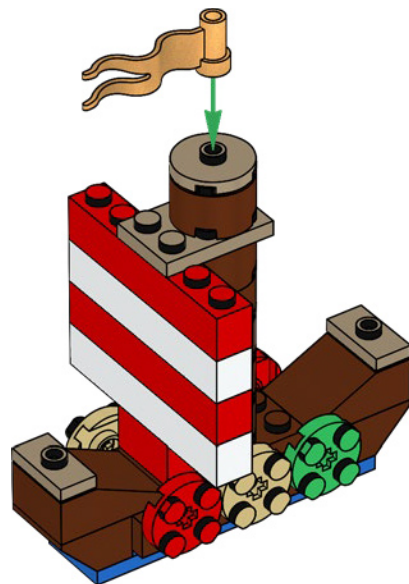



1x



1x

17

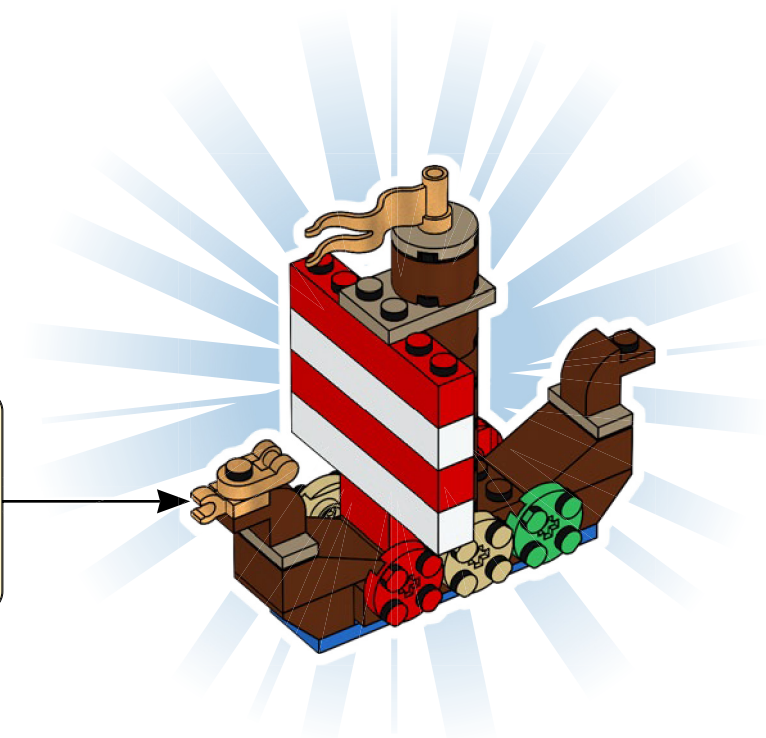
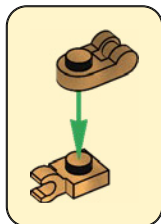

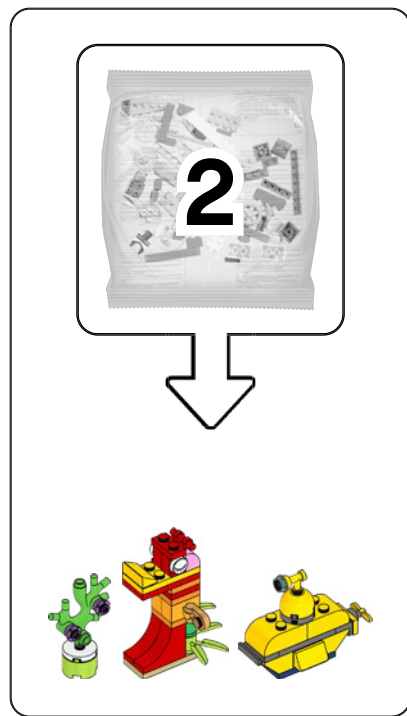

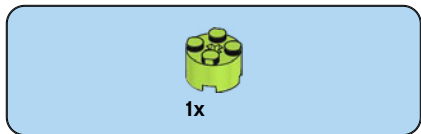

1

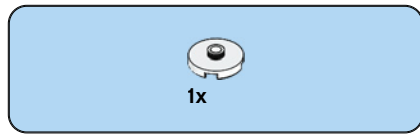

2



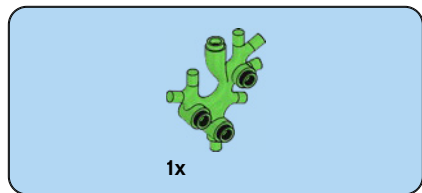

3

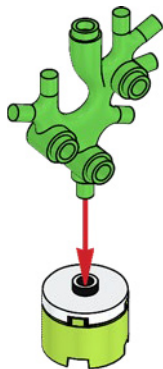



2x

4



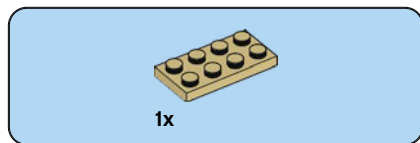

1x

1

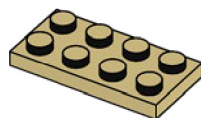

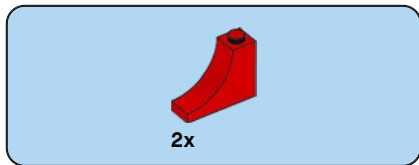

2

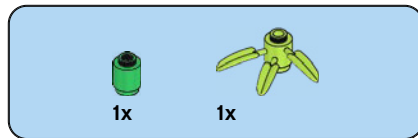
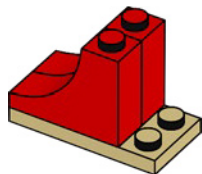

3

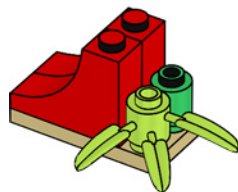

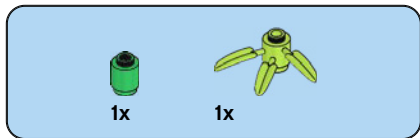

4

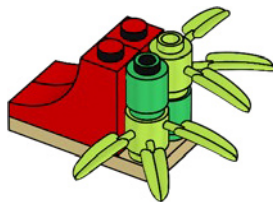



1x

5

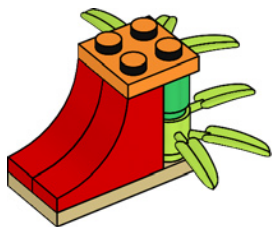

2x

6

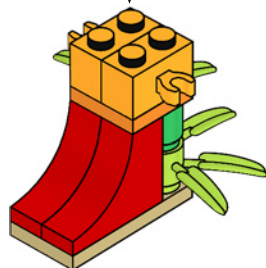
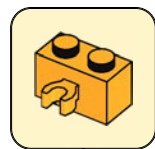



1x

7

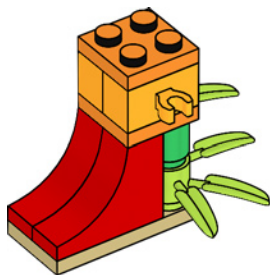



2x

8

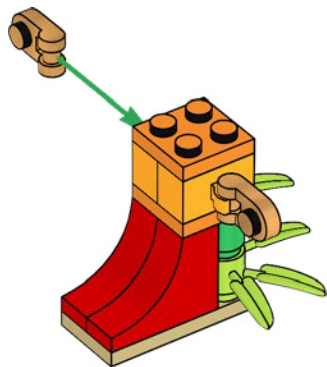

1x



1x

9

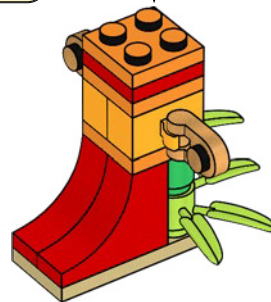
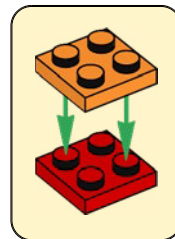



1x



1x

10

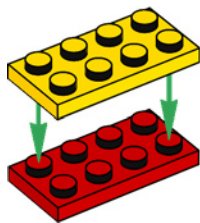

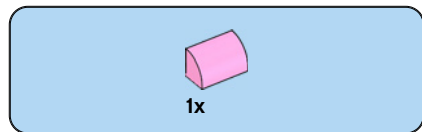

11

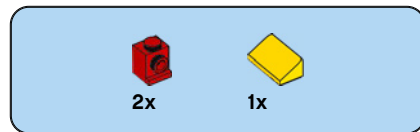
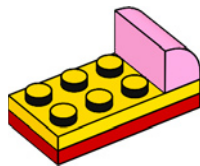

12

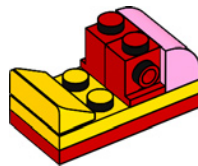



1x

13

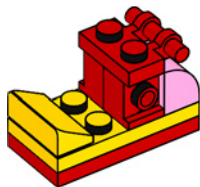



2x

14

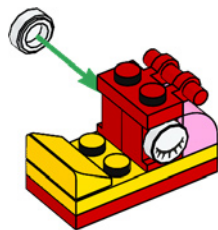

15

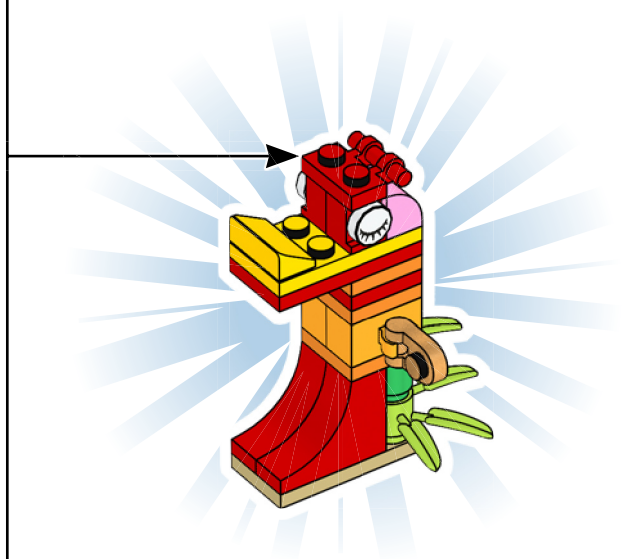

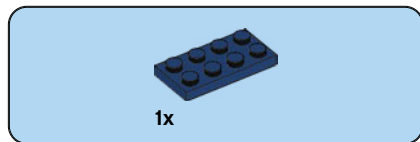

1

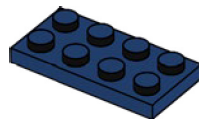

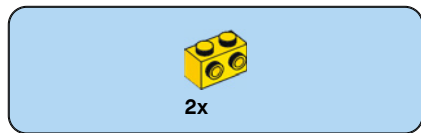

2

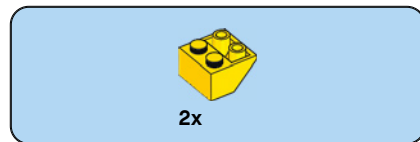
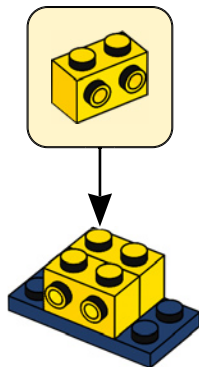

3

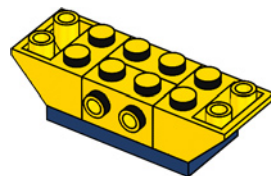



1x

4

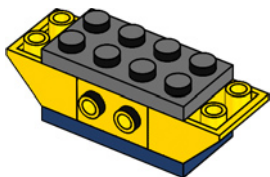

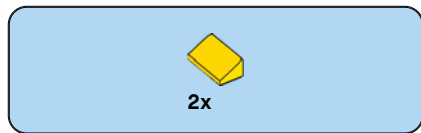

5

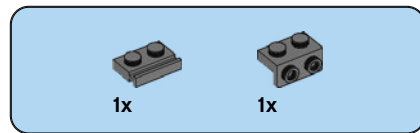
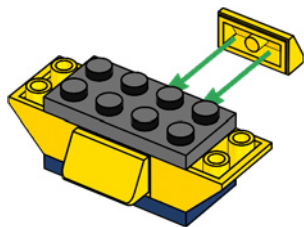

6

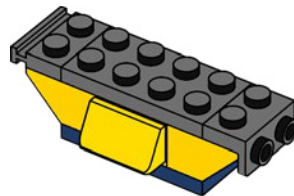



2x

7

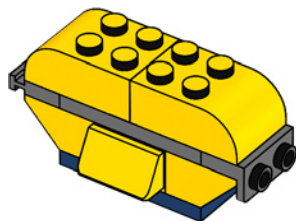



1x

8

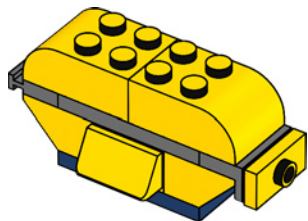

1x



1x

9

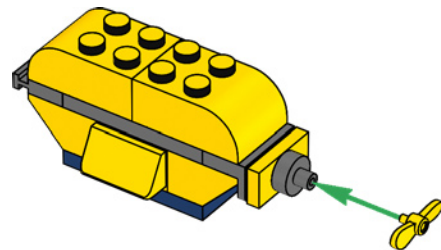



1x



1x

10

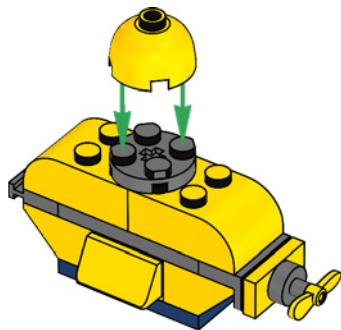



1x



1x

11

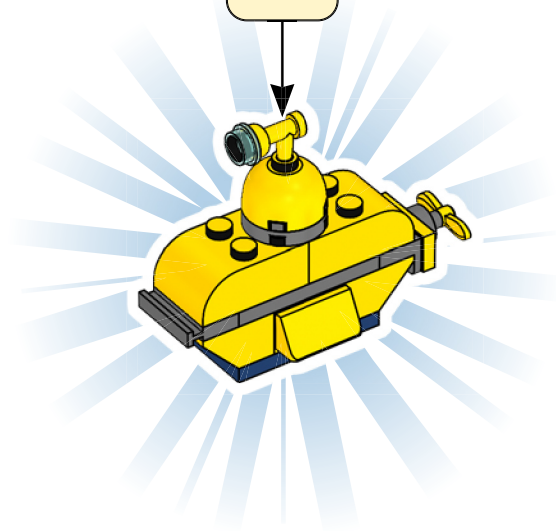
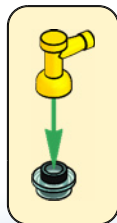

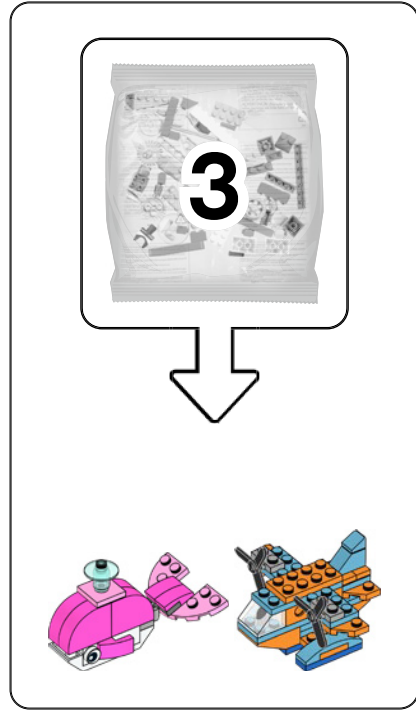

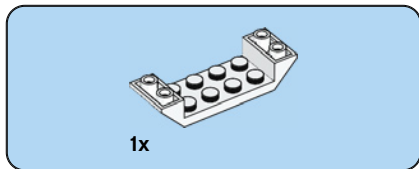

1

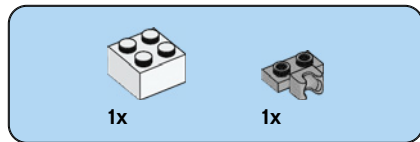
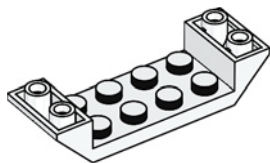

2

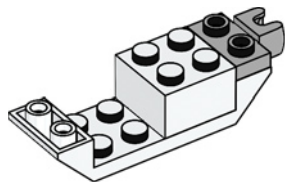



2x

3

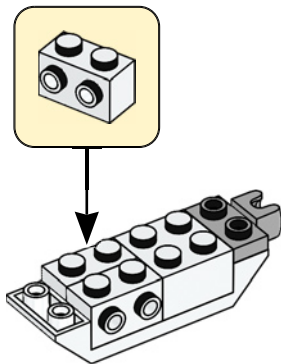

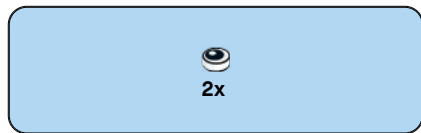

4

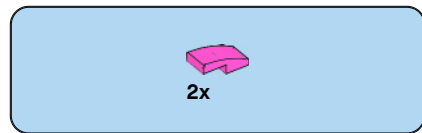
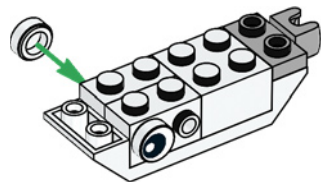

5

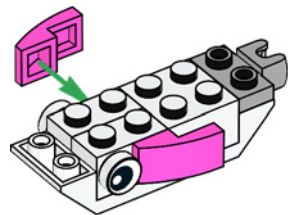

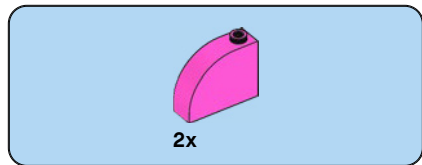

6

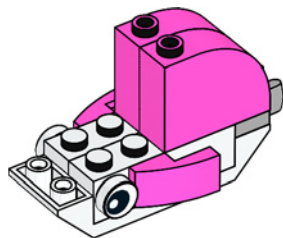

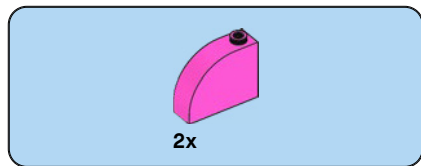

7

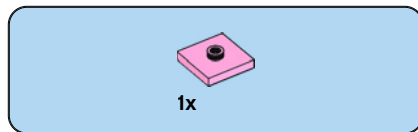
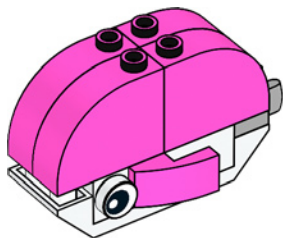

8

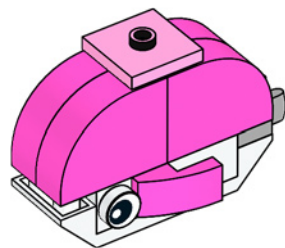

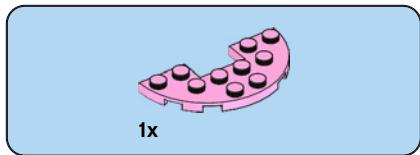

9

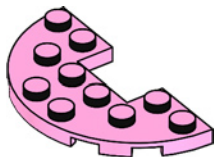



1x

10

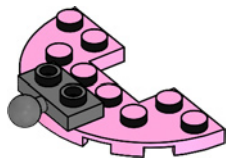

2x

11

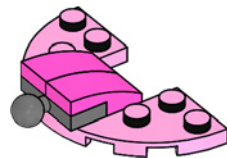

12

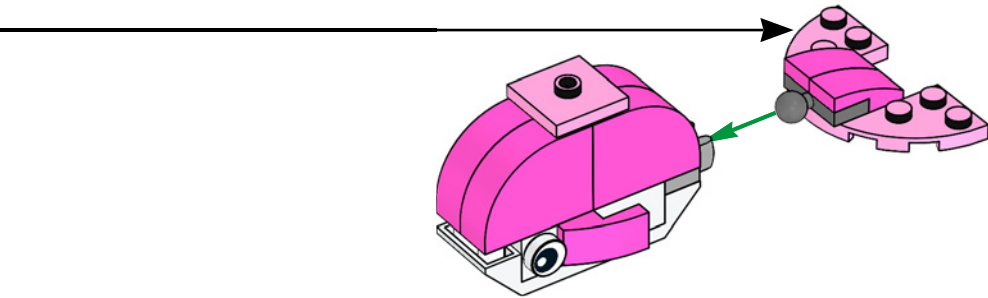



1x



1x

13

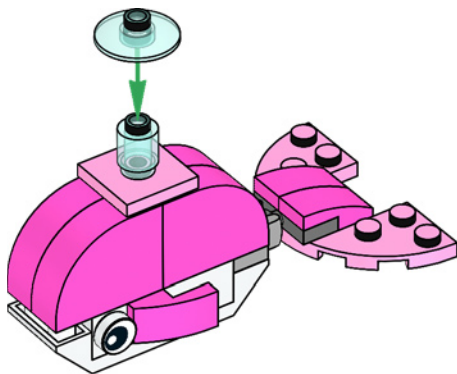

14

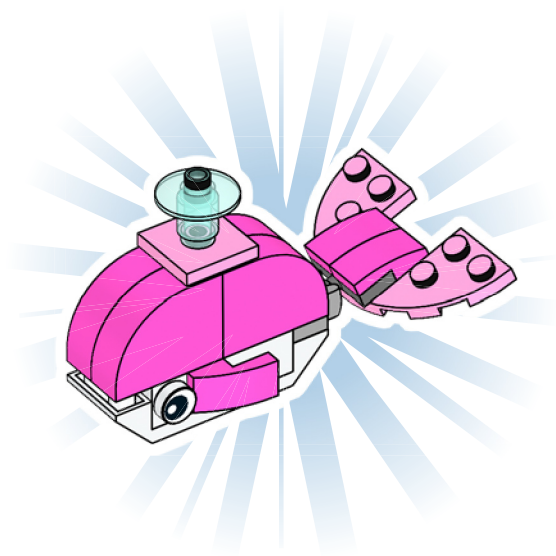

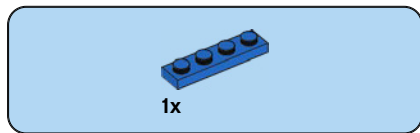

1

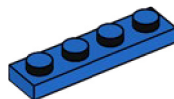

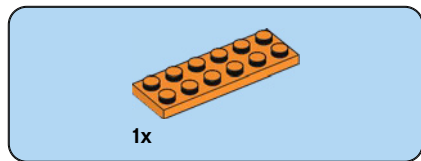

2

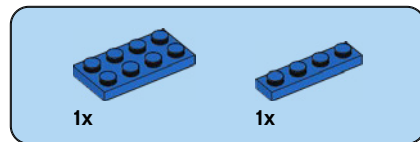
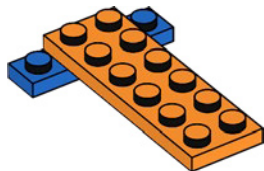

3

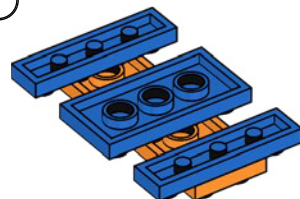

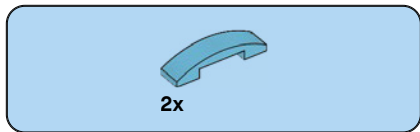

4

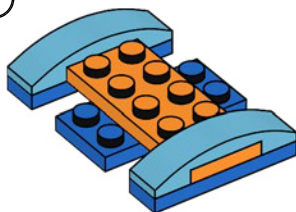

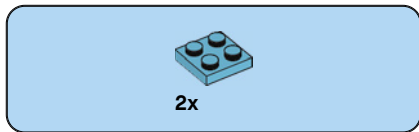

5

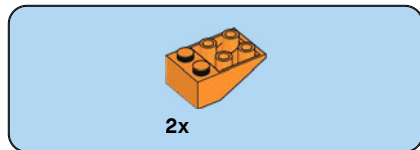
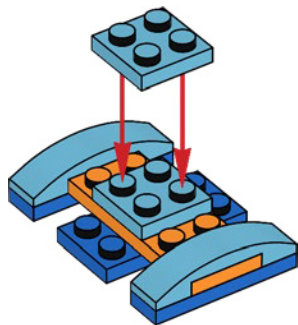

6

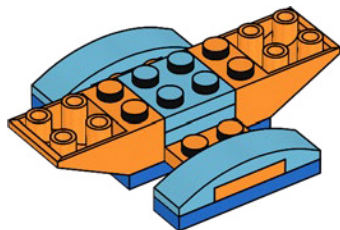

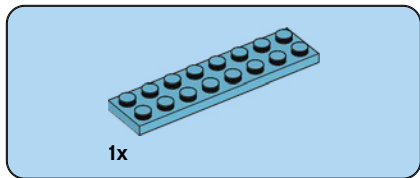

7

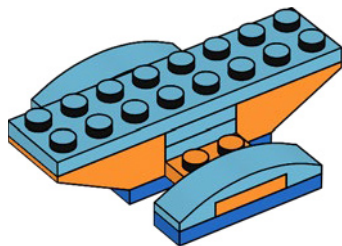



1x

8

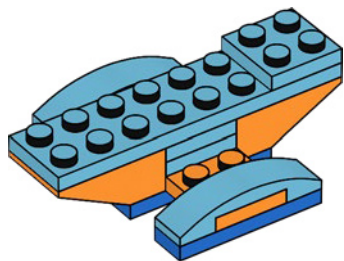

2x

9

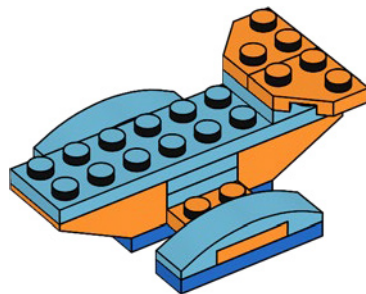



1x

10

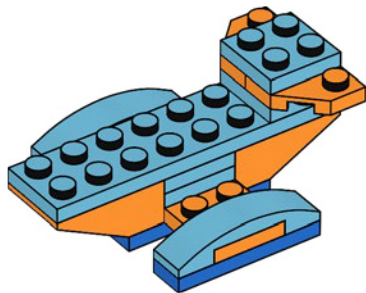



2x

11

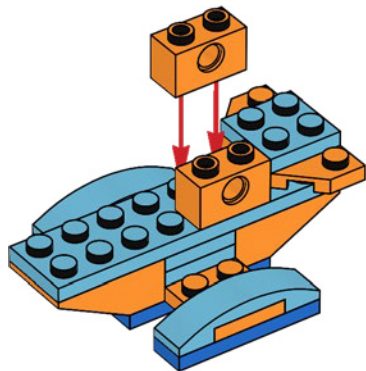

2x



1x

12

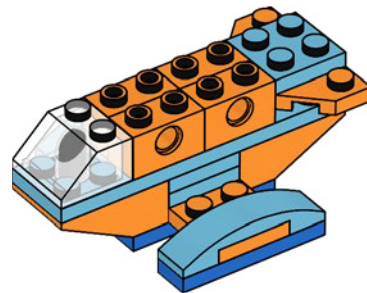



2x



1x

13

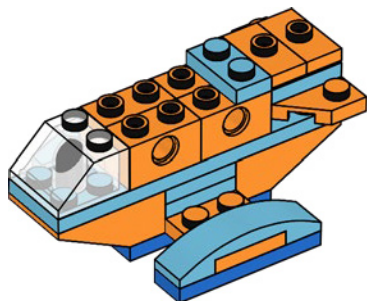

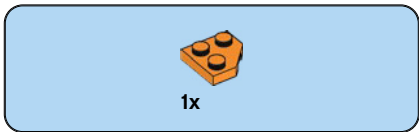
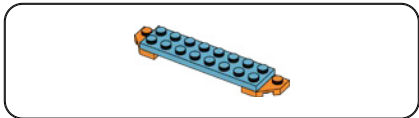

14

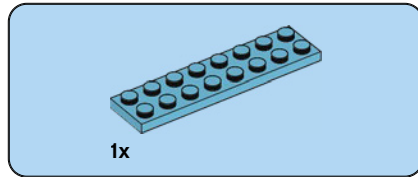

15

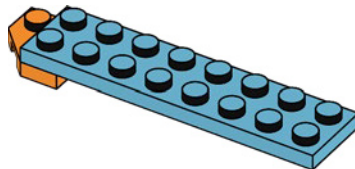



1x

16

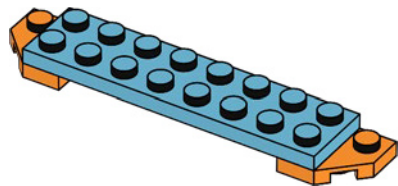

17

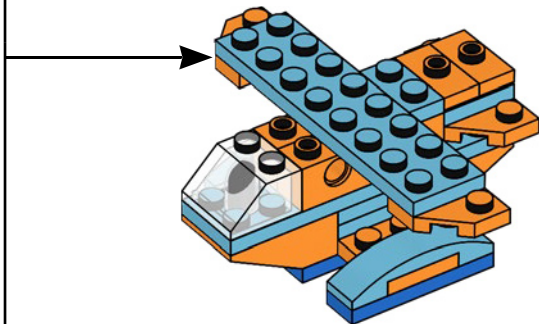



1x

18

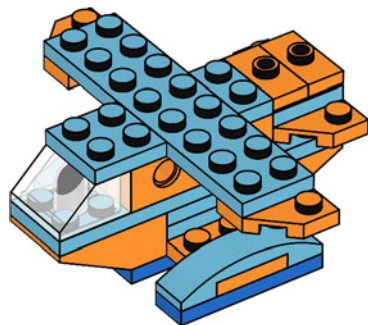

1x

19

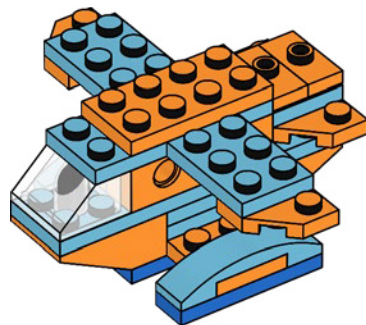



1x



1x

20

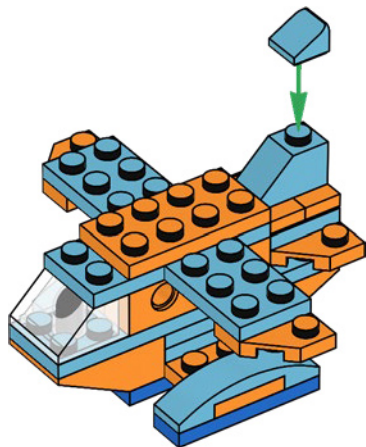

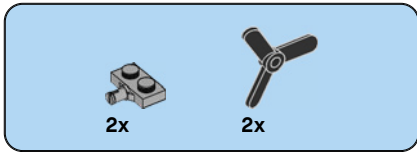

21

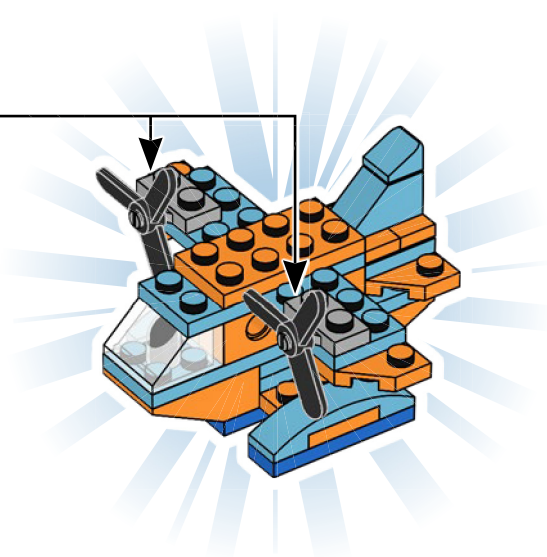
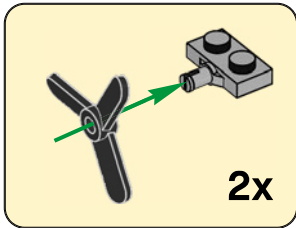



CLASSIC



What fun things can you build?
Welche lustigen Sachen kannst du bauen?
Quels objets amusants peux-tu construire ?
Quali cose divertenti sai costruire?
¿Qué cosas divertidas puedes construir?
Que coisas divertidas consegues construir?
Milyen mókás dolgokat tudsz megépíteni?
Kādas interesantas lietas tu uzbūvēsi?
你能拼搭出什么有趣的模型呢?





CLASSIC



11017



11015



11018





3x
300301



2x
300901



2x
6058177



2x
614301



2x
6131572



2x
6174937



2x
6284604



4x
6284599



4x
6329607



1x
6093053



4x
6194809



2x
4224792



2x
4112982



1x
4213568



3x
6115031



1x
4114309

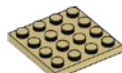

1x
4243824



4x
4140562



3x
300421



2x
300121



2x
300921



2x
407021



2x
4251818



2x
6029946



2x
6294331



2x
6092565



1x
302221



3x
302021



3x
4140585



2x
403221



2x
6173961



1x
6268946



2x
300423



2x
300123



2x
6189191



2x
6126049



4x
371023



3x
302023



1x
303423



2x
300424



2x
6336971



2x
6119197



1x
4216656



5x
4550348



4x
366024



2x
621524



1x
6092583



2x
302124



1x
302024



2x
6185994



2x
403224



1x
4256320



2x
6286830



1x
6265497



4x
6147726



2x
300328



2x
4187334



2x
6129807



2x
306228



2x
621528



2x
4107758

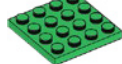

1x
4243821



2x
403228

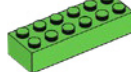

2x
6102903



2x
6357612



1x
6182261



1x
6336855



2x
6175572



1x
4527943



2x
4504372



4x
6136553



4x
4121737



2x
6092599



3x
4159007



1x
4158355



1x
4121741



4x
6218367



2x
4153825



2x
6335311



4x
6065504



1x
6073042



1x
4282860



2x
6186656



1x
6217587



2x
6101254



2x
6092591



3x
6035540



1x
6132767



1x
4667595



2x
6153594



8x
4211166



4x
4211221



4x
4216625



4x
6335567



2x
4216695



3x
4211186



4x
4221590



2x
4211159



1x
4214559



2x
6138173



2x
370026



2x
6047276



2x
287726



2x
6308000



2x
6174243



4x
4578677



2x
6371406



2x
6170693



2x
4211387



2x
4211393



2x
4211440



2x
4211406



3x
6338165



2x
6395349



2x
4211060



1x
4211065



3x
6271752



3x
6338160



3x
6214341



3x
4543086



3x
4211042



4x
6225620



1x
6334462



4x
6132918

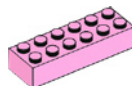

2x
6228963



1x
6314374



2x
6264994



1x
6251842



2x
6096589



1x
6133060



3x
6245307



1x
6238677



1x
6283590



2x
6253666



2x
6251908



2x
6244796



3x
6244886



2x
6240030



2x
6254306



1x
4619520



3x
4619655



2x
6097093



3x
6097419



5x
4625032



2x
6209684



3x
6057898



1x
6268949



1x
6284379



3x
6212377



Customer Service

Kundenservice

Service Consommateurs

Servicio Al Consumidor

LEGO.com/service or dial



: 00800 5346 5555

: 1-800-422-5346

WIN

GO TO WWW.LEGO.COM/PRODUCTFEEDBACK AND
GIVE US YOUR SHORT **FEEDBACK** ABOUT THIS
LEGO® SET FOR A CHANCE TO WIN
A COOL LEGO PRIZE.

Terms & Conditions apply

LEGO.com / productfeedback



GEWINNE

Erzähle uns auf
www.LEGO.com/productfeedback

etwas über die Erfahrungen, die du mit
diesem LEGO® Set gemacht hast, und
sichere dir die Chance auf einen coolen
LEGO Preis!

Es gelten die Teilnahmebedingungen

GAGNE

Rends-toi sur
www.LEGO.com/productfeedback

et donne-nous quelques commentaires
sur ce produit LEGO® pour avoir une
chance de gagner un prix LEGO !

Voir Conditions Générales

GANAN

Visita
www.LEGO.com/productfeedback

y envíanos tu opinión acerca de este
set LEGO®. ¡Participarás en el sorteo de
un premio LEGO!

Términos y Condiciones aplicables

获取奖品

登录
www.LEGO.com/productfeedback

给出关于此乐高®套装的简短反馈，
就有机会获得炫酷乐高奖品

《条款及条件》适用

LEGO and the LEGO logo are trademarks of the LEGO Group. ©2022 The LEGO Group.

6394757