

ZNAR™



3520







1

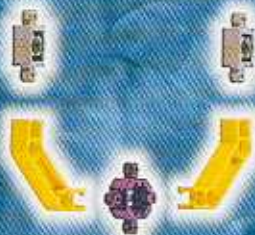

2



1



2









2

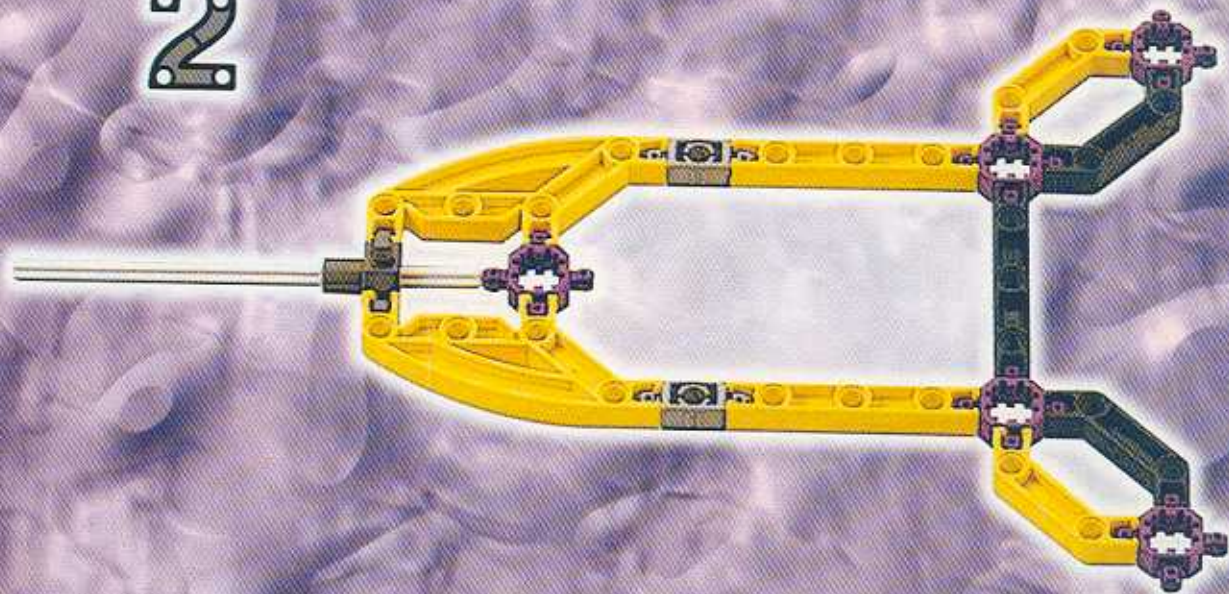





2

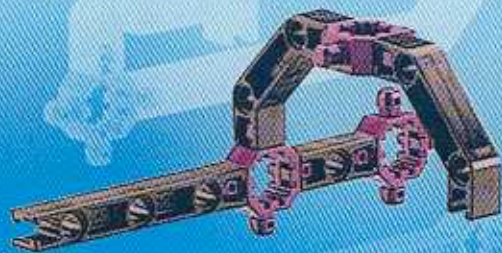

3



4



5



6



7

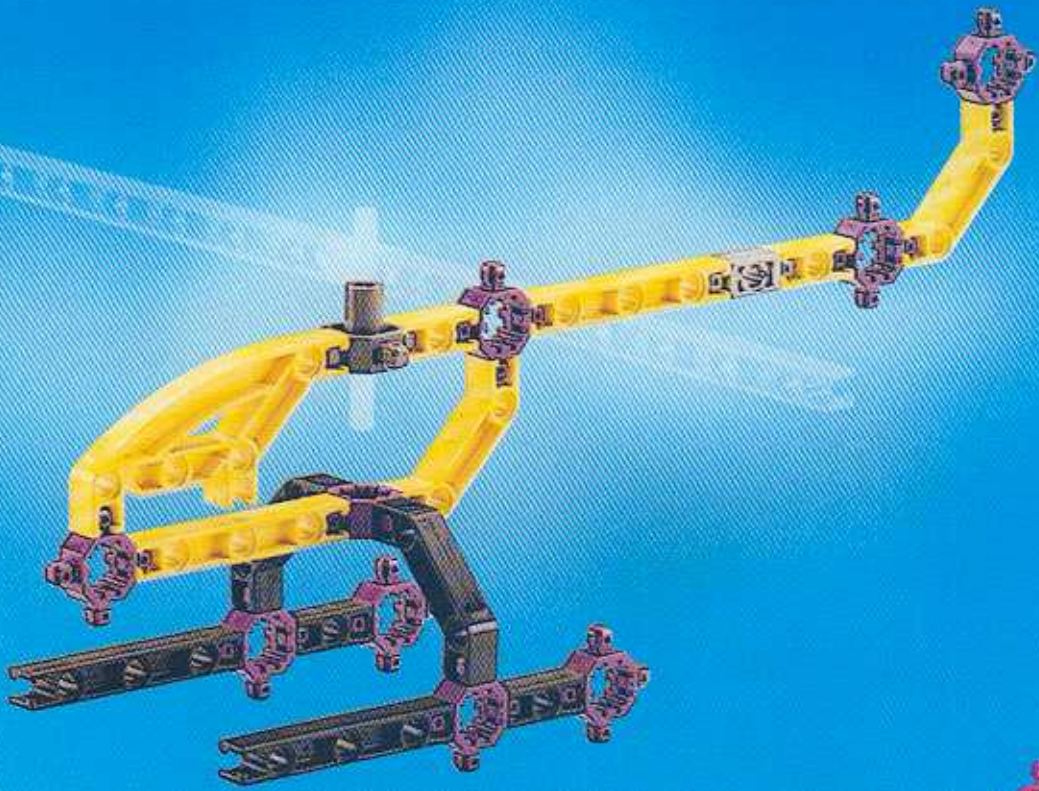



19





1



21

2

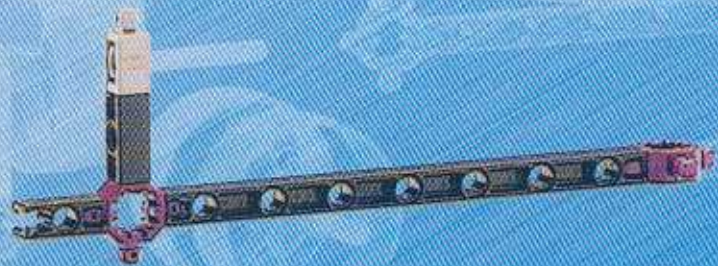

3



4



5



6

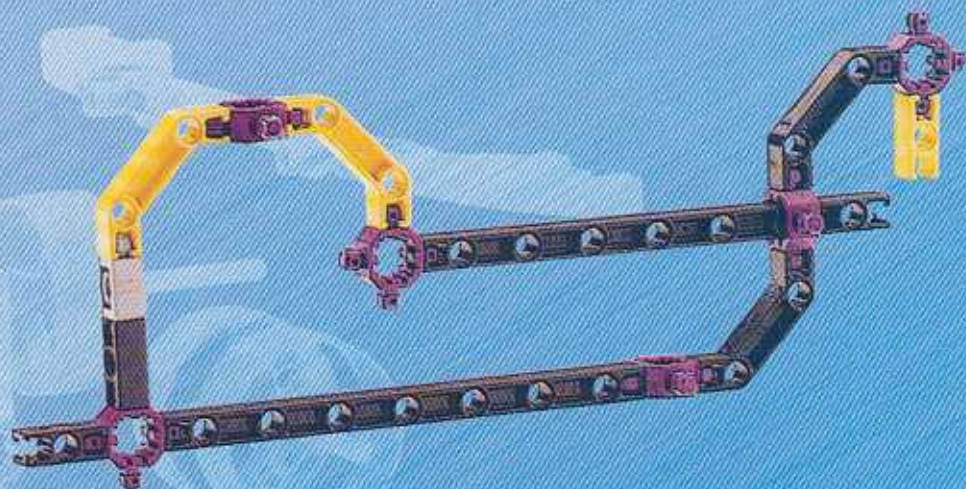

7



8



28

9

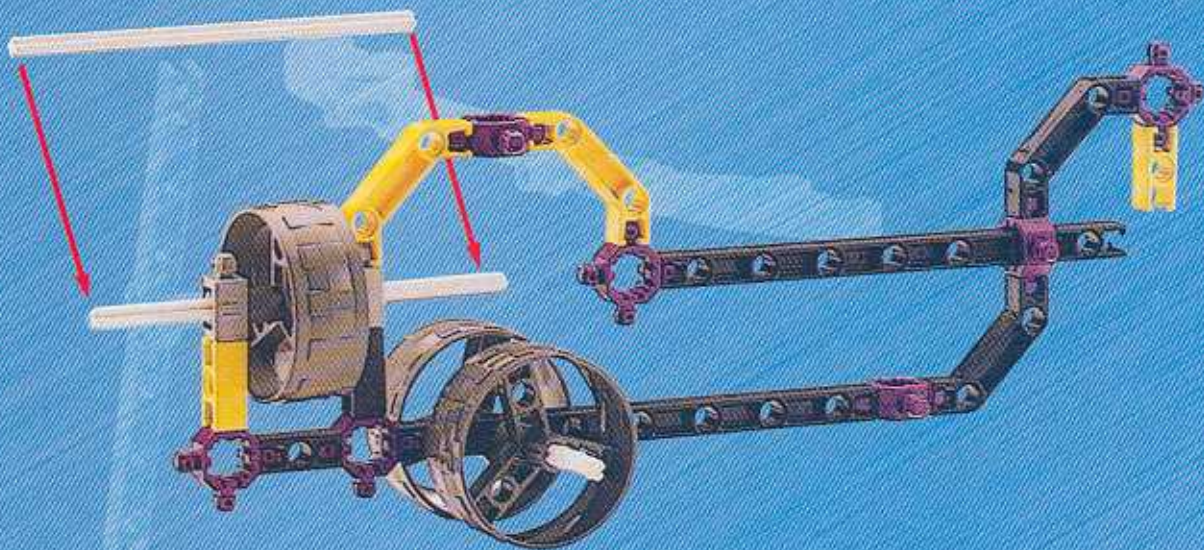

10



11



12

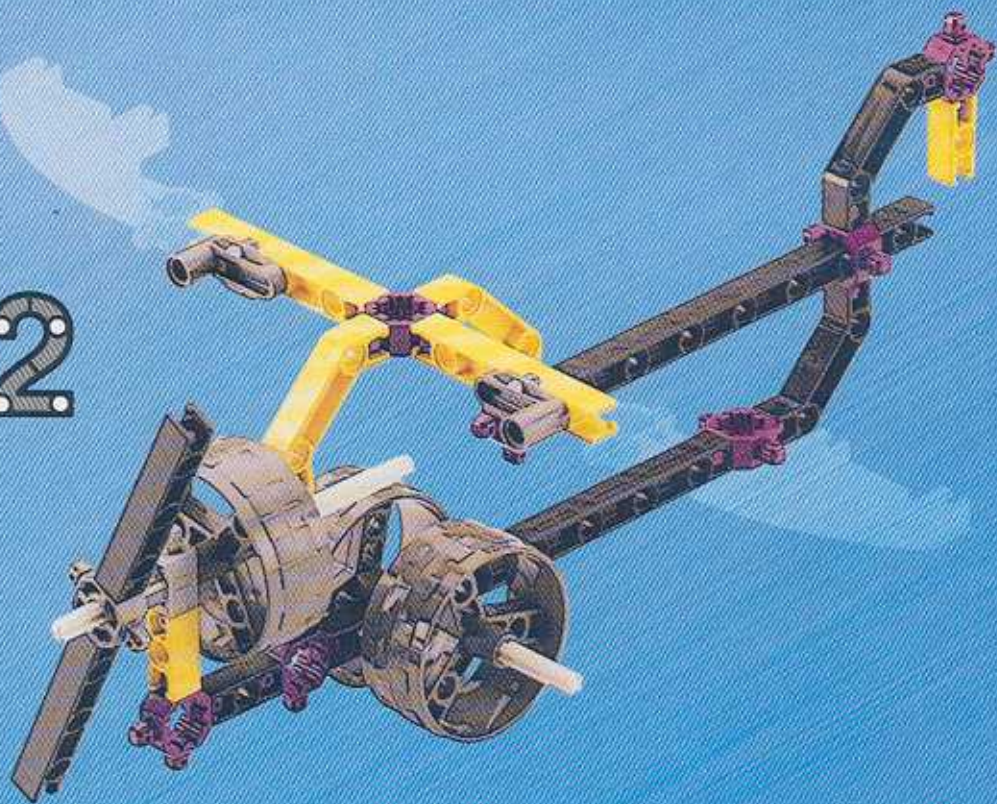

32

13





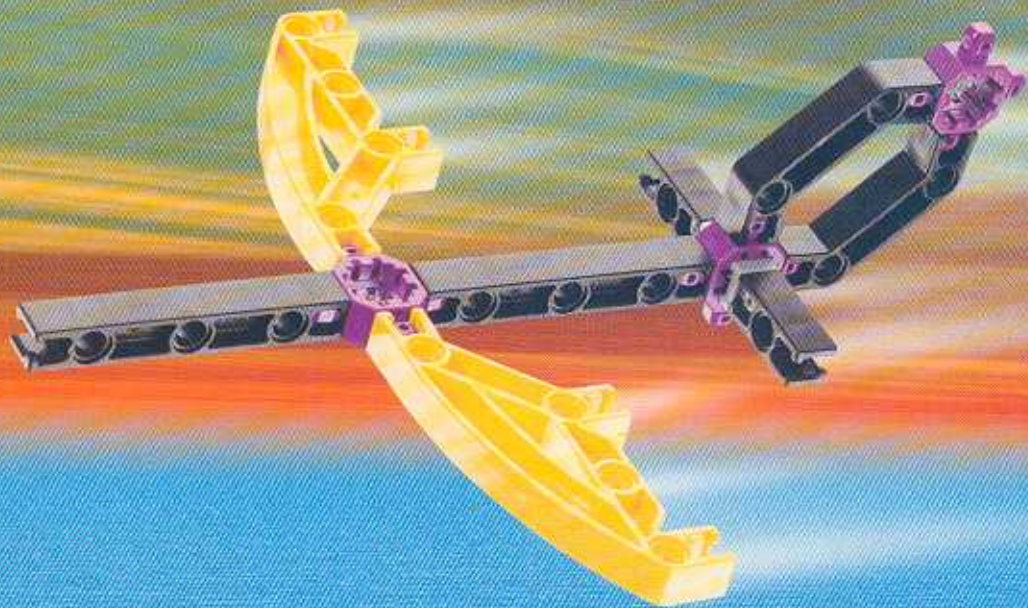

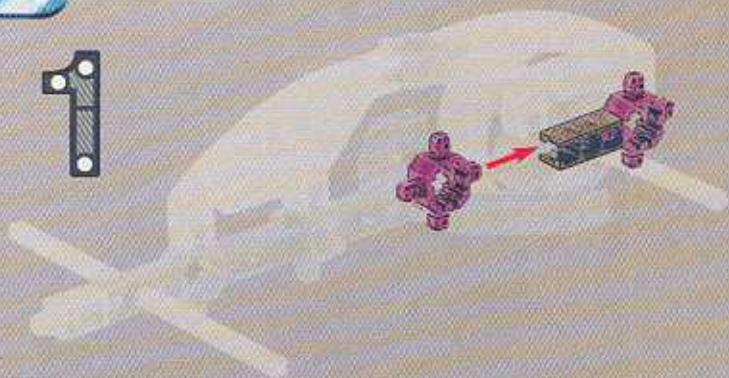
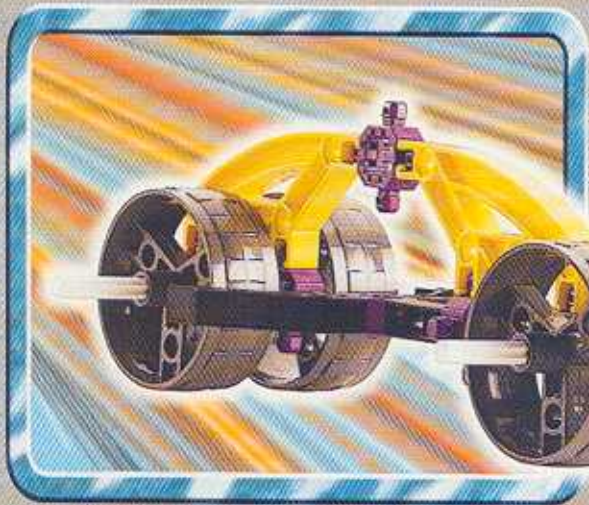

36



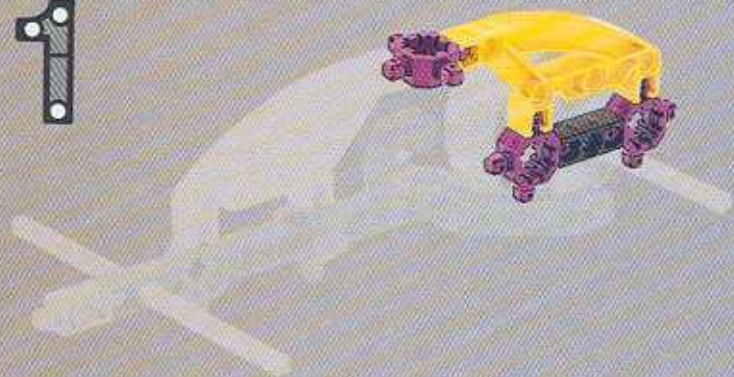

2

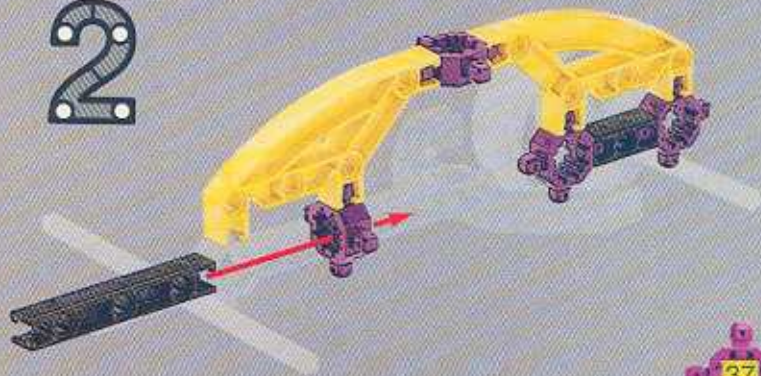

3

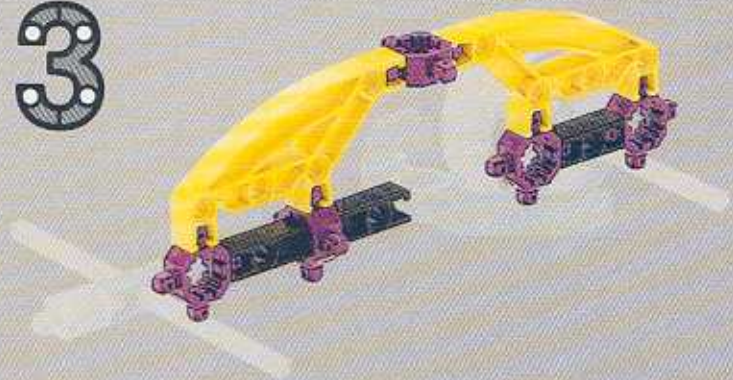

4

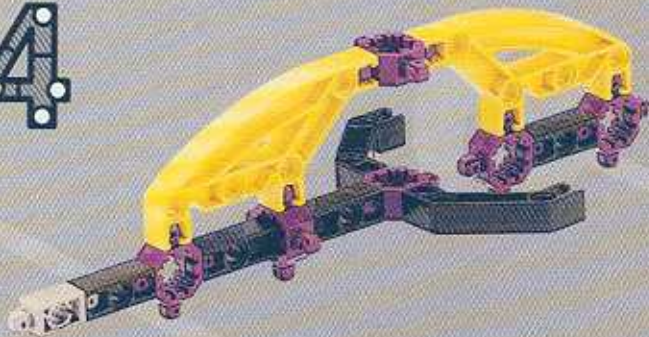

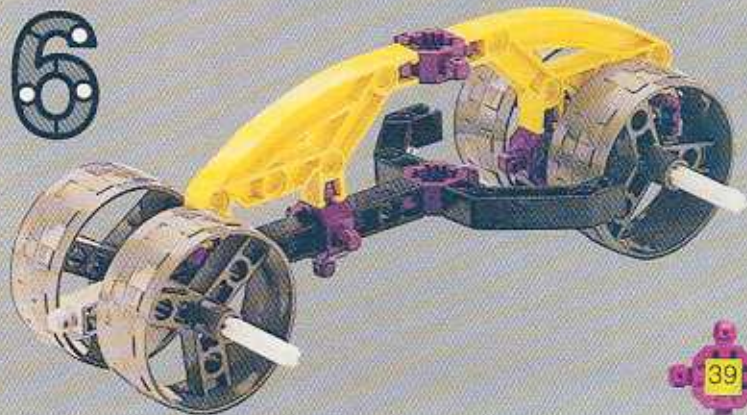
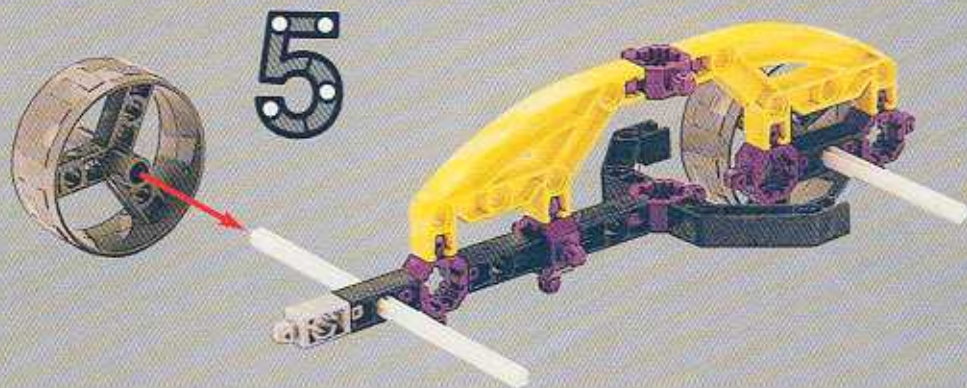

TRANS  FORM

1



2

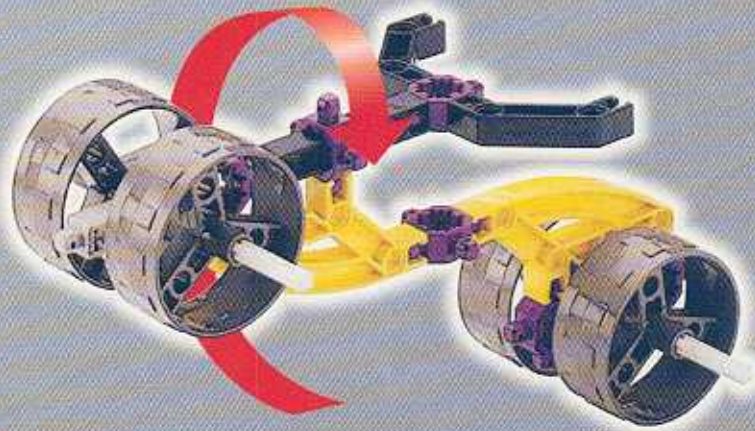

TRANS  FORM

3

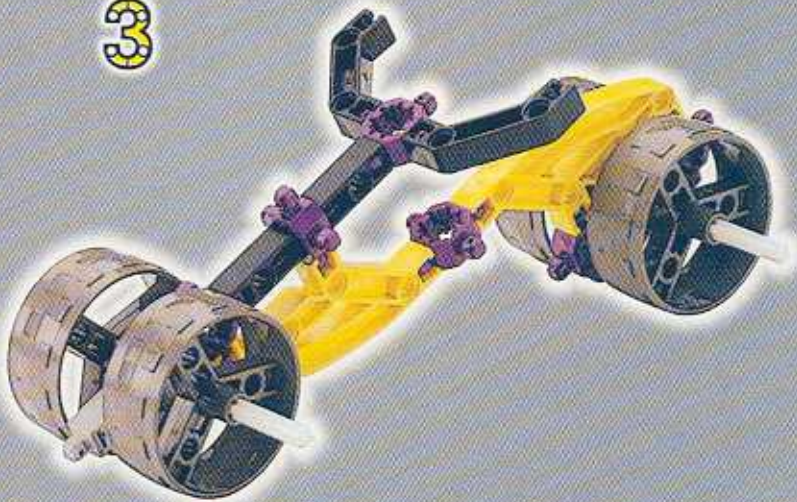



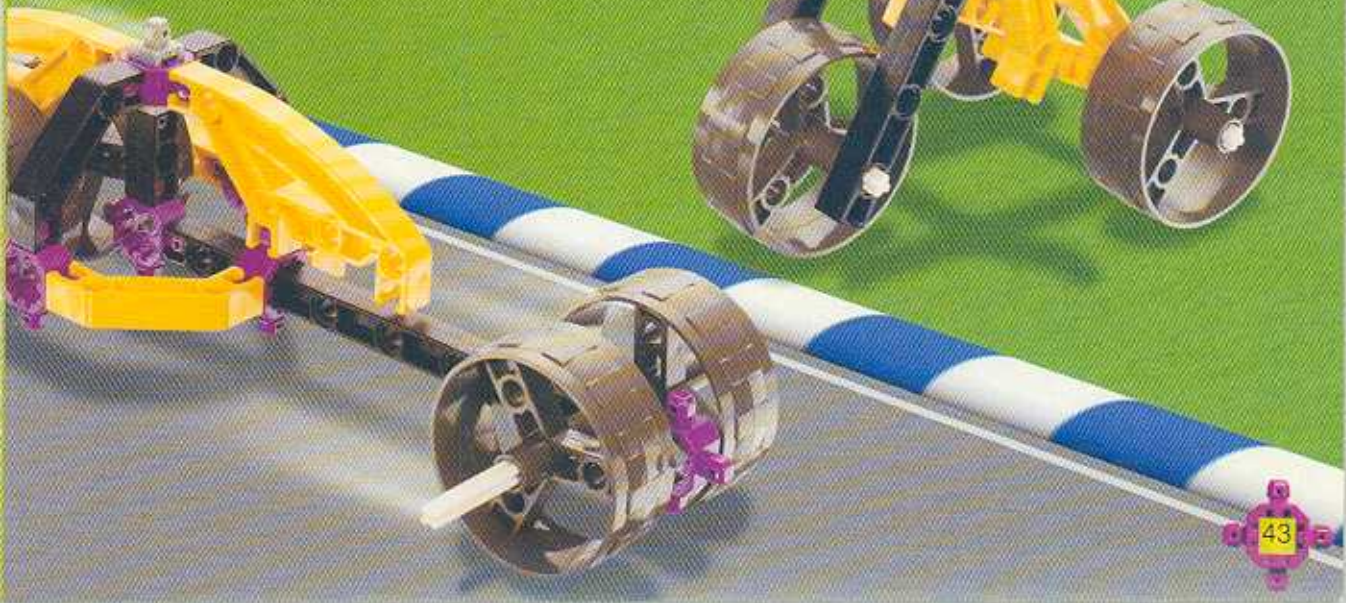



2

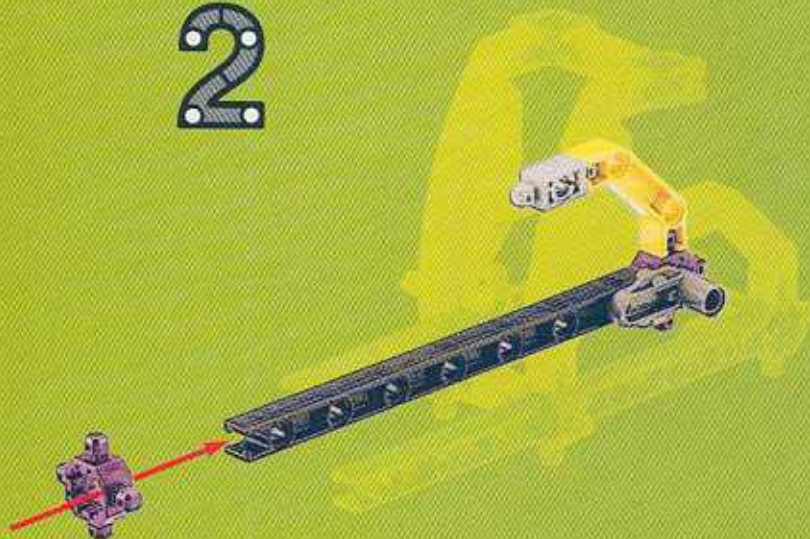



46

4

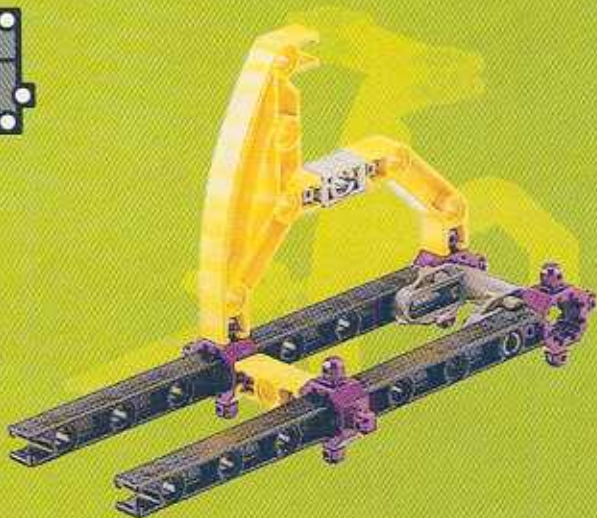

5

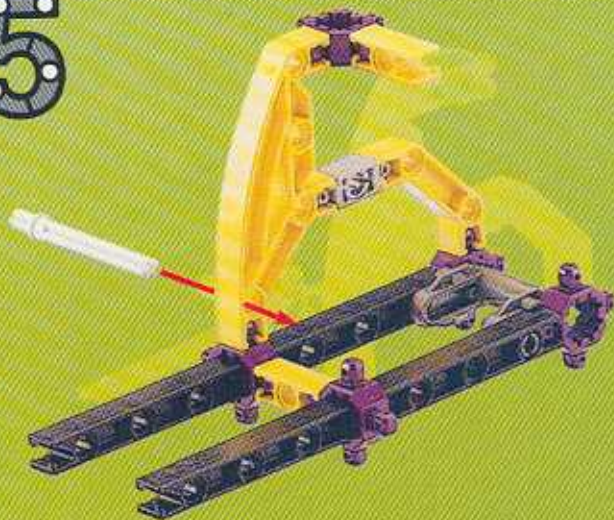

6

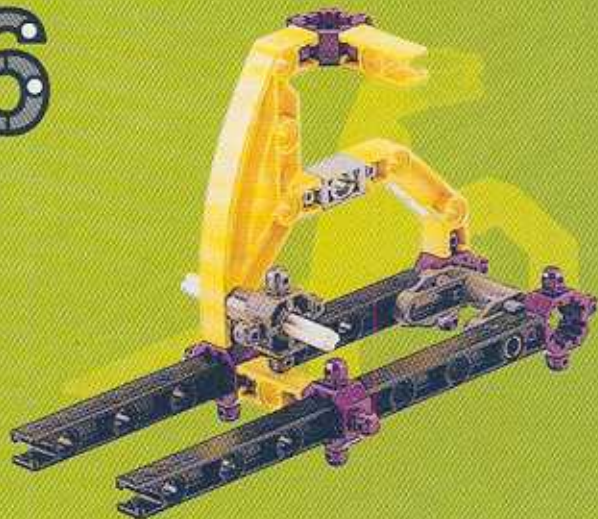

7

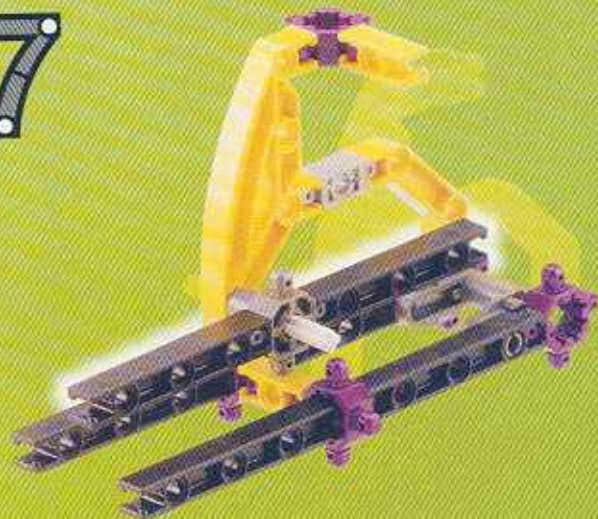

8

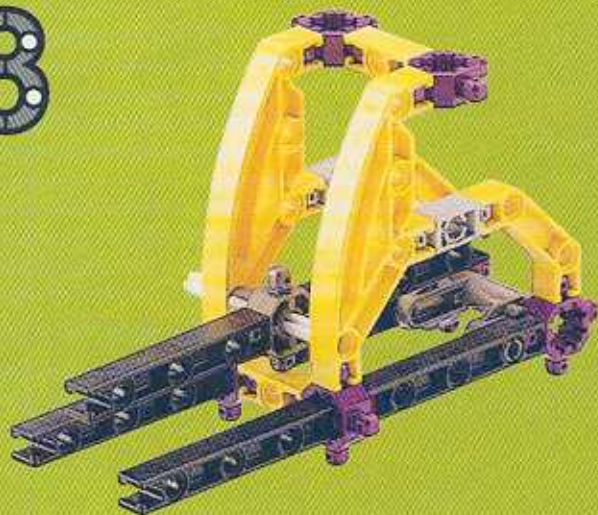

9

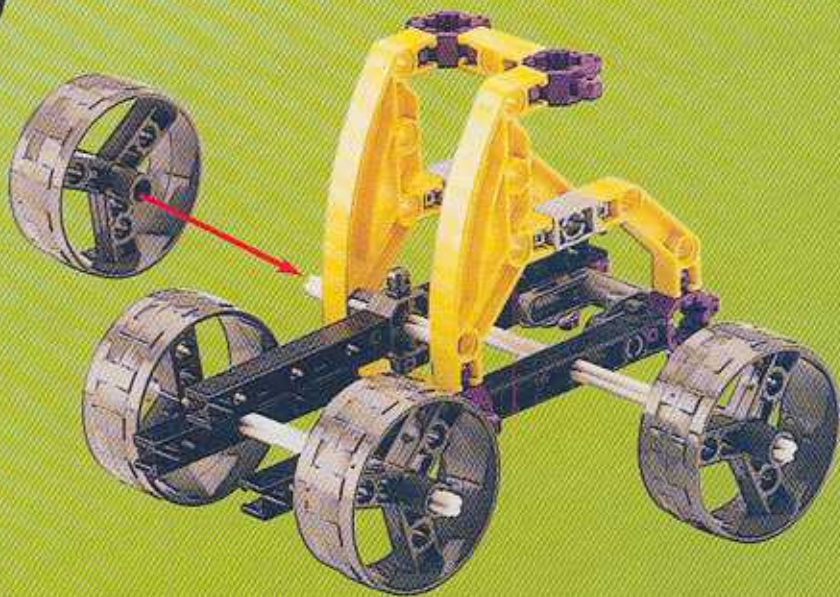

10



11



12





56

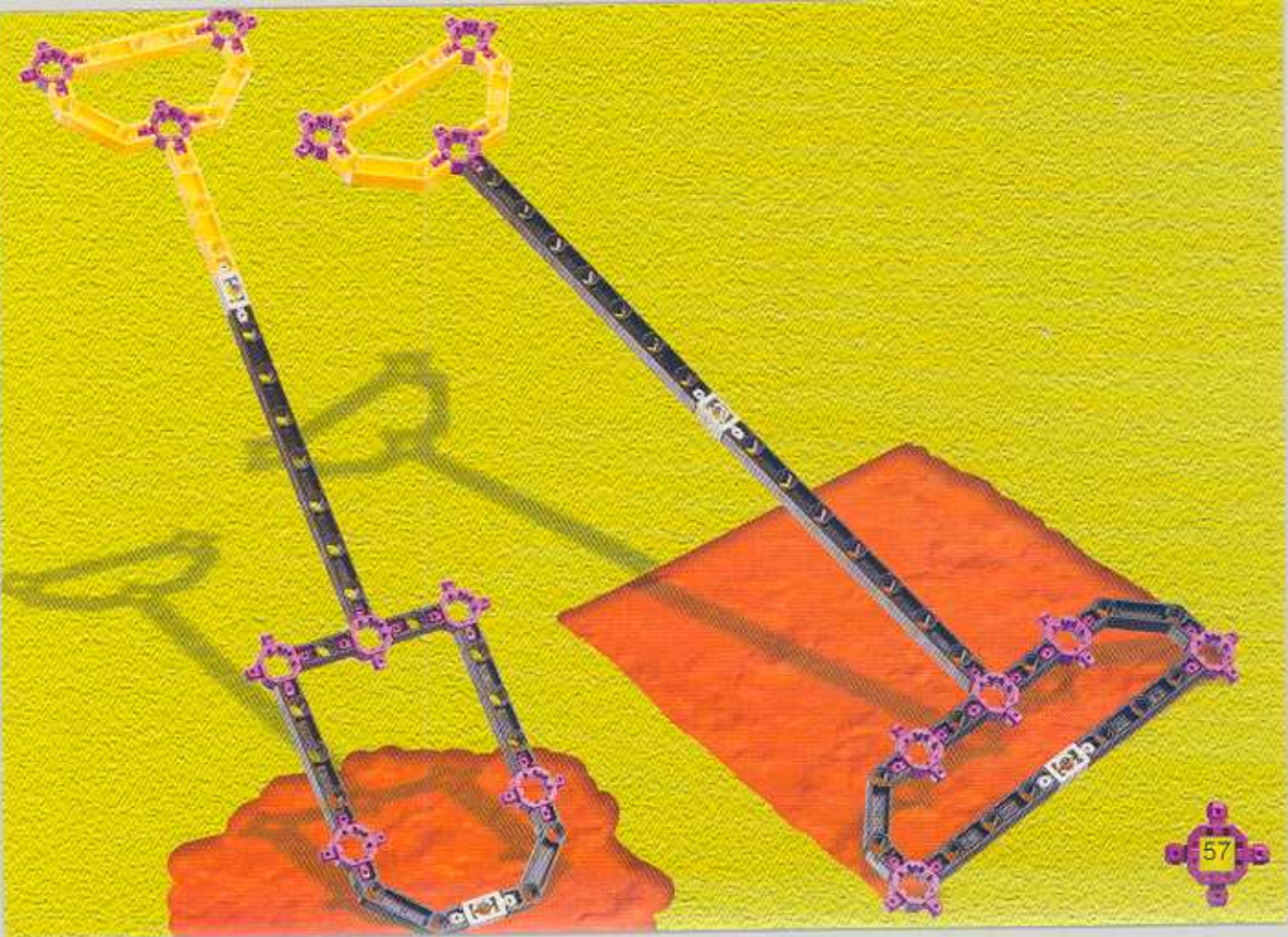

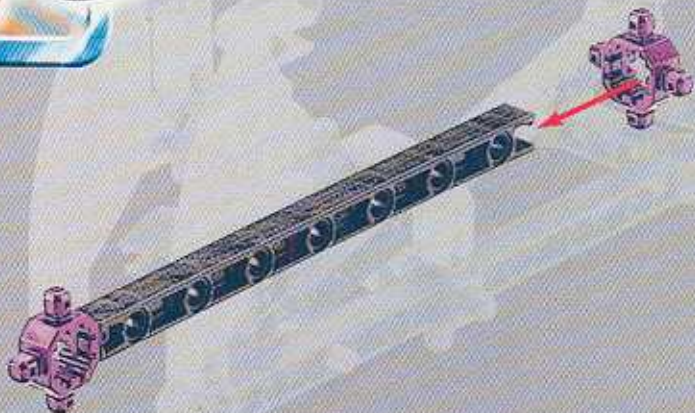

2

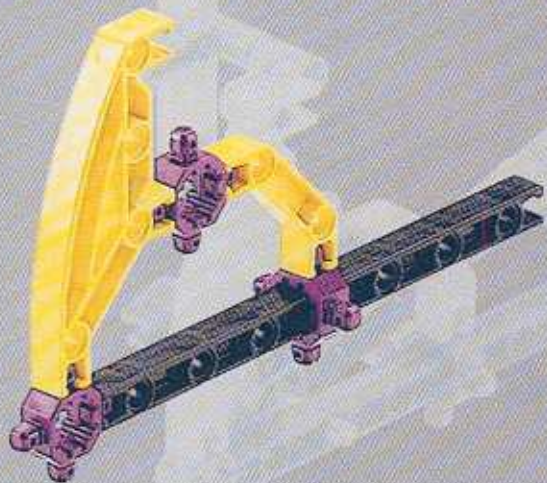

3

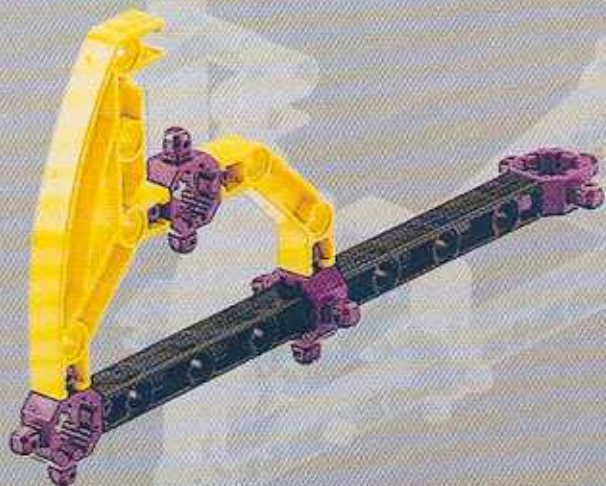

4

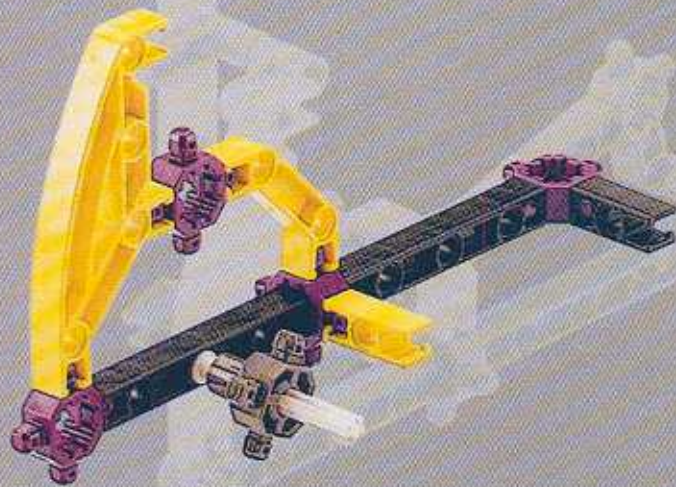

5

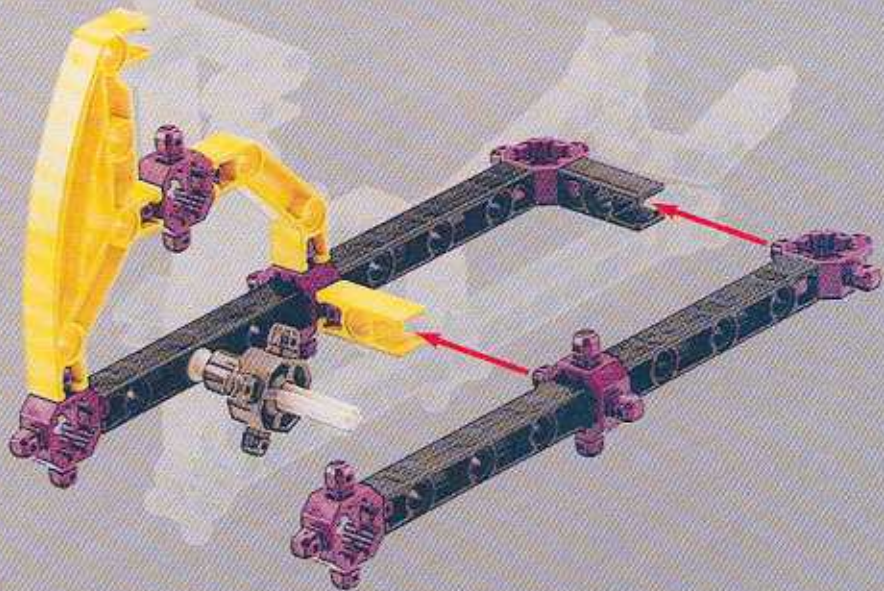

6



7

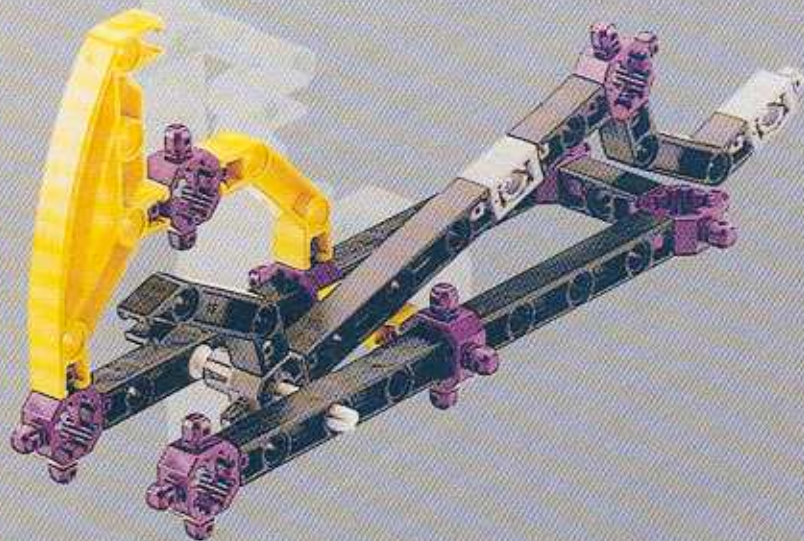

8

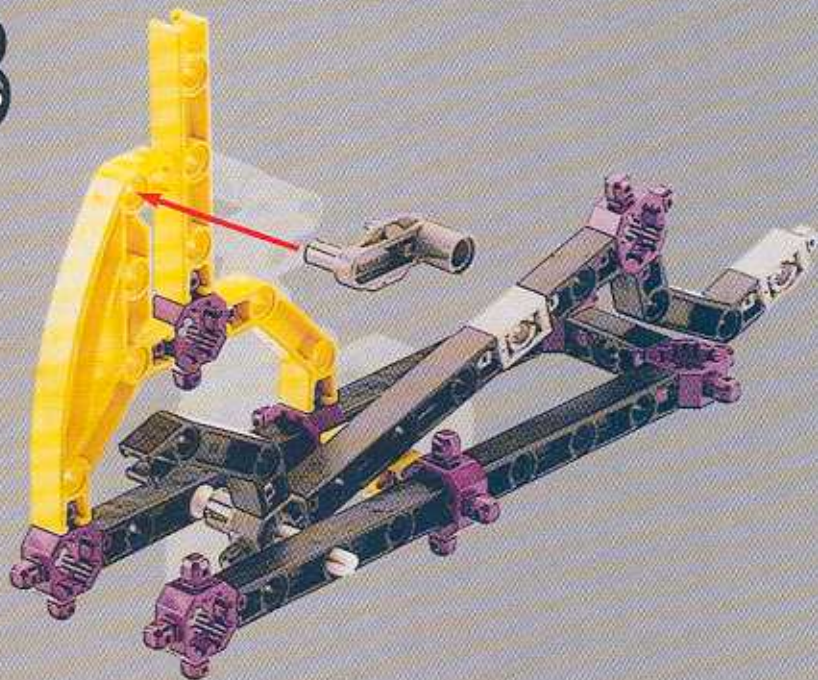

65

19

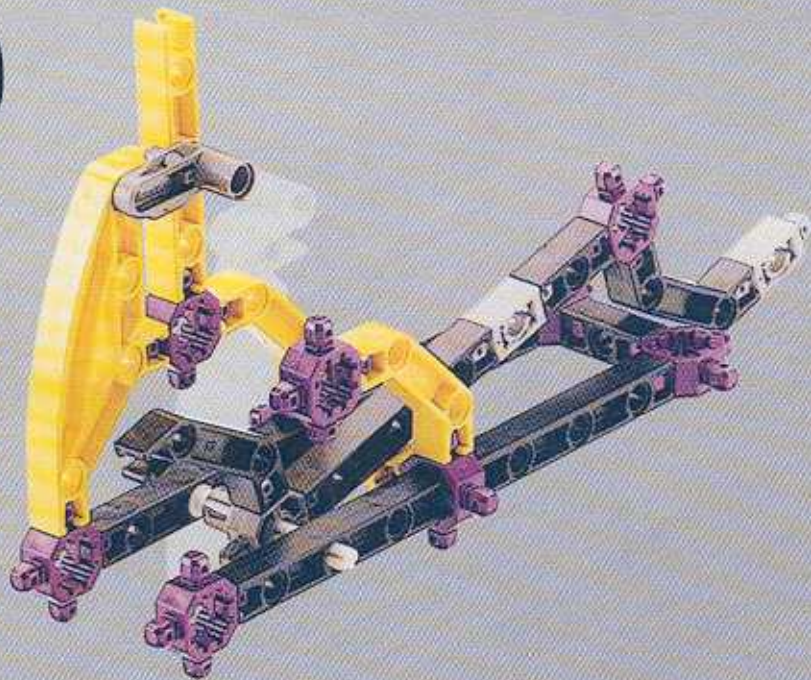

10



11

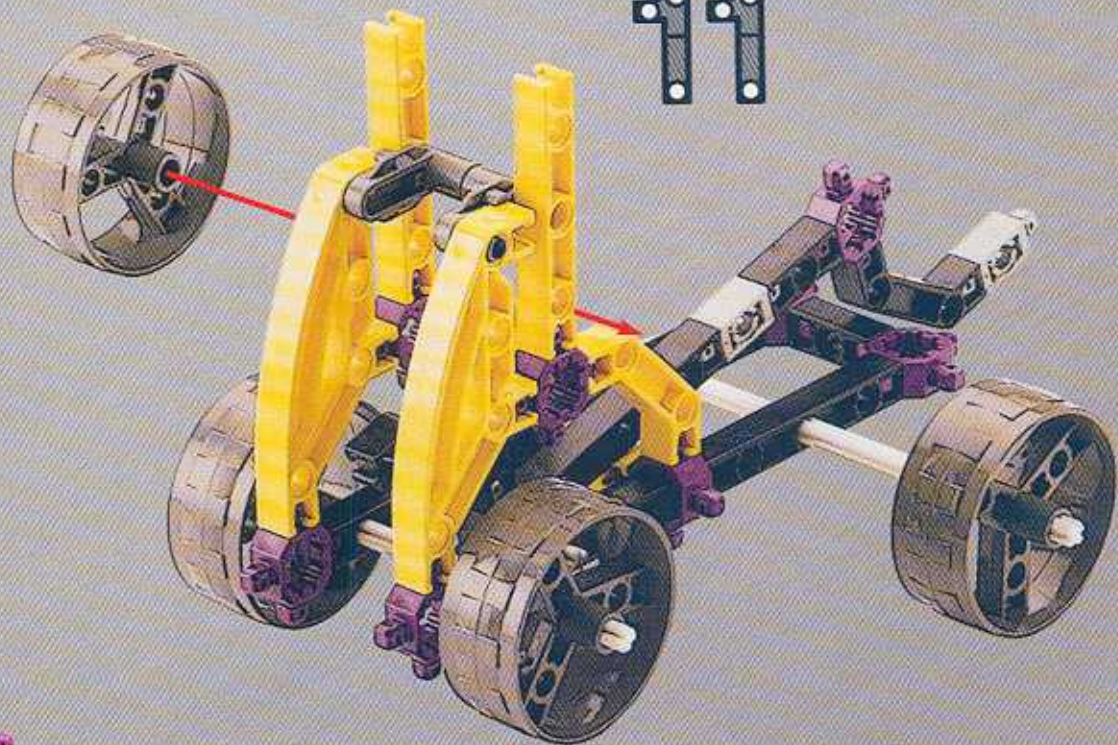

12

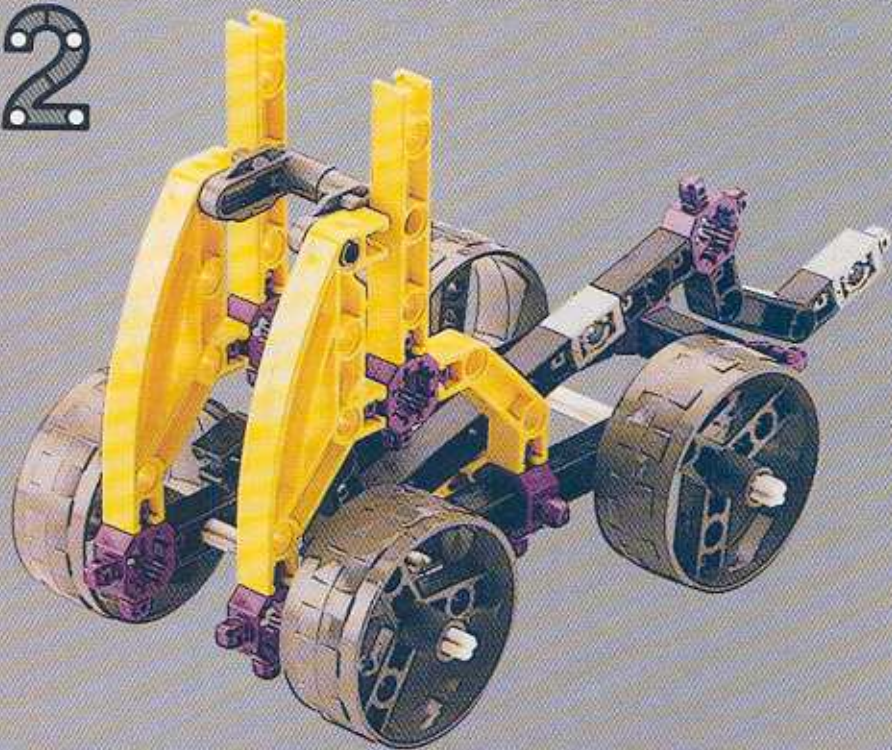



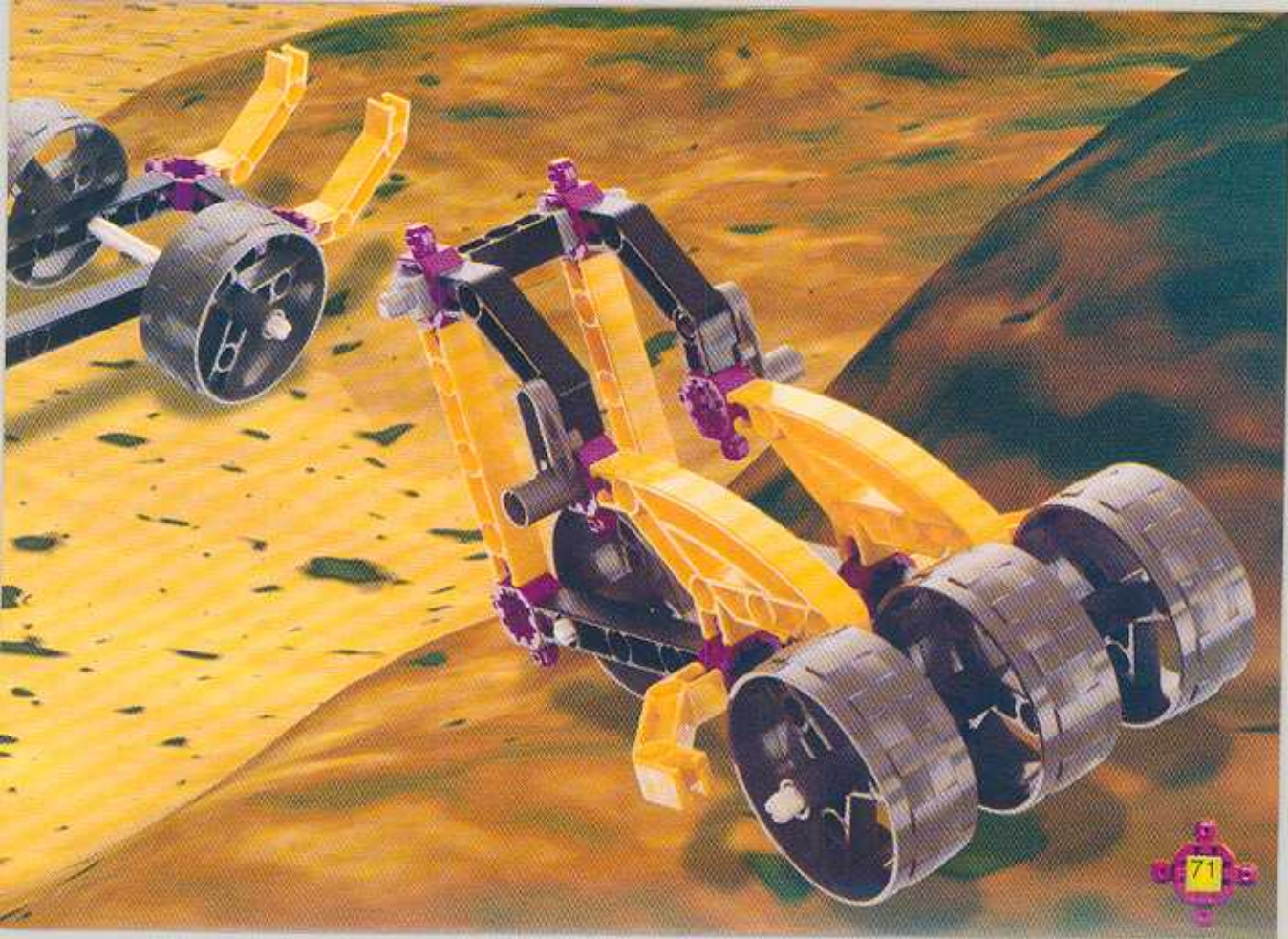



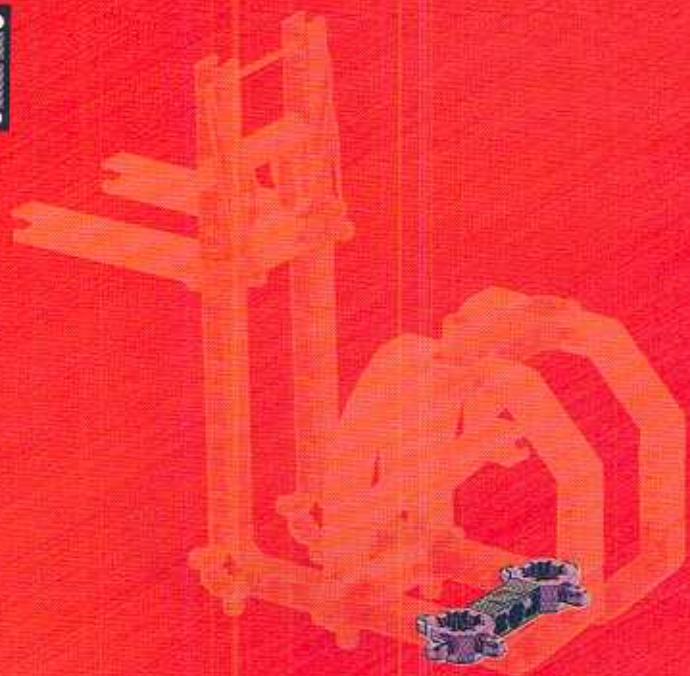

2

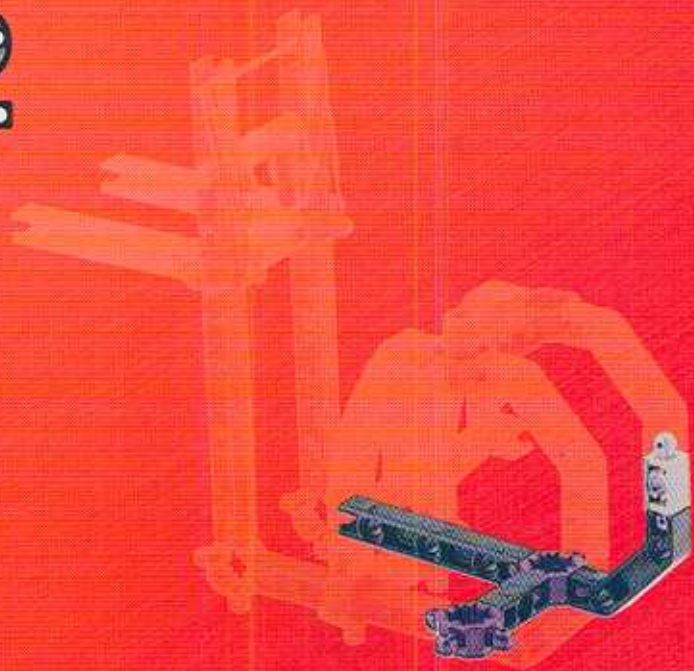

3

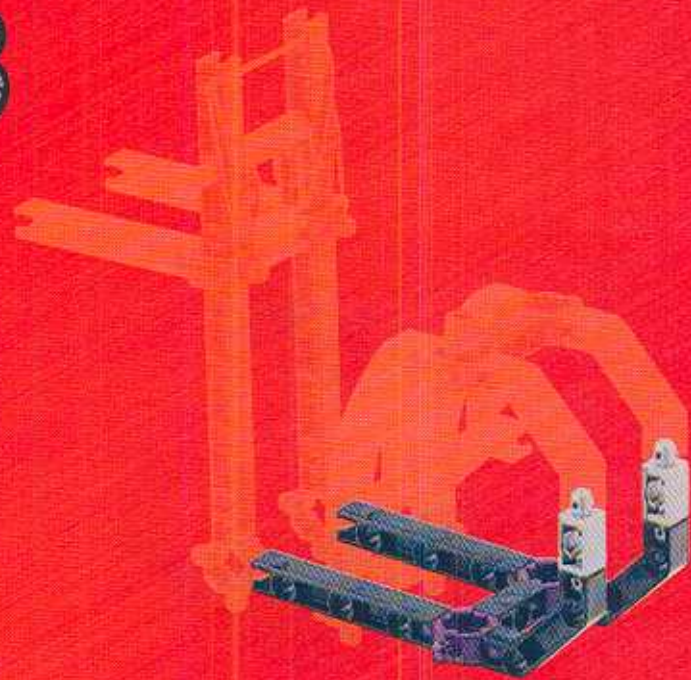

4

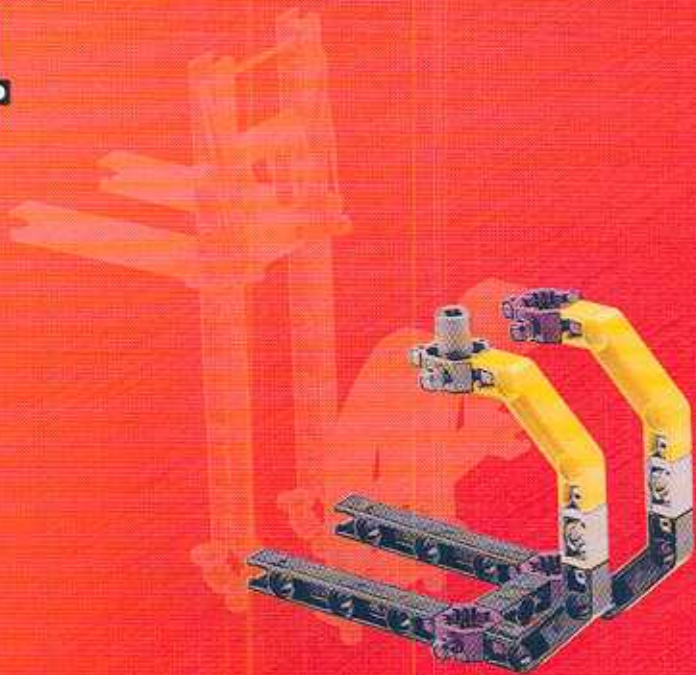

5

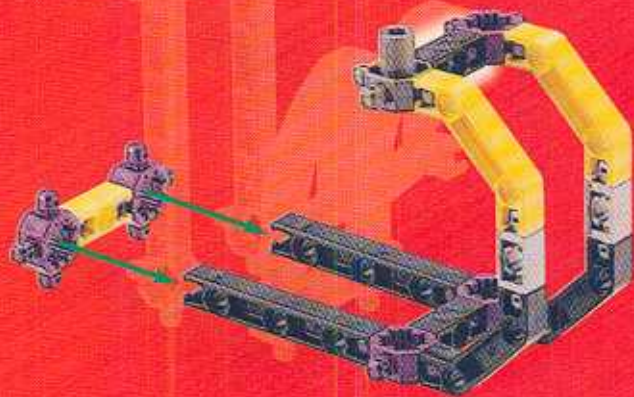

6

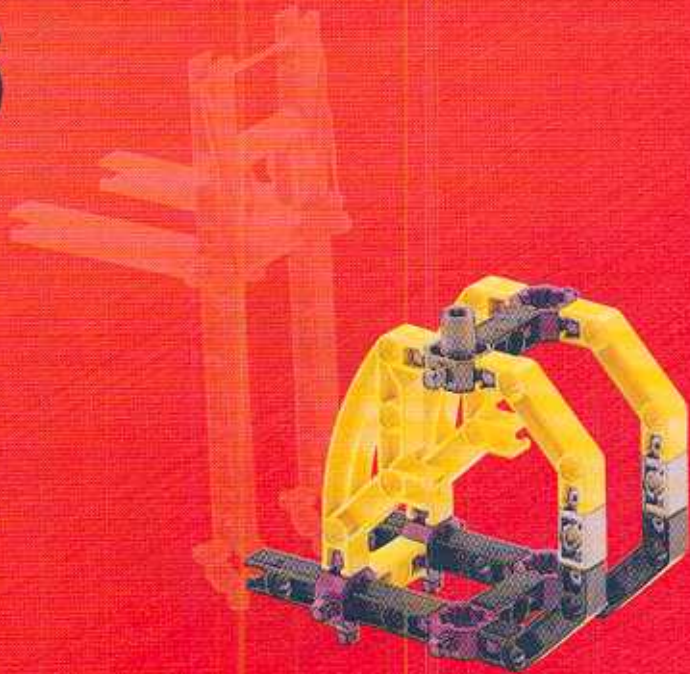

7

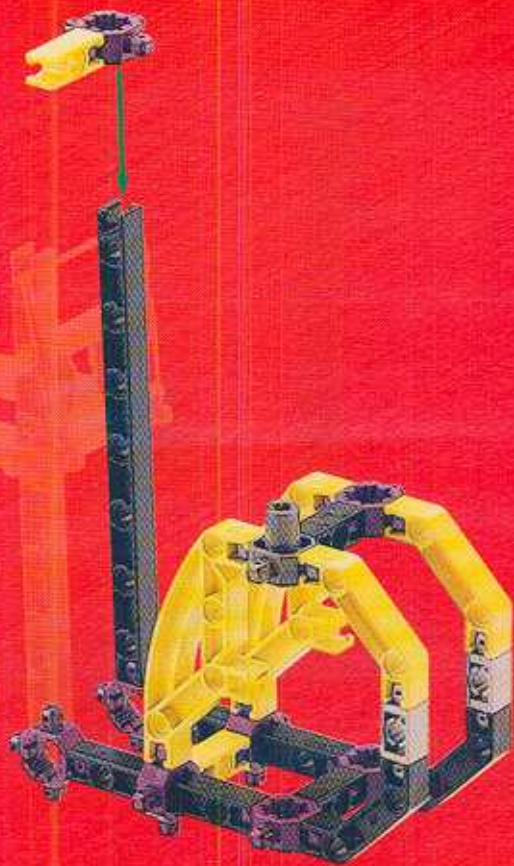

8

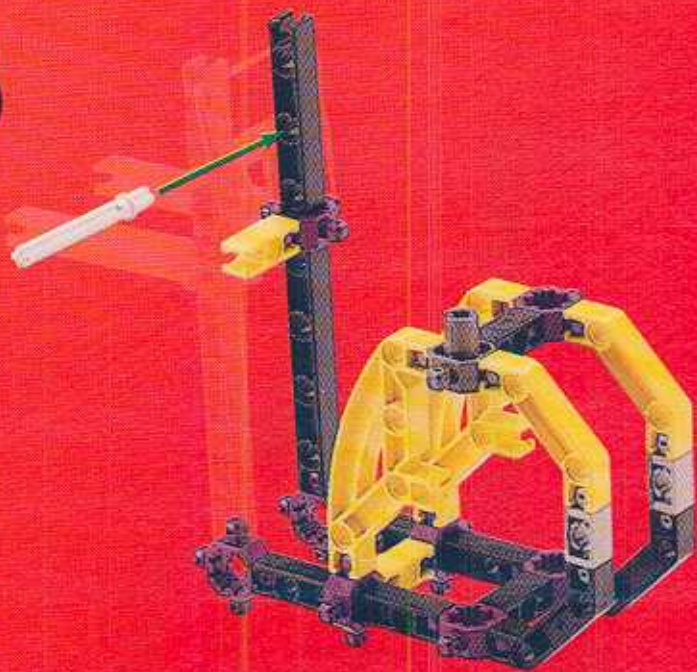

9

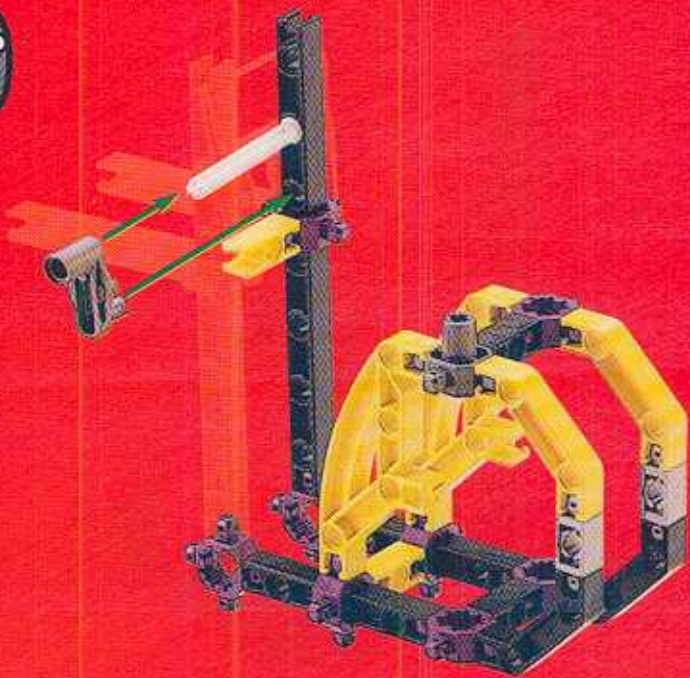

10

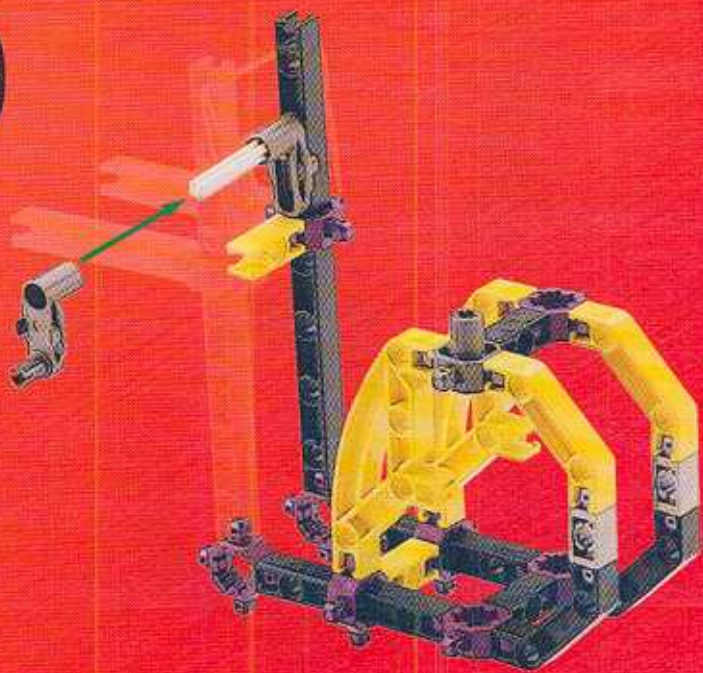

12

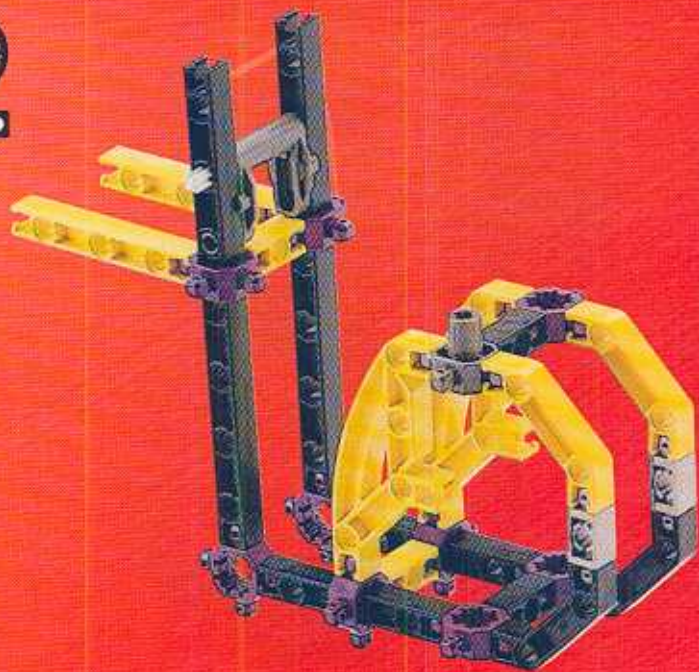

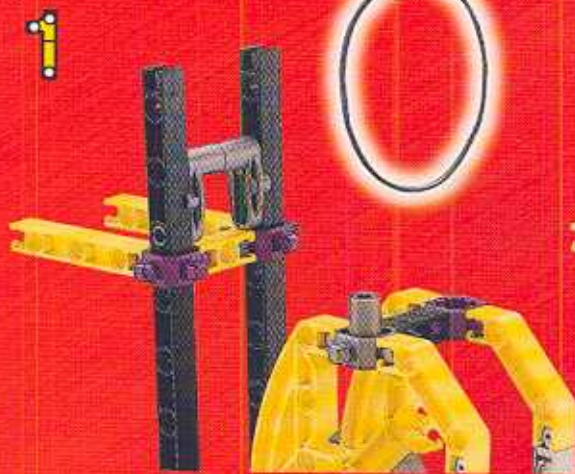

13

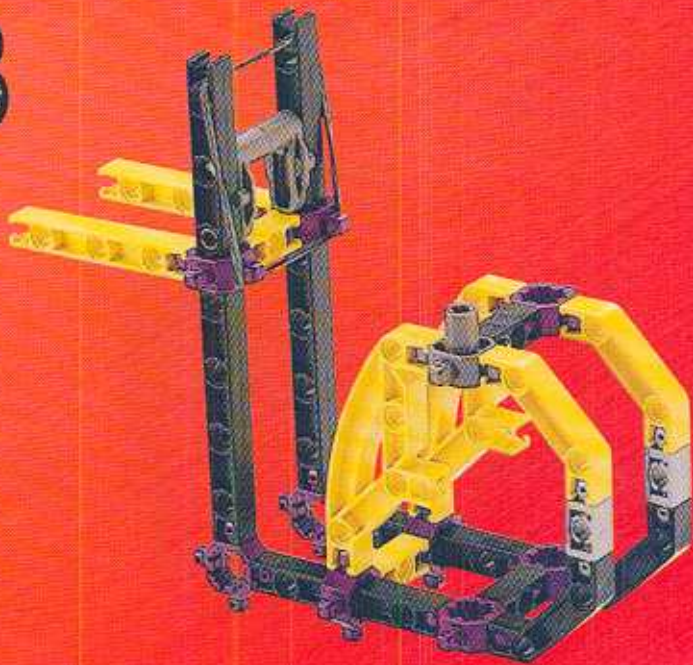

14

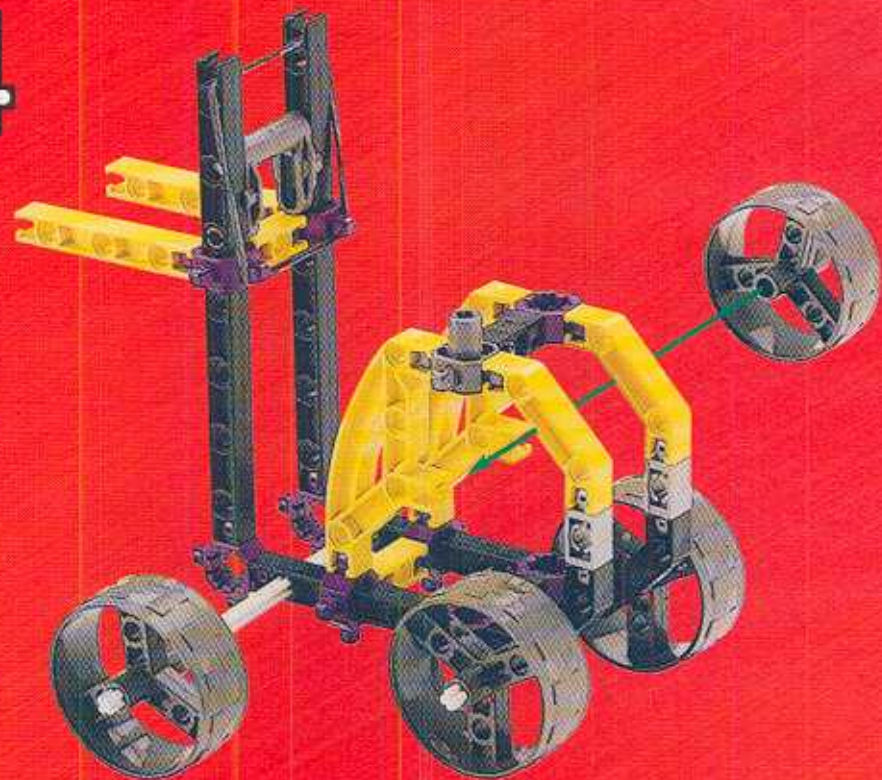

15



