

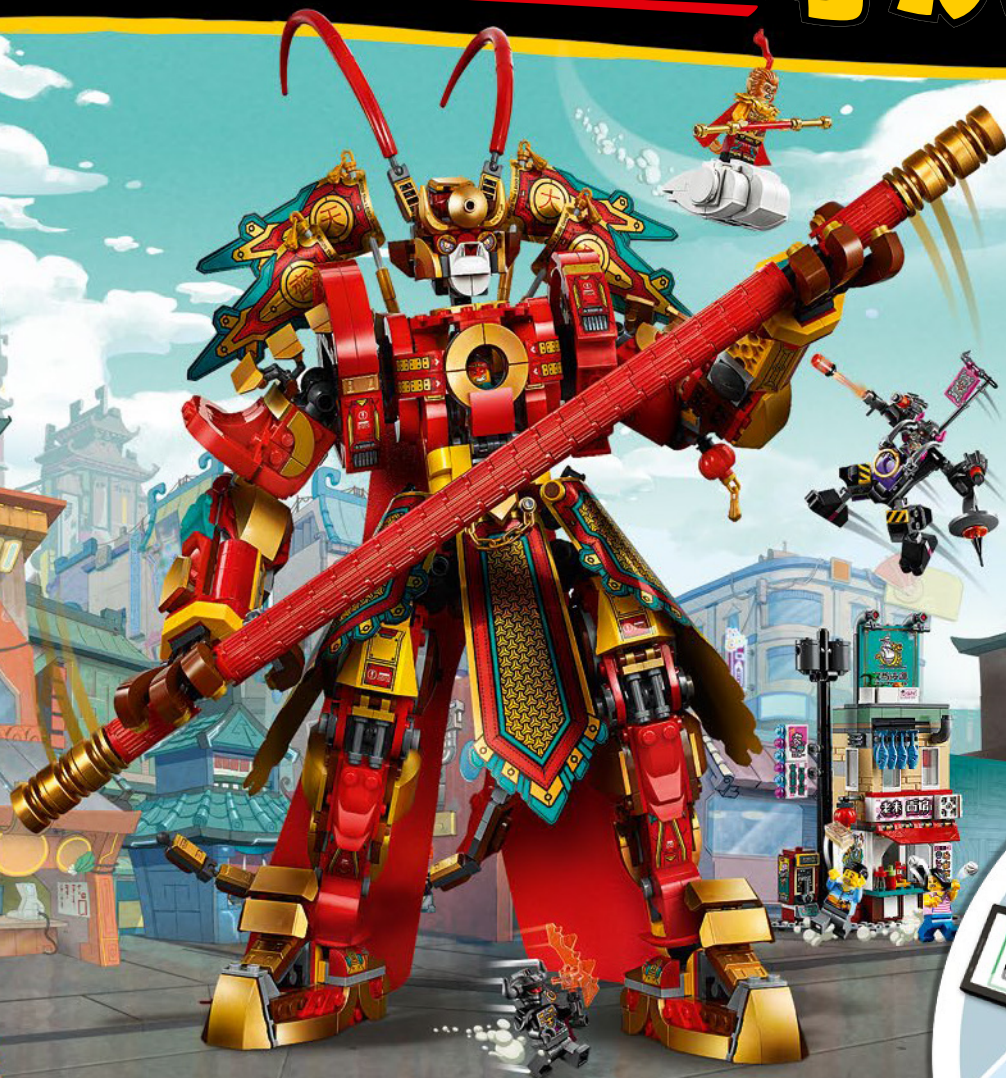

MONKIE KID 悟空小侠™

80012

1



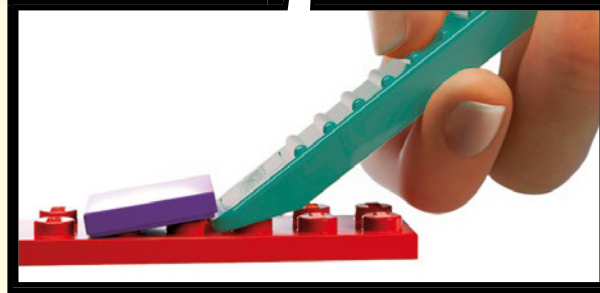
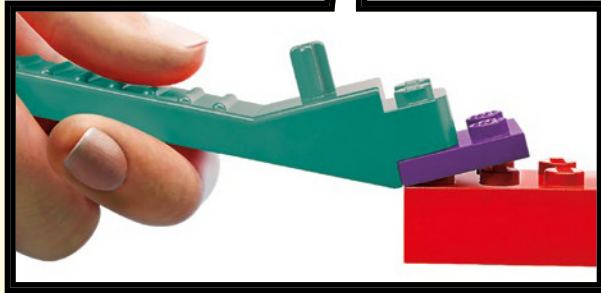
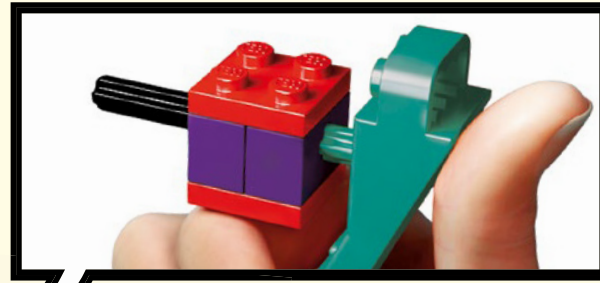
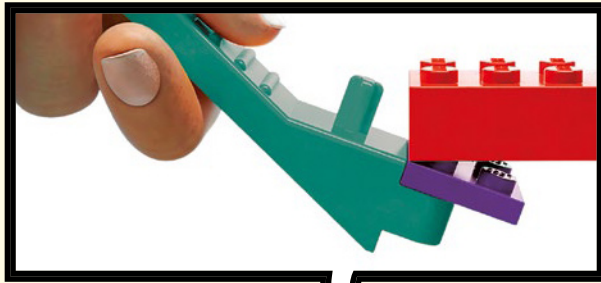

LEGO.com/brickseparator



- 1** Scan the code on the front cover
 Scanne den Code auf der Titelseite
 Scanne le code sur la page de couverture
 Scanner le code sur la page couverture
 Scansiona il codice sulla copertina
 Escanea el código de la portada
 Faz scan do código na frente da capa
 Olvasd be a borítón látható kódot!
 Noskenē kodu uz priekšējā vāka
 扫描封面上的二维码



- 2** Get Instructions PLUS
 Hol dir Instructions PLUS
 Hol dir Instructions PLUS
 Obtiens les instructions PLUS
 Obtenir les Instructions PLUS
 Scarica Instructions PLUS
 Descubre Instructions PLUS
 Obtém Instruções PLUS
 Szerezd be az Instructions PLUS
 kiegészítőt!
 Saņem "Instructions PLUS"
 获取更多说明

LEGO.com/apps

Check for compatibility
 Kompatibilität prüfen
 Vérifier la compatibilité
 Controlla la compatibilità
 Comprueba tu compatibilidad

Verificar a compatibilidade
 Ellenőrizd a kompatibilitást
 Pārbaudīt saderību
 检查兼容性



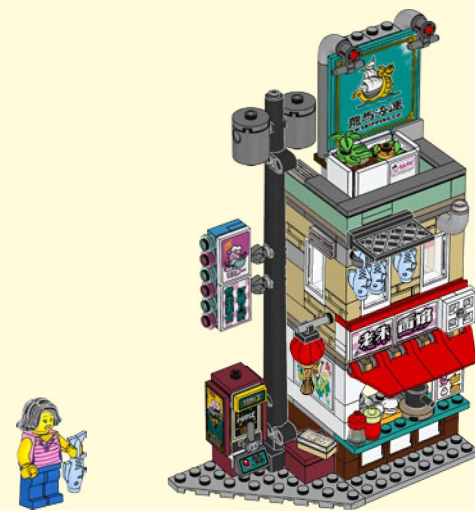



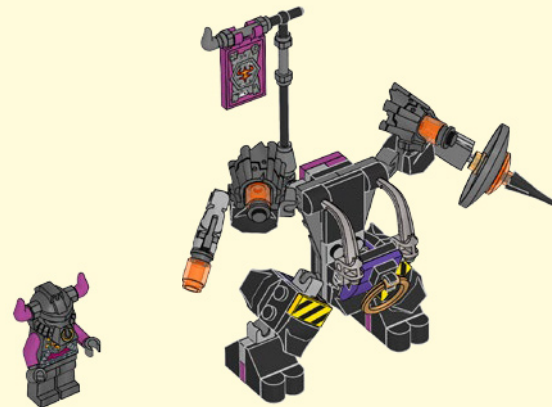

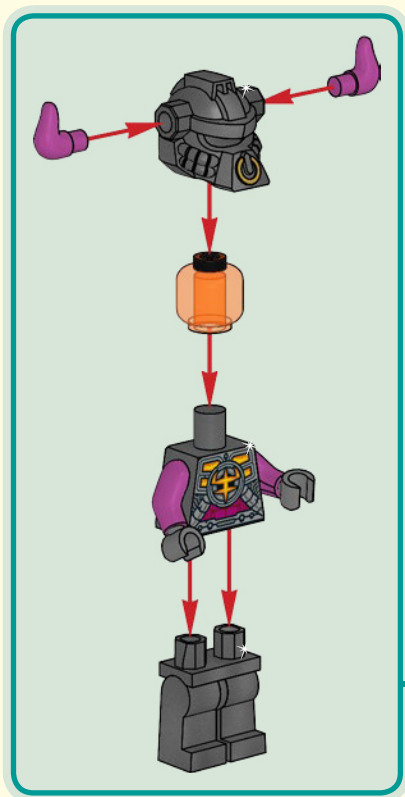

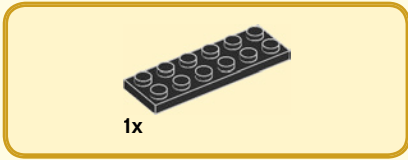
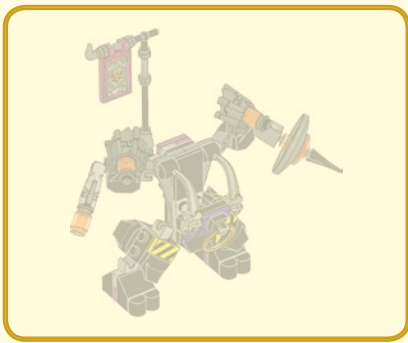

1

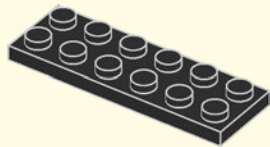

2

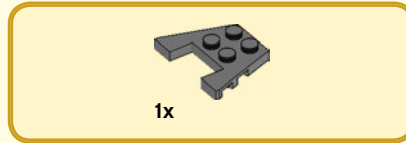
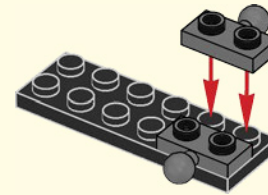

3

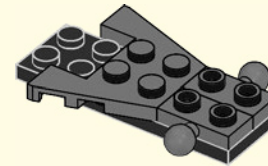



4

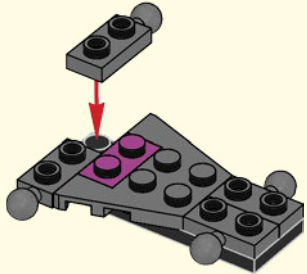

5

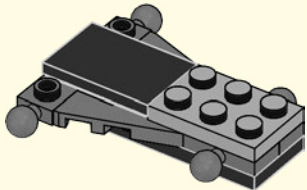

6

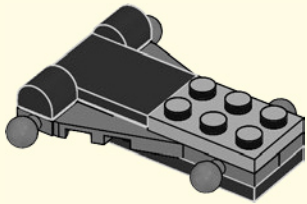



7

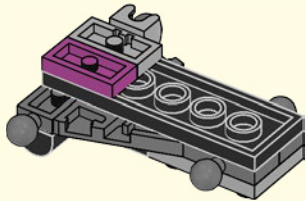

8

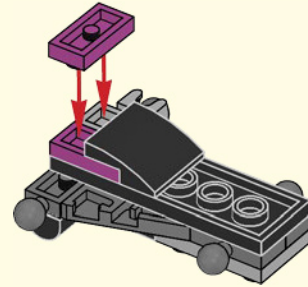

9

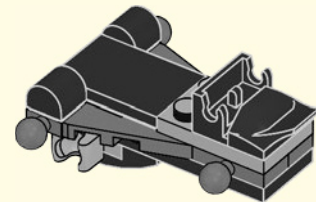
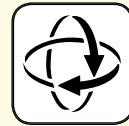

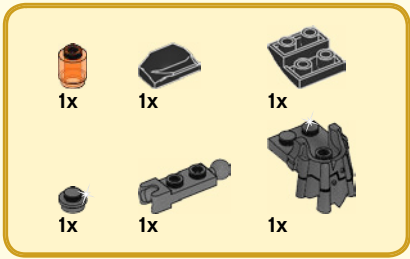

10

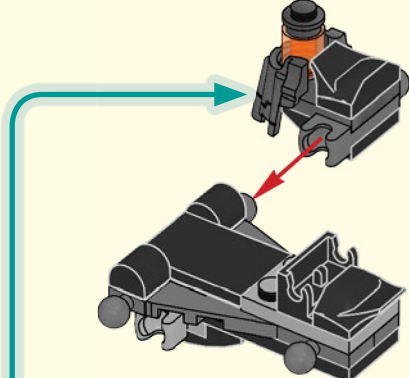
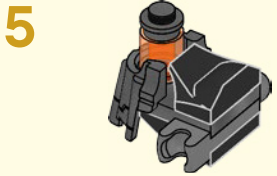
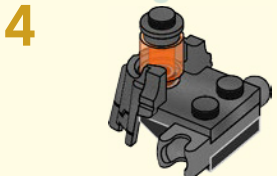
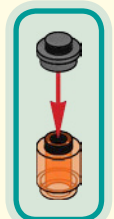
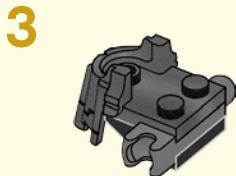
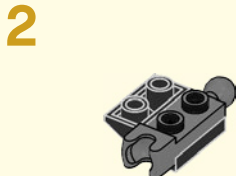
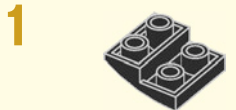

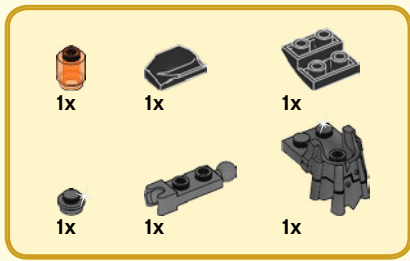

11

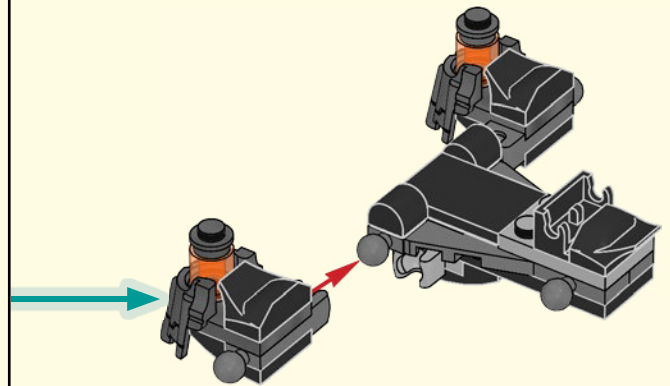
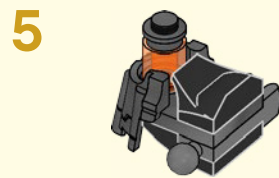
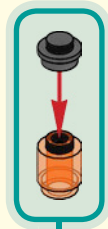
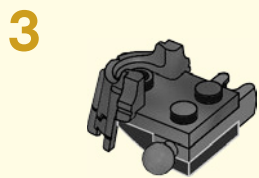
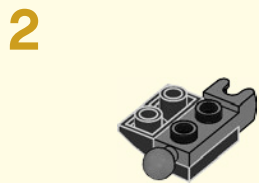
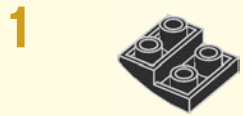



1x

12

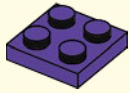

1x



1x

13

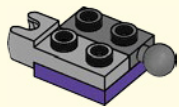

1x

14

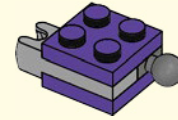

1x



1x

15

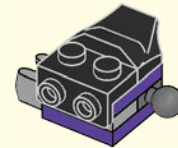

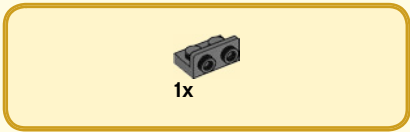

16

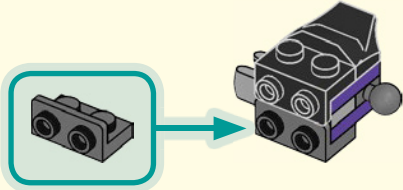

17



18

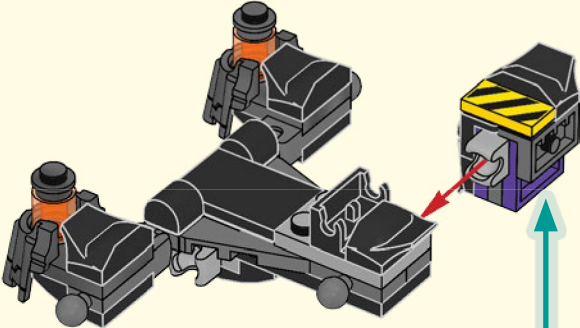



1x

19

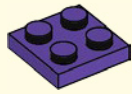

1x



1x

20

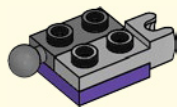

1x

21

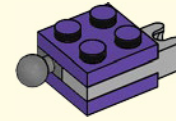

1x



1x

22

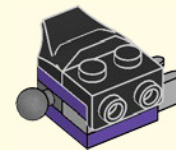



1x

23

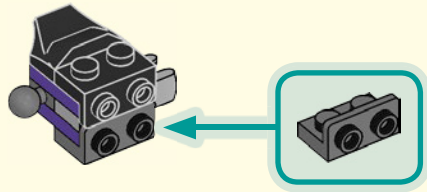

1x



1x

24



25

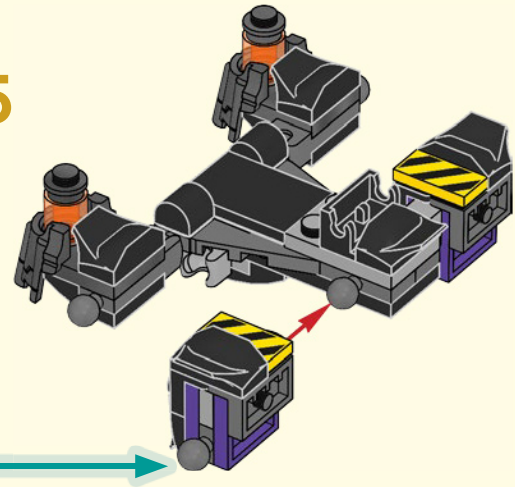

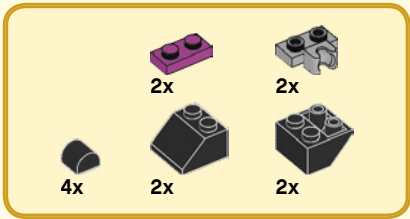

26

1		3	
2		4	

2x

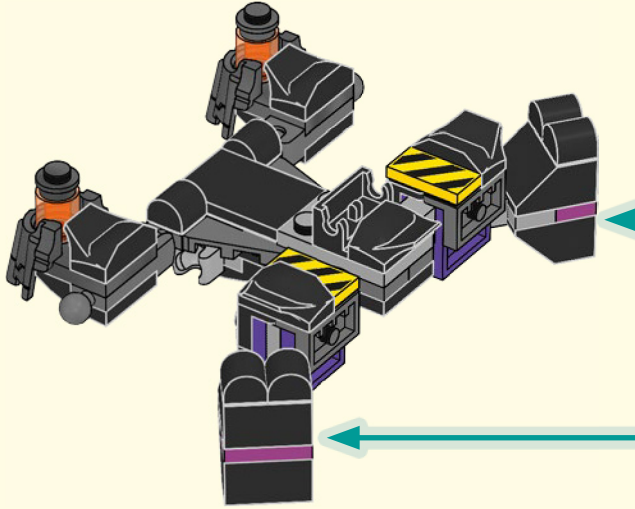

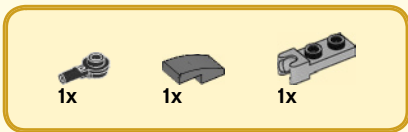

27

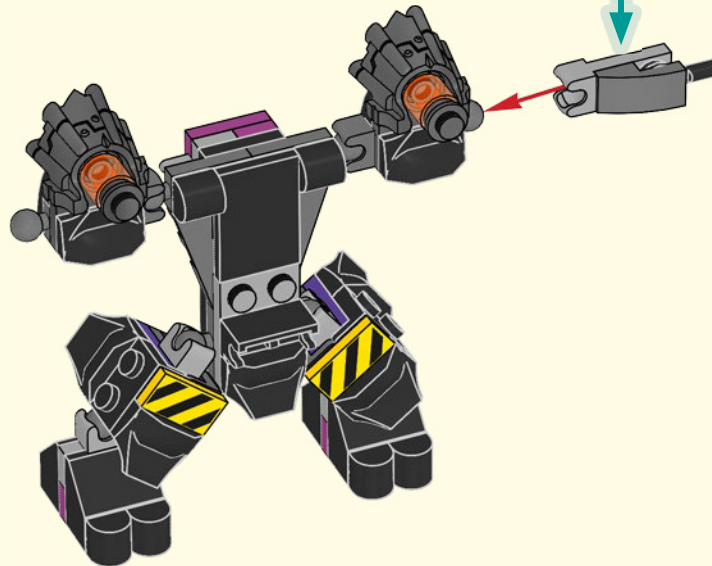
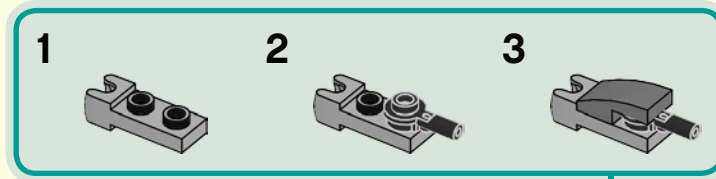



28

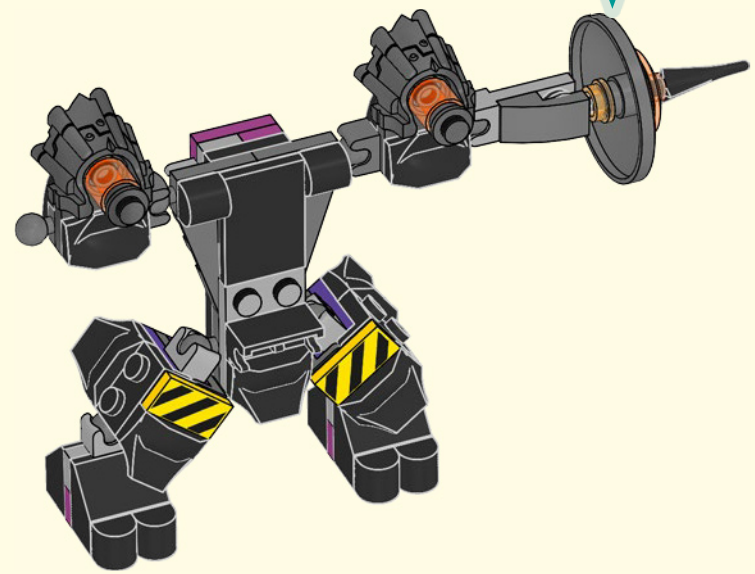
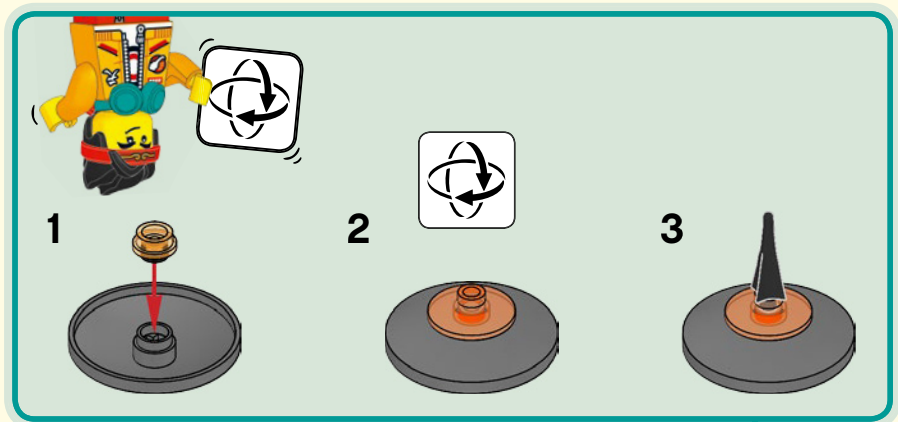



29

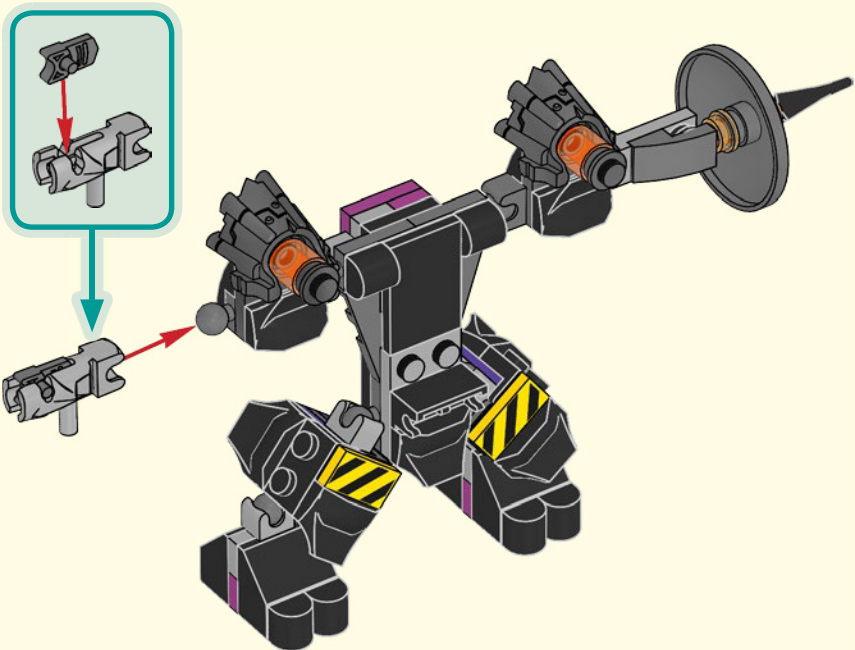



30

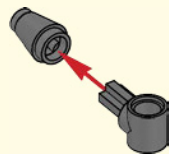

32

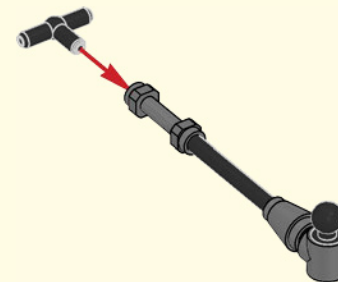

31

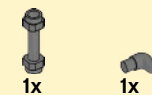

33

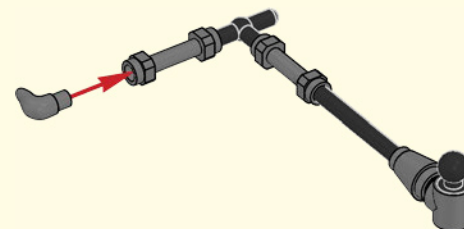

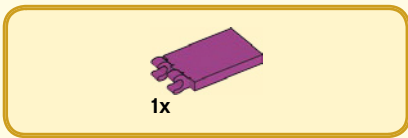

34

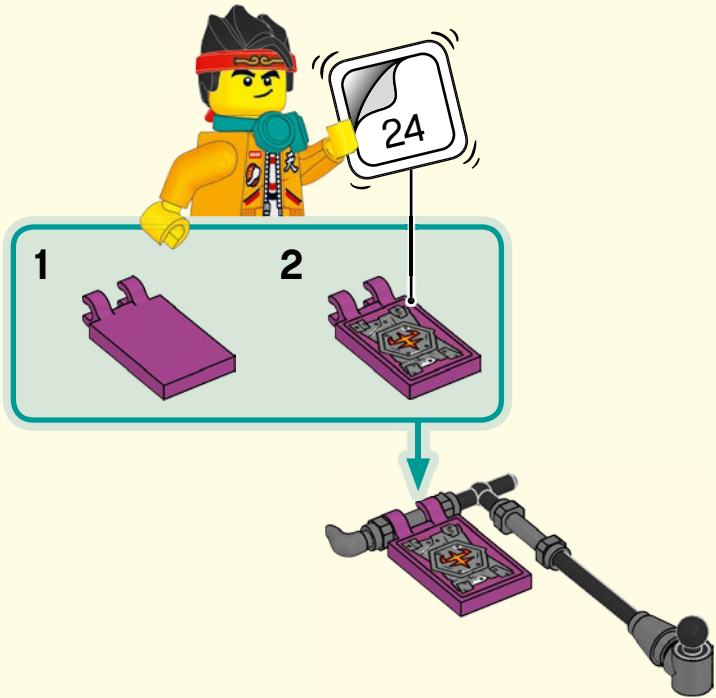

35

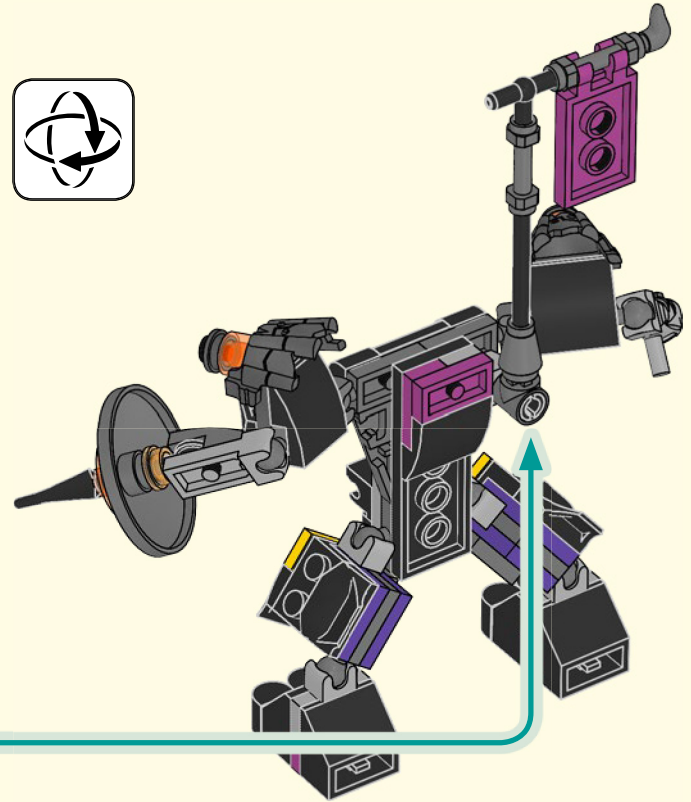
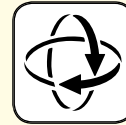

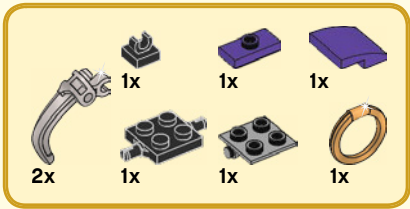

36

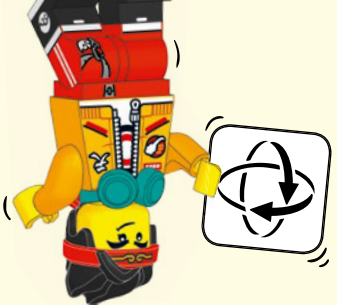

1

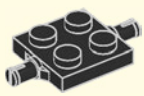

2

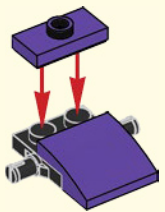

3

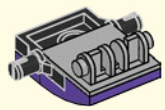

4

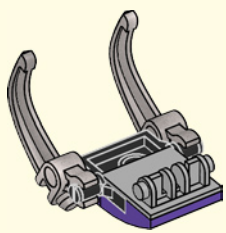

5

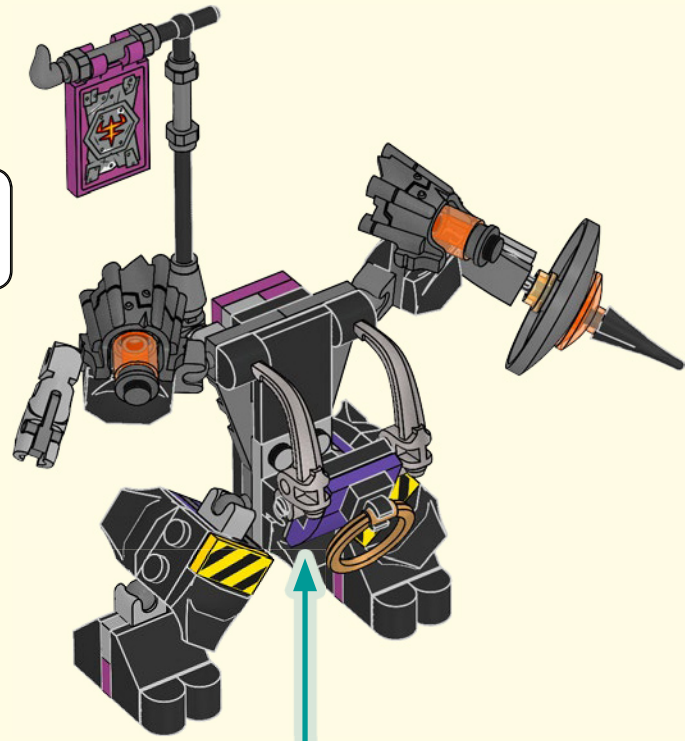
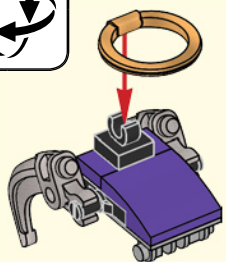
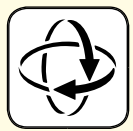

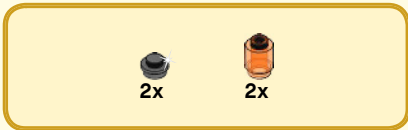

37

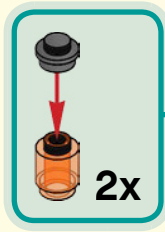
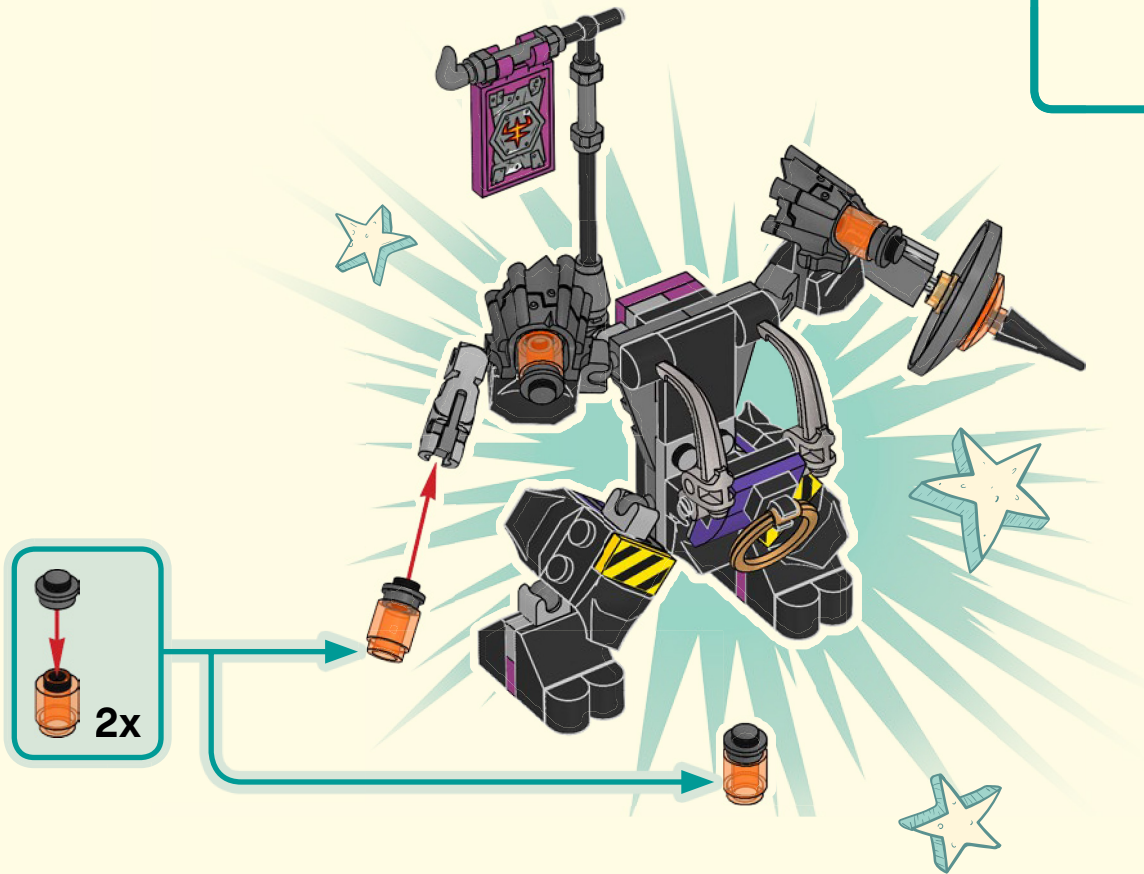
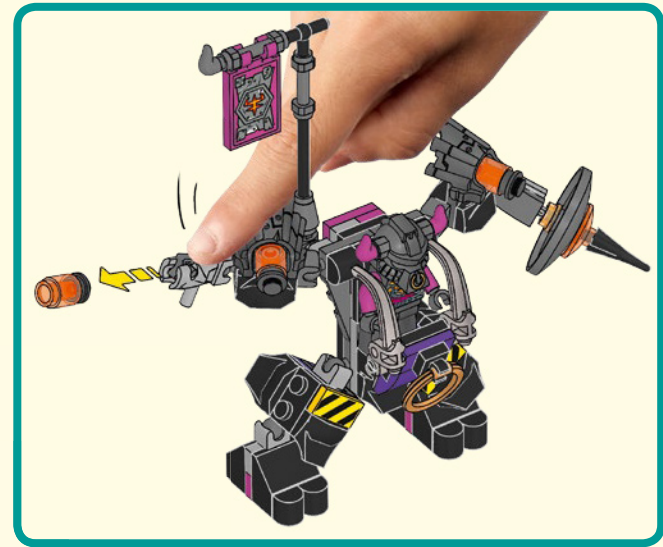



1

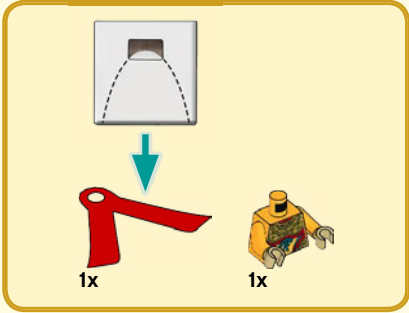
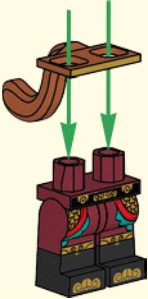

2

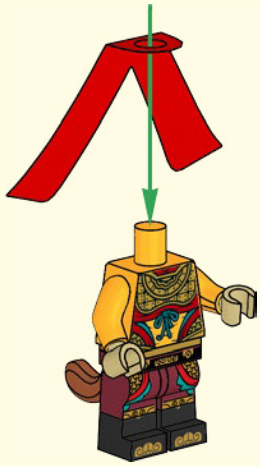



3

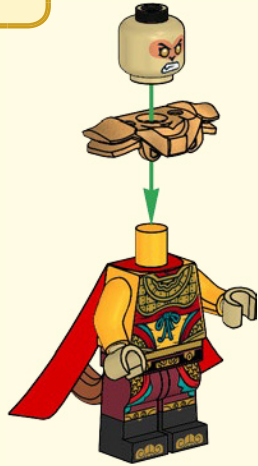

4

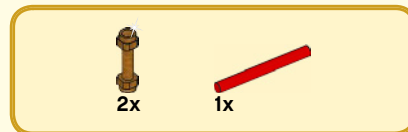
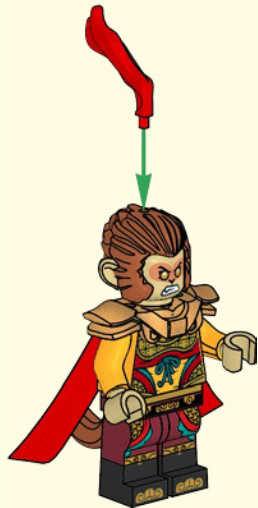

5

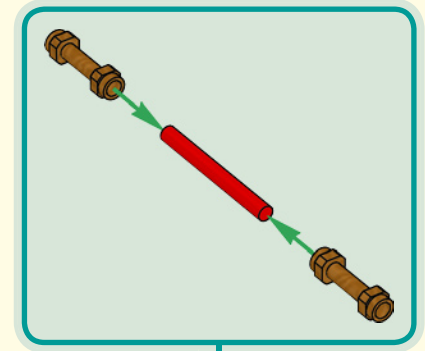

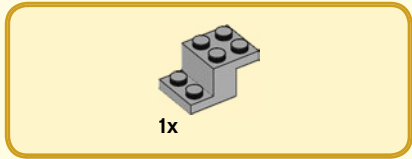

1

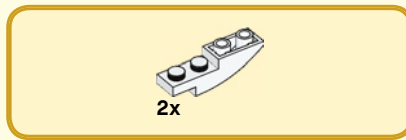
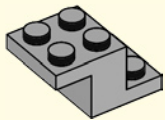

2

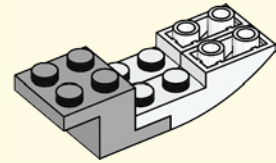

3

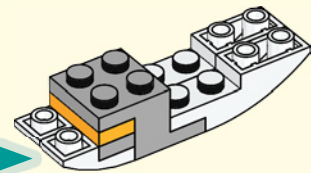
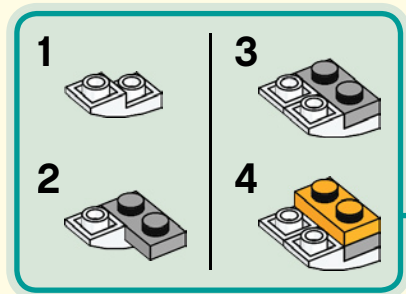



4

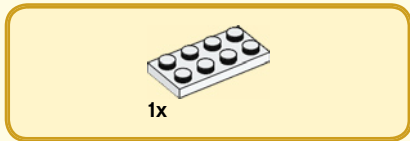
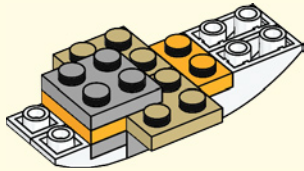

5

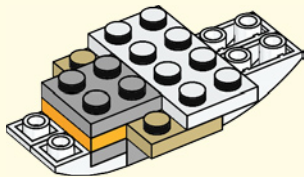

6

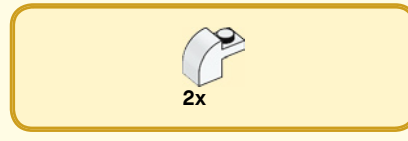
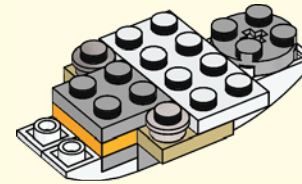

7

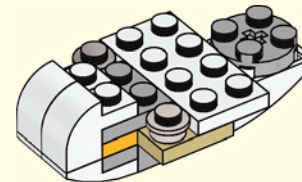



2x



1x

8

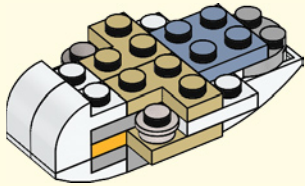

2x



2x

9

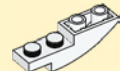
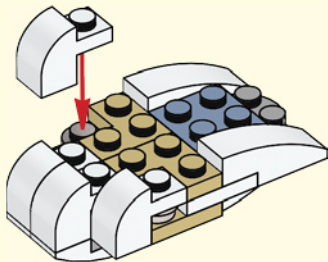

2x



2x

10

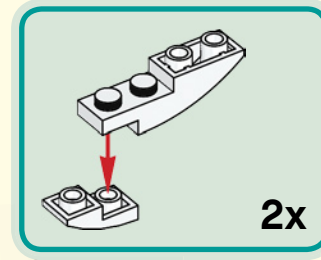

2x

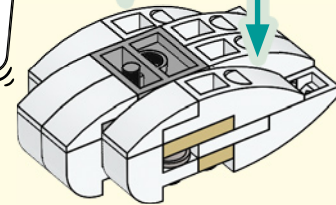
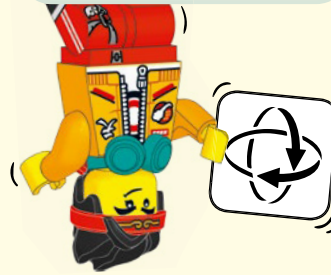

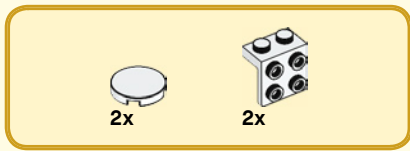

11

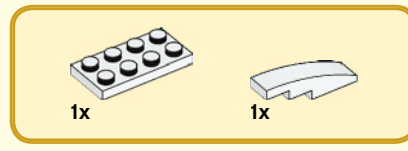
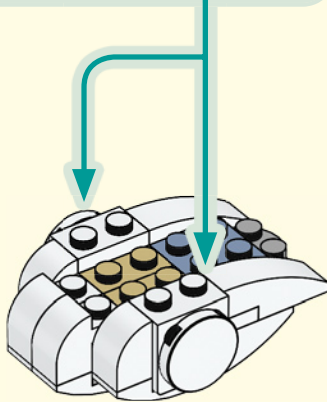
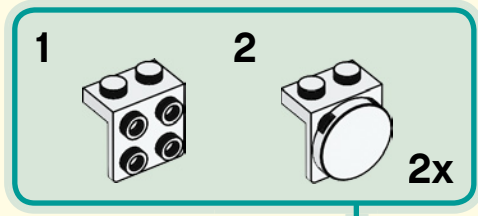

12

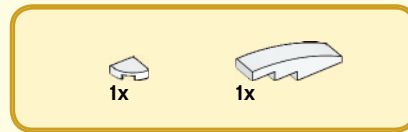
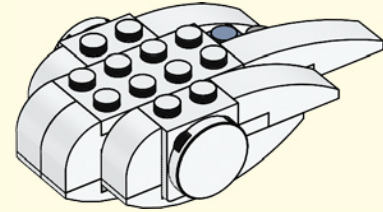

13

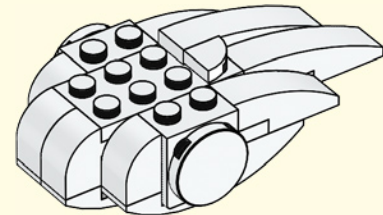



14

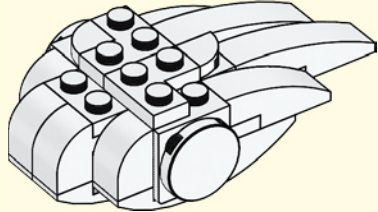

15

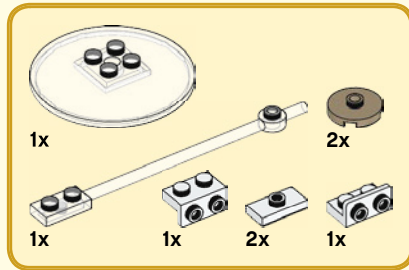
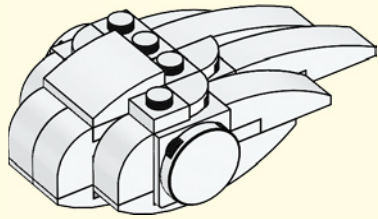

16

1

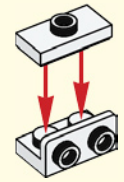

2

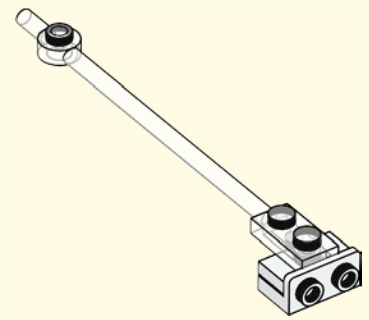

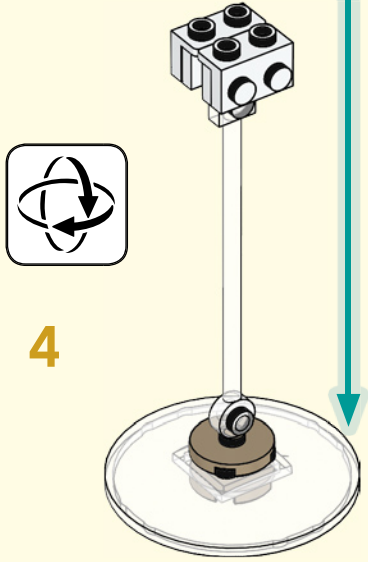
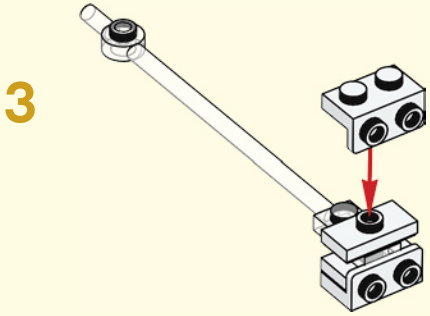
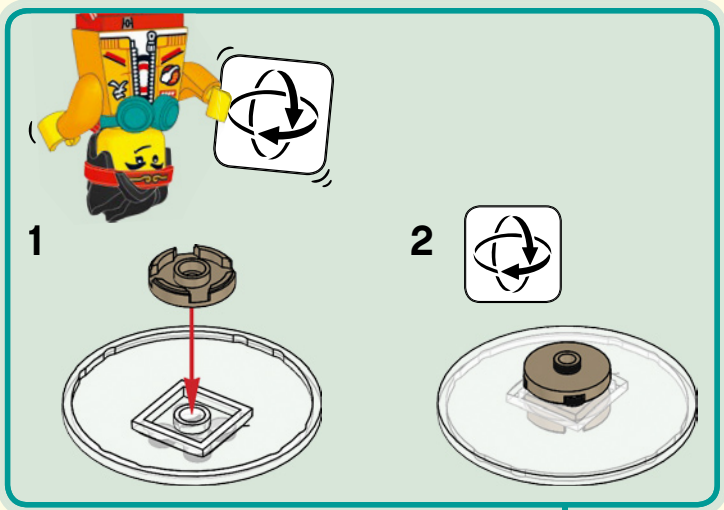

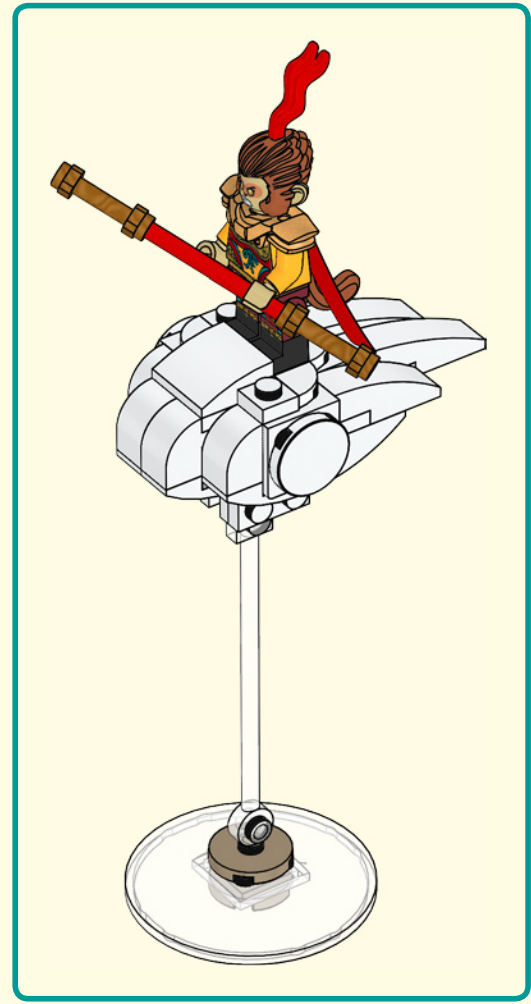
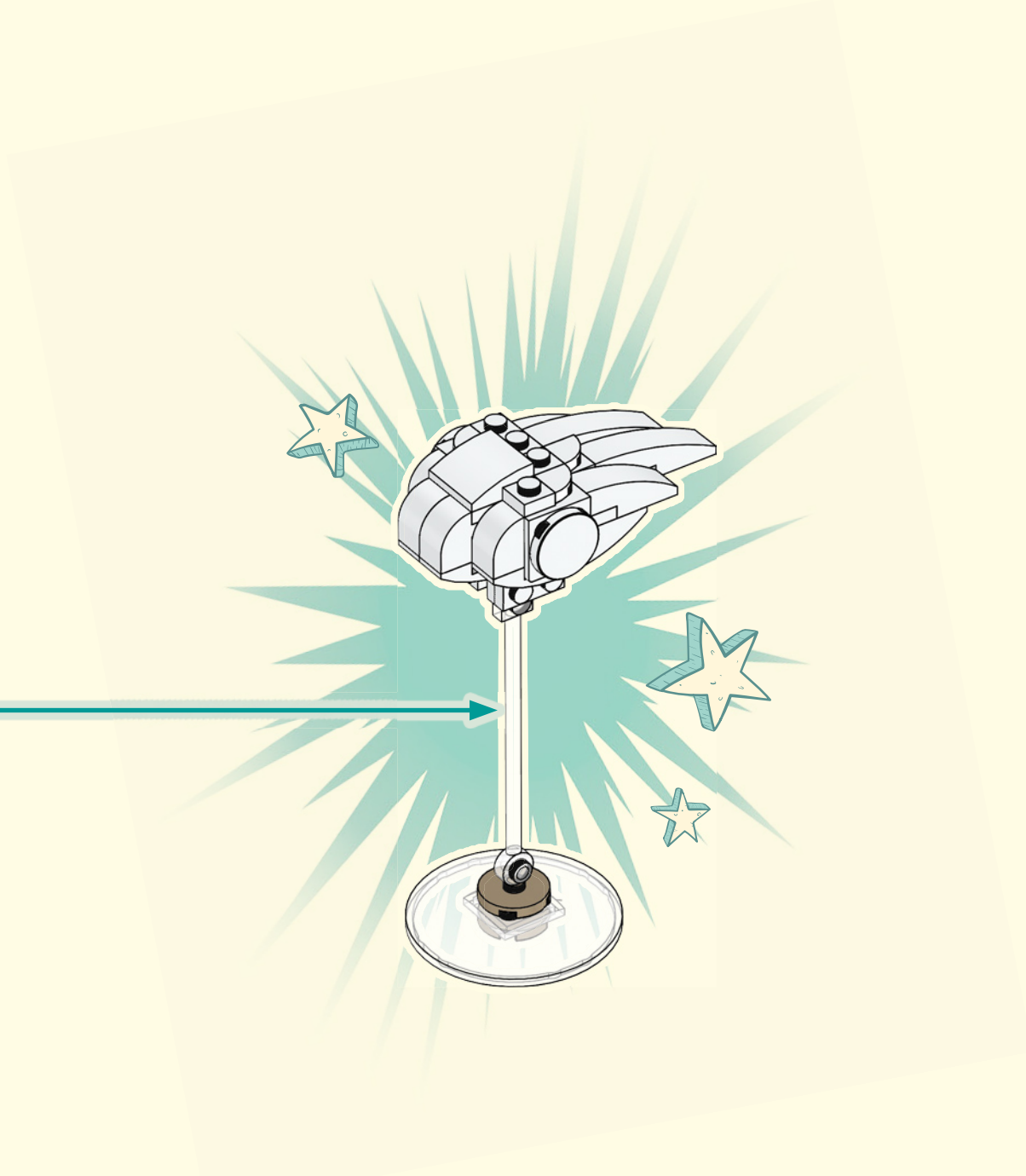

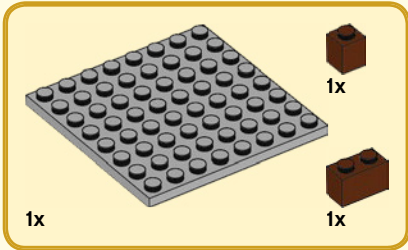
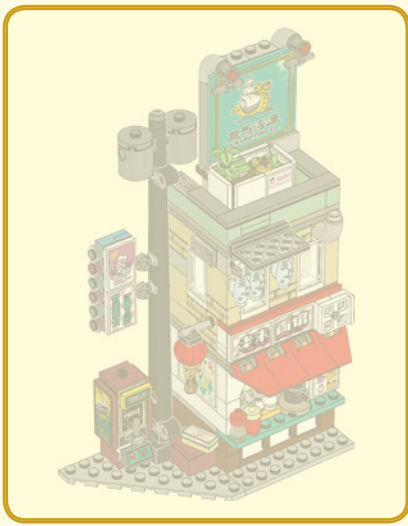

1

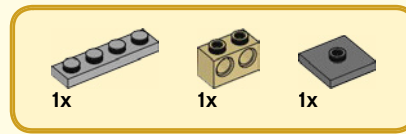
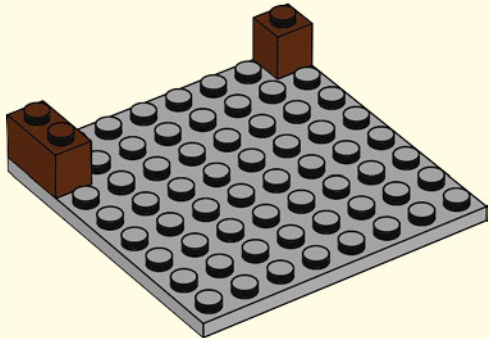

2

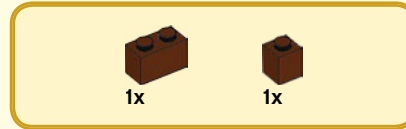
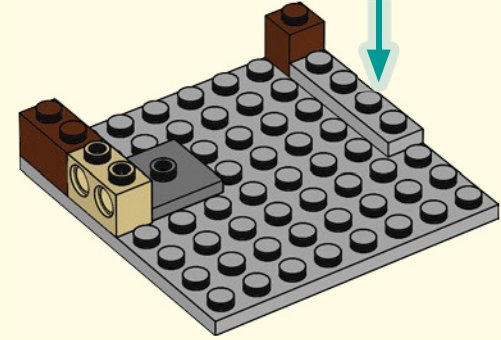
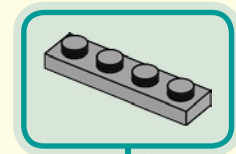

3

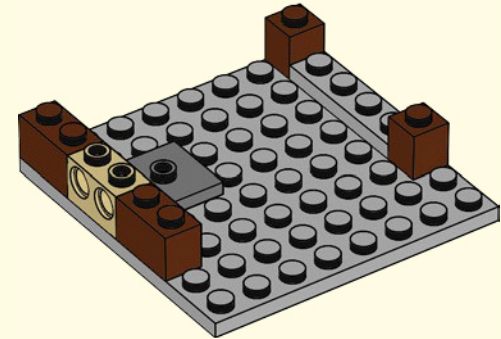

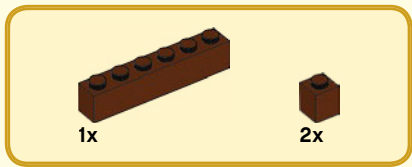

4

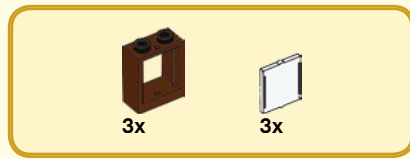
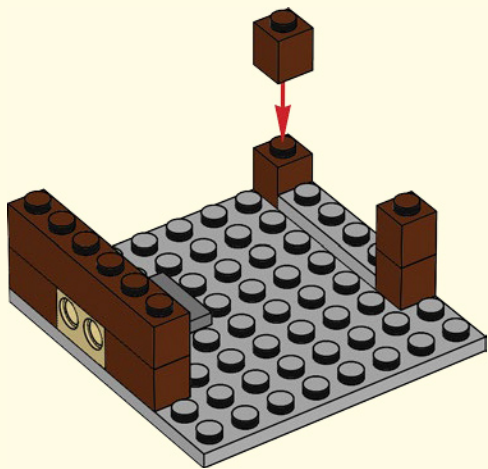

5

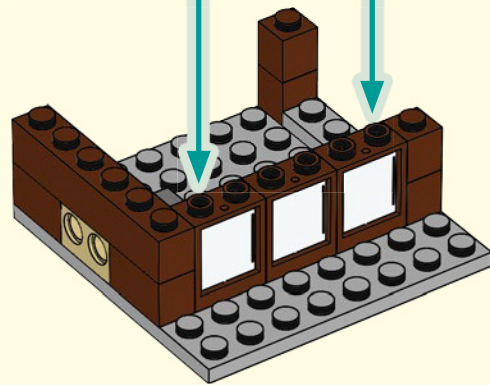
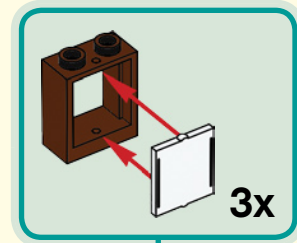

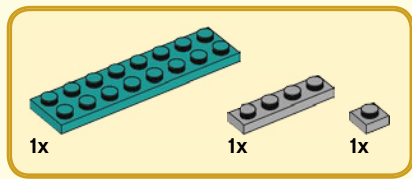

6

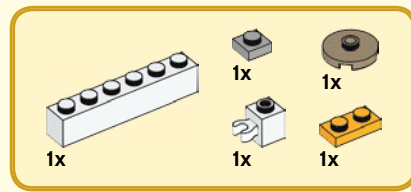
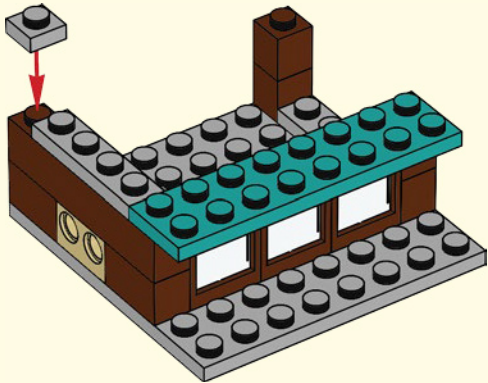

7

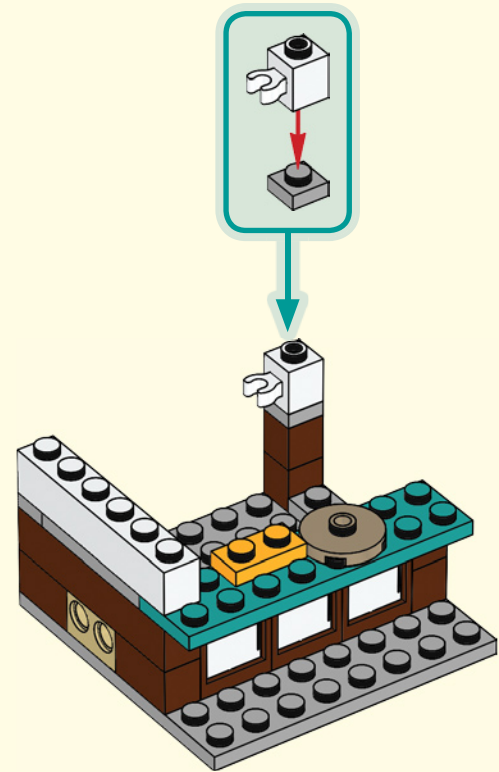

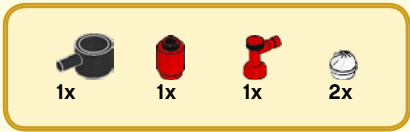

8

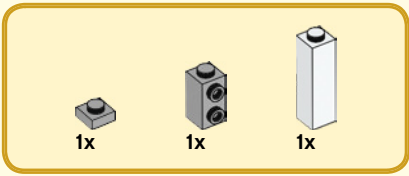
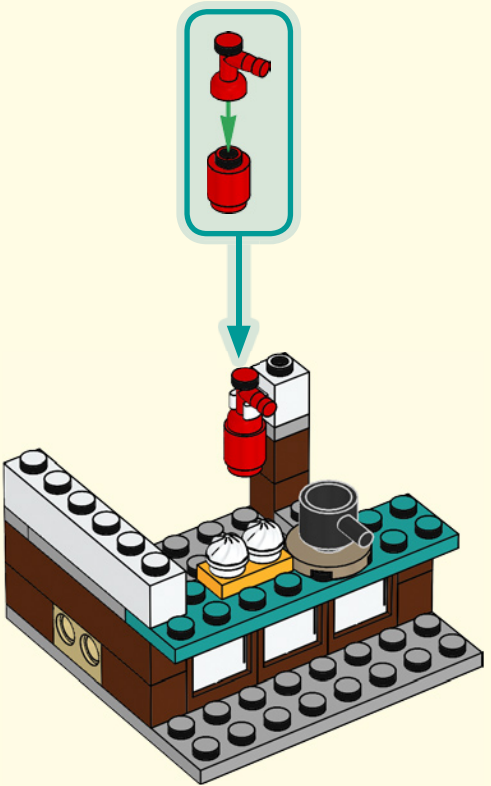

9

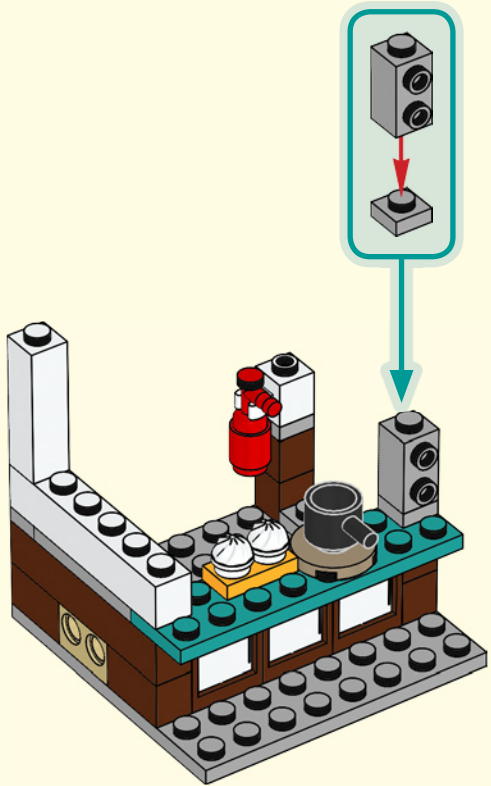

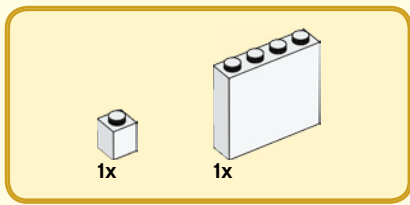

10

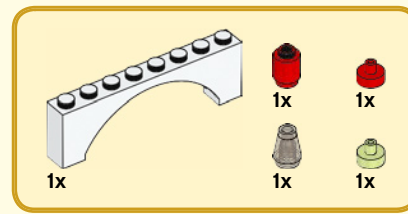
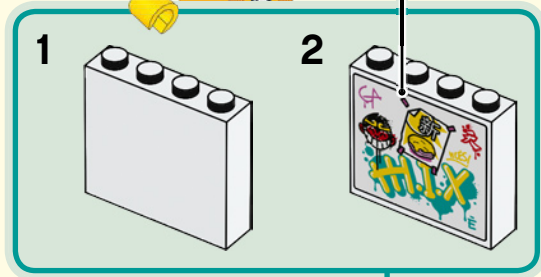

11

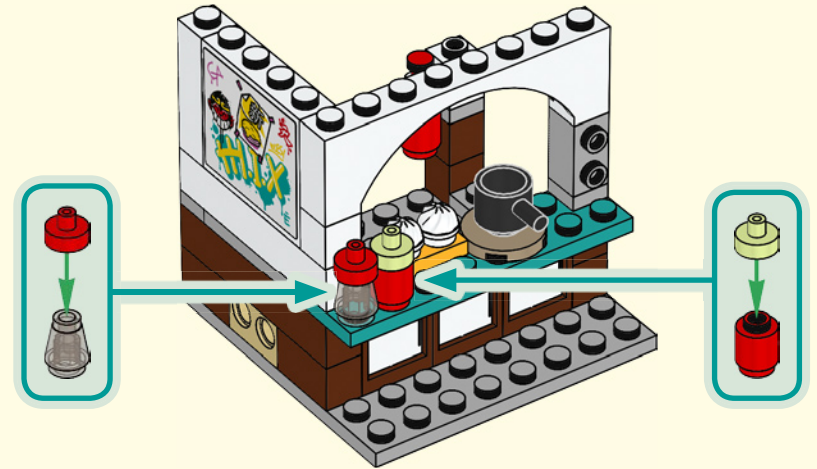

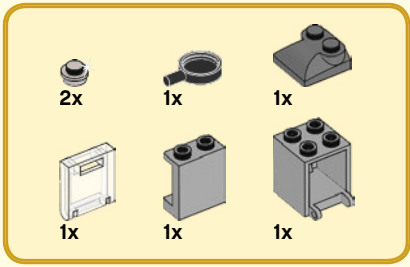

12

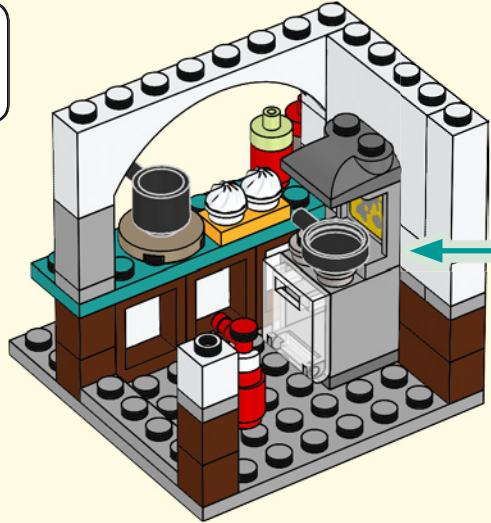
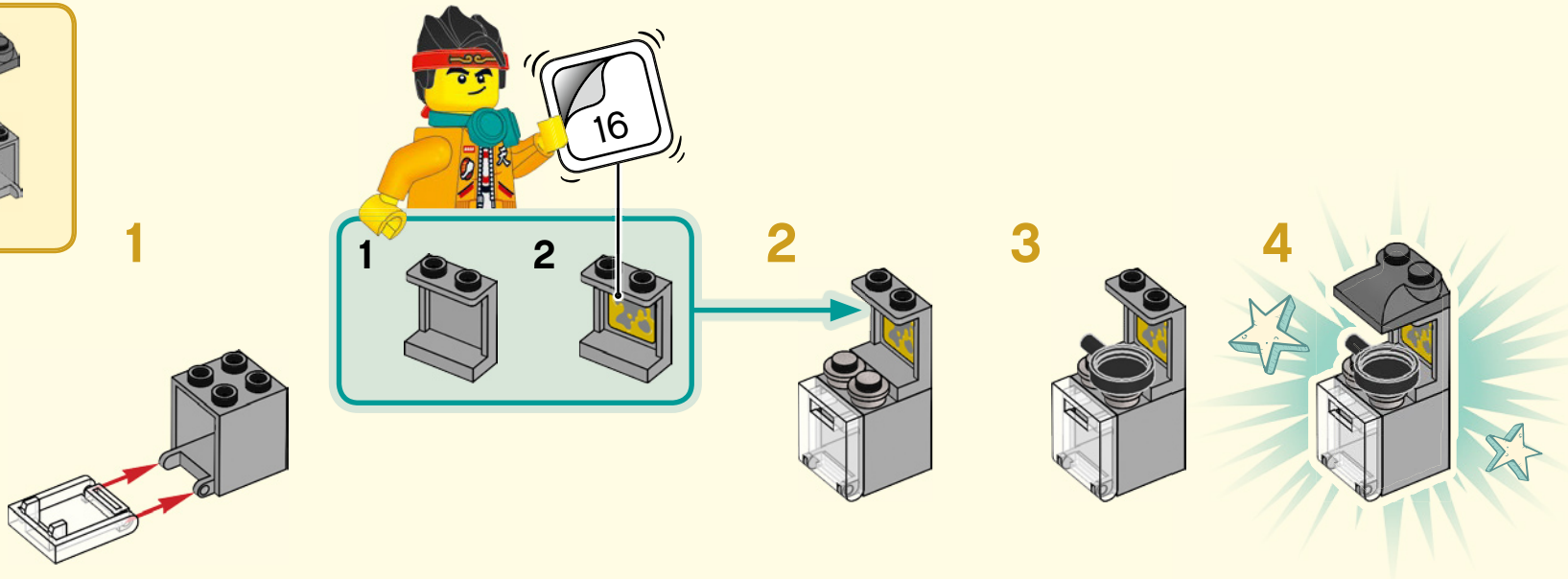

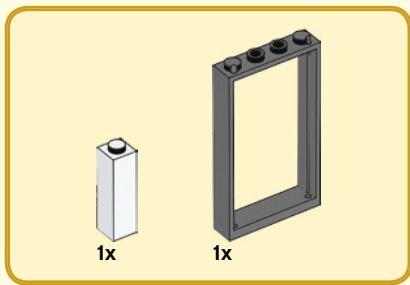

13

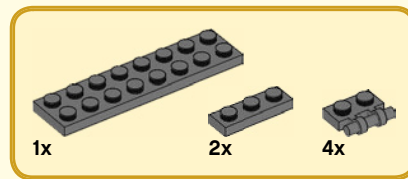
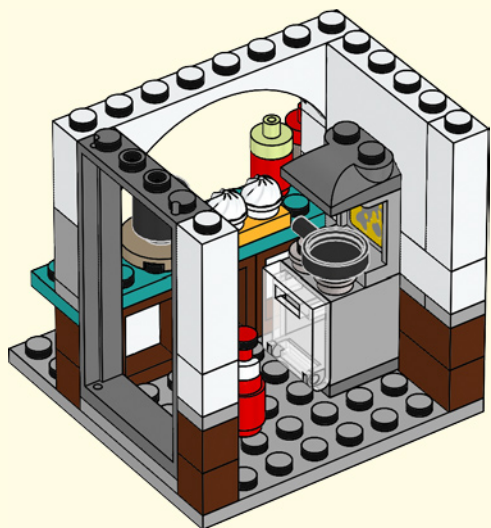

14

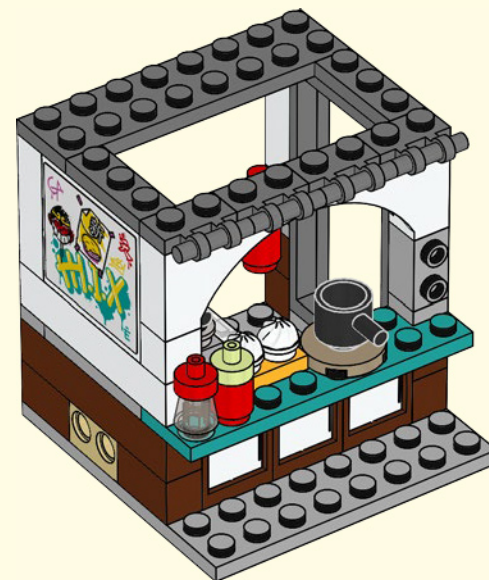

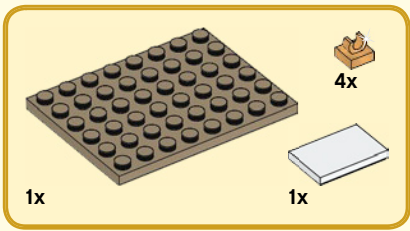

15

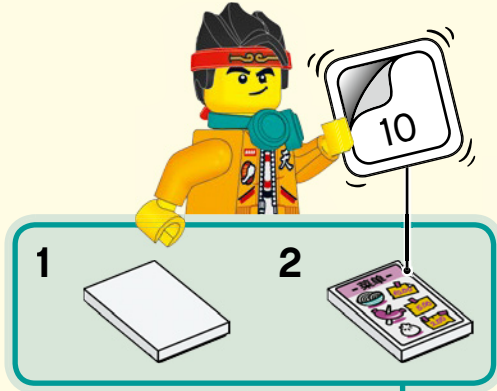

16

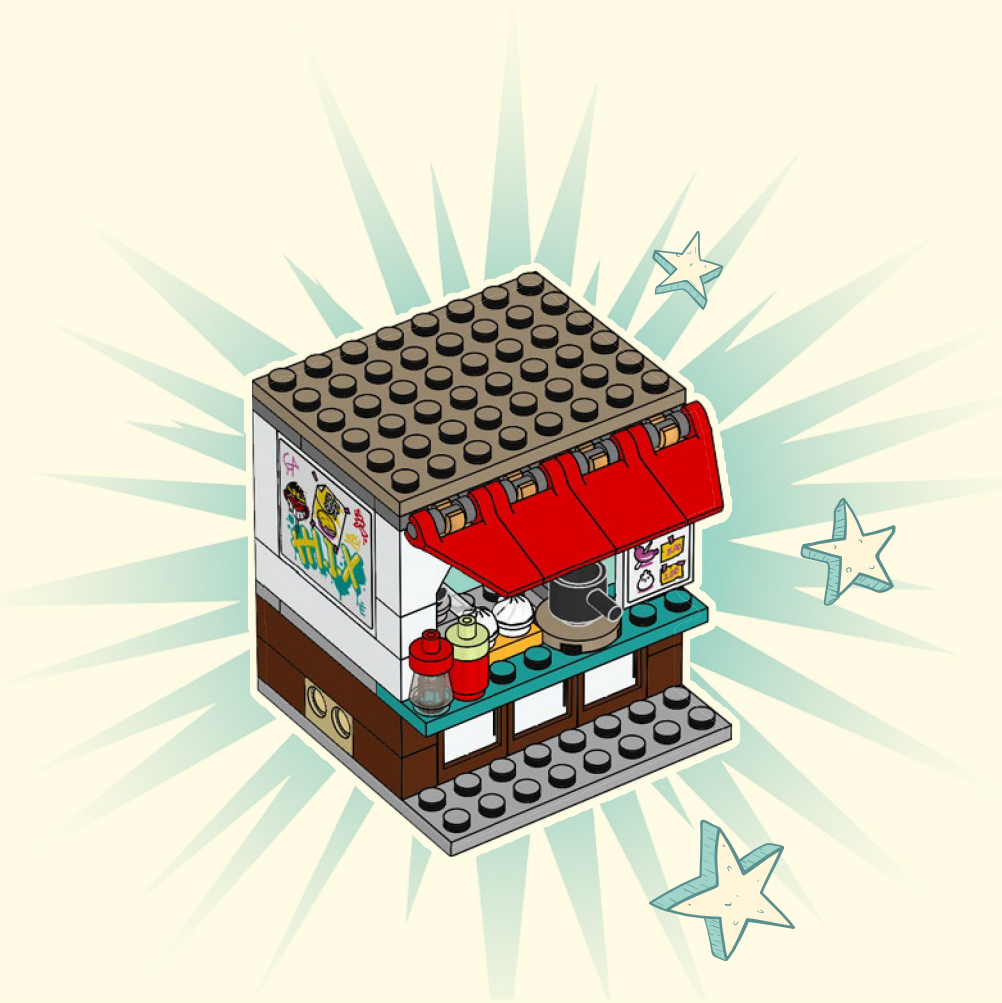

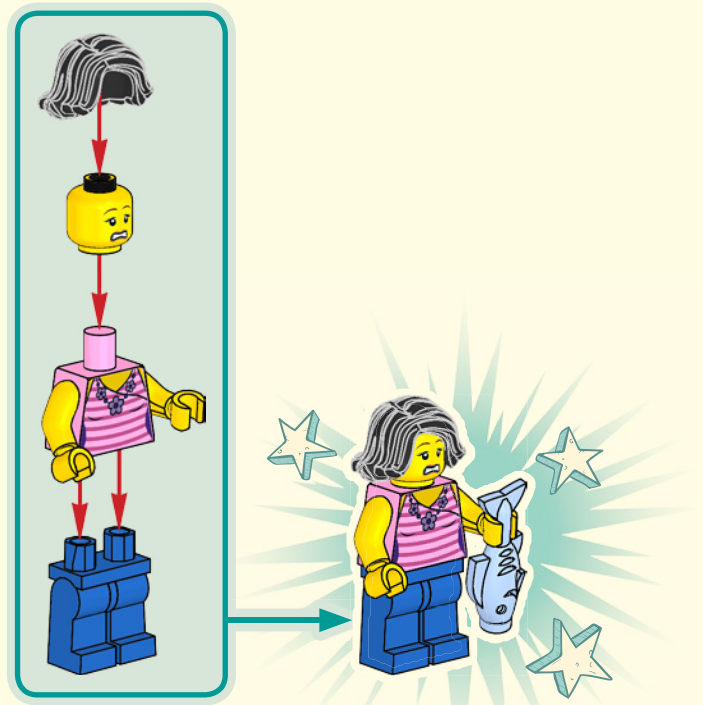
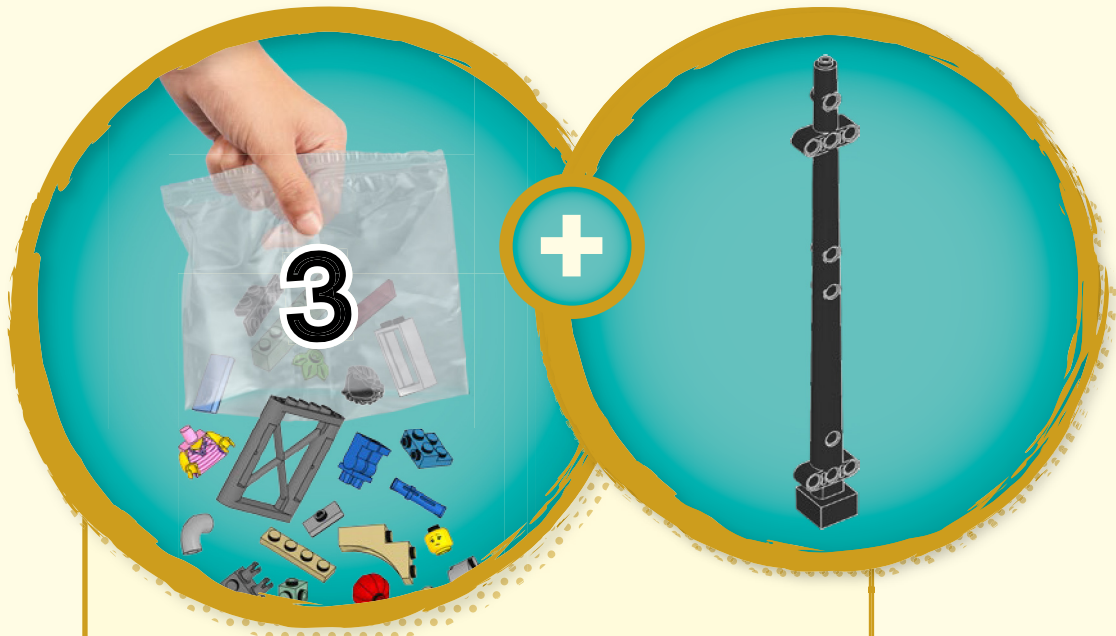

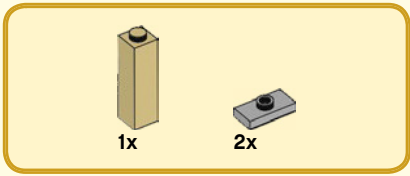

17



18



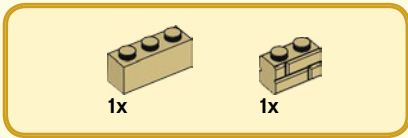

19

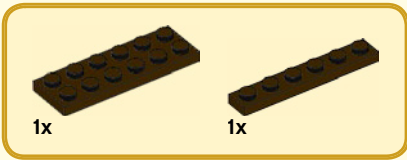

20





21

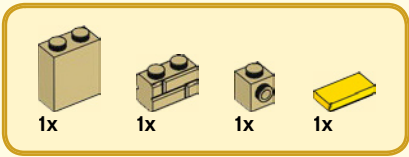
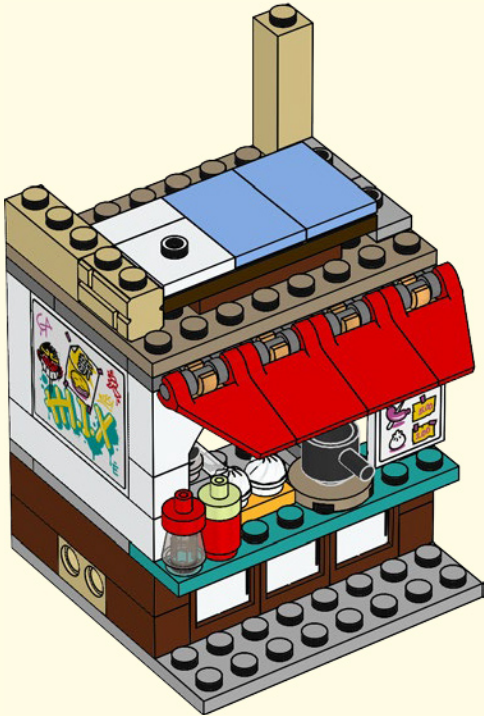

22

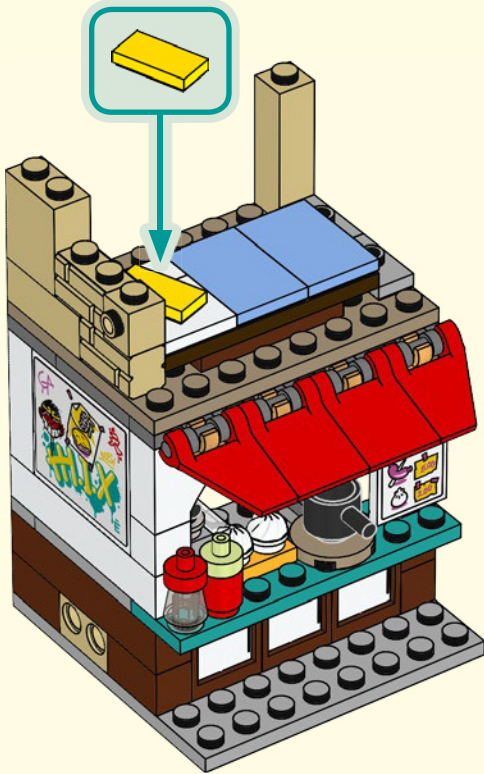

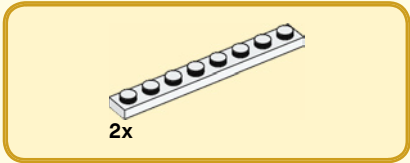

2x

23

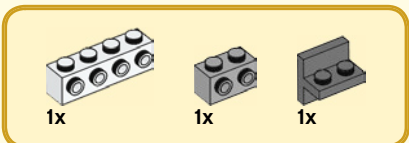
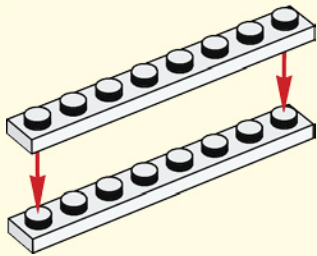

1x

1x

1x

24

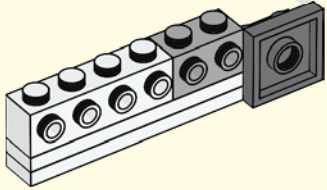
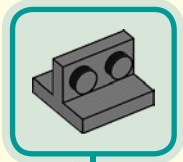



2x

25

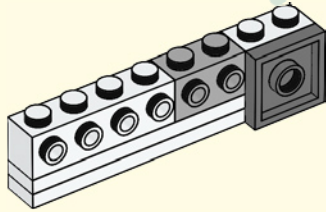
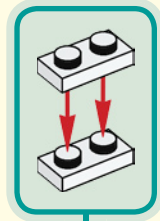

1x

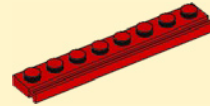

1x



1x



1x



1x

26

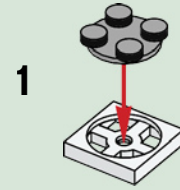

1

2

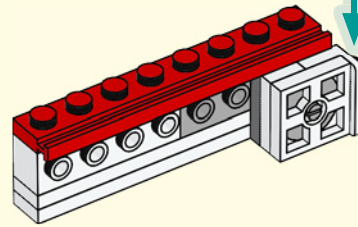



27

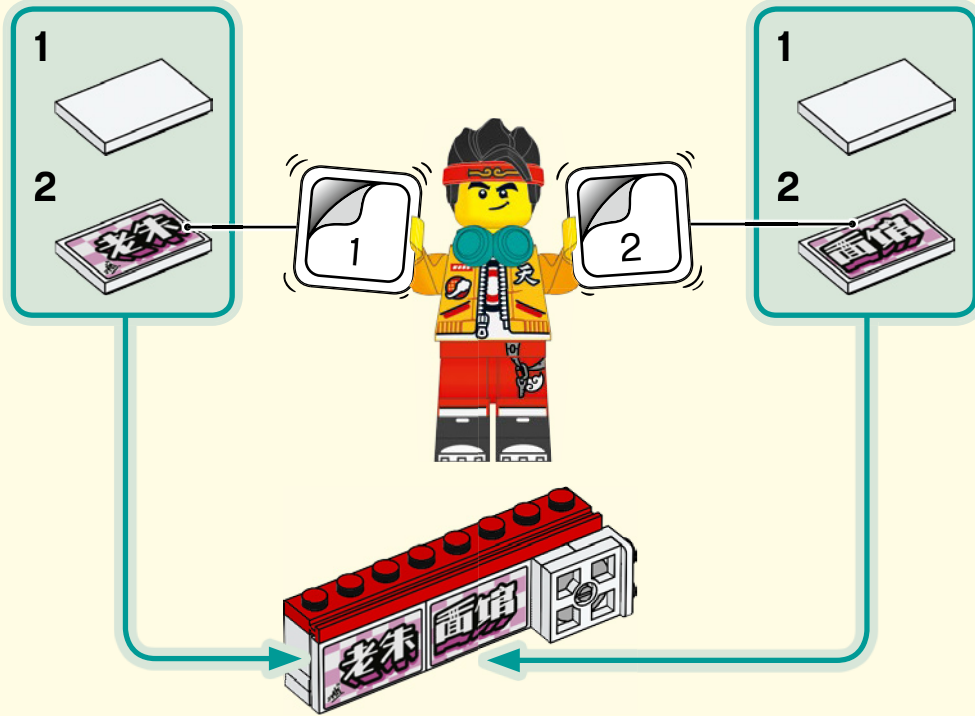

28

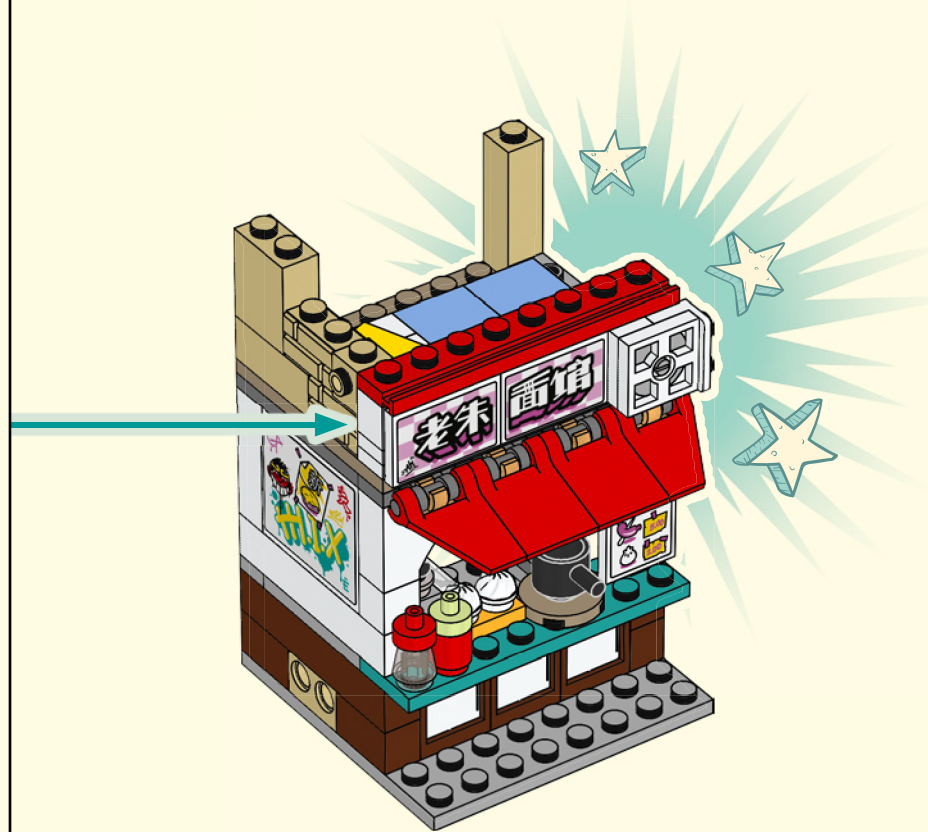

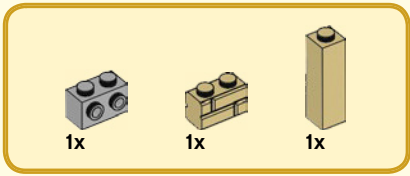

29

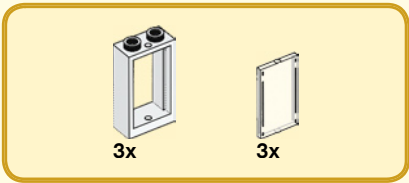
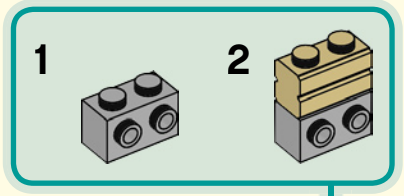

30

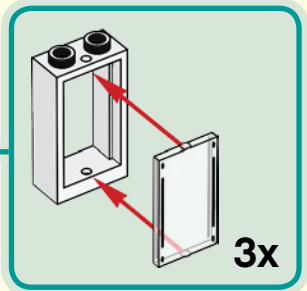

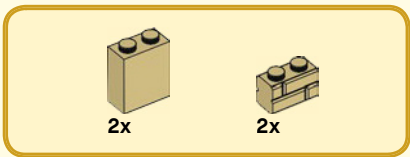

31

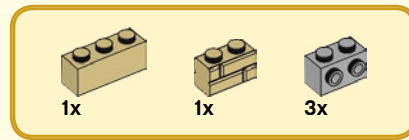
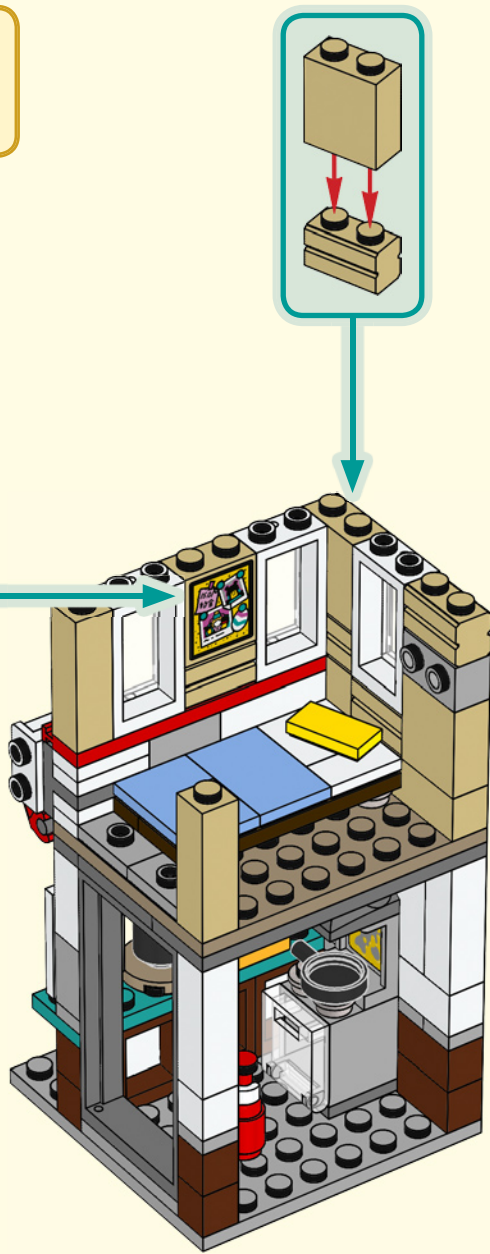
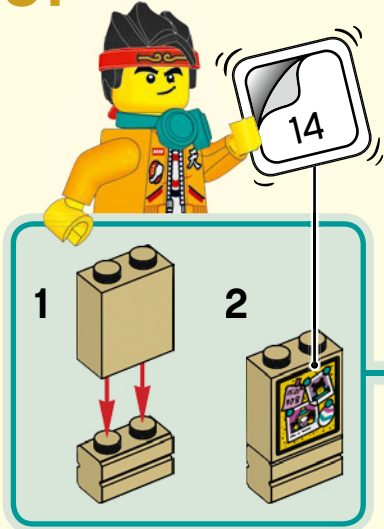

32

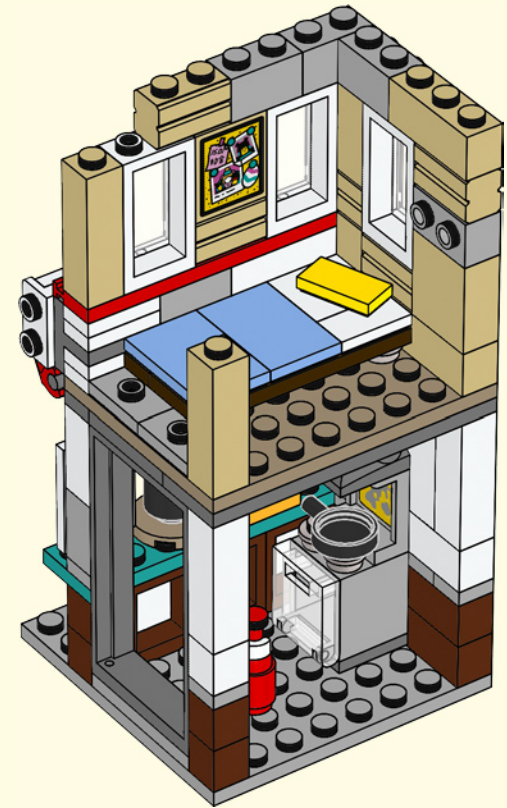

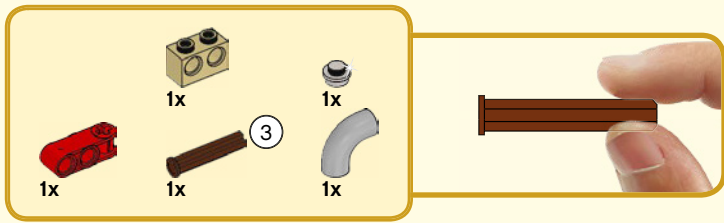

33

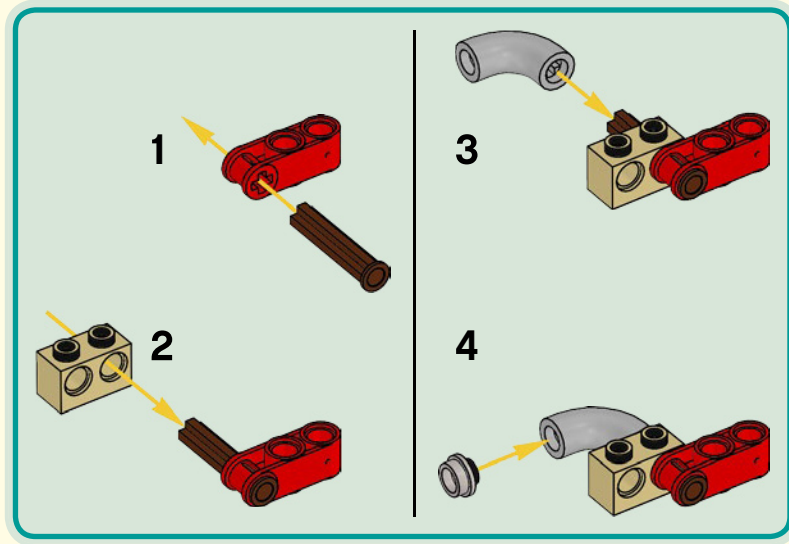

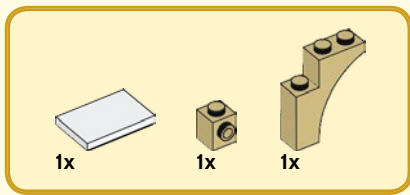

34

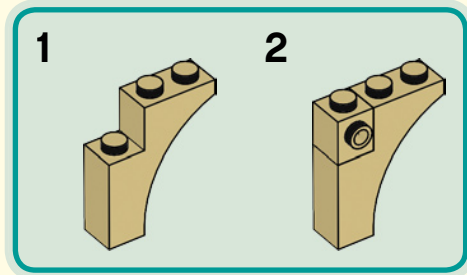
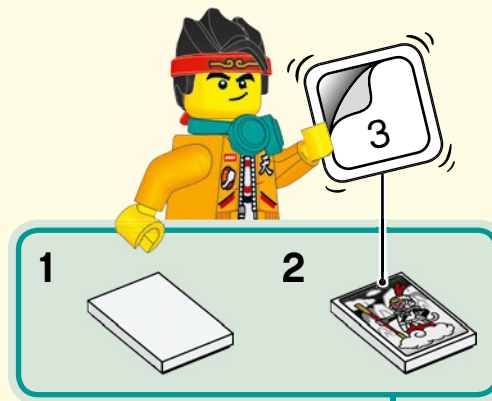

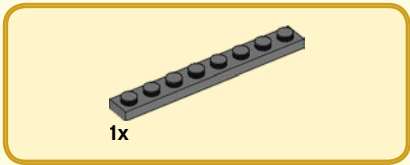

35



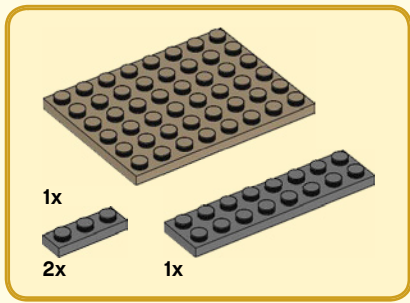

36

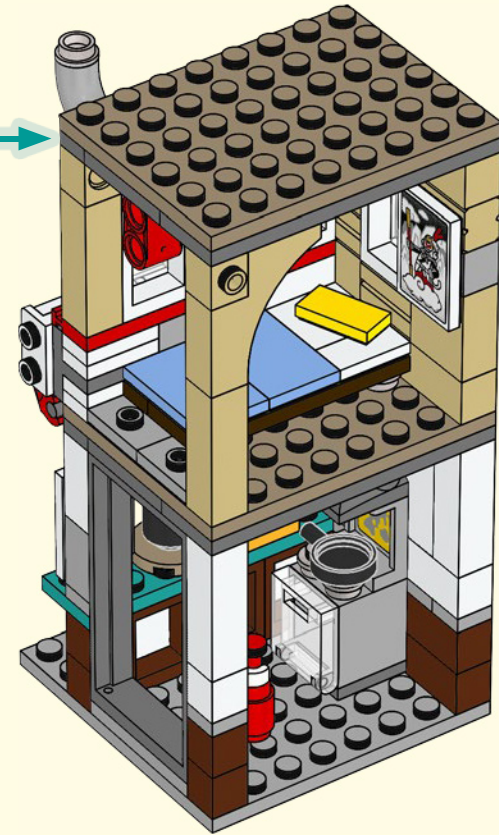
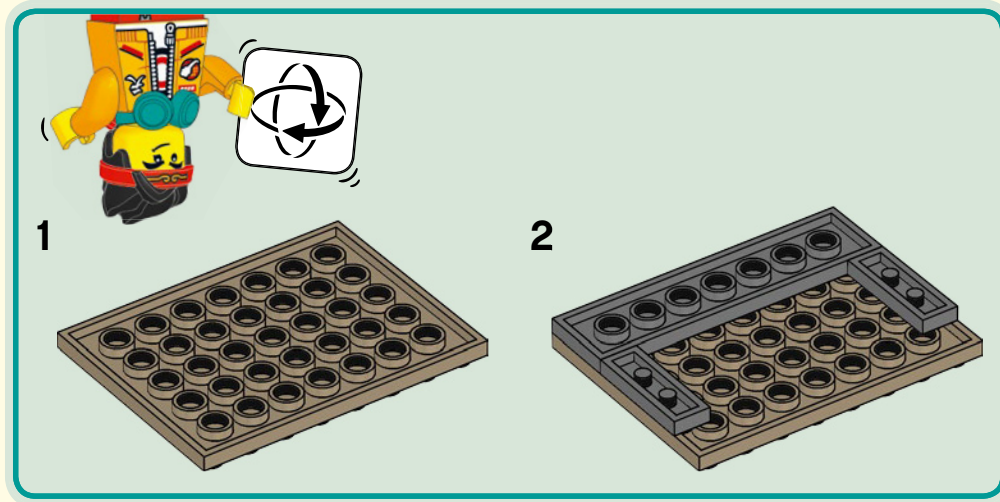

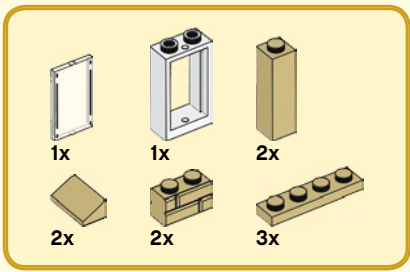

37

1

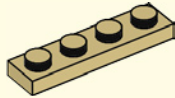

2

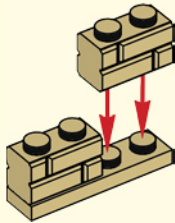

3

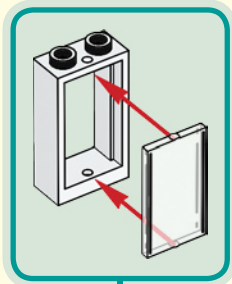
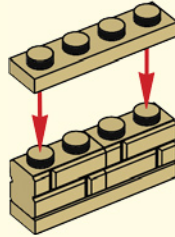

4

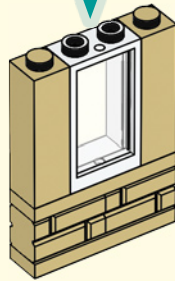

5

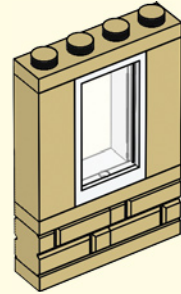

6

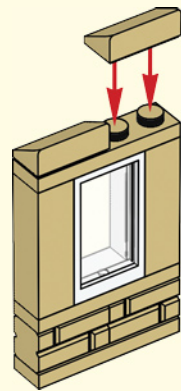

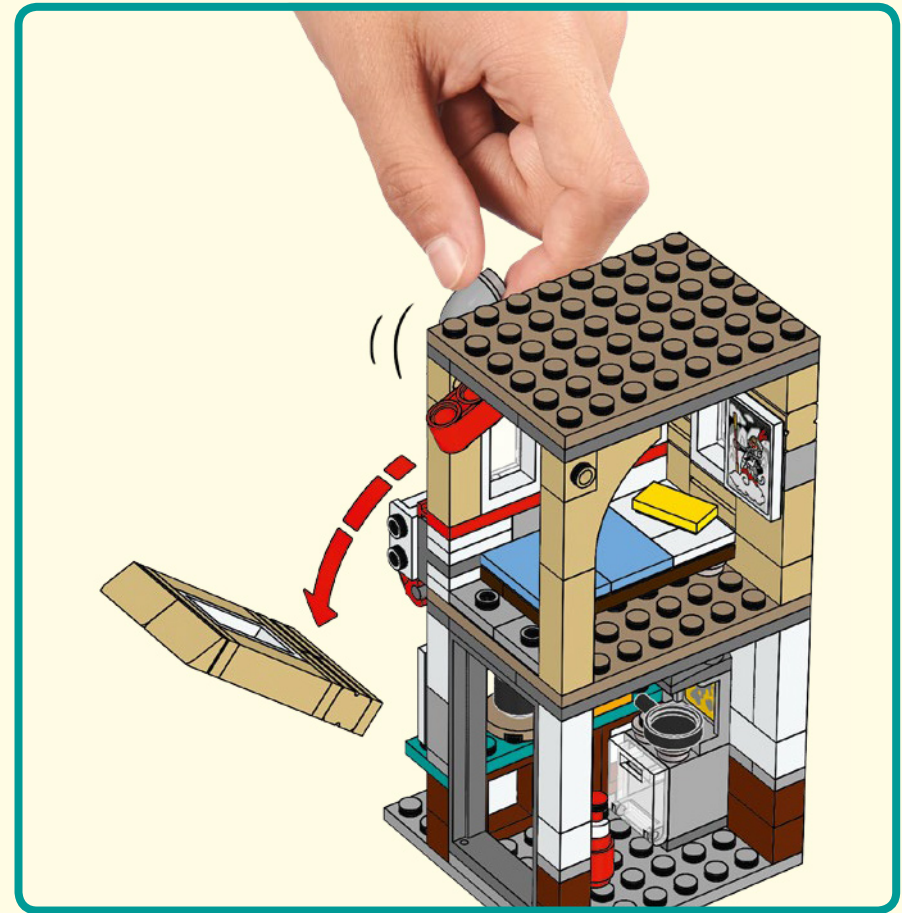
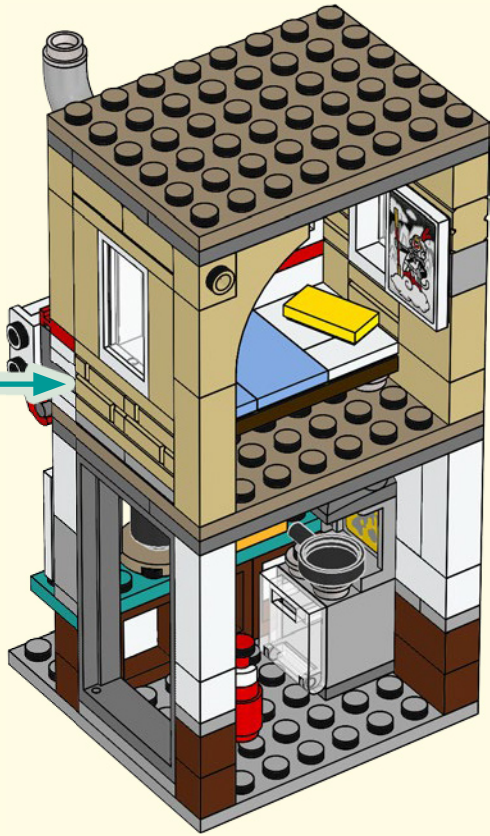

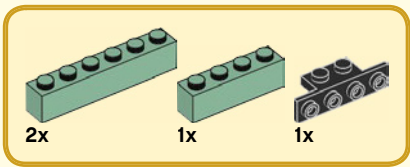

38

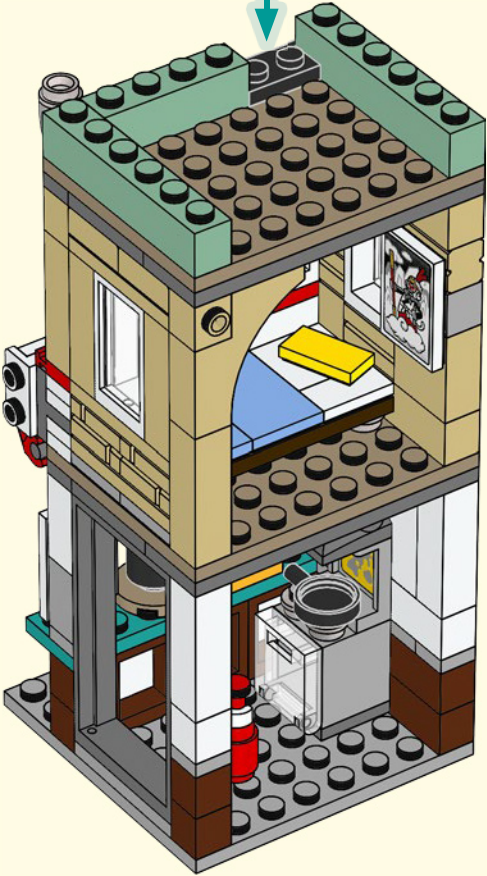
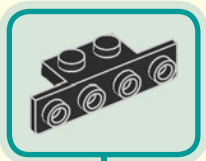

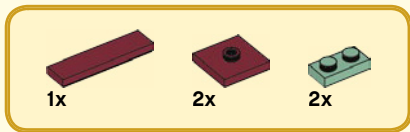

39

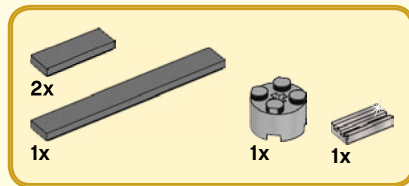
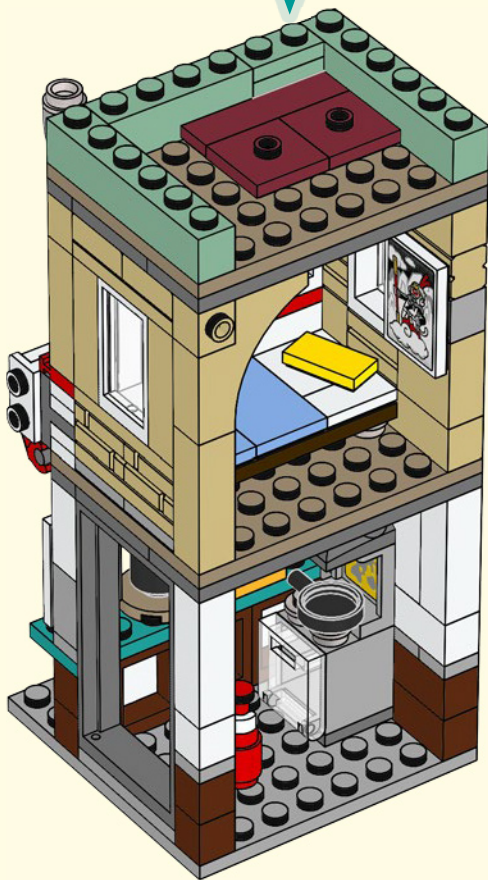
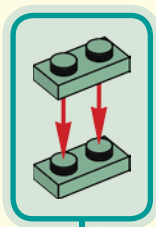

40

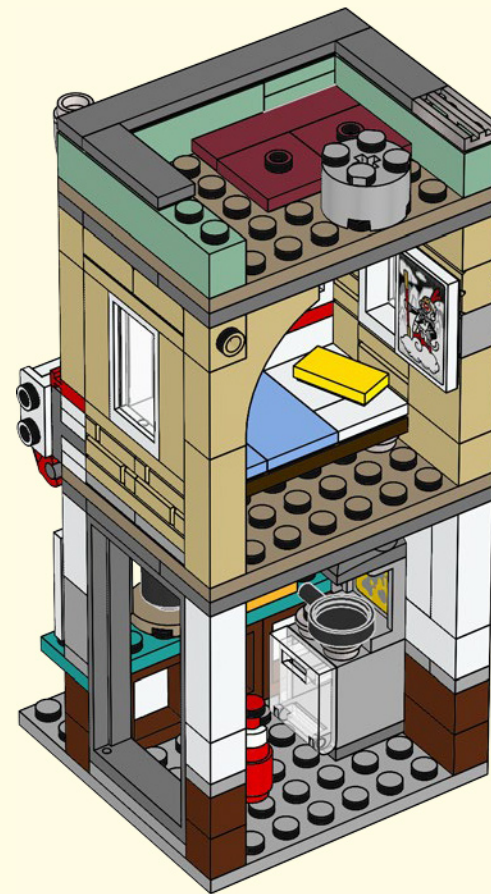

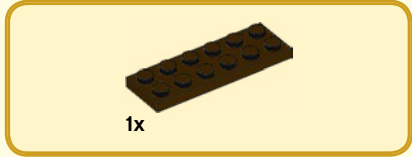

41

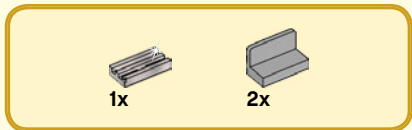
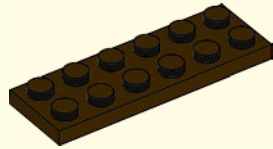

42

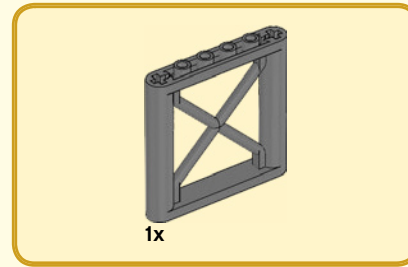
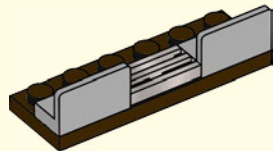

43

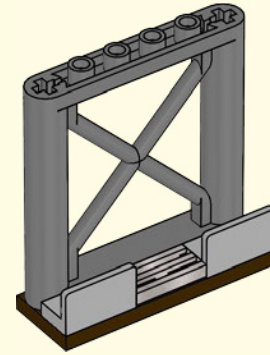

44

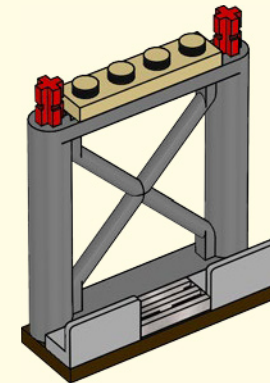



45

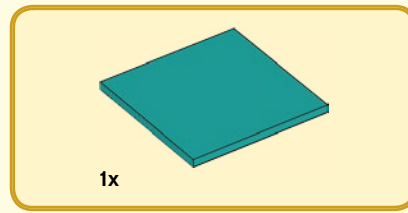
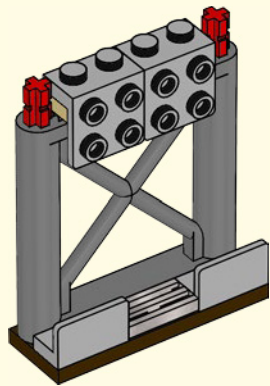

46

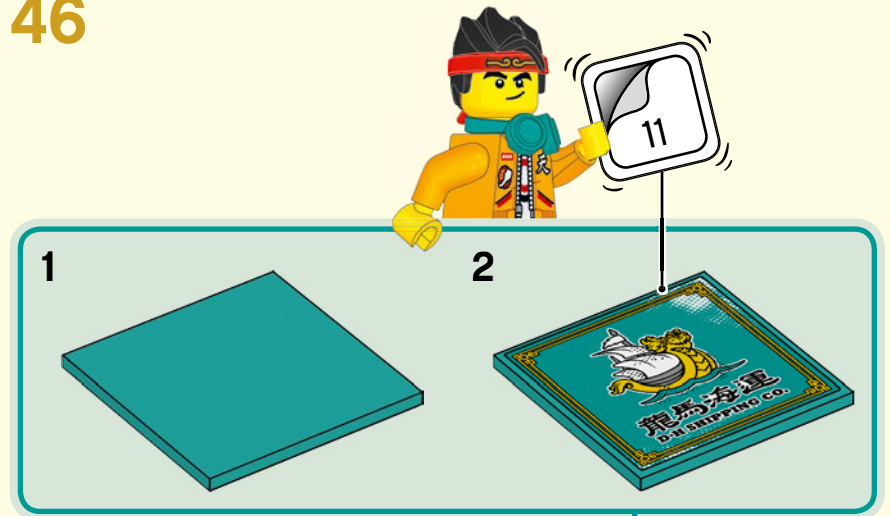



47

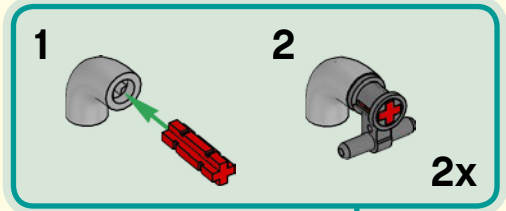

48

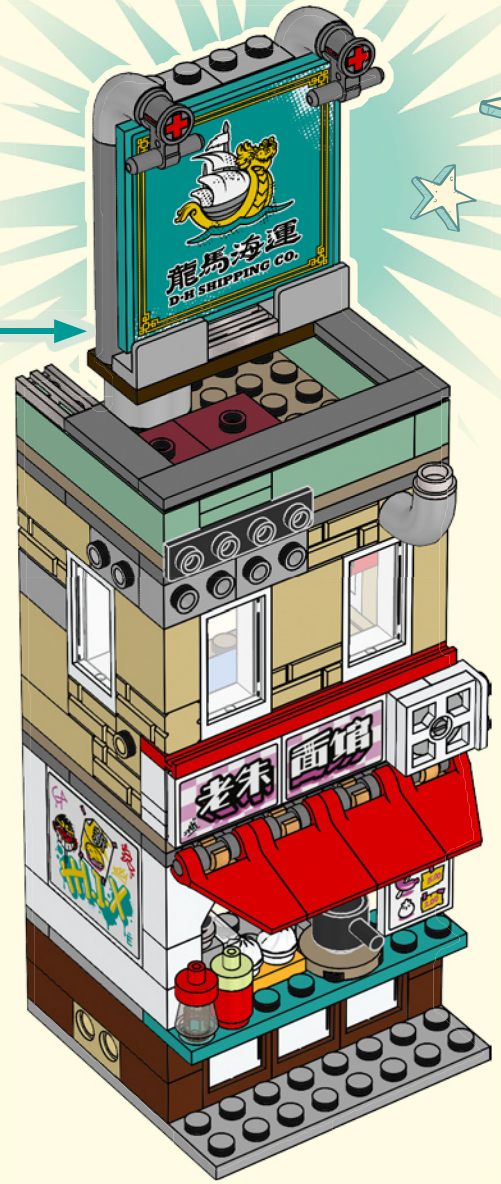



6x



2x



2x



1x



1x



2x



1x



4x

49

1

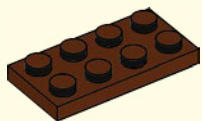

2

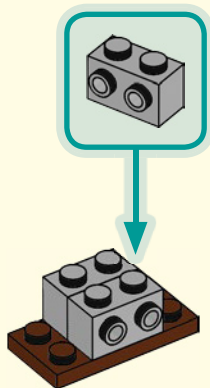

3

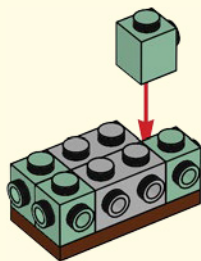

4

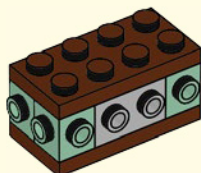

5

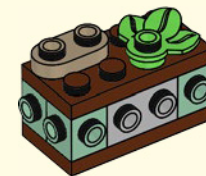

6

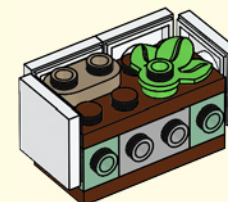

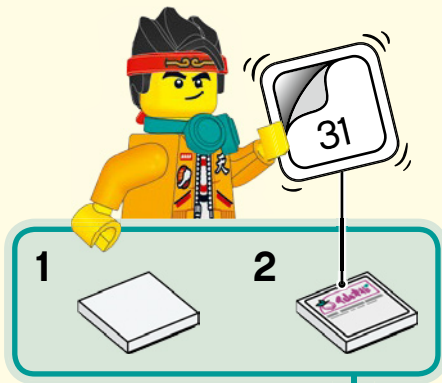

7



8

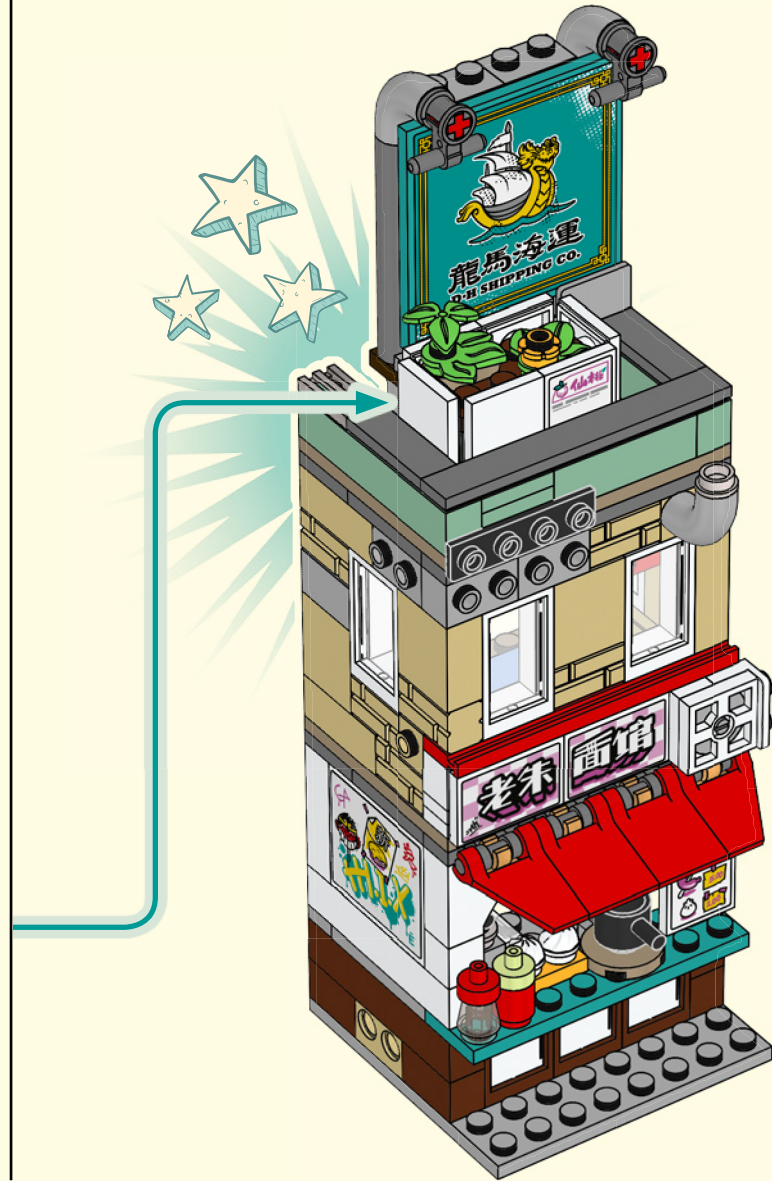
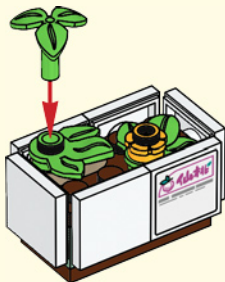



4x



1x

50

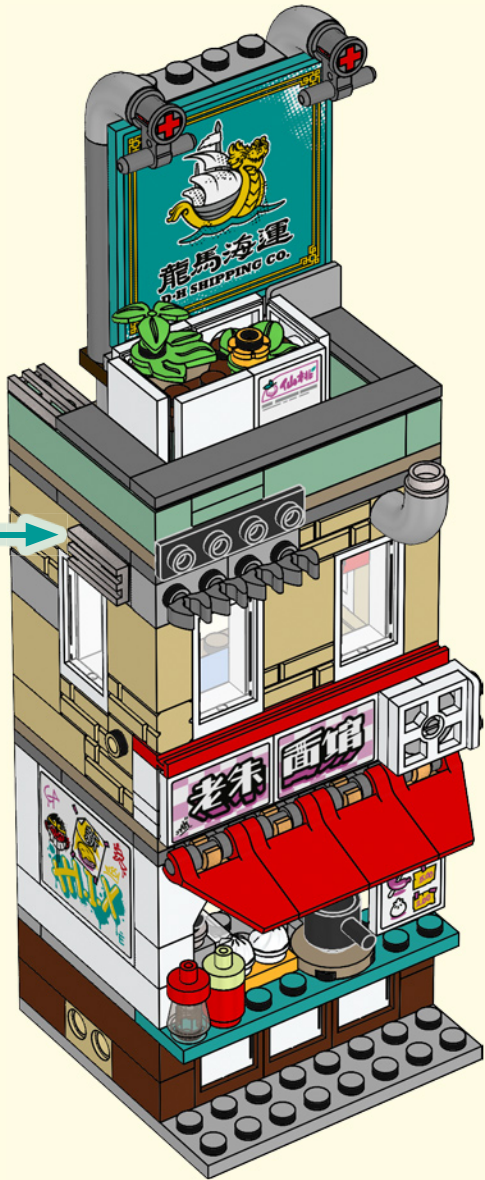
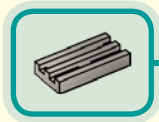

1x



3x

51

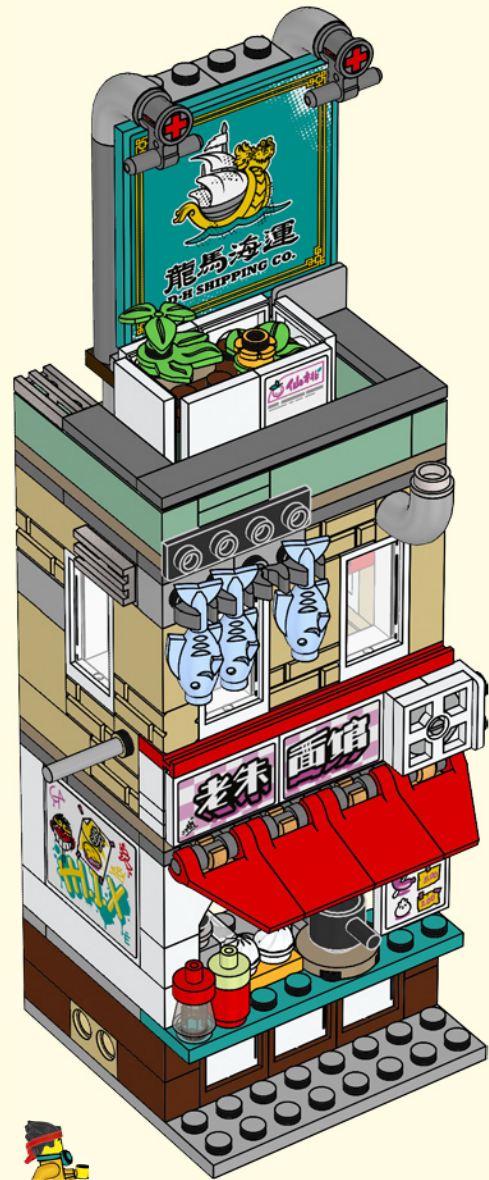



1x

52

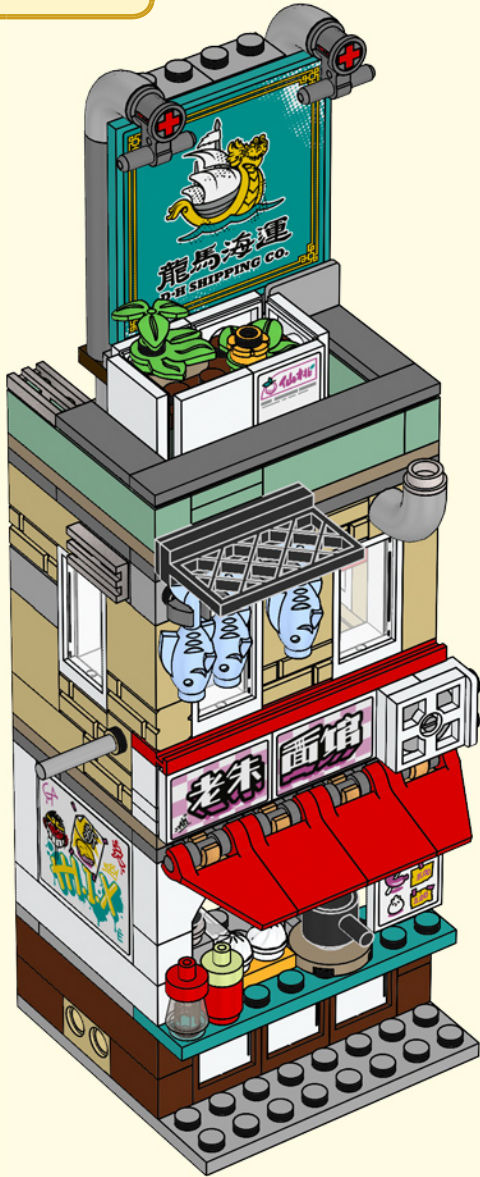

1x



1x



1x

53

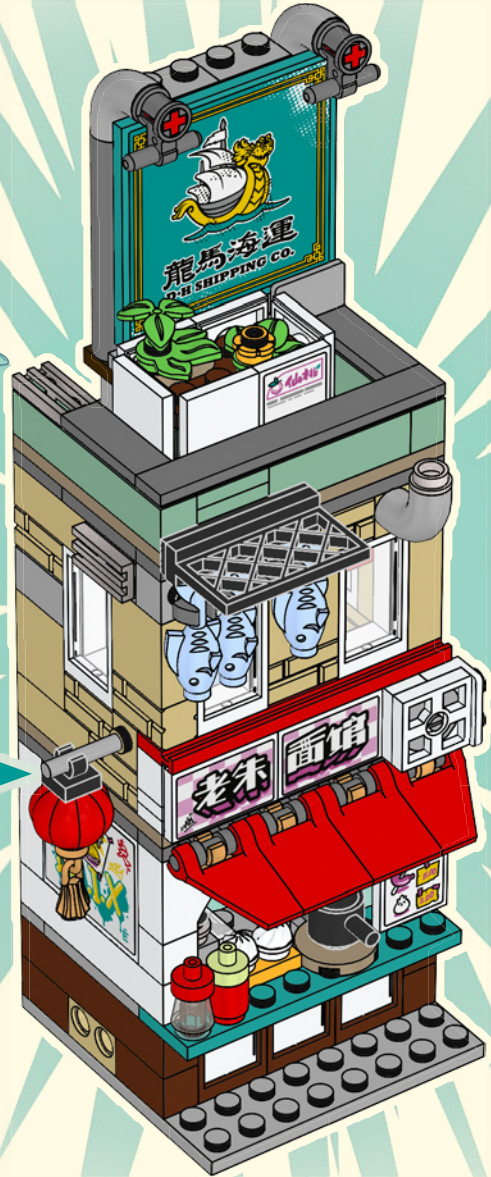
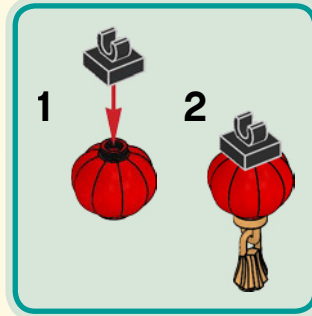

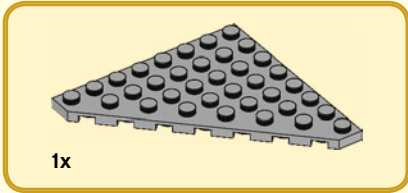
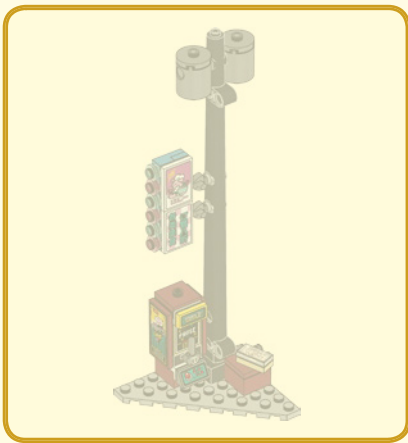

54

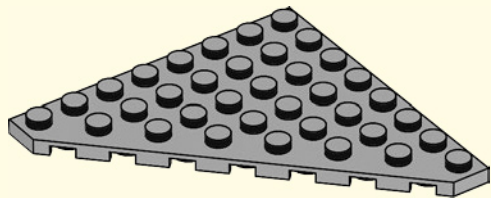

55

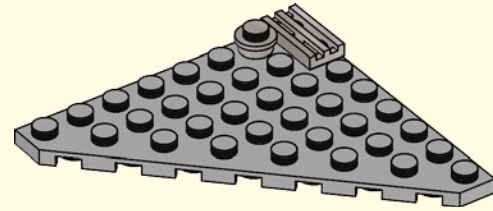

56

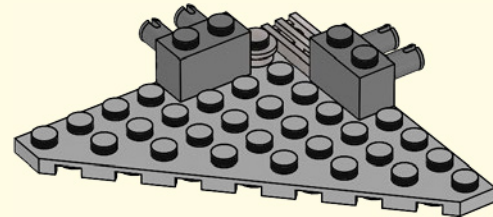



2x

57

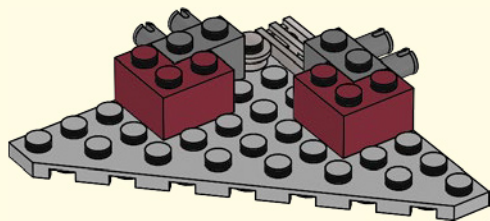

1x



1x



1x

58

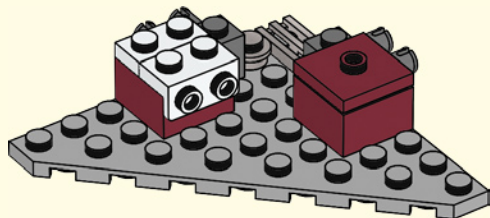

1x



1x



1x

59

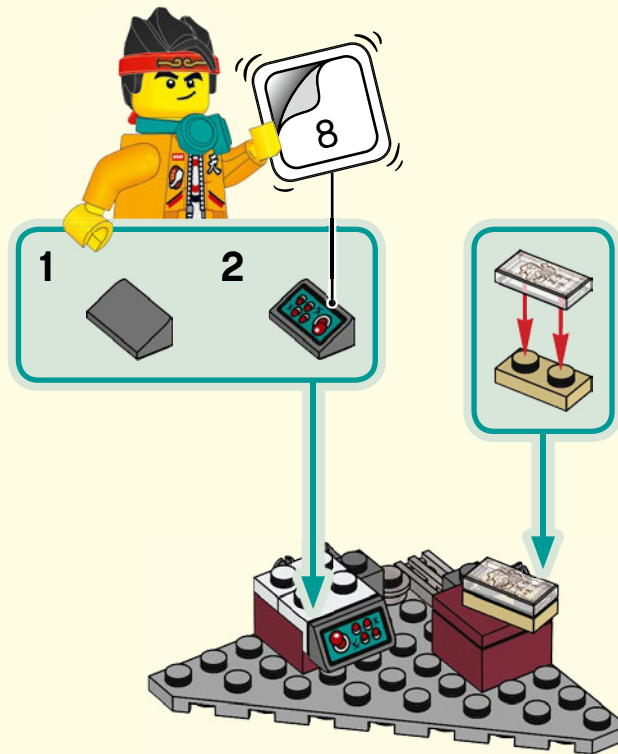

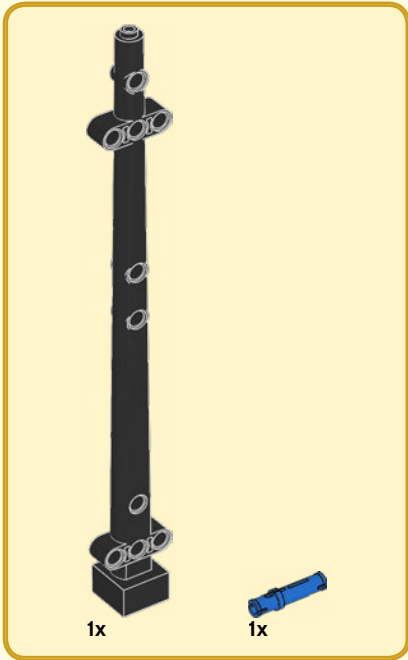
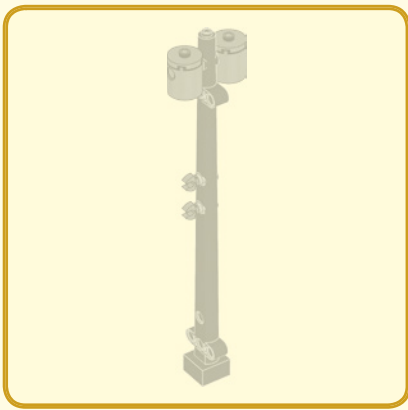

60

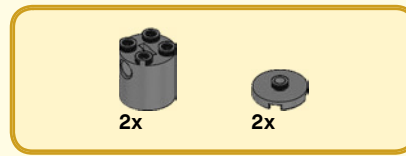

61

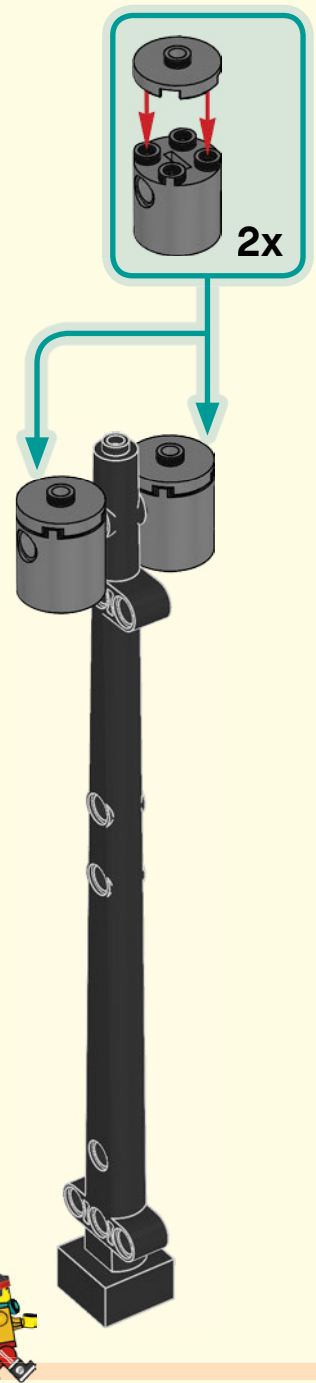



62

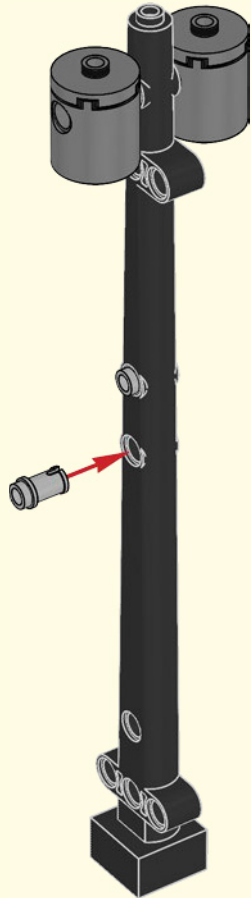

63

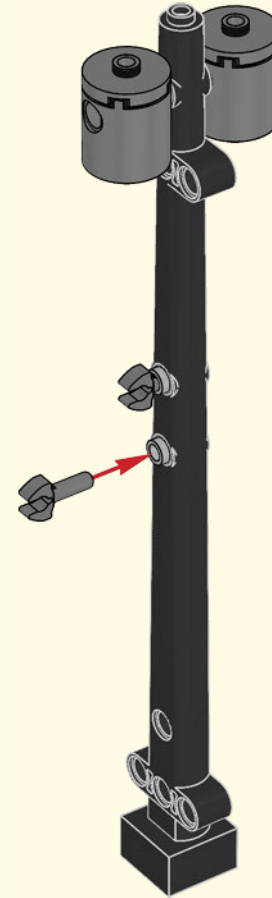

64

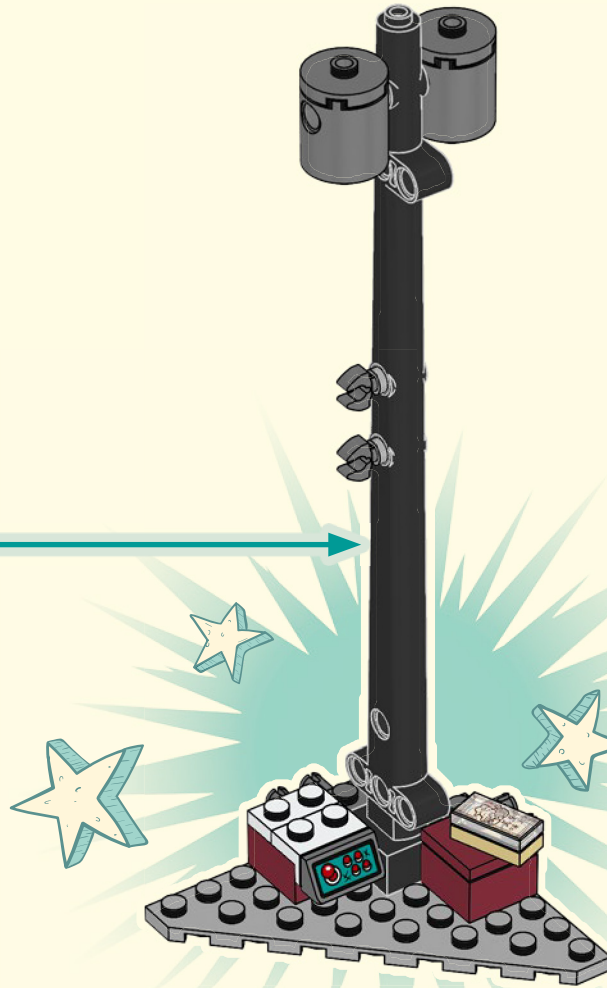



1x

65

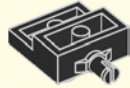

1x

66



2x

67

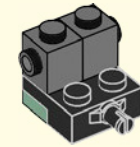
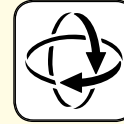

1x



1x



2x

68

1

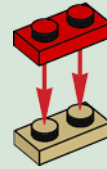

2

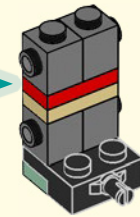
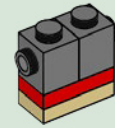

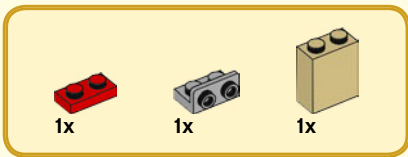

69

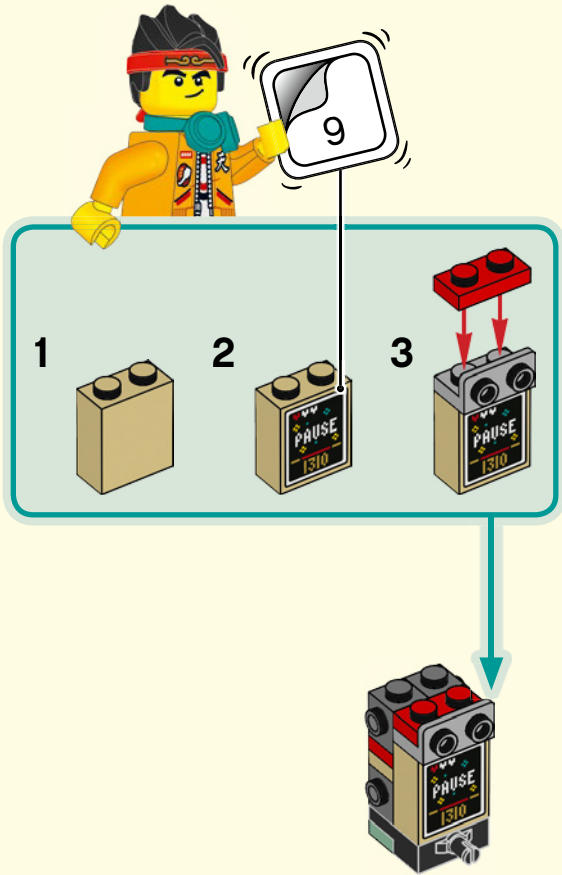

70

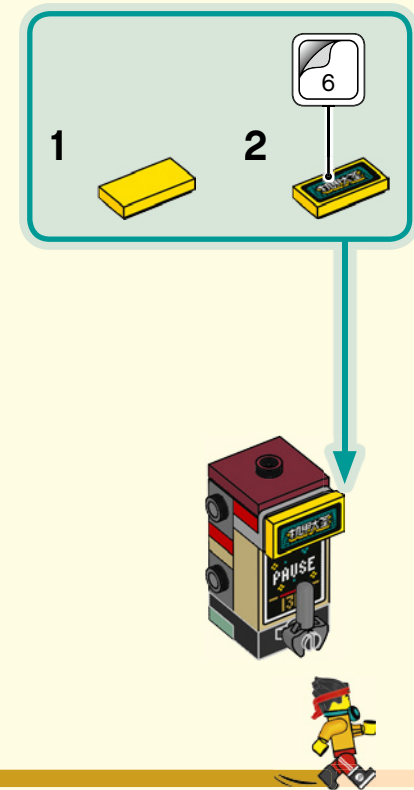

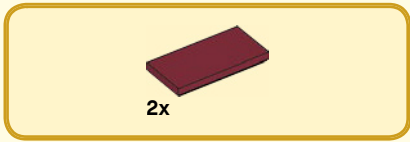

71

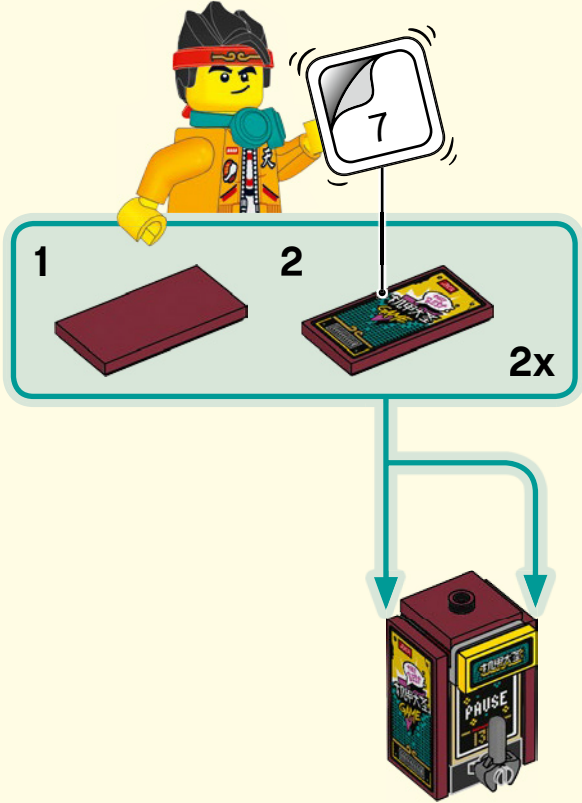

72

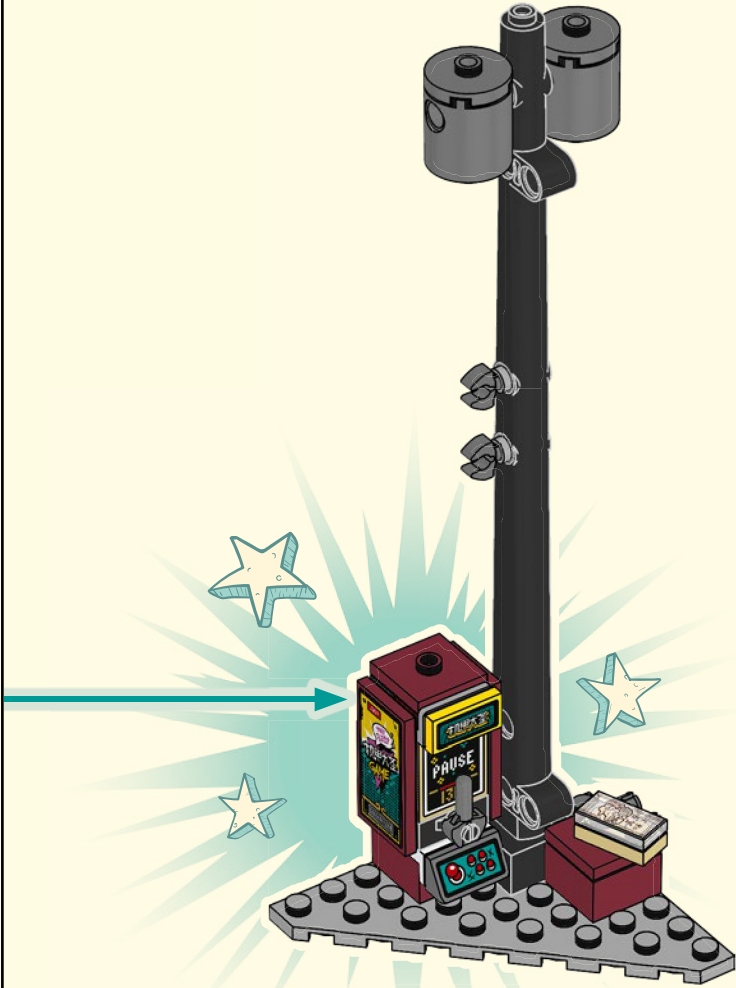

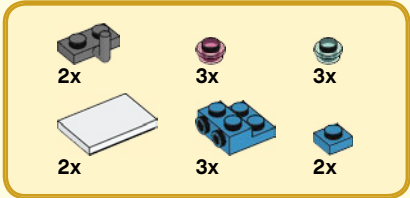

73

1

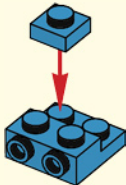

2

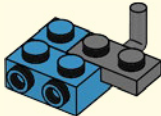

3

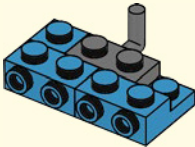

4

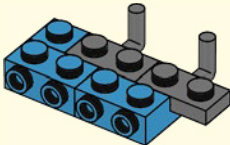

5

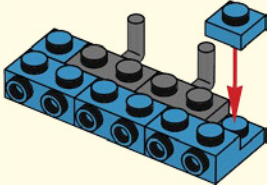

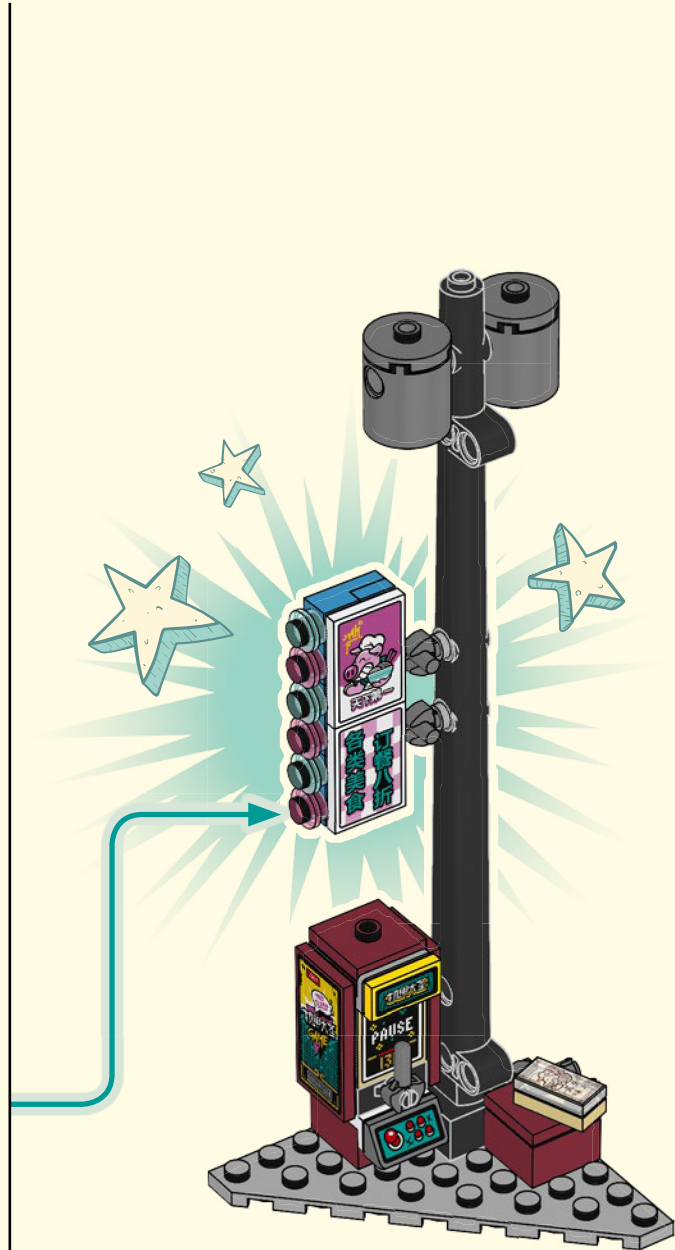
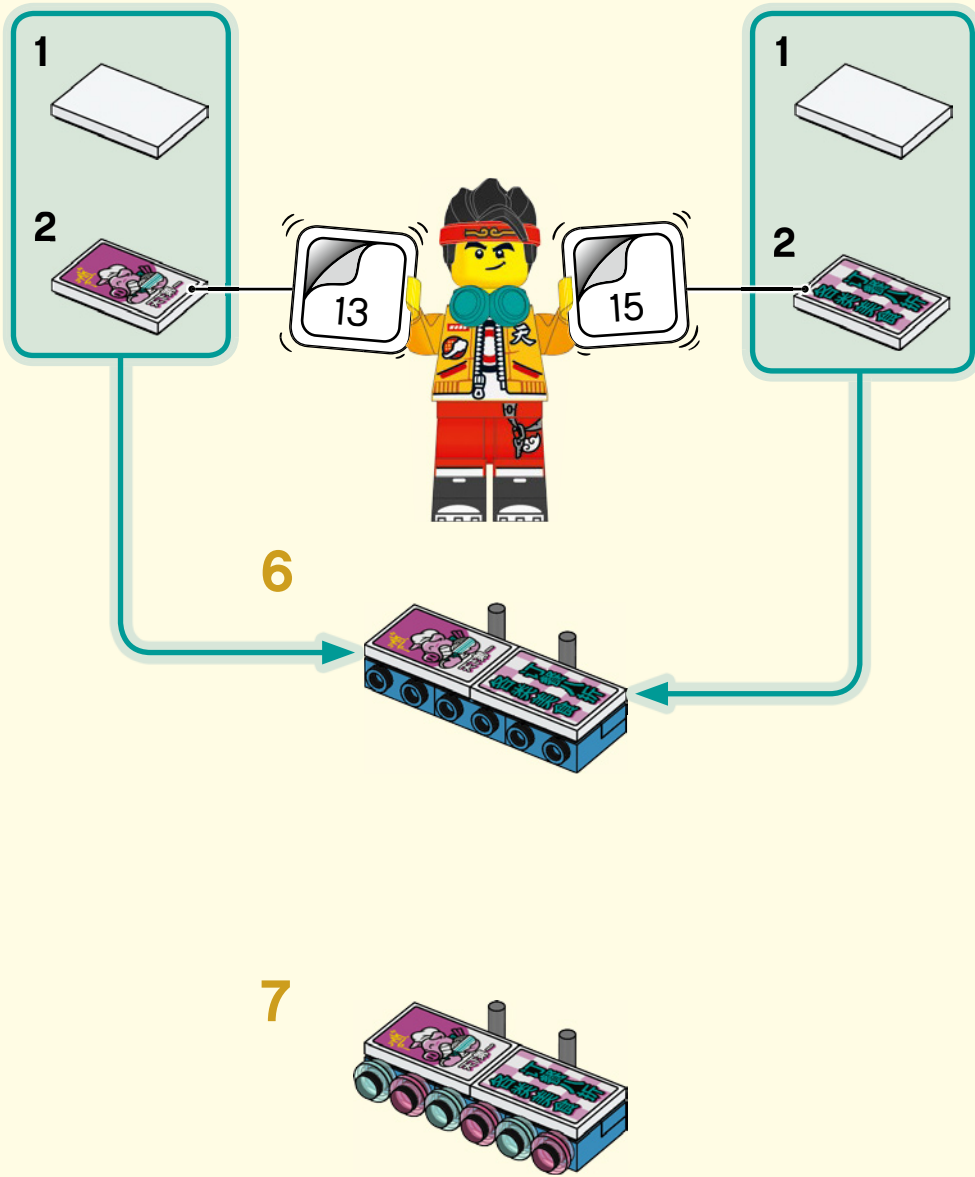

74

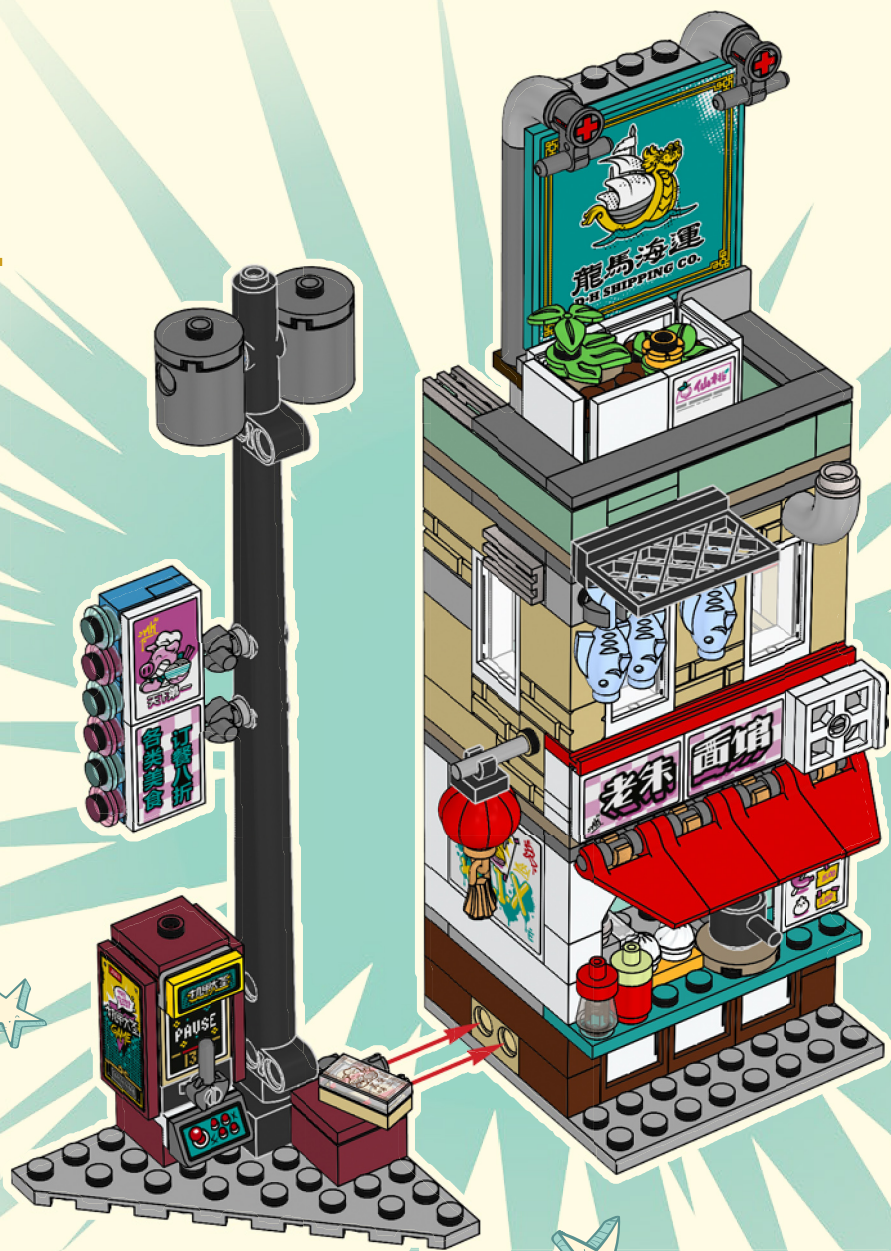



MONKIE KID 悟空小侠™





MONKIE KID 悟空小侠™



80009



80008



80007



80006



80013



80012



80011



80010

WIN

GO TO WWW.LEGO.COM/PRODUCTFEEDBACK AND
GIVE US YOUR SHORT **FEEDBACK** ABOUT THIS
LEGO® SET FOR A CHANCE TO WIN
A COOL LEGO PRIZE.

Terms & Conditions apply

LEGO.com/productfeedback



GEWINNE

Erzähle uns auf
www.LEGO.com/productfeedback

etwas über die Erfahrungen, die
du mit diesem LEGO® Set gemacht
hast, und sichere dir die Chance
auf einen coolen LEGO Preis!

Es gelten die
Teilnahmebedingungen

GAGNE

Rends-toi sur
www.LEGO.com/productfeedback

et donne-nous quelques com-
mentaires sur ce produit LEGO®
pour avoir une chance de gagner
un prix LEGO !

Voir Conditions Générales

GANAN

Visita
www.LEGO.com/productfeedback

y envíanos tu opinión acerca de
este set LEGO®. ¡Participarás en el
sorteo de un premio LEGO!

Términos y Condiciones aplicables

获取奖品

登录
www.LEGO.com/productfeedback

给出关于此乐高®套装的简短反馈，
就有机会获得炫酷乐高奖品

《条款及条件》适用

경품 당첨 기회

www.LEGO.com/productfeedback

페이지로 이동하여 이 레고® 세트에
대한 간략한 피드백을 보내 주시고
멋진 레고 경품을 탈 수 있는 기회도
잡으십시오

약관 적용

ЗАПОЛНИ АНКЕТУ И ПОЛУЧИ ПРИЗ

Перейди по ссылке
www.LEGO.com/productfeedback

ответь всего на несколько во-
просов об этом наборе LEGO®,
и у тебя появится шанс выиграть
замечательный приз от компании
LEGO.

Применяются Условия и правила
участия