



NEXO KNIGHTS



70361







1

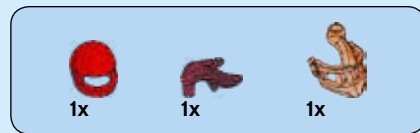

2



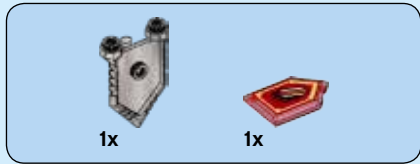

3



4

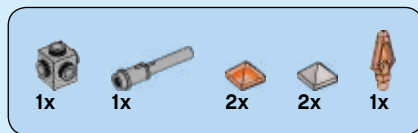

4

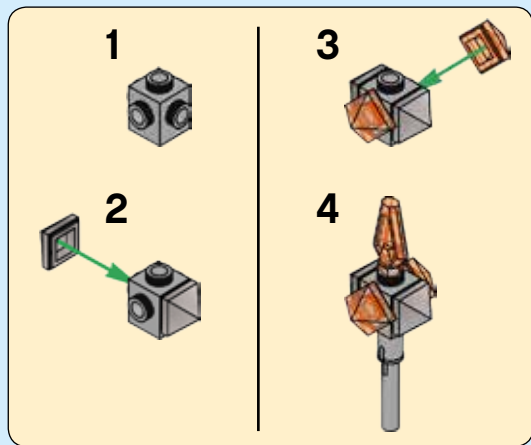



2x



1x

1

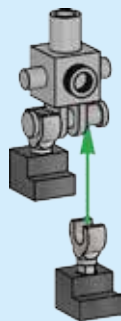

1x



1x

2

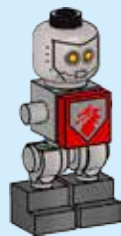



2x



2x

3

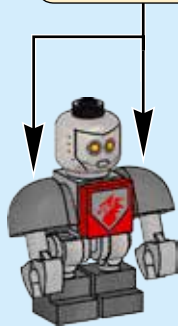
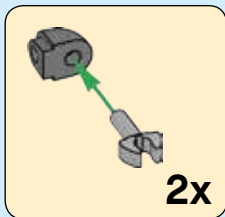

1x



1x



1x

4

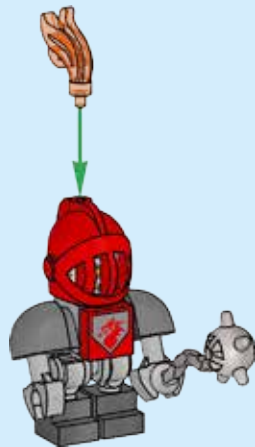

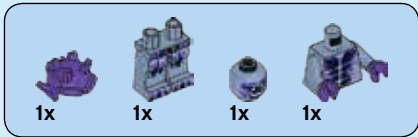

1

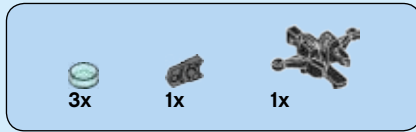
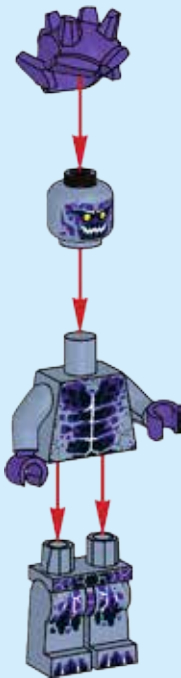

2

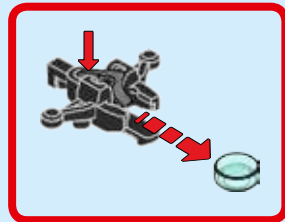
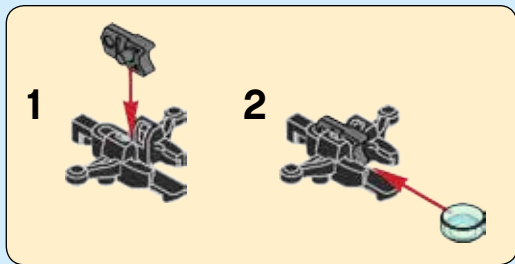



3

1



2

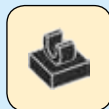

3

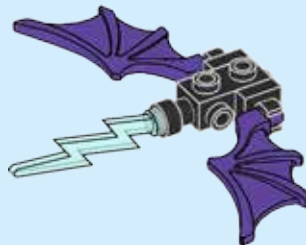



1

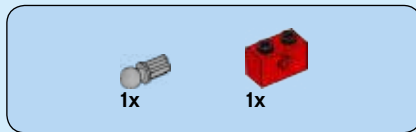
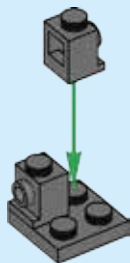

2

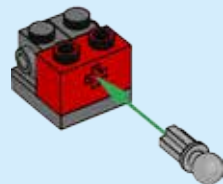



2x

3

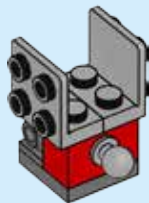

1x



1x

4

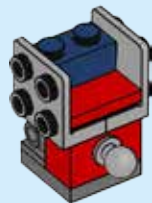



2x



2x

5

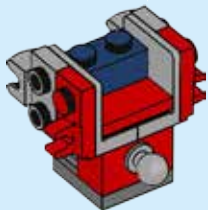

2x

6

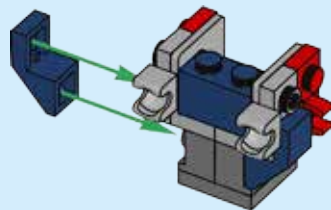
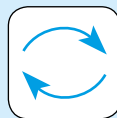



7

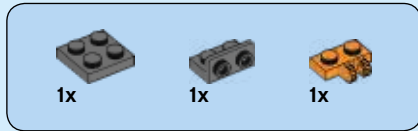
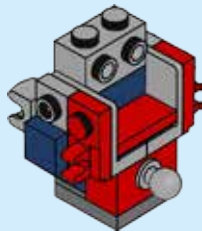
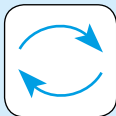

8

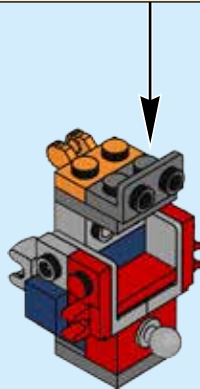
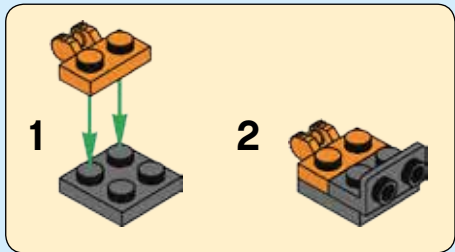

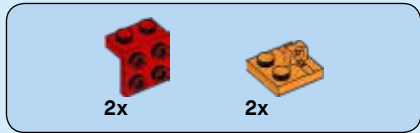

9

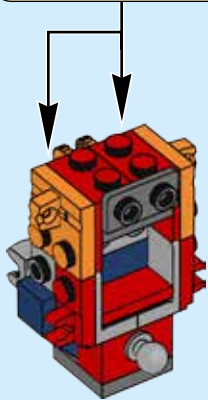
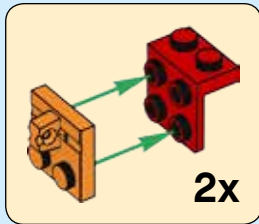

10

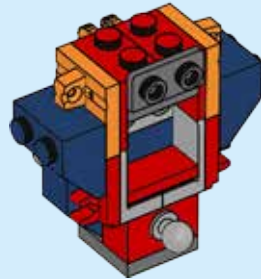



2x

11

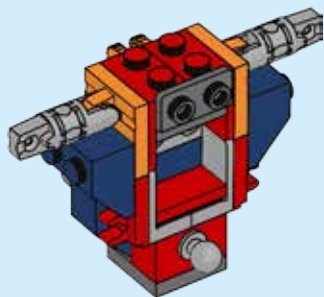

2x

12

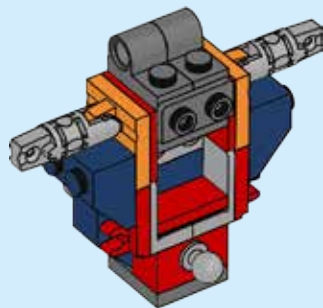



2x



1x

13

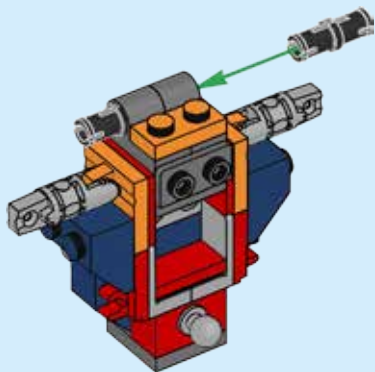

16



1x

14

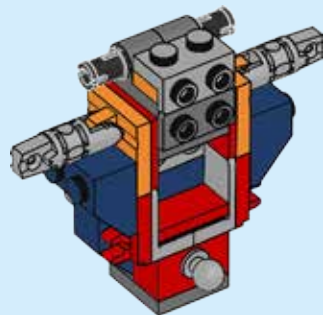



15

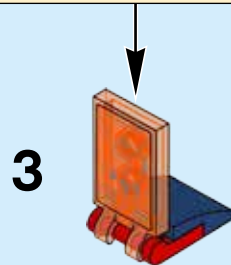
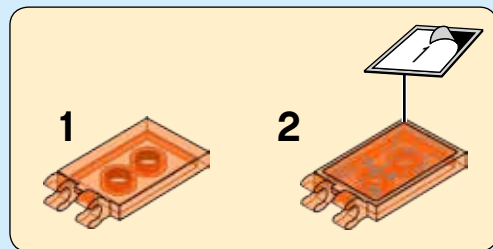

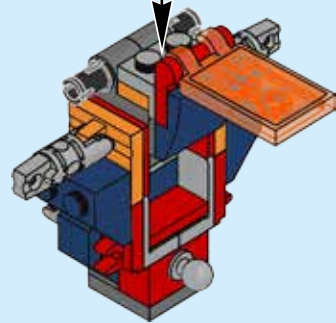

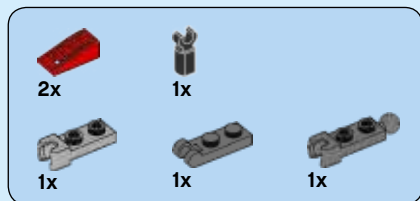

16

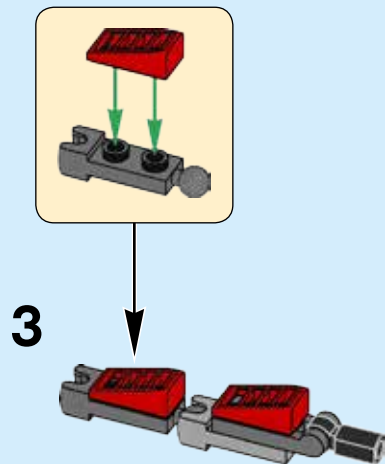
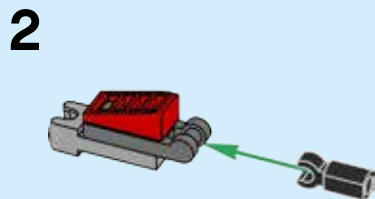
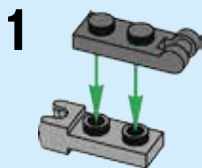

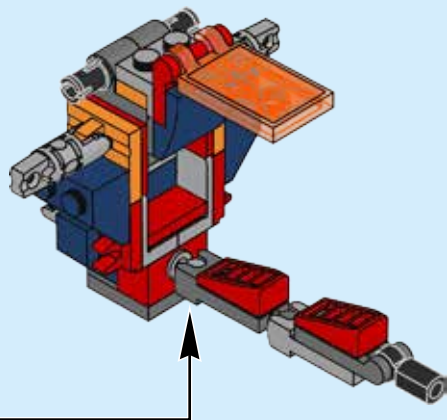

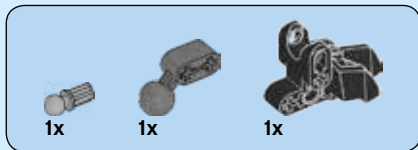

17

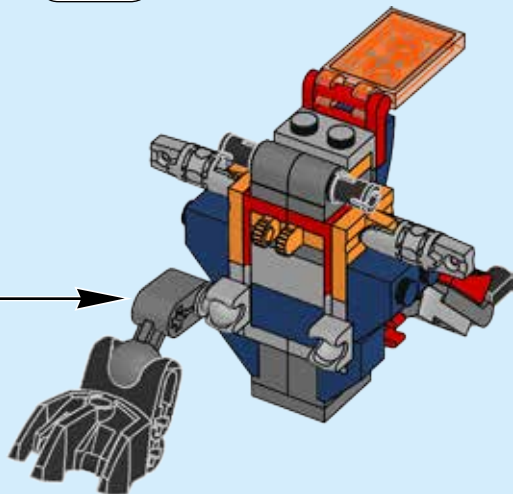
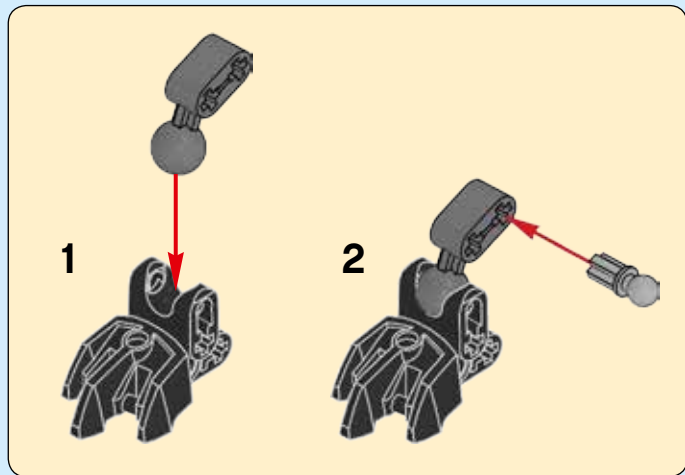
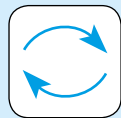

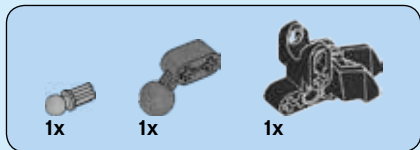

18

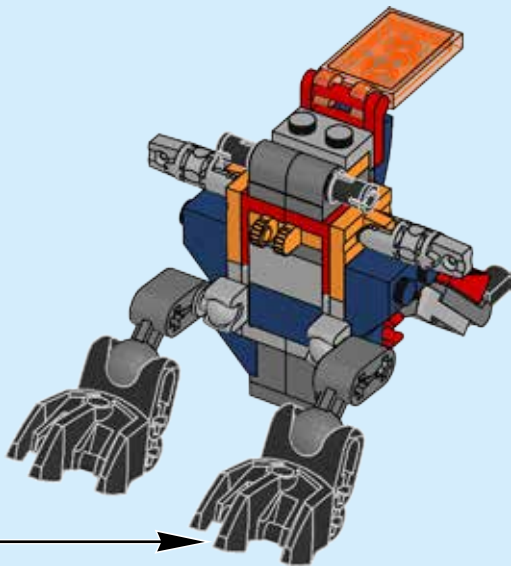
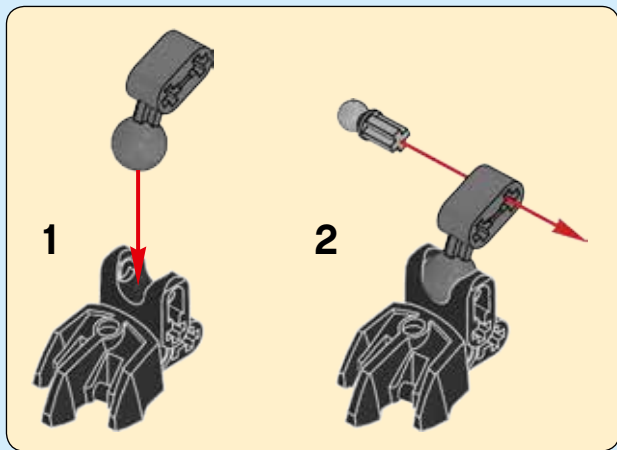



2x



1x

19

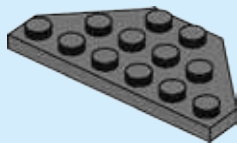

2x

20

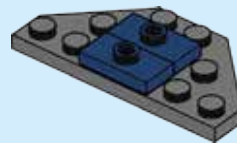

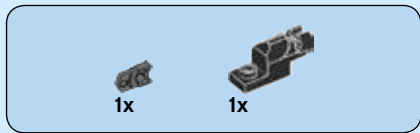

21

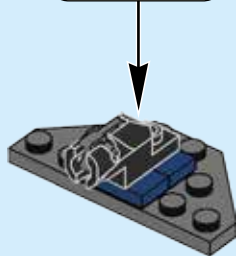
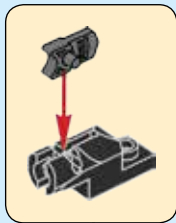

22

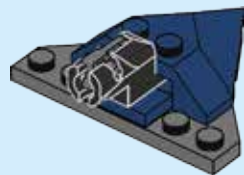

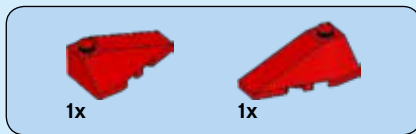

23

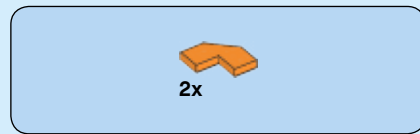
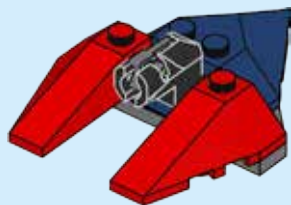

24

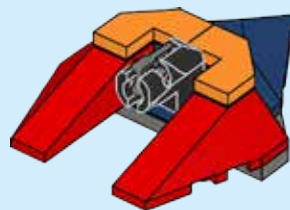

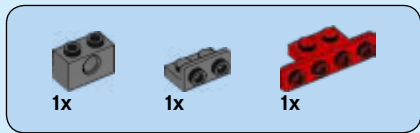

25

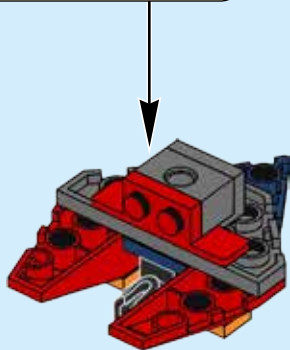
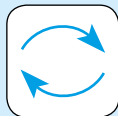
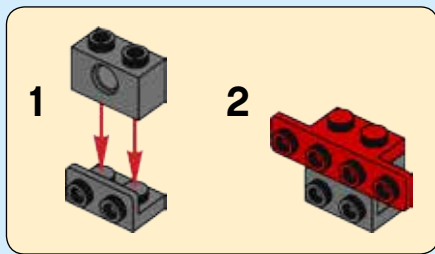

26

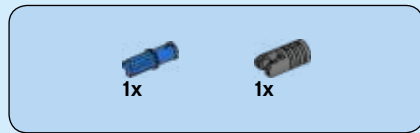

26

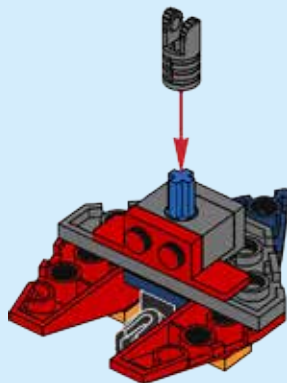

2x

27

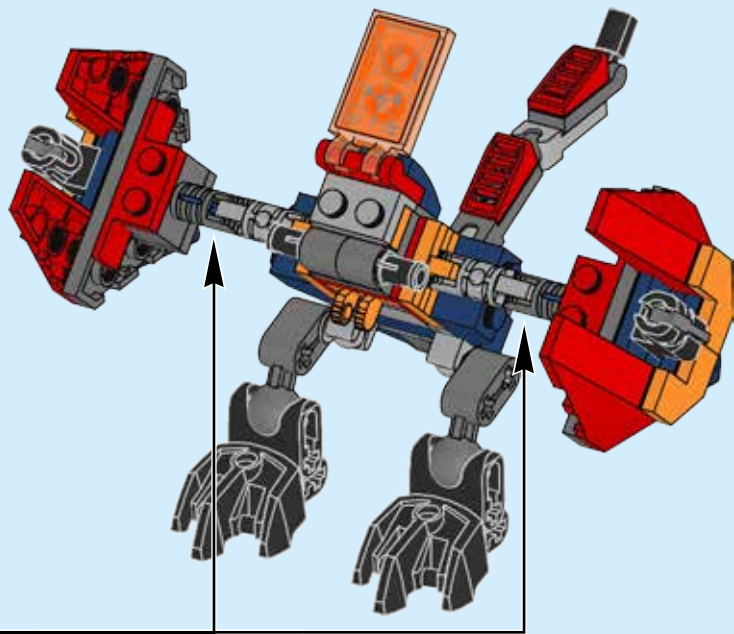

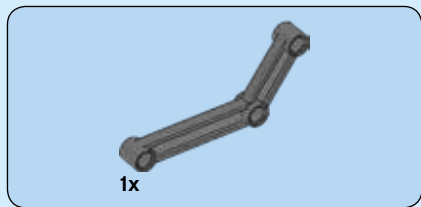

28

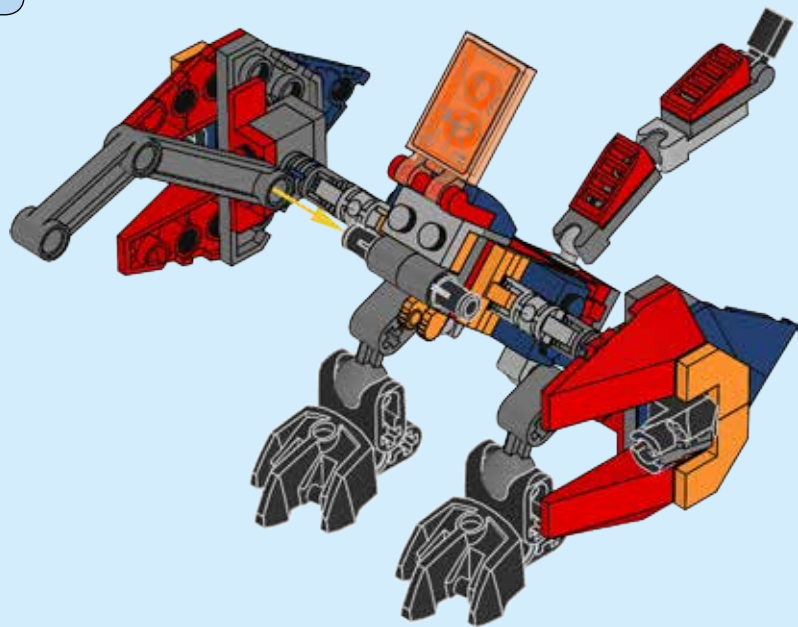



1x



1x

29

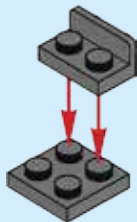

2x

30

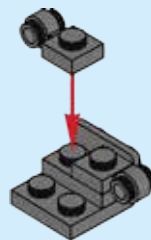



2x

31

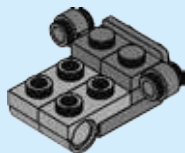

2x



1x

32

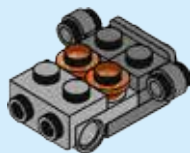



1x

33



2x

34

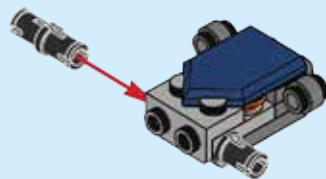



1x

35

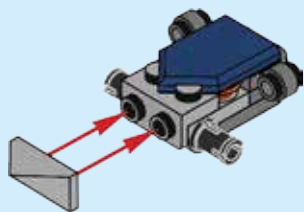

2x

36

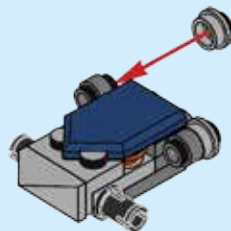



1x

37

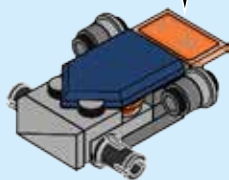
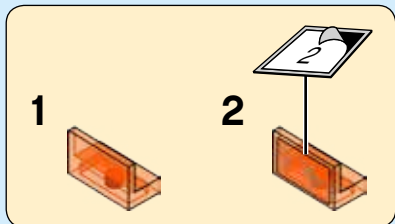

2x

38

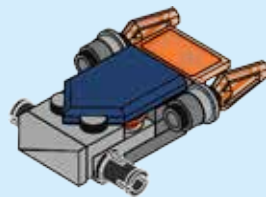

39

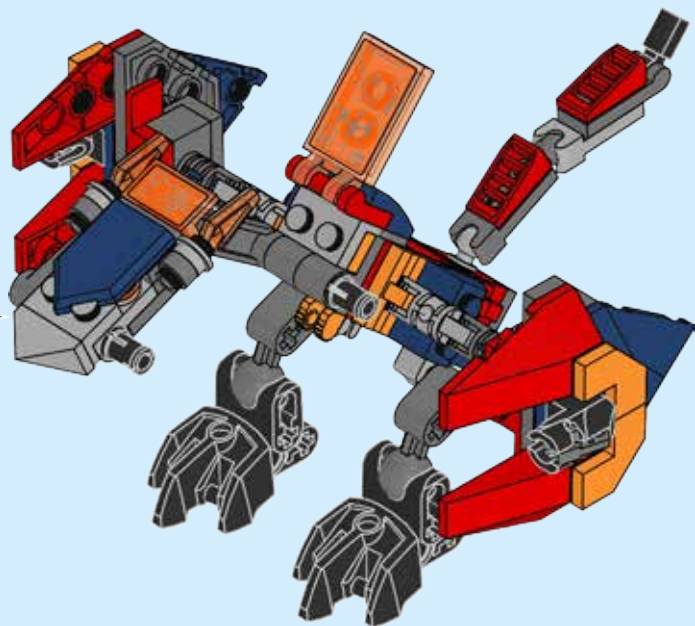

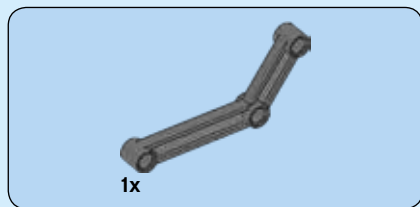

40

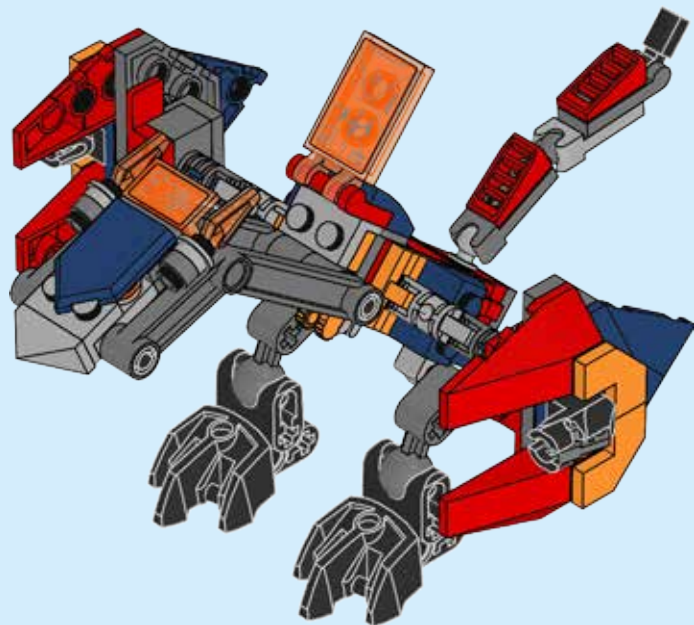

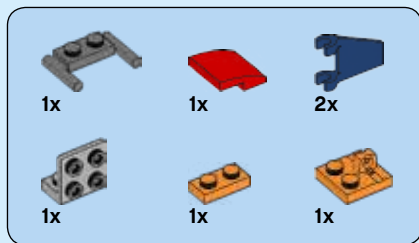

41

1

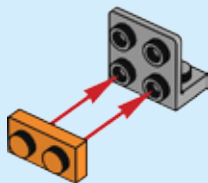

2

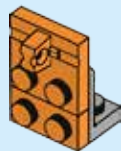

3

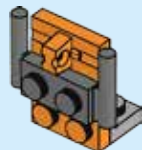

4

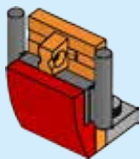

5

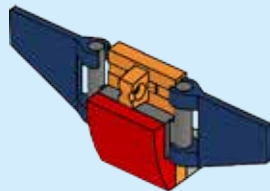

6

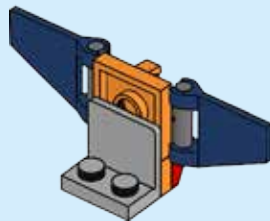

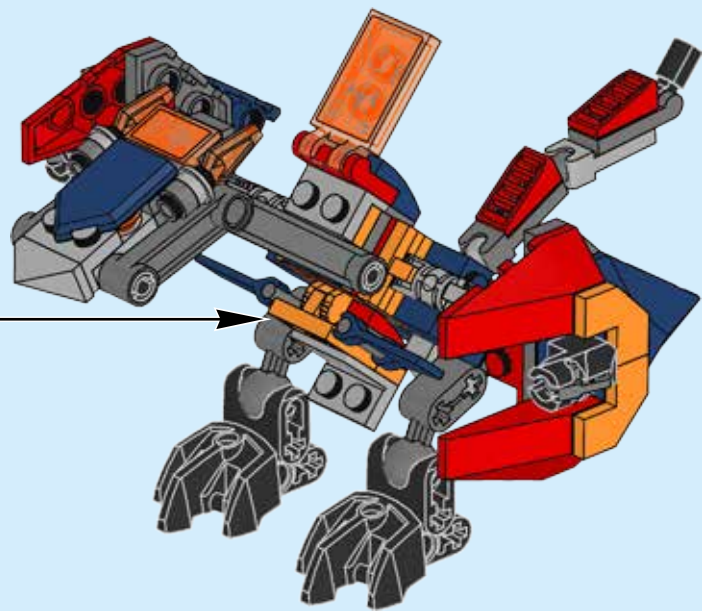



42

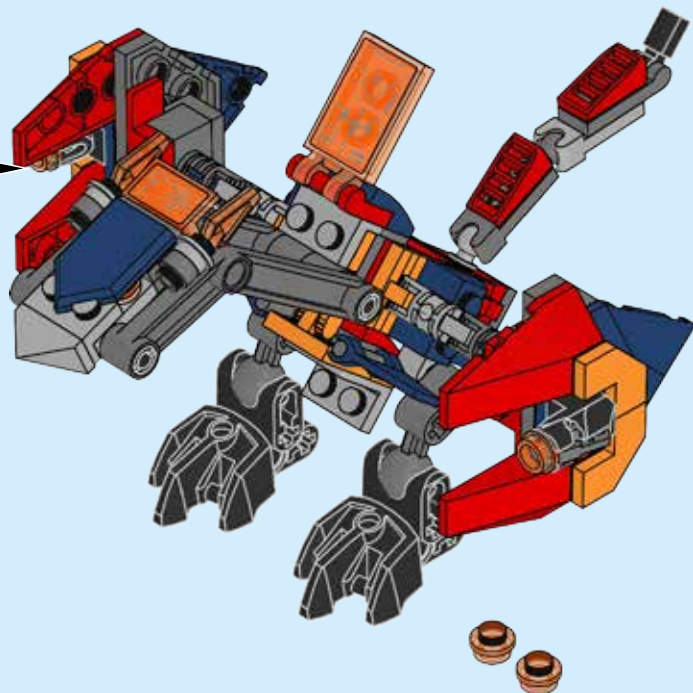

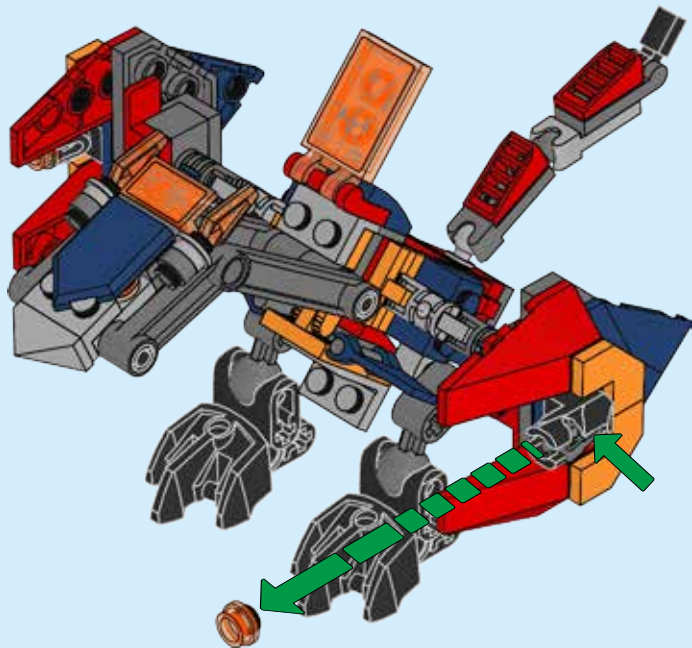

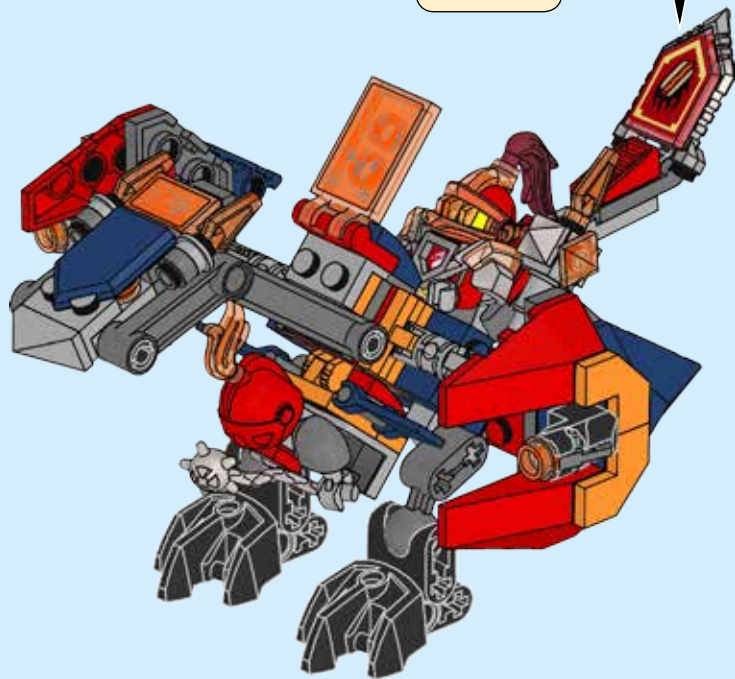



70363

1

70361

2



3

70361 + 70363

COMBINE
YOUR POWERS



COMBINE YOUR POWERS . KOMBINIERE DEINE KRÄFTE . COMBINE TES POUVOIRS . COMBINA I TUOI POTERI
COMBINA TUS PODERES . COMBINA OS TEUS PODERES . KOMBINÁLD ERÖIDET! . 组合你的力量



70352



70341



70363



70351



70354



70354



70355



70355



70356



70357

DISCOVER MORE COMBINATIONS



NEXO KNIGHTS



LEGO.COM/NEXOKNIGHTS

DISCOVER MORE COMBINATIONS / WEITERE KOMBINATIONEN ENTDECKEN / DÉCOUVRE PLUS DE COMBINAISONS / SCOPRI ALTRE COMBINAZIONI / DESCUBRE MÁS COMBINACIONES /
DESCOBRER MAIS COMBINAÇÕES / FEDEZZ FEL MÉG TÖBB KOMBINÁCIÓTI! / 发现更多组合



NEXO KNIGHTS™



LEGO® NEXO KNIGHTS™: MERLOK 2.0



1



2



3

LEGO.COM/DEVICECHECK



NEXO KNIGHTS



70357



70356



70355



70354



70353



70361



70362



70363



70364



70365



70366



70373



NEXO KNIGHTS™



DOWNLOAD THE FREE APP; KOSTENLOSE APP HERUNTERLADEN; TÉLÉCHARGE L'APPLI GRATUITE ;
 SCARICA L'APP GRATUITA; DESCARGA LA APP GRATIS; DESCARREGA A APP GRÁTIS;
 TÖLTSD LE AZ INGYENES APPOT! / 下载免费 APP:

LEGO® NEXO KNIGHTS™: MERLOK 2.0 LEGO.com/devicecheck

ALL MATERIALS MIGHT NOT BE AVAILABLE IN ALL MARKETS.
 MÖGLICHERWEISE IST NICHT DAS GANZE MATERIAL IN ALLEN MÄRKTEN VERFÜGBAR.
 CERTAINS PRODUITS PEUVENT NE PAS ÊTRE DISPONIBLES SUR CERTAINS MARCHÉS.
 TUTTI I MATERIALI POTREBBERO NON ESSERE DISPONIBILI IN TUTTI I MERCATI.
 CIERTOS MATERIALES PODRÍAN NO ESTAR DISPONIBLES EN TODOS LOS MERCADOS.
 OS MATERIAIS PODERÃO NÃO ESTAR TODOS DISPONÍVEIS EM TODOS OS MERCADOS.
 ELKÉPZELHETŐ, HOGY BIZONYOS KIEGÉSZÍTŐK A TE ORSZÁGODBAN NEM ELÉRHETŐEK.
 部分内容可能不适用于某些国家/地区

LEGO.COM/NEXOKNIGHTS



LEGO NEXO KNIGHTS





NEXO KNIGHTS



ROGUL
70354



BRICKSTER
70355



BRICKSTER
70357



BOULDRON
70353
70356



HARPY
70353



WHITE STONE STATUE
70357



BRICKSTER
70357



BRICKSTER
70356



BRICKSTER
70354



JESTRO
70356



STONE STOMPER
70353 / 70357 / 70361



STONE STOMPER
70357



STONE STOMPER
70355



LORD KRAKENSKULL
70355



GENERAL GARG
70356

* Weapons and decorations vary by set • Zubehör und Dekoration variieren je nach Set • Las armas y accesorios varían según el set • As armas e decorações variam consoante o conjunto •



BATTLE SUIT CLAY
70362



BATTLE SUIT MACY
70363



BATTLE SUIT AARON
70364



BATTLE SUIT AXL
70365



BATTLE SUIT LANCE
70366



CLAY
70353



MACY
70356 / 70361



AARON
70355 / 70357



AXL
70354



LANCE
70357



STONE CLAY
70356



KING'S GUARD
70357



KING HALBERT
70357



FANCY PANTS
70357



MACY BOT
70361



AARON BOT
70355



AXL BOT
70354



ROBIN
70357



HAMLETTA
70357



MERLOK 2.0
70357

Les armes et les décorations varient selon les boîtes • Le armi e le decorazioni possono variare a seconda del set •
A fegyverek és dekorációk készletenként változnak. • 套装不同，武器和装饰各有不同

WIN

GO TO WWW.LEGO.COM/PRODUCTFEEDBACK AND
GIVE US YOUR SHORT **FEEDBACK** ABOUT THIS
LEGO® SET FOR A CHANCE TO WIN
A COOL LEGO PRIZE.

Terms & Conditions apply

LEGO.com/productfeedback



GEWINNE

Erzähle uns auf
www.LEGO.com/productfeedback

etwas über die Erfahrungen, die du mit
diesem LEGO® Set gemacht hast, und
sichere dir die Chance auf einen coolen
LEGO Preis!

Es gelten die Teilnahmebedingungen

GAGNE

Rends-toi sur
www.LEGO.com/productfeedback

et donne-nous quelques commentaires sur
ce produit LEGO® pour avoir une chance
de gagner un prix LEGO !

Voir Conditions Générales

GANAN

Visita
www.LEGO.com/productfeedback

y envíanos tu opinión acerca de este set
LEGO®. ¡Participarás en el sorteo de un
premio LEGO!

Términos y Condiciones aplicables

获取奖品

登录
www.LEGO.com/productfeedback

给出关于此乐高®套装的简短反馈，
就有机会获得炫酷乐高奖品

《条款及条件》适用

LEGO, the LEGO logo and NEXO KNIGHTS are trademarks of the LEGO Group. ©2017 The LEGO Group.

6204039