



Architecture

21026
Venice
Italy
Venezia, Italia



[LEGO.com/architecture](https://www.lego.com/architecture)

Venice

Built on over 100 islands in a marshy lagoon at the edge of the Adriatic Sea, Venice has a skyline that rises from the water to create a unique architectural experience. There are no roadways or cars in the historic city; instead 177 canals crossed by over 400 bridges give access to innumerable narrow, mazelike alleys and squares.

While the origin of the city dates back over 1500 years, the golden age of Venice occurred during the late Middle Ages and Renaissance periods when it became one of the most powerful republics in the eastern Mediterranean.

Today the city is facing major challenges including gradual subsidence, flooding, and problems caused by its popularity as a tourist destination. More than 60,000 people visit Venice each day—more than the population of the city itself—putting pressure on the city to accommodate these guests while maintaining its unique nature and identity.



Rialto Bridge

The Rialto Bridge (Ponte di Rialto) spans the Grand Canal at the heart of the historic city. Built between 1588 and 1591, it replaced earlier wooden bridges that had linked the districts of San Marco and San Polo since the 12th century.

When the last wooden bridge collapsed in 1524, several projects were considered before the city authorities requested plans for a stone bridge in 1551. The architect Antonio da Ponte competed with illustrious competitors such as Michelangelo and Palladio before winning the contract.

His single span design with a 24 ft. (7.5 m) arch included three walkways: two along the outer edges and a wider central walkway between two rows of small shops. The entire structure was built on some 12,000 wooden pilings that still support the bridge over 400 years later.

[“To build a city where it is impossible to build a city is madness in itself, but to build there one of the most elegant and grandest of cities is the madness of genius.”]

Alexander Herzen



Rialto Bridge

Bridge of Sighs

Bridge of Sighs (Ponte dei Sospiri) is an enclosed bridge constructed in white limestone that passes over the Rio di Palazzo, connecting the old city prison to the interrogation rooms in the Doge's Palace. Designed by Antonio Contino, the nephew of Antonio da Ponte who created the Rialto Bridge, the bridge was completed in 1602.

The bridge's romantic name is thought to refer to the sighs of convicts as they saw their last view of Venice before being taken to their prison cells. In reality, very little of the city could be seen through the stone grills covering the windows and the majority of prisoners at that time were small-time criminals.

["I stood in Venice, on the
Bridge of Sighs, A palace
and a prison on each hand."]



St. Mark's Campanile

As one of the tallest structures in the city, St. Mark's Campanile (Campanile di San Marco) is one of Venice's most recognizable symbols. From here the visitor has an incredible view of the city and lagoon as well as the Italian Alps in the distance.

The 323 ft. (98.6 m) bell tower stands alone in the corner of St. Mark's Square, near the front entrance to the basilica. The brick structure is 39 ft. (12 m) wide on each side and 160 ft. (50 m) tall, upon which sits a belfry housing five bells. A spire caps the tower with a golden weather vane on top.

Though the design of the Campanile is from the 16th century, the tower itself was completely rebuilt in 1912 after the original one collapsed in 1902. The inauguration of the new tower occurred exactly 1000 years after the foundation of the original tower was laid.



St. Mark's Campanile

St. Mark's Basilica

St. Mark's Basilica (Basilica di San Marco) is the most famous church in Venice and the best-known example of the city's unique Italo-Byzantine architecture.

Built to house the relics of Mark the Evangelist, little is known about the original church buildings, but the current structure is thought to have been constructed between 1073 and 1093. The basilica is laid out in the design of a Greek cross and the tallest of the five domes reach 141 ft. (43 m) in height.

While the layout of the church has remained constant over the centuries, the decoration on the inside and outside of the church has changed greatly. Venice's involvement in crusades and conquests saw mosaics, columns, and friezes from all over the Mediterranean

added to the original opulent, golden mosaic interior. Outside, the exterior brickwork was gradually covered with marble cladding and carvings as Venetian vessels returned with the spoils of war and trade.

A symbol of the wealth and power of the Venetian Republic, St. Mark's Basilica remains one of the city's most impressive landmarks today.



St. Mark's Basilica

St. Theodore and the Lion of Venice columns

Two granite columns stand guard at the entrance to St. Mark's Square (Piazza di San Marco).

On top of the western column is a statue of St. Theodore, the first patron of the city. Here he holds a spear and his foot rests upon a crocodile—representing the dragon he was said to have slain. On the eastern column stands the winged Lion of Venice, the symbol of the second patron of the city, St. Mark.

Both columns are believed to have been erected in about 1268 and it is believed that the city executed convicted criminals between the two columns in days gone by. To this day, superstitious Venetians avoid walking between this pair of columns.

[“There is a glorious city in the sea. The sea is in the broad, the narrow streets, Ebbing and flowing... ”]

Samuel Rogers



St. Theodore and the Lion of Venice columns

Venezia

Costruita su oltre 100 isole in una paludosa laguna ai margini del mare Adriatico, Venezia si erge dall'acqua, offrendo ai visitatori un'esperienza architettonica senza uguali. Il centro storico è privo di strade percorribili da automobili, mentre 177 canali, attraversati da oltre 400 ponti, danno accesso a un labirinto di stretti vicoli e piazze.

Sebbene la fondazione della città risalga a oltre 1.500 anni fa, l'età d'oro di Venezia fu durante i periodi del tardo Medioevo e del Rinascimento, quando divenne una delle più potenti Repubbliche nel Mediterraneo orientale.

Oggi, la città deve affrontare grandi sfide tra cui una graduale subsidenza, allagamenti e problemi causati dalla sua popolarità come destinazione turistica. Oltre 60.000 persone visitano Venezia ogni giorno, più della popolazione stessa, e questo mette sotto un'enorme pressione la città che deve accogliere i suoi ospiti e allo stesso tempo preservare la sua natura e identità.



Ponte di Rialto

Il Ponte di Rialto attraversa il Canal Grande, nel cuore della città storica. Costruito tra il 1588 e il 1591, sostituì alcuni ponti di legno che collegavano i quartieri di San Marco e di San Polo dal 12° secolo.

Quando l'ultimo ponte di legno crollò nel 1524, diversi progetti furono presi in esame dalle autorità cittadine prima che un ponte in pietra fosse commissionato nel 1551. L'architetto Antonio da Ponte si aggiudicò il progetto dopo aver avuto la meglio su illustri concorrenti come Michelangelo e Palladio.

Il suo design a campata unica, con un arco di 7,5 m, comprendeva tre passaggi pedonali: due lungo i bordi esterni e uno centrale, più ampio, tra due file di piccoli negozi. L'intera struttura è stata costruita su circa 12.000 pali di legno che ancora sostengono il ponte, a 400 anni di distanza.

[“Costruire una città dove è impossibile costruire una città è già una follia, ma costruirci una delle città più eleganti e grandiose del mondo è geniale follia”.]

Alexander Herzen



Ponte di Rialto

Ponte dei Sospiri

Il Ponte dei Sospiri è una struttura completamente chiusa, in pietra calcarea bianca d'Istria, che collega, scavalcando il rio di Palazzo, il vecchio Palazzo delle Prigioni alle Sale dei Magistrati del Palazzo Ducale. Progettata da Antonio Contino, il nipote di Antonio da Ponte, artefice del Ponte di Rialto, la struttura fu completata nel 1602.

Si dice che il Ponte dei Sospiri abbia questo nome perché in esso transitavano i condannati o i detenuti in attesa di giudizio, i quali potevano ammirare Venezia per l'ultima volta prima di essere rinchiusi nelle celle. In realtà, essendo la struttura completamente chiusa, era possibile vedere molto poco attraverso le griglie di pietra che coprivano le finestre e la maggior parte dei prigionieri a quel tempo era costituita da piccoli criminali.

[“Ero a Venezia sul Ponte dei Sospiri; un palazzo da un lato, dall'altro una prigione”.]



Campanile di San Marco

Una delle strutture più alte della città, il Campanile di San Marco è uno dei simboli più riconoscibili di Venezia. Dal Campanile, i visitatori possono ammirare una vista incredibile della città e della laguna e le Alpi in lontananza.

Il campanile, alto 98,6 m, si erge solitario in uno degli angoli di Piazza San Marco, vicino all'entrata della Basilica. Sulla struttura in mattoni, larga 12 m e alta 50 m, riposa la cella campanaria che ospita cinque campane. Sulla cella campanaria si trova una cuspide di forma piramidale dotata di segnavento dorato.

Sebbene il design del campanile risalga al 16° secolo, la torre è stata completamente ricostruita nel 1912 dopo il crollo di quella originale, nel 1902. L'inaugurazione della nuova torre ebbe luogo esattamente 1.000 anni dopo la costruzione della fondazione della torre originaria.



Campanile di San Marco

Basilica di San Marco

La Basilica di San Marco è la chiesa più famosa di Venezia e il più noto esempio di architettura italo-bizantina della città.

Costruita per ospitare le reliquie di San Marco Evangelista, poco si sa sugli edifici della chiesa originale, ma si pensa che la struttura attuale sia stata eretta tra il 1073 e il 1093. La Basilica ha la forma di una croce greca e la più alta delle cinque cupole raggiunge i 43 m di altezza.

Sebbene la pianta della Basilica sia rimasta inalterata nel corso dei secoli, le decorazioni interne ed esterne hanno subito diversi cambiamenti. Per via del coinvolgimento di Venezia nelle crociate e dei viaggi dei mercanti in oriente, l'opulento interno a mosaico

si è man mano arricchito di colonne, fregi, marmi e sculture. All'esterno, la muratura è stata gradualmente ricoperta di marmo e sculture, il bottino di guerre e degli intensi scambi commerciali della repubblica marinara.

Simbolo della ricchezza e del potere della repubblica, la Basilica di San Marco rimane uno dei punti di riferimento più imponenti della città.



Basilica di San Marco

Le colonne di San Teodoro e del Leone Alato

Due colonne di granito fanno la guardia all'ingresso di Piazza San Marco.

Sulla sommità della colonna occidentale si trova la statua di San Teodoro, il primo patrono della città. San Teodoro impugna una lancia e il suo piede poggia su un cocodrillo, che rappresenta il drago che si dice abbia ucciso. Sulla colonna orientale, svetta il Leone alato di Venezia, il simbolo del secondo patrono della città, San Marco.

Si pensa che entrambe le colonne siano state erette intorno al 1268 e lo spazio tra le due steli venne in seguito destinato a luogo delle esecuzioni capitali. Tra la popolazione locale persiste tuttora l'usanza superstiziosa di non attraversare lo spiazzo tra le colonne.

[“Vi è una città gloriosa
nel mare.
Il mare è nelle
strade grandi e
strette, fluenti e rifluenti...”]

Samuel Rogers



Le colonne di San Teodoro e del Leone Alato

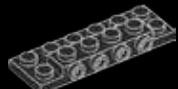

1x

1

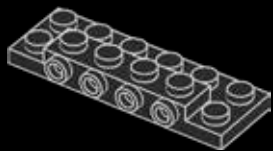

1x

2

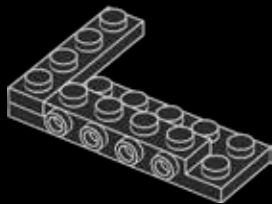

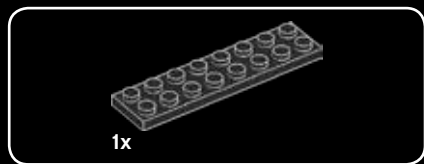

3

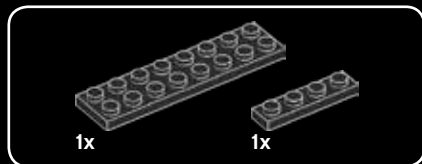
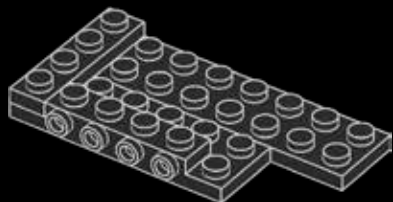

4

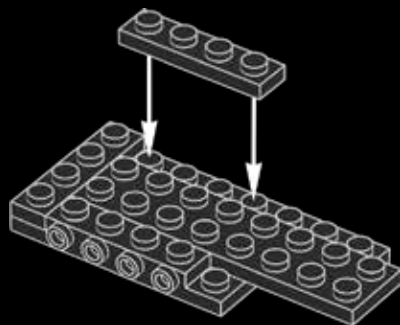



1x

5

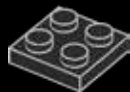
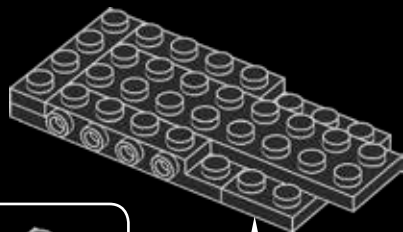

1x

6

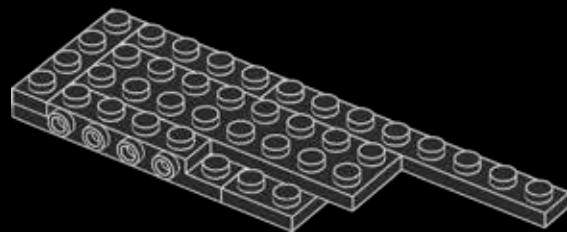

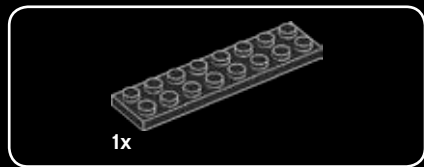

7

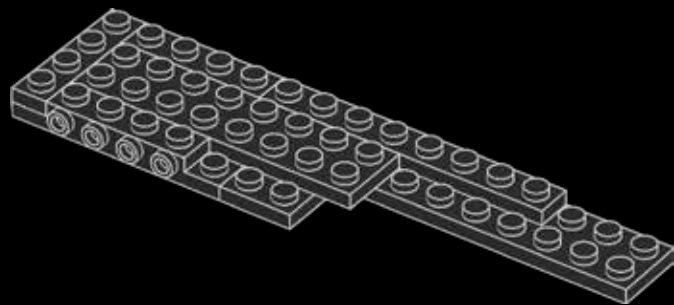

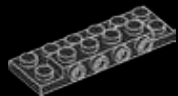

1x

8

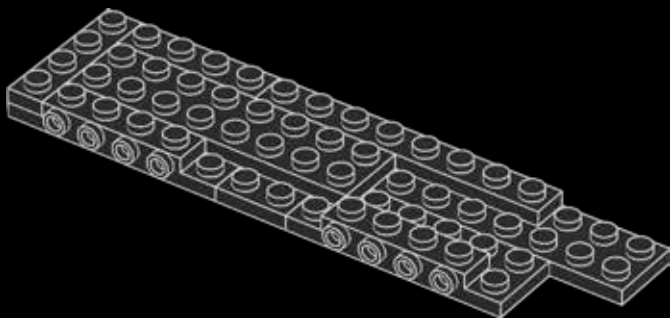



1x



1x



1x

9

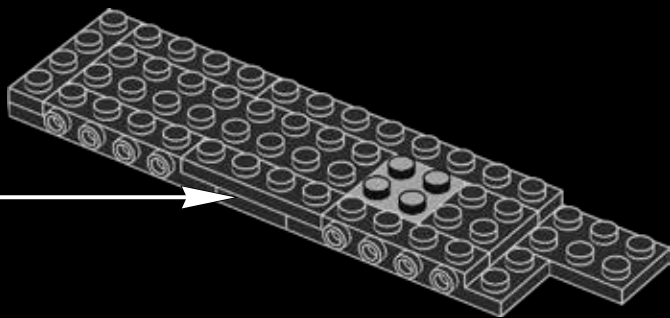
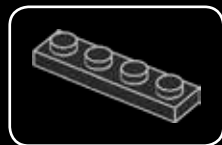

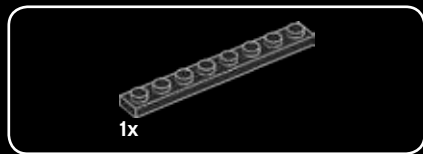

10

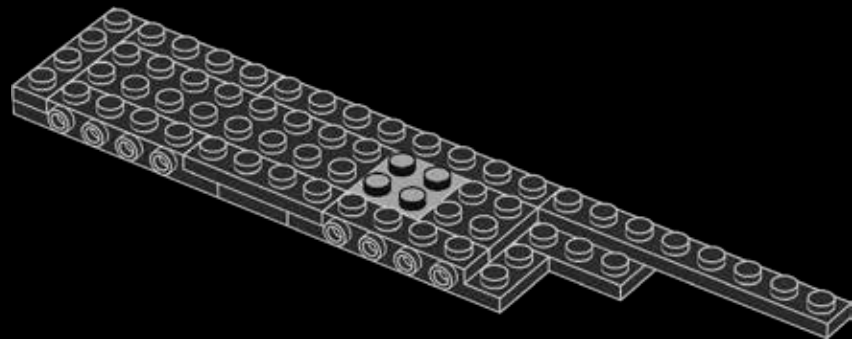

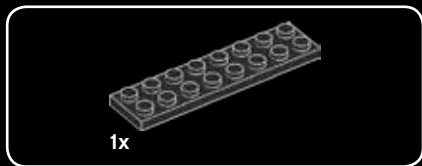

11

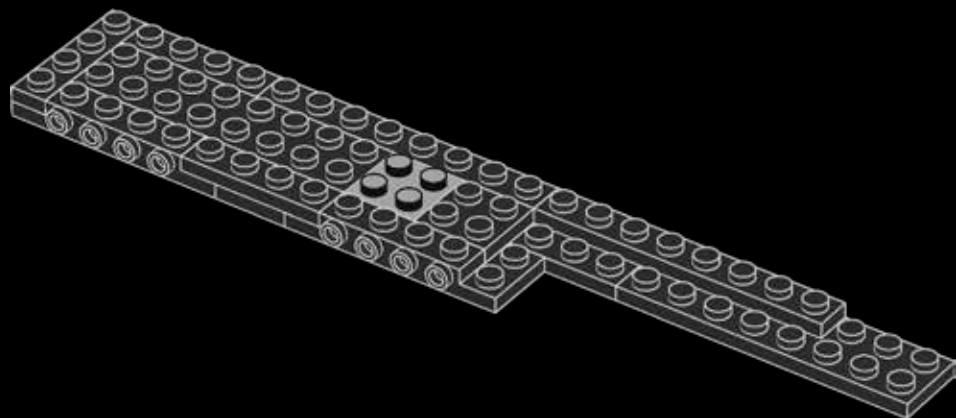

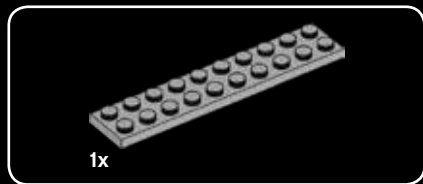

12

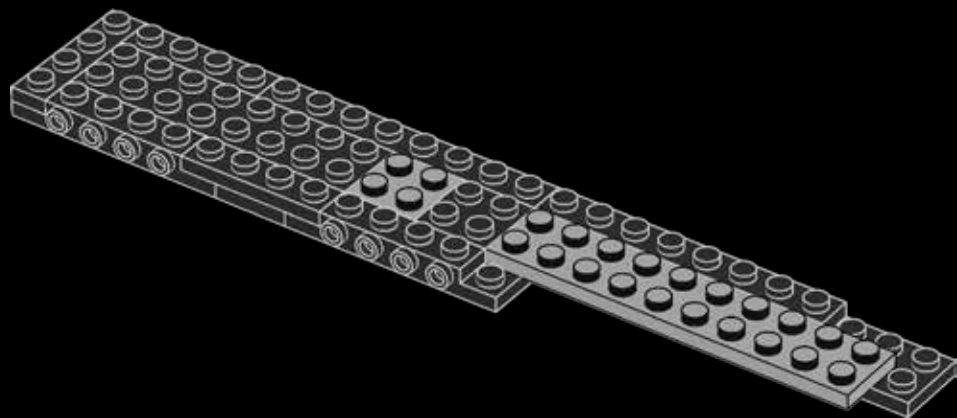

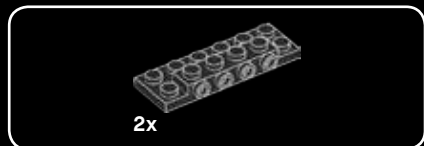

13

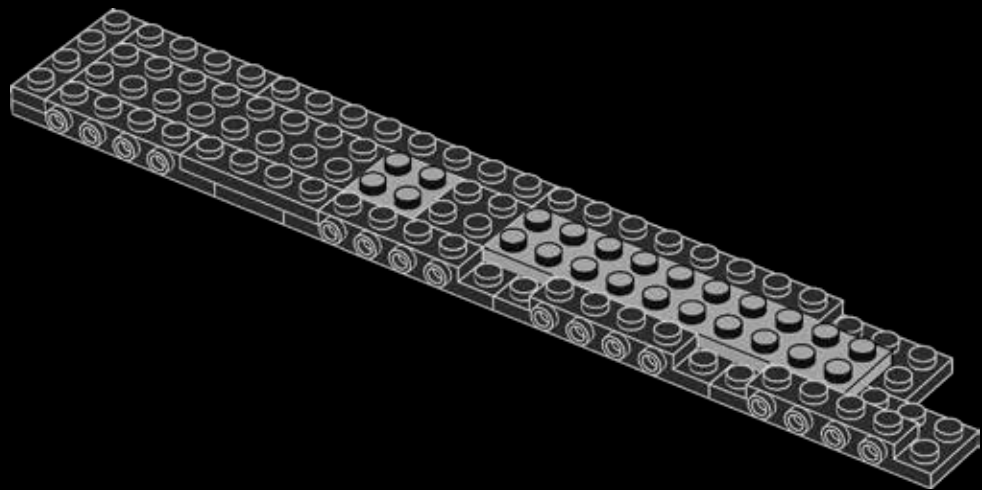



2x

14

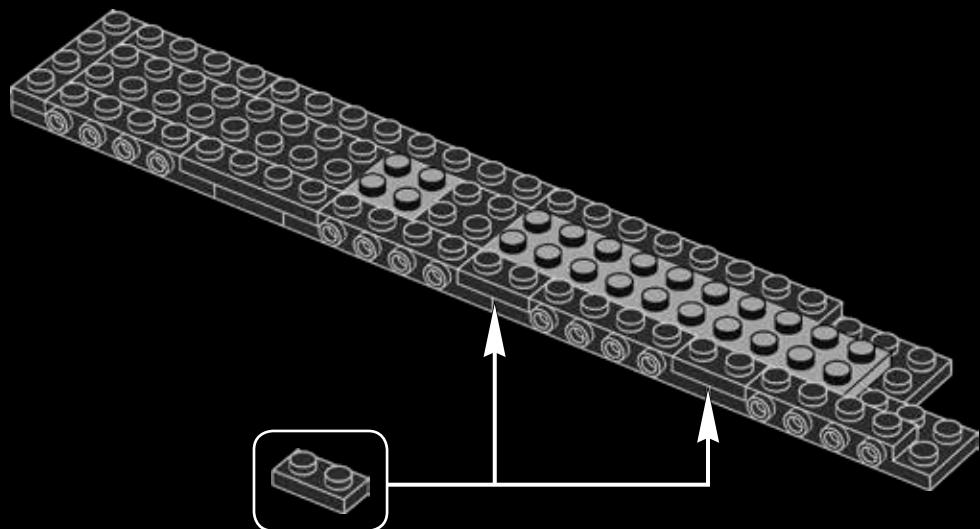



1x

As many of the small islands in the lagoon were spongy marshland, the majority of buildings sit upon a foundation of wooden piles.

A causa della natura paludosa di molte delle piccole isole della laguna, la maggior parte degli edifici fu costruita su pali di legno.



© Kfir_rin

15

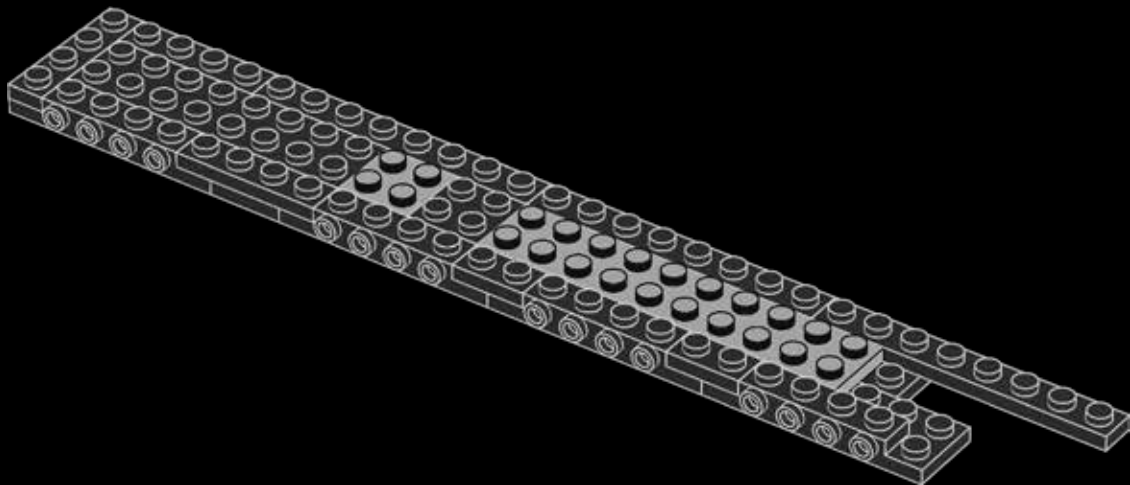

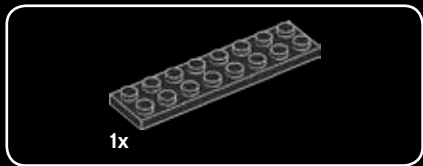

16

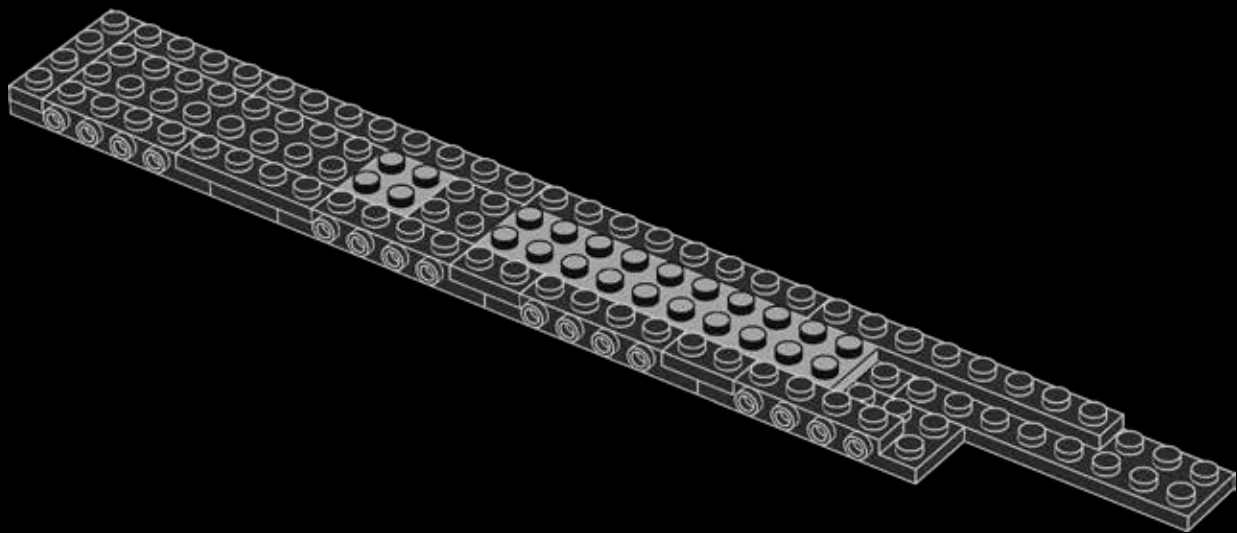

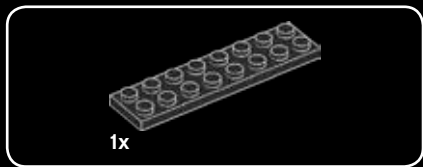

17

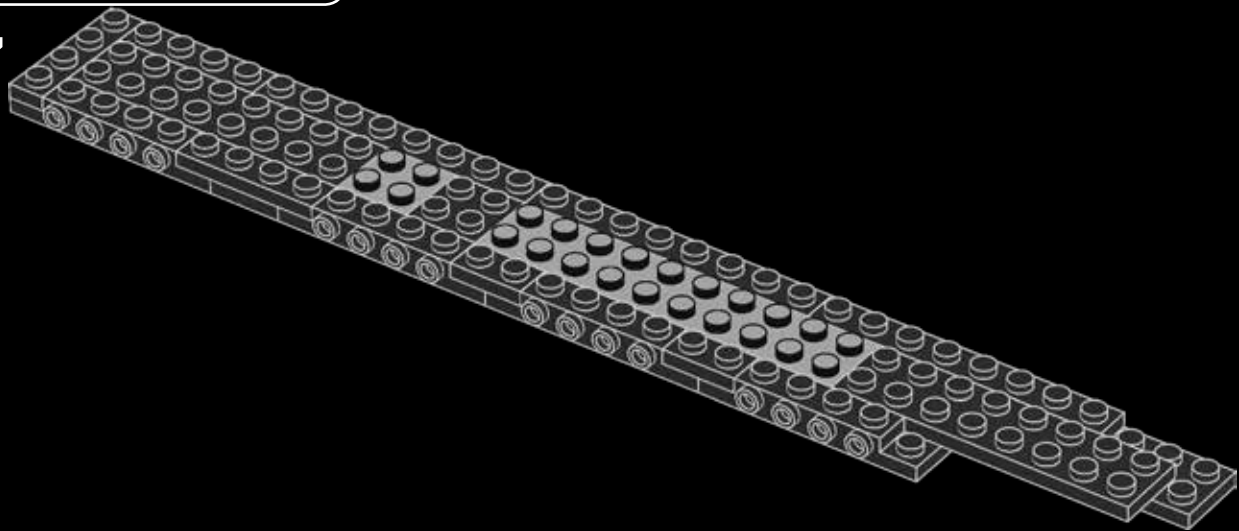

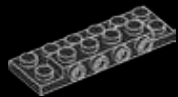

1x

18

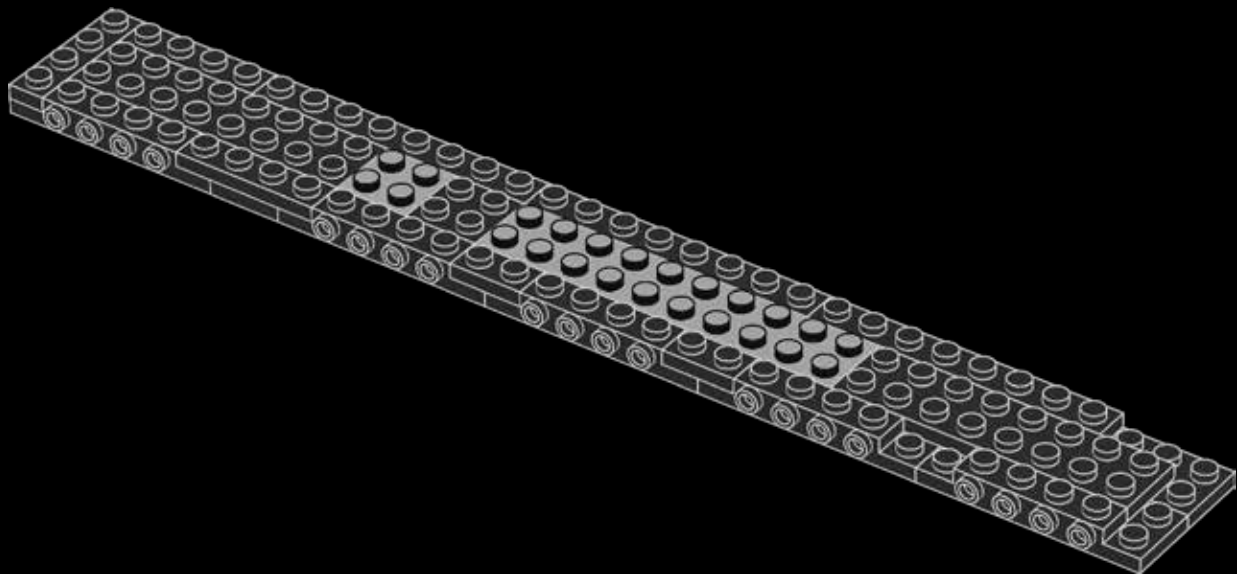



2x



1x

19

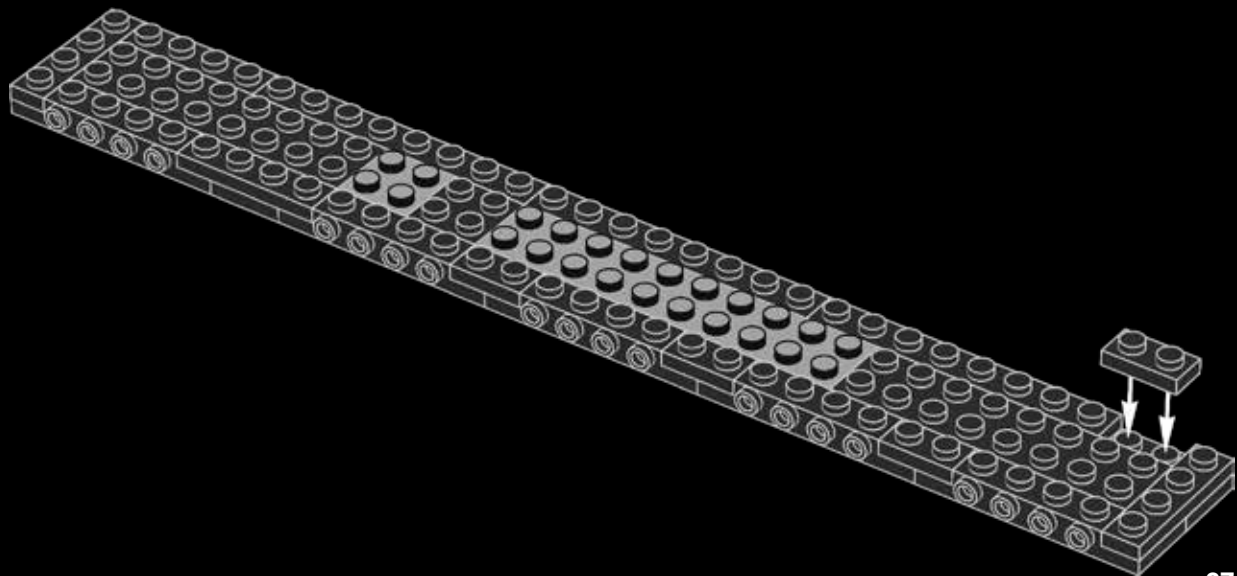



1x

20

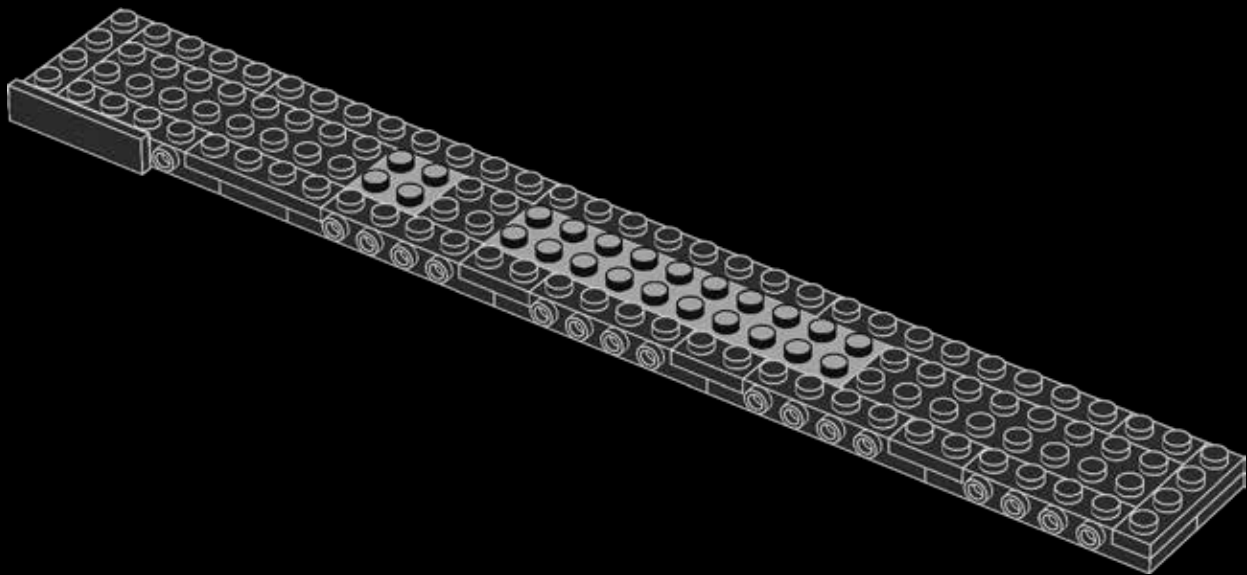

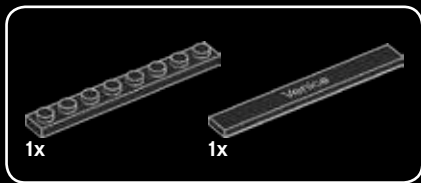

21

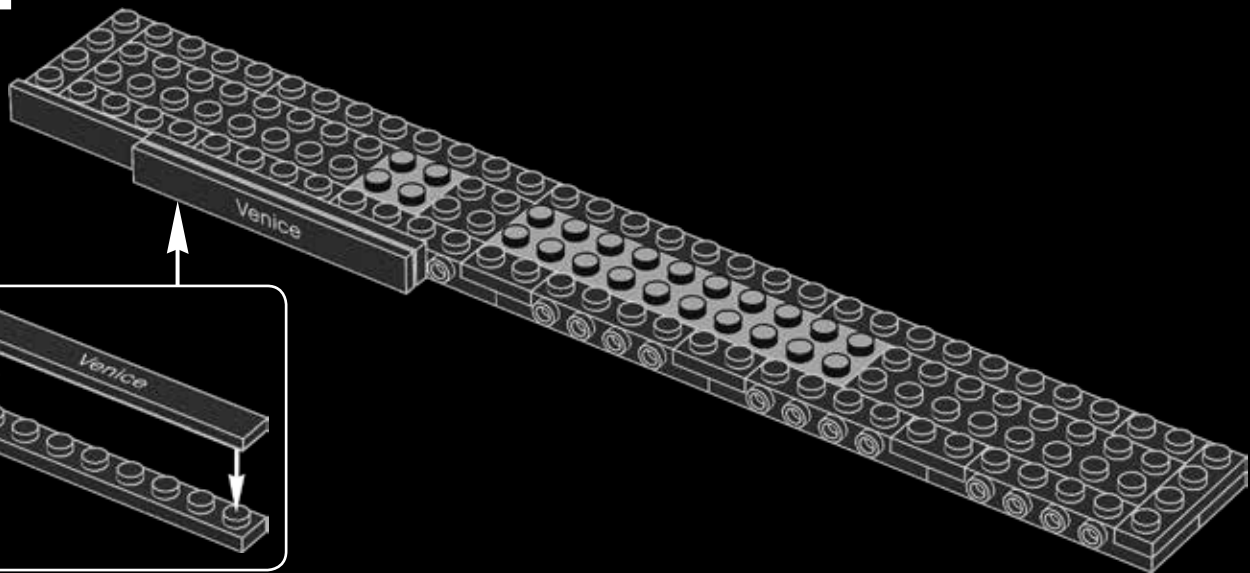
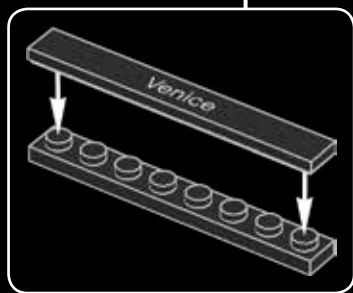

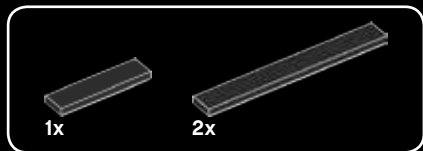

22

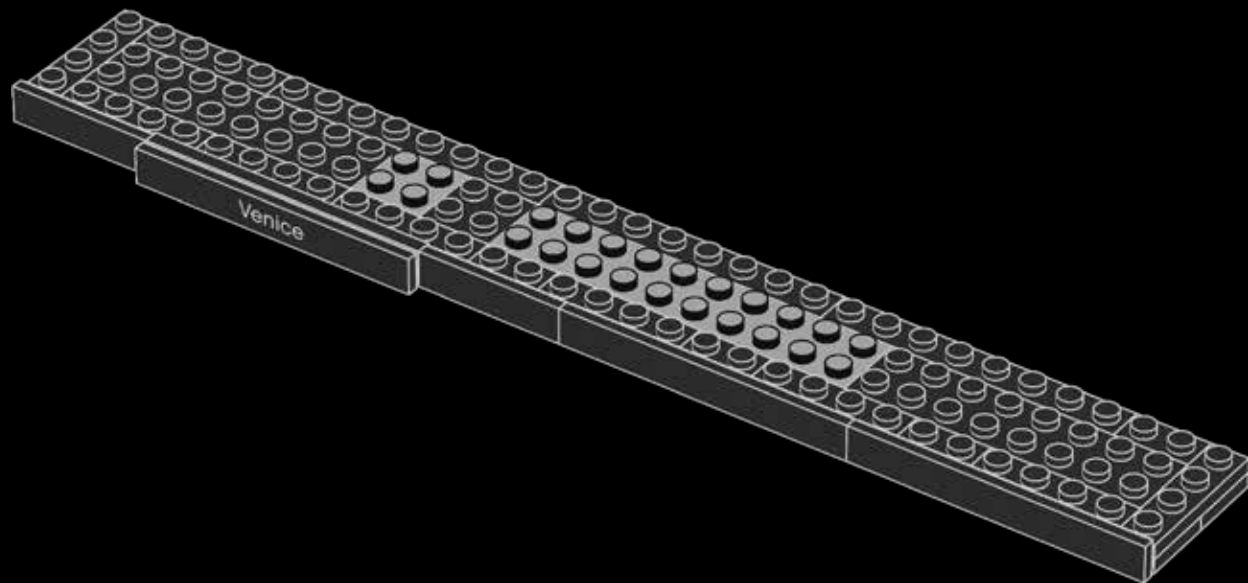

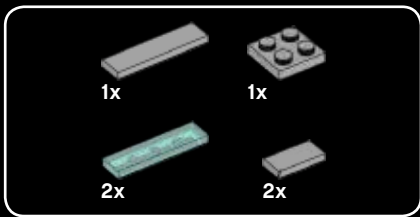

During the Acqua Alta (high water) tides can rise up to 6 ft. (2 m) and often flood St. Mark's Square.

Durante l'acqua alta, la marea può raggiungere i 2 m e spesso allaga Piazza San Marco.



© BlueMoonStore

23

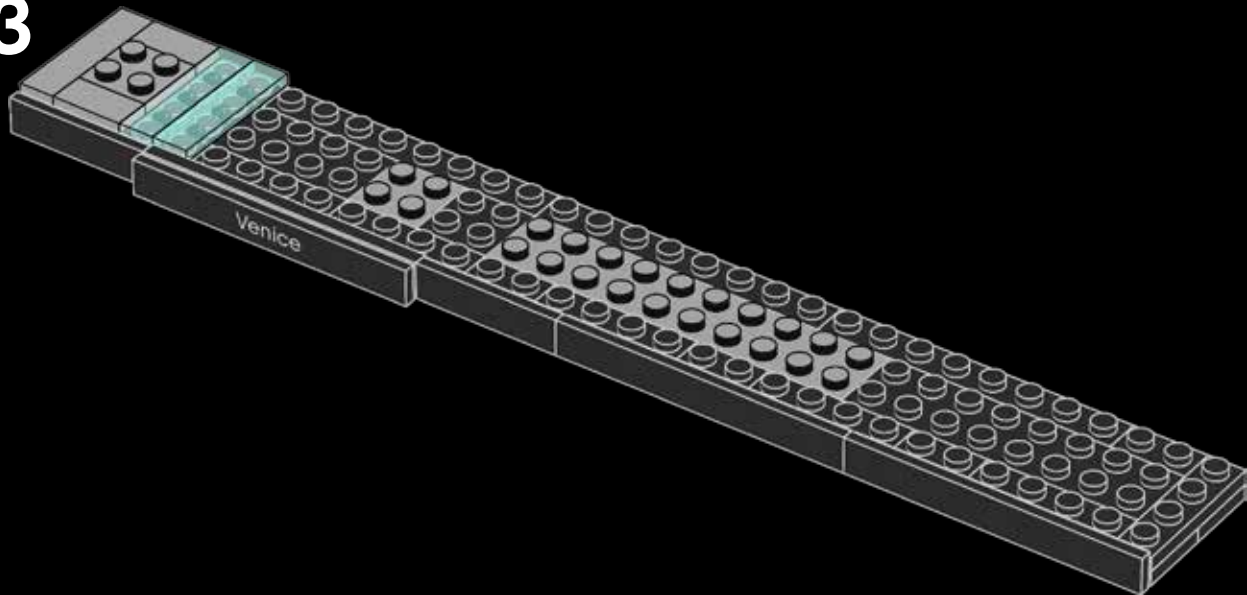

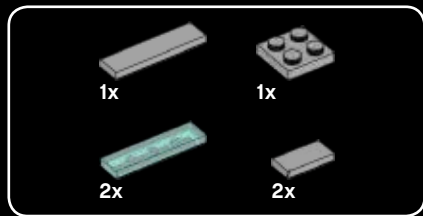

24

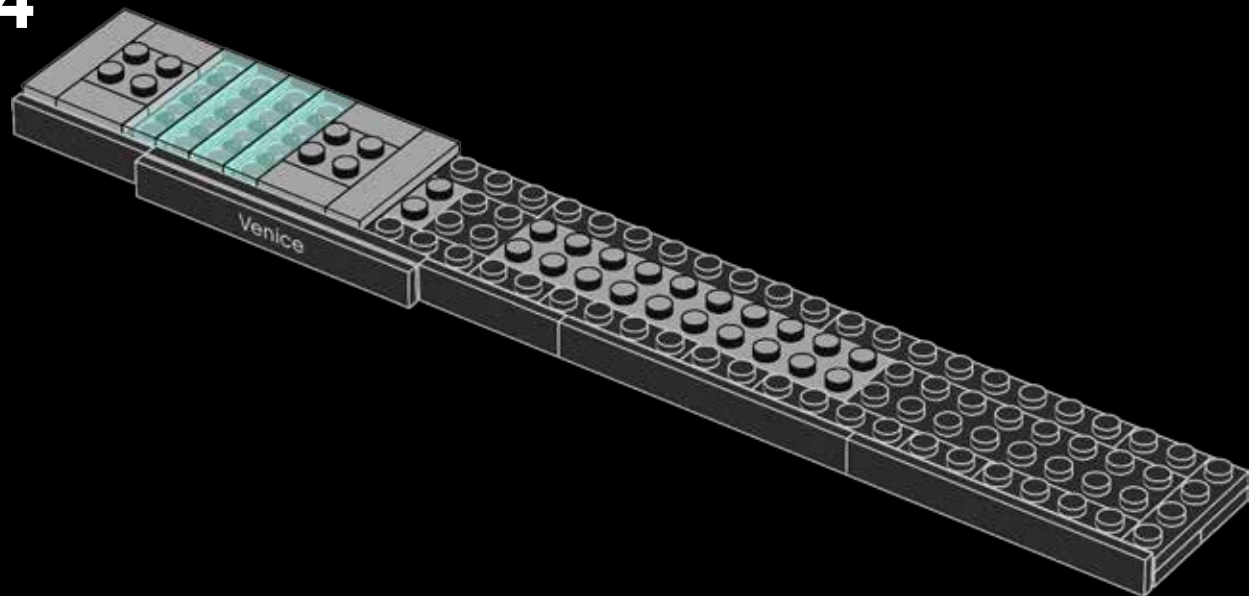

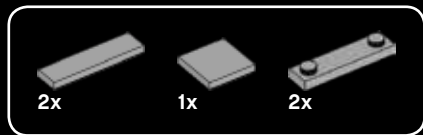

26

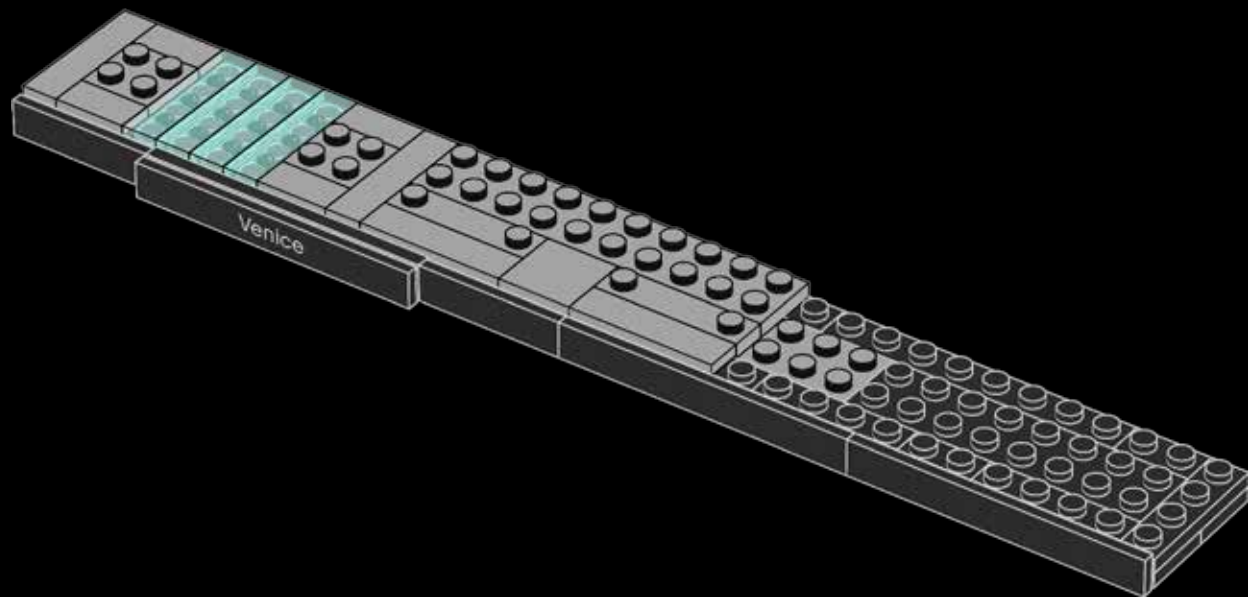

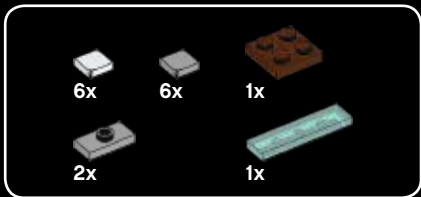

Venice is slowly sinking at the rate of about 0.04 inches (1-2 mm) every year.

Venezia sta sprofondando lentamente, a una velocità di circa 1-2 mm all'anno.



© pic3

27

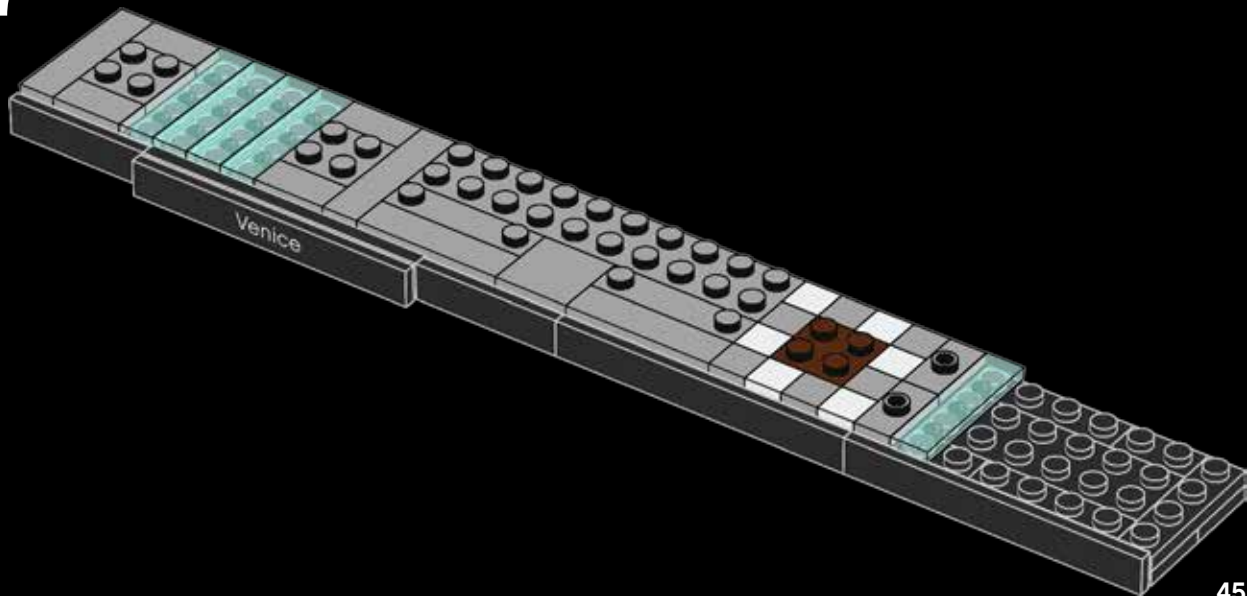



2x



2x



4x

28

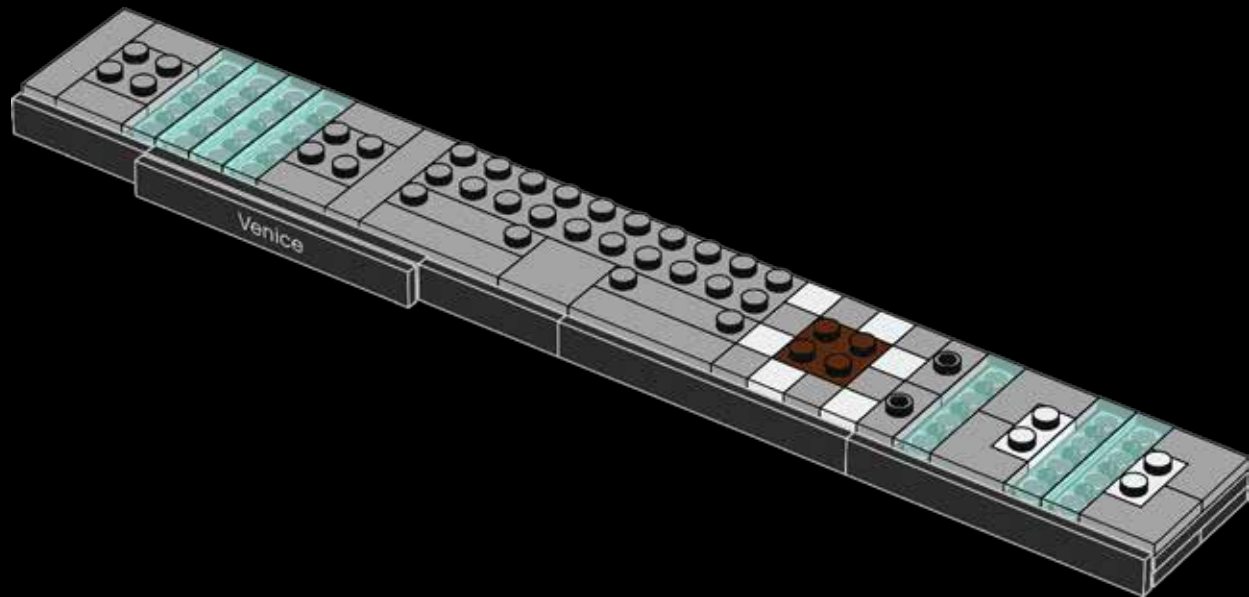



29

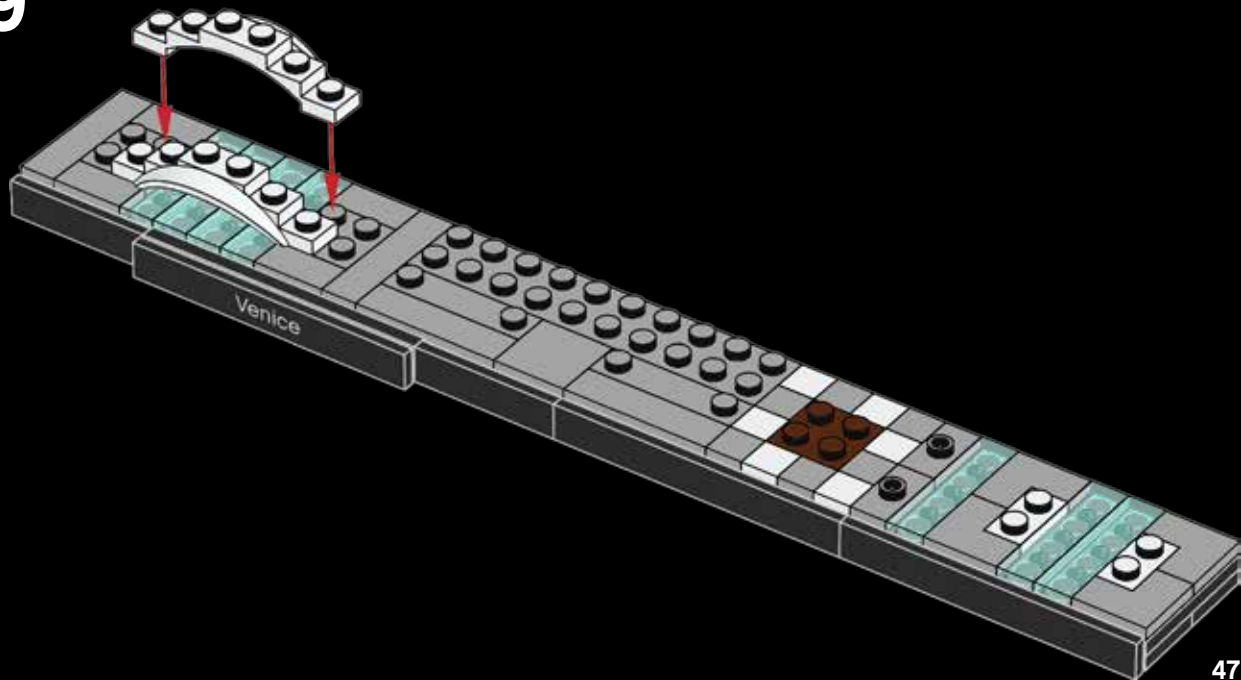



1x



6x

30

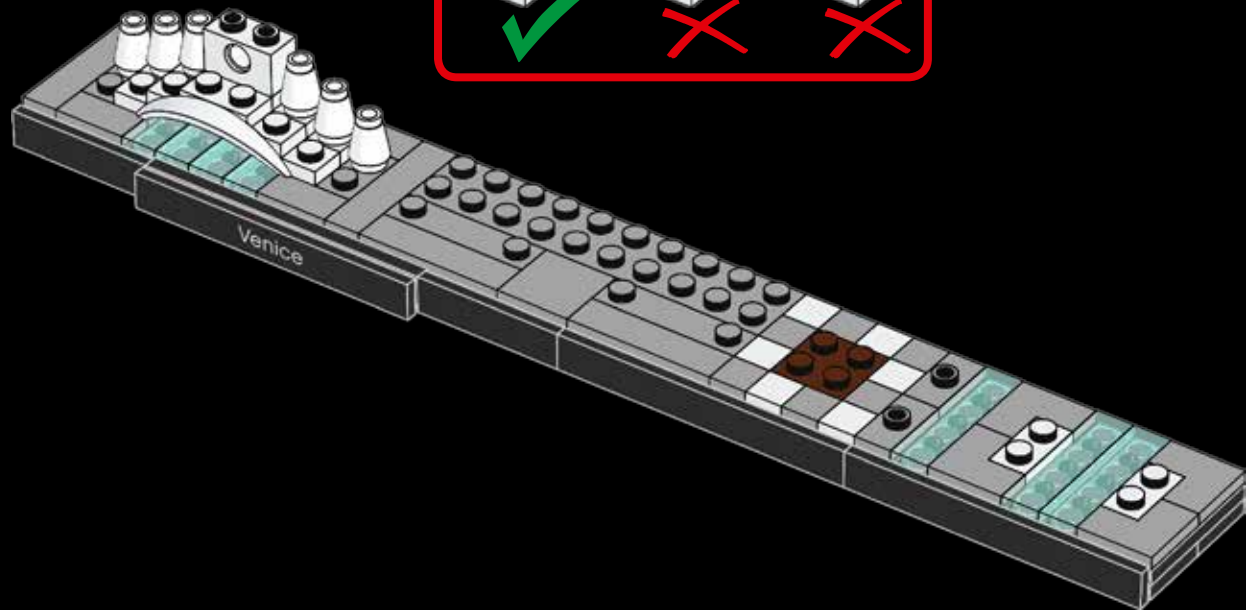



1x



6x

31

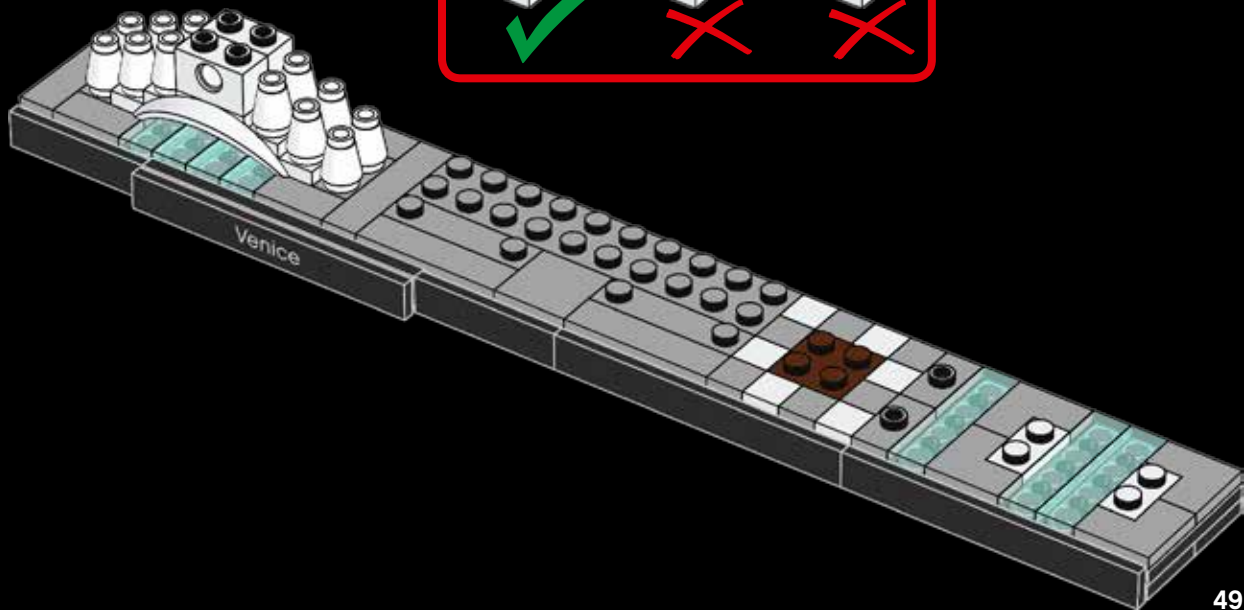



6x

32

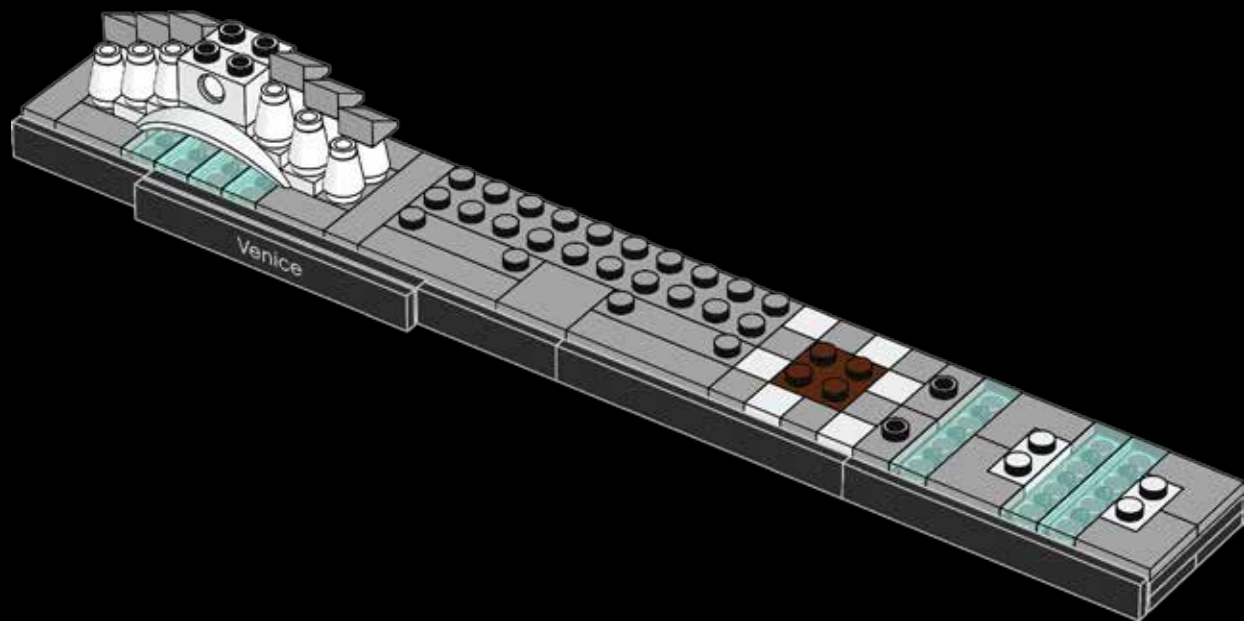

50



6x

33

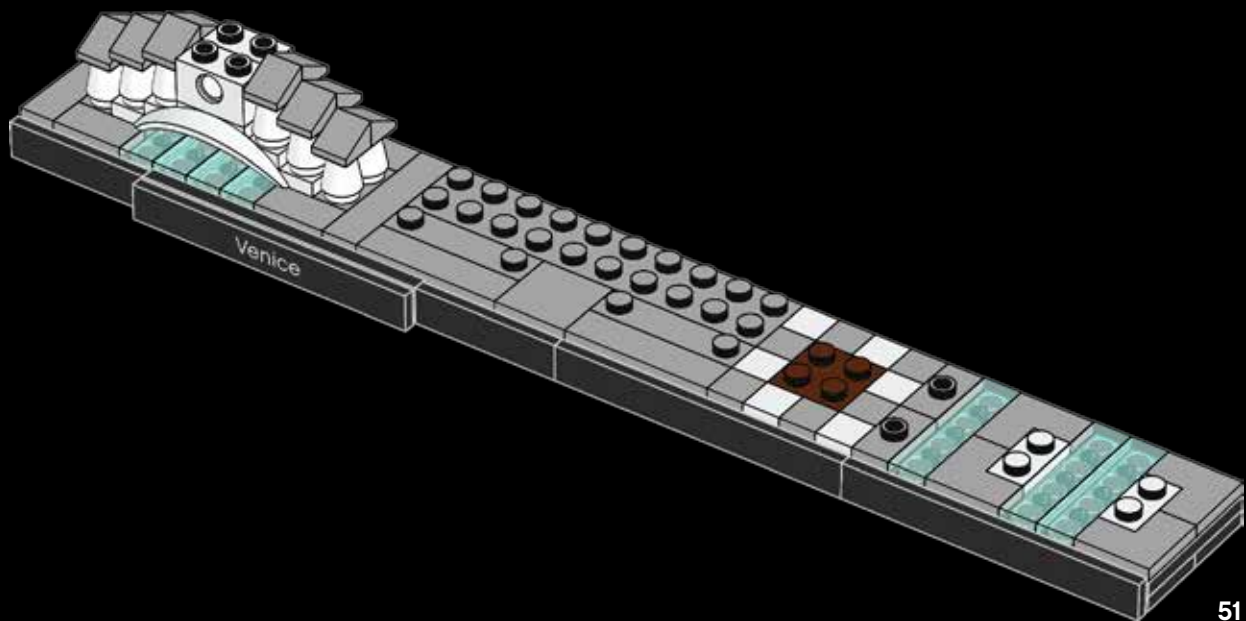



4x

34

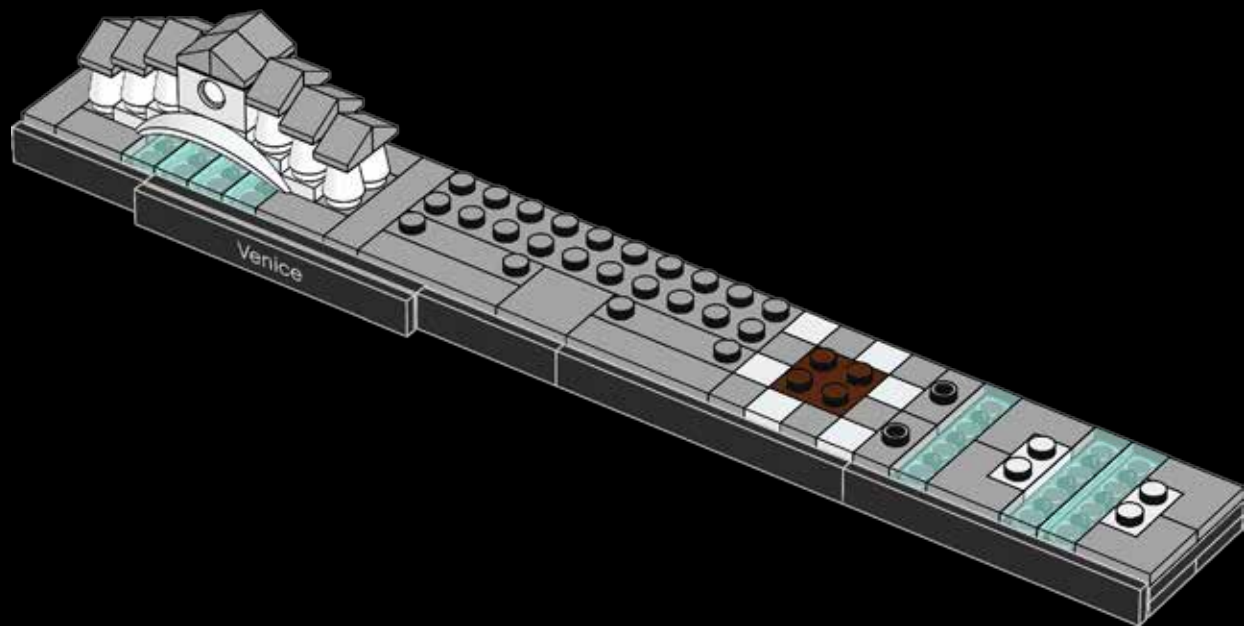



2x

35

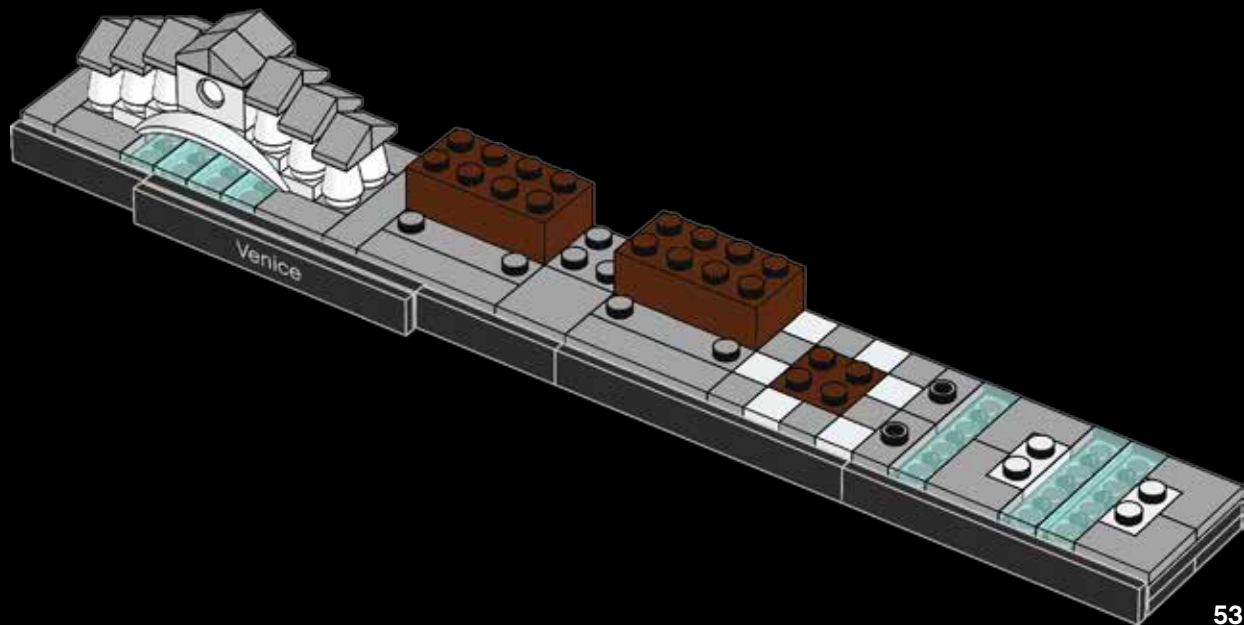

The Grand Canal is the region's largest canal. Possessing a unique S-shape, it splits the city in half.

Il Canal Grande è il canale più grande dell'intera regione. A forma di S, divide la città in due parti distinte.



© TTStudio



2x

36

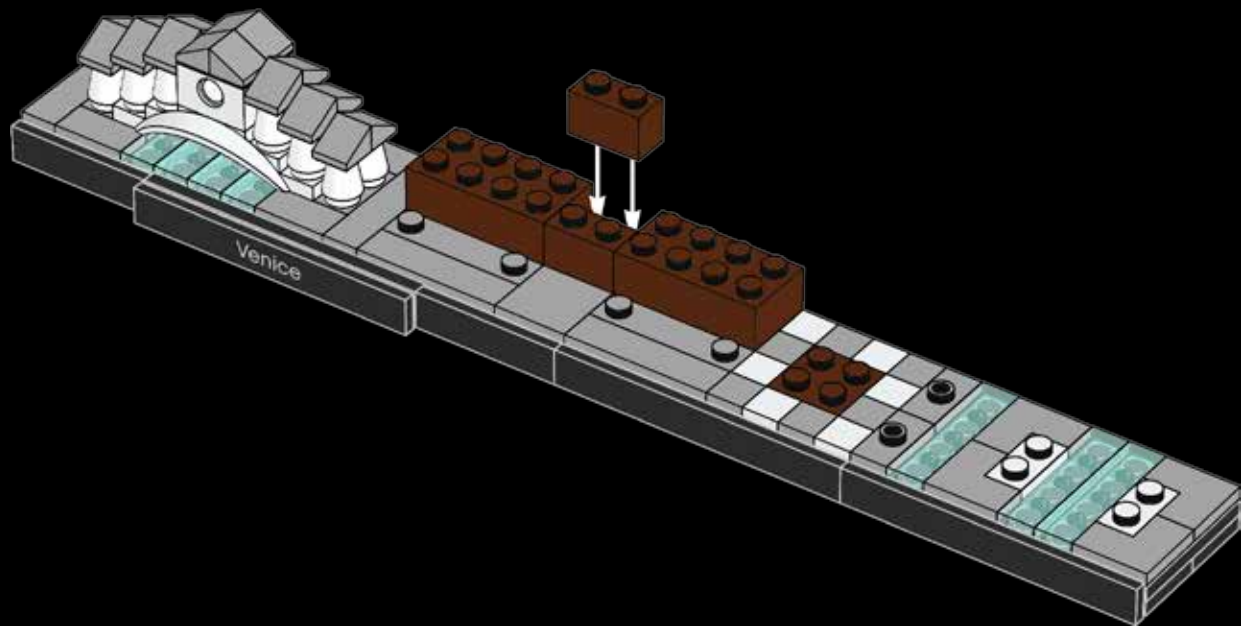



2x



2x

37

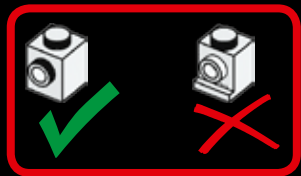
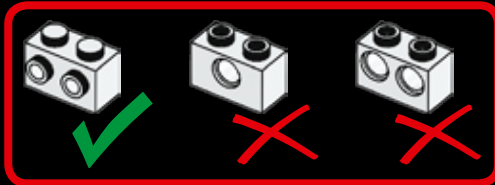
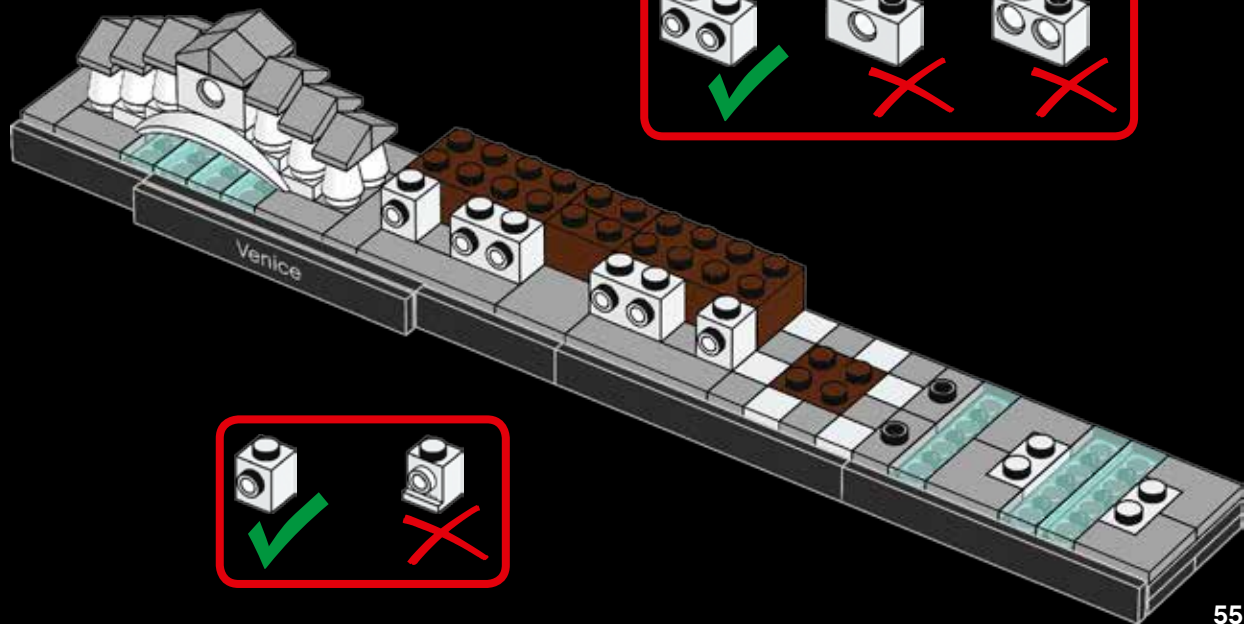



1x



2x

38

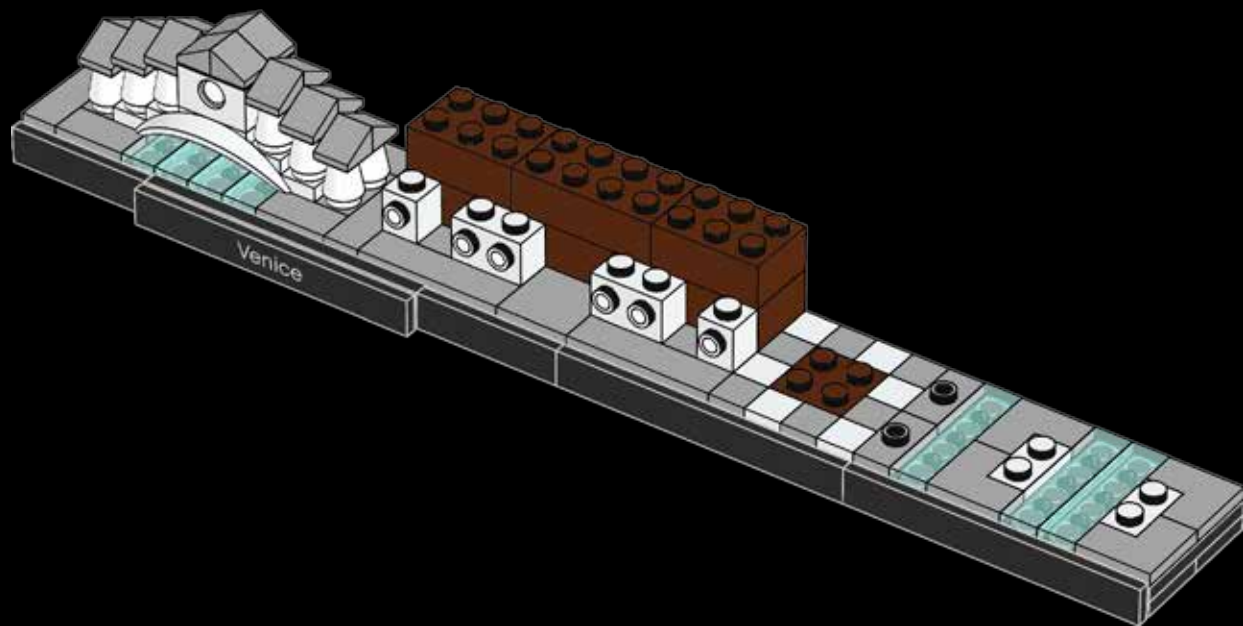

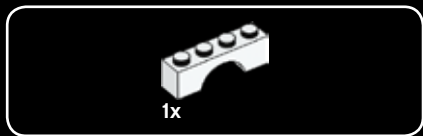

39

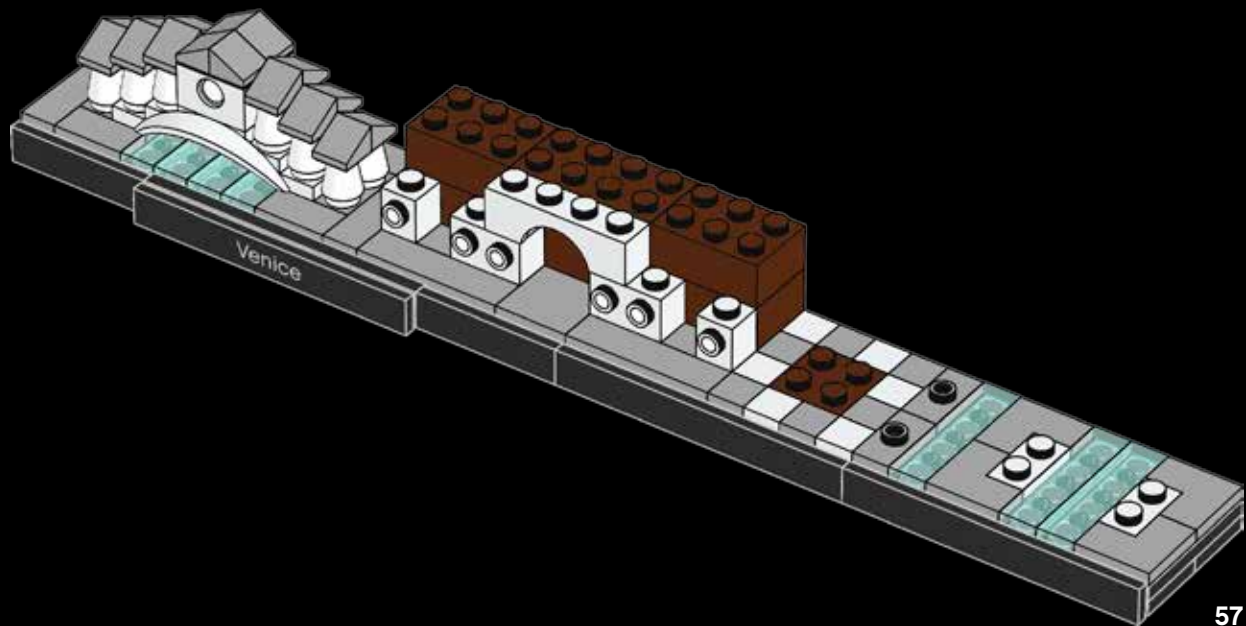



2x

40

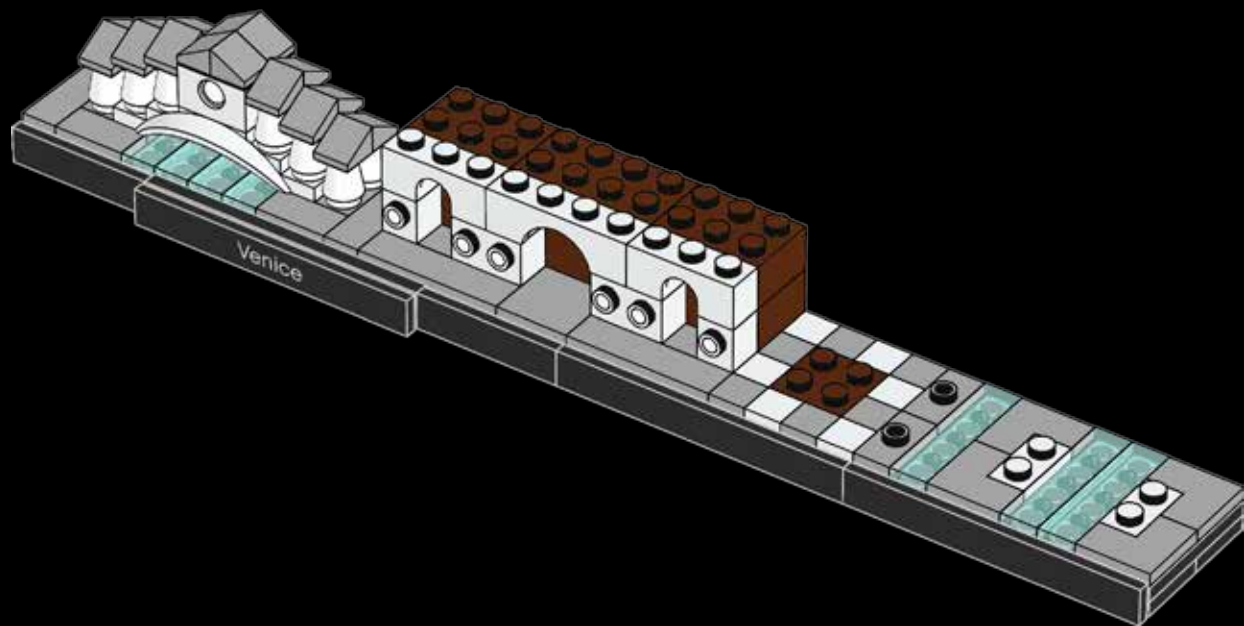

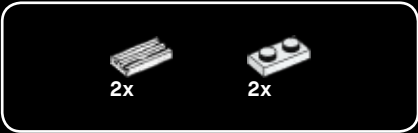

41

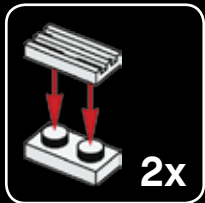
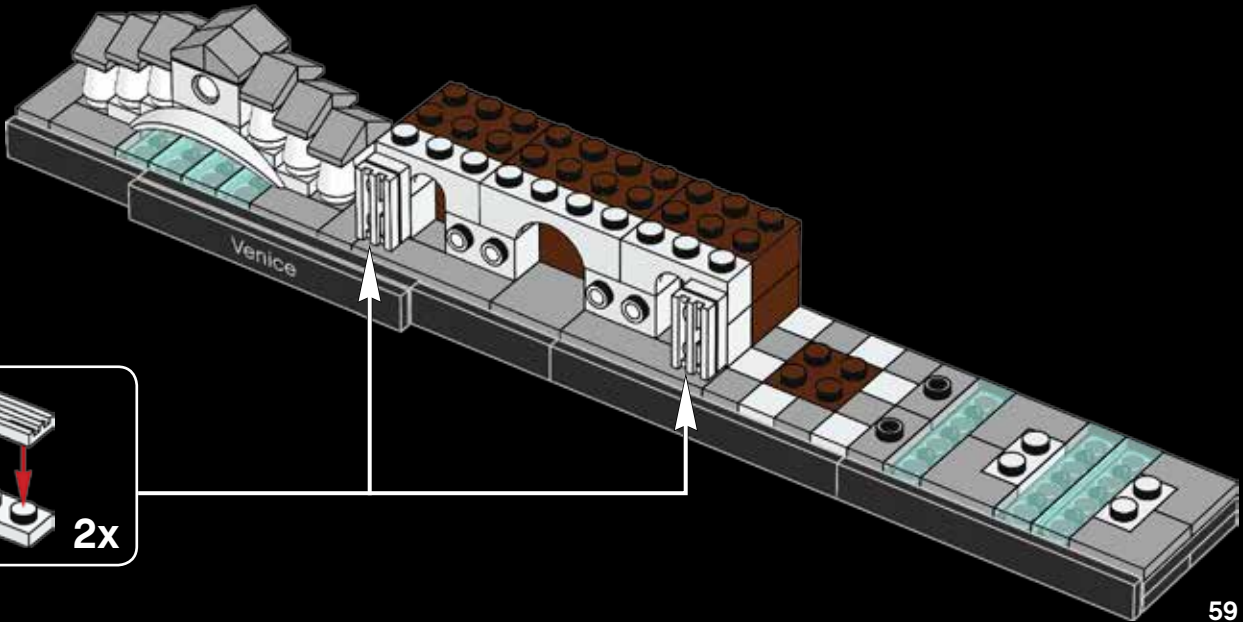



4x



2x

42

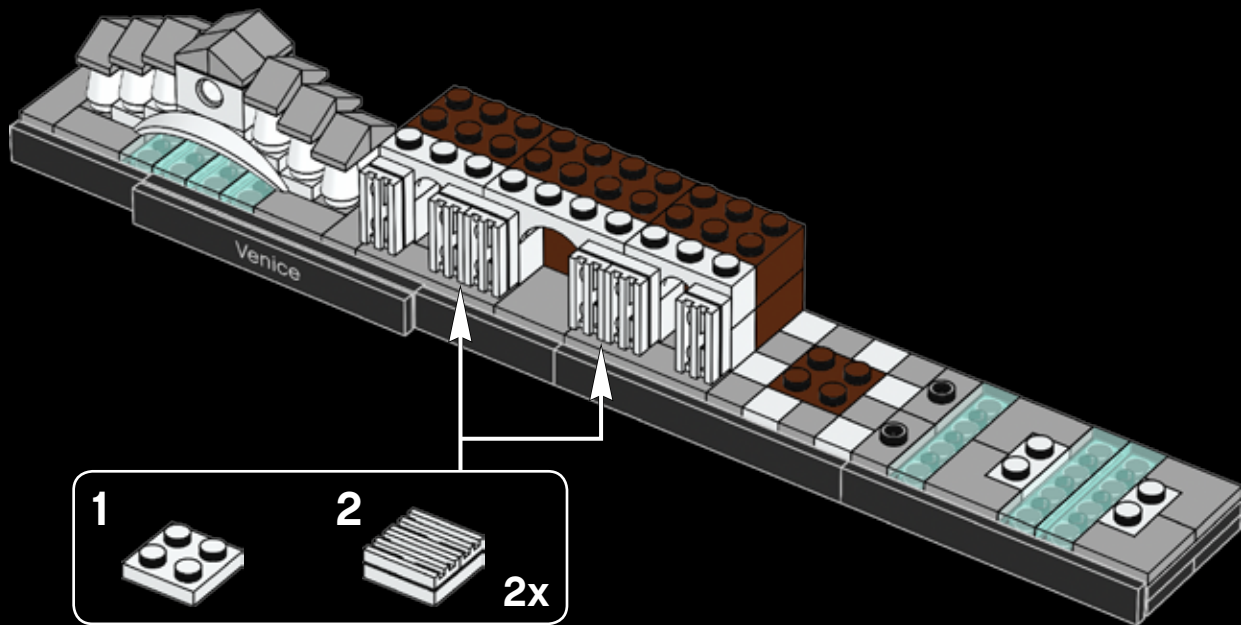

1



2

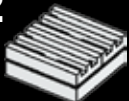

2x

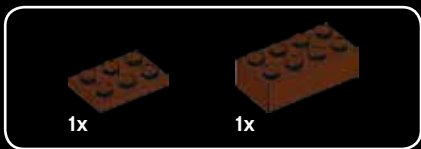

1

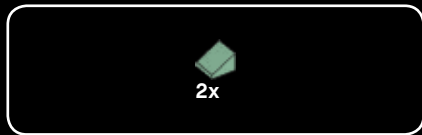
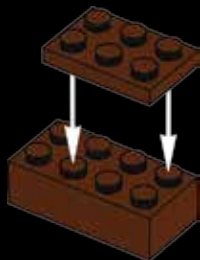

2





1x



2x

3



1x



1x

4



43

Venice has over 450 palaces and major buildings built in a mixture of styles: Gothic, Byzantine, Baroque etc.

Venezia conta oltre 450 palazzi e grandi edifici in diversi stili: gotico, bizantino, barocco, ecc.



© Iakov Kalinin

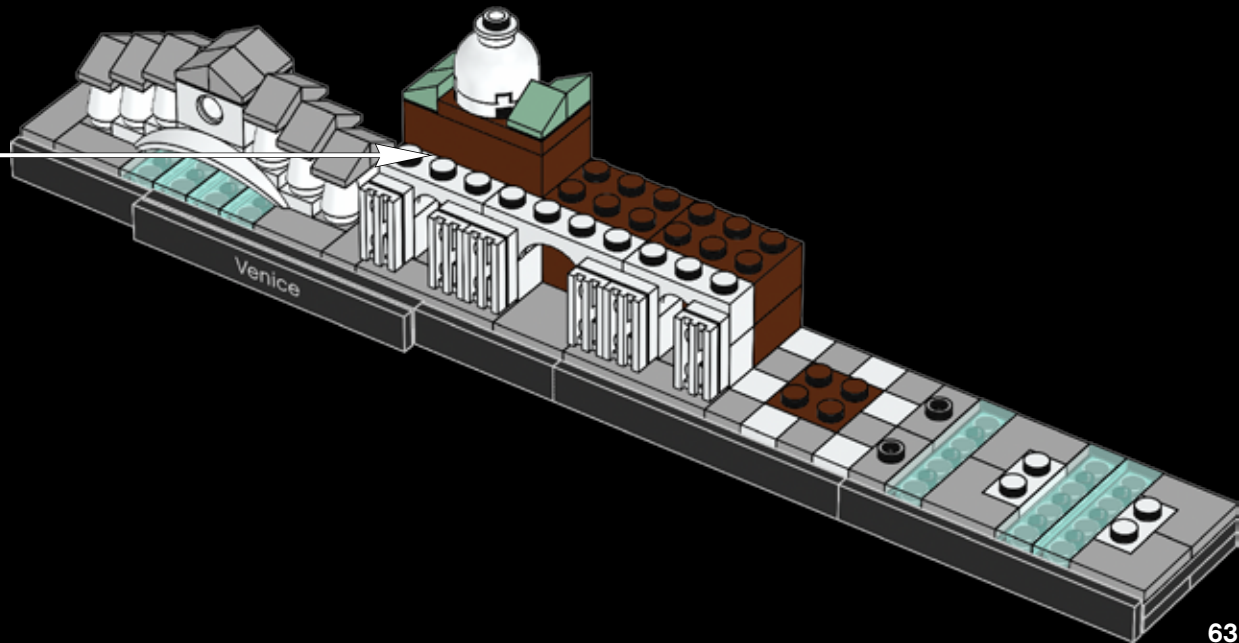

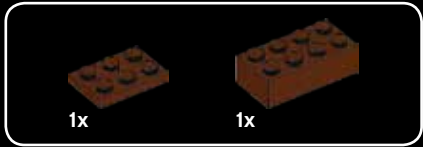

1

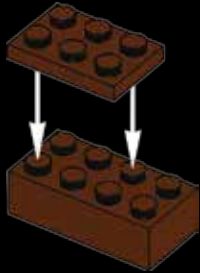

2





1x



2x

3



1x



1x

4

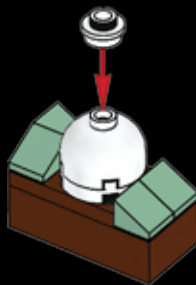

44

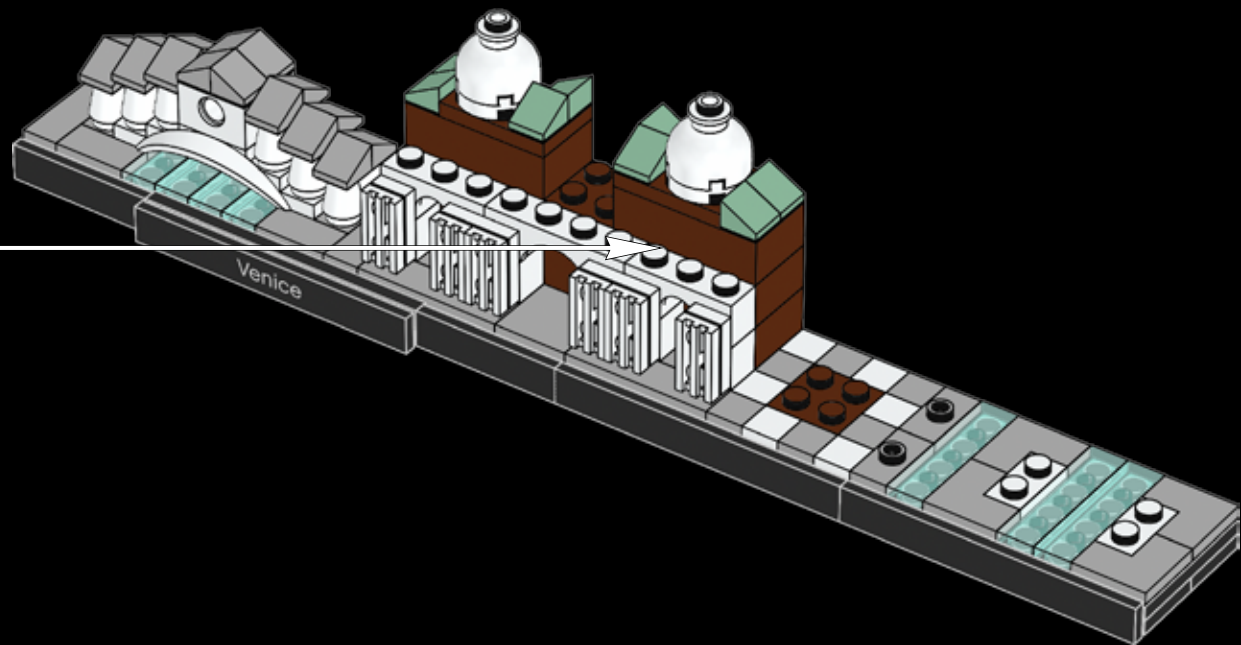



1x

45

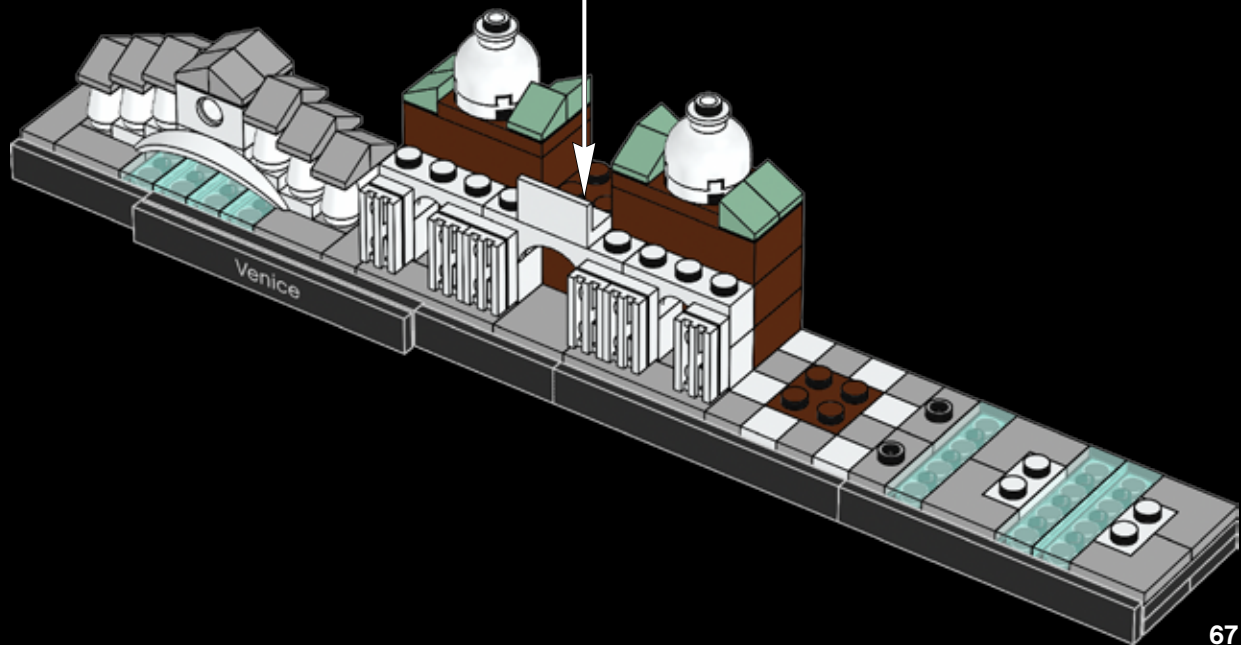
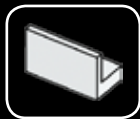



46

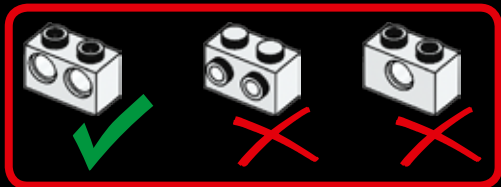
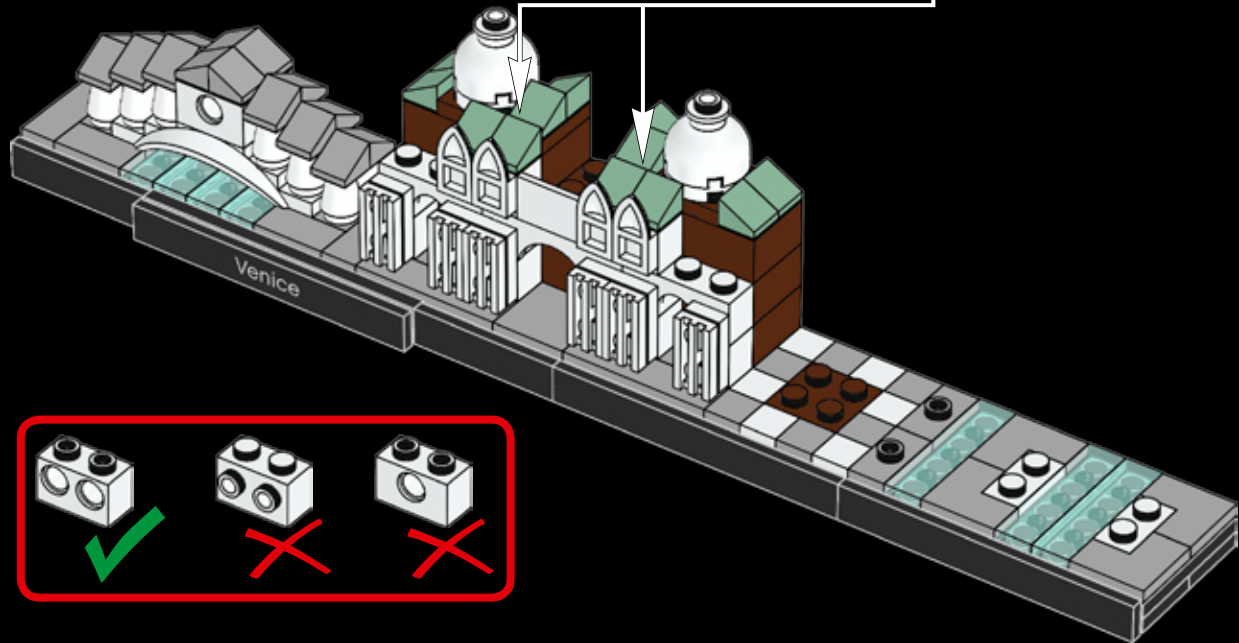
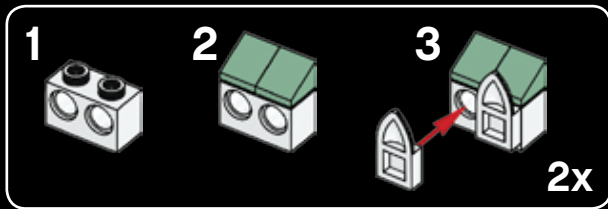



2x



2x

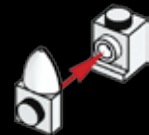

2x

47

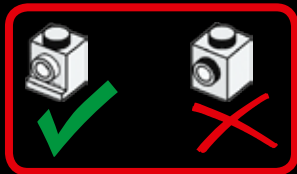
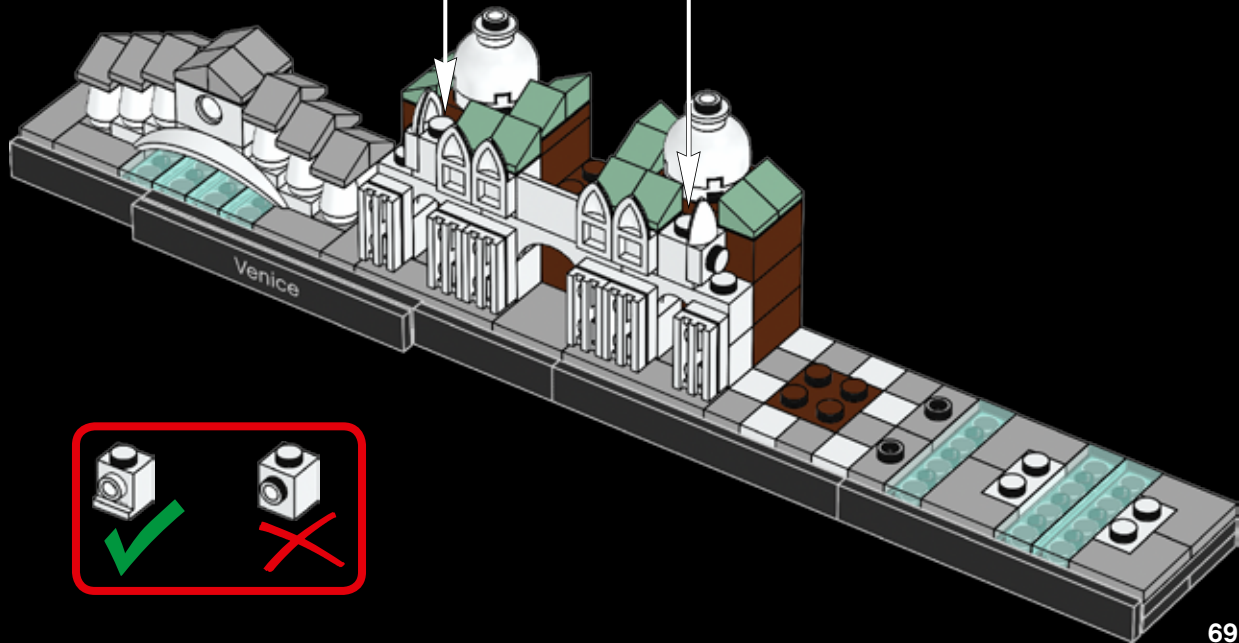



1x



1x

1

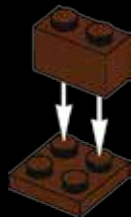

1x

2





1x

3



1x

4





1x



1x

5



2x



1x

6

1

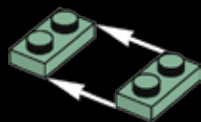

2

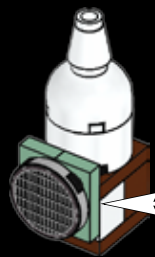
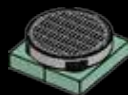

48

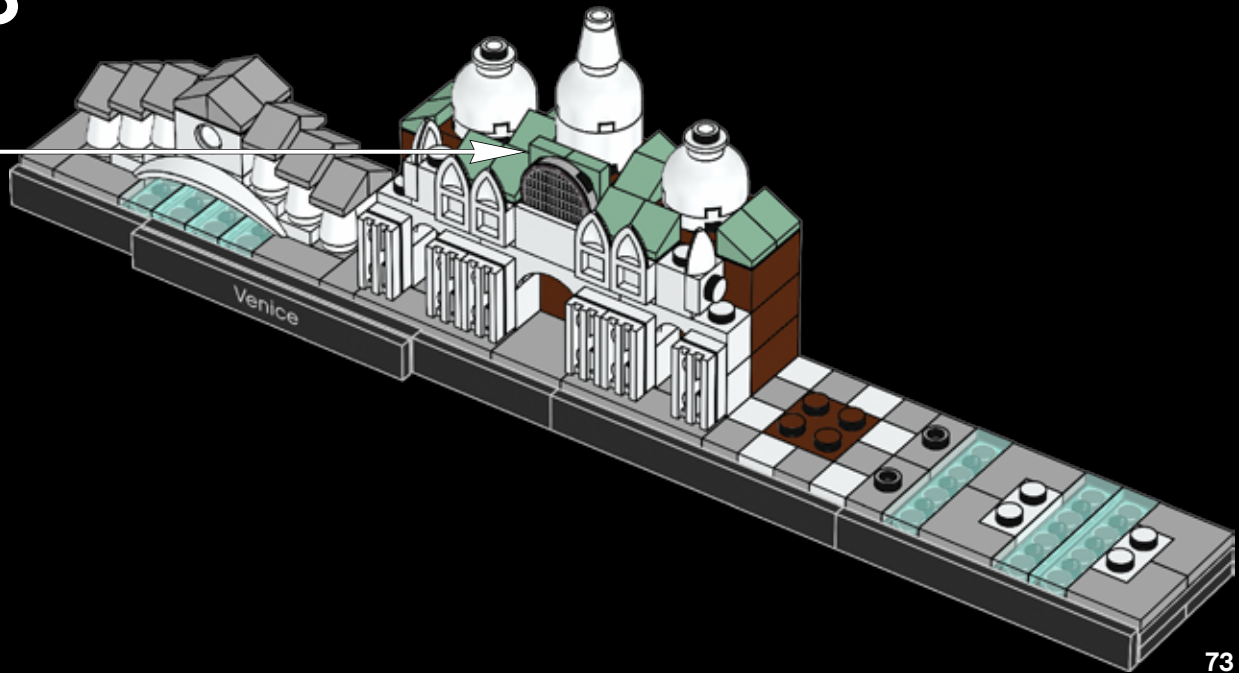



1

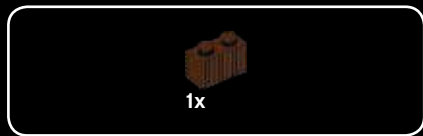
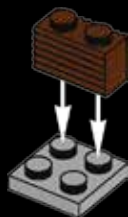

2



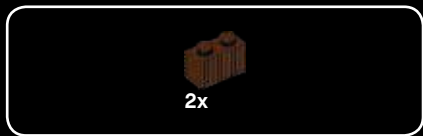

3

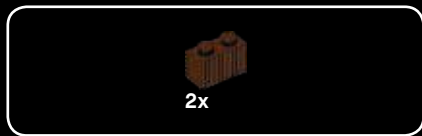

4





5



6



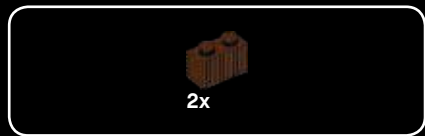

7

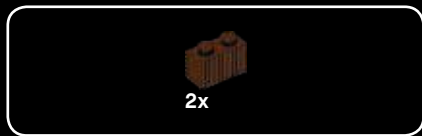

8





2x

9



2x

10





1x



1x

11

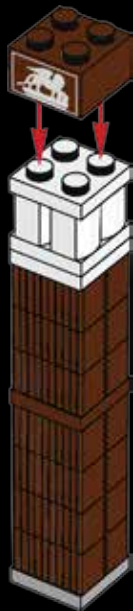

1x

12





1x



1x

13



49

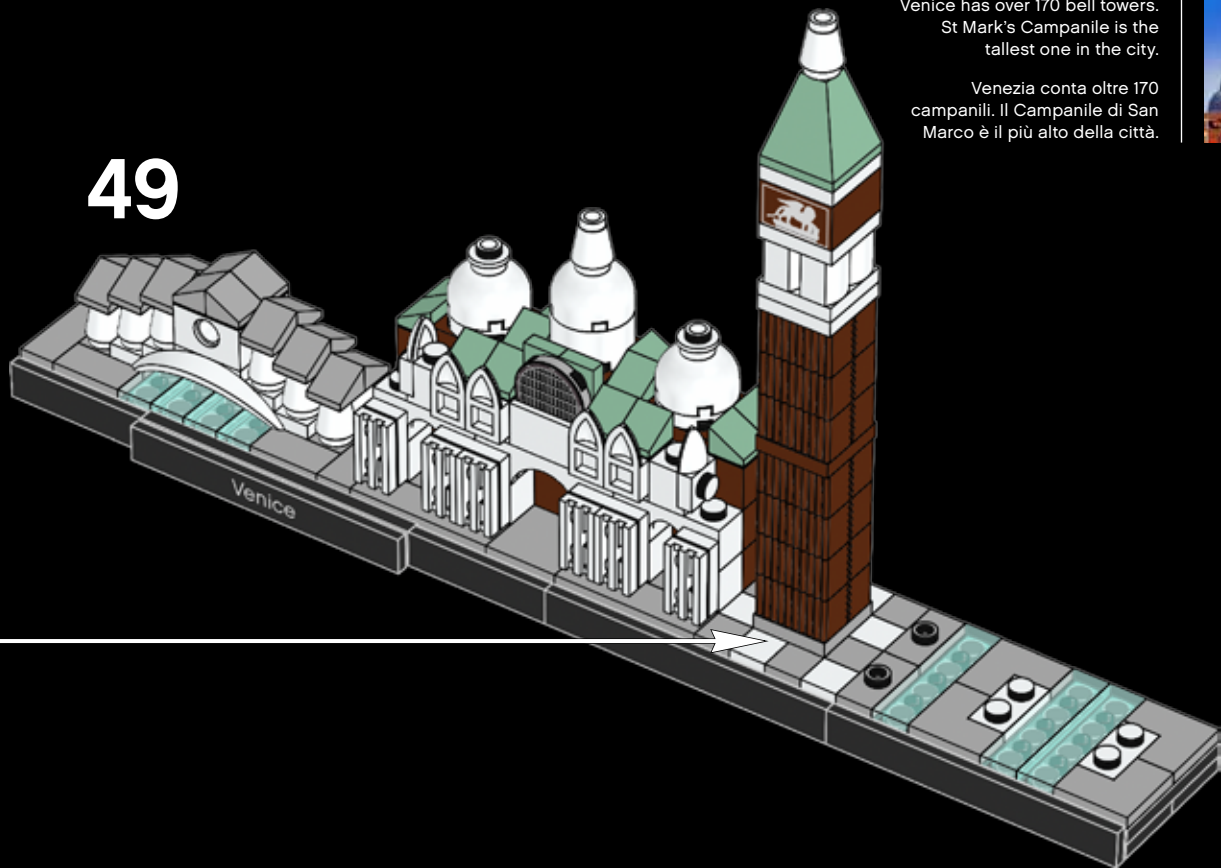

Venice has over 170 bell towers.
St Mark's Campanile is the
tallest one in the city.

Venezia conta oltre 170
campanili. Il Campanile di San
Marco è il più alto della città.



© Kkulikov



2x

50

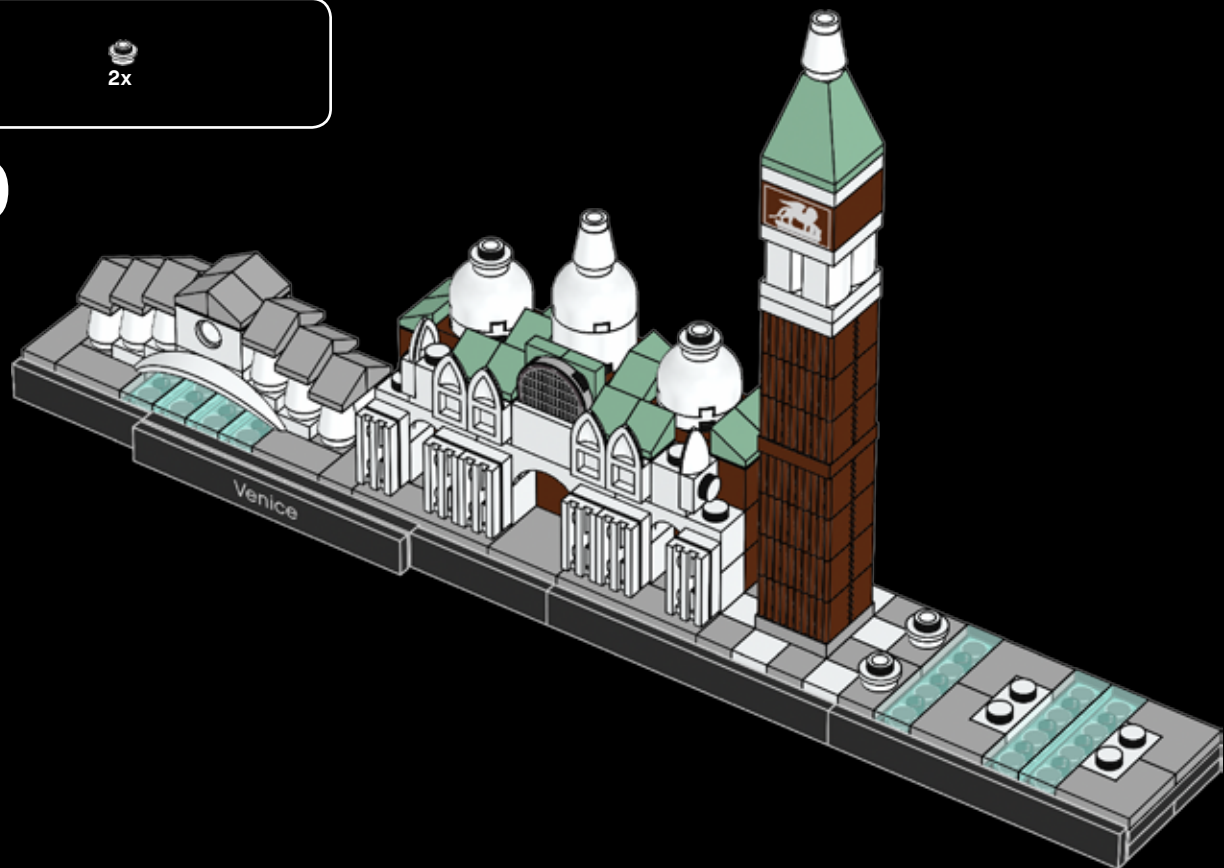



2x

51

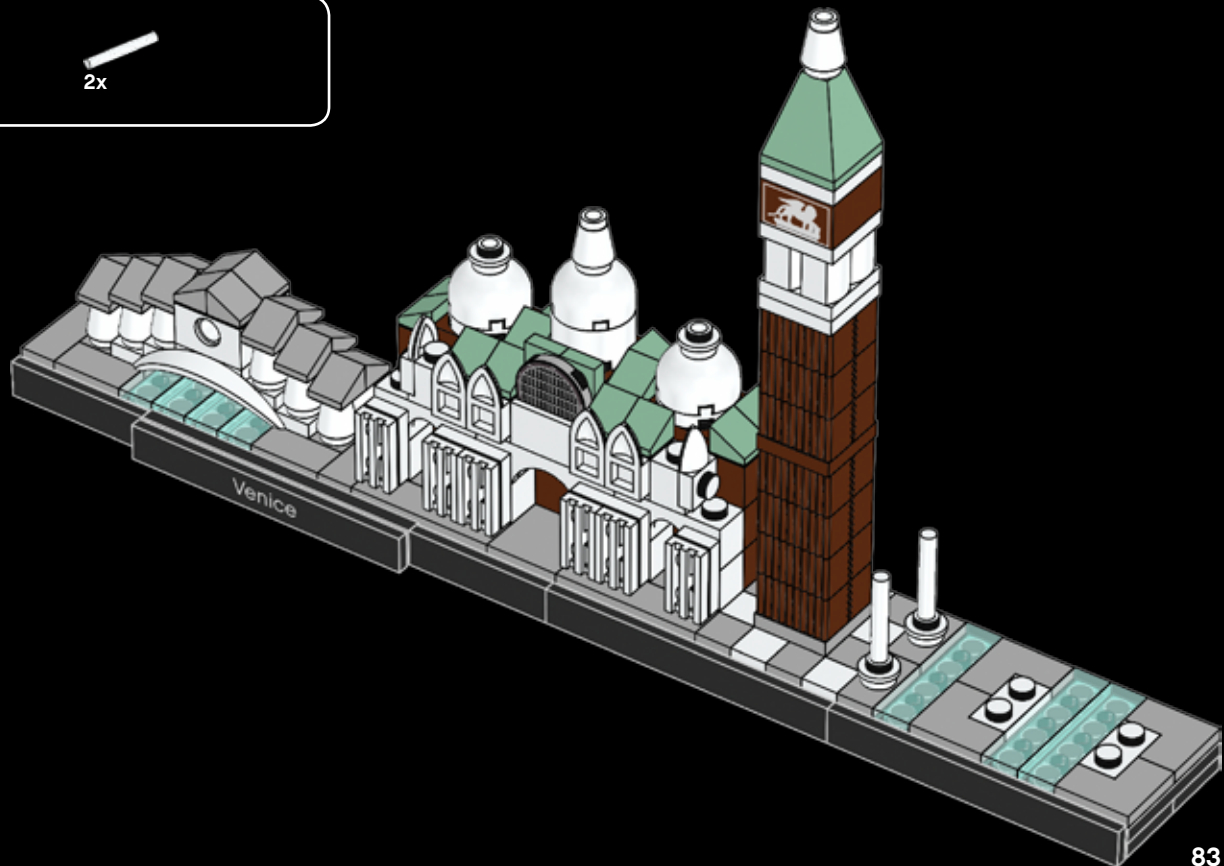



1x



1x

52

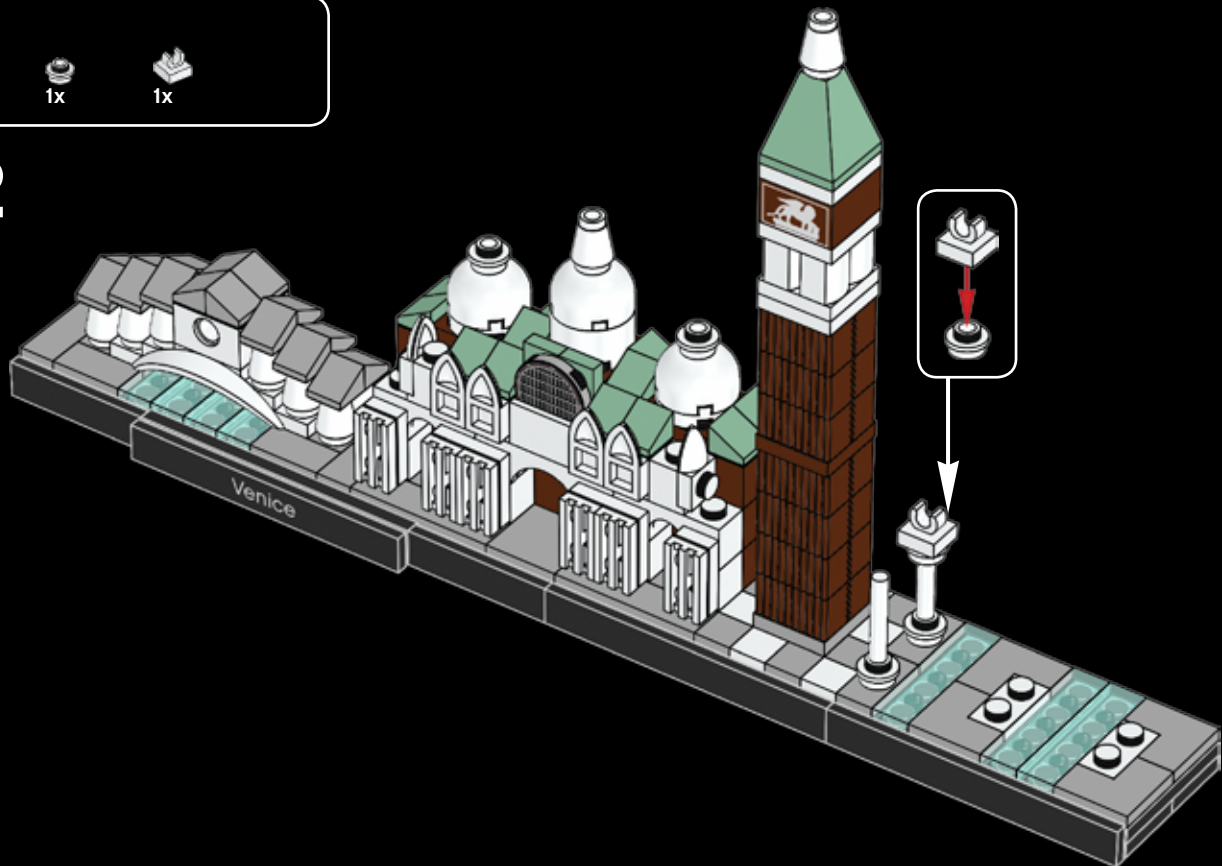



1x



1x

53

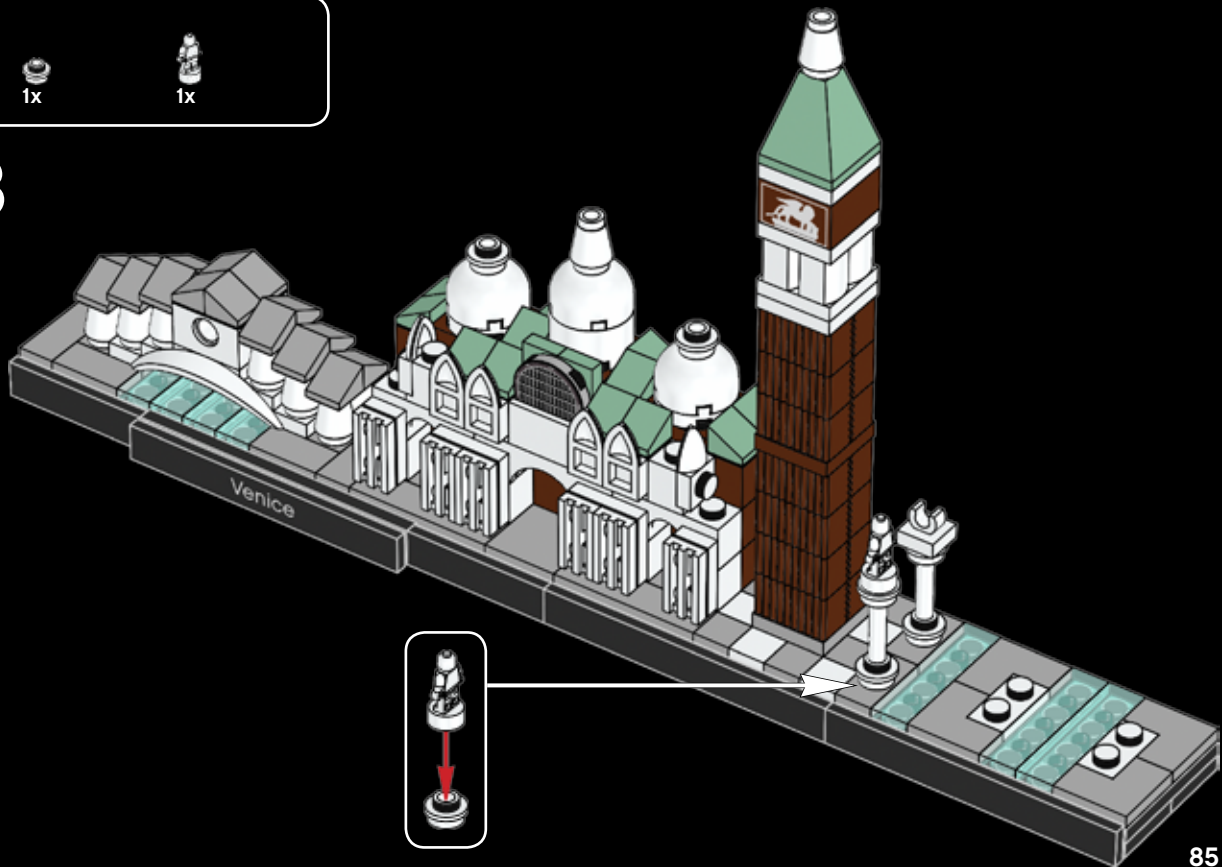



2x

54

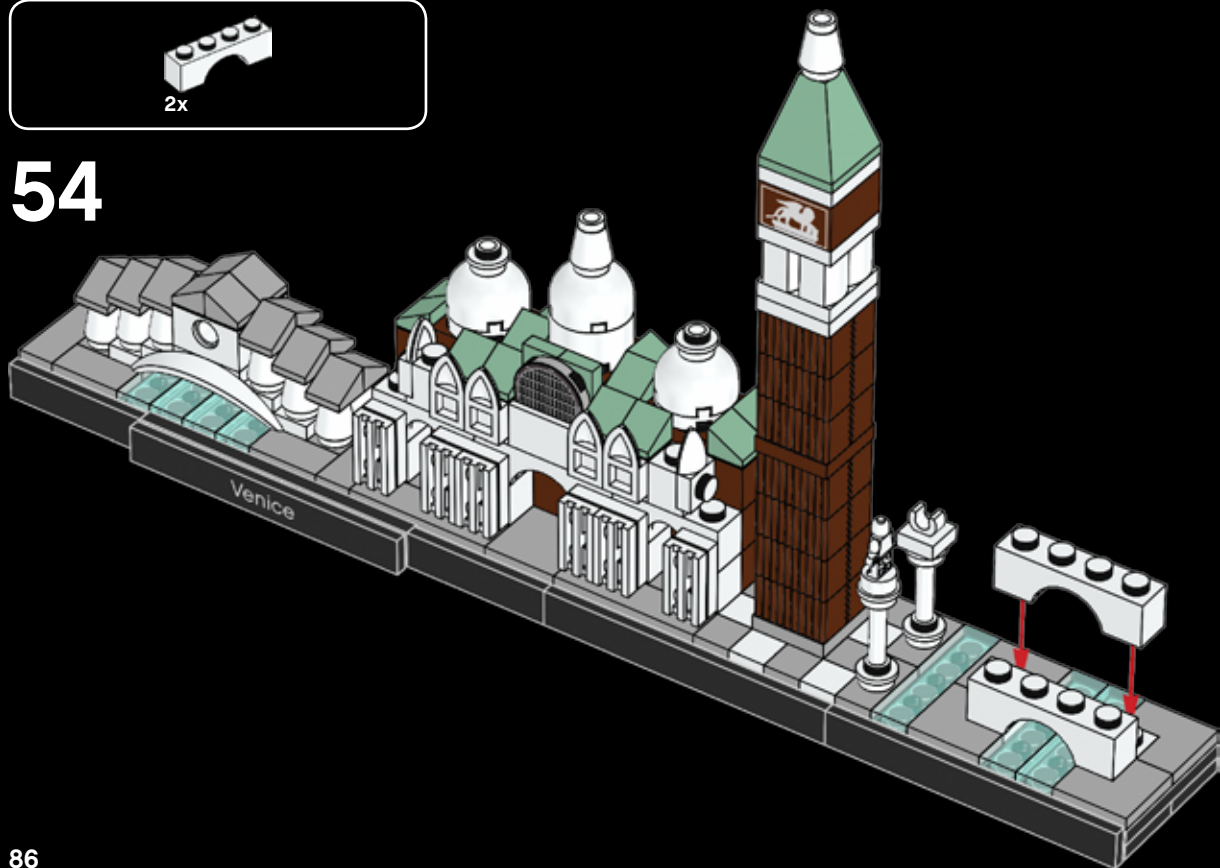



2x

55

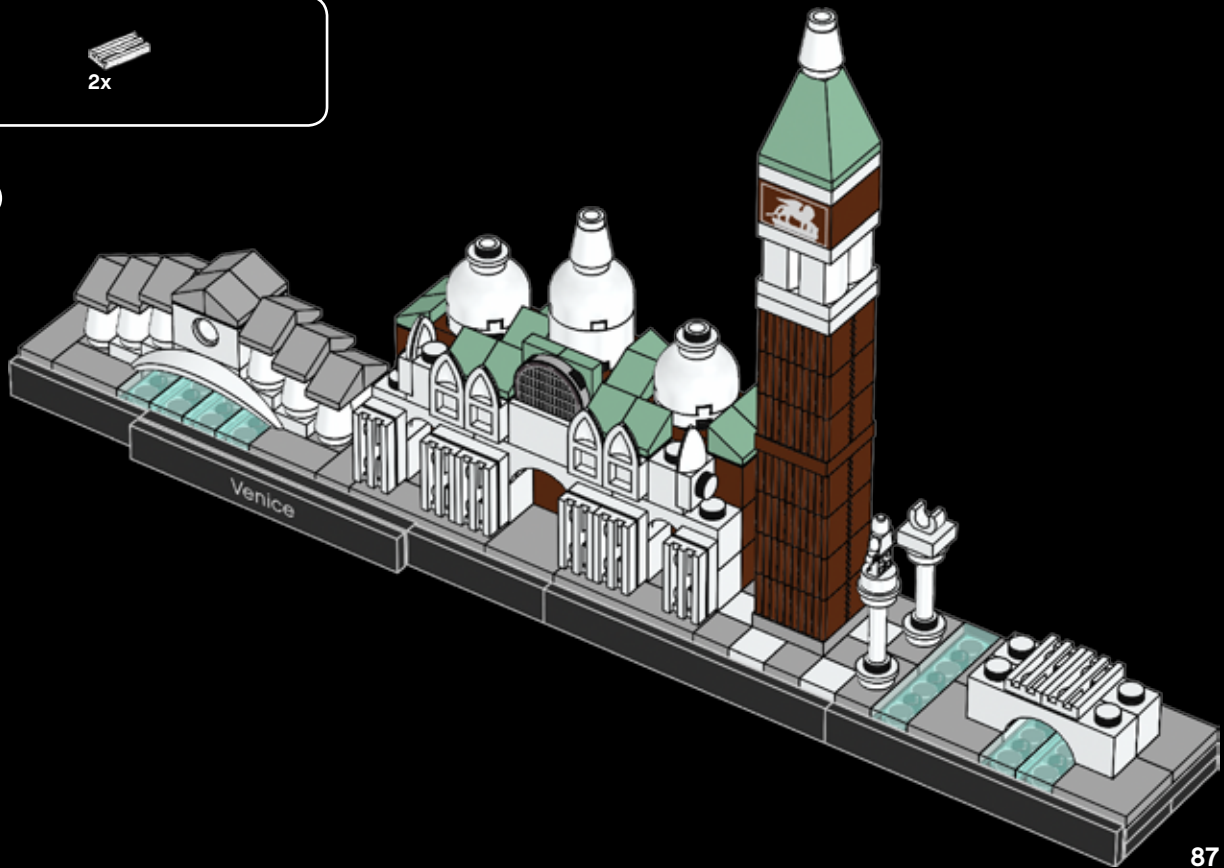



2x

56

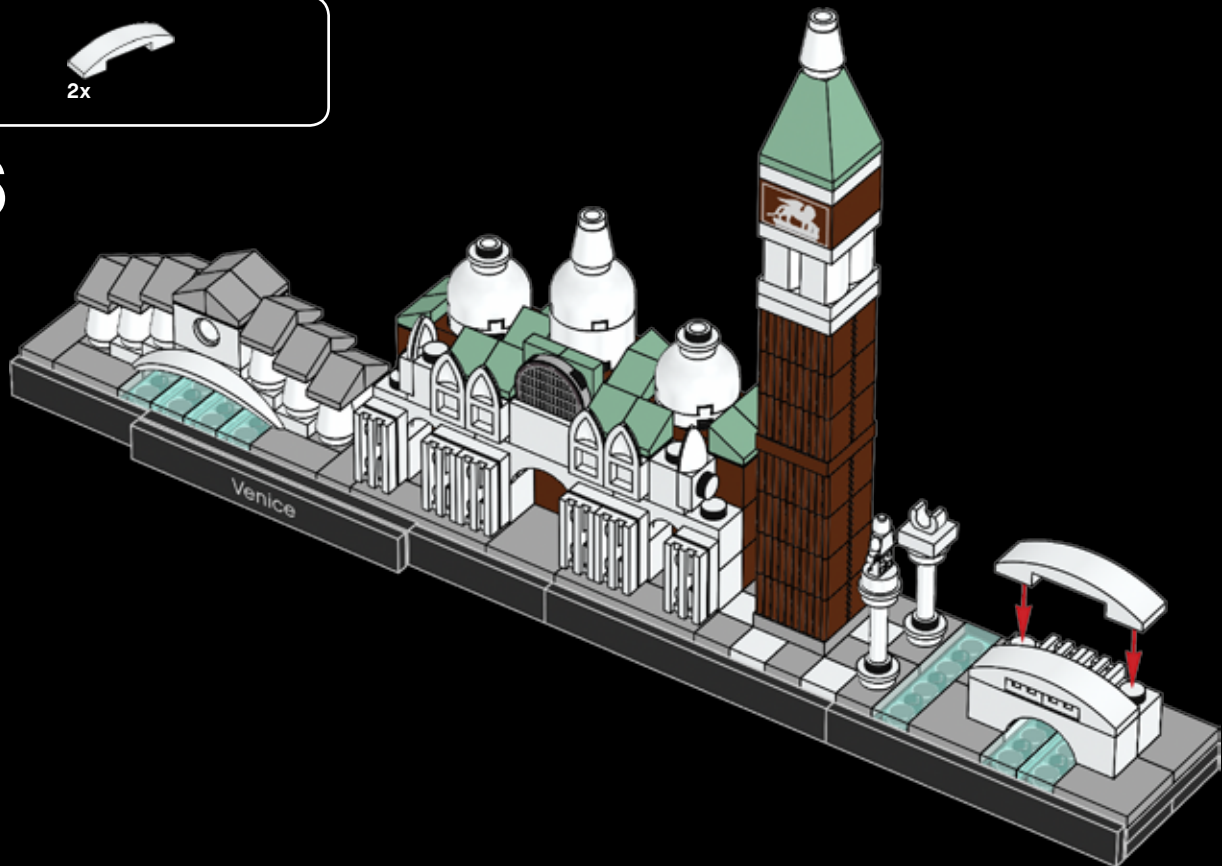



[“Venice is like eating an entire box of chocolate liqueurs in one go.”]

Truman Capote

[“Venezia è come mangiare un'intera scatola di cioccolatini al liquore in una sola volta”.]

Truman Capote



LEGO® Architecture—then and now

There has always been a natural connection between the LEGO® brick and the world of architecture. Fans who build with LEGO elements instinctively develop an interest in the form and function of the structures they create. At the same time, many architects have discovered that LEGO bricks are the perfect way of physically expressing their creative ideas.

This connection was confirmed in the early 1960s with the launch of the LEGO 'Scale Model' line. It matched the spirit of the age where modern architects were redefining how houses look and people were taking an active interest in the design of their new homes. These sets were designed to be different from the normal, brightly colored LEGO boxes; they also included a book on architecture as a source of inspiration.

Decades later, architect and LEGO fan Adam Reed Tucker revived the idea of expressing architecture using LEGO bricks and in partnership with the LEGO Group,

launched the LEGO Architecture line that we know today. His first models, and the original sets in the current LEGO Architecture series, were interpretations of famous skyscrapers from his hometown of Chicago. Since then LEGO Architecture has developed and evolved, first with well-known buildings from other cities in the United States, and now with iconic structures from Europe, the Middle East and Asia.

The introduction of our LEGO Architecture Studio set echoes the ambitions of the earlier LEGO 'Scale Model' line and widens the potential of the LEGO Architecture series. Now you can enjoy building and learning about specific landmark buildings, or create exciting architectural models from your own fantasy. An inspiring 270-page book, featuring a number of renowned architects from around the world, guides you through the principles of architecture and encourages you in your own creative building.



21050
Studio

LEGO® Architecture – Ieri e oggi

Vi è sempre stato un rapporto naturale fra i mattoncini LEGO® e il mondo dell'architettura. Gli appassionati che costruiscono con gli elementi LEGO sviluppano istintivamente un interesse per la forma e la funzione delle strutture che essi creano. Allo stesso tempo, molti architetti hanno scoperto che i mattoncini LEGO sono perfetti per esprimere fisicamente le loro idee creative.

Questo rapporto è stato consolidato all'inizio degli anni '60 con il lancio della linea "Scale Model" di LEGO. Questa linea riflette lo spirito di un'epoca in cui gli architetti modernisti stavano ridefinendo il concetto di edificio e le persone cominciarono a interessarsi attivamente al design delle loro abitazioni. Questi set furono progettati per essere diversi dalle solite coloratissime confezioni LEGO e comprendevano anche un libro di architettura come fonte di ispirazione.

Alcuni decenni più tardi, l'architetto e appassionato di LEGO, Adam Reed Tucker, rilanciò l'idea di esprimere

l'architettura con i mattoncini LEGO e, in collaborazione con il Gruppo LEGO, ideò la linea LEGO Architecture che conosciamo oggi. I suoi primi modelli e i set originali della corrente serie LEGO Architecture erano interpretazioni dei famosi grattacieli della sua città natale, Chicago. Da allora, LEGO Architecture si è sviluppata e si è evoluta, in primo luogo con edifici ben noti di altre città degli Stati Uniti e ora con strutture iconiche di Europa, Medio Oriente e Asia.

L'introduzione del nostro set LEGO Architecture Studio riecheggia le ambizioni della linea LEGO "Scale Model" originale e amplia le potenzialità della serie LEGO Architecture. Ora è possibile costruire e conoscere specifici edifici storici o creare avvincenti modelli architettonici utilizzando la propria fantasia. Un affascinante volume di 270 pagine, comprendente i progetti di numerosi e rinomati architetti di tutto il mondo, illustra i principi dell'architettura e incoraggia a usare la propria creatività nelle costruzioni.



21050
Studio

Celebrate the world of architecture and collect all the models
Celebra il mondo dell'architettura e colleziona tutti i modelli

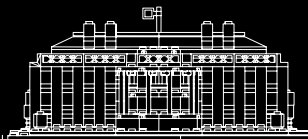

21006
The White House
Casa Bianca

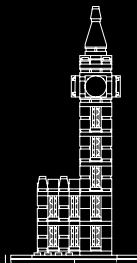

21013
Big Ben

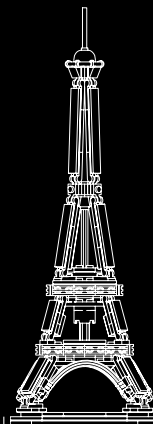

21019
The Eiffel Tower
Torre Eiffel

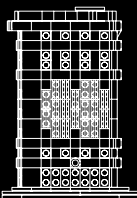

21023
Flatiron Building
Grattacielo Flatiron



21024
Louvre



21020
Trevi Fountain
Fontana di Trevi

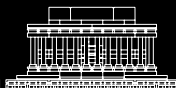

21022
Lincoln Memorial



21027
Berlin
Berlino



21028
New York City

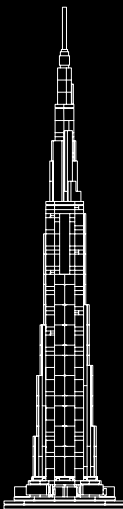

21031
Burj Khalifa

References

Pictures -

© *Shutterstock*

© *Iakov Kalinin*

© *pio3*

© *KKulikov*

© *TTstudio*

© *Kite_rin*

Text -

www.comune.venezia.it

www.basilicasanmarco.it

Riferimenti

Immagini -

© *Shutterstock*

© *Iakov Kalinin*

© *pio3*

© *KKulikov*

© *TTstudio*

© *Kite_rin*

Testo -

www.comune.venezia.it

www.basilicasanmarco.it

1x
6073432

14x
4518400

6x
4547649

1x
6054551

2x
407001

2x
4558952

6x
307001

6x
4224792

2x
403201

3x
4216652

1x
614301

2x
6059185

2x
3200001

3x
6058177

8x
241201

2x
370001

4x
302301

1x
486501

2x
6093526

6x
302201

2x
4520970

3x
365901

2x
6023806

2x
4523556

4x
302326

2x
302226

2x
243126

4x
371026

5x
4653049

1x
6135202

4x
346026

2x
416226

6x
303426

7x
4586557

12x
4652205

2x
4655080

1x
6136563

14x
4223303

3x
4211149

4x
4216695

1x
6142085

2x
4211189

2x
4216668

5x
4211201

16x
4521921

6x
4211415

1x
6052204

2x
6066097

4x
4211414

4x
4211397

1x
4211413

4x
6065824

2x
4599498

4x
4211356

2x
4211462

Customer Service
Kundenservice
Service Consommateurs
Servicio Al Consumidor
LEGO.com/service or dial

00800 5346 5555 : 
1-800-422-5346 : 



LEGO and the LEGO logo are
trademarks of the
LEGO Group.
©2016 The LEGO Group. 6160897

