



NEXO KNIGHTS



70327







1



2

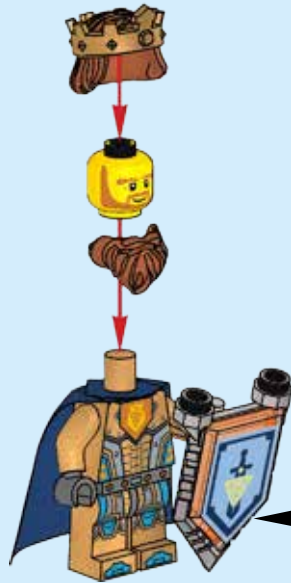

3

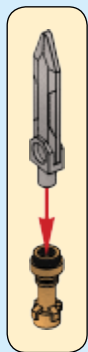

1

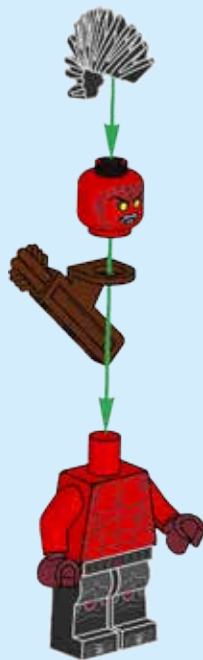

2





2x



1x

1

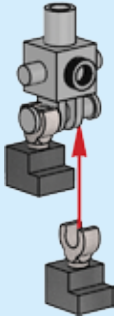

1x



1x

2



2x



2x

3

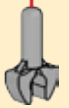

2x



1x



1x

4





1



2

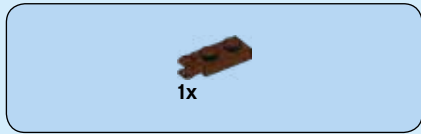

3





4



5

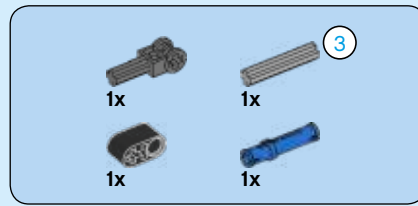

6

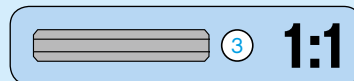
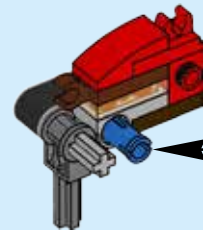
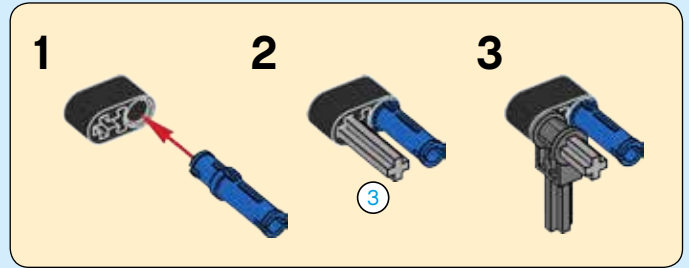



1x

7

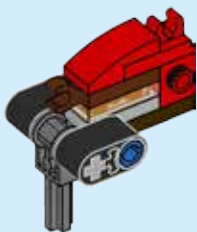

1x

8

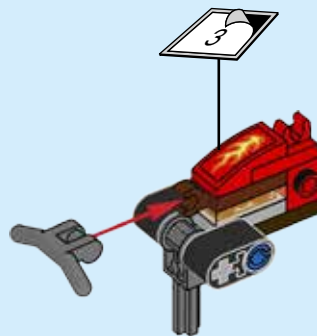

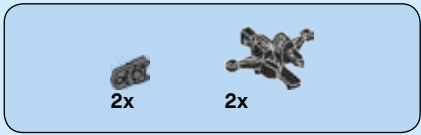

9

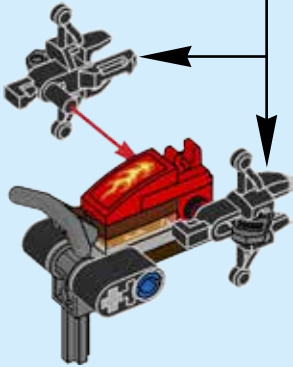
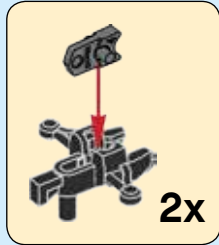

10

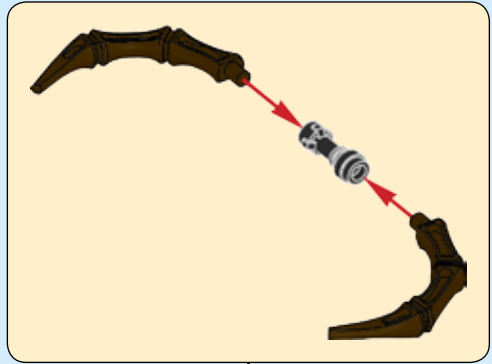

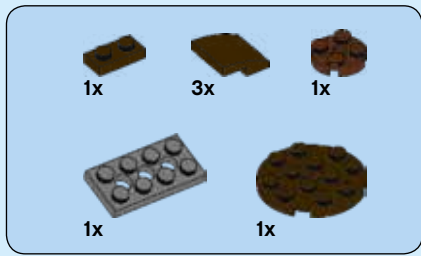

11

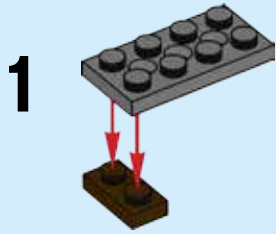

4x



12

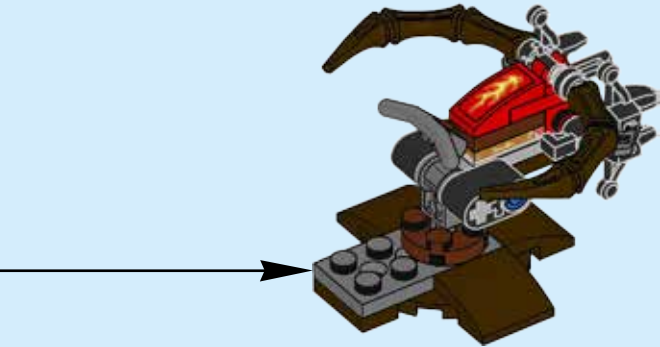
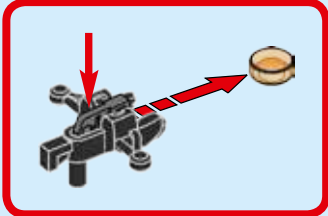

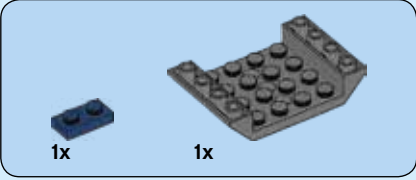

1

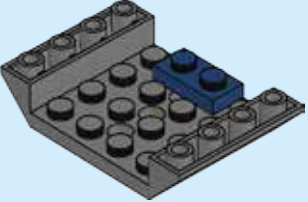

2

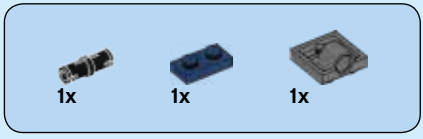
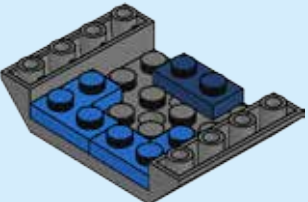

3

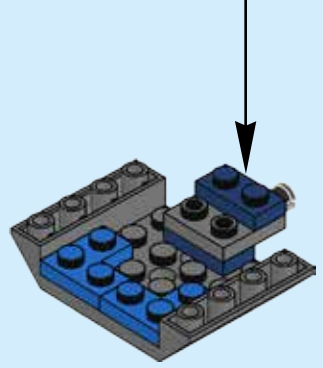
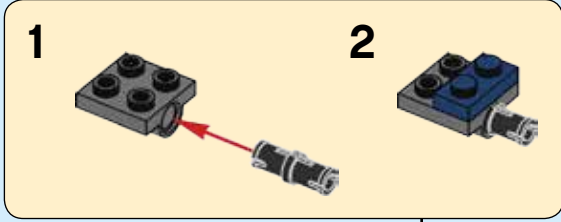



2x



1x

4

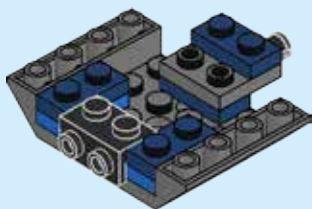

1x



2x

5

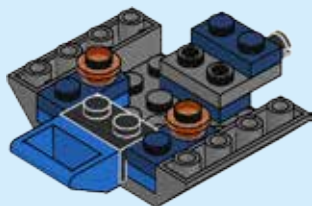

2x

6

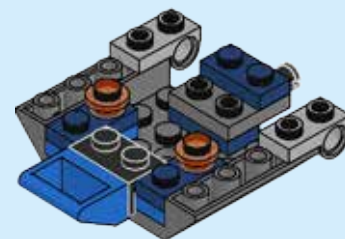



2x

7

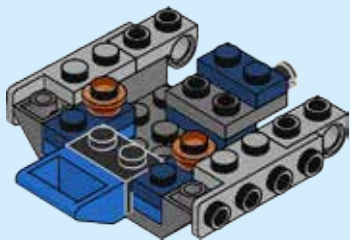

1x

8

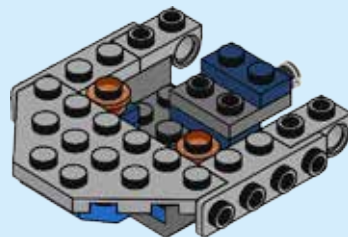

2x

9

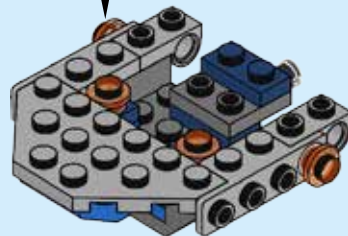

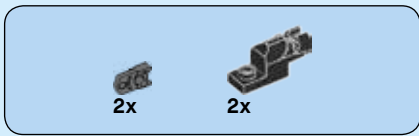

10

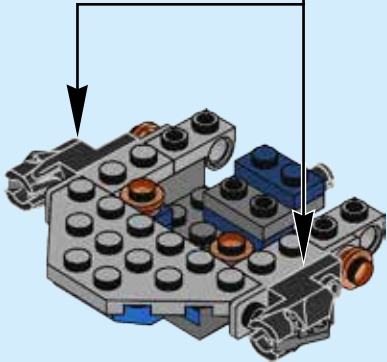
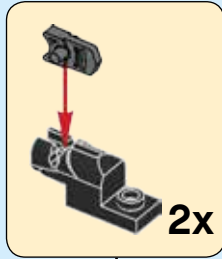

11

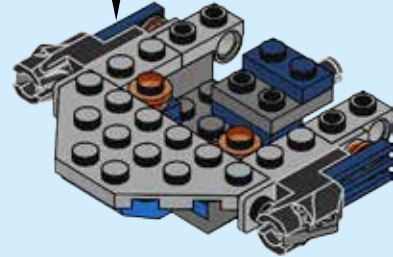

12



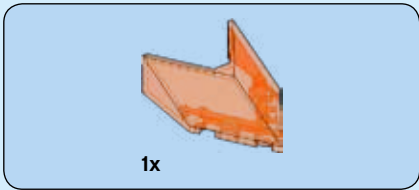

13

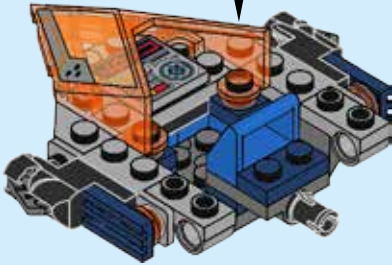
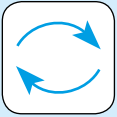
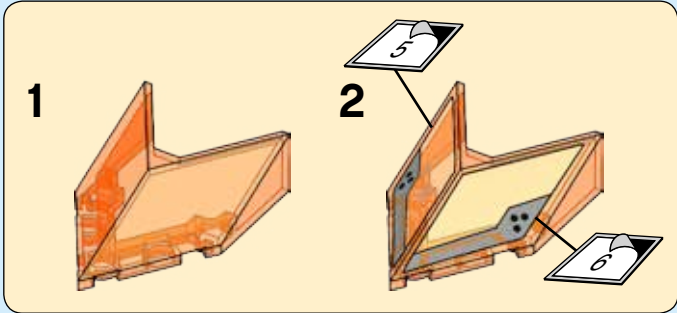

14

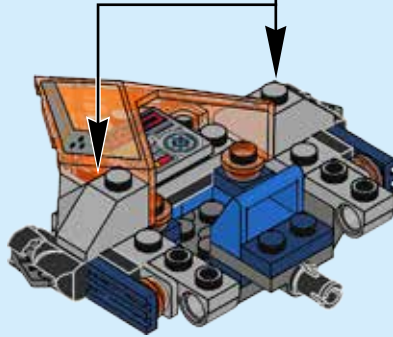



2x

15

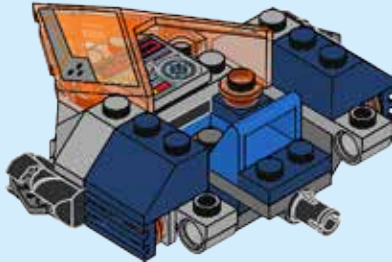

2x

16

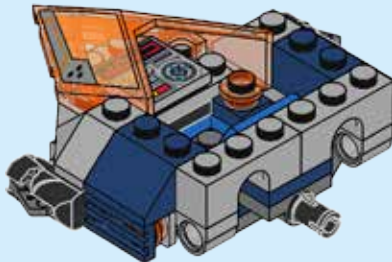

1x

17

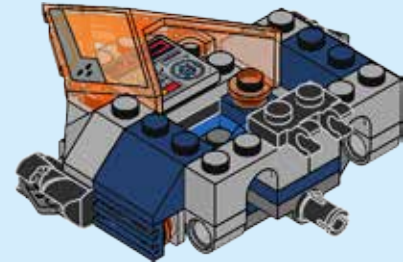

2x



2x



1x

18

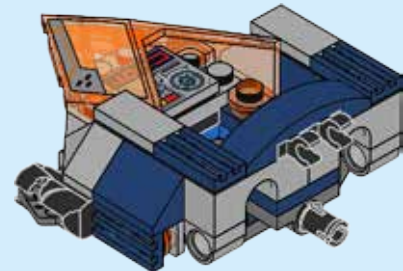



2x

19

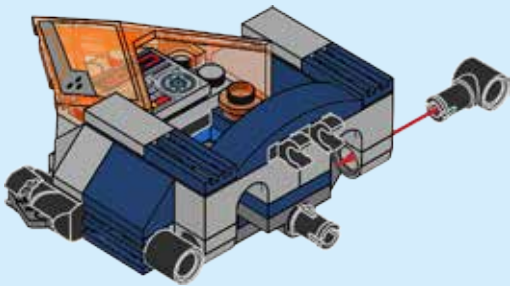

2x



2x

20

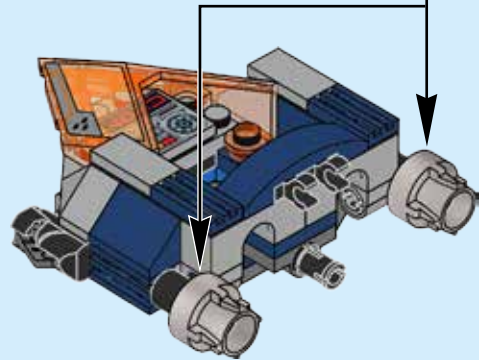
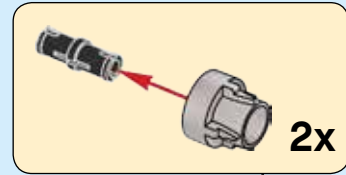



1x

21

1



2

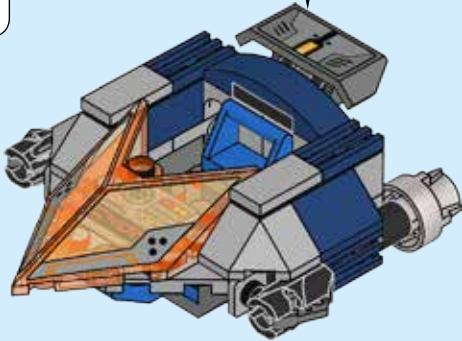

4x

22

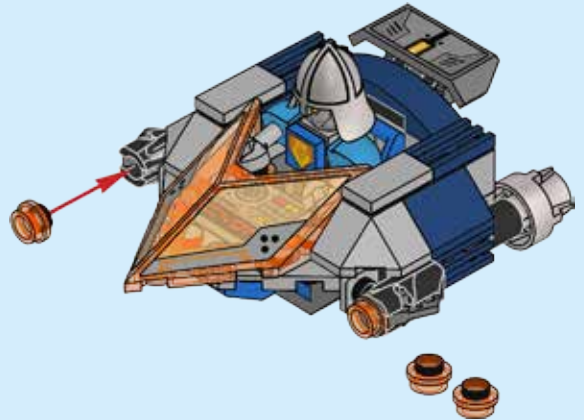
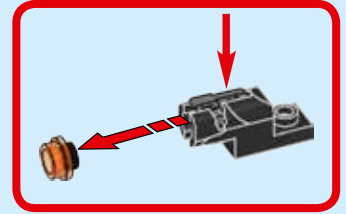



1

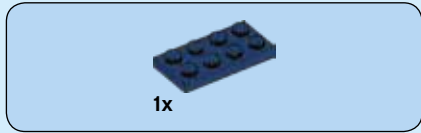
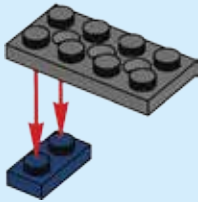

2

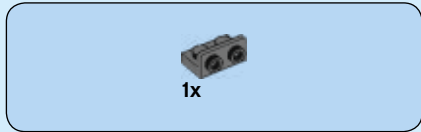
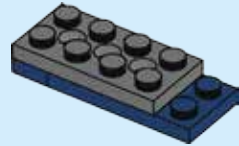

3





4

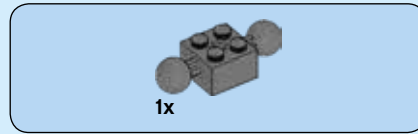
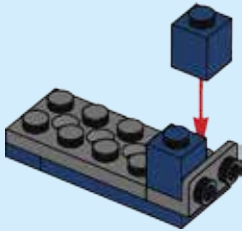

5

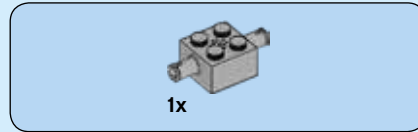
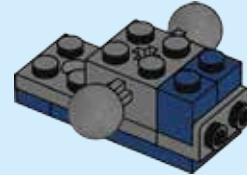

6

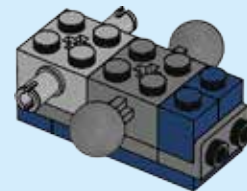

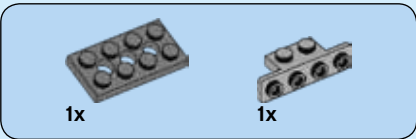

7

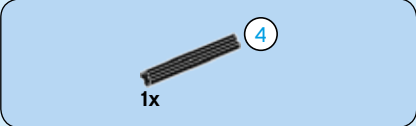
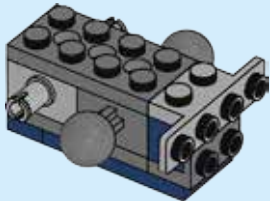

8

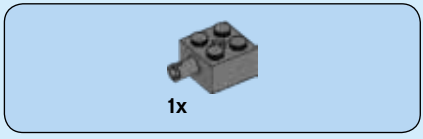
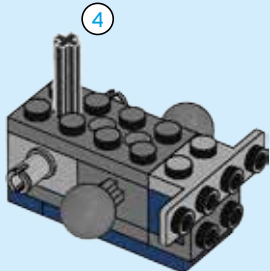

9

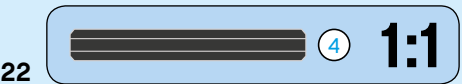
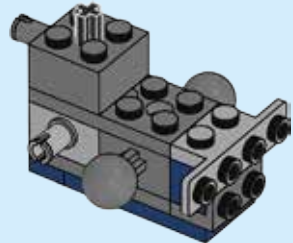

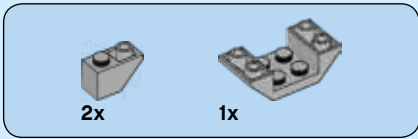

10

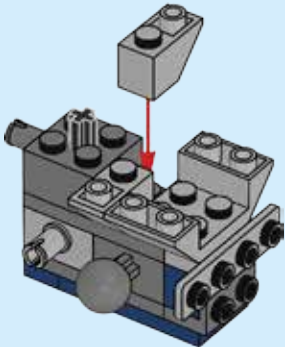

11

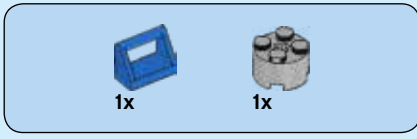
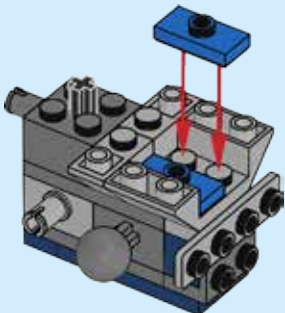

12

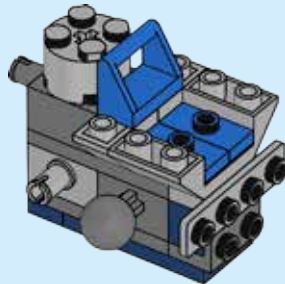



1x

13

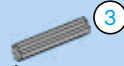
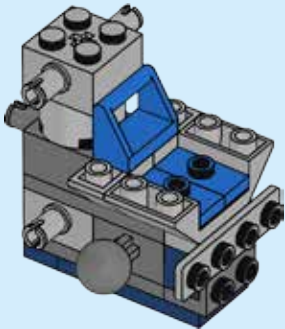

1x

14

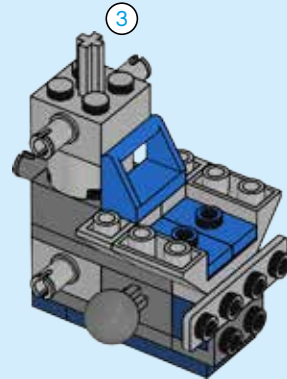

3

1:1



15

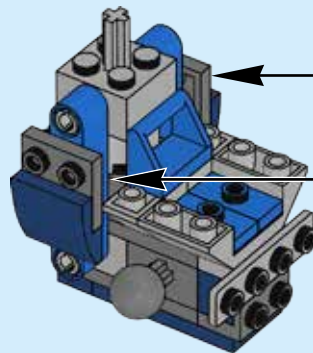
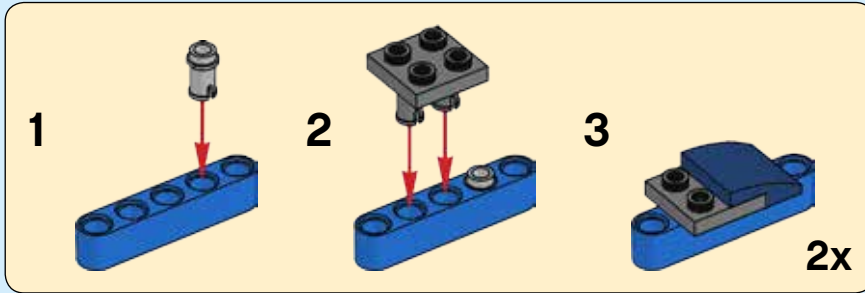



2x

16

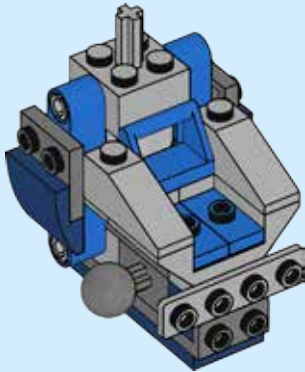

2x

17

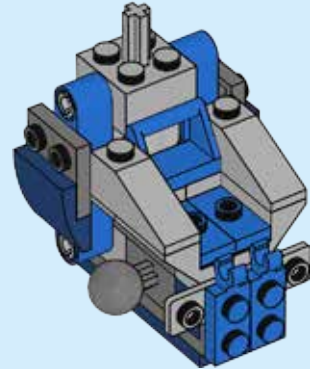



2x



1x

18

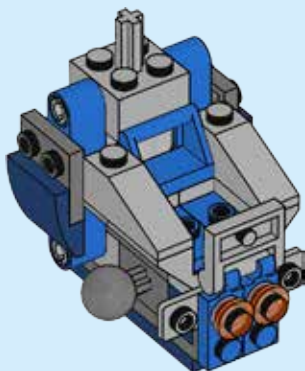

2x

19

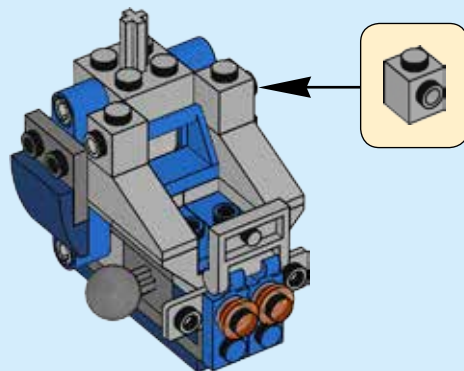

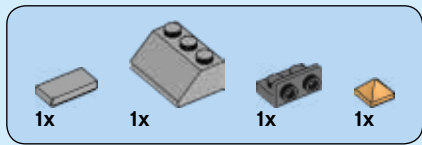

20

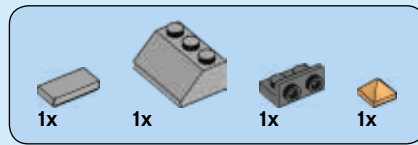
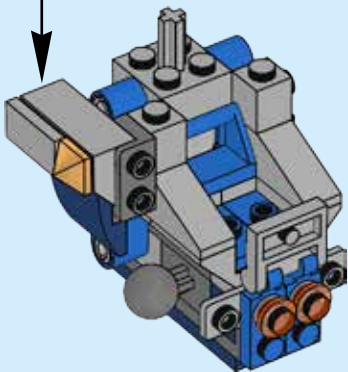
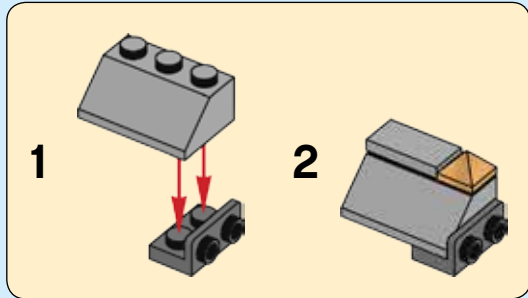

21

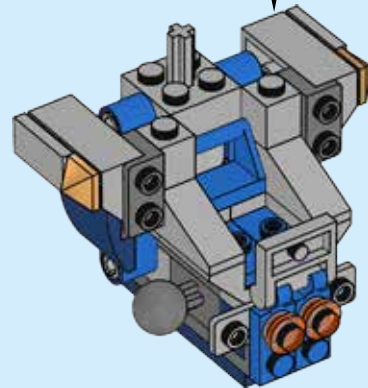
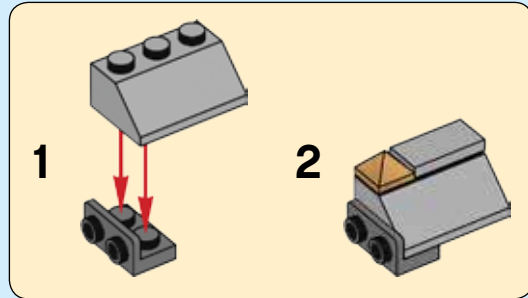

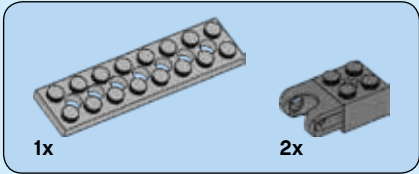
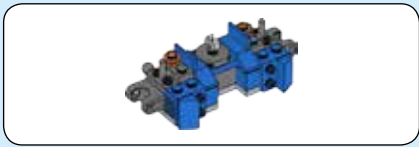

22

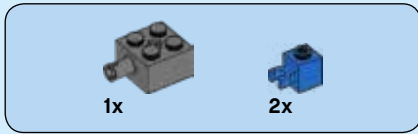
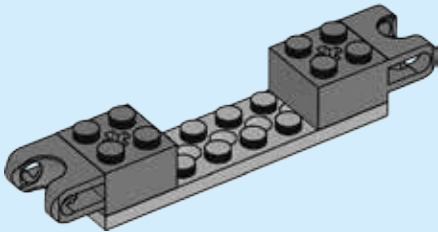

23

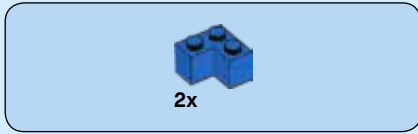
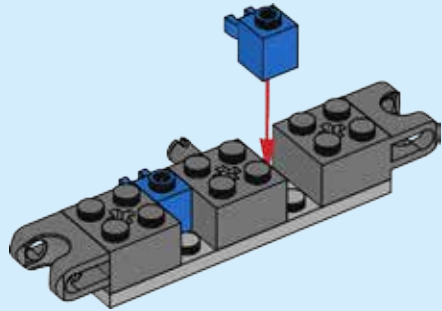

24

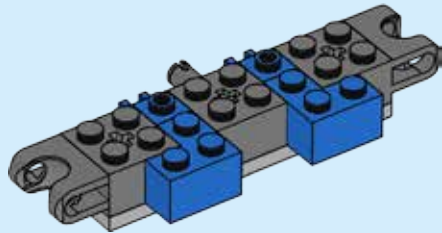

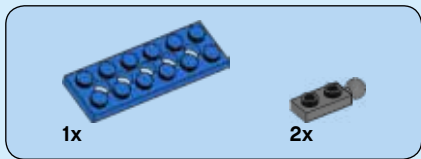

25

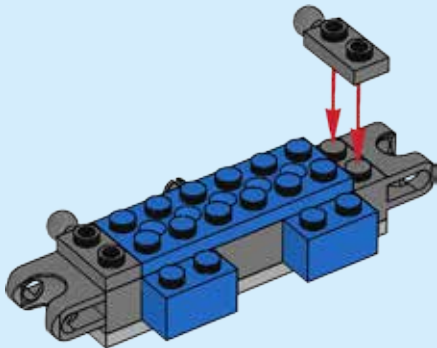

26

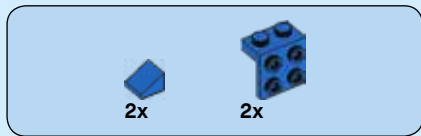
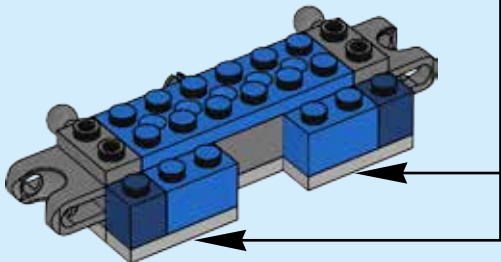
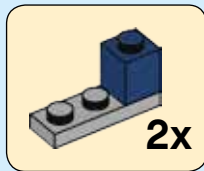

27

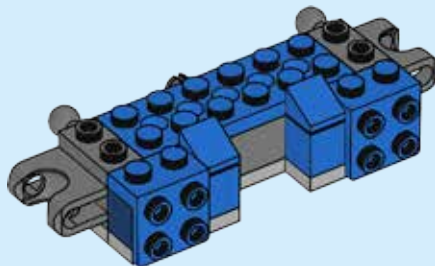



2x

28

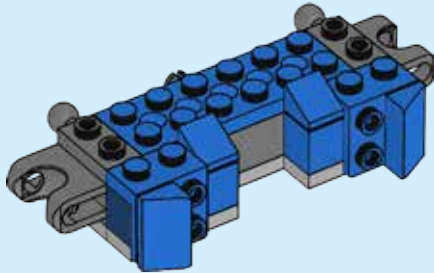

2x



2x



1x

29

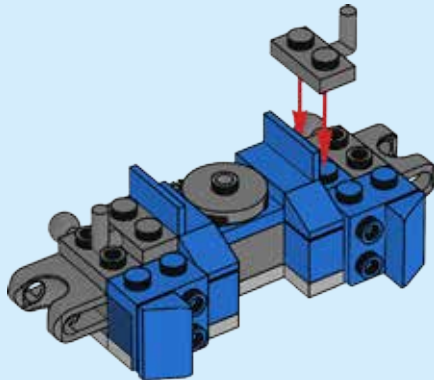

2x



1x

30

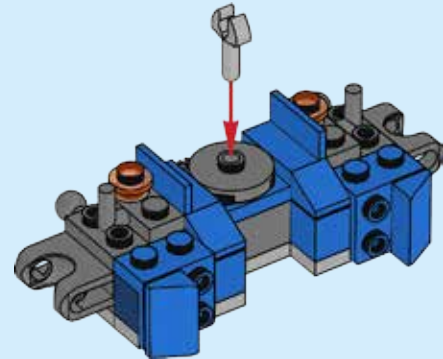

31

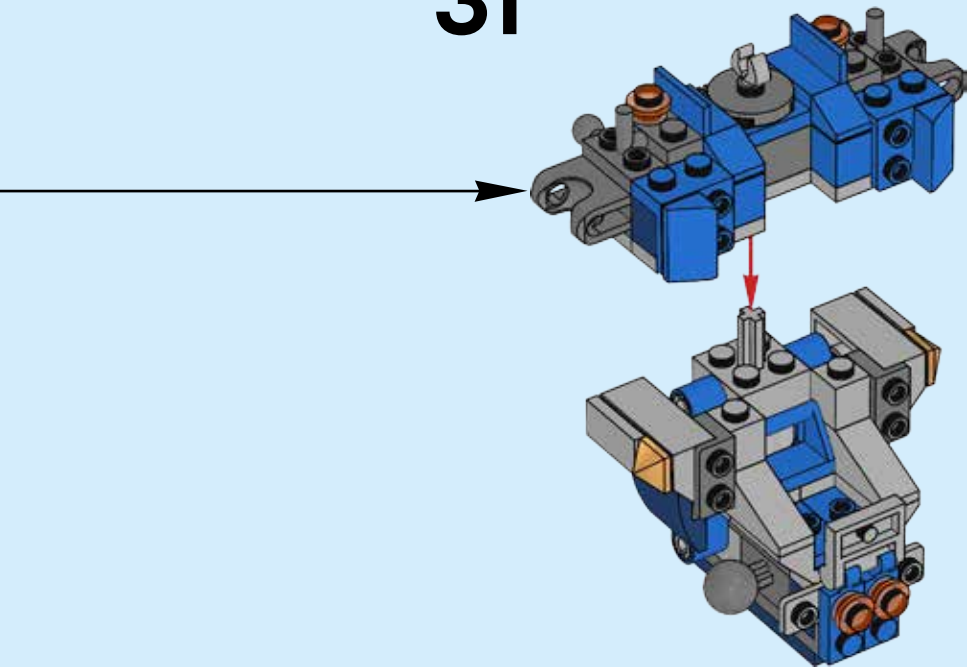

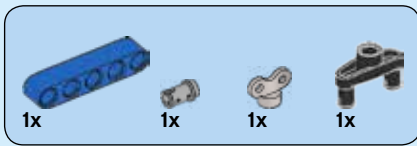

32

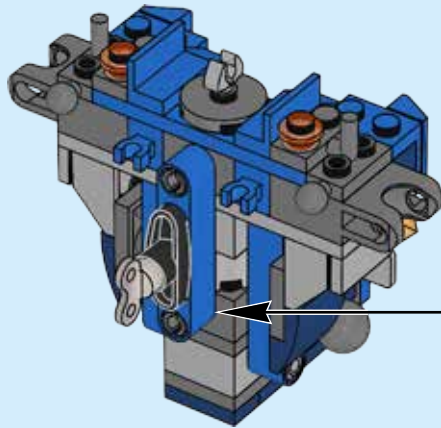
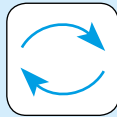
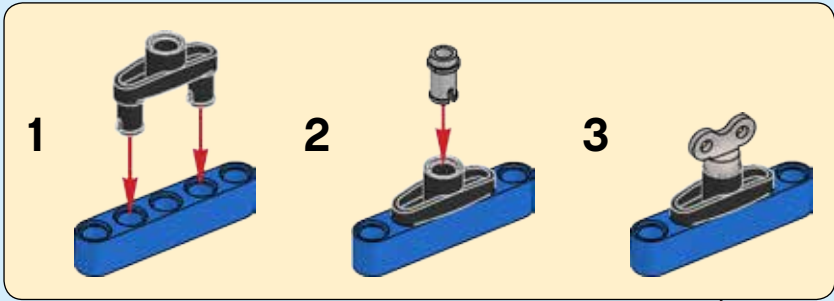

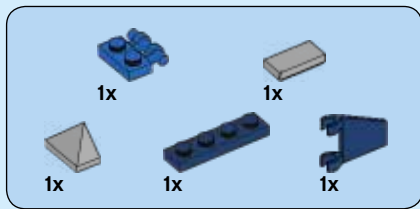

33

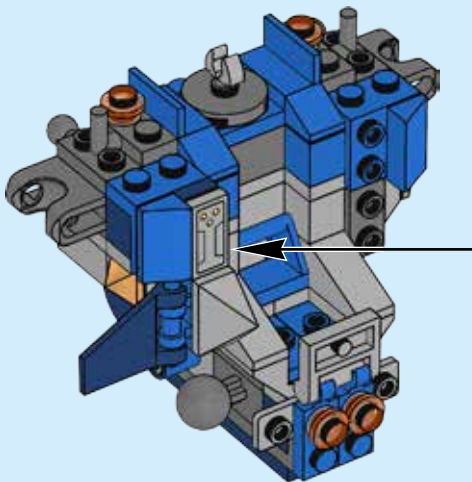
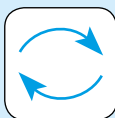

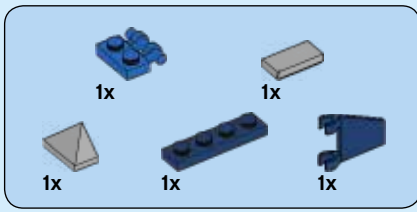

34

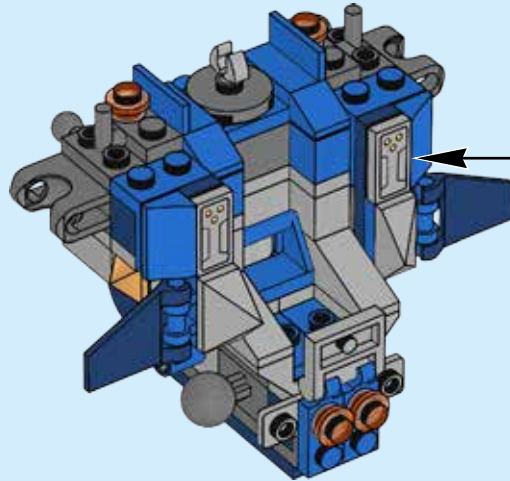



2x

35

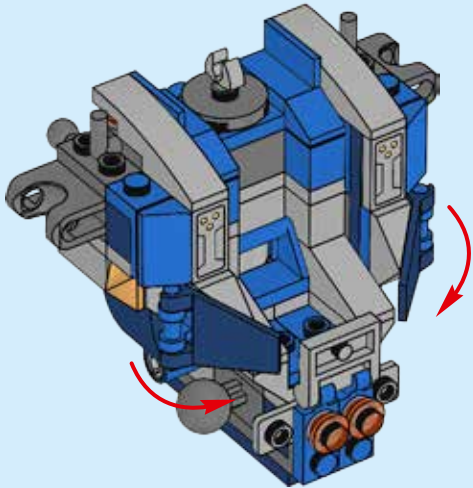

1x



1x



1x



1x

36

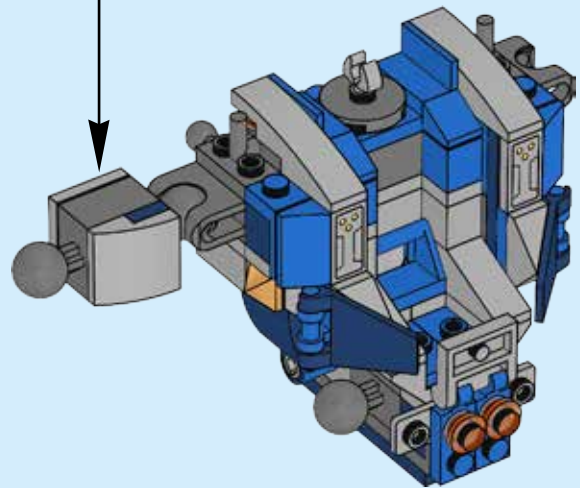
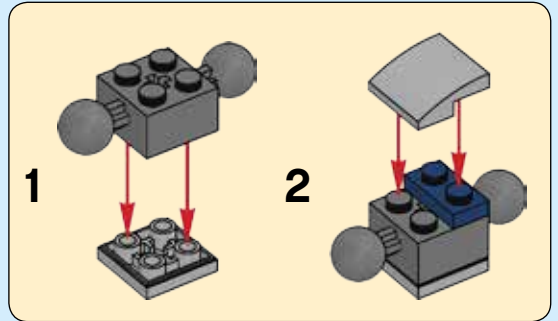



37

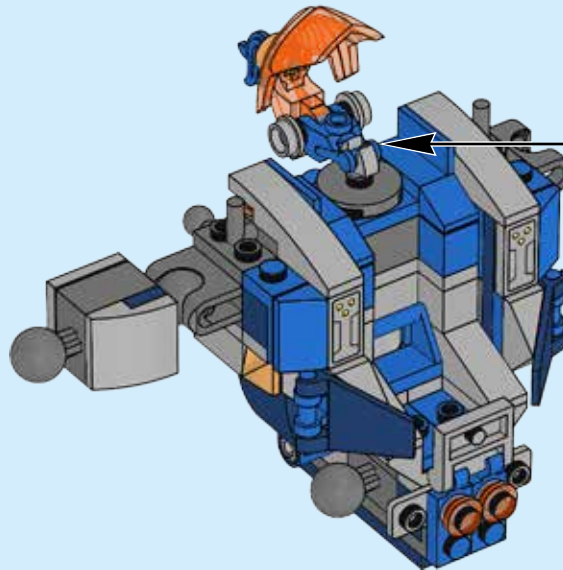
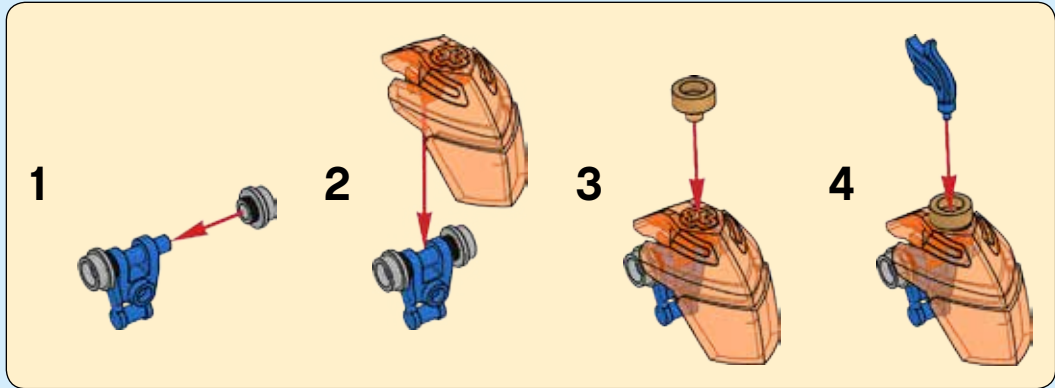

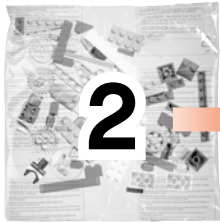

1x



38

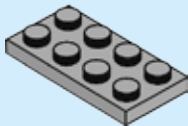

2x

39

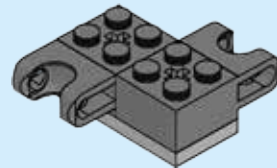



1x

40

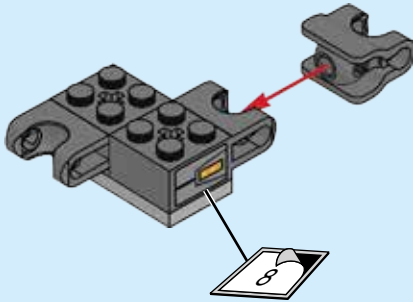

1x



1x



1x

41



1x



1x

42

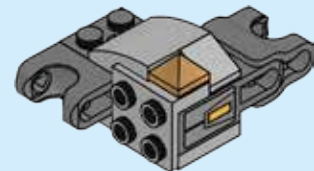



1x



1x

43

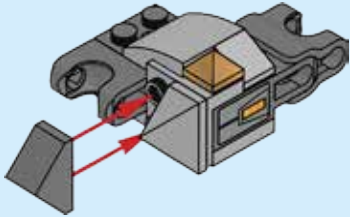

44

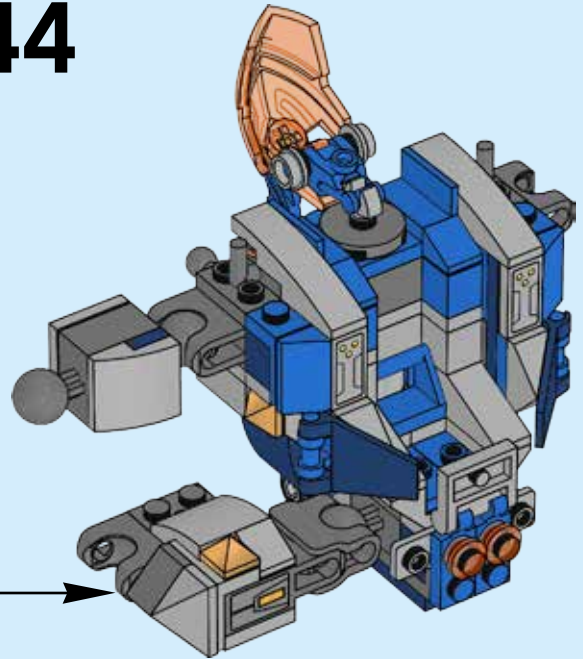



1x

45



1x

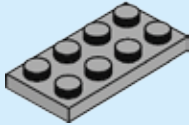

2x

46

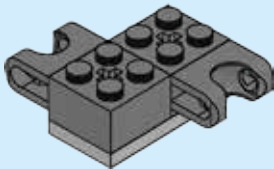

1x

47

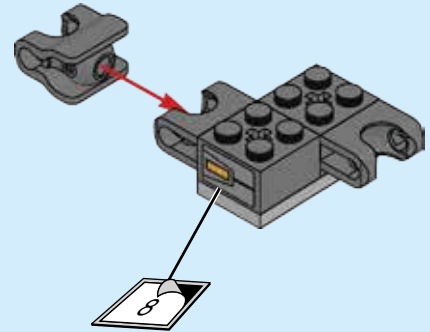

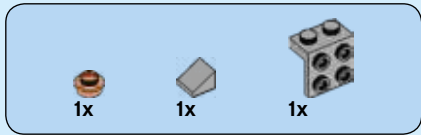

48

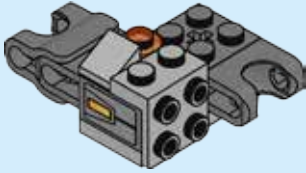

49

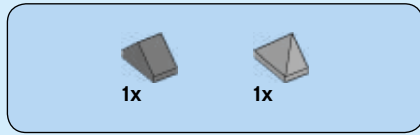
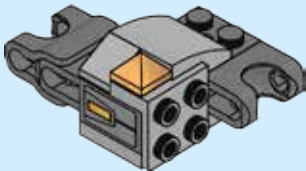

50

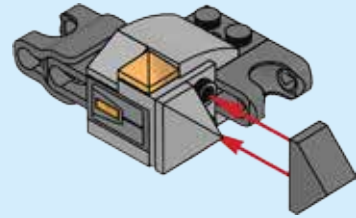

51

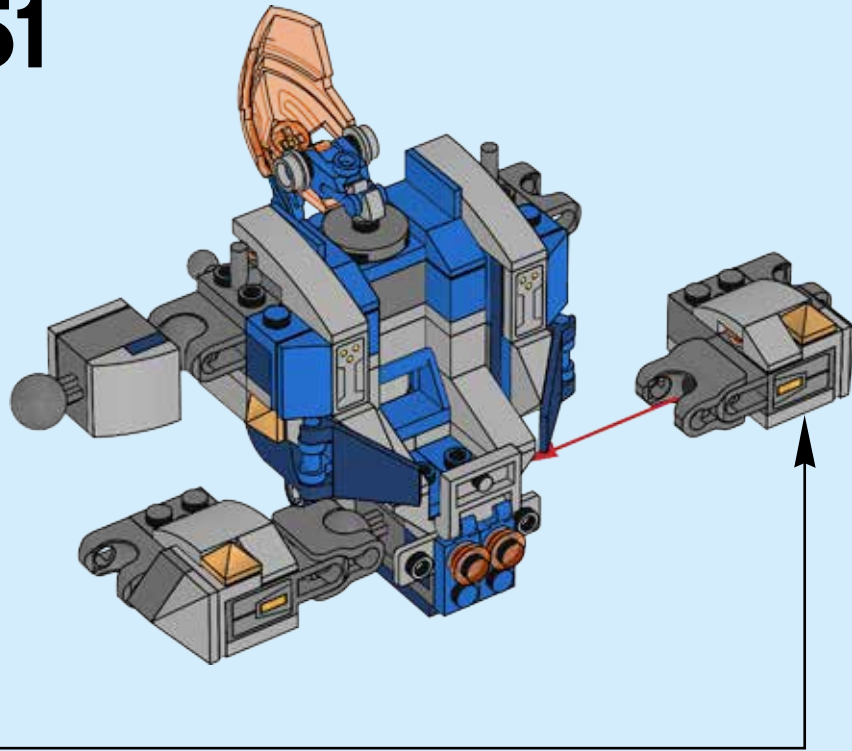



2x

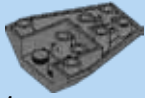

1x

52

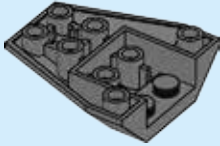

1x

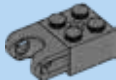

1x

53

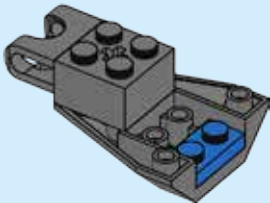

1x



1x

54

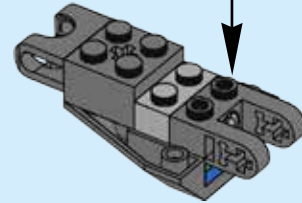
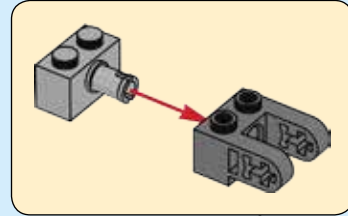



55

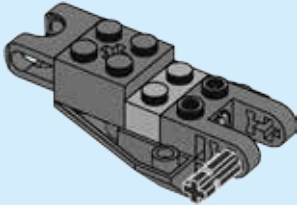

56

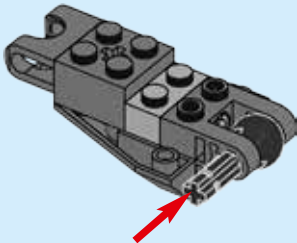

57

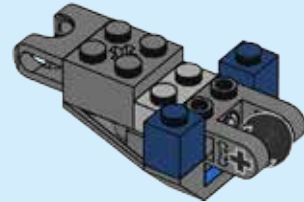

58

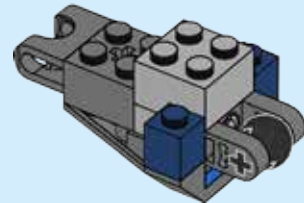

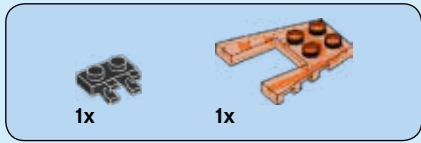

59

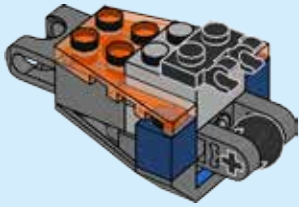

60

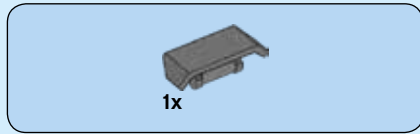
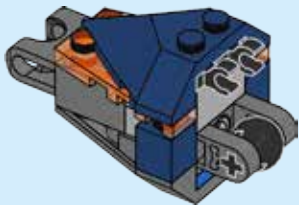

61

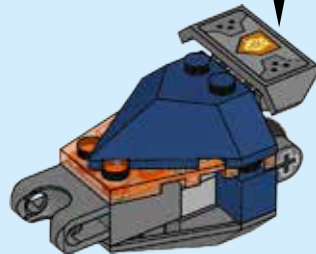
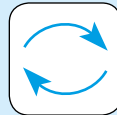
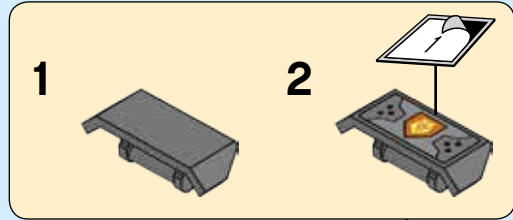

2x

62

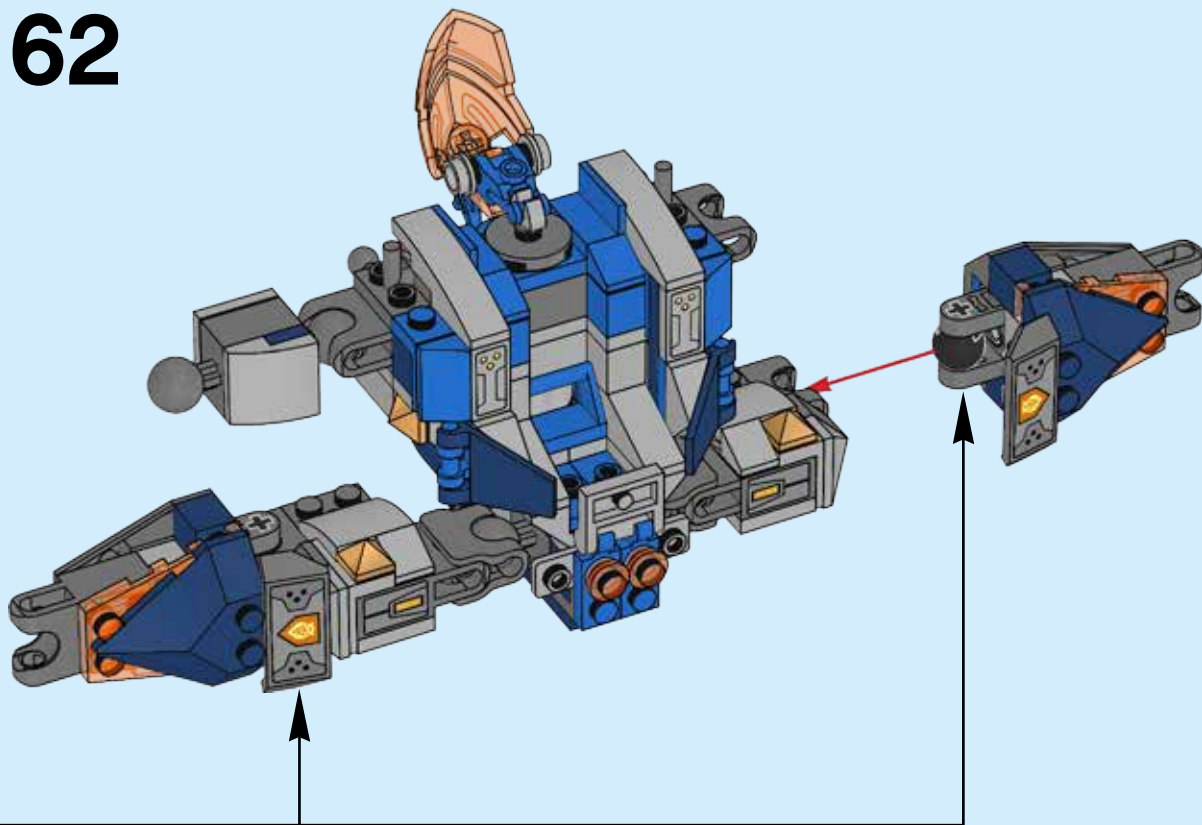



2x



1x

63

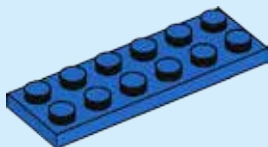

1x

64

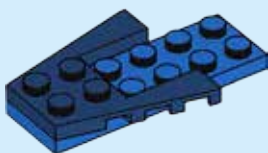

1x

65

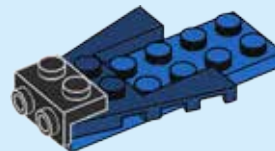

1x

66

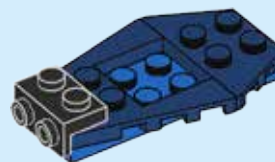

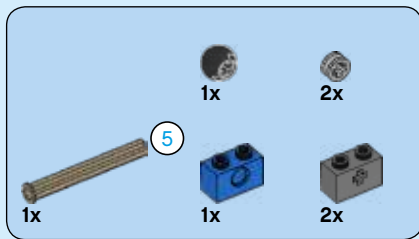

67

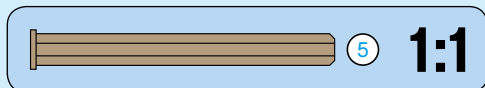
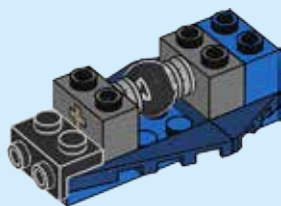
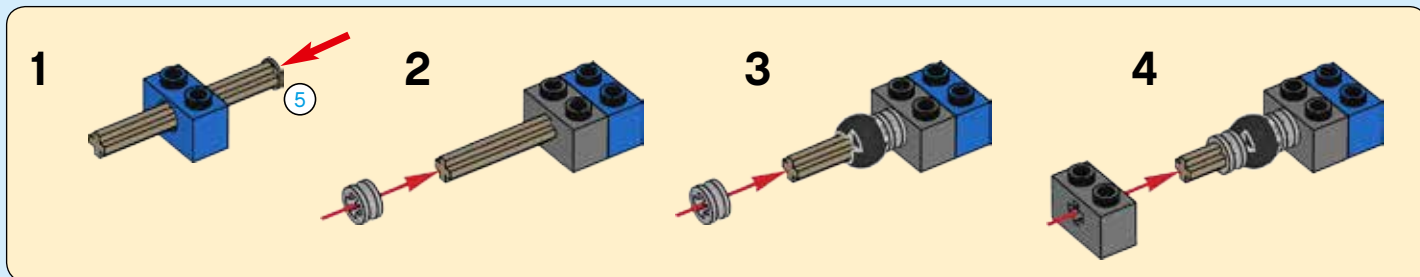

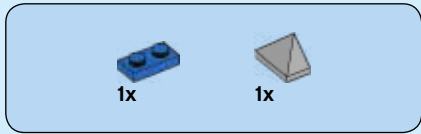

68

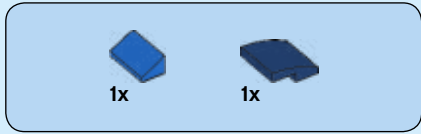
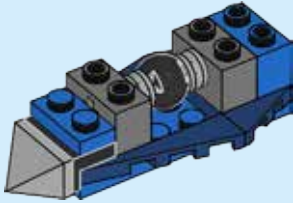

69

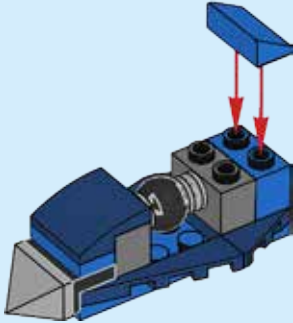

2x

70

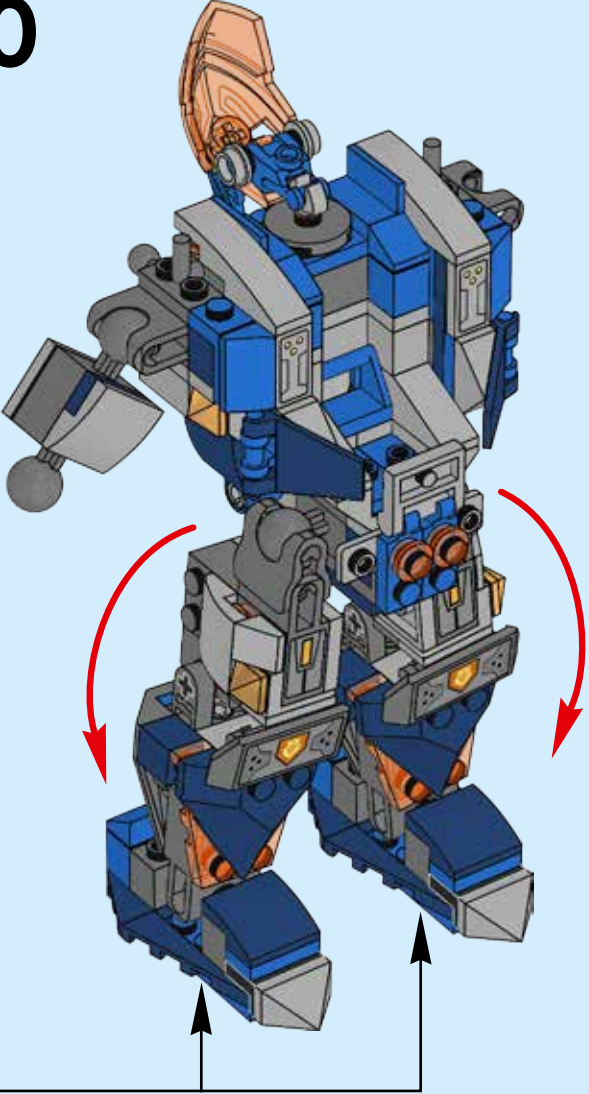



1x

71

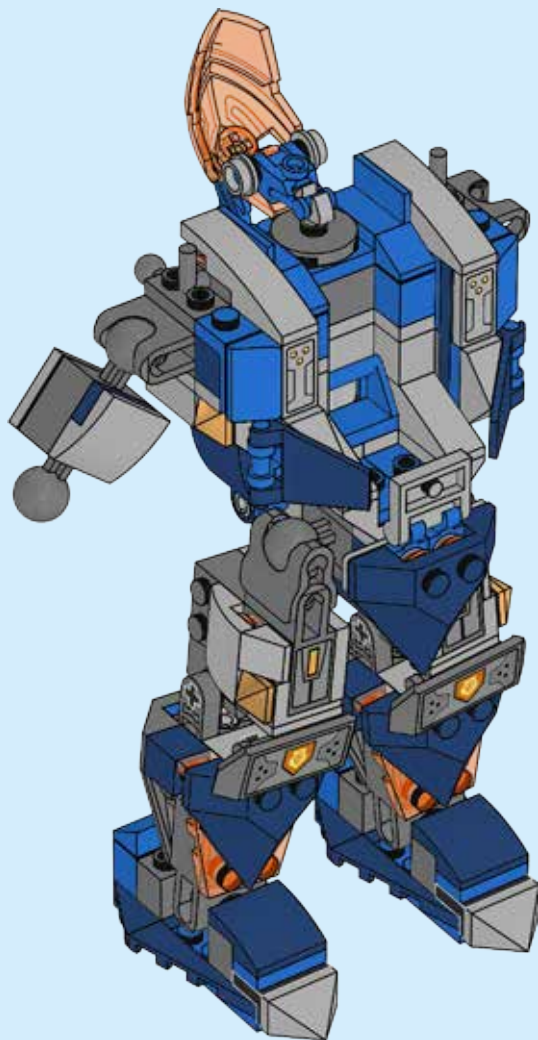



1x

72

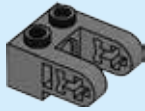

1x

73

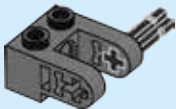

1x

74

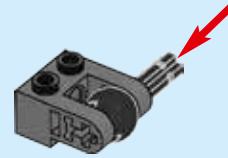

1x

75



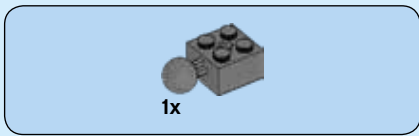

76

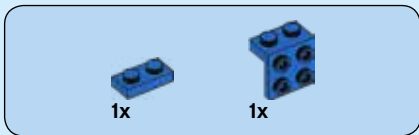
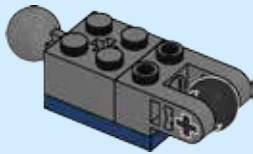

77

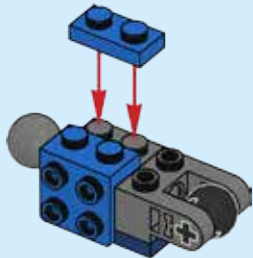

78

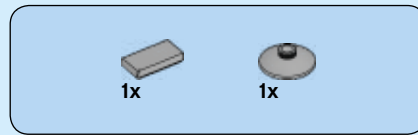
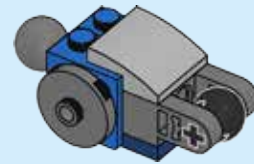

79

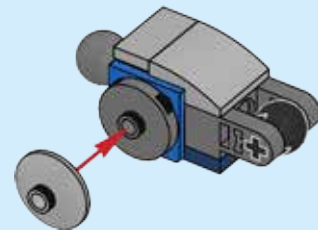

80

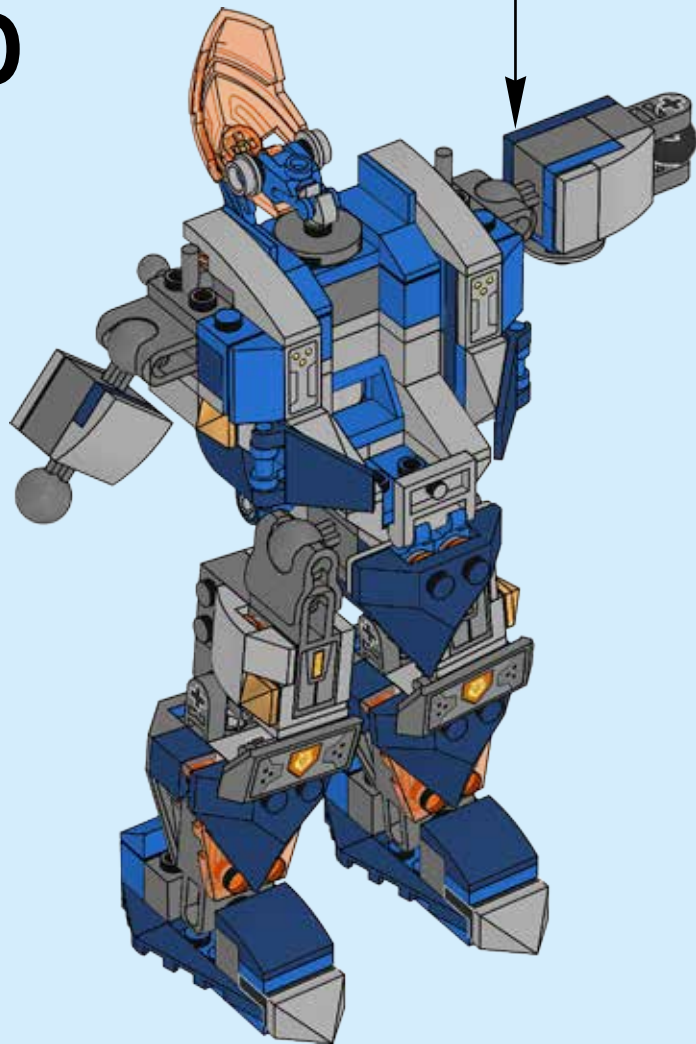



1x

81

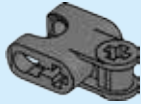

1x

82

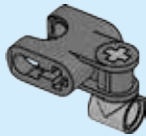

2x

83

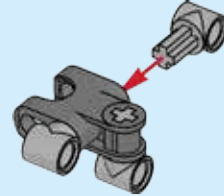

2x



2x



2x

84

1

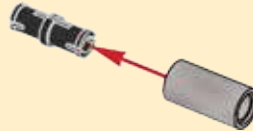

2



2x

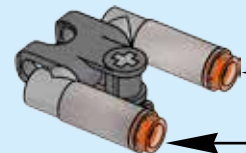

85

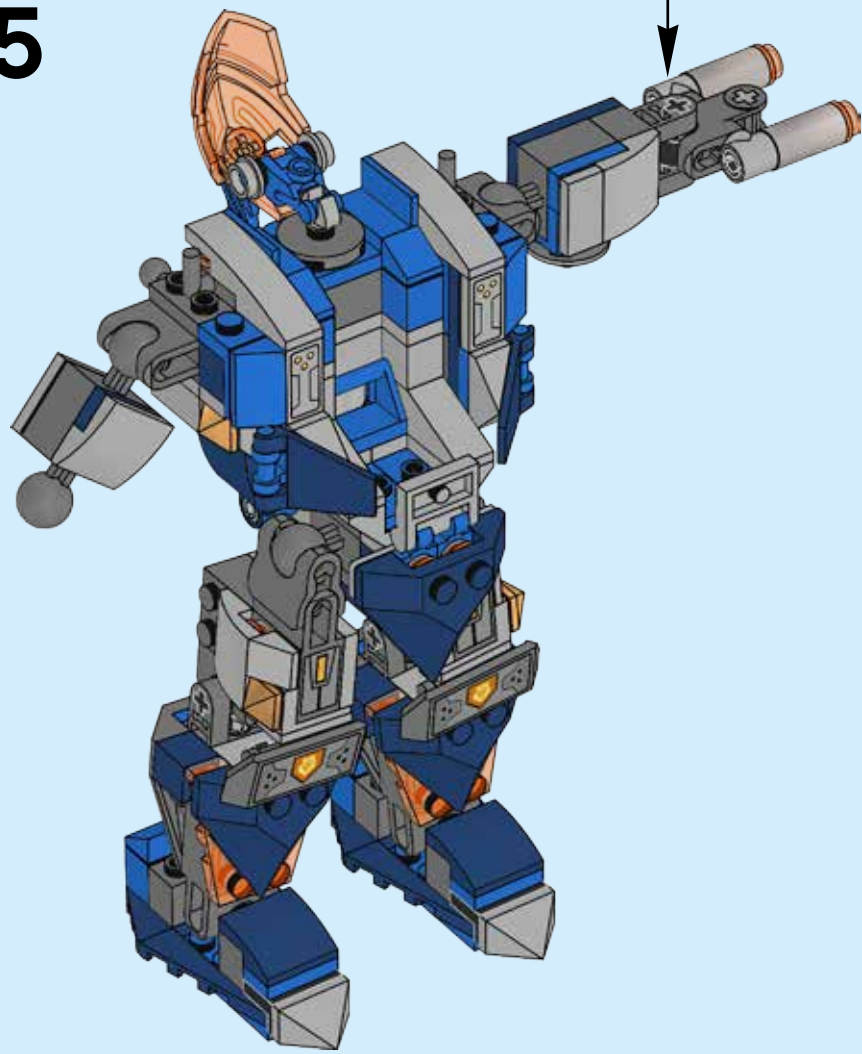



1x

86

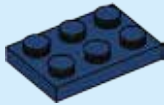

1x

87

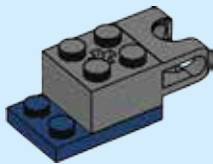

1x



1x

88

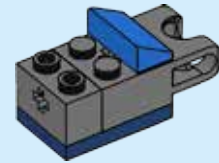

1x



1x

89

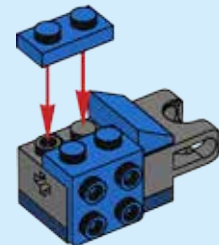



1x

90



1x

91

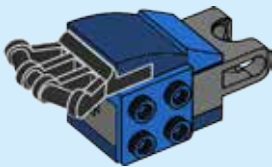

1x



1x

92

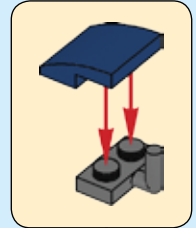
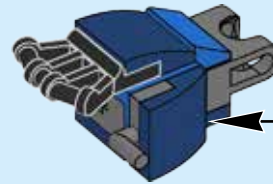

4x

93

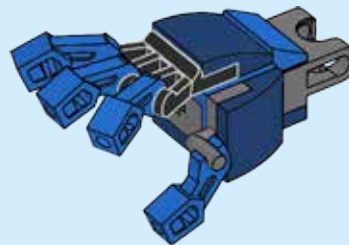

94

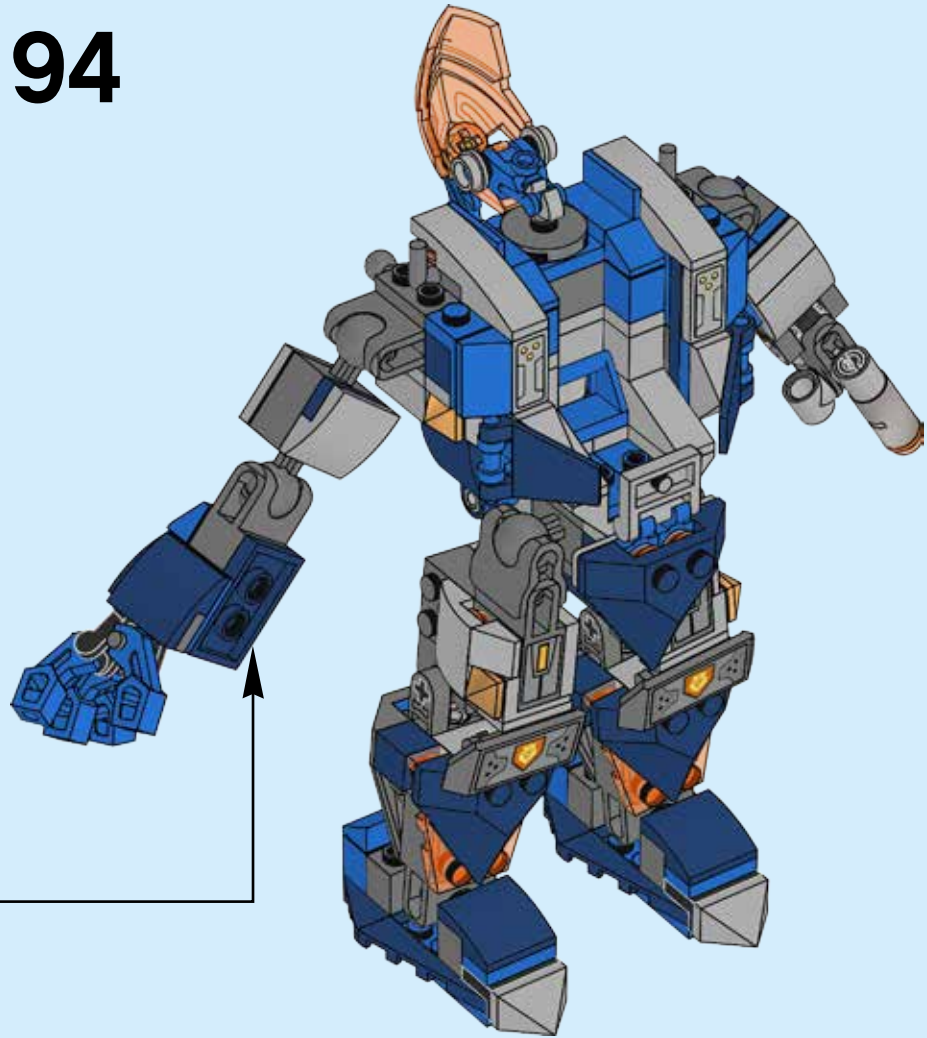

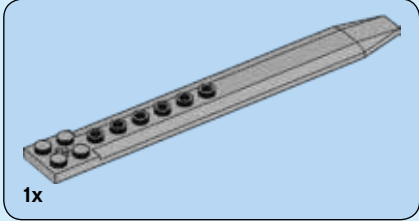

95

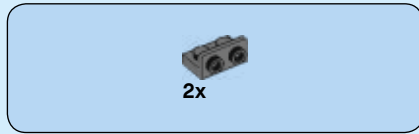
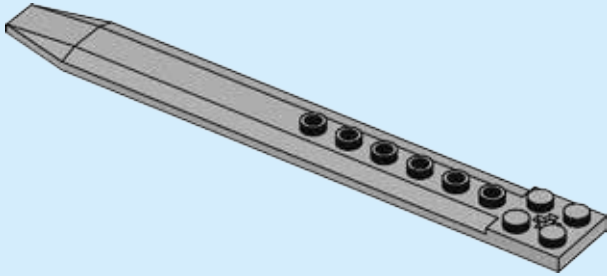

96

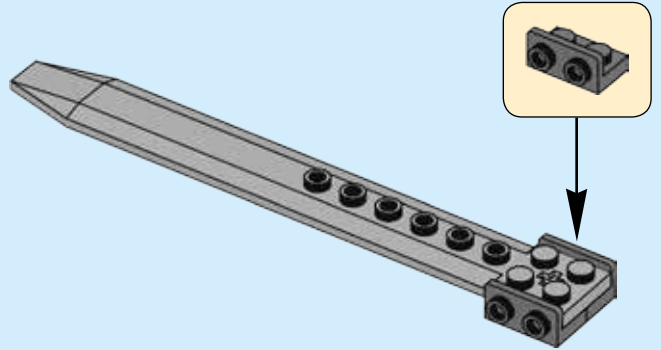

97

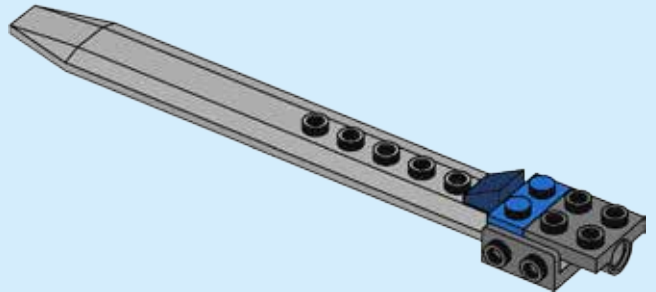

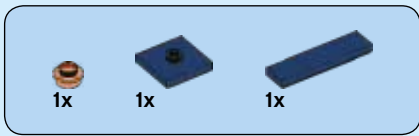

98

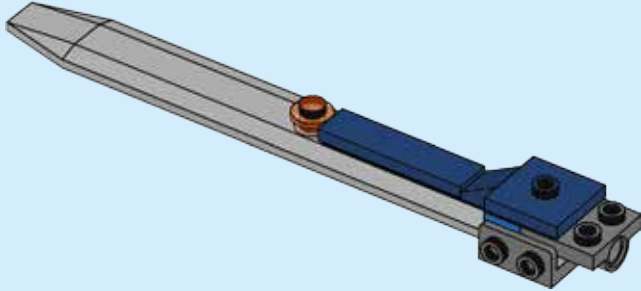

99

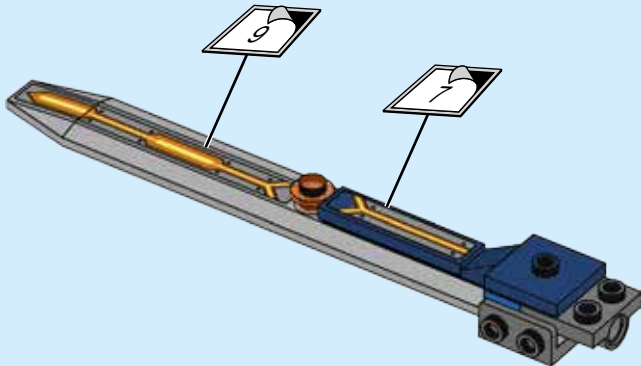

100

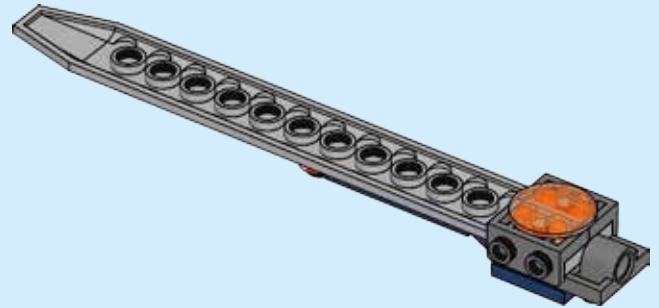
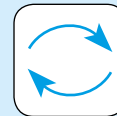



101

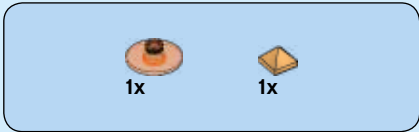
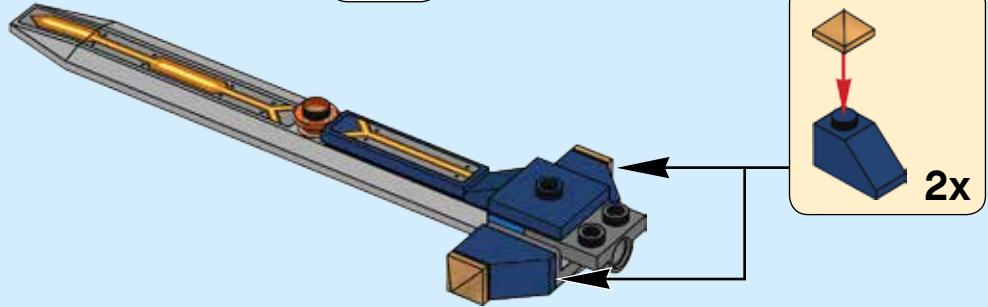
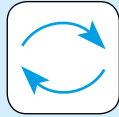

102

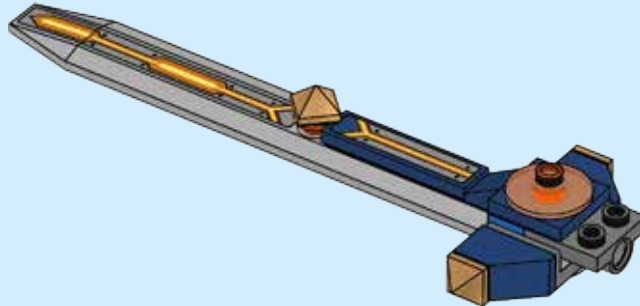

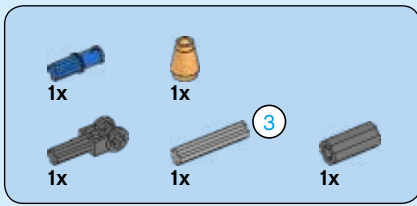

103

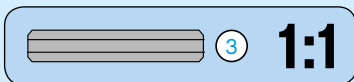
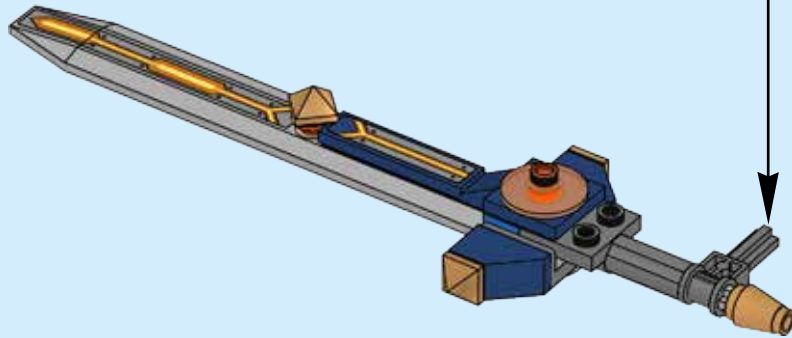
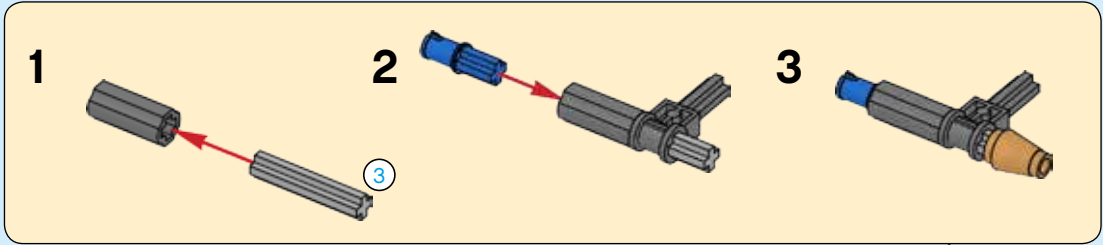

104





2x



1x



1x

105

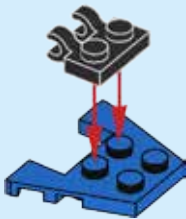

1x

106



1x

107

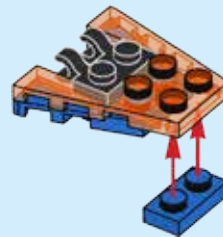



1x

108



1x

109

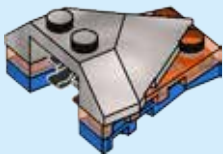
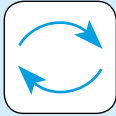

1x

110

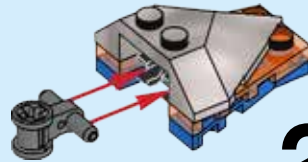

2x

111

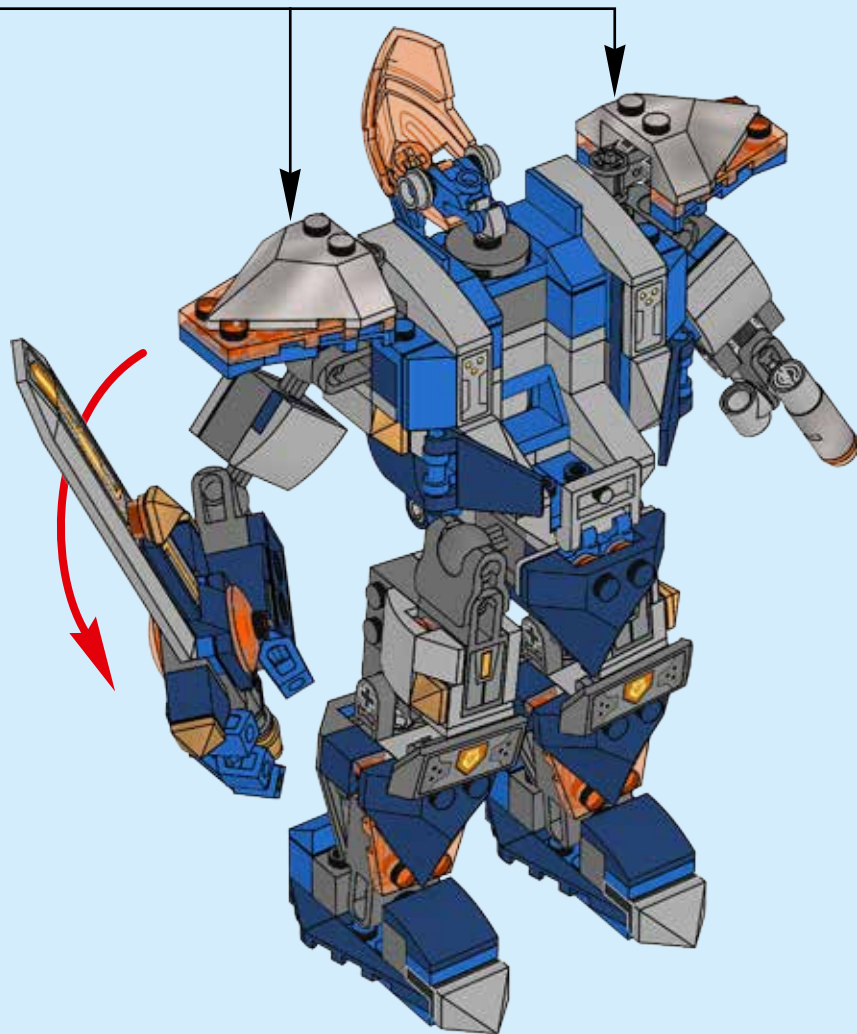

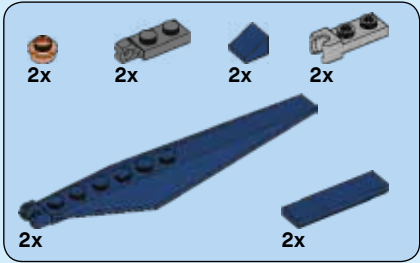

112

1

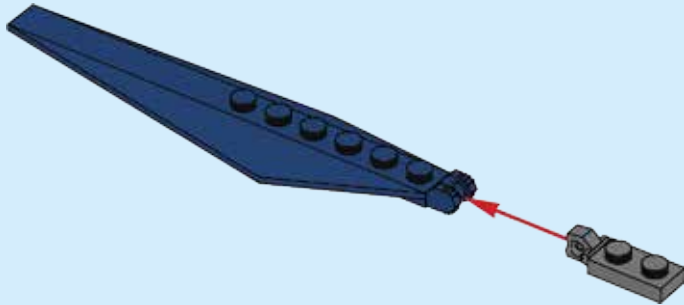

2

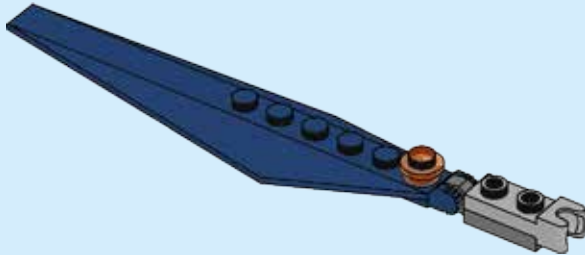

3

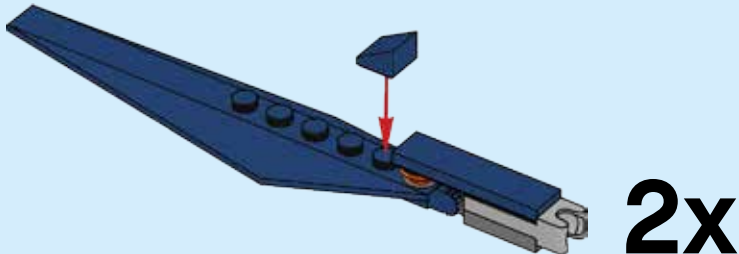

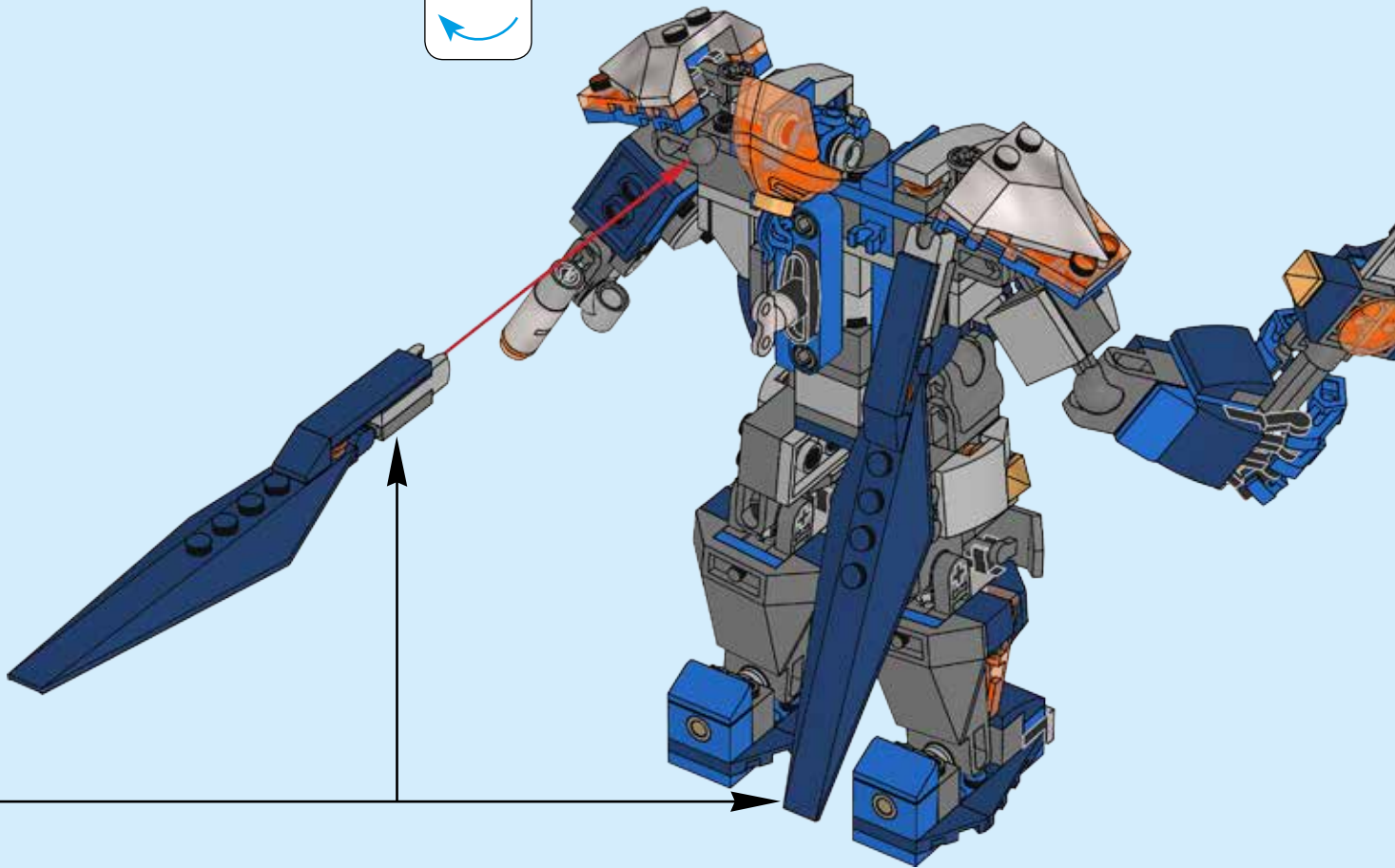
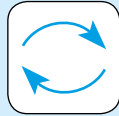

113

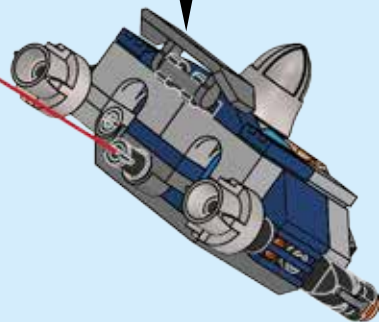
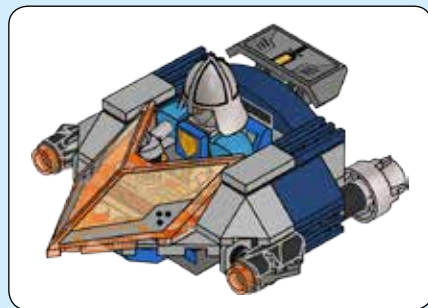
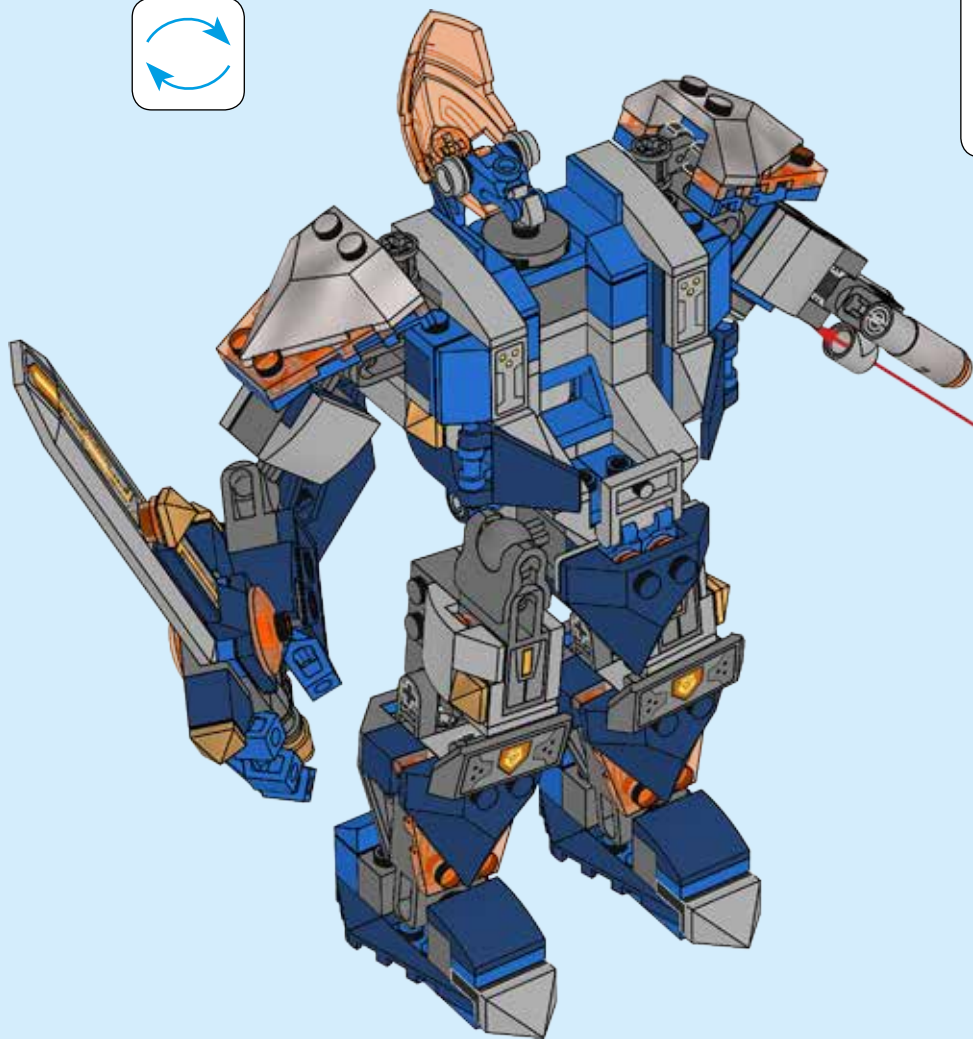
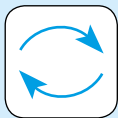

114

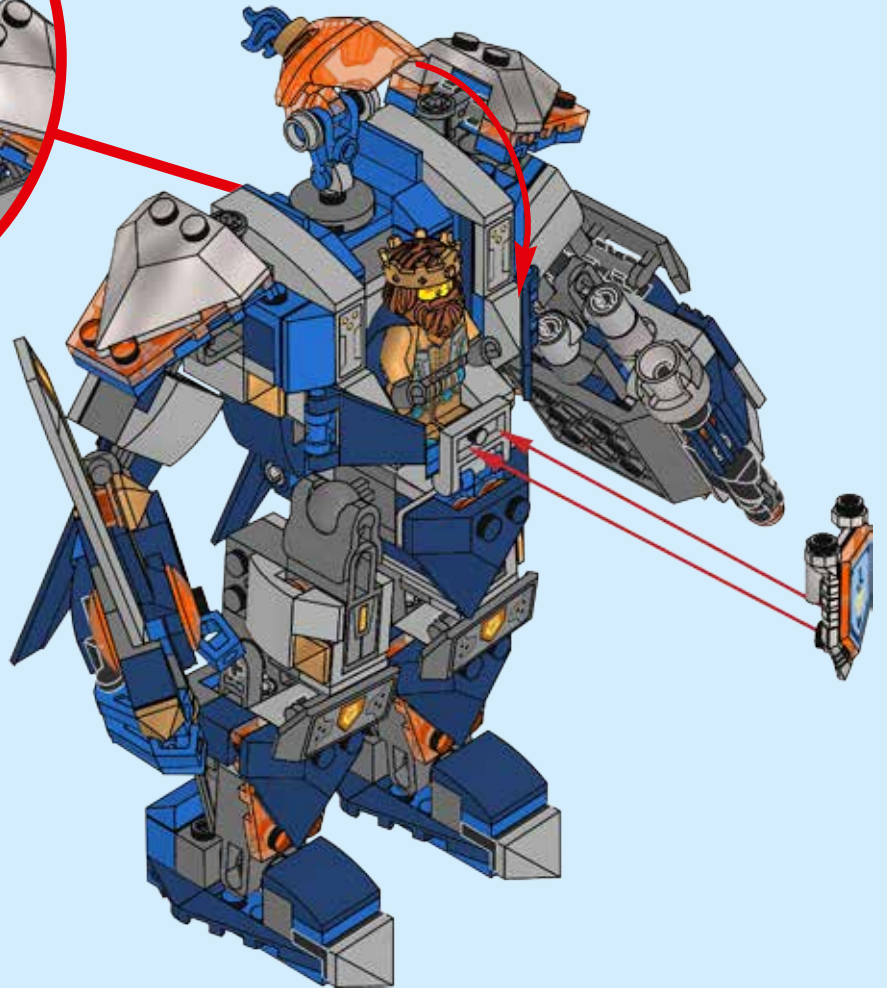
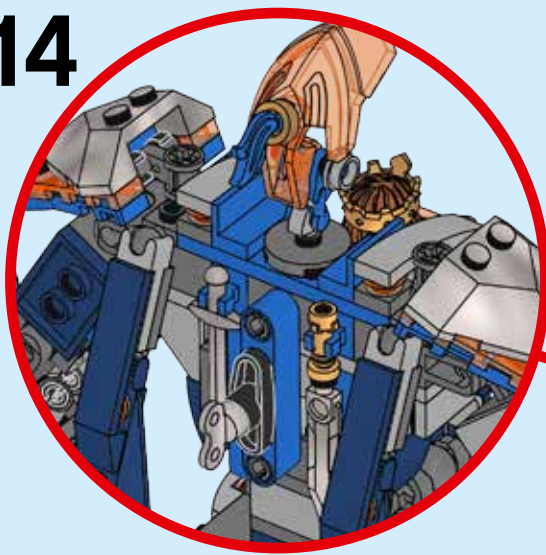

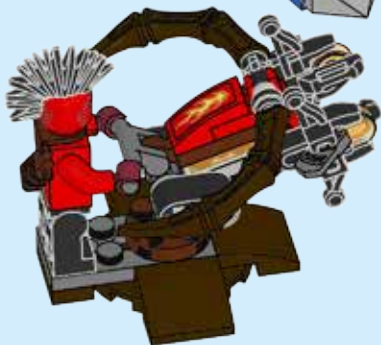
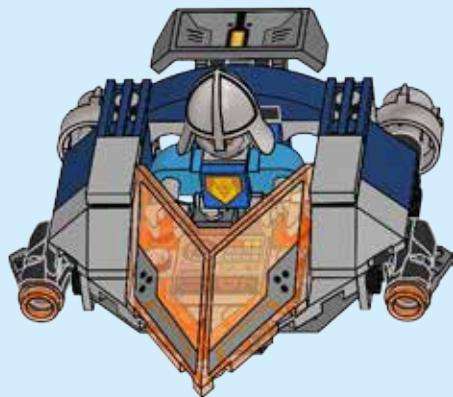
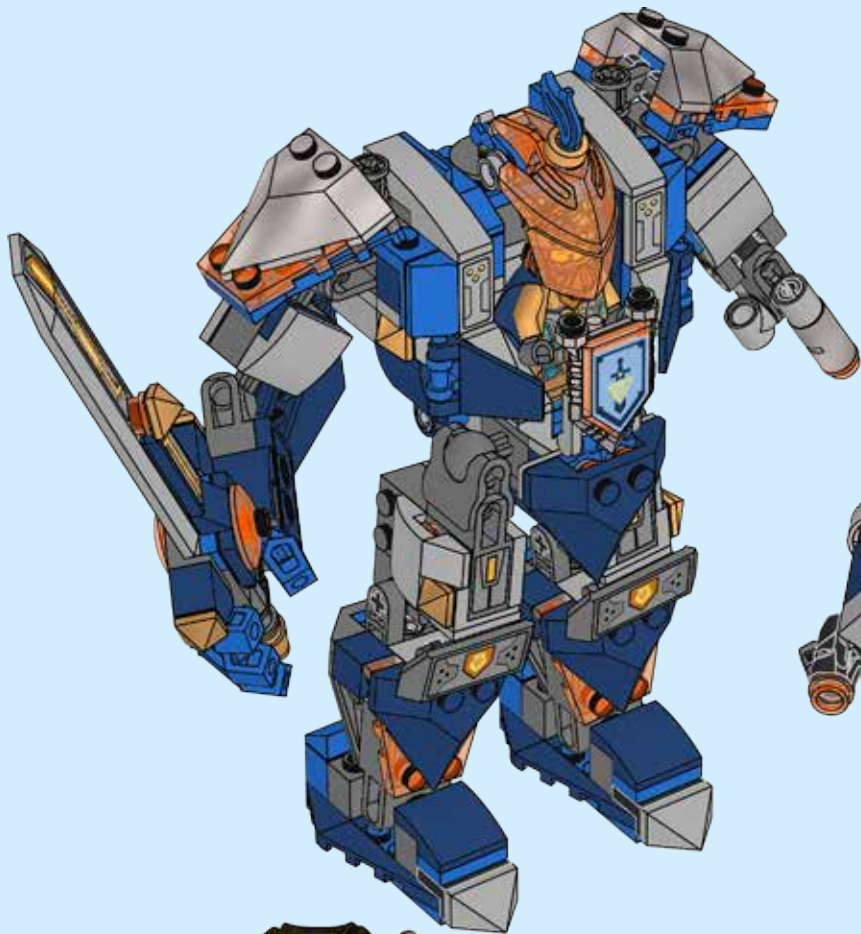



NEXO KNIGHTS



NEXO POWER UPLOAD

DOWNLOAD THE FREE APP



LEGO® NEXO KNIGHTS™: MERLOK 2.0



1



2



3

DOWNLOAD THE FREE APP/KOSTENLOSE APP HERUNTERLADEN/TÉLÉCHARGE L'APPLI GRATUITE
DESCARGA LA APP GRATIS/DESCARREGA A APP GRÁTIS/TÖLTSD LE AZ INGYENES APPOT/下載免費APP
DEVICE CHECK;/GERÄT PRÜFEN;/VERIFICATION DE COMPATIBILITE ;
COMPRUEBA TU DISPOSITIVO;/VERIFICAÇÃO DO DISPOSITIVO;/ESZKÖZELLENÖRZÉS;/設備檢查;

LEGO.com/devicecheck



NEXO KNIGHTS

SCANNING TIPS

Scanning Tips / Tipps zum Scannen / Conseils de scannage /
Consejos para escanear / Dicas para o scan /
Beolvasási tippek / 扫描秘诀



LEGO.COM/NEXOKNIGHTS/HELP





NEXO KNIGHTS



LEGO
LEGOLAND
DISCOVERY CENTER



LEGOLAND



DOWNLOAD THE FREE APP: /KOSTENLOSE APP
HERUNTERLADEN; /TÉLÉCHARGE L'APPLI GRATUITE :/
DESCARGA LA APP GRATIS; /DESCARREGA A APP GRÁTIS;/
TÖLTSD LE AZ INGYENES ÁPPOTI; /下载免费APP:
LEGO® NEXO KNIGHTS™: MERLOK 2.0

ALL MATERIALS MIGHT NOT BE AVAILABLE IN ALL MARKETS.
MÖGLICHERWEISE IST NICHT DAS GANZE MATERIAL IN ALLEN MÄRKTEN VERFÜGBAR. /CERTAINS PRODUITS PEUVENT NE PAS ÊTRE DISPONIBLES SUR CERTAINS MARCHÉS. /CIERTOS MATERIALES PODRÍAN NO ESTAR DISPONIBLES EN TODOS LOS MERCADOS. /OS MATERIAIS PODERÃO NÃO ESTAR TODOS DISPONÍVEIS EM TODOS OS MERCADOS. /ELKÉPZELHETŐ, HOGY BIZONYOS KIEGÉSZÍTŐK A TE ORSZÁGODBAN NEM ELÉRHETŐEK. /部分内容可能不适用于某些国家/地区

LEGO.COM/NEXOKNIGHTS



NEXO KNIGHTS







NEXO KNIGHTS



70330



70331



70332



70333



70334



70335



club™





NEXO KNIGHTS



ULTIMATE BEAST MASTER
70334

ULTIMATE LAVARIA
70335



SPARKKS
70316



JESTRO
70316



BOOK OF MONSTERS
70316



MOLTOR
70313



BEAST MASTER
70314



CRUST SMASHER
70311



ASH ATTACKER
* 70310 / 70315 / 70317



FLAME THROWER
70312



SCURRIER
* 70315 / 70317

* Weapons and decorations vary by set/Zubehör und Dekoration variieren je nach Set/Les armes et les décorations varient selon les boîtes/



ULTIMATE CLAY
70330

ULTIMATE MACY
70331

ULTIMATE AARON
70332

ULTIMATE ROBIN
70333

NEXT POWER UP



AARON
* 70313 / 70317

AXL
70317

LANCE
* 70312 / 70316

CLAY
* 70315 / 70317

MACY
70314



CHEF ÉCLAIR
70317



LANCE BOT
70312



CLAY BOT
70315



ROYAL SOLDIER
* 70310 / 70311



MERLOK 2.0
70317



1x
4598897

5x
4286267

2x
6073231

1x
6101834

3x
4109810

5x
4121715

2x
6006140

1x
6125717

3x
6016172

5x
4556158

1x
6055630

2x
6102734

2x
6117858

1x
4604304

1x
370526 4

2x
6124825

4x
4211573

3x
4542590

3x
4211483

2x
4521921

2x
4558953

1x
6129994

6x
6075075

1x
4211512

1x
4211526

3x
6123815

3x
6089147

7x
4211414

2x
4211437

2x
6117967

2x
4211364

1x
4244627

1x
6132886

1x
4615837

4x
6102357

2x
4211387

2x
6034676

3x
4211815 3

2x
6043639

2x
4645397

1x
4211352

1x
4211449

1x
6028100

2x
4211429

2x
4211488

2x
4211773

3x
6014615

2x
4211752

2x
6042950

2x
4211395

1x
4211517

3x
4504374

8x
4255413

4x
6022579

6x
4528981

2x
6103405

2x
4529551

2x
4530028

3x
6103985

2x
4502089

1x
6037886

3x
6129858

1x
4667595

2x
4613335

6x
6061569

1x
4565320

2x
4153653

2x
6102890

1x
6136351

2x
6082417

1x
6133414

1x
6144629

1x
6145153

1x
6145157

2x
6141816

1x
6131705

4x
4646865

1x
4280341

1x
4211159

1x
4211160

1x
6008297

2x
6055631 5



1x
6129791



1x
6129763



1x
6030266



1x
4597713



1x
6029946



19x
3005747



1x
6124909



1x
3006347



1x
6142939



4x
6124831



1x
6129592



4x
6051334



2x
6020189



2x
4226221



2x
6115080



1x
4516546



5x
4210935



3x
4611703



5x
6000606



1x
4261908



2x
6106472



2x
6123814



2x
4210883



2x
6066952



2x
6047417



2x
4210665



1x
4626667



3x
4547958



2x
4211046



1x
4497253



3x
6124820



9x
4619760



3x
4227398



2x
6065816



2x
6079036



2x
6079036



1x
4549999



2x
4504380



2x
486523



4x
6117968



1x
6132701



1x
6034719



4x
6014032



1x
4508613



2x
6072680



5x
4651236



1x
4206482



3x
243223



2x
6092582



2x
370023



11x
302323



2x
4140586



2x
4568990



2x
242023



2x
4558606



1x
4514553



2x
4594242



3x
4142134



2x
379523



1x
4114027



1x
6125244



1x
6078442



1x
6038196



2x
6123838



1x
6037507



2x
6054858



1x
6129534



2x
6129453



2x
6125856



1x
6134587



1x
6003147



1x
4529247



1x
6126113



7x
6129416



1x
6131728



1x
6131713



2x
6058221



3x
6047037



2x
6051523



1x
6005030

Customer Service

Kundenservice

Service Consommateurs

Servicio Al Consumidor

LEGO.com/service or dial



: 00800 5346 5555

: 1-800-422-5346