



SCOOBY-DOO!

75903



[LEGO.com/scoobydoo](https://www.LEGO.com/scoobydoo)



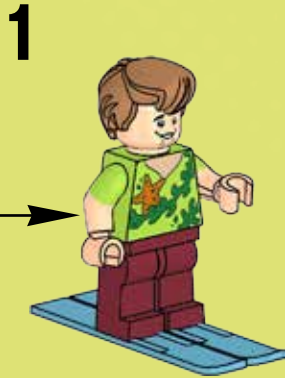
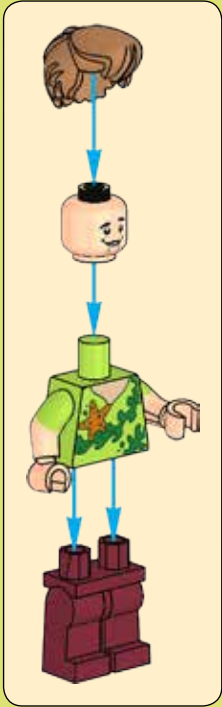
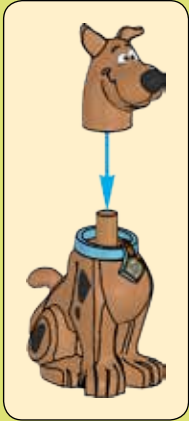

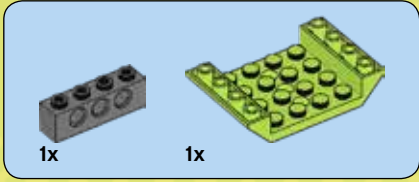
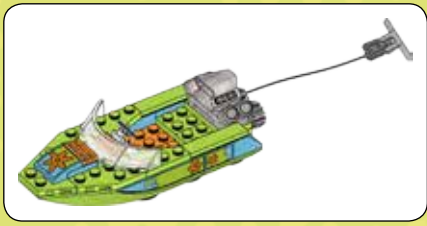

1

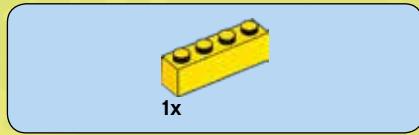
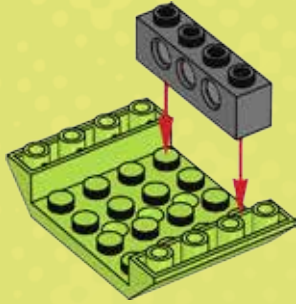

2

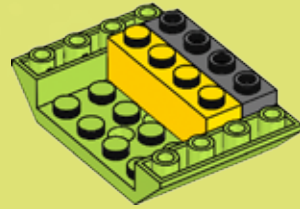



2x

3

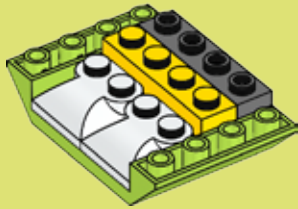

2x

4



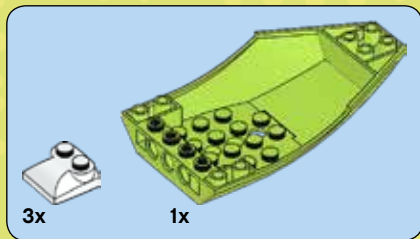

5

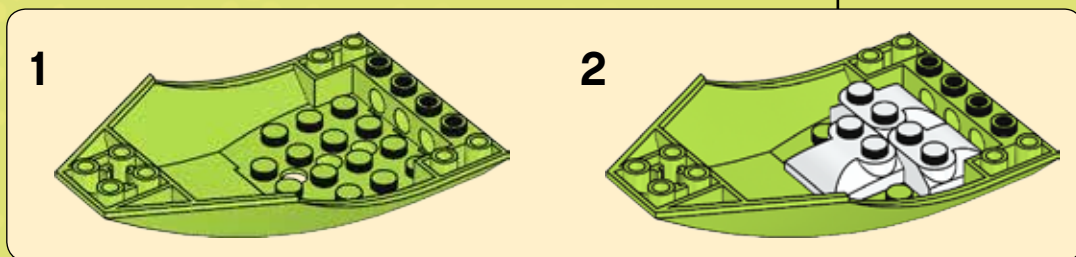
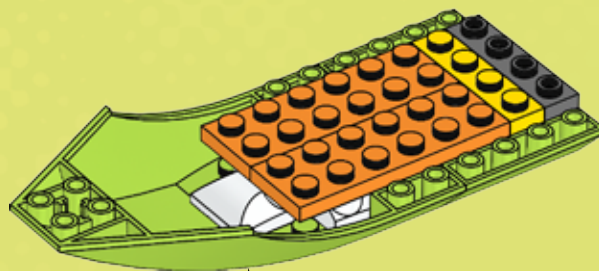



1x



2x

6

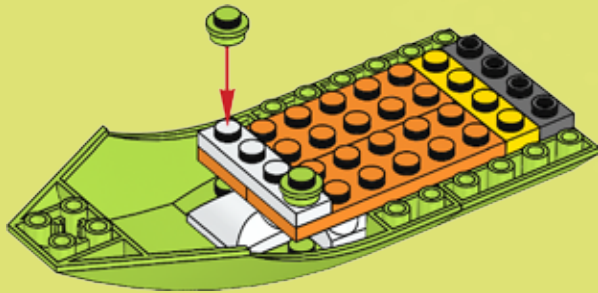

2x



2x

7

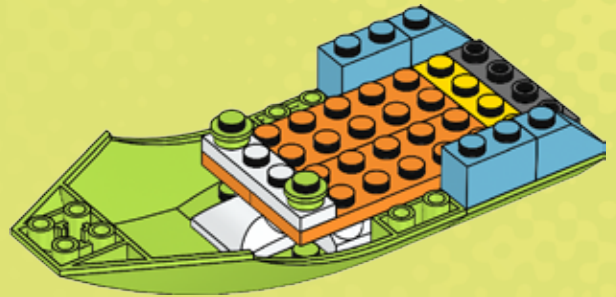

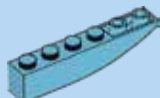

2x

8

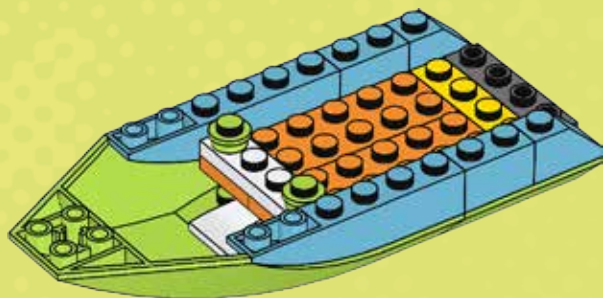

9

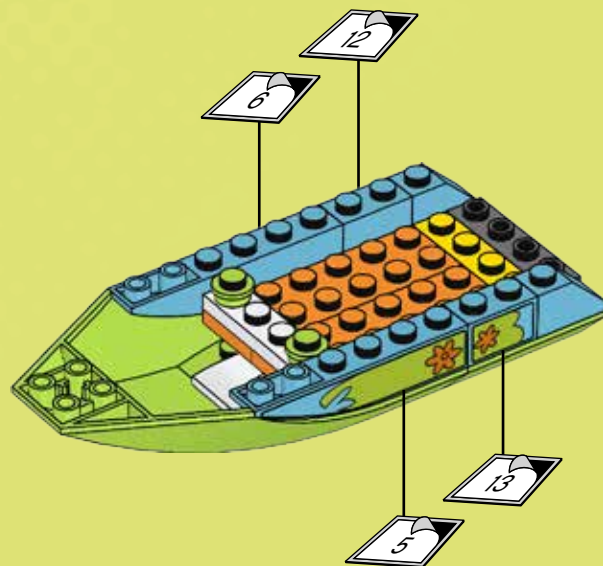



3x

10

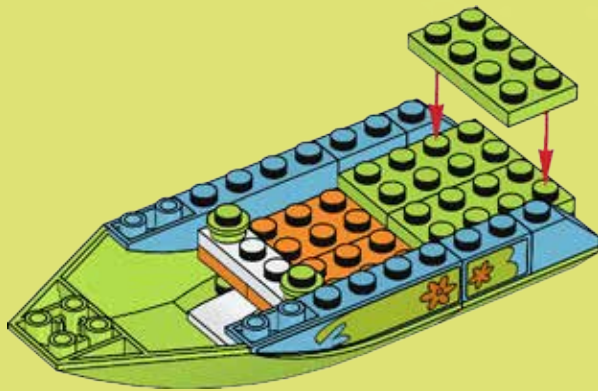

2x



1x

11

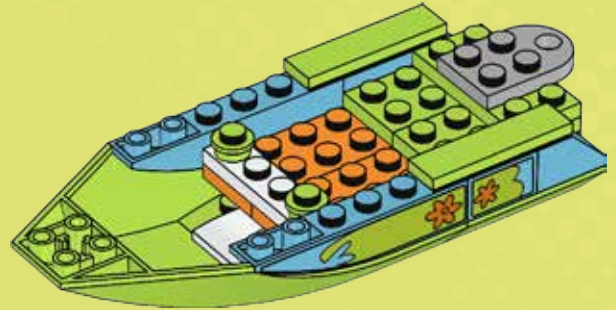

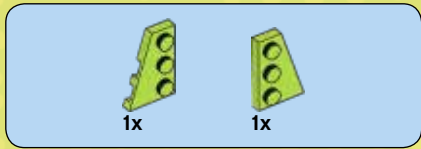

12

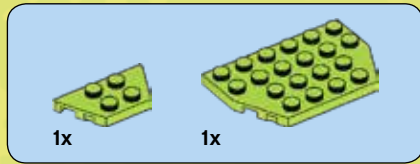
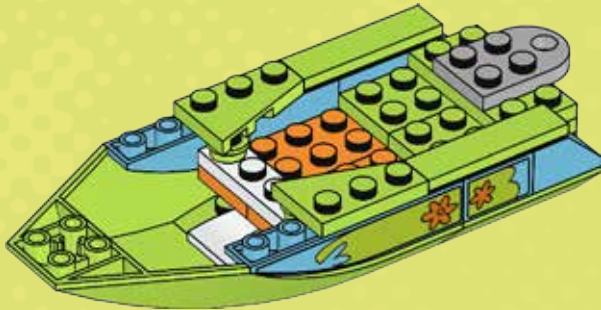

13

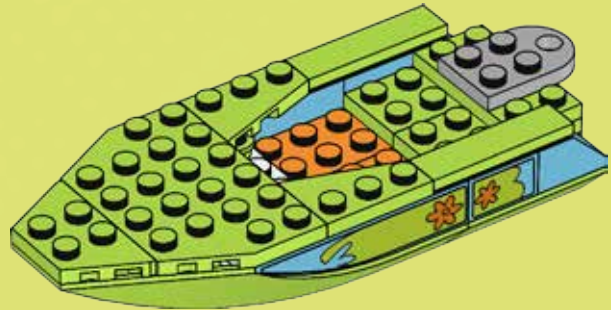



6x

14

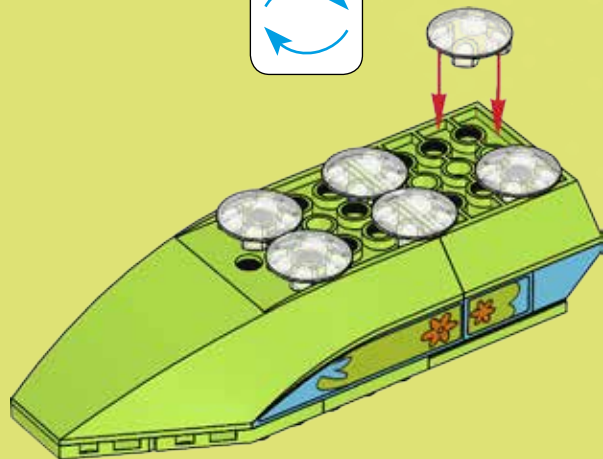
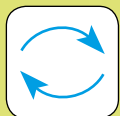

1x

15

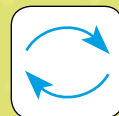



16

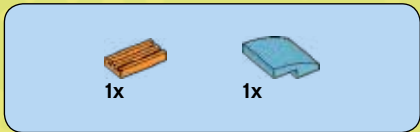

17

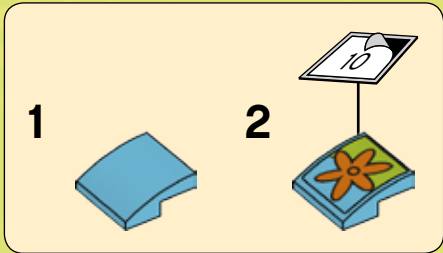



1x



2x

18

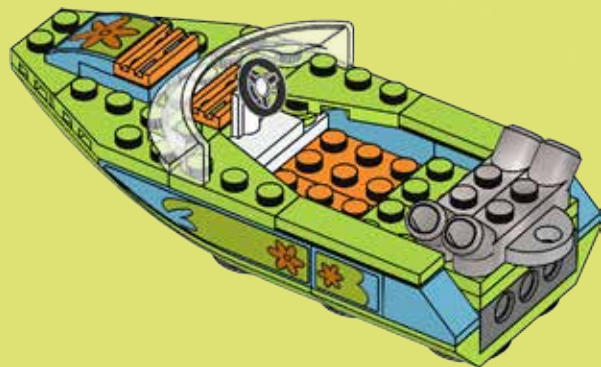

1x



1x



1x

19

1

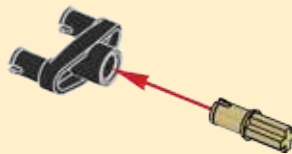

2

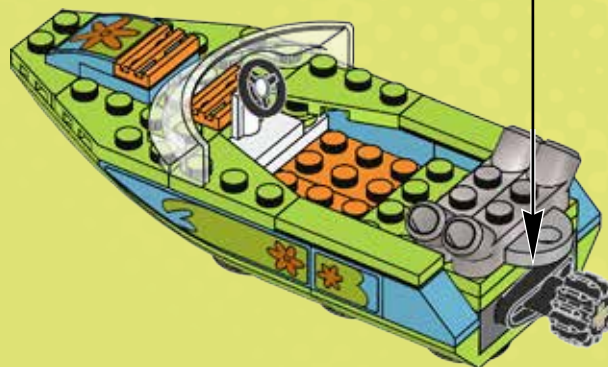

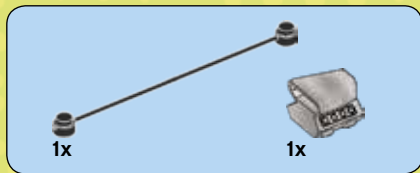

20

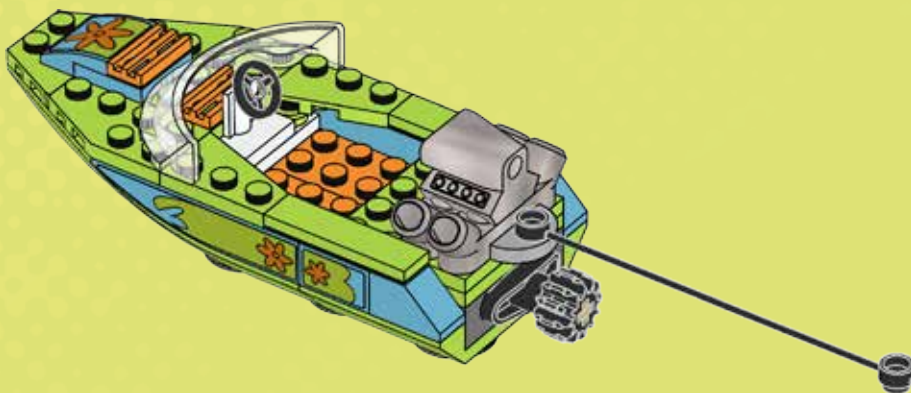



1x



1x

21

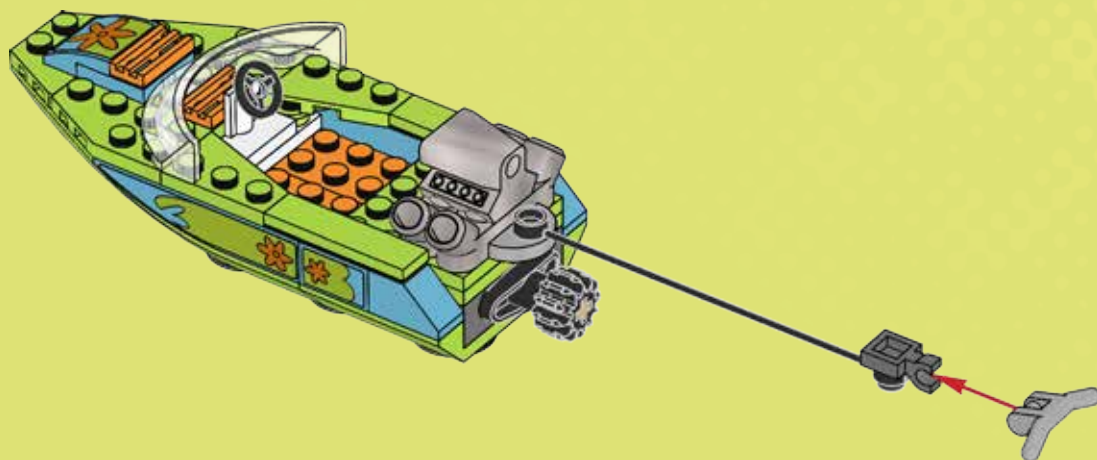



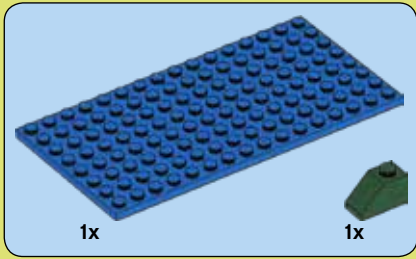
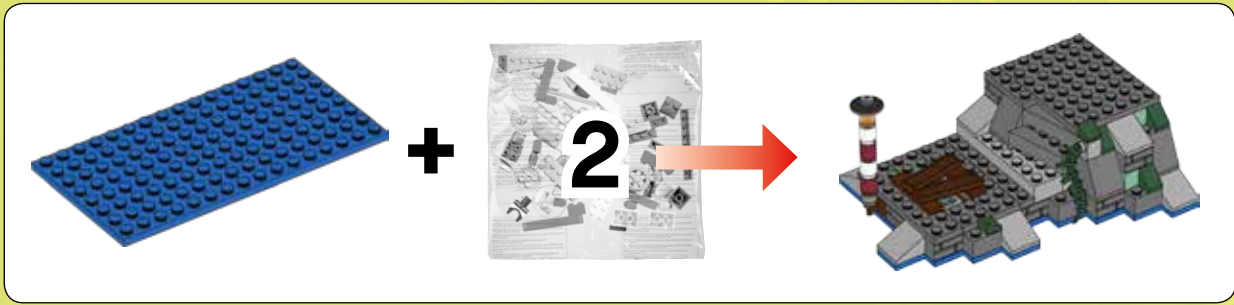

1

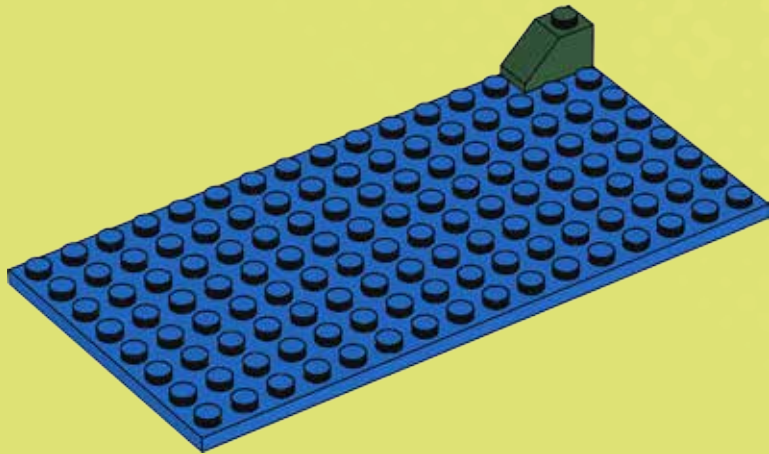



1x



1x

2

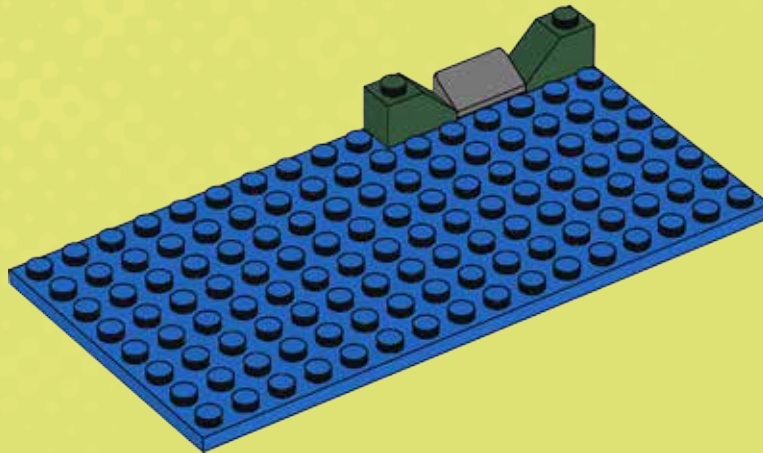

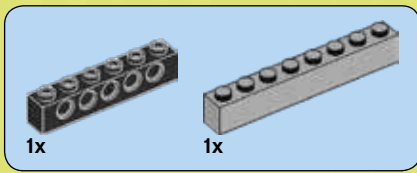

3

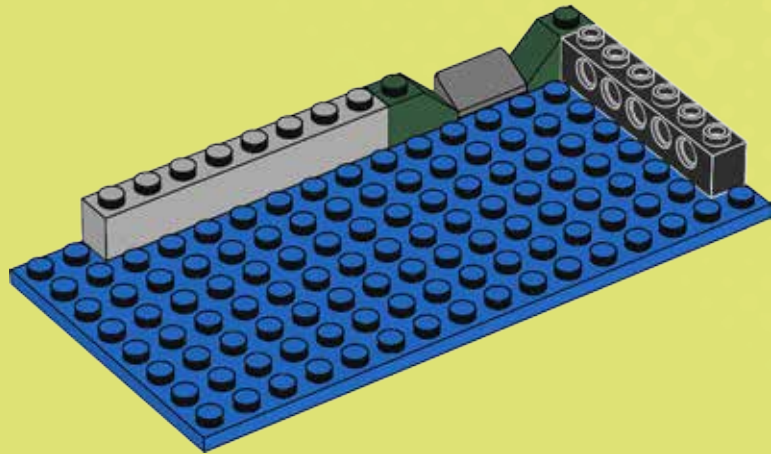

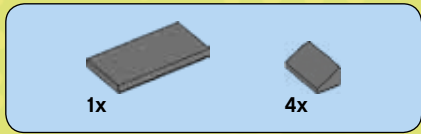

4

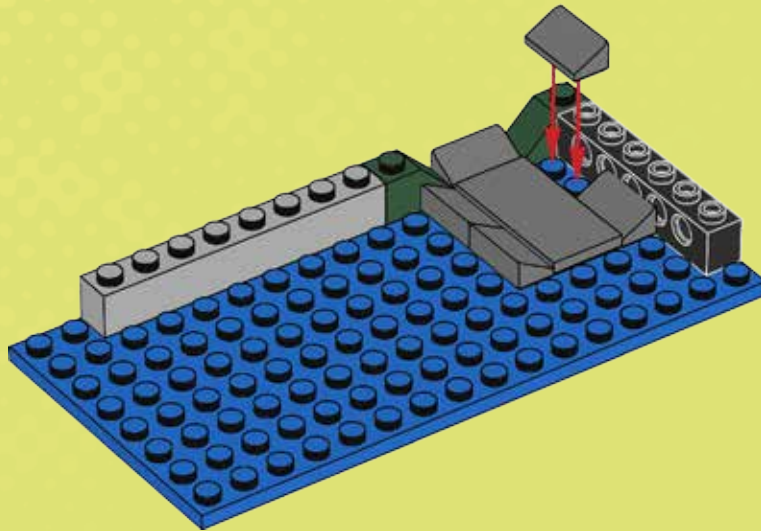

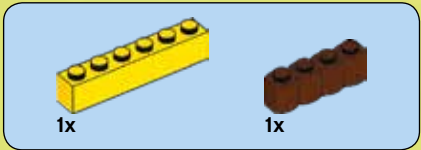

5

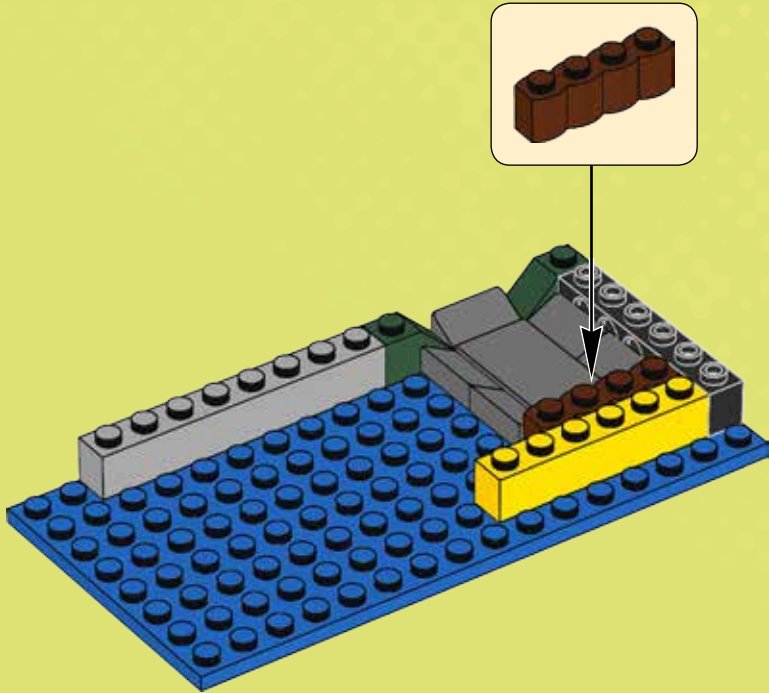

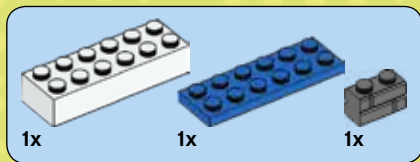

6

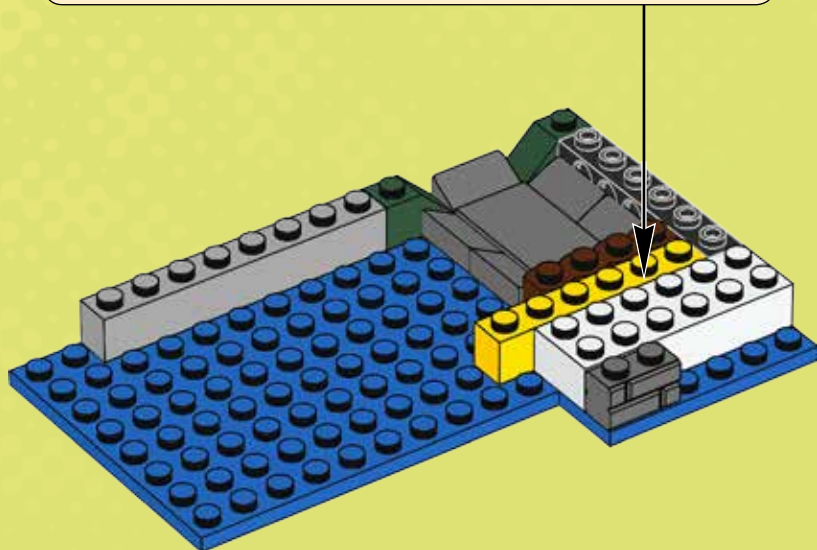
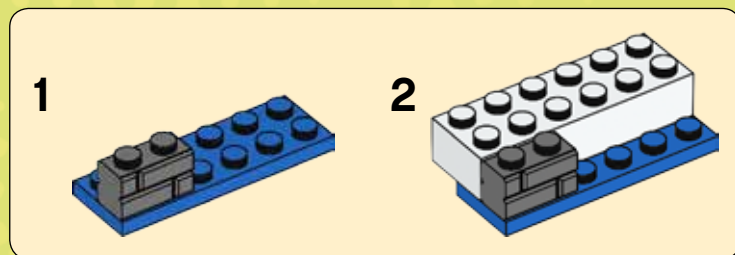

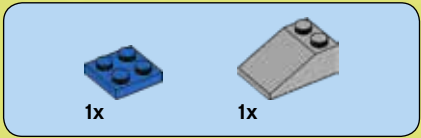

7

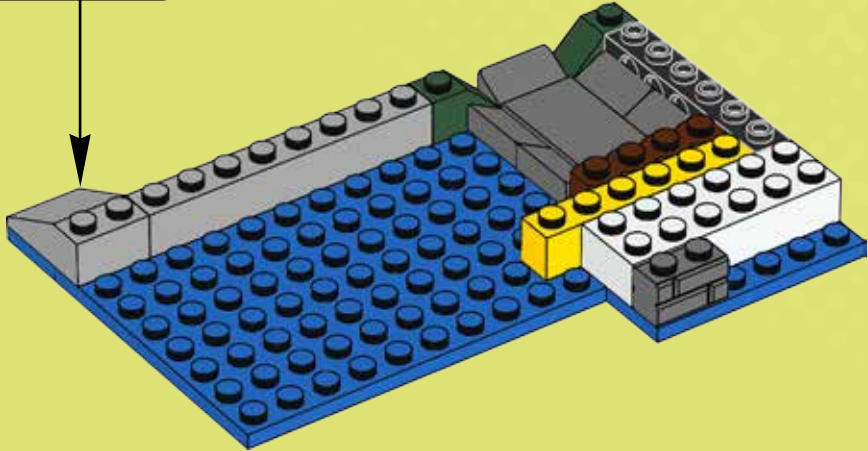
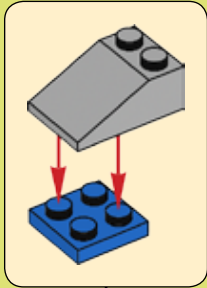



8

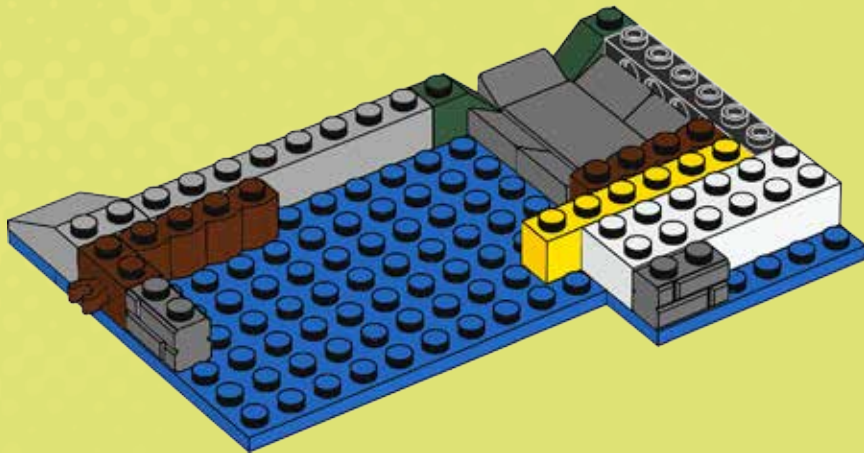

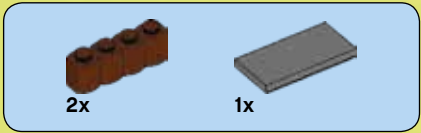

9

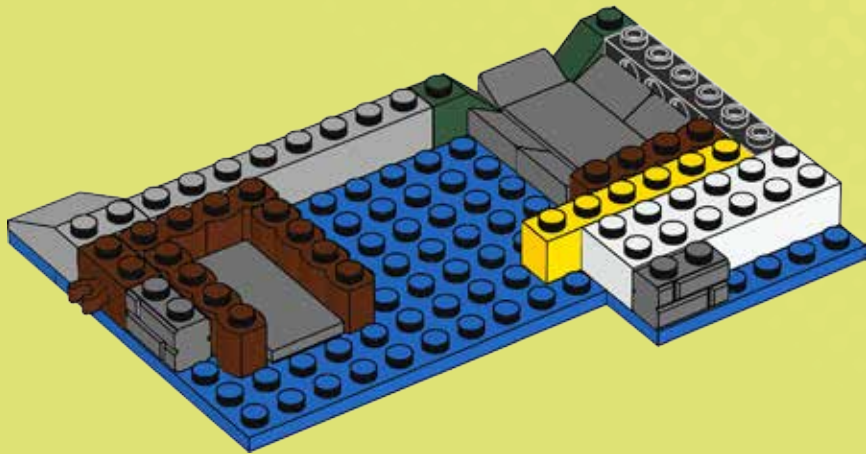



1x



1x

10

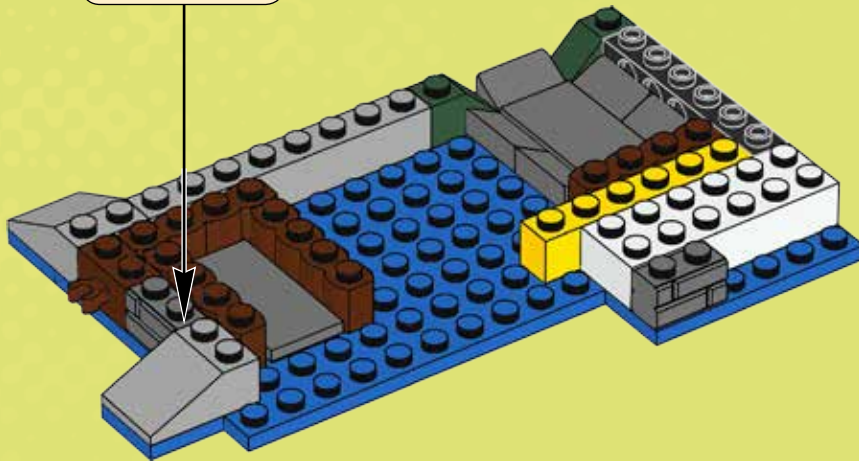
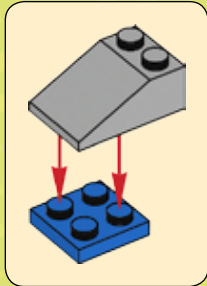

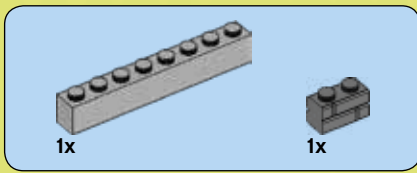

11

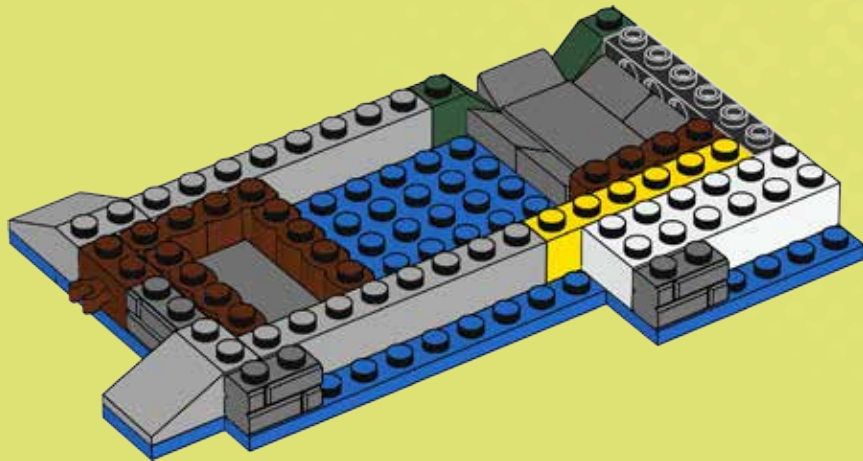



3x



3x

12

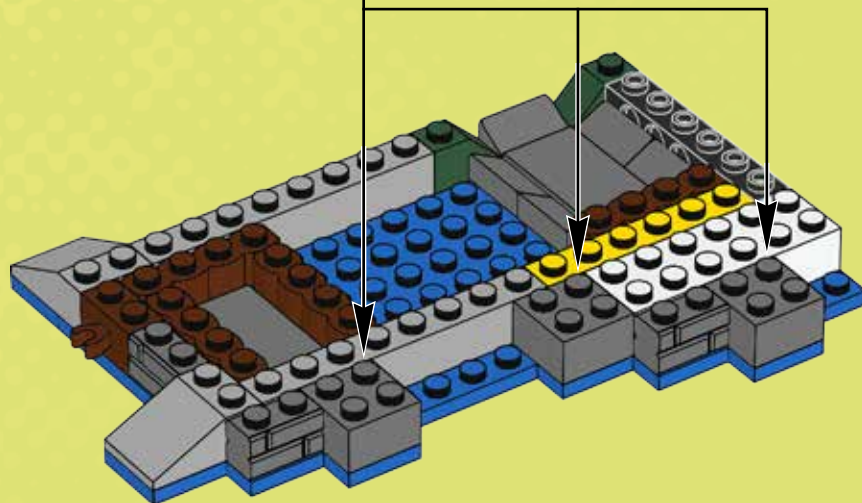
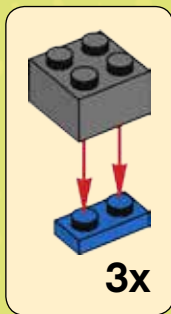

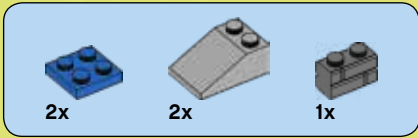

13

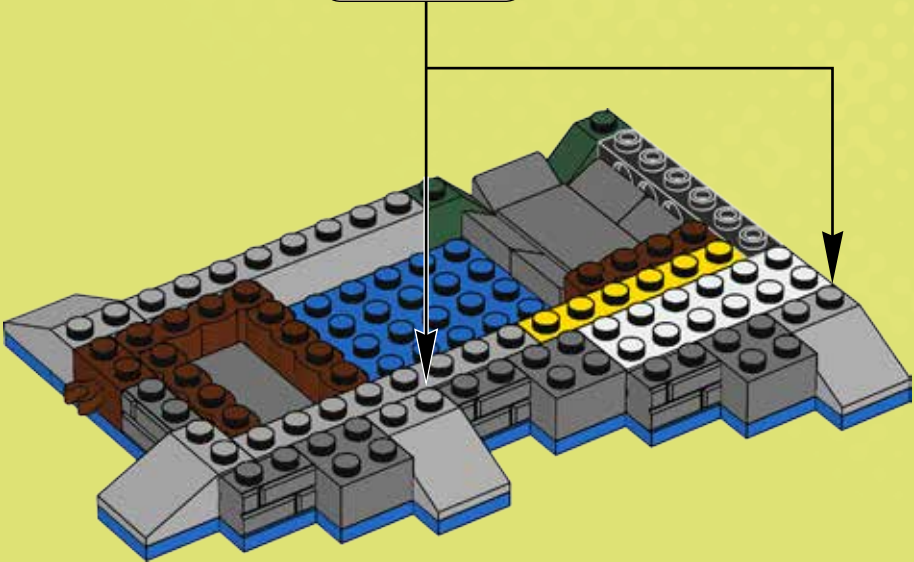
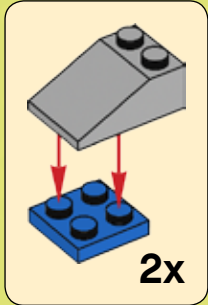



14

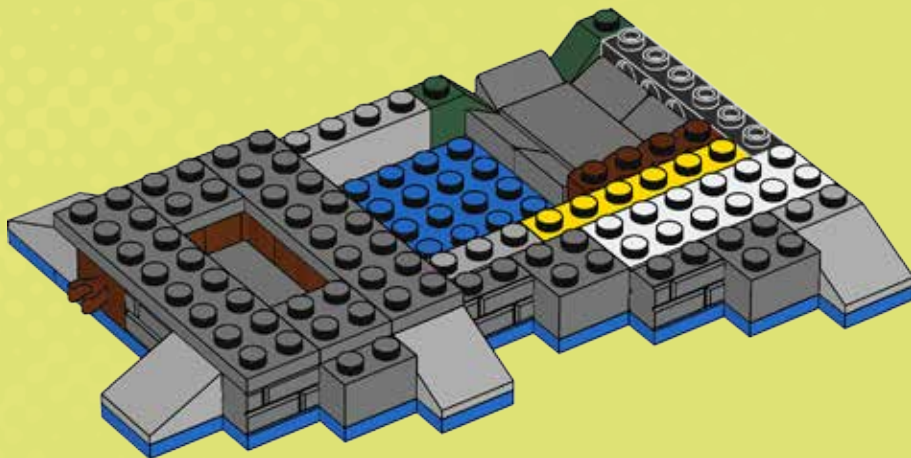

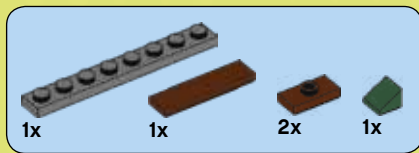

15

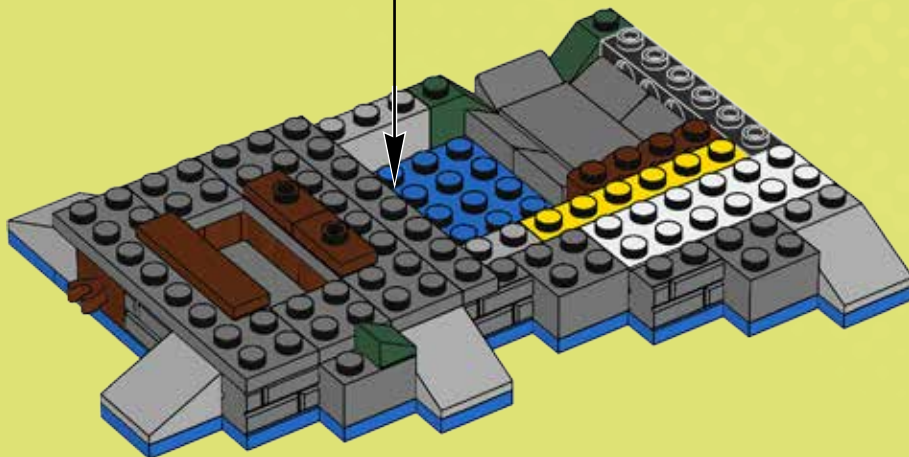
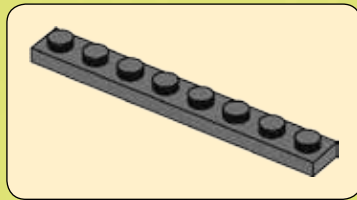

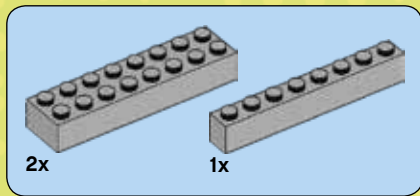

16

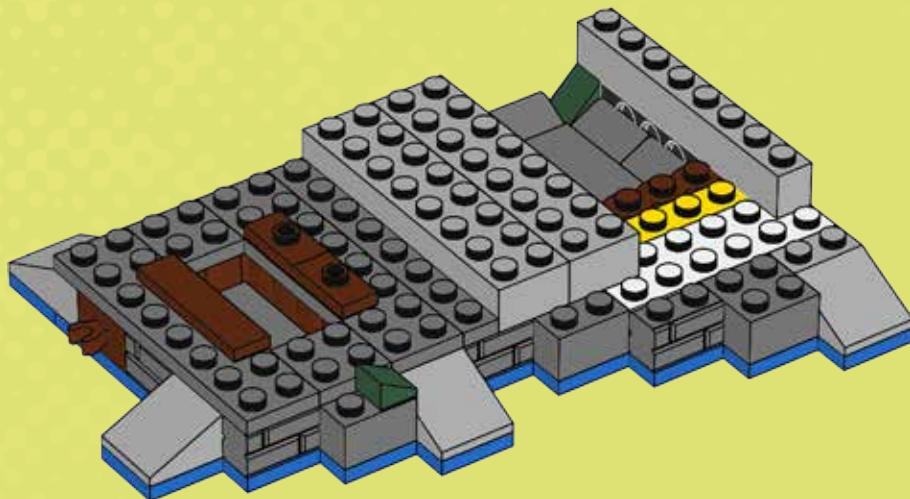

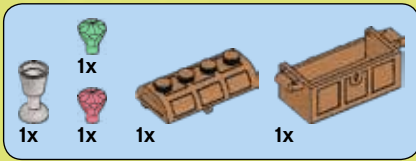

17

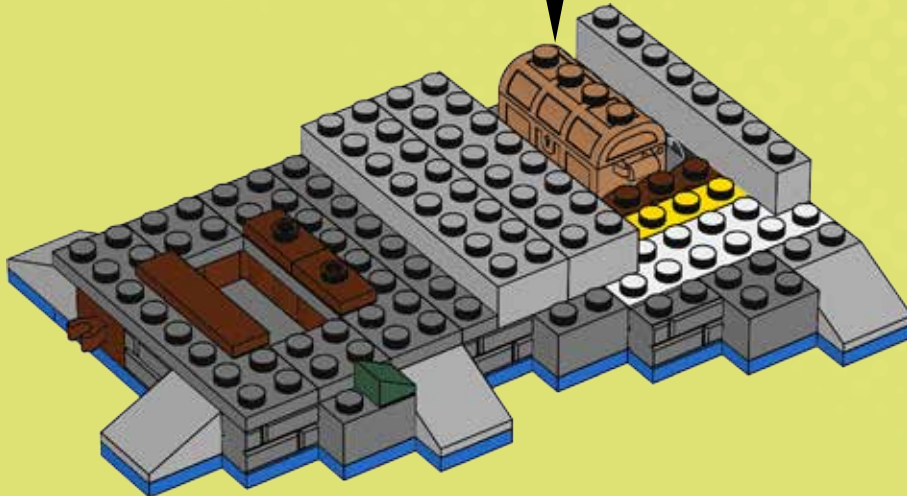
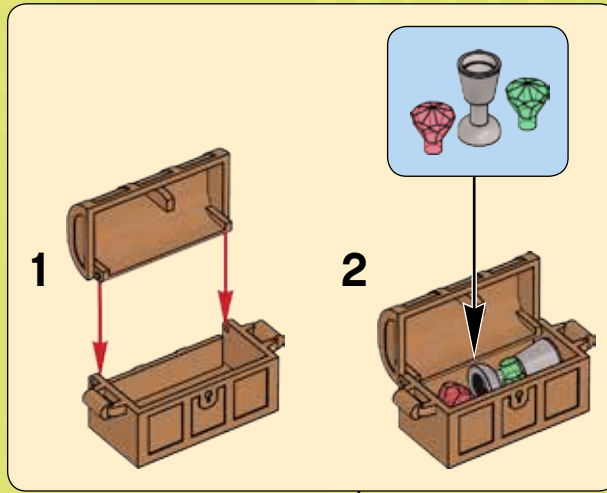

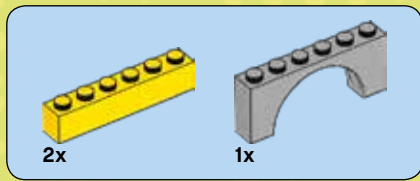

18



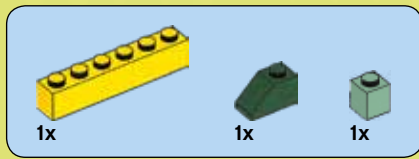

19

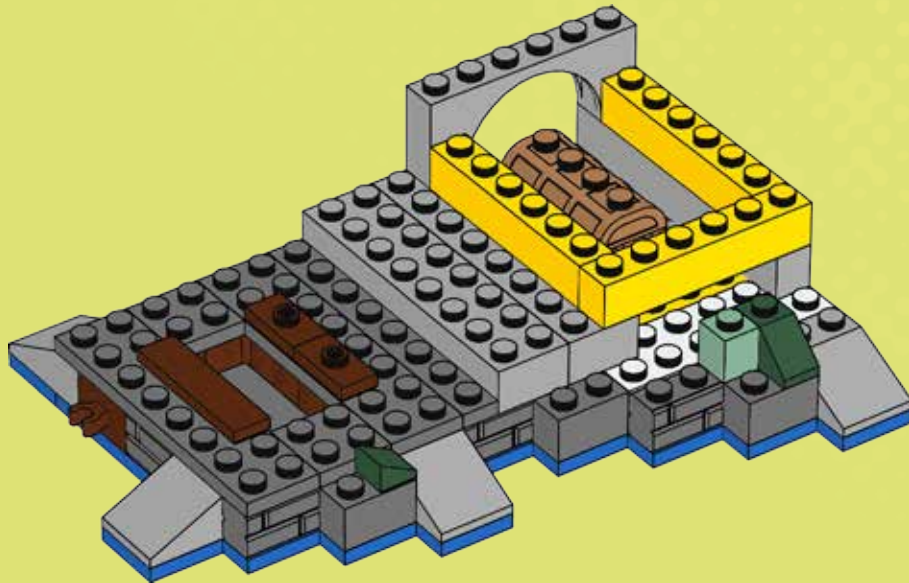

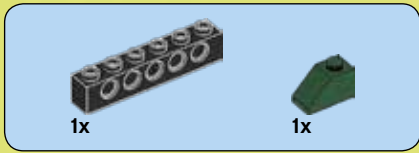

21

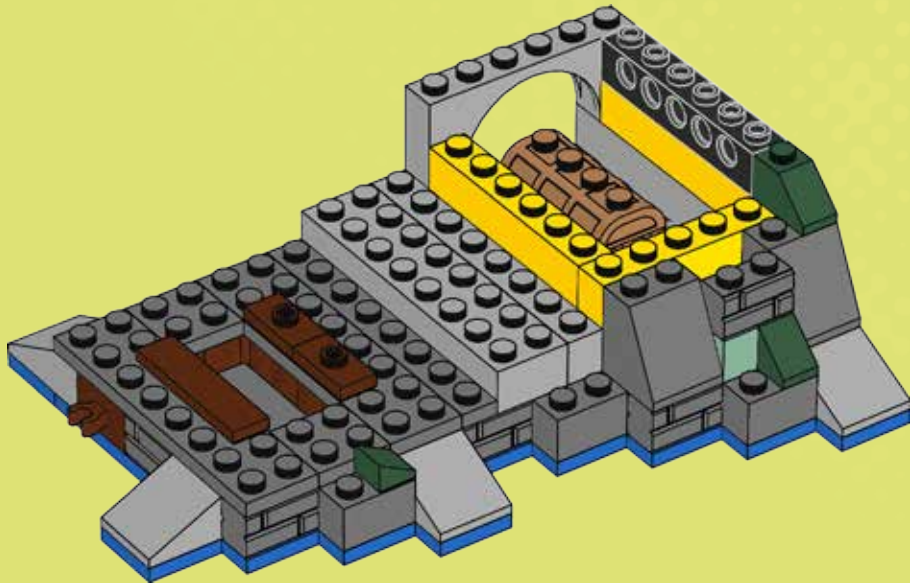



1x



1x



1x

22

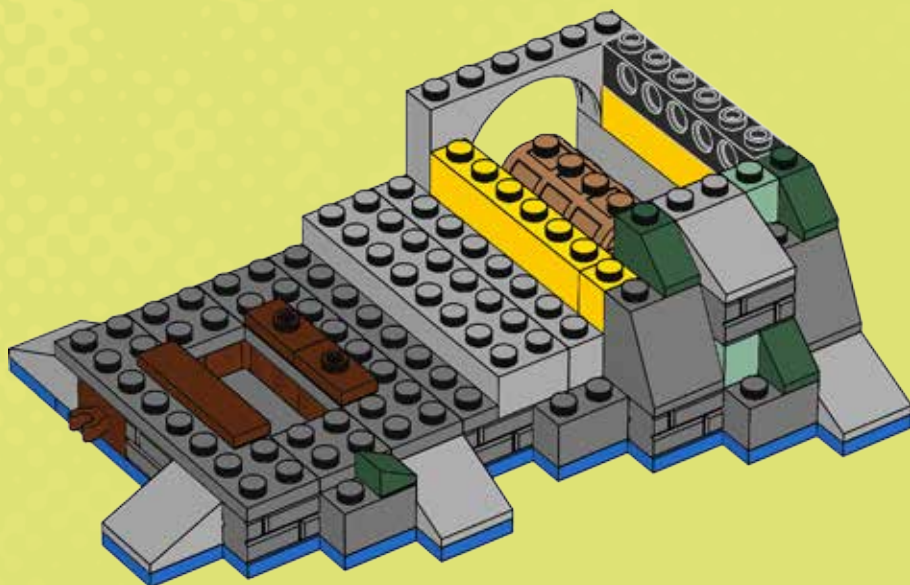



1x



1x

23

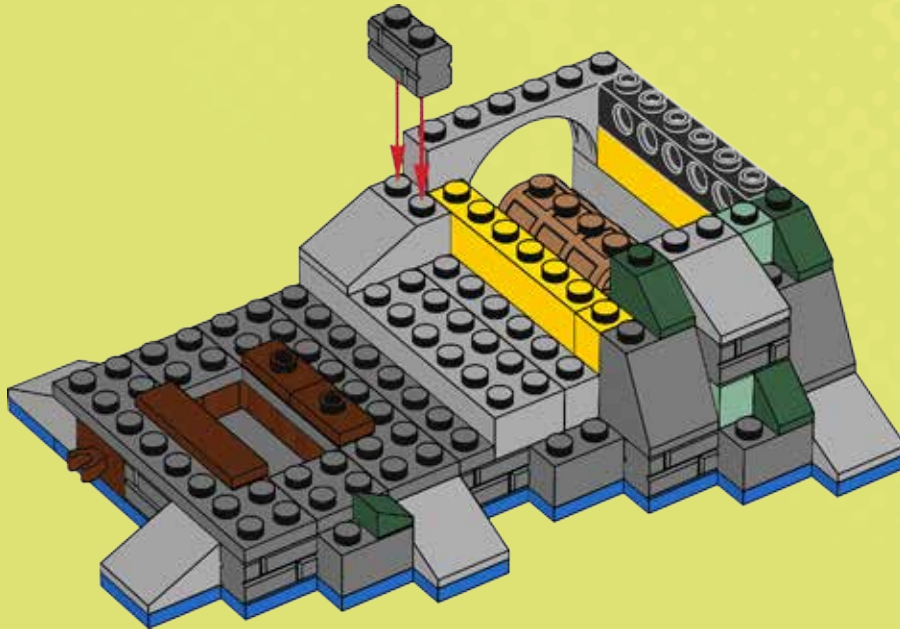



1x

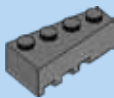

1x

24

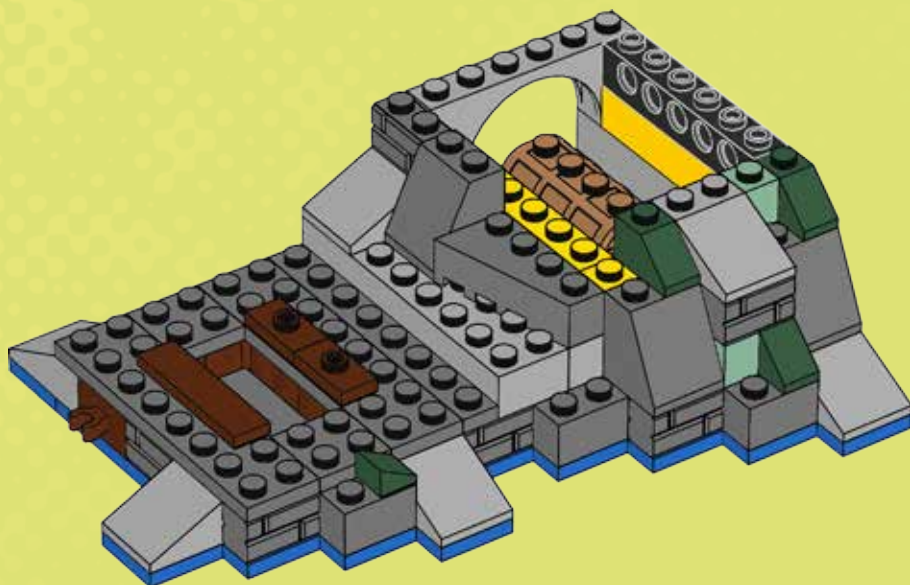



1x



1x

25

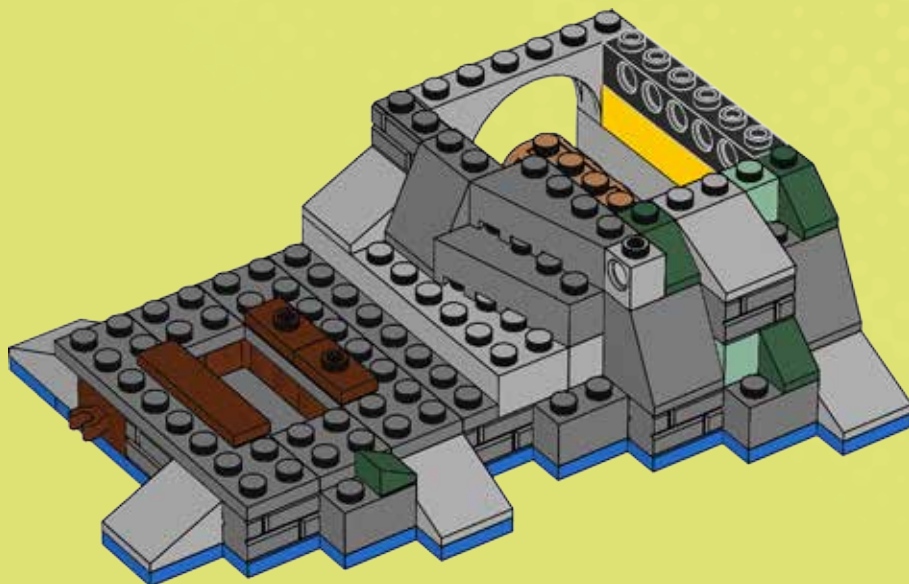

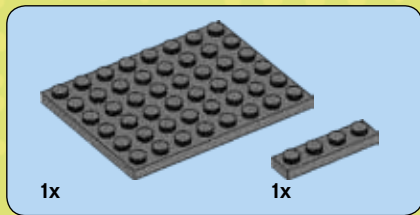

26

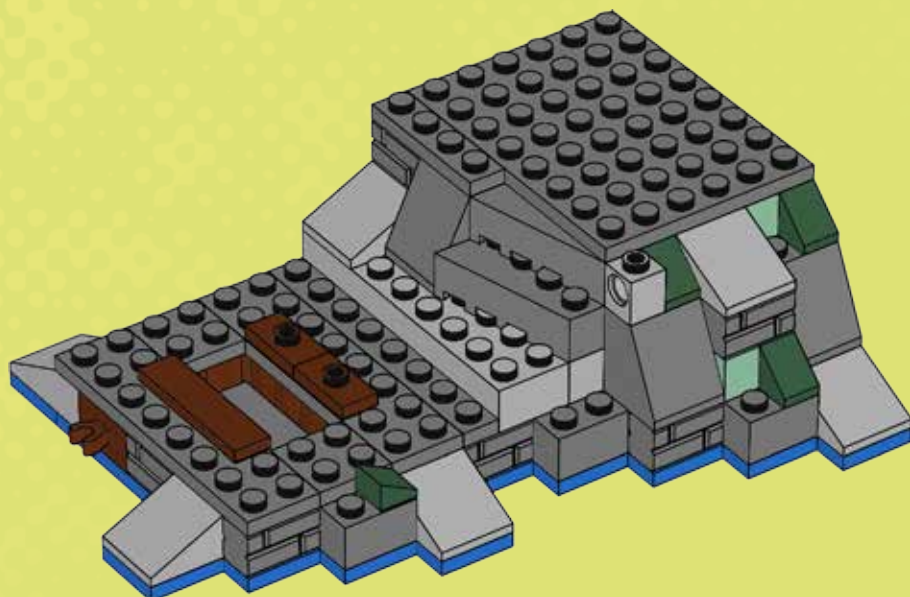

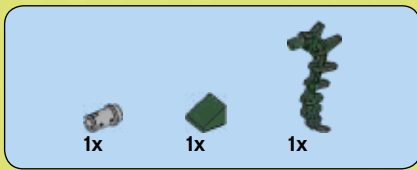

27

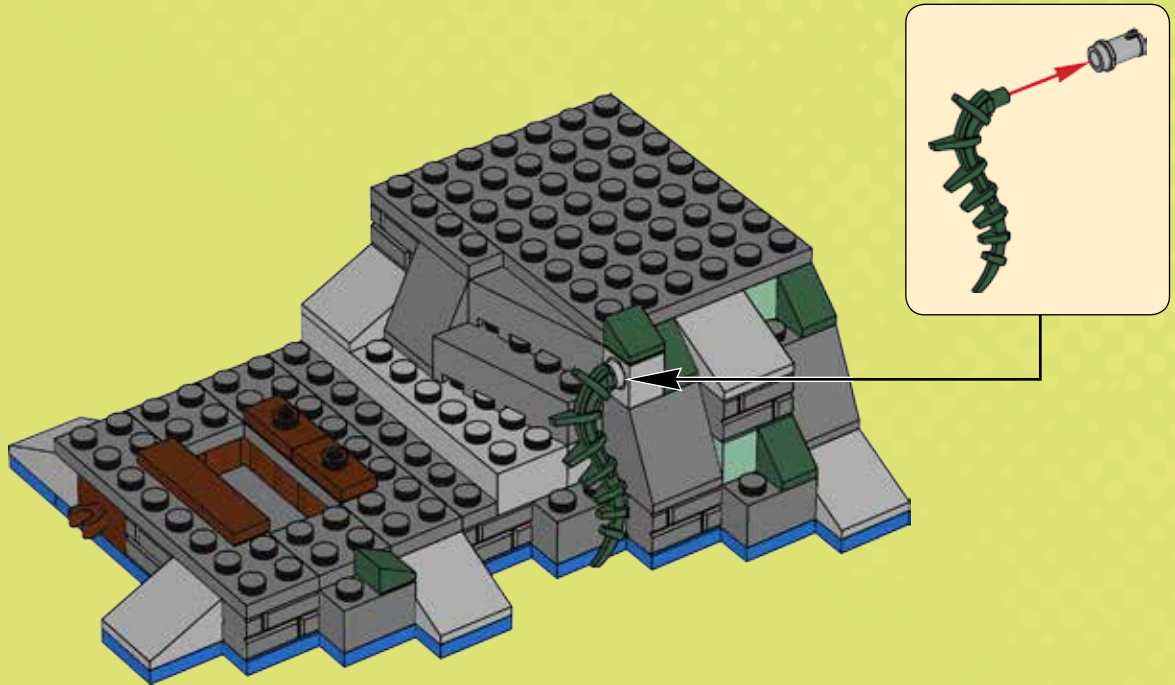

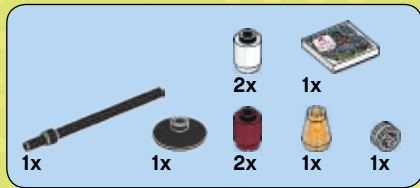

28

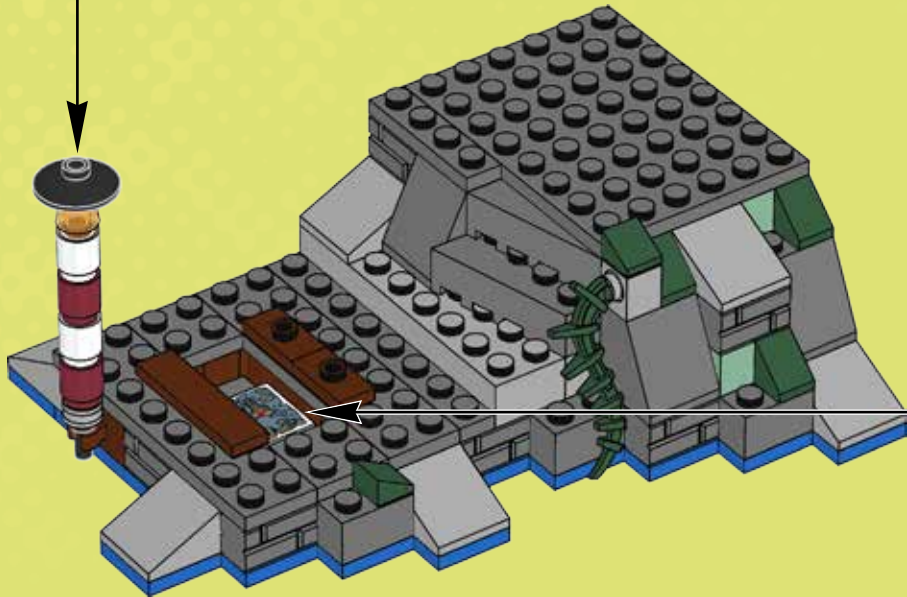
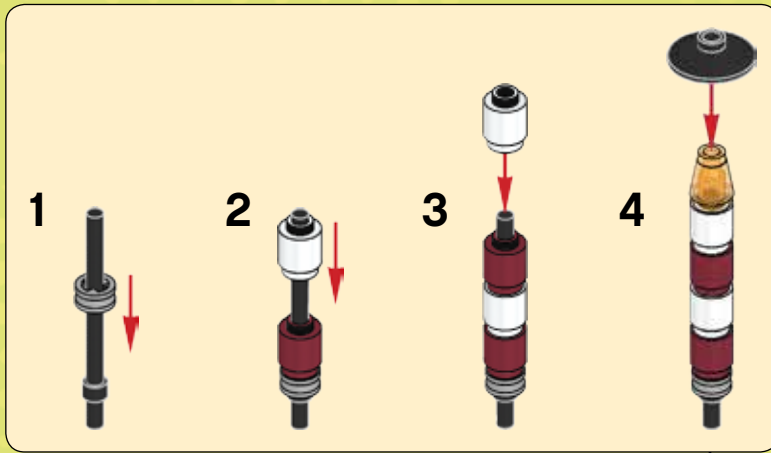



29

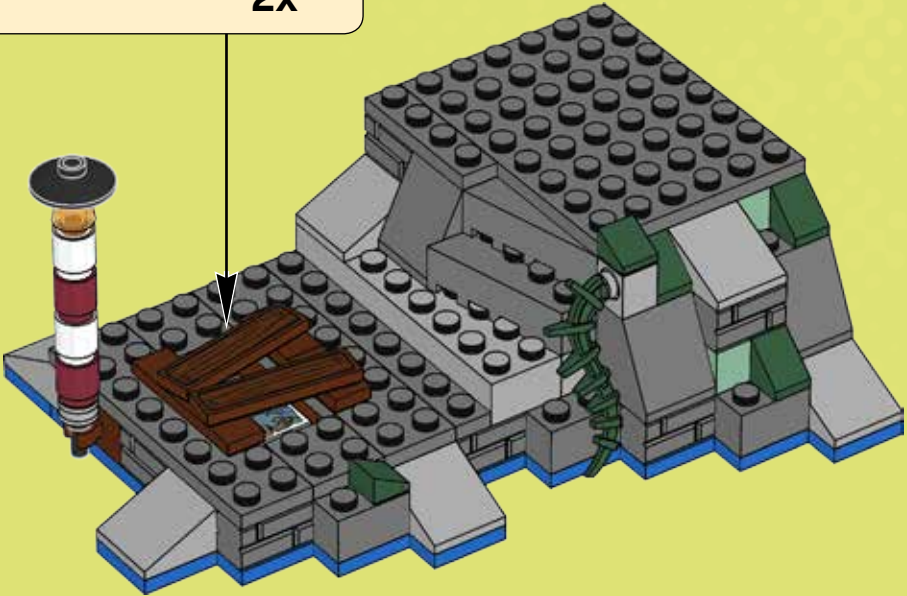
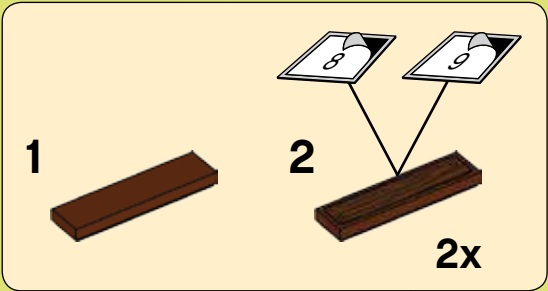

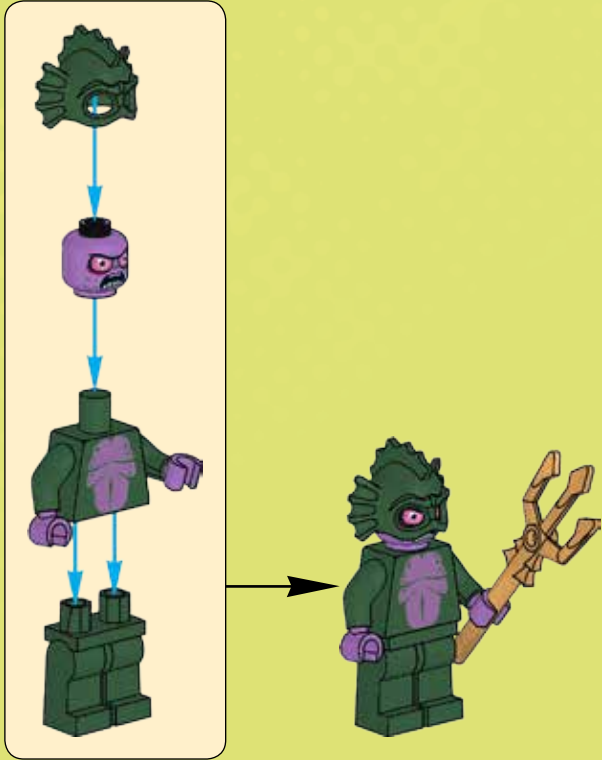

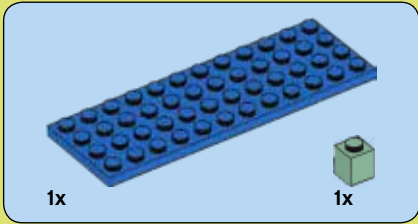
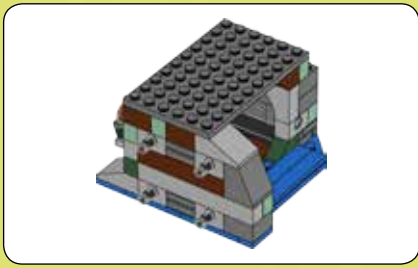

1x

1x

1

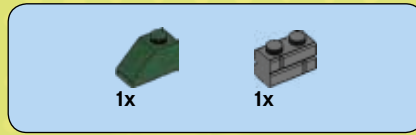
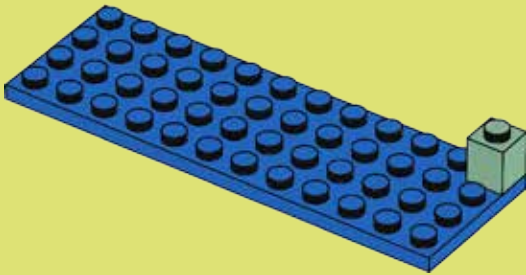

1x

1x

2

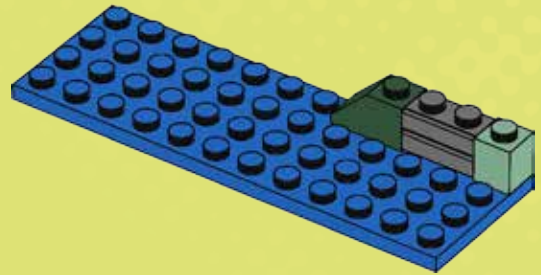

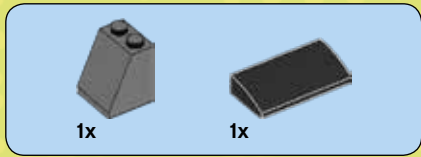

3

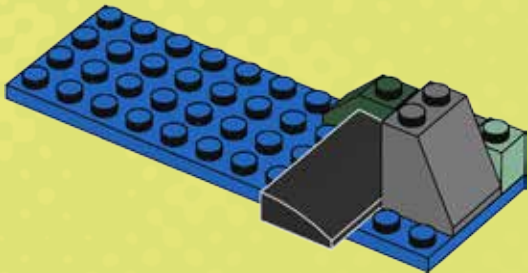

4

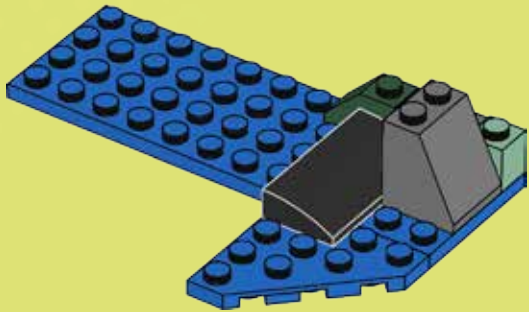

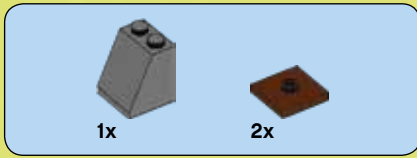

5

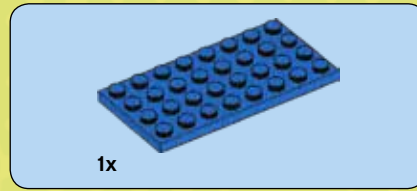
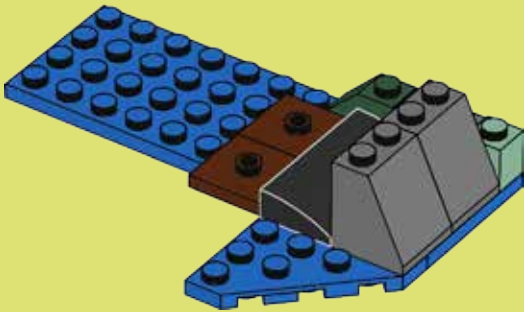

6

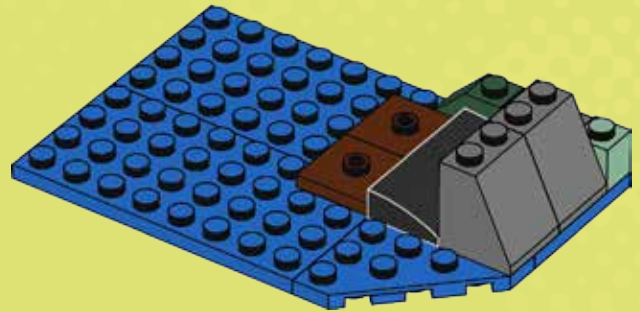

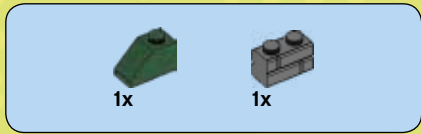

7

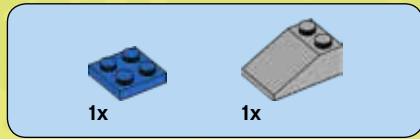
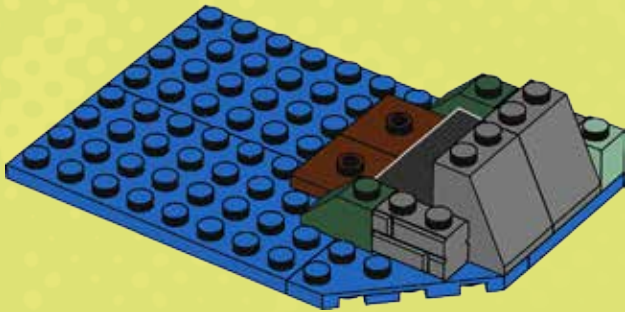

8

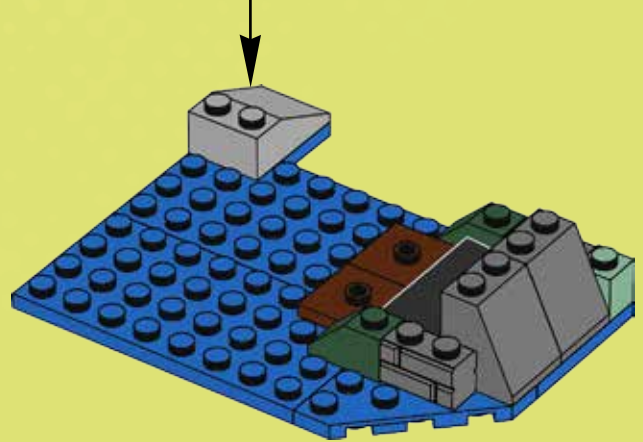
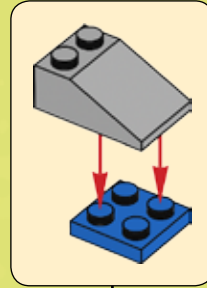



2x



1x

9

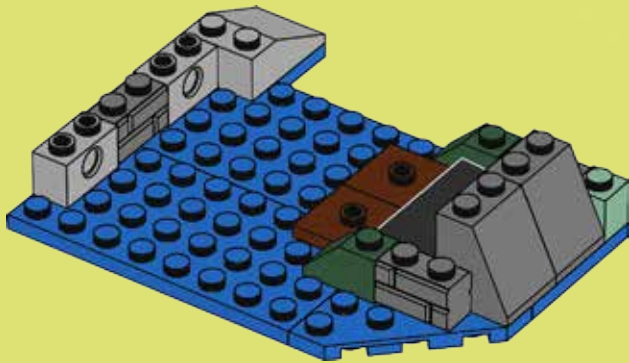

1x



1x



1x

10

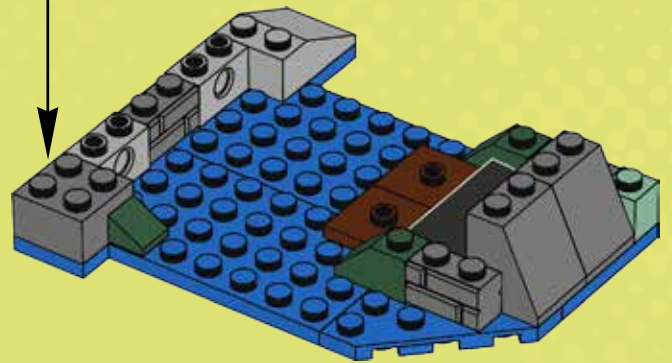
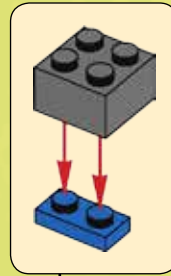



2x

11

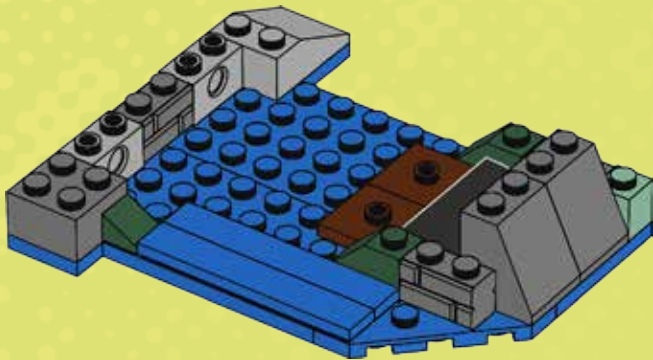

2x

12

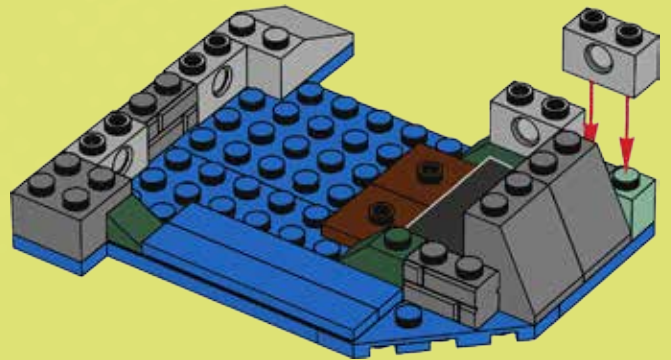



13

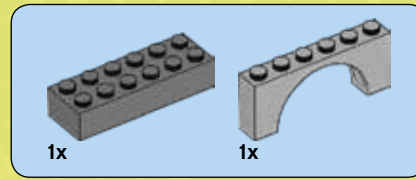
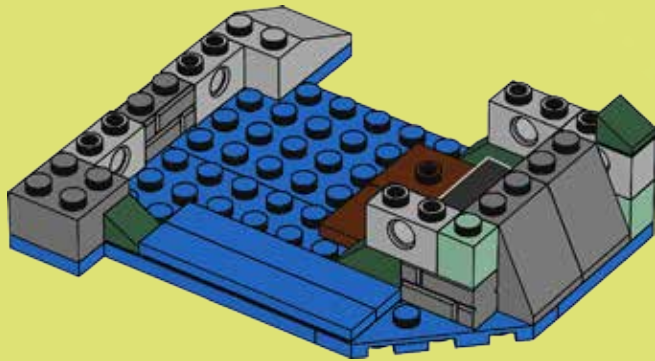

14

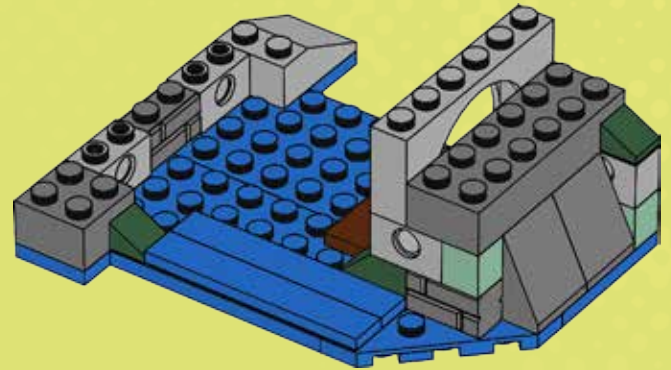



2x

15

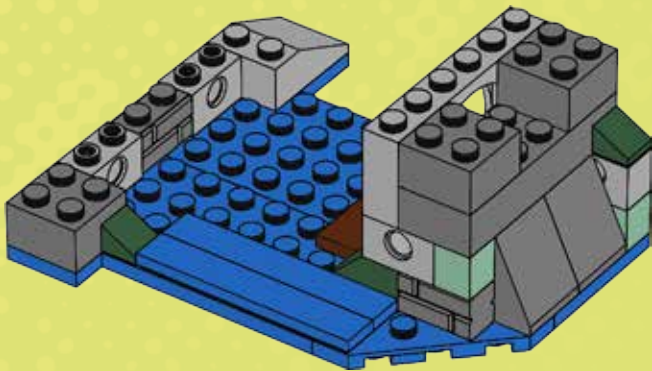

2x



1x

16

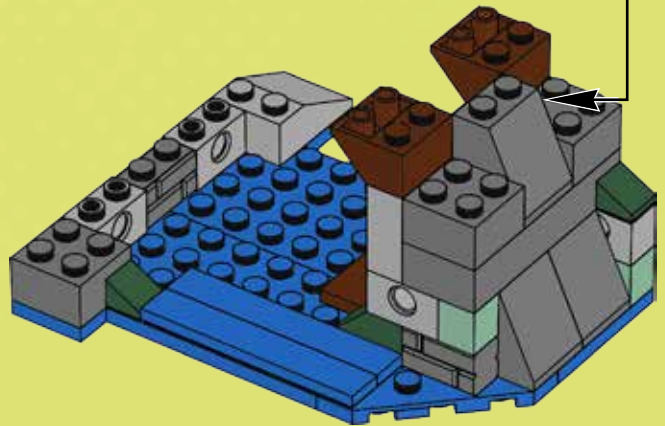
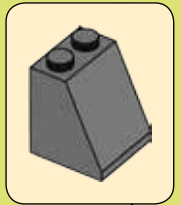



2x



2x

17

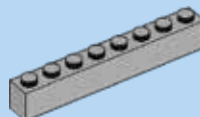
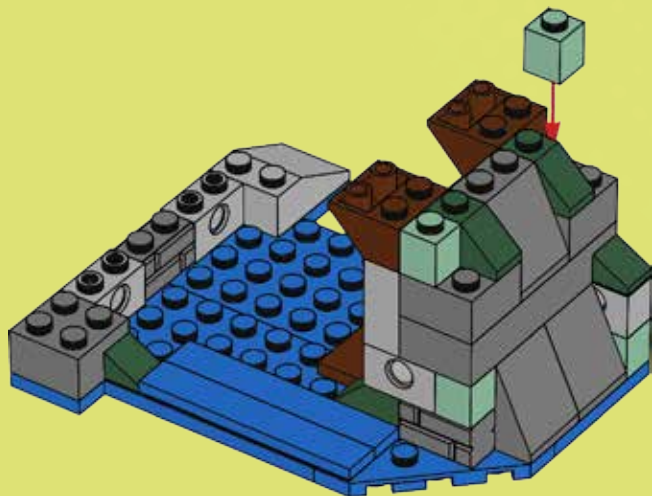

1x



1x



2x

18

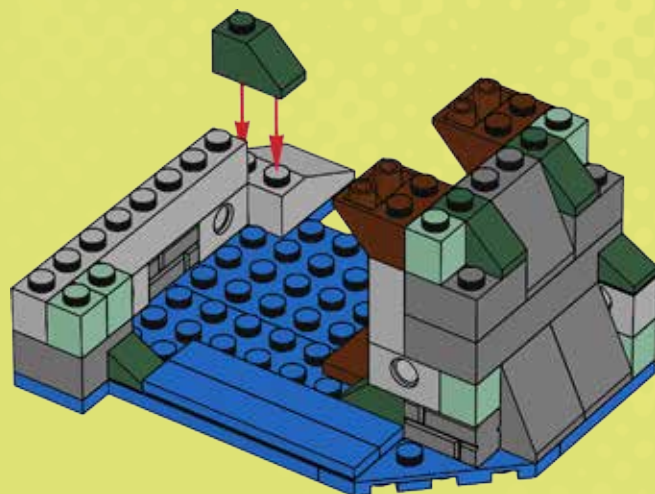

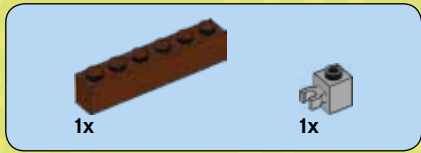

19

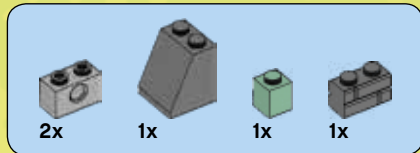
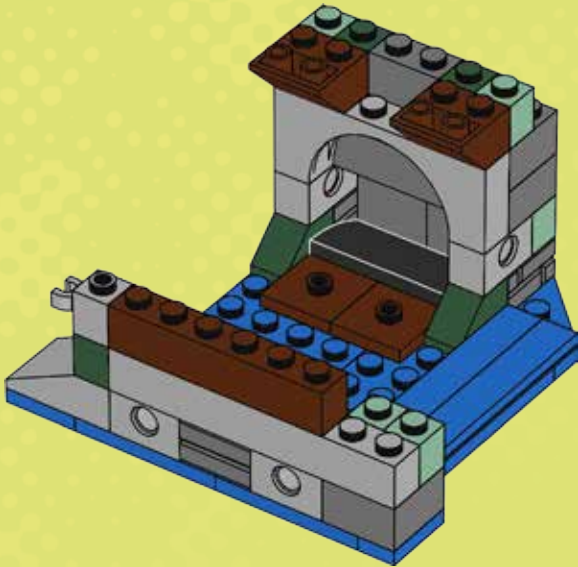

20

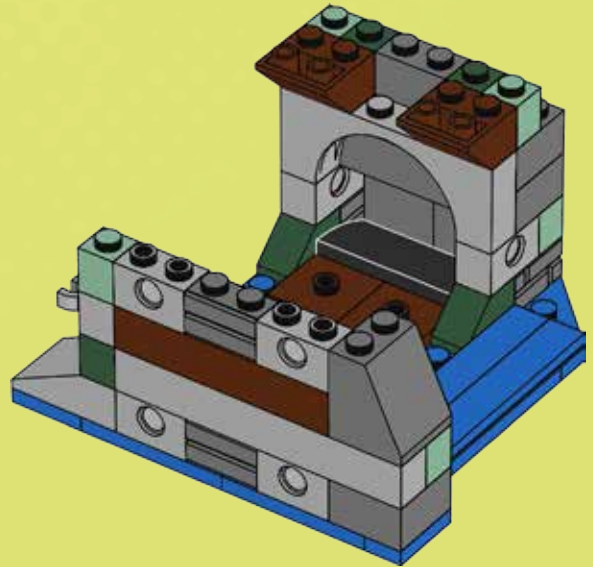

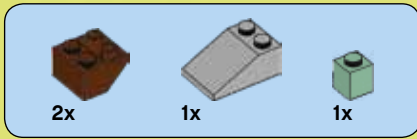

21

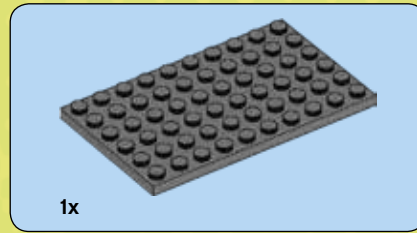
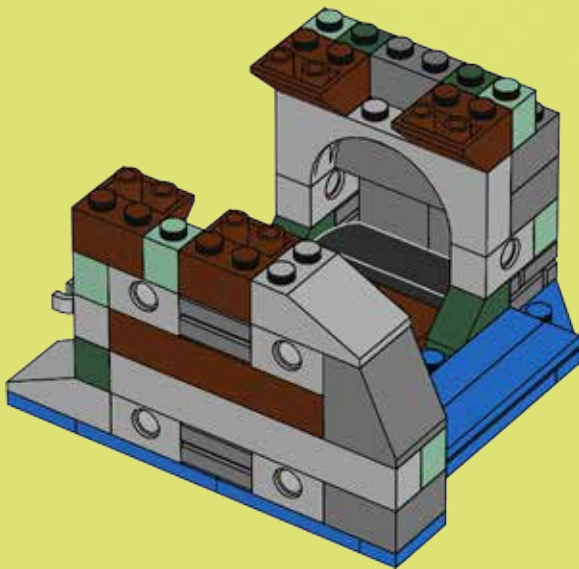

22

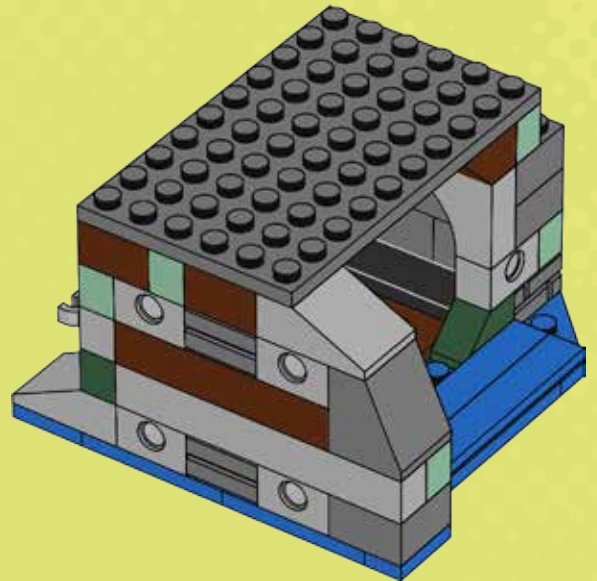



4x



1x



1x

23

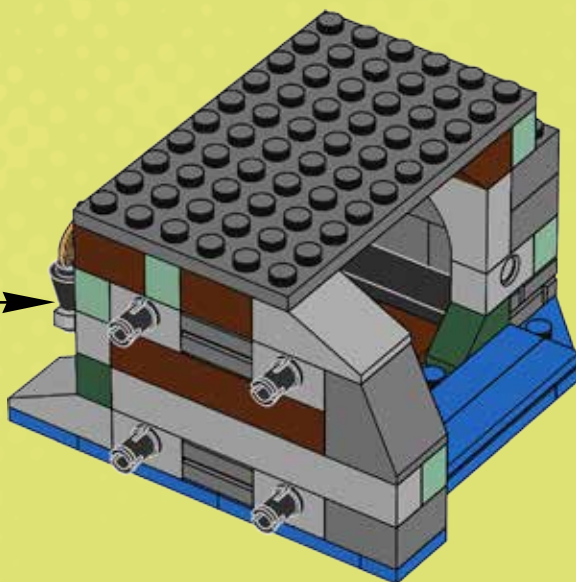
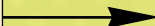
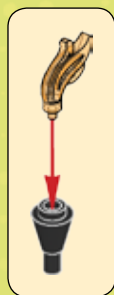

30

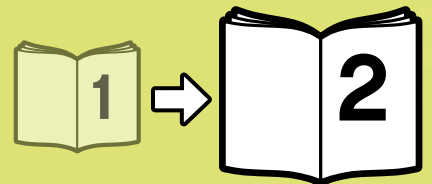
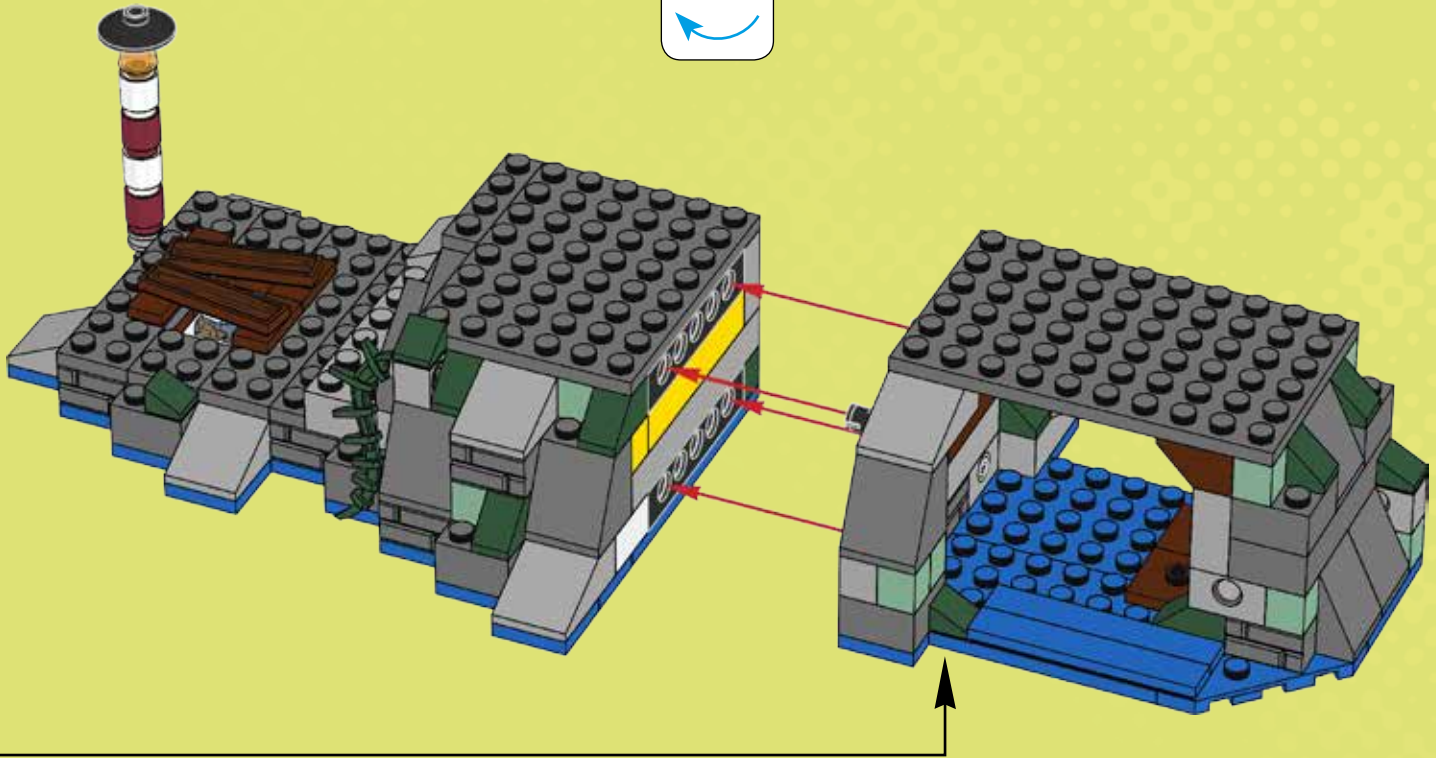
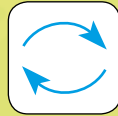



SCOOBY-DOO!

75903



 [LEGO.com/scoobydoo](https://www.LEGO.com/scoobydoo)

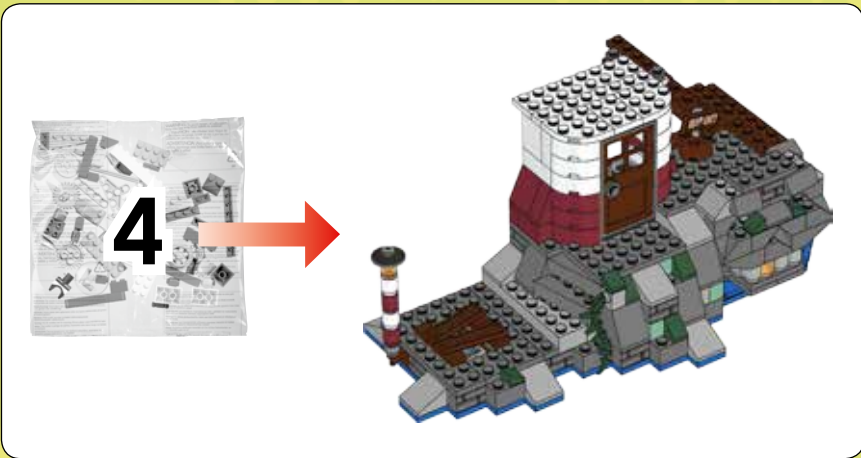

1

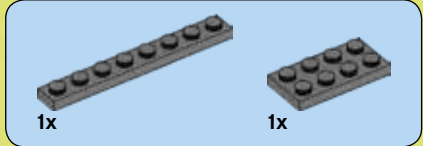
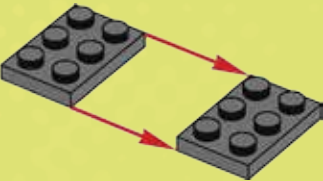

2

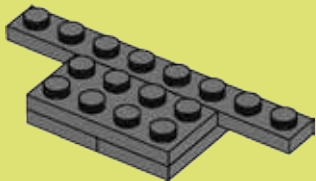



1x

3

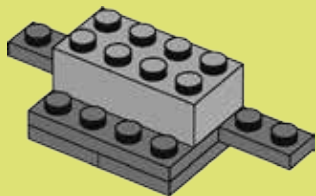

2x

4

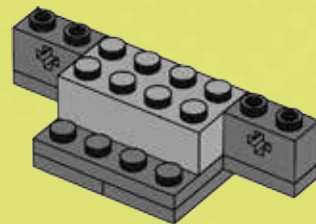



3x



1x

5



1x

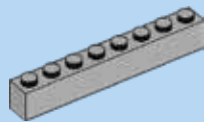

1x

6

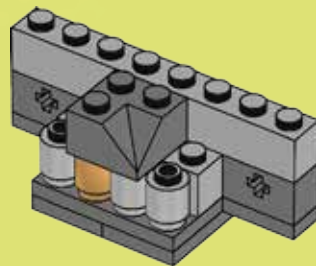

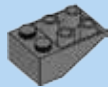

2x

7

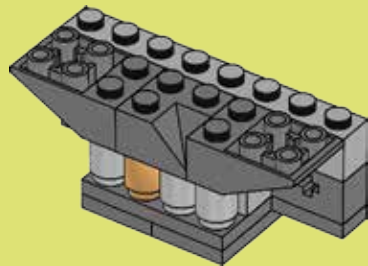

2x



1x

8

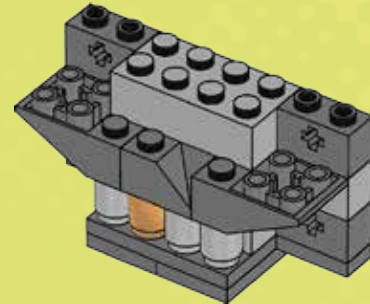



2x



1x

11

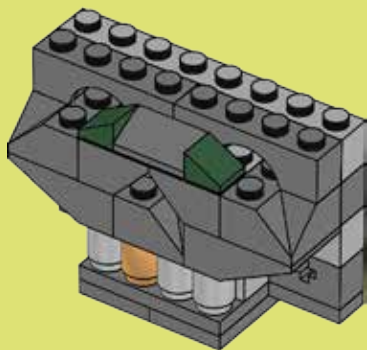

1x



2x

12

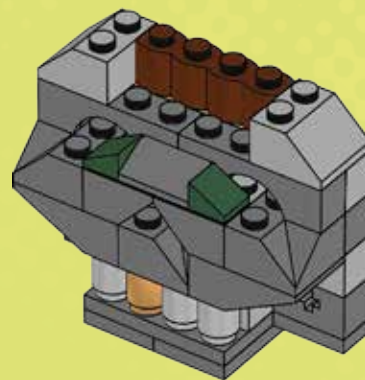



2x



1x

13

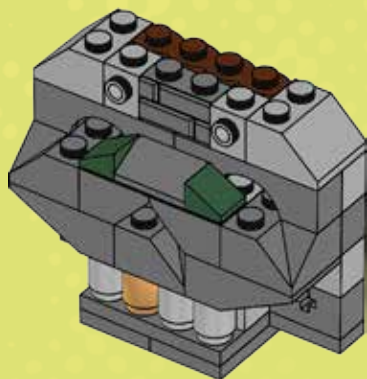

1x



2x

14

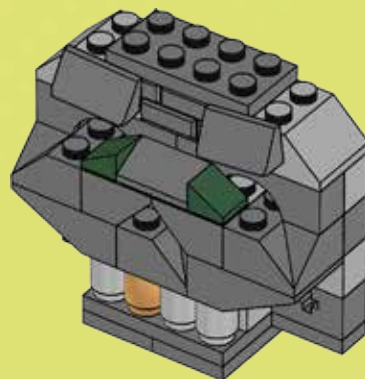

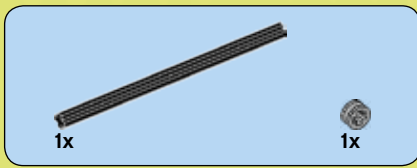

15

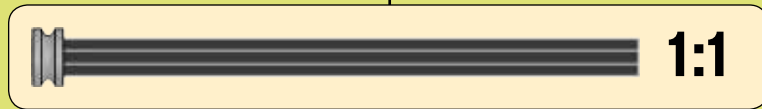
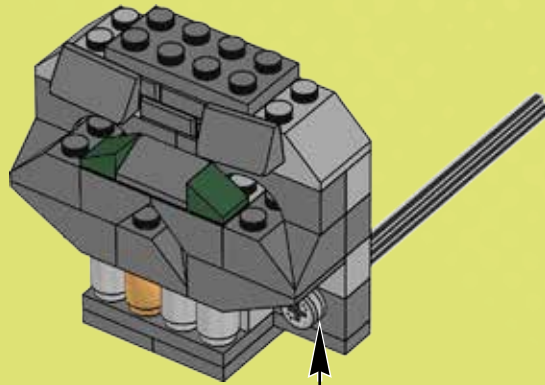

31

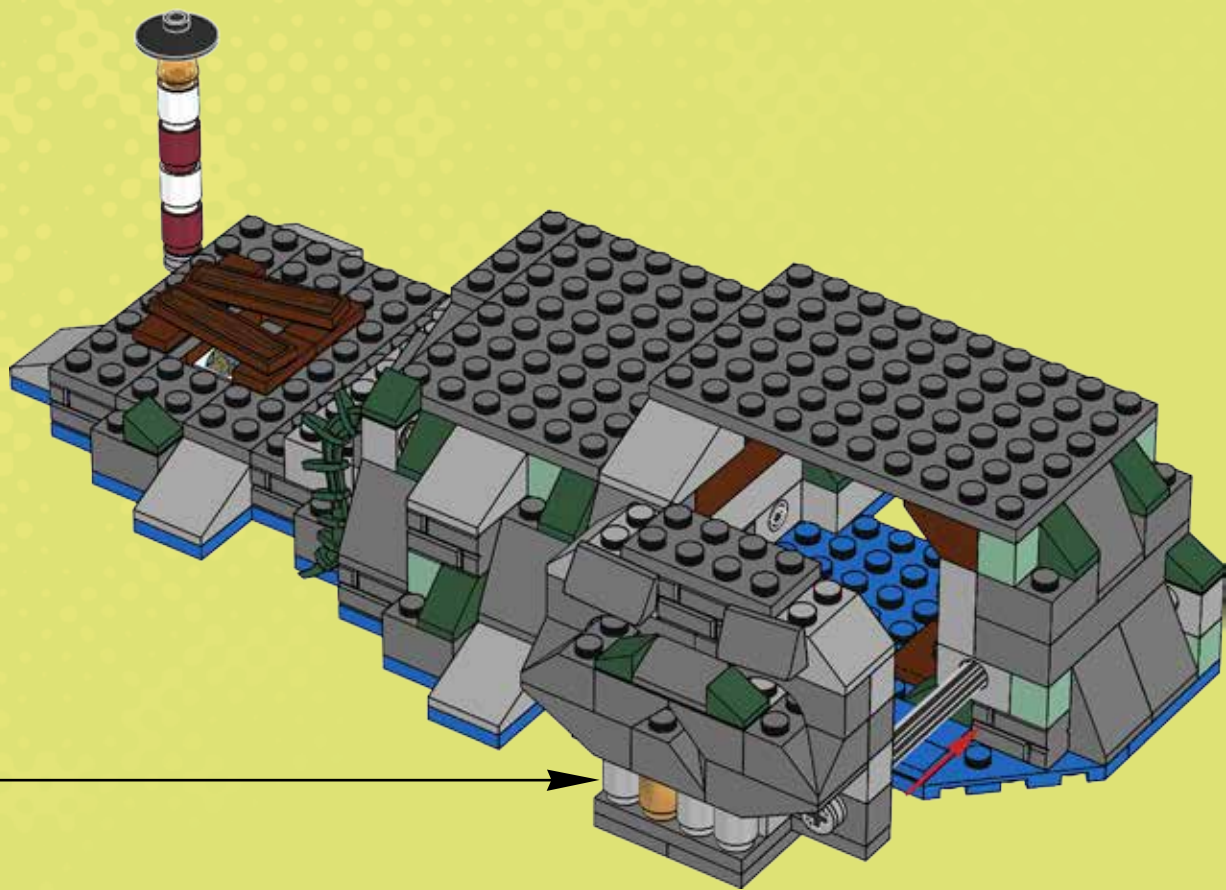



1x

32

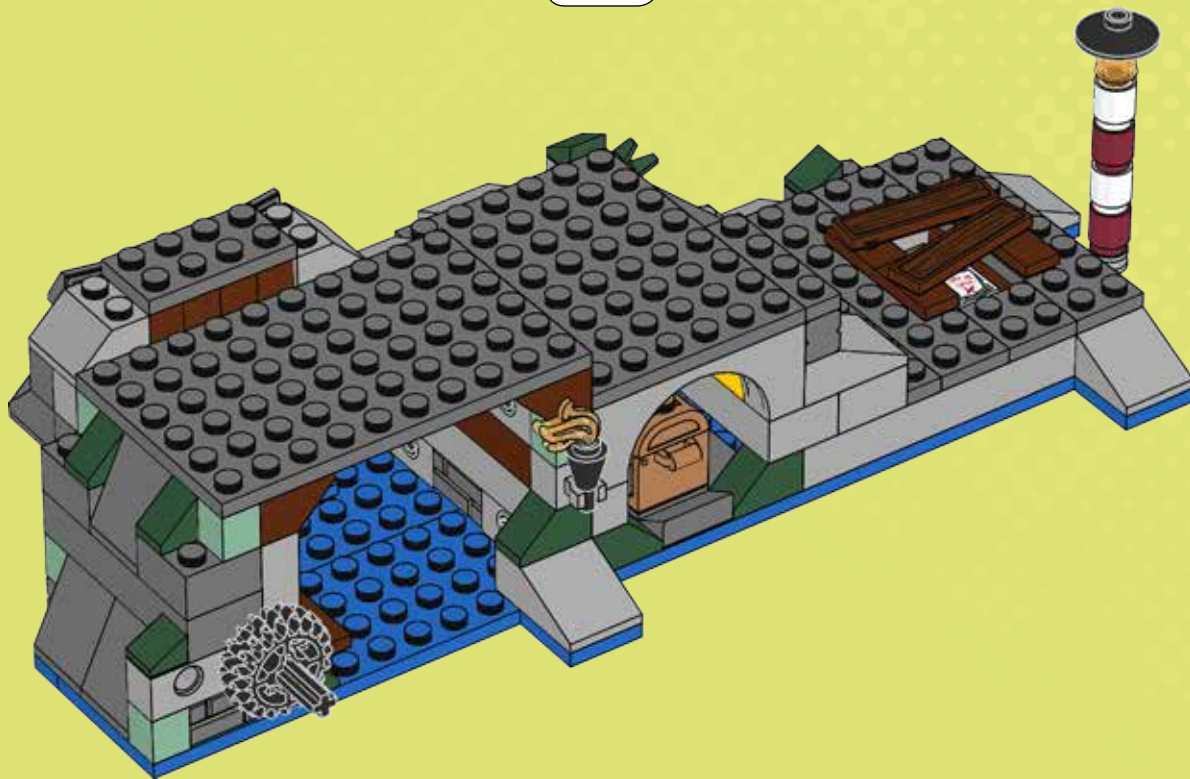
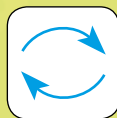



1x



1x

33

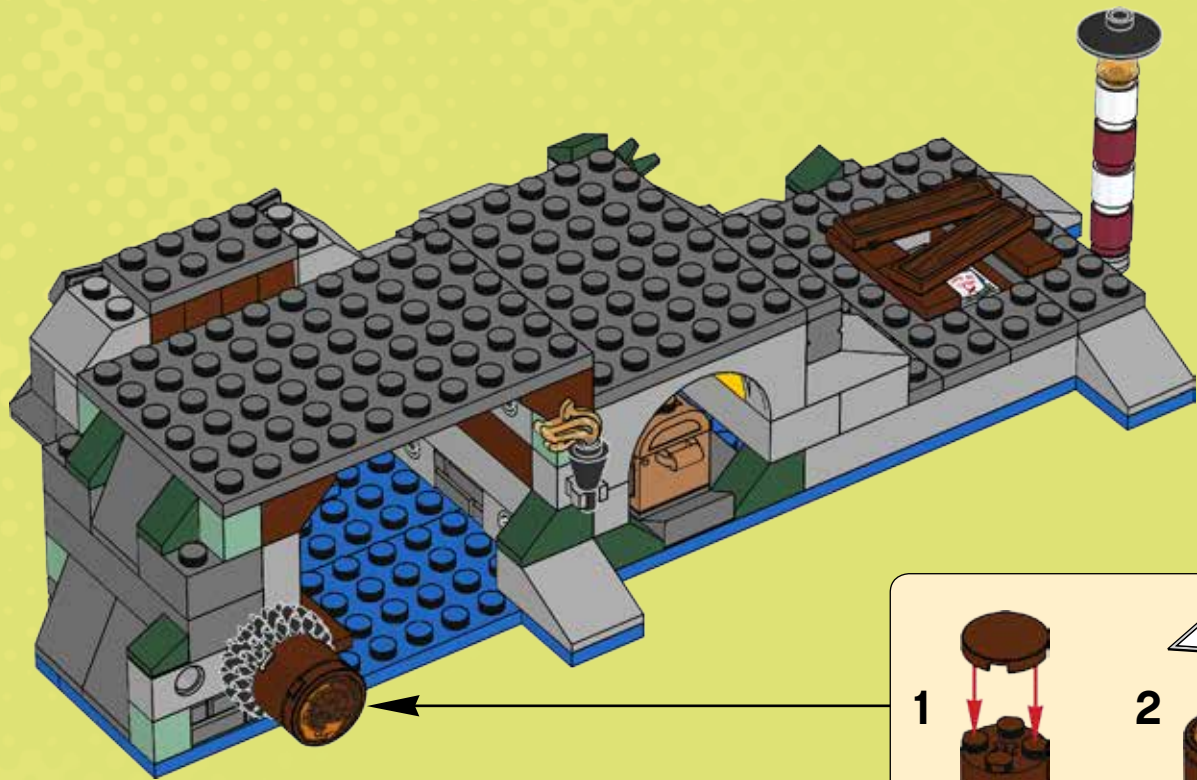

1



2





1x



1x



1x

34

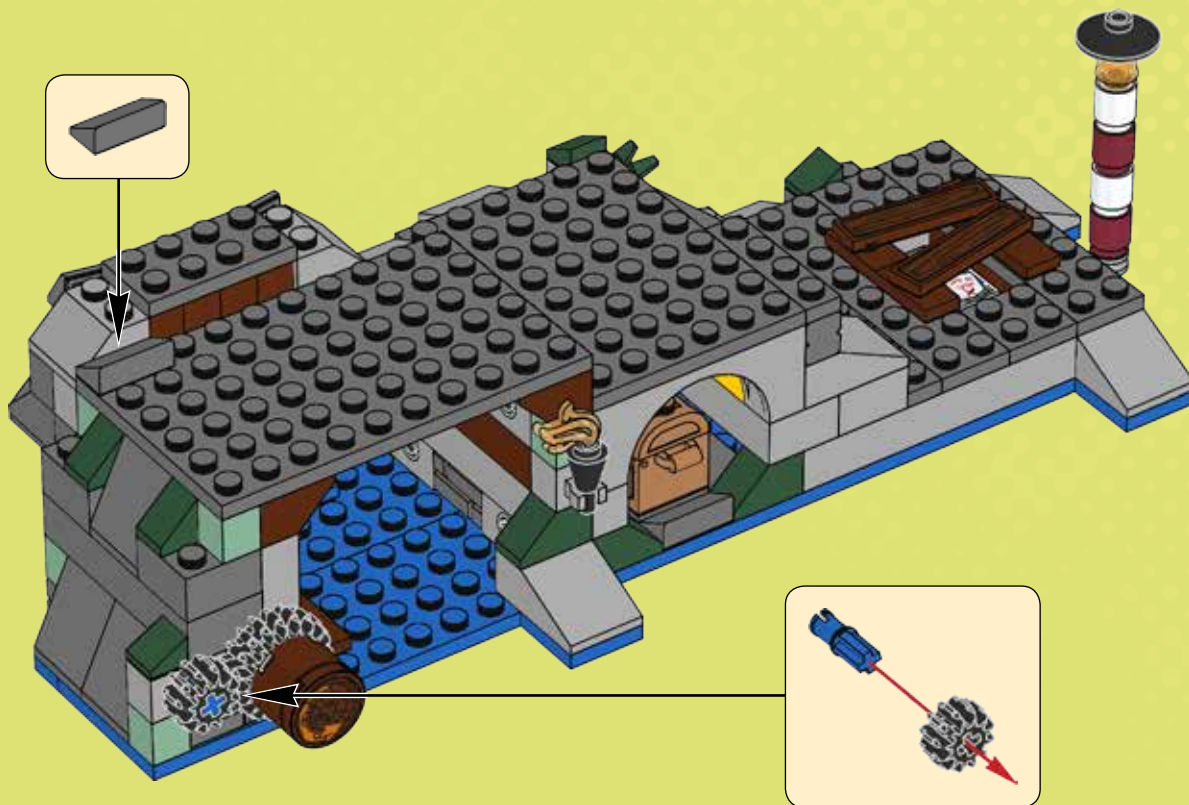

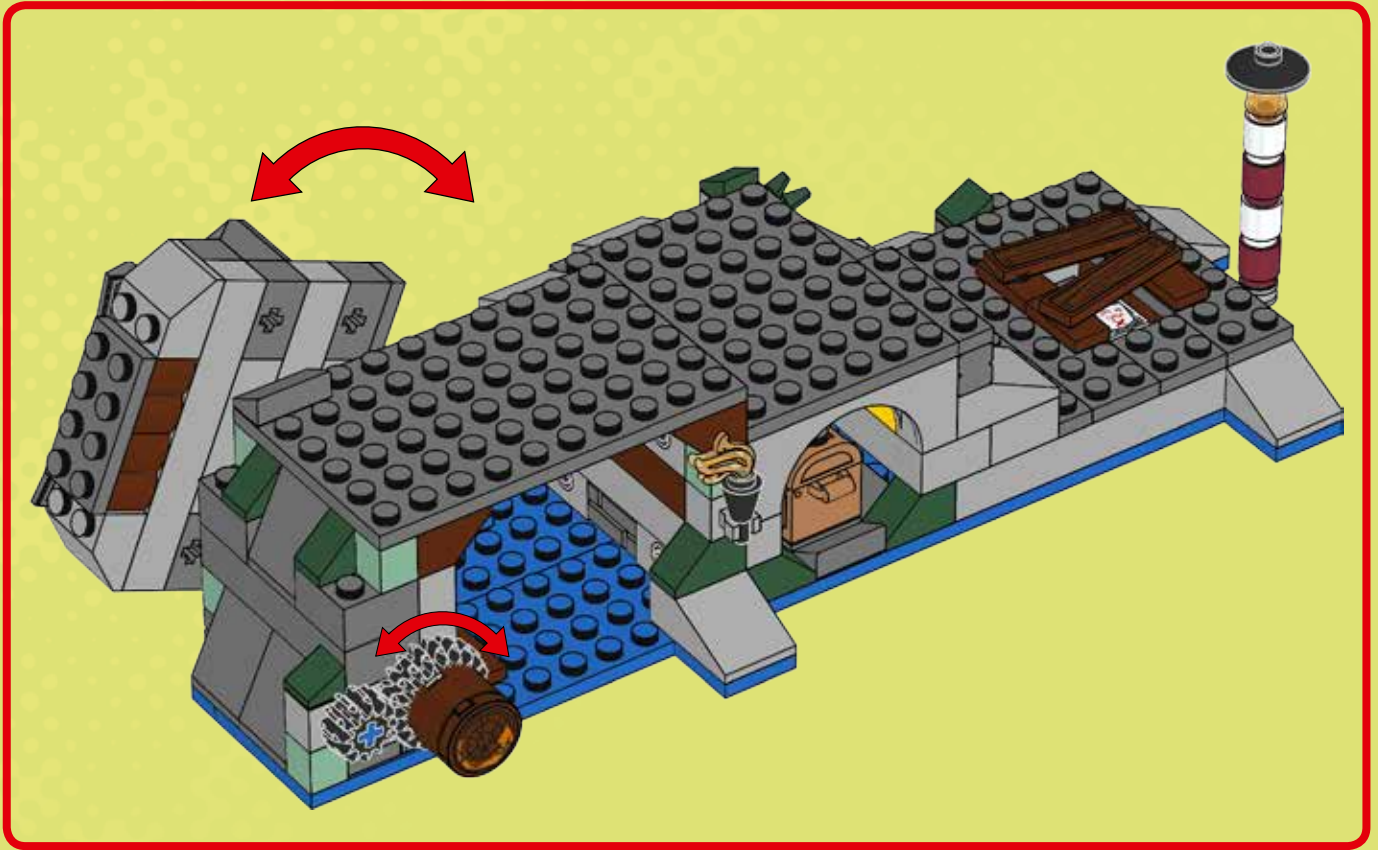

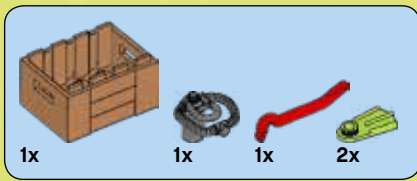

35

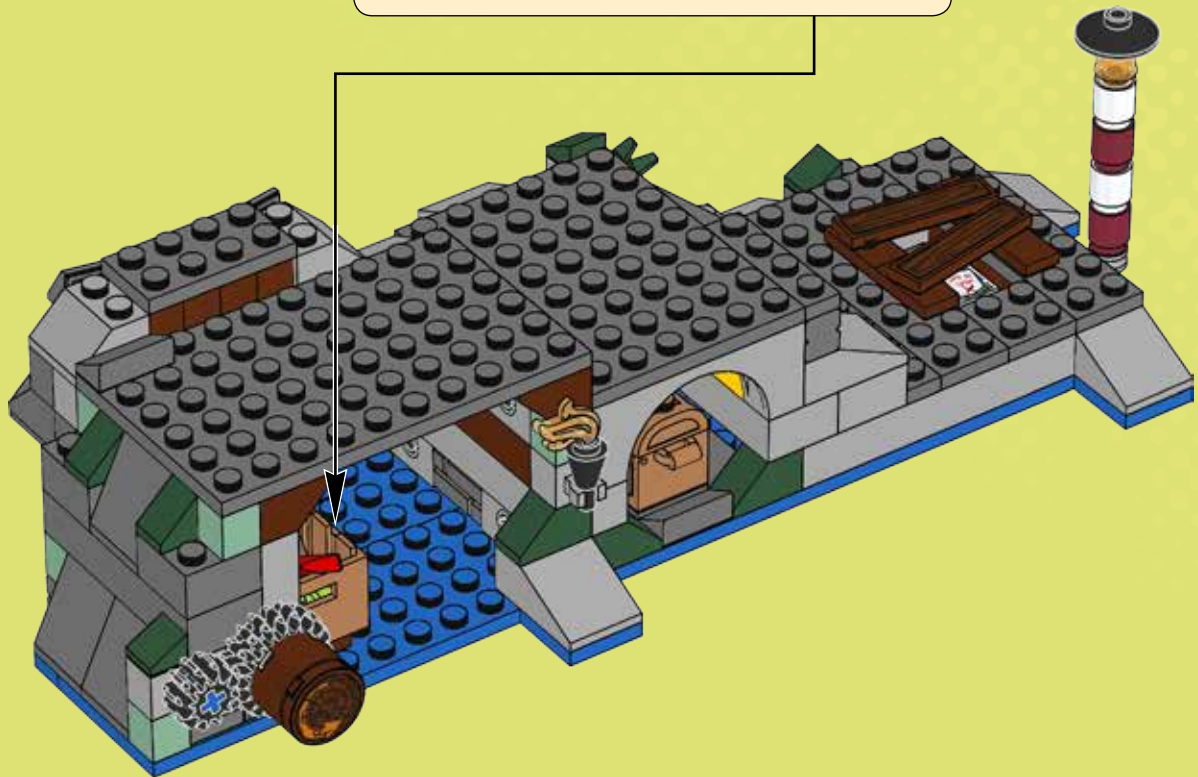
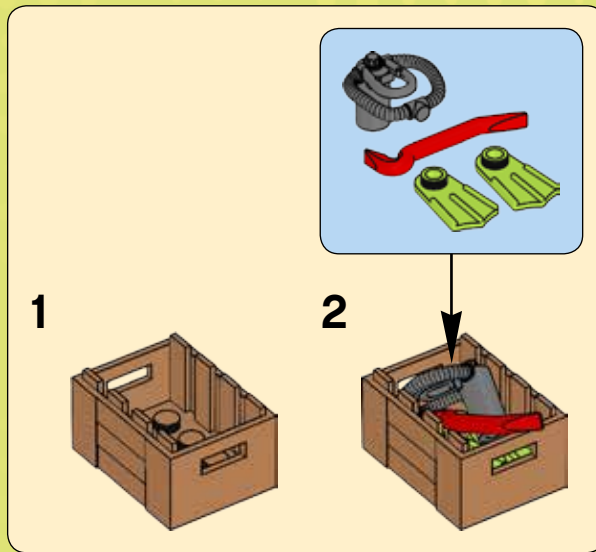



1x



1x

36

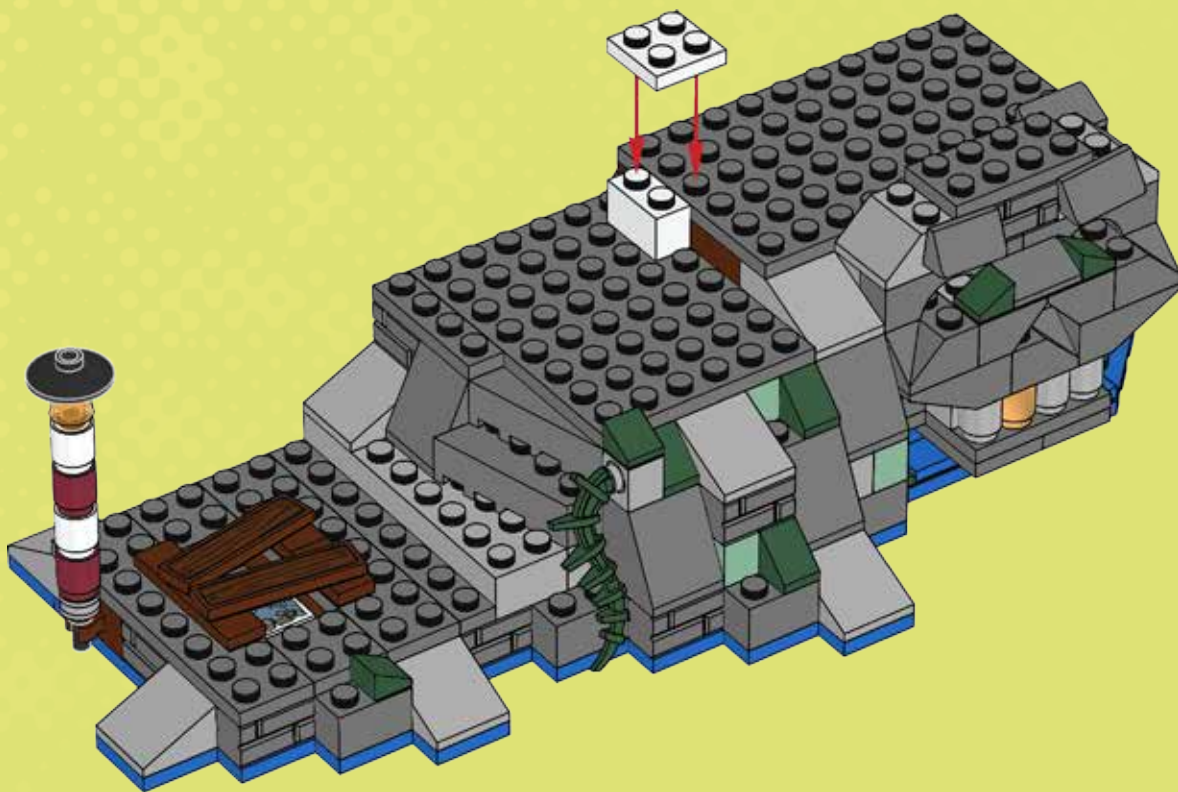
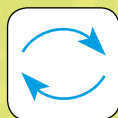



1x



1x

37





1x



2x

38

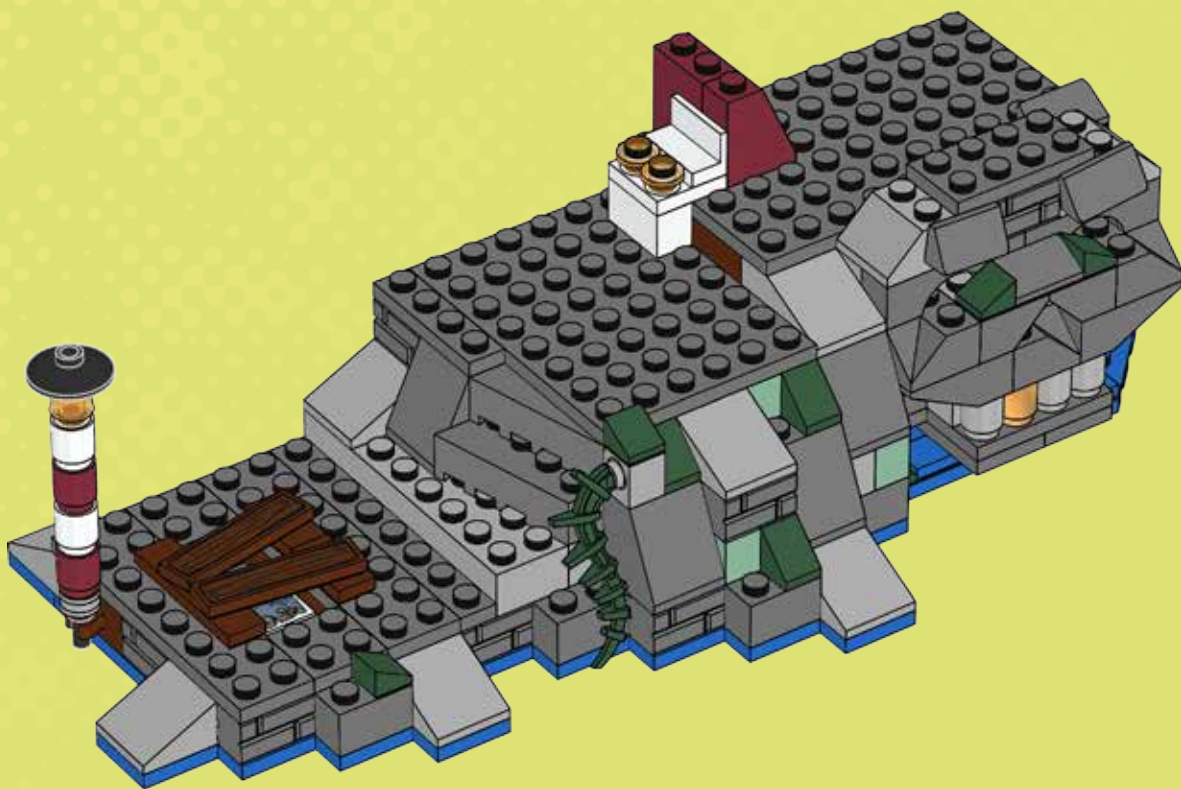

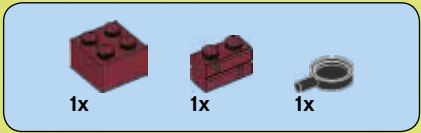

39

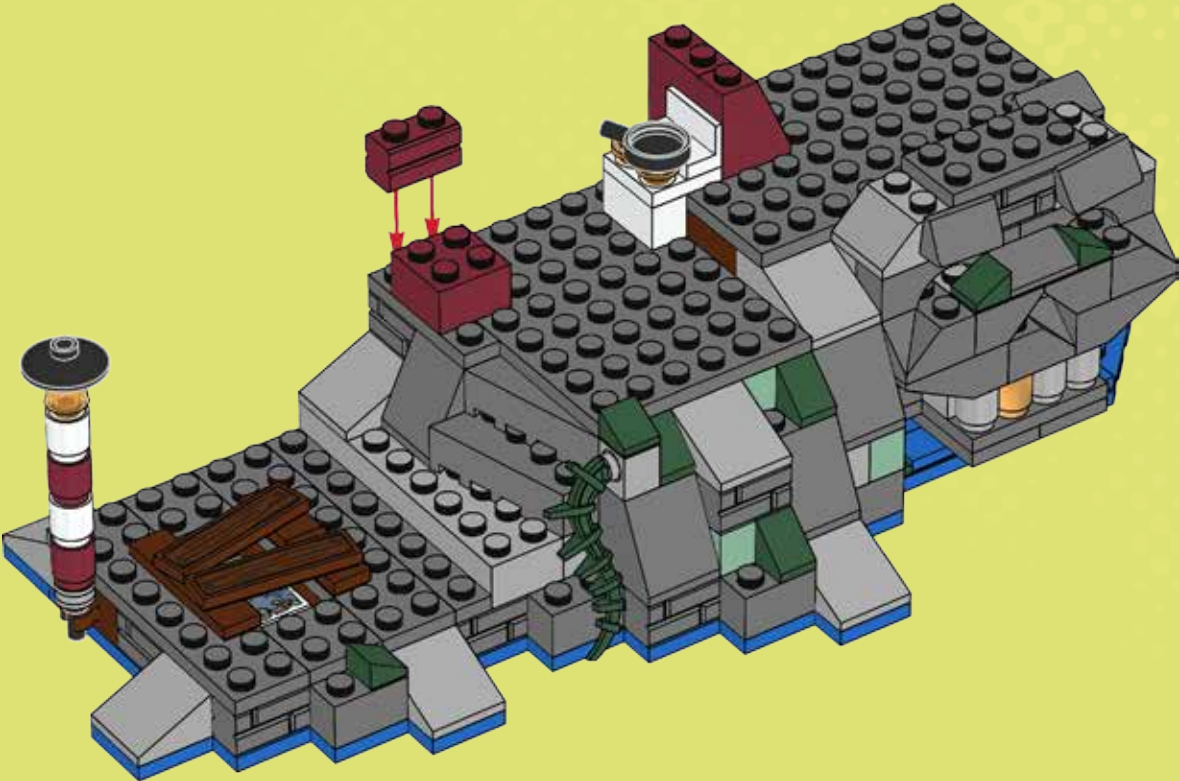

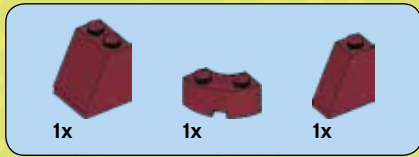

40

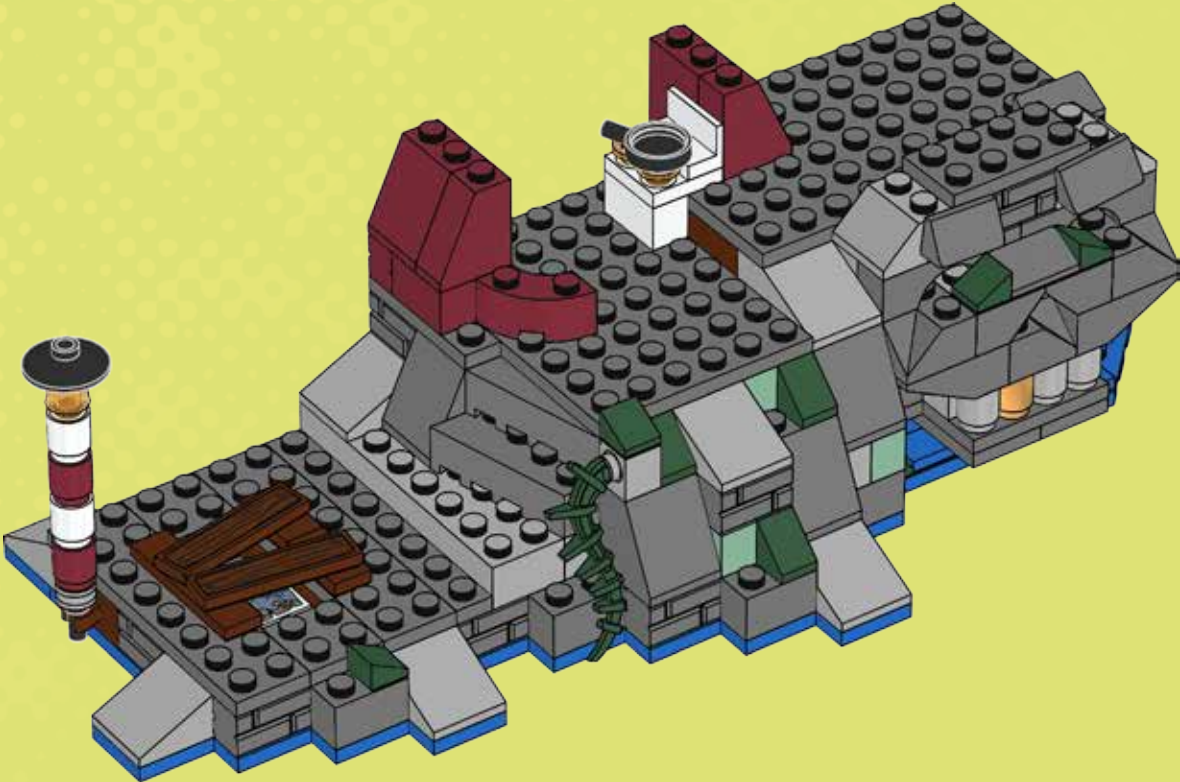



2x

41

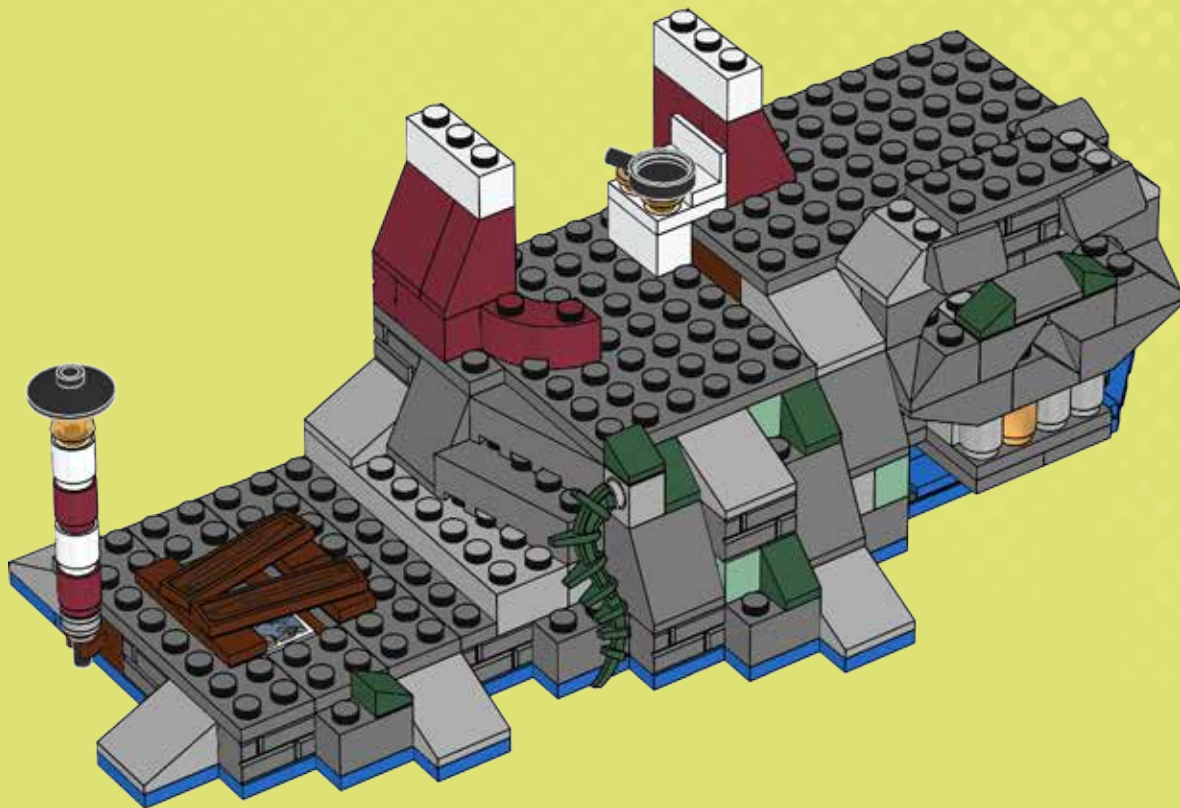



1x



1x



1x

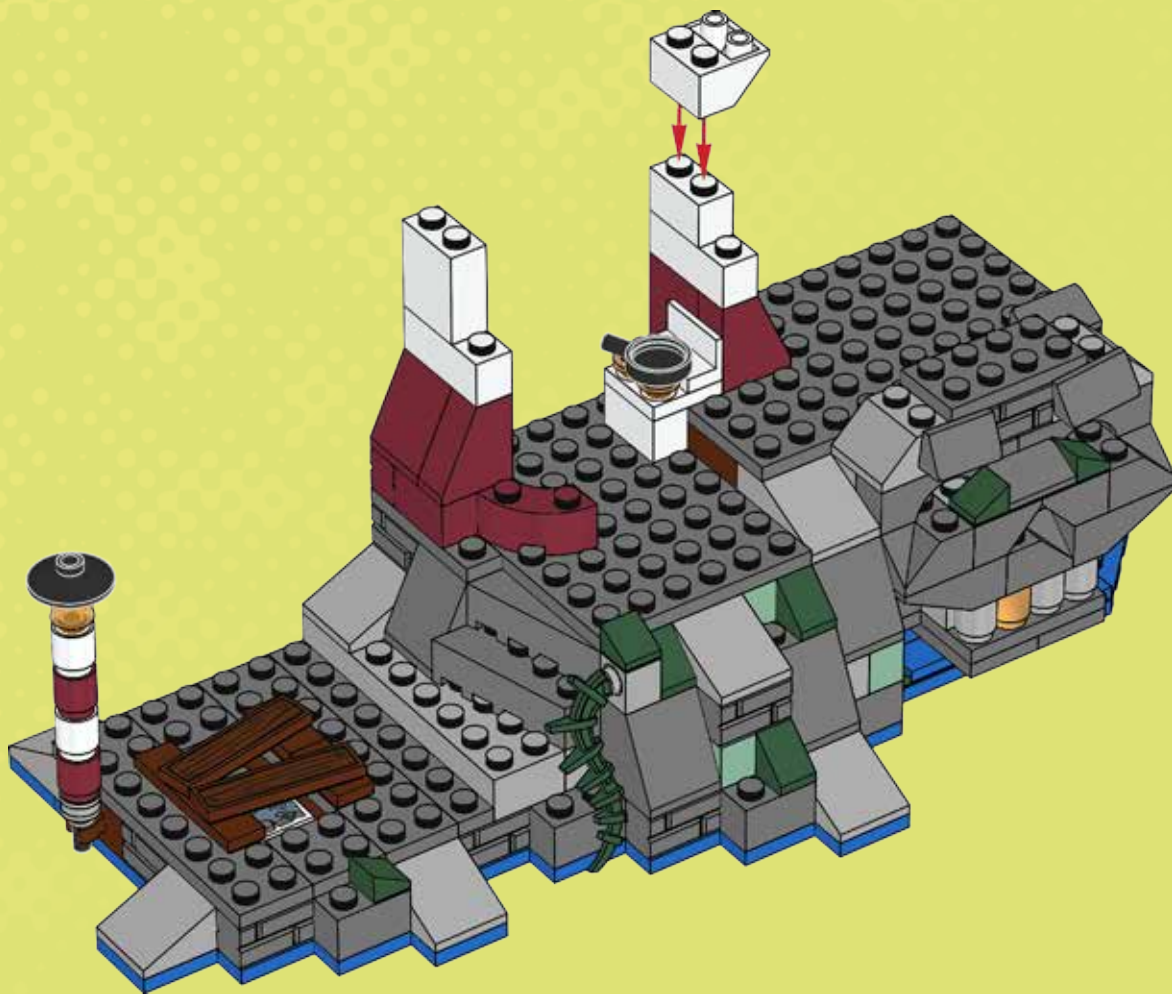

42

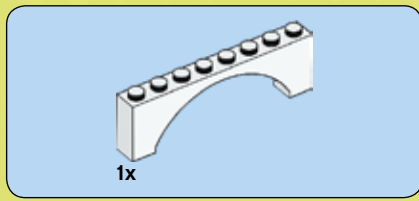

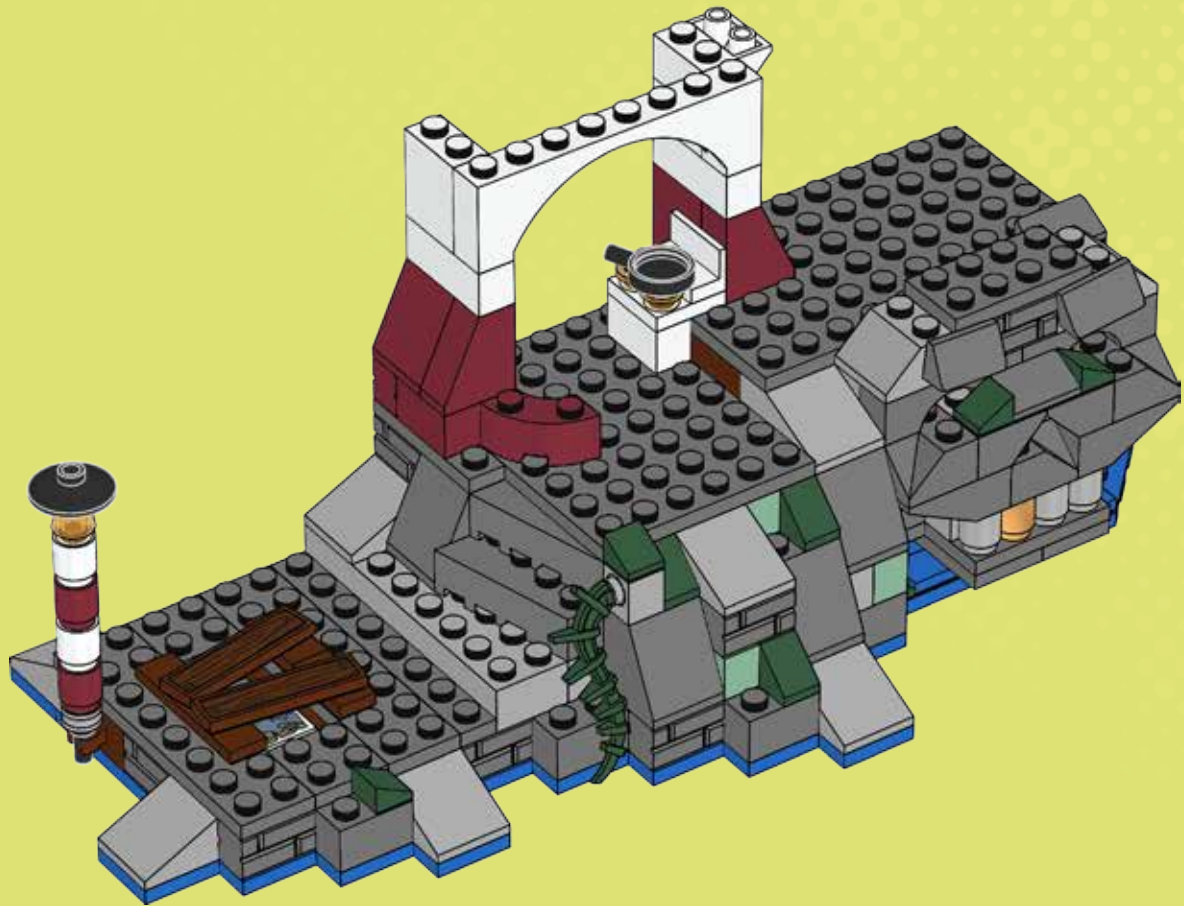

43



6x  4x 

44

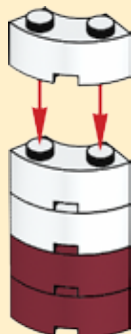
2x

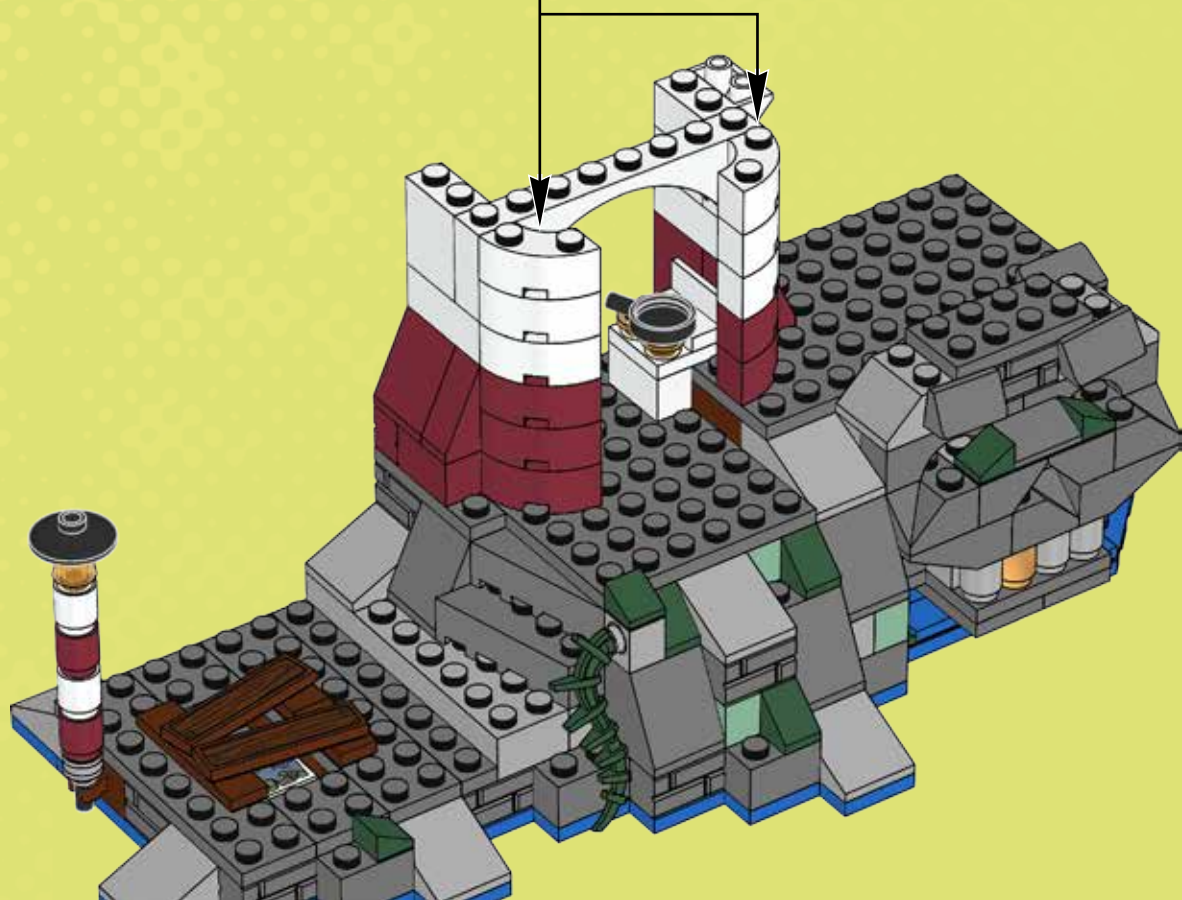

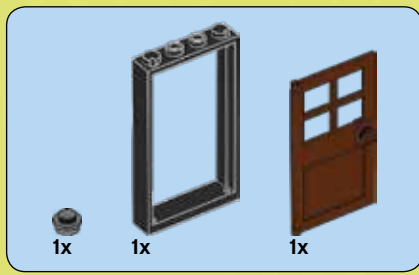

45

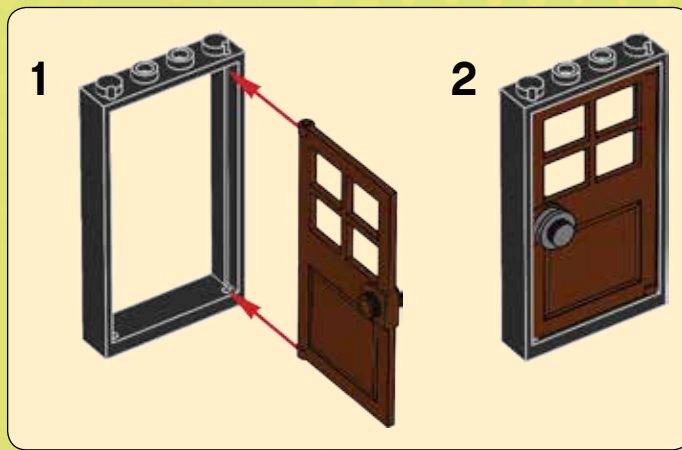



1x

46

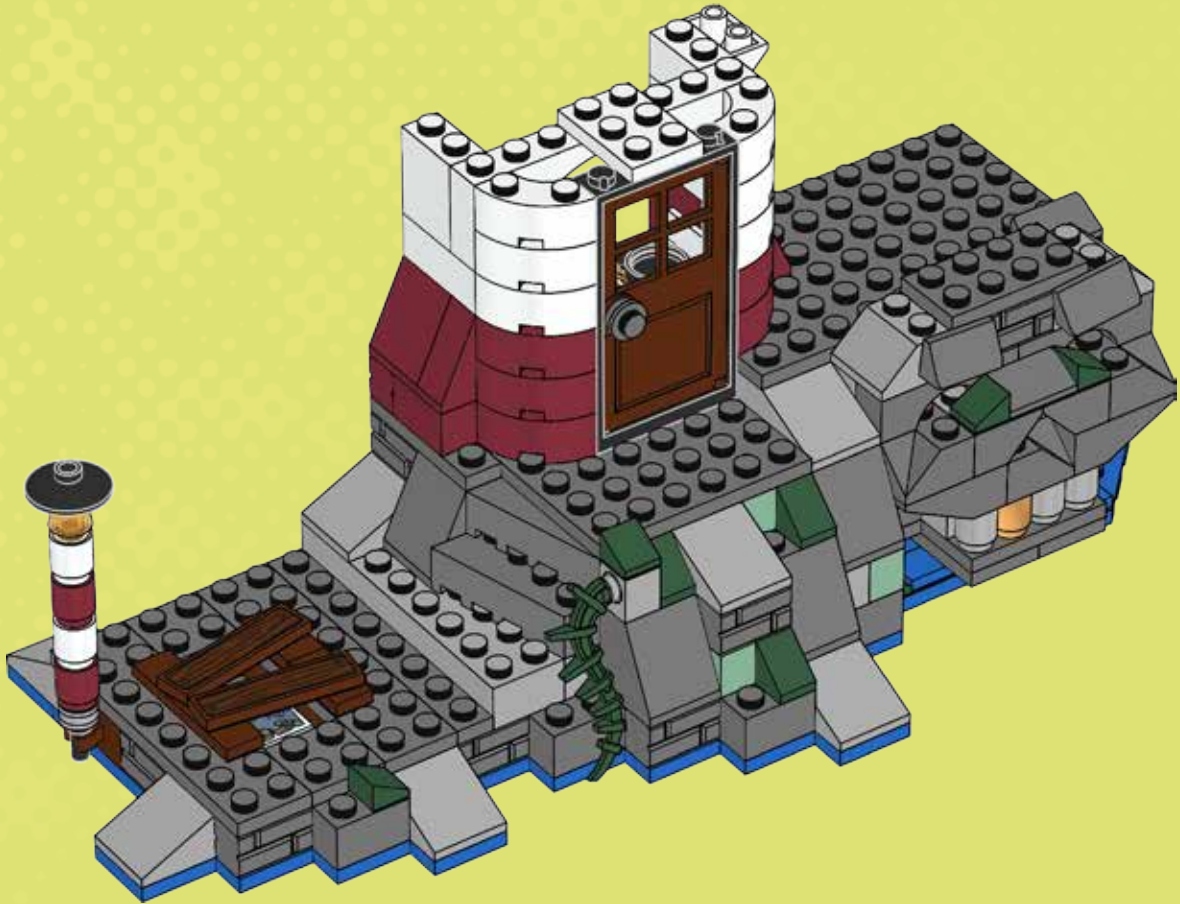



2x

47

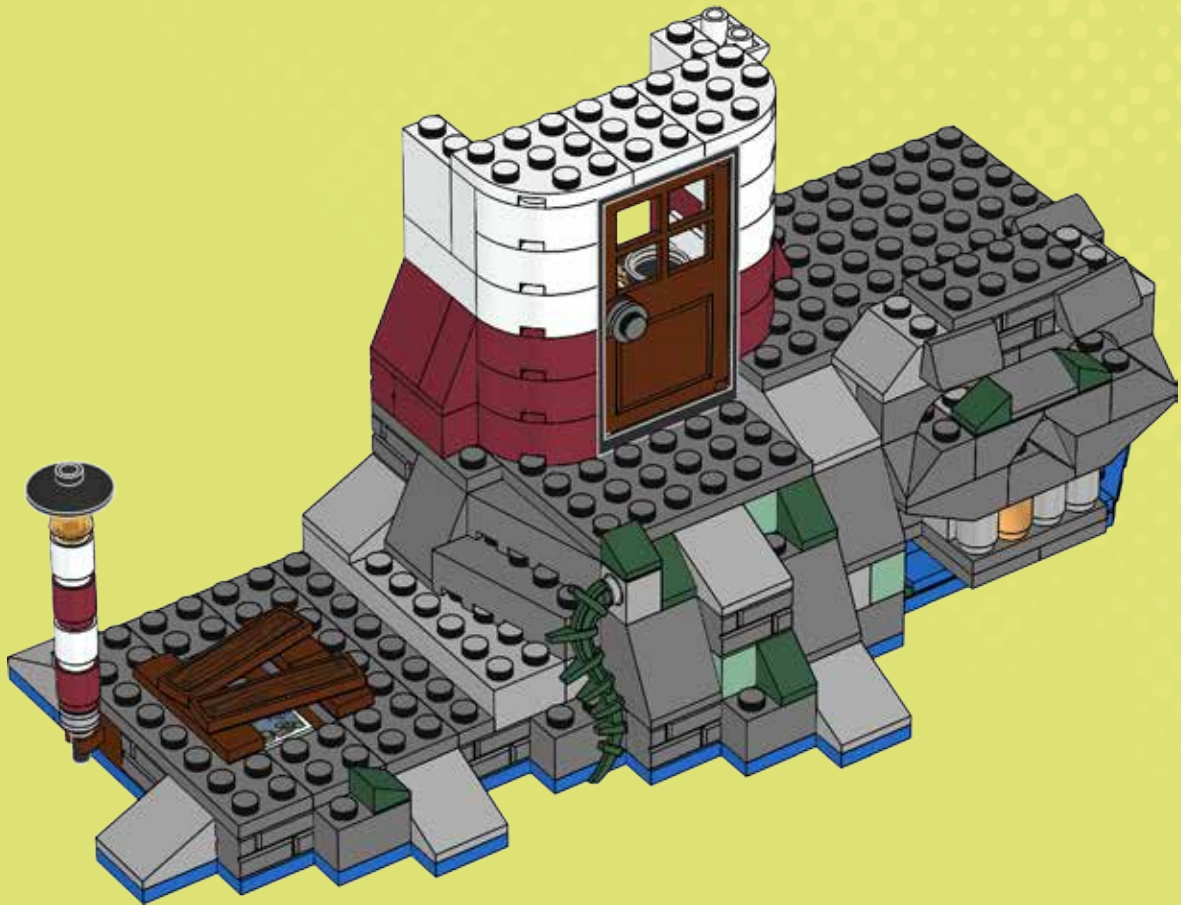

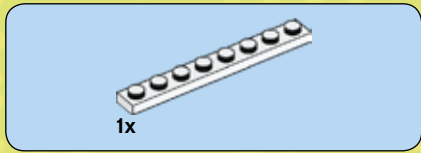

48

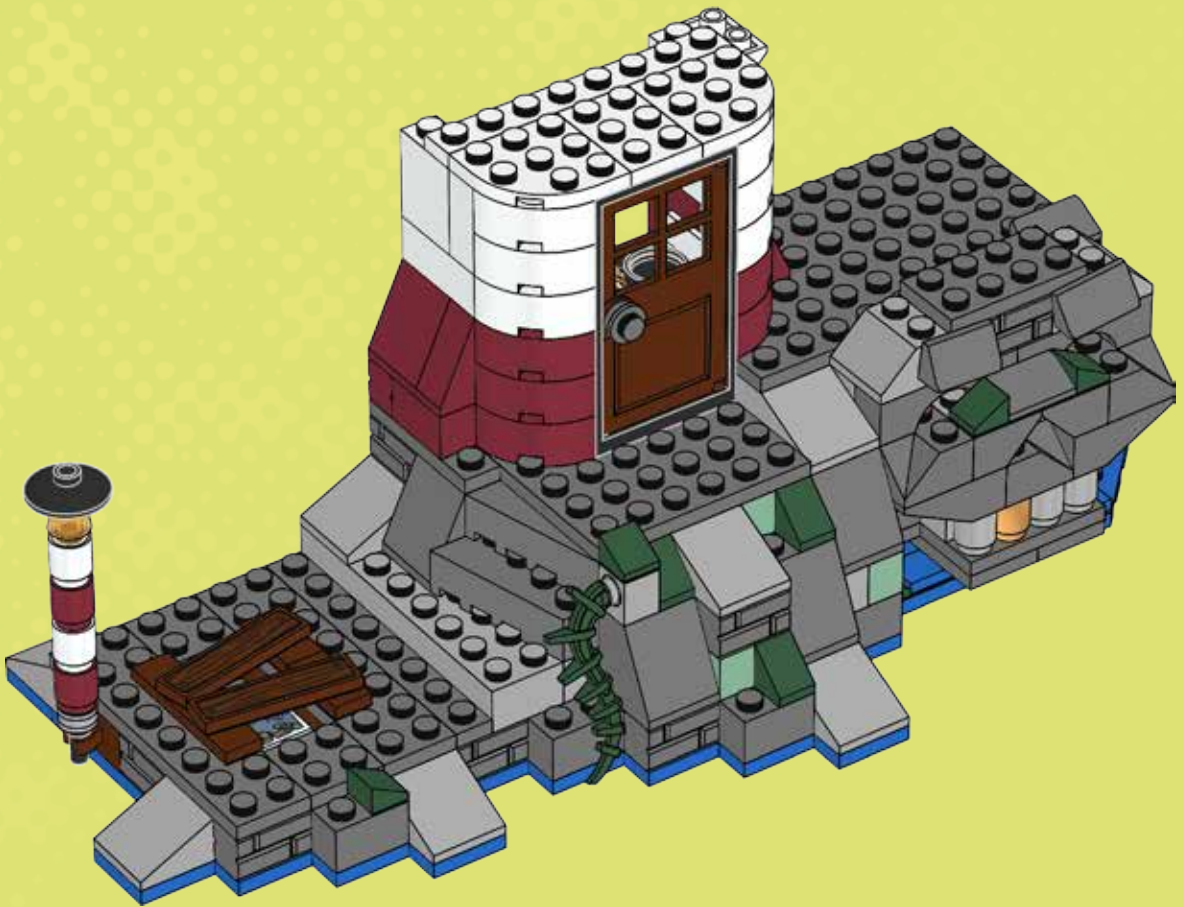



1x



1x



1x

49

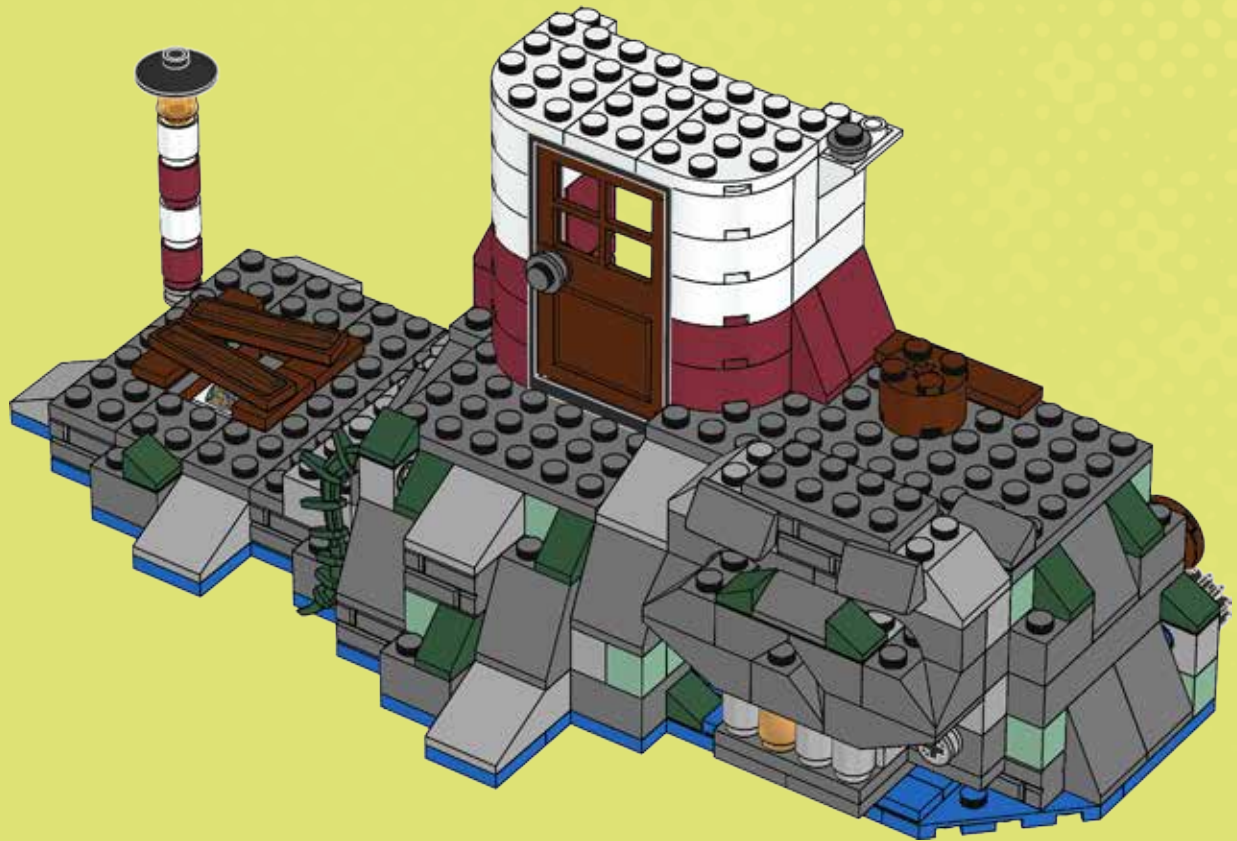

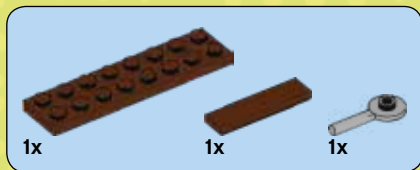

50

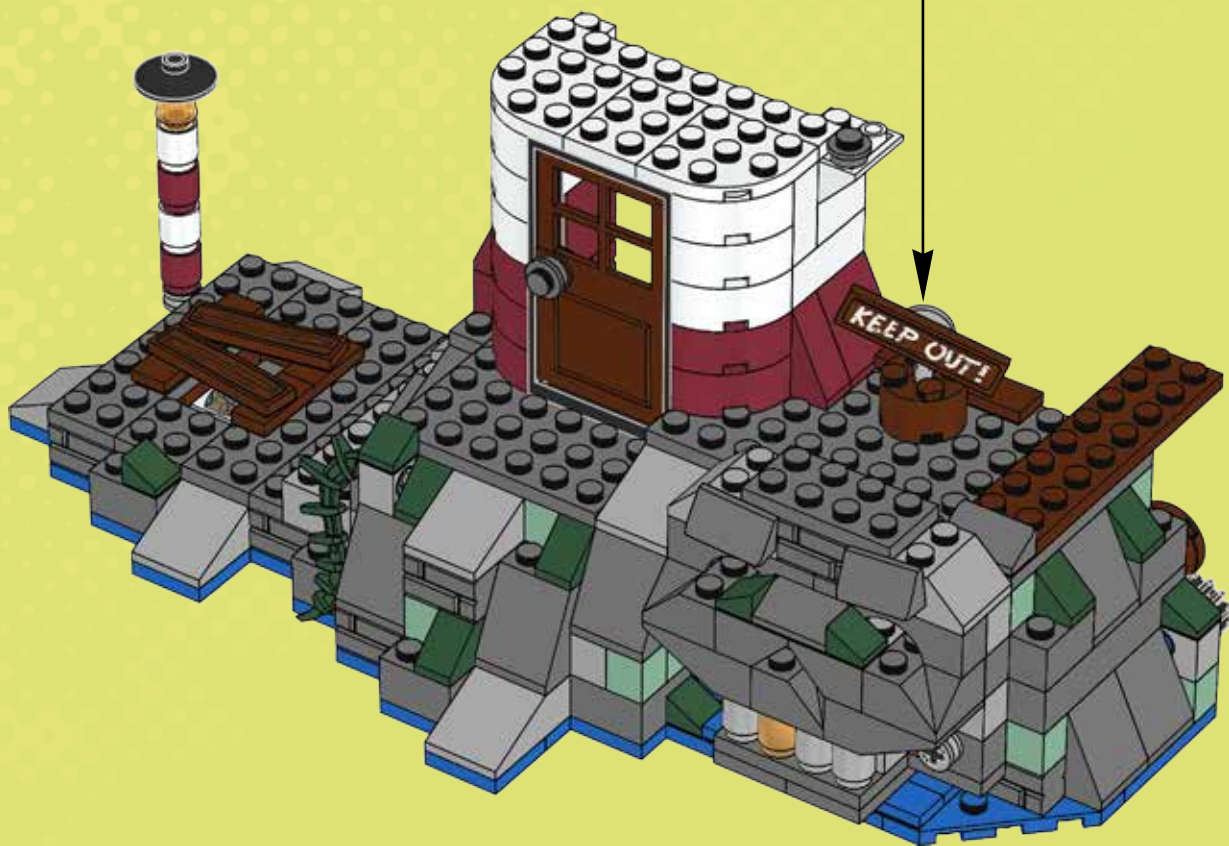
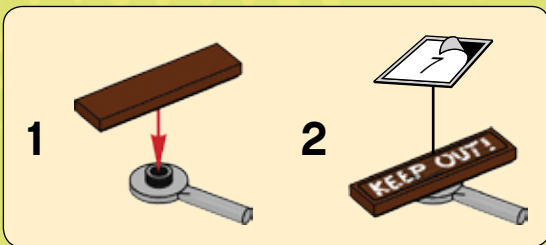

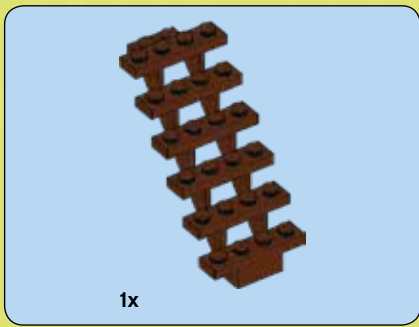

51

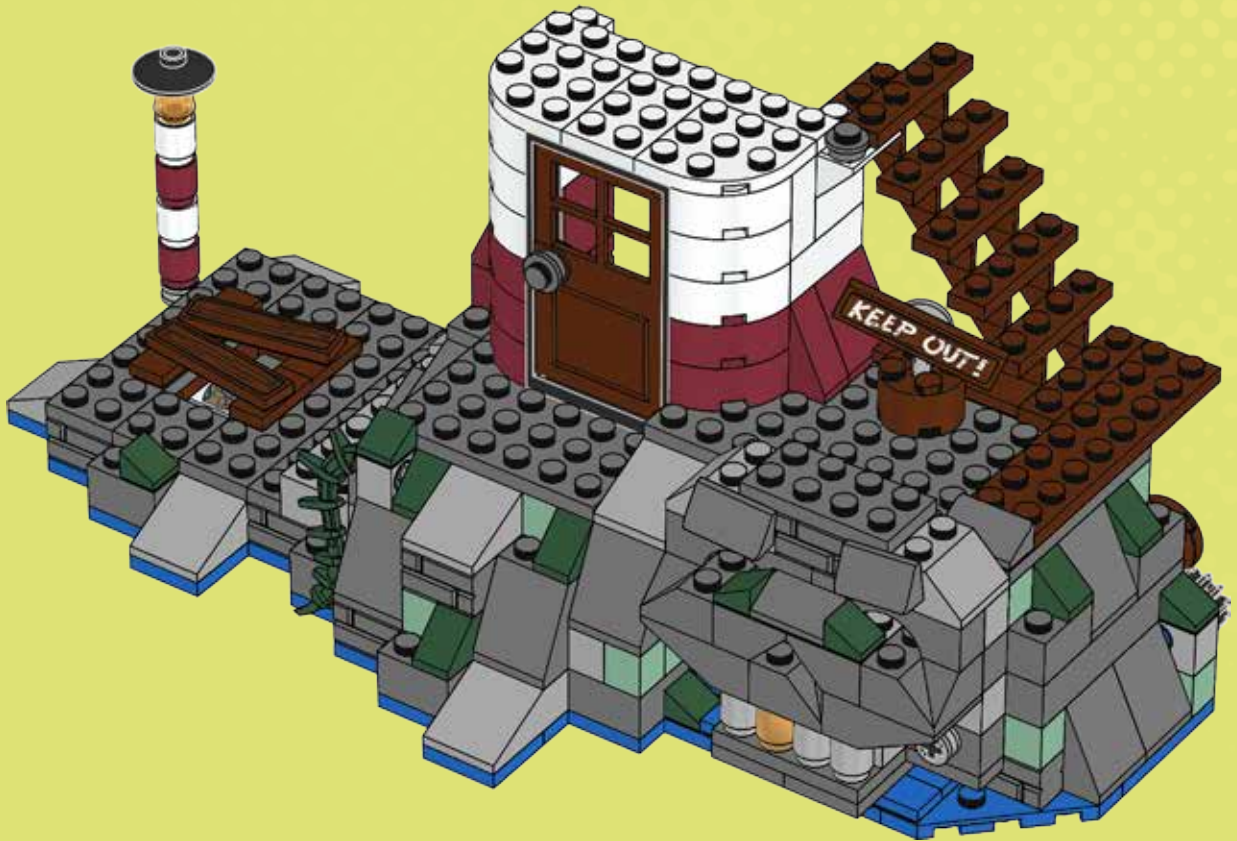

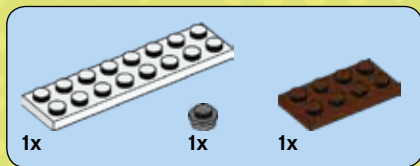

52

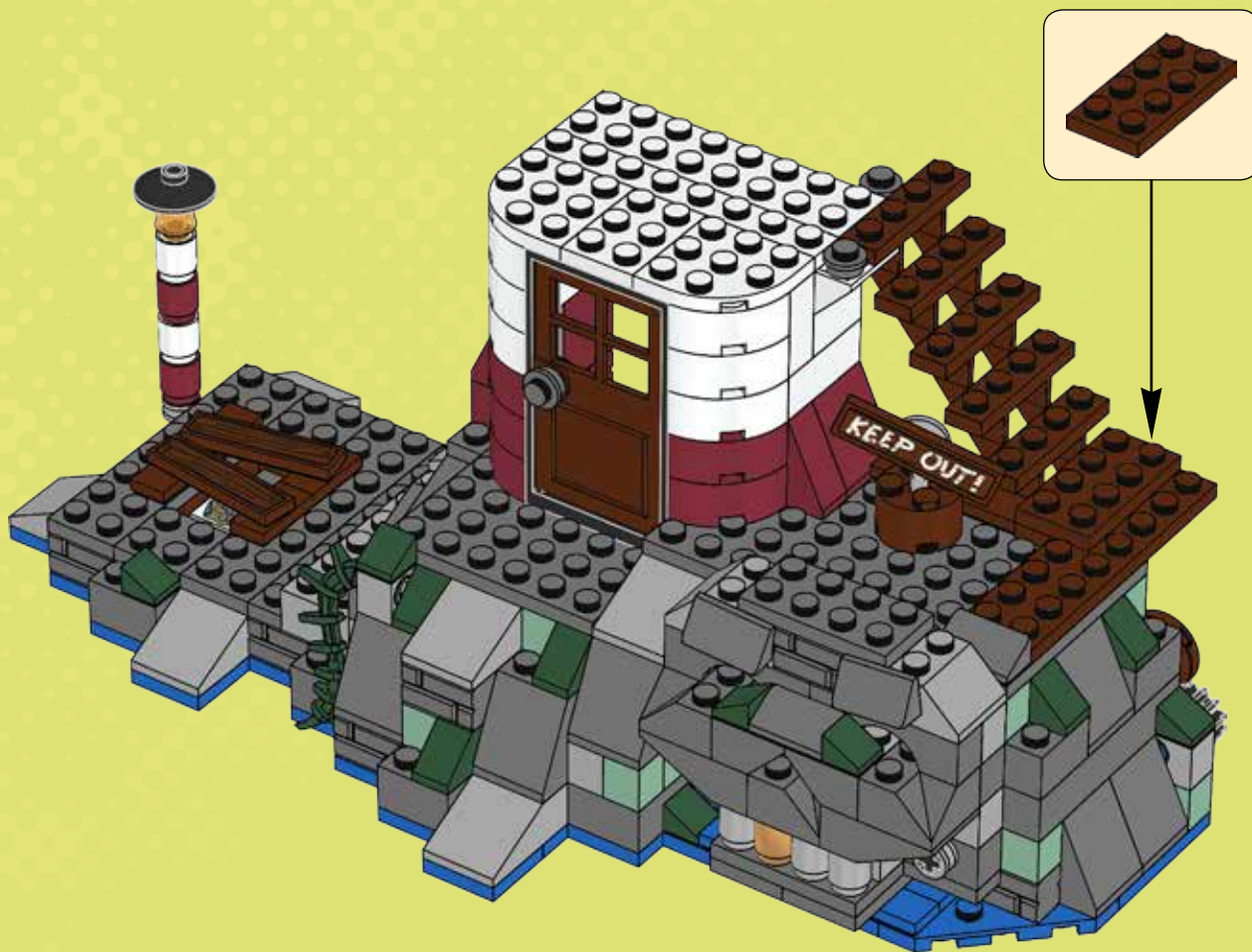

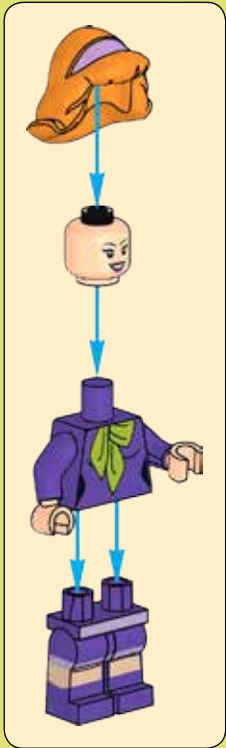
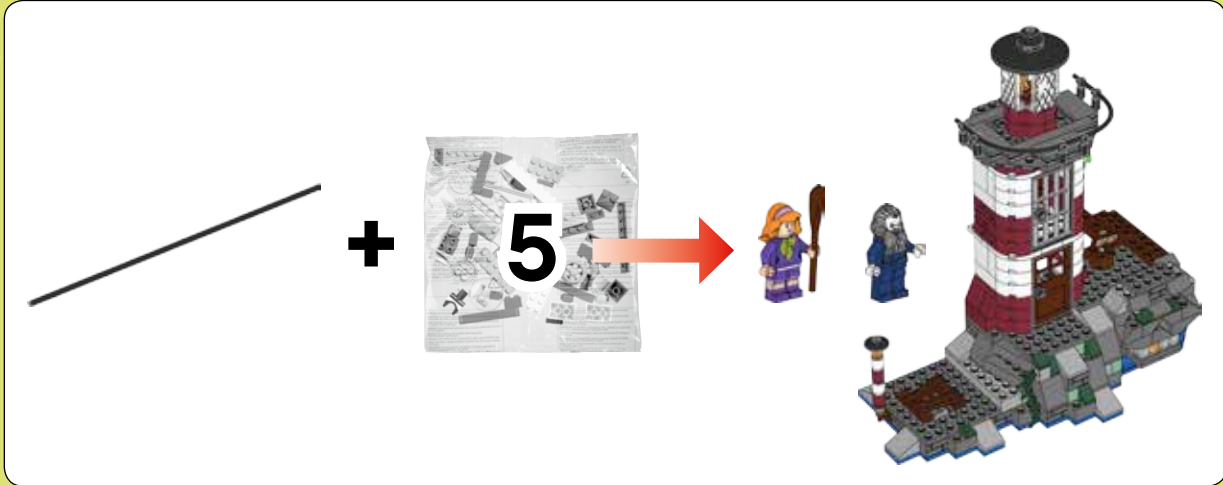



1x

53

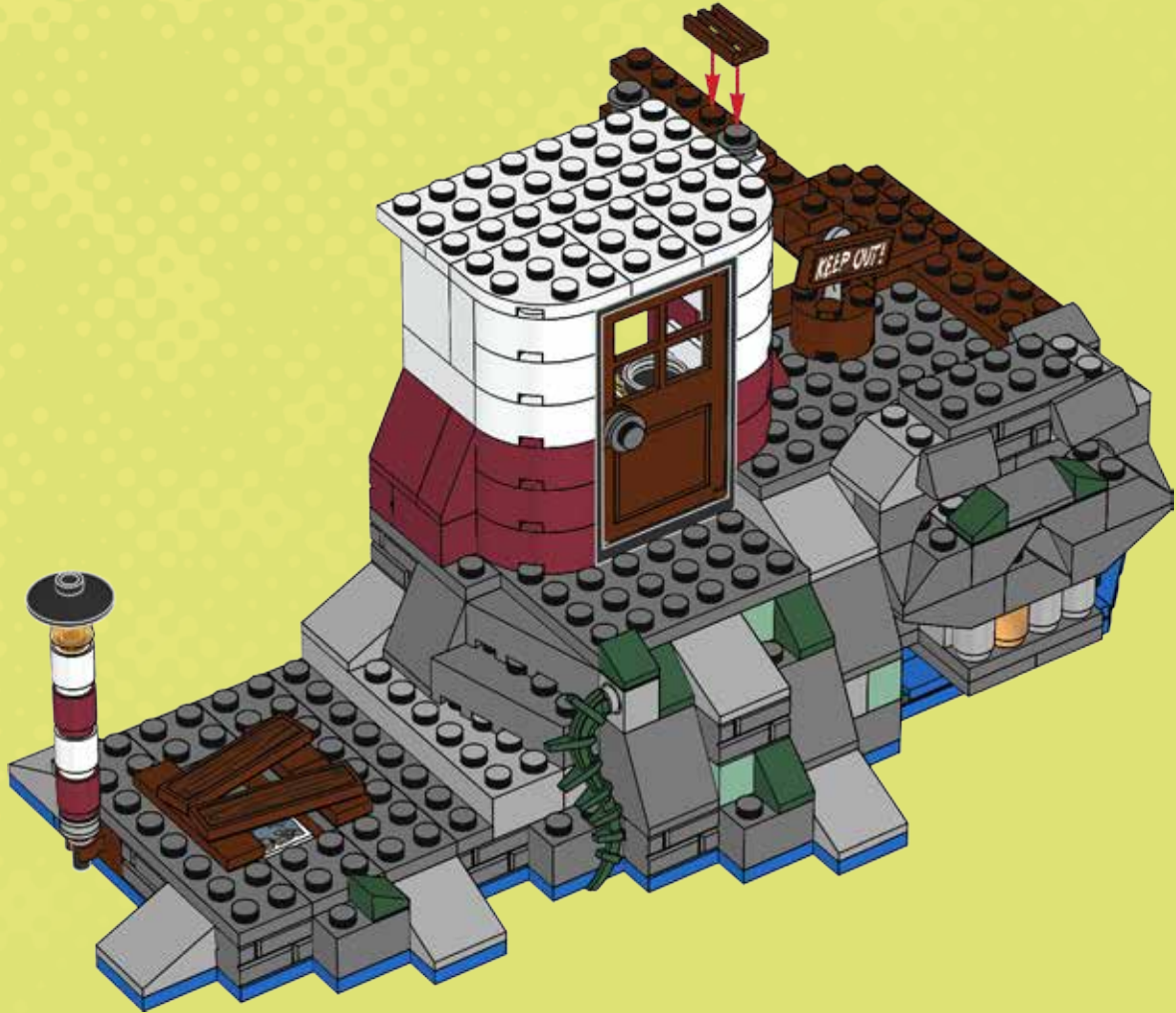



2x



2x



2x

54

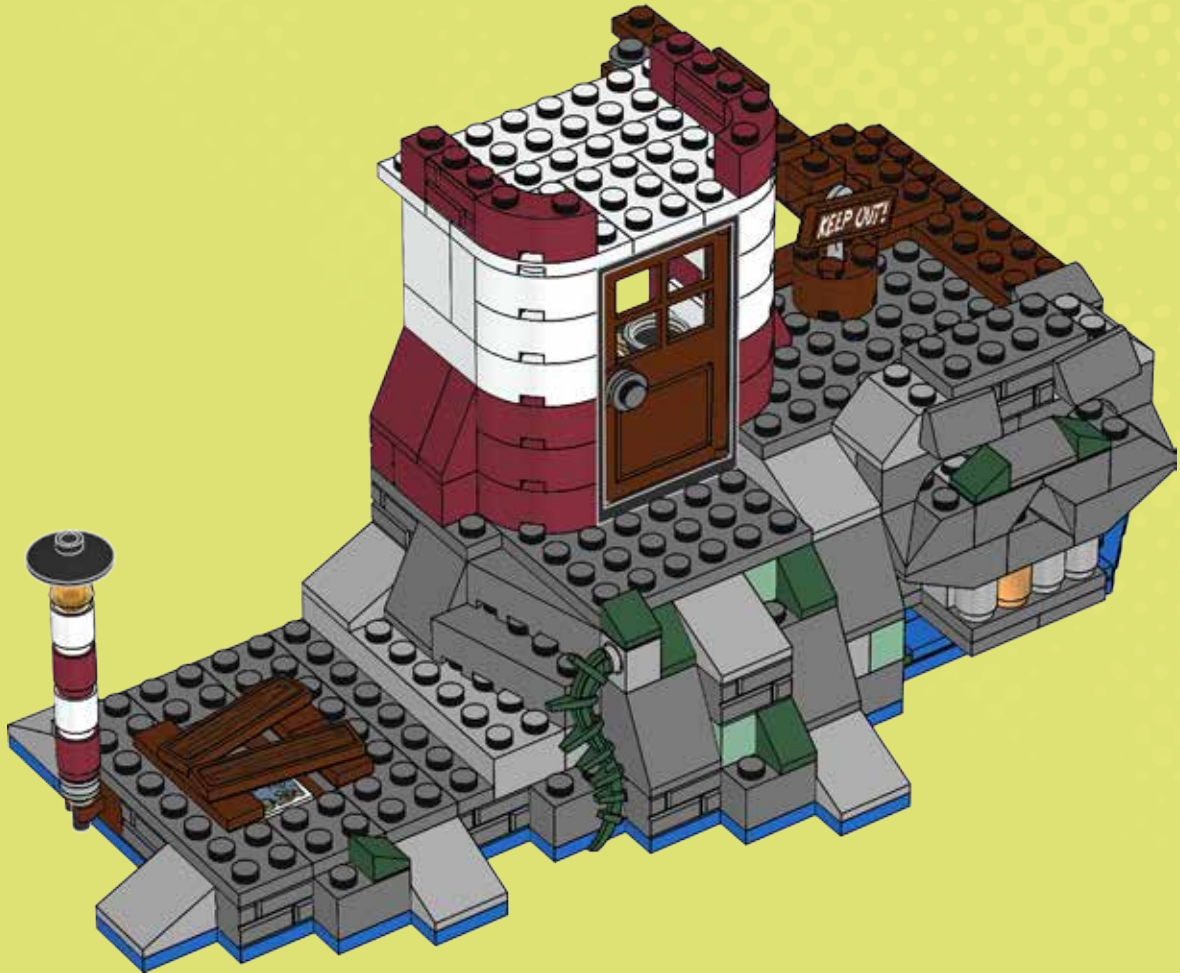



2x



2x



2x

55

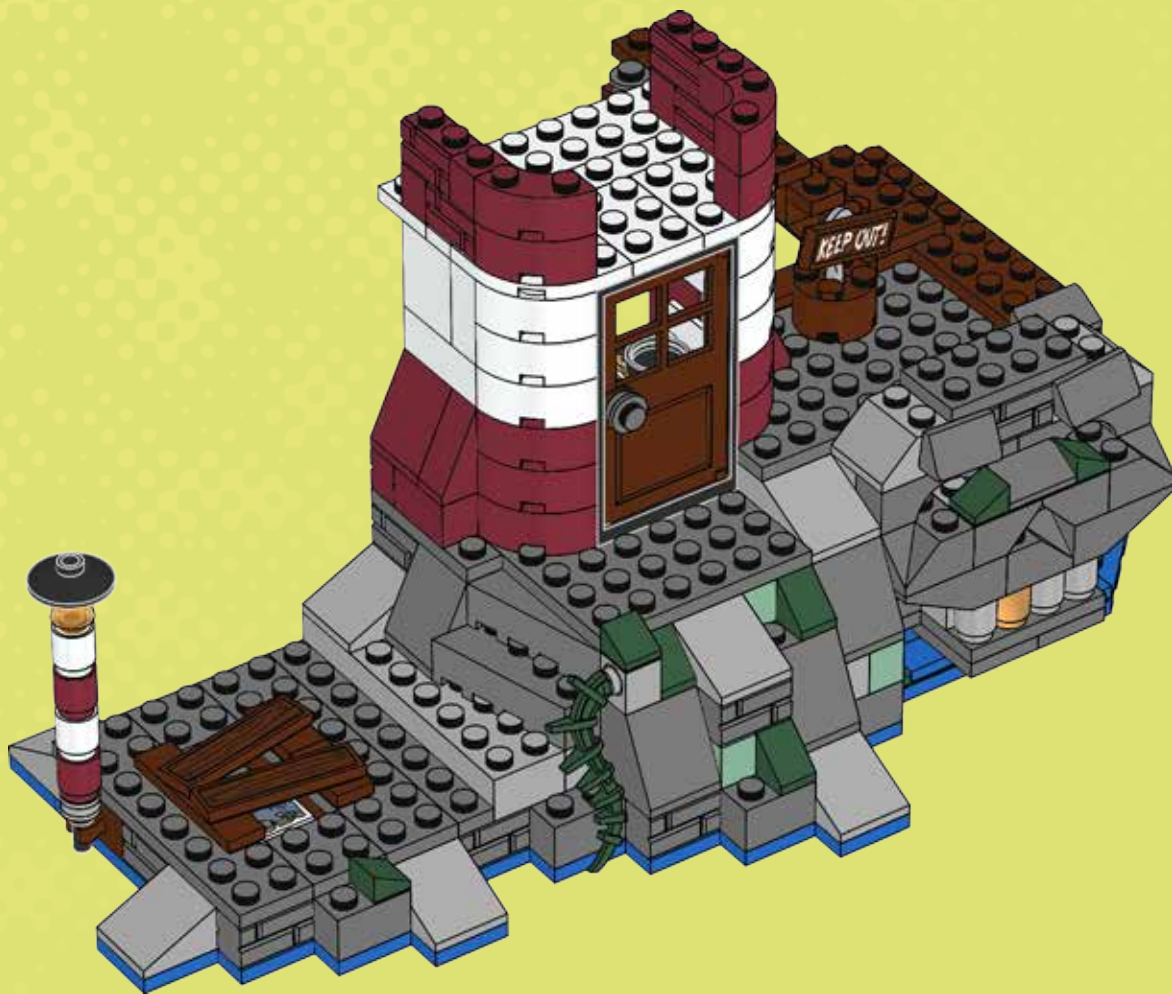

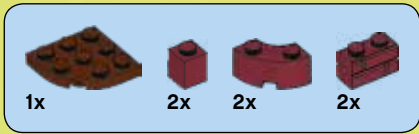

56





2x

57

1

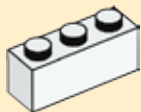

2

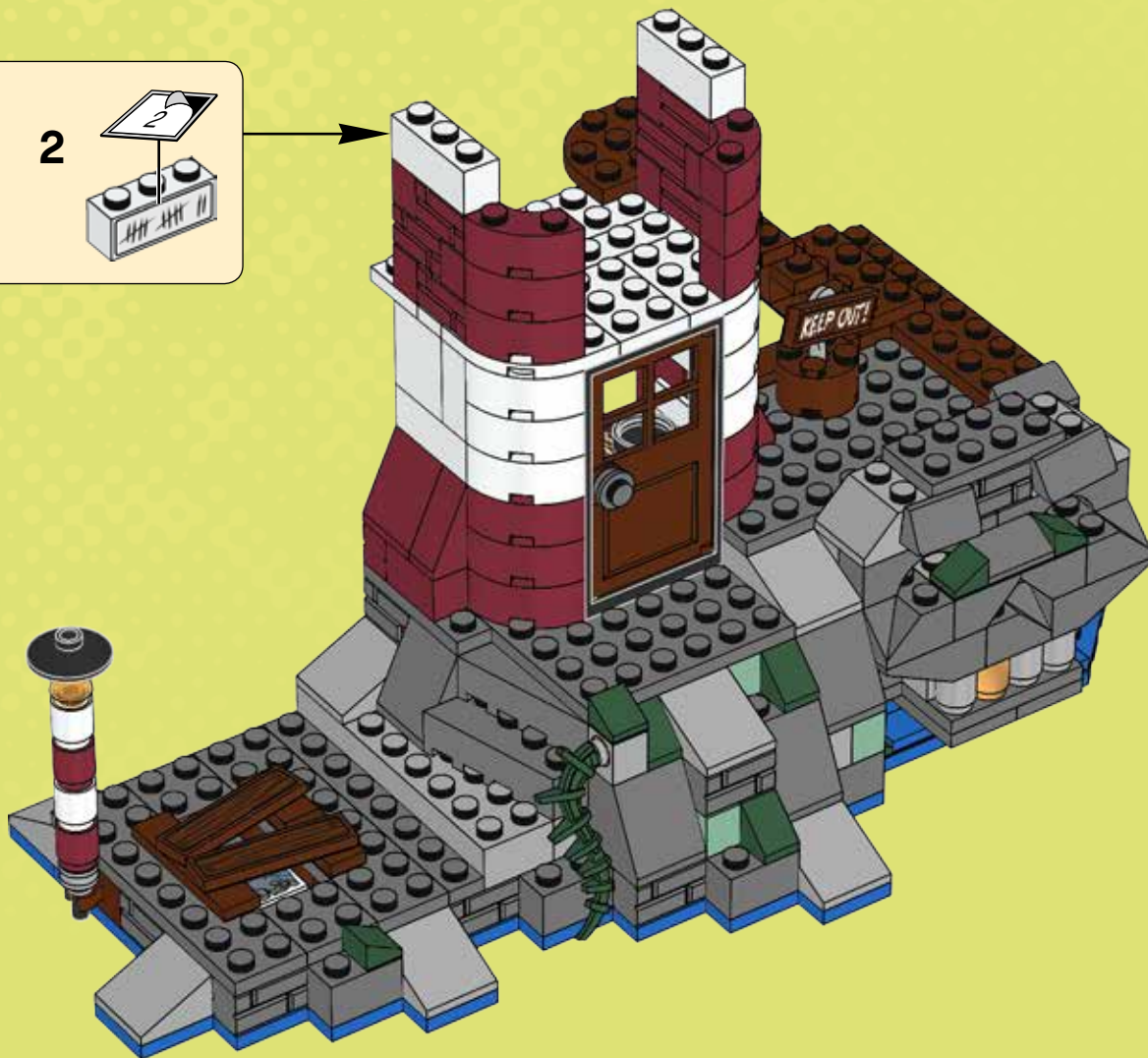
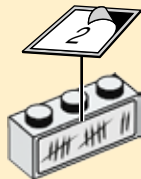

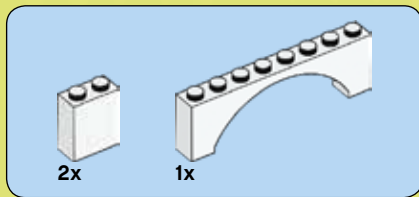

58





6x

59

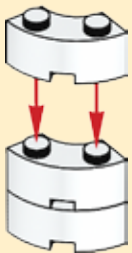

2x



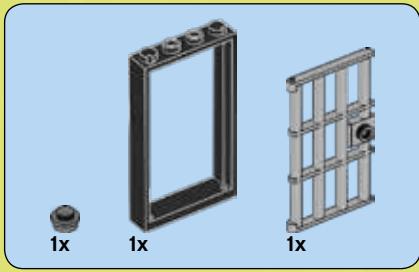

60

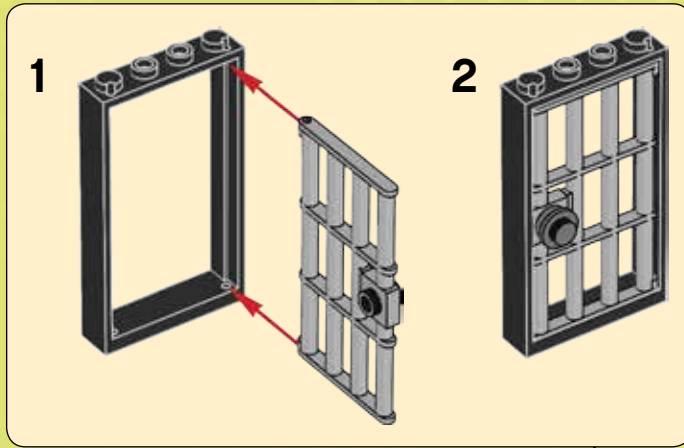



1x

61



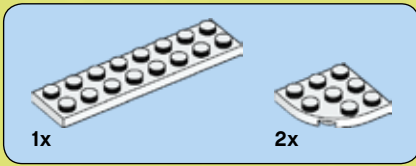

62





2x



2x

63



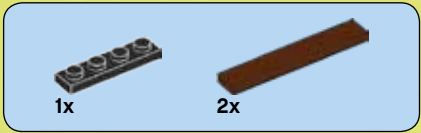

64





2x

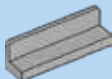

2x

65





2x



2x

66





2x



1x

67



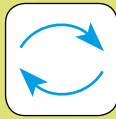
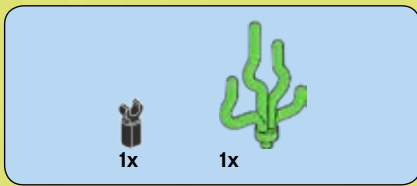

68

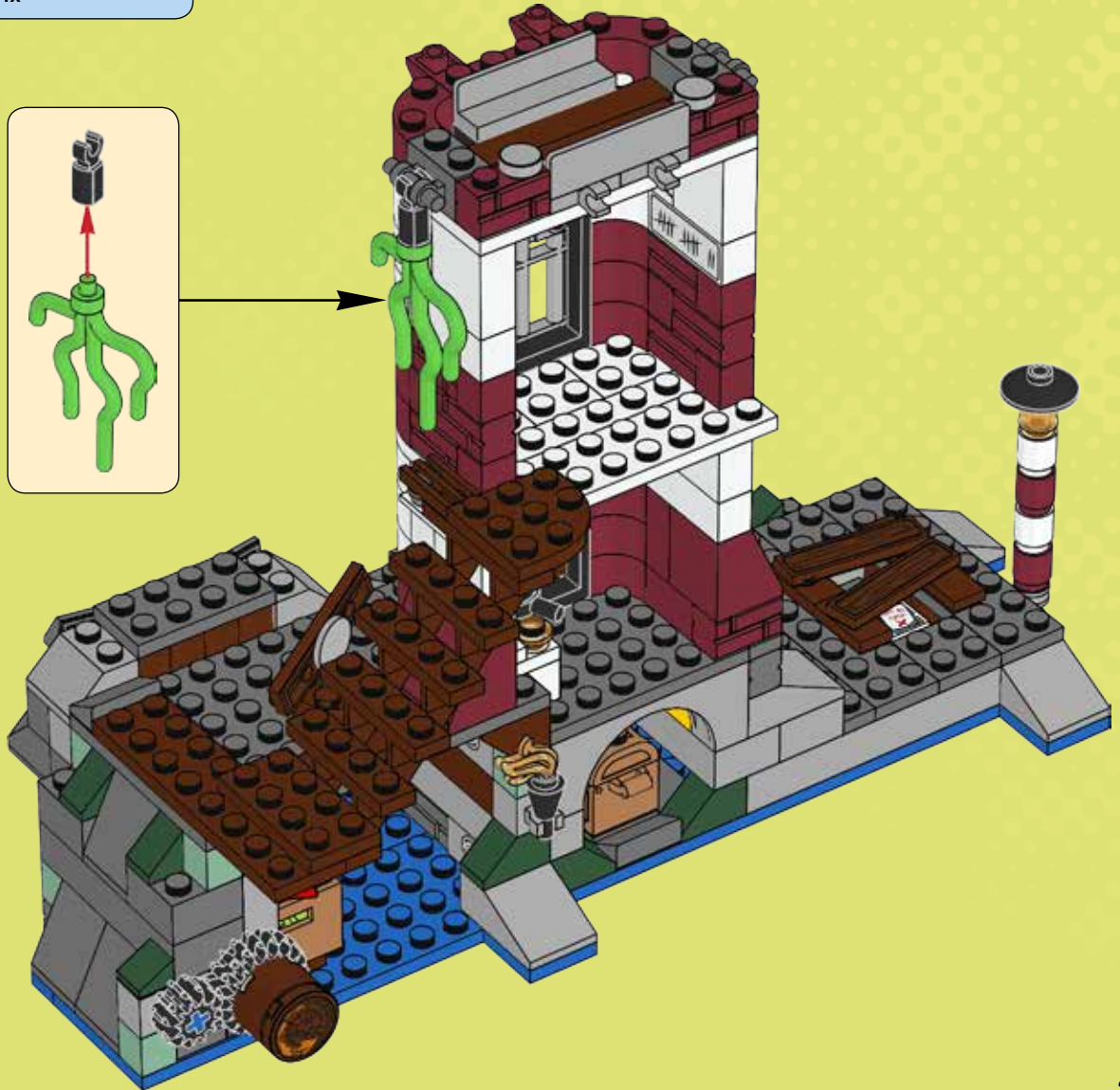
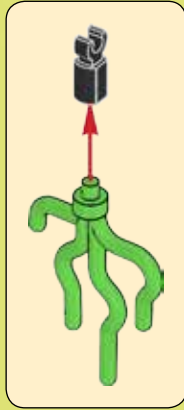

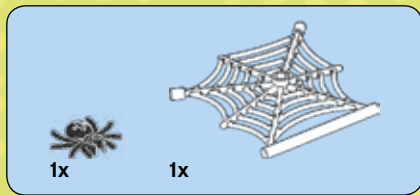

69

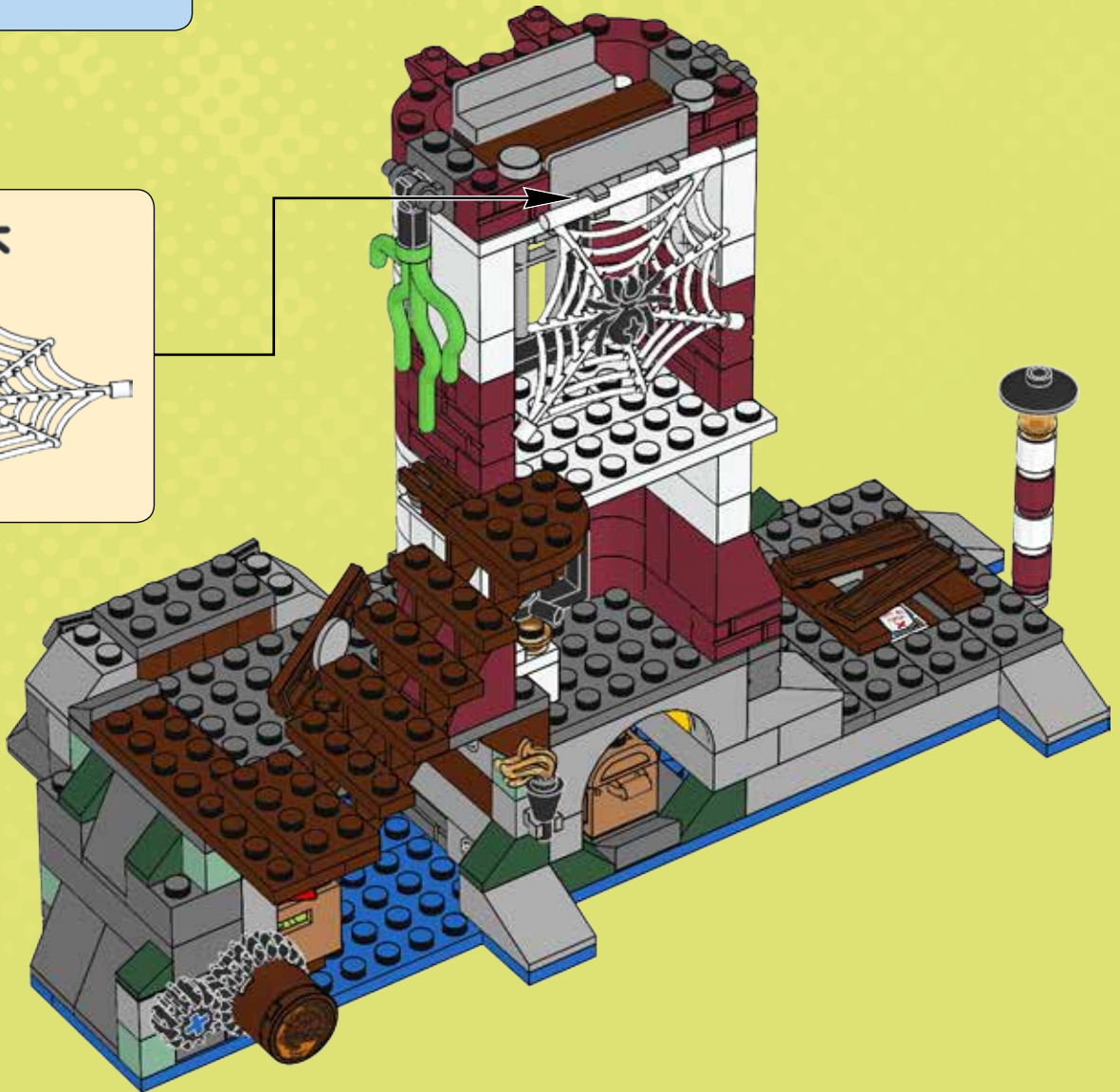
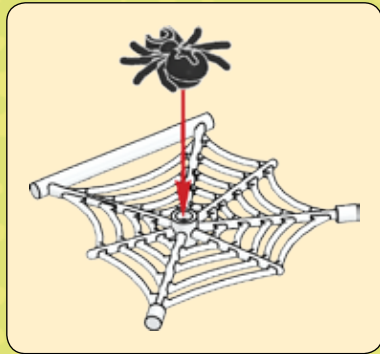

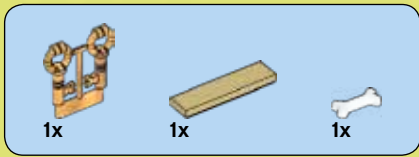

70

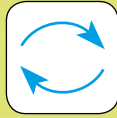

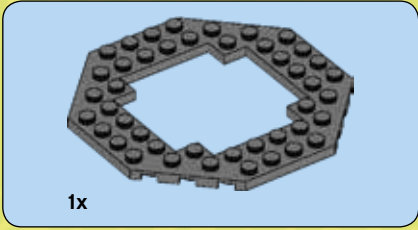
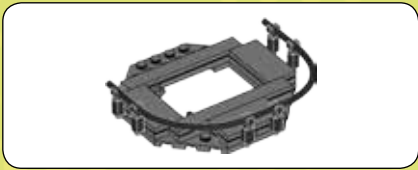

1

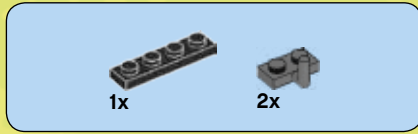
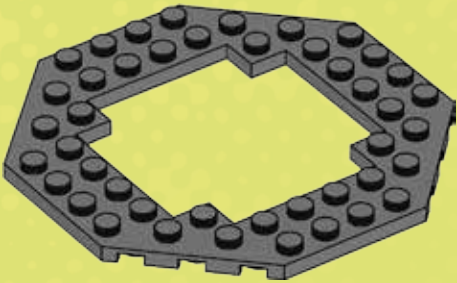

2

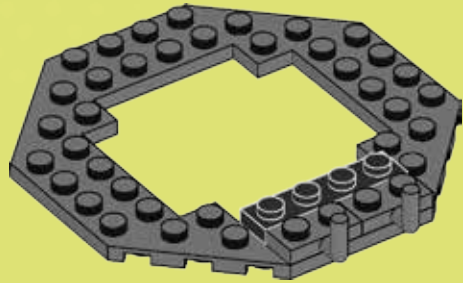

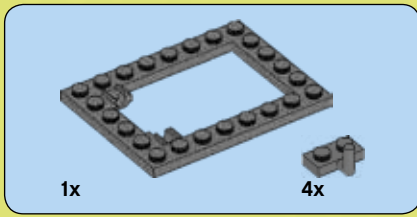

3

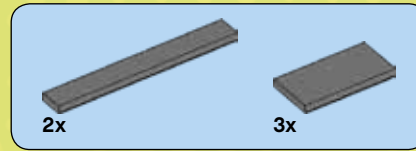
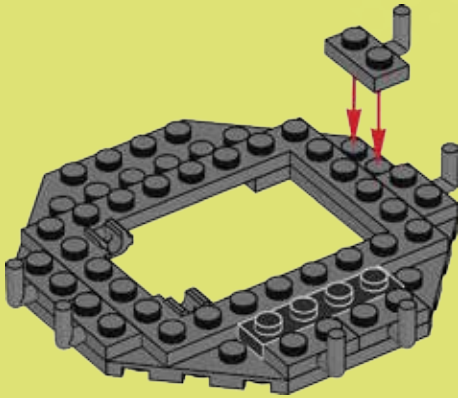

4

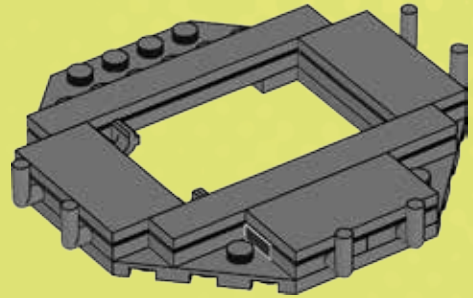



5

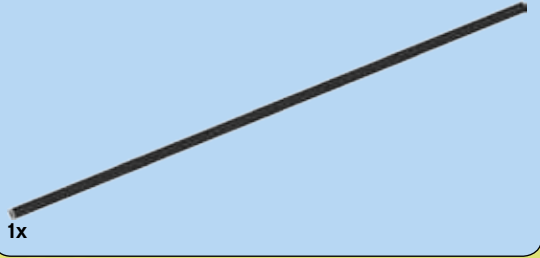
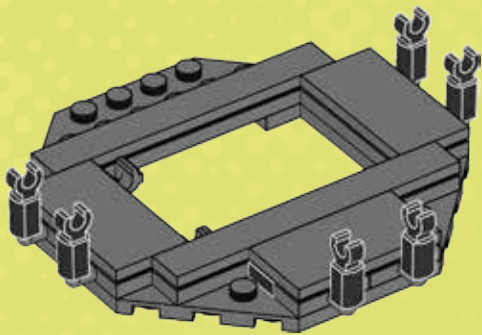

6

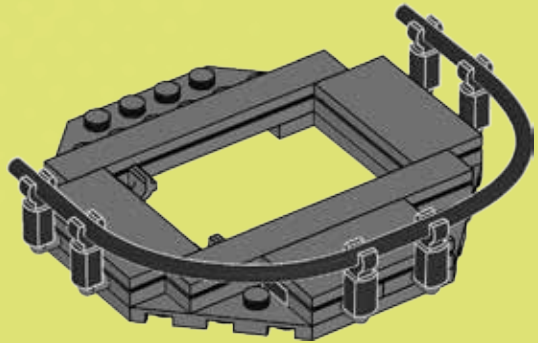

71

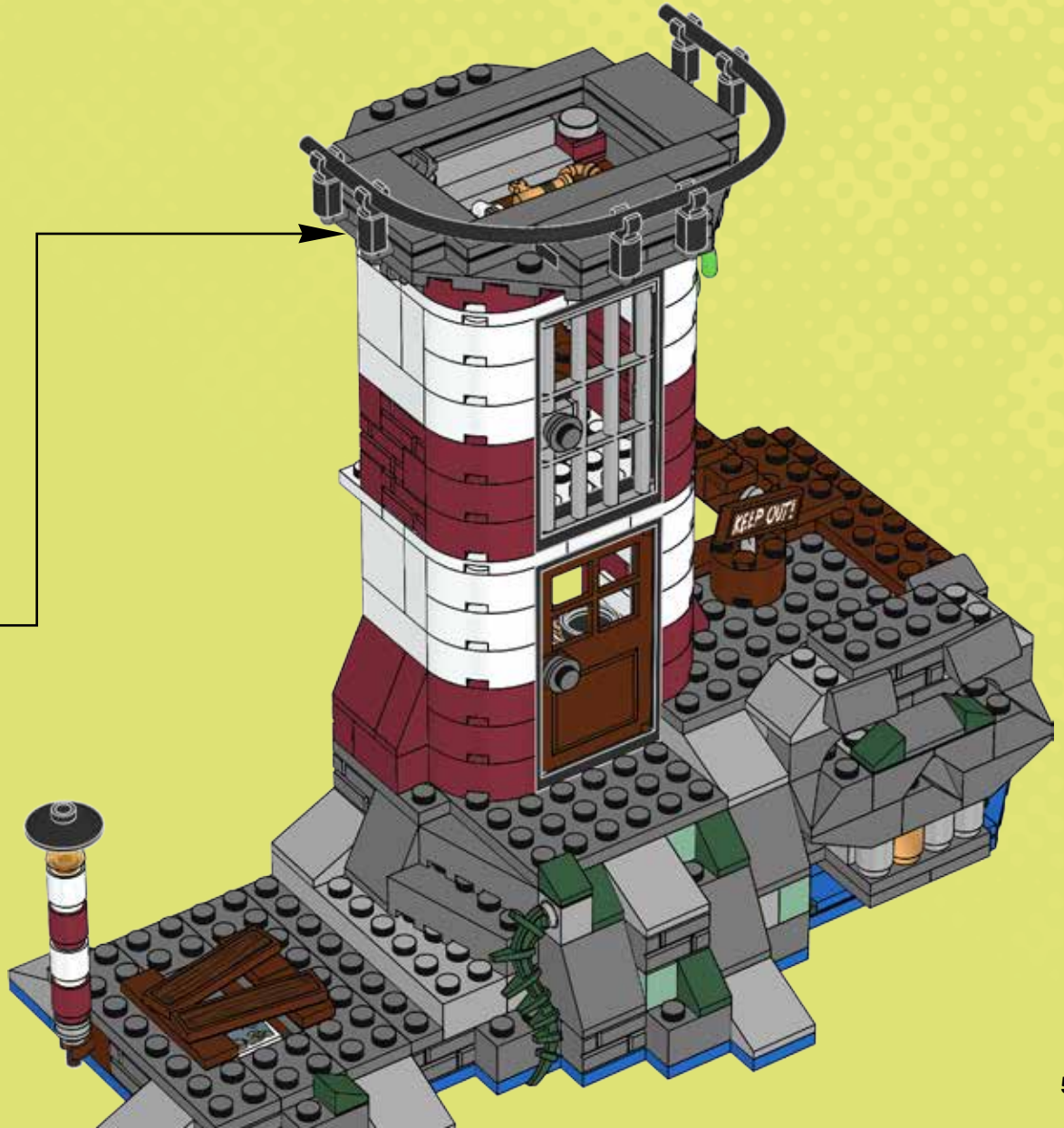



1

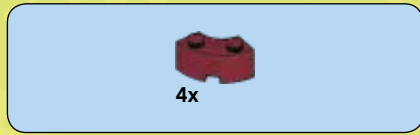

2

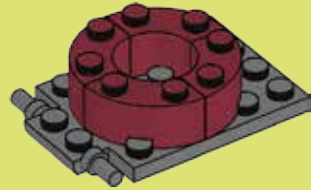



1x

3

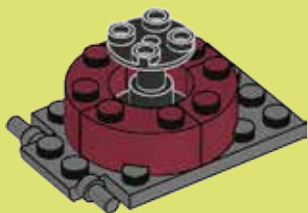

4x

4

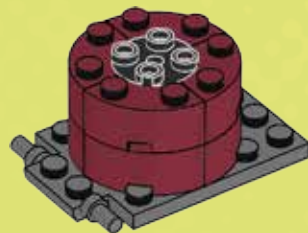



2x

5



2x

6





2x

7

1



2

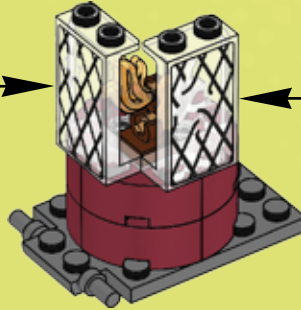

1



2

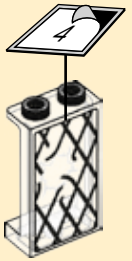

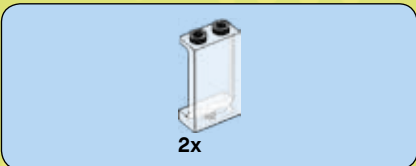

8

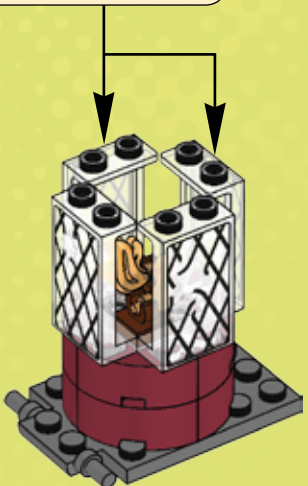
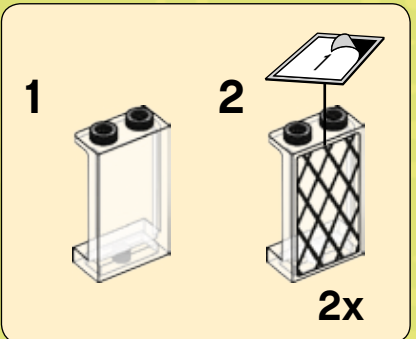

9



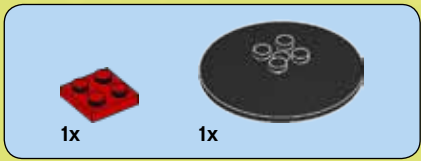

10



11



72







SCOOBY-DOO!

WE'VE GOT A MYSTERY TO SOLVE
WIR MÜSSEN EIN GEHEMNIS LÜFTEN
NOUS AVONS UN MYSTÈRE À RÉSOUDRE

TENEMOS UN MISTERIO QUE RESOLVER
TEMOS UM MISTÉRIO PARA RESOLVER
MÁRIS VAN EGY MEGOLDÁSRA VÁRÓ REJTÉLYUNK

75900



75901



75902



75903



75904



LEGO.COM/scoobydoo



1x
4113954

1x
4113955

4x
302323

5x
302223

2x
4118785

1x
4206482

1x
4609342

1x
379523

1x
303523

1x
4528850

1x
4610354

1x
452826

1x
6056234

1x
4113209

1x
6106280

7x
6015891

4x
4121715

1x
6055630

2x
4177431

1x
6093977

1x
4653822

2x
389426

1x
4587844

2x
371026

2x
302026

1x
474026

1x
6058341

2x
4535834

1x
6081988

1x
6096955

1x
373726

1x
6025396

3x
4113261

2x
300401

4x
362201

1x
4181142

2x
306201

12x
4567449

1x
366001

2x
6062279

1x
6123042

1x
302201

2x
302101

1x
371001

1x
346001

2x
303401

4x
4550745

1x
486501

1x
4600294

1x
6006221

1x
9551

5x
4494474

1x
302221

1x
614121

1x
4599453



1x
6122385



2x
4164021



3x
4537936



3x
4183133



1x
4539907



1x
4539908



1x
6025027



1x
6116514



1x
6122140



2x
6022112



1x
6116511



1x
6116504

66



2x
4211065



2x
4211008



2x
4210998



2x
4210997



1x
4595710



1x
4595708



1x
4210794



1x
4211114



1x
4296512



6x
4211060



1x
4210875



2x
4211128



2x
4287972



4x
4210935



1x
4213607



9x
4567887



2x
4211096



7x
4234534



3x
4210702



2x
4211064



2x
4210999



11x
6000311



2x
4211094



2x
4211043



1x
4211001



5x
4560184



1x
4579354



6x
4611703



4x
4210633



1x
4500608



2x
6092674



2x
4619655



1x
6119126



2x
6102650



1x
4625032



2x
6088558



5x
4211181



1x
4211193



1x
4215496



2x
4211166



2x
6071274



2x
6092590



1x
4216581



1x
6075213



1x
4283660



1x
6103769



1x
4609635



1x
4277751



4x
4211221



1x
4224243



2x
4565394



5x
4211194



1x
4211186



2x
4211204



1x
4211211



2x
4558953



1x
4533772



3x
4211412



1x
4211535



7x
4211440



2x
4211410



8x
4211421



2x
6071299



1x
6122981



1x
4211753



1x
4258308



2x
4211573



1x
4211483



1x
4610149



1x
4211419



2x
6106189



2x
4211385



6x
4211392

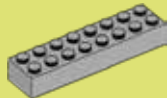

2x
6037399



2x
6028812



2x
4650260



1x
6102983



1x
6102984



1x
6035734



1x
6119136



1x
6122127



1x
6122066



1x
6122746



1x
6122736



1x
6060800



1x
4595077



1x
6022033



1x
6122731



1x
6122133



1x
4162916



1x
6123036



1x
301024



4x
300924



1x
614124



1x
6123033



1x
6059027



2x
4125254



2x
4121741



1x
6122725



1x
4654448



6x
4541376



10x
6093908



1x
4539104



2x
4539099



21x
4625551



2x
4645101



2x
4590811



2x
4625281



1x
4541496



10x
4521948



1x
4550324



1x
6115248



1x
6122533



1x
4666579



6x
4504375



10x
4255624



1x
4226869



1x
6122436



1x
6122359



1x
4294148



1x
6107389



1x
6076604



1x
6076604



2x
4632100



6x
4278412



4x
6010737



1x
4523573



1x
4567338



2x
4222960



3x
4649066



3x
4649066



3x
4649066



3x
4649066



3x
4649066



3x
4649066



3x
4649066



3x
4649066



3x
4649066



3x
4649066

Customer Service
Kundenservice
Service Consommateurs
Servicio Al Consumidor

LEGO.com/service or dial



: 00800 5346 5555

: 1-800-422-5346

LEGO and the LEGO logo are trademarks of the LEGO Group.
©2015 The LEGO Group. 6132705



Download Zapp App Scan the page Play Activity!

Zapp App herunteladen
Seite scannen
Spiele Spaß erleben!

Télécharge l'application Zapp
Scanne la page
Joue à l'activité !

Descarga la app Zapp
Escanea la página
¡Juega!

Descarrega a app Zapp
faz scan da página
Joga com muita ação!

Töltsd le a Zapp appot
Szkemöld be az oldalt,
Indítsd a játékot!



TM & © Hanna-Barbera.
WB SHIELD: TM & © Warner Bros. Entertainment Inc.
(s15)

Apple, the Apple logo, iPad, iPhone and iPod touch are trademarks of Apple Inc.
Google Play is a trademark of Google Inc.