



Friends



41033



1



2



3



4



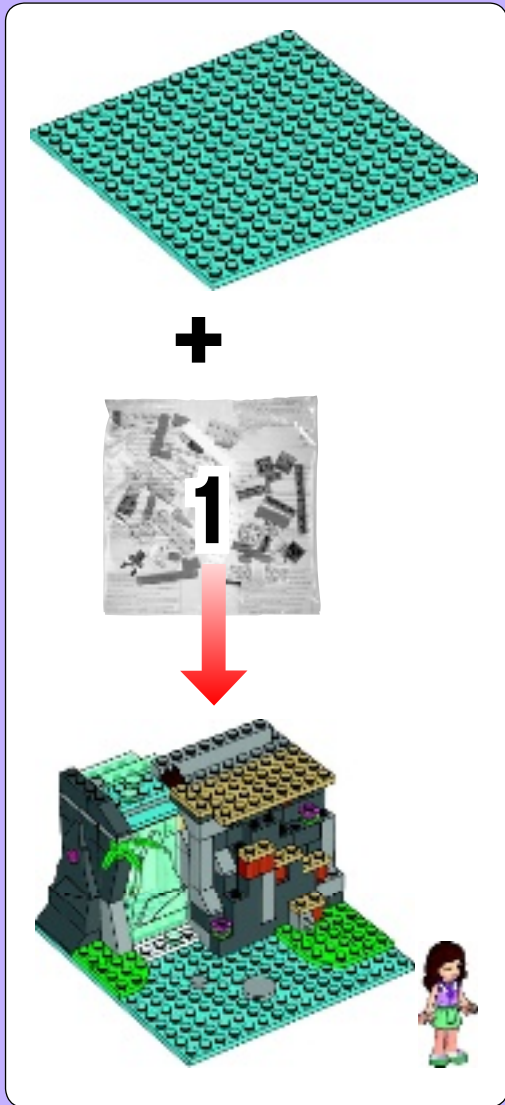



1

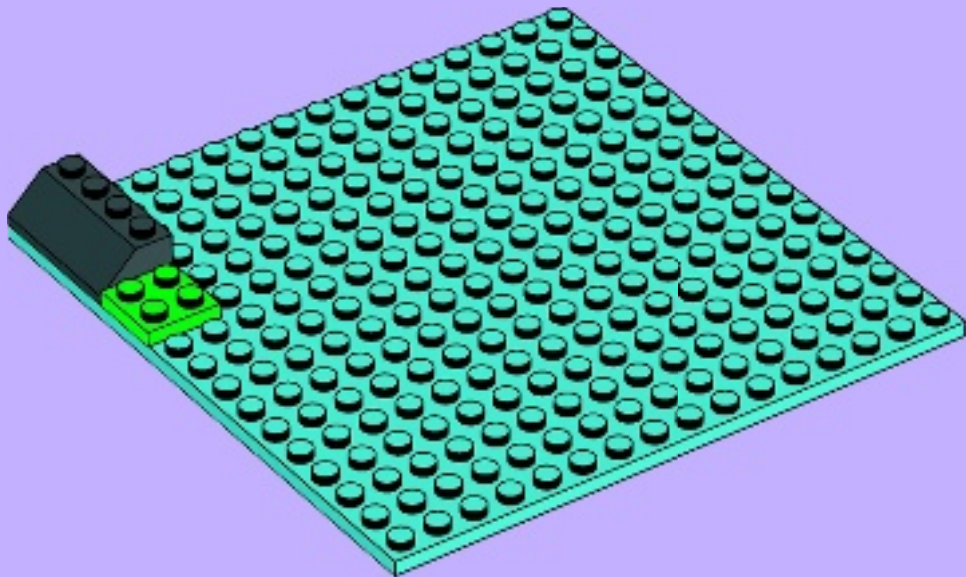

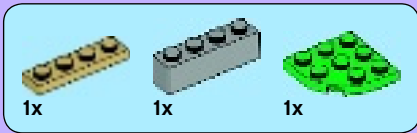

2





3

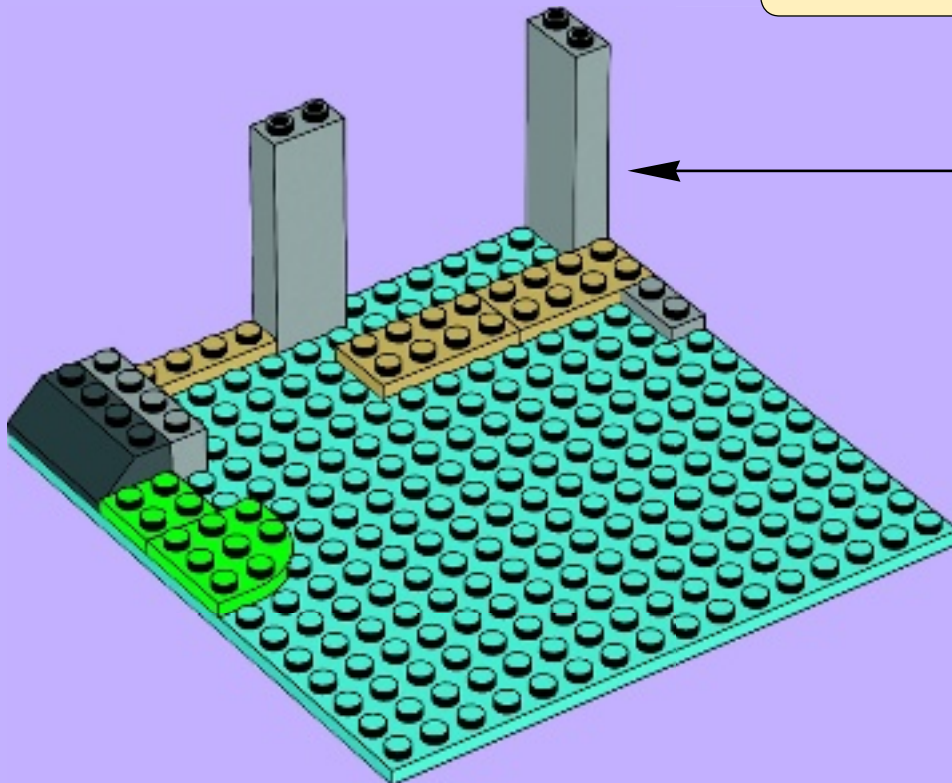
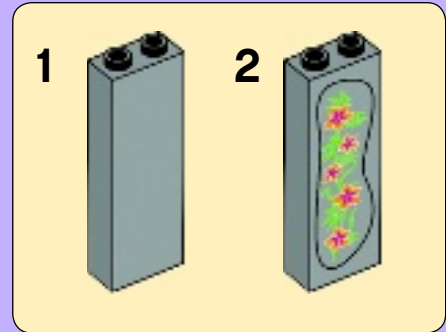

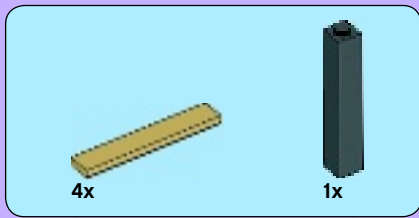

4

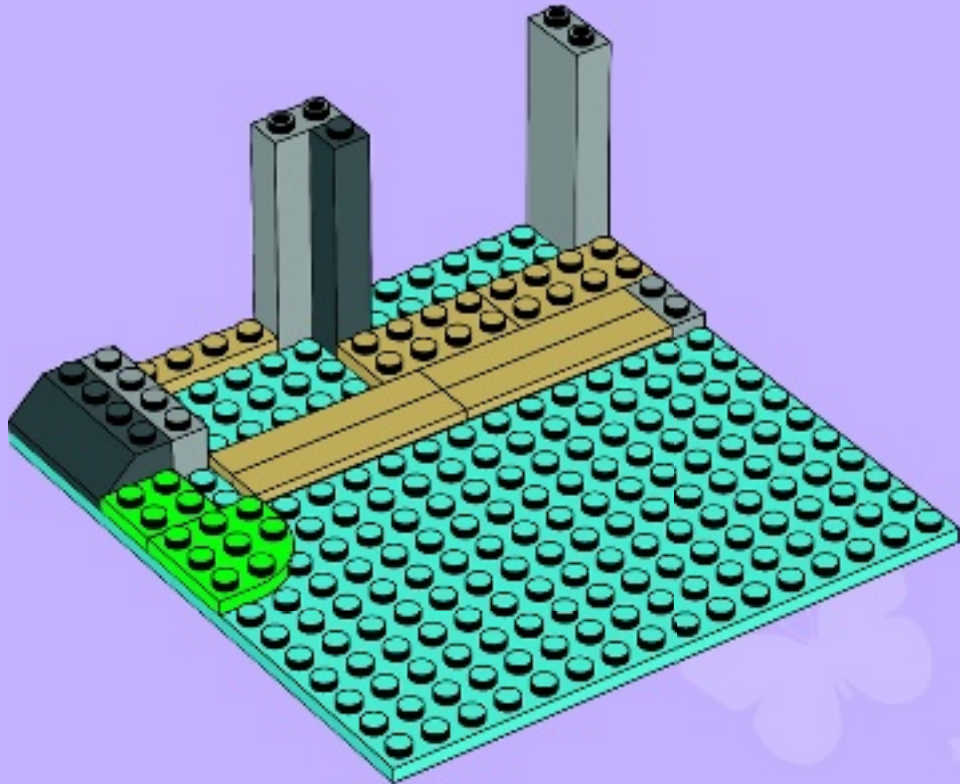

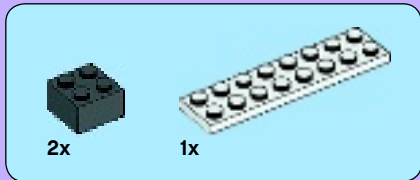

5

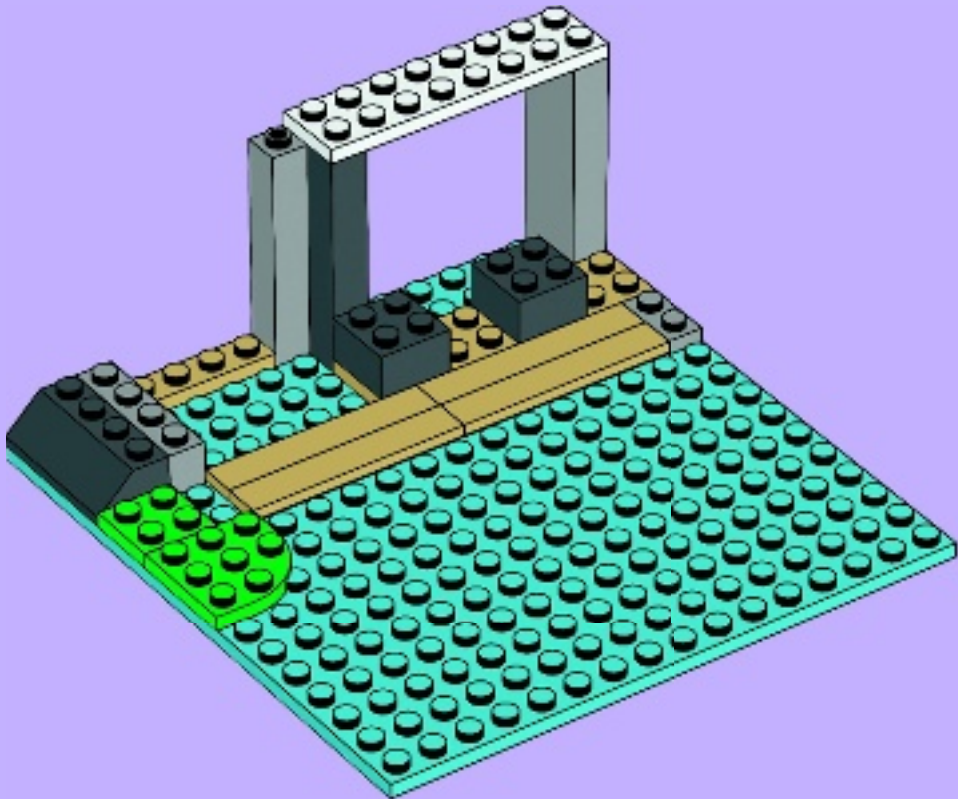

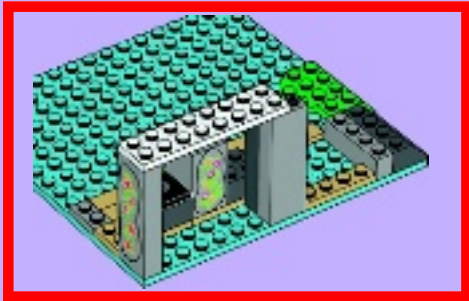
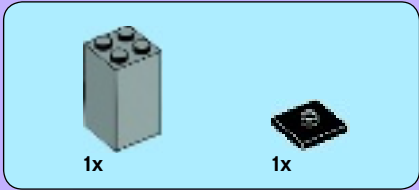

6

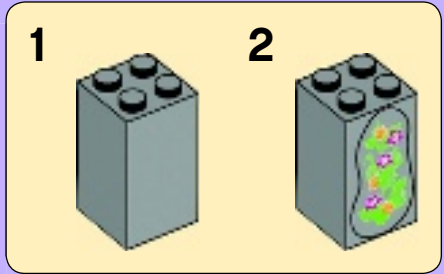
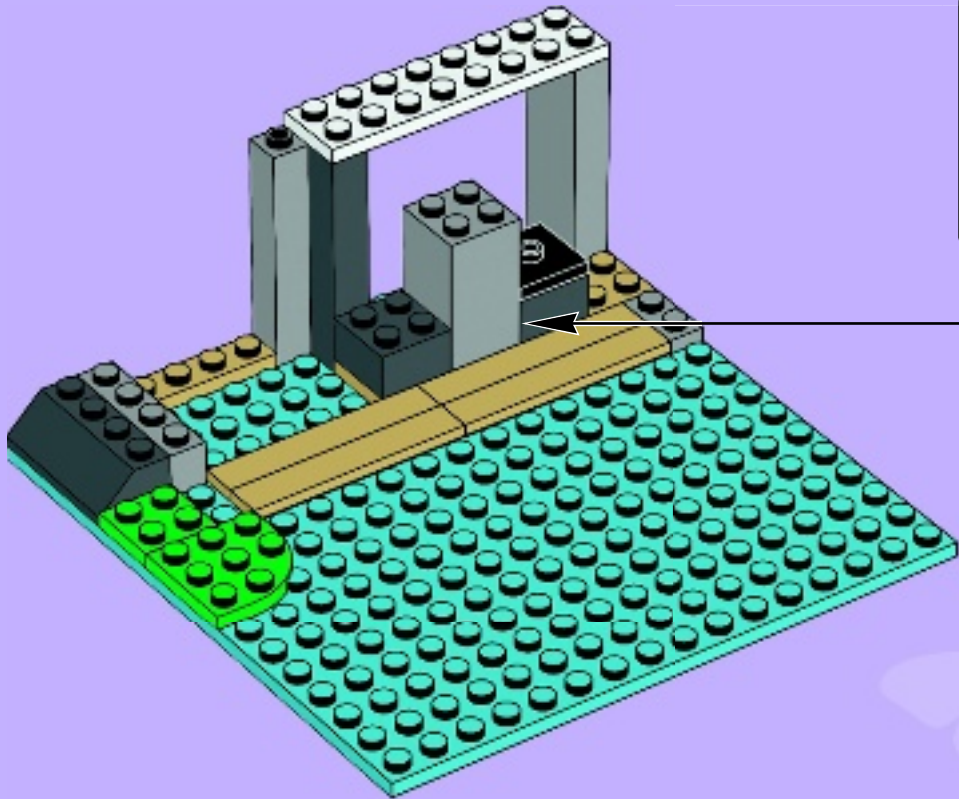



1x



1x

7

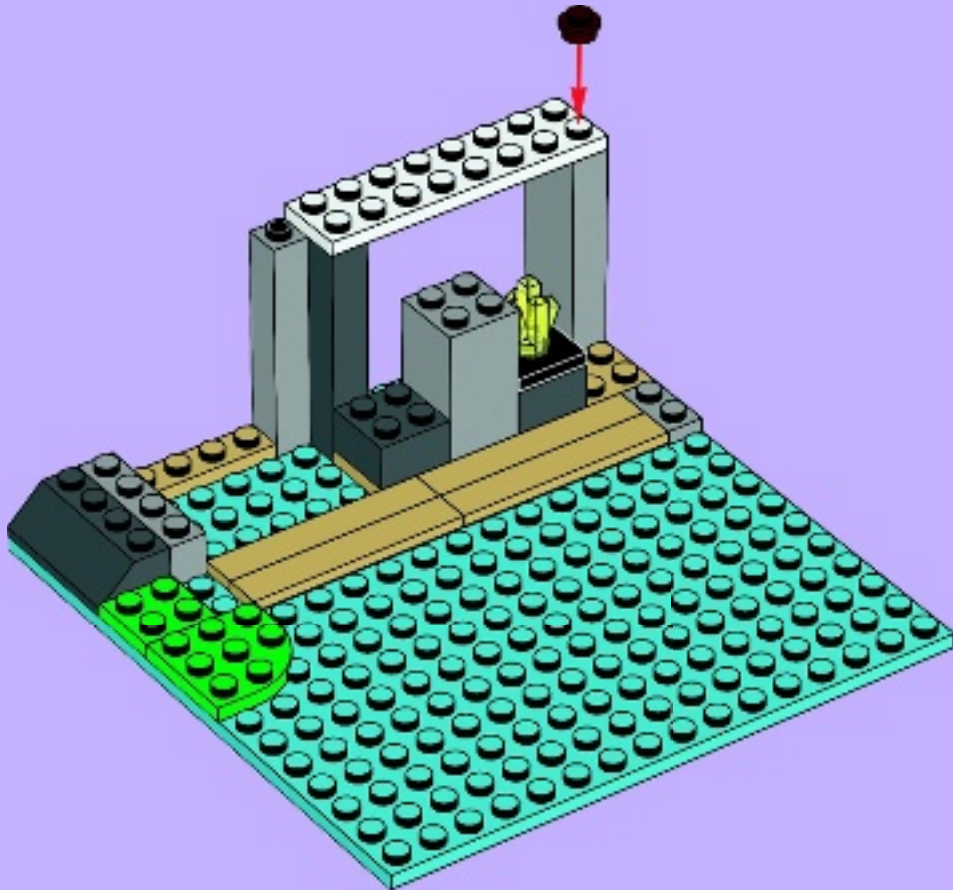



9

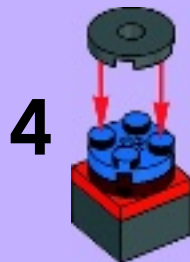
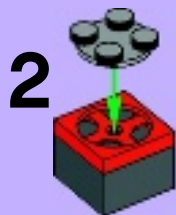

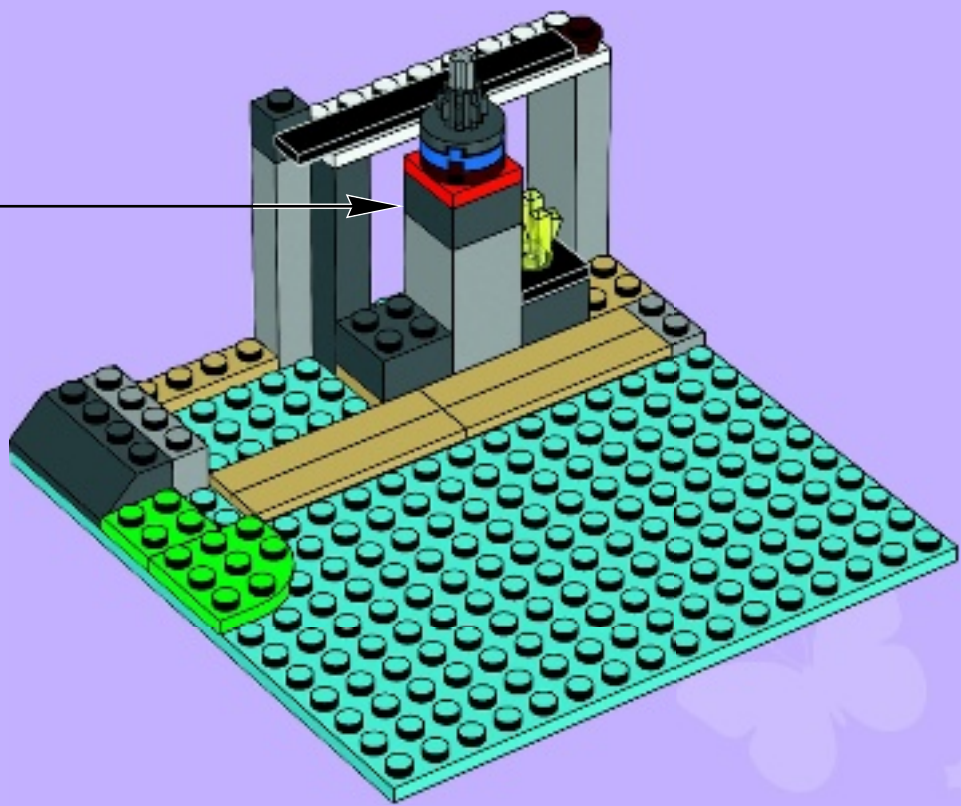

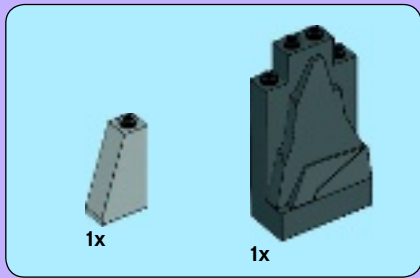

10

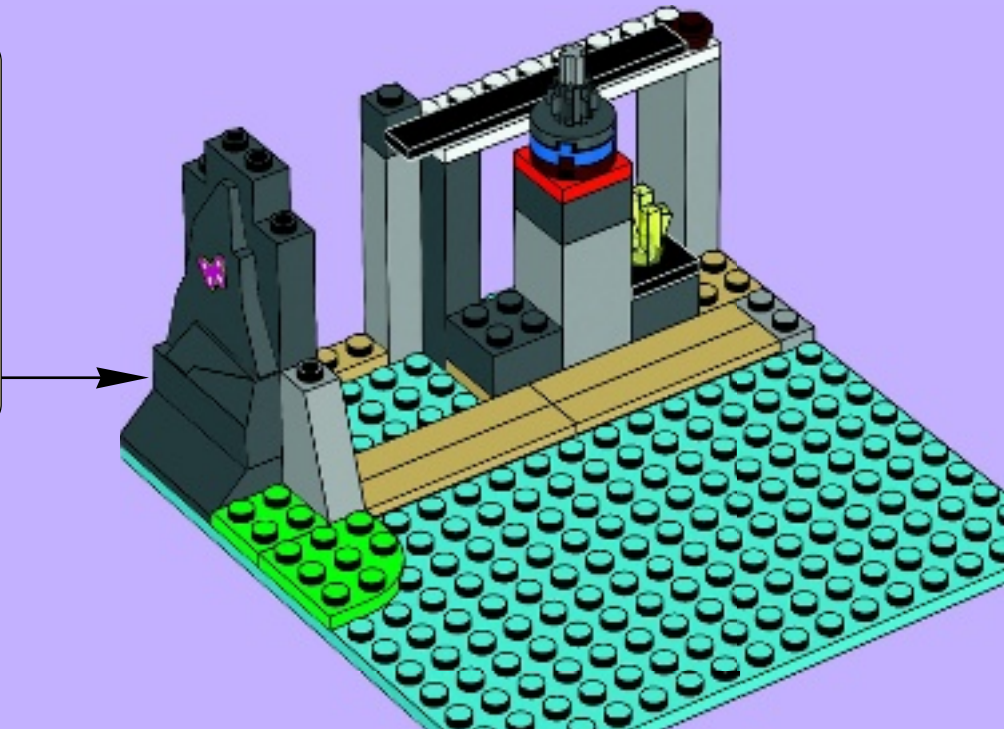

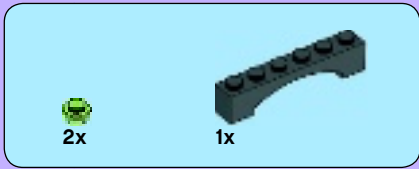

11

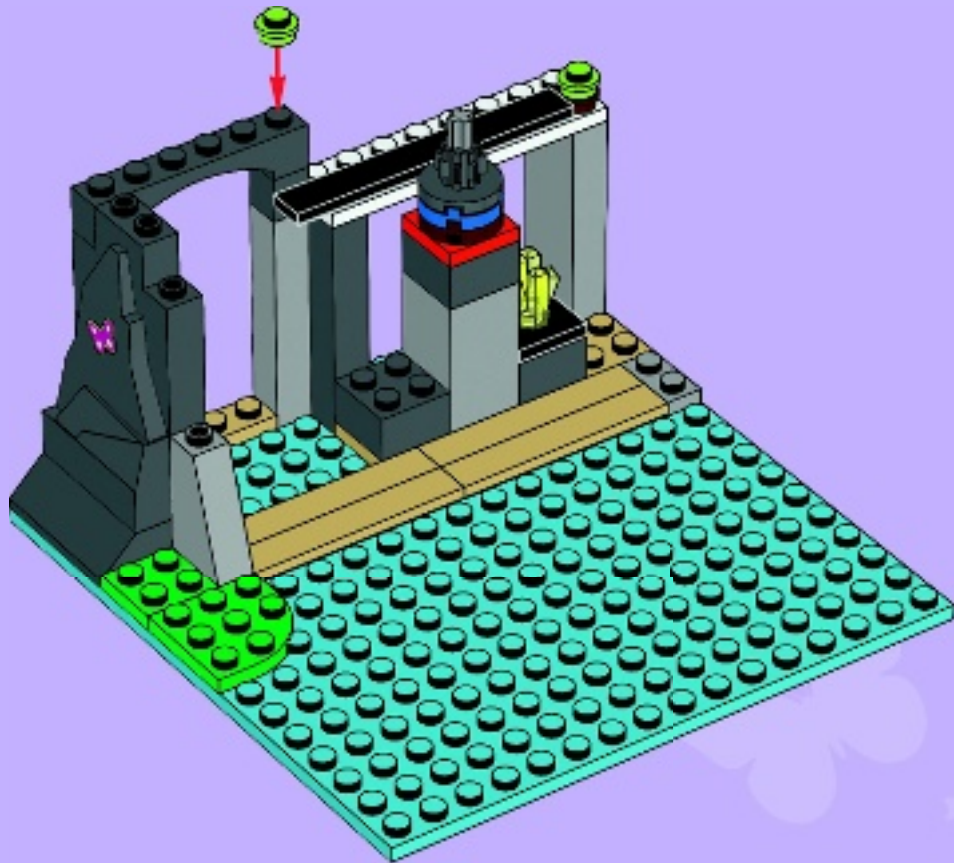

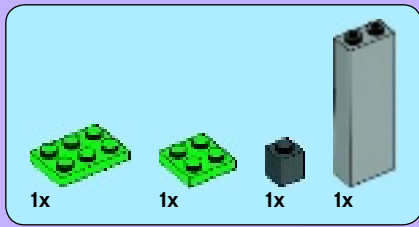

12

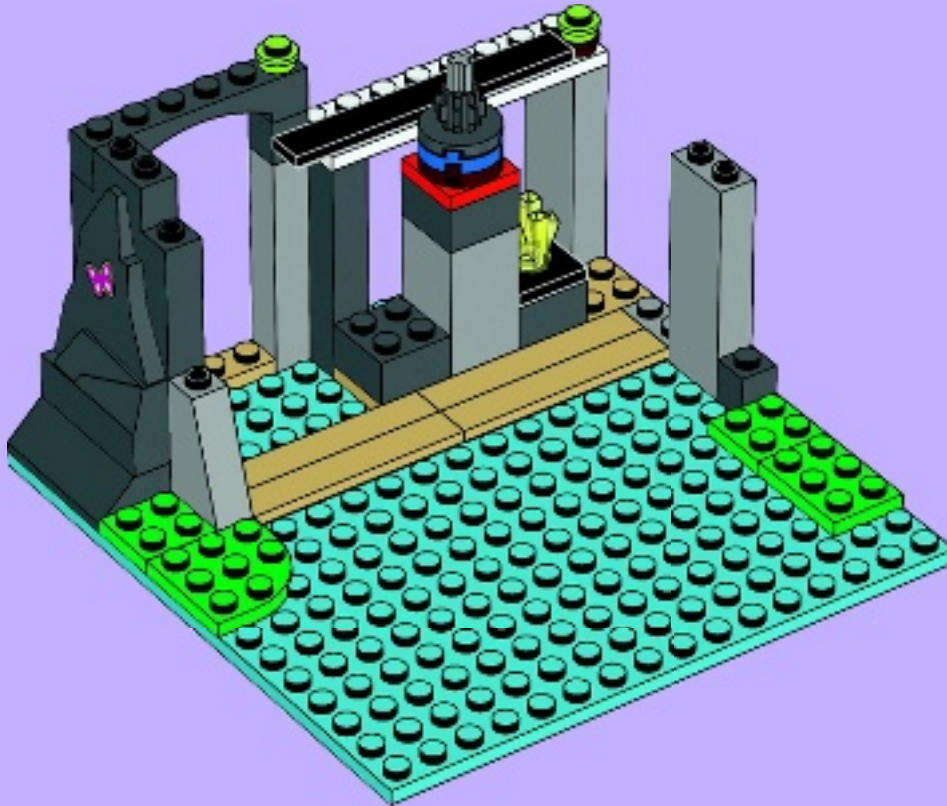

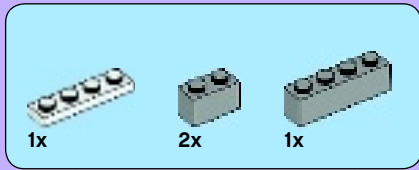

13

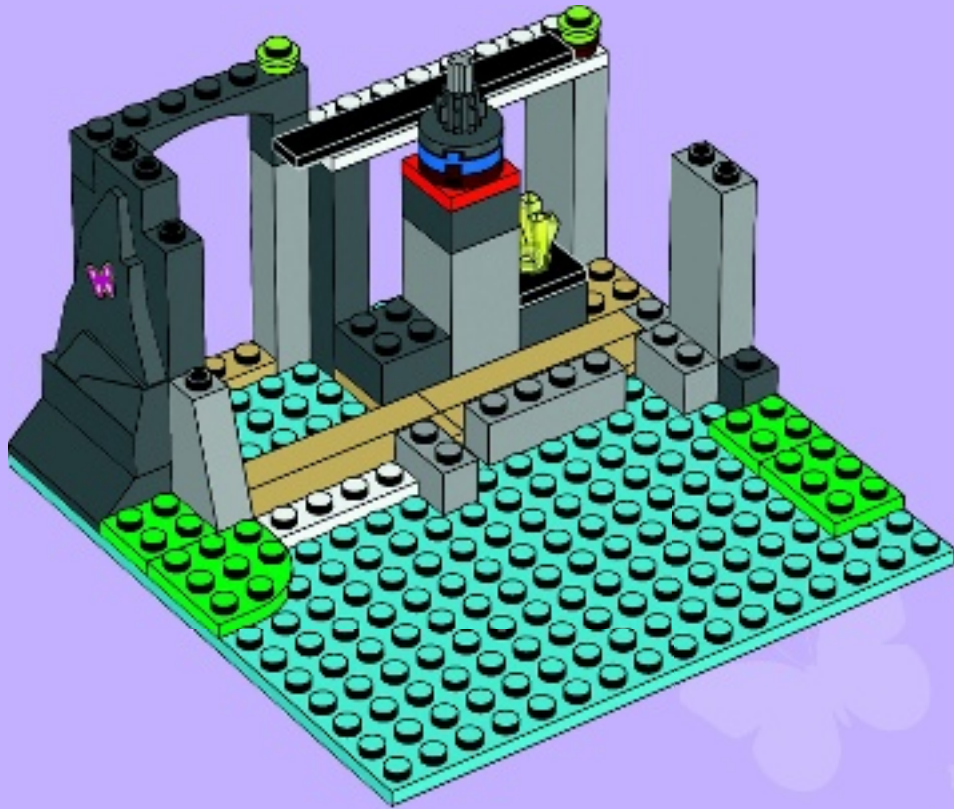



1x



1x

14

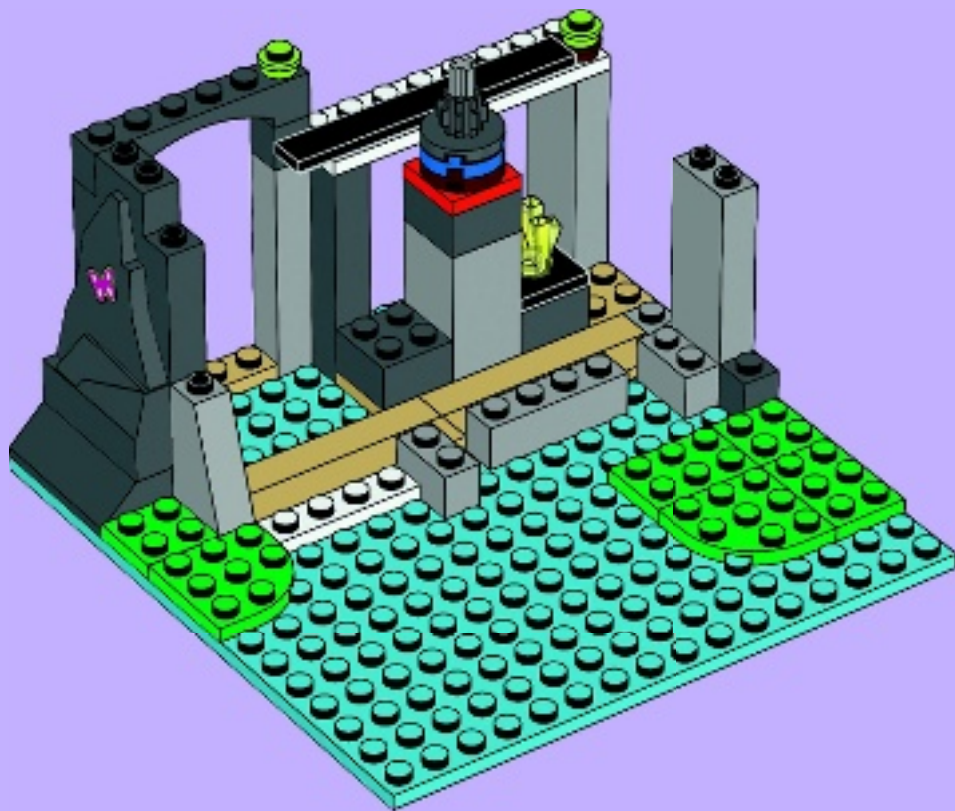

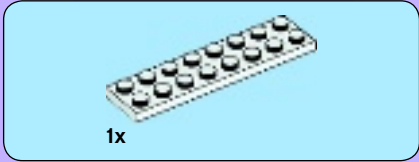
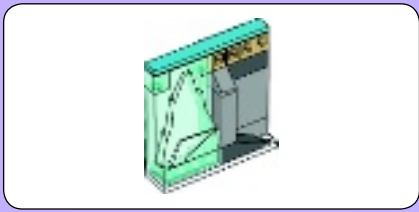

1

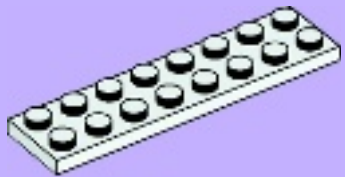

2

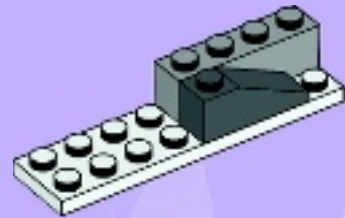

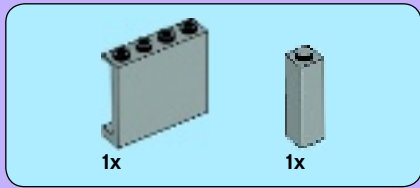

3

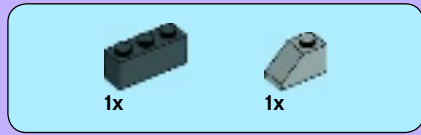
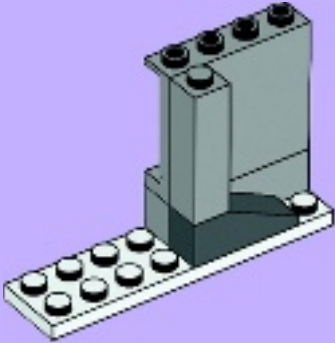

4

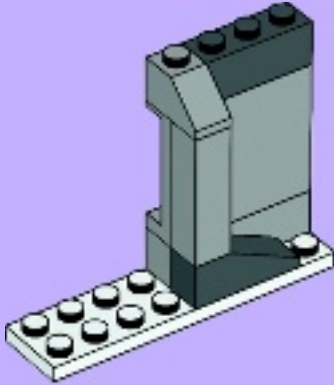

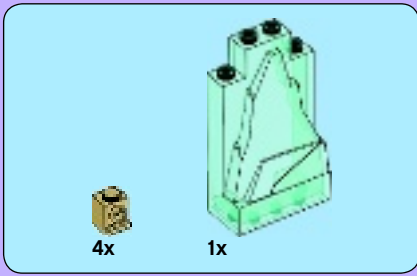

5

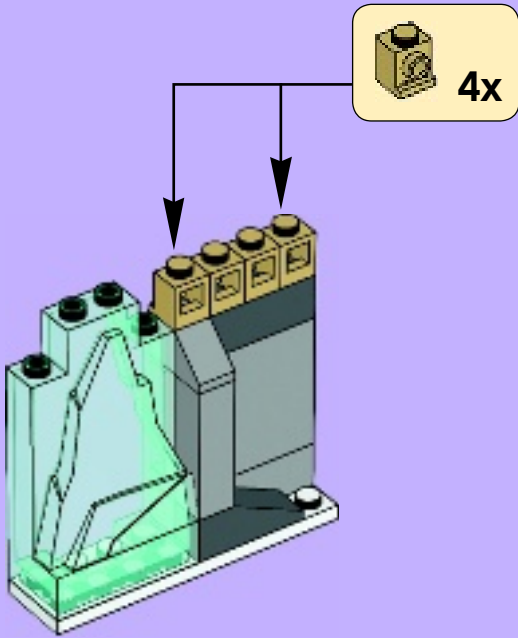

6



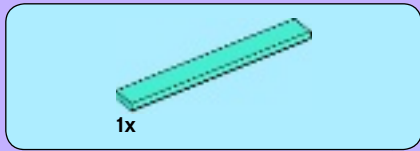

7

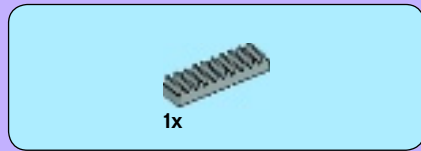
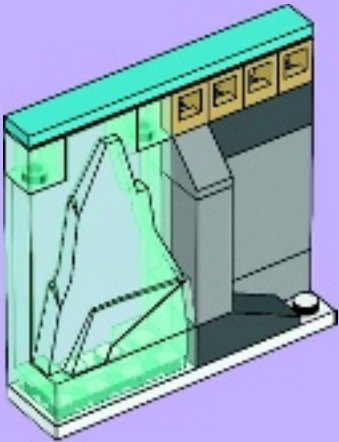

8

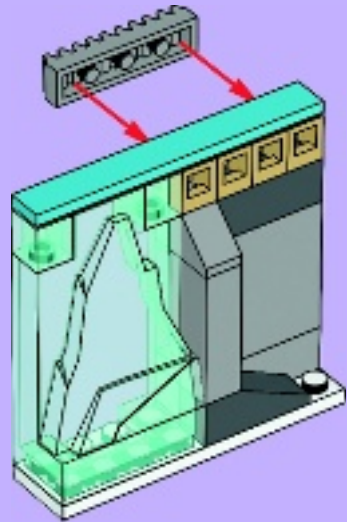

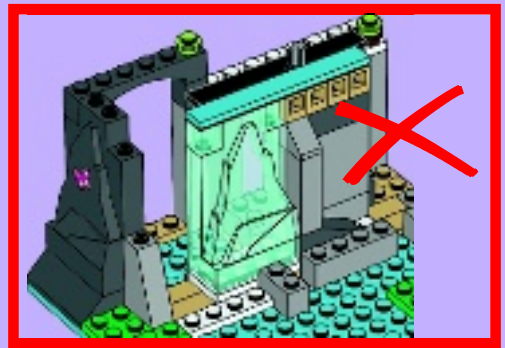
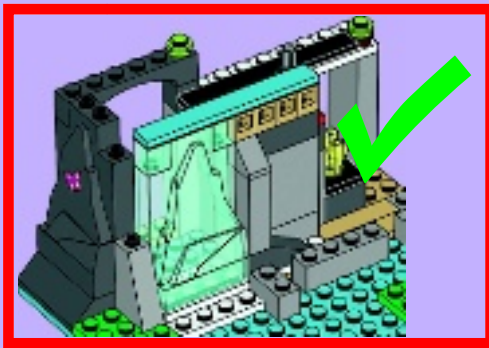

15

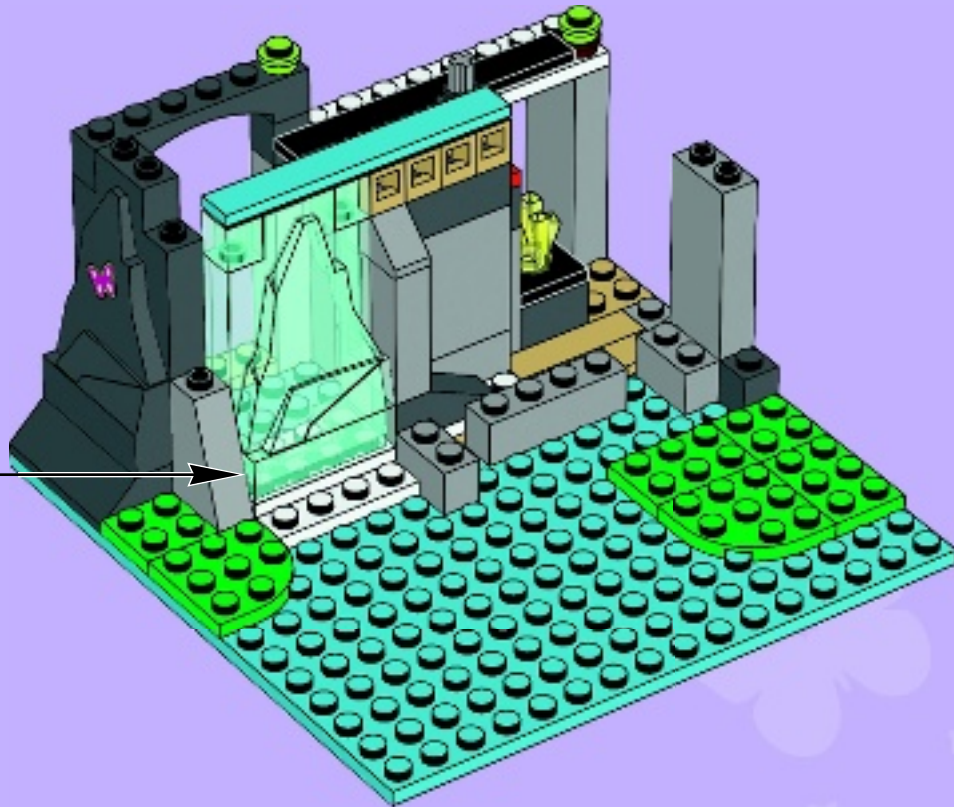

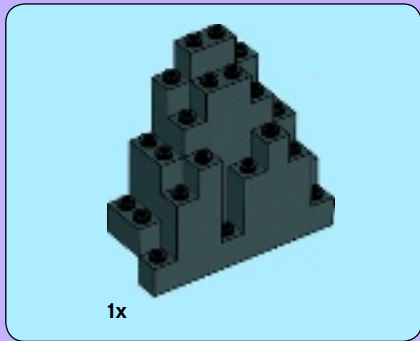

16

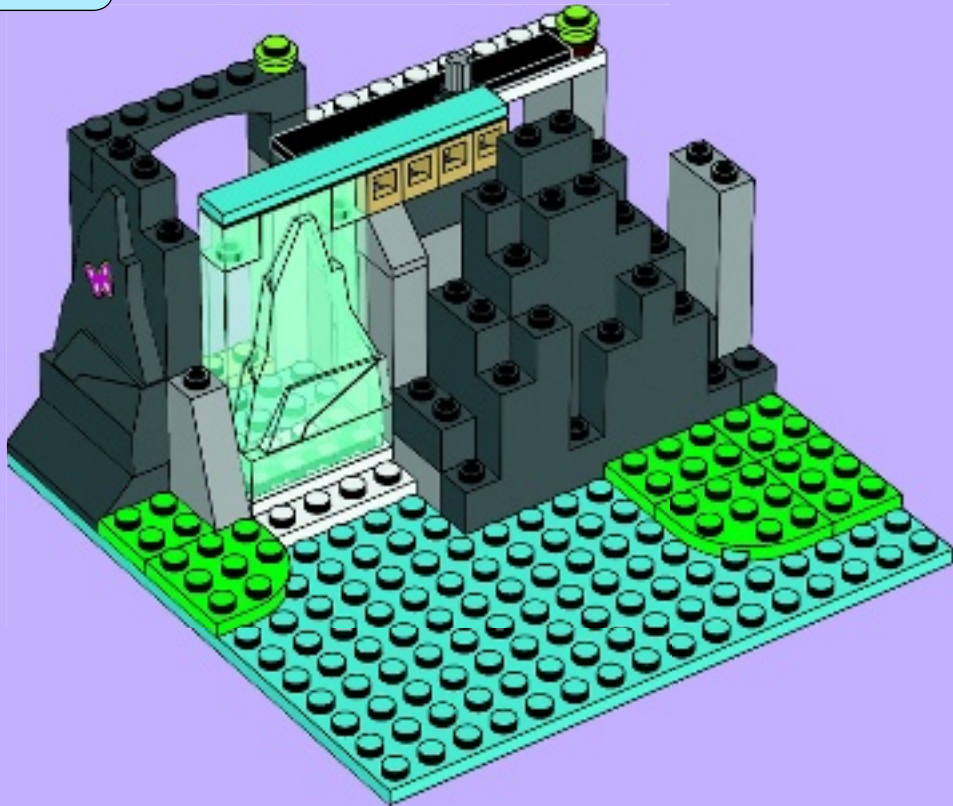



17

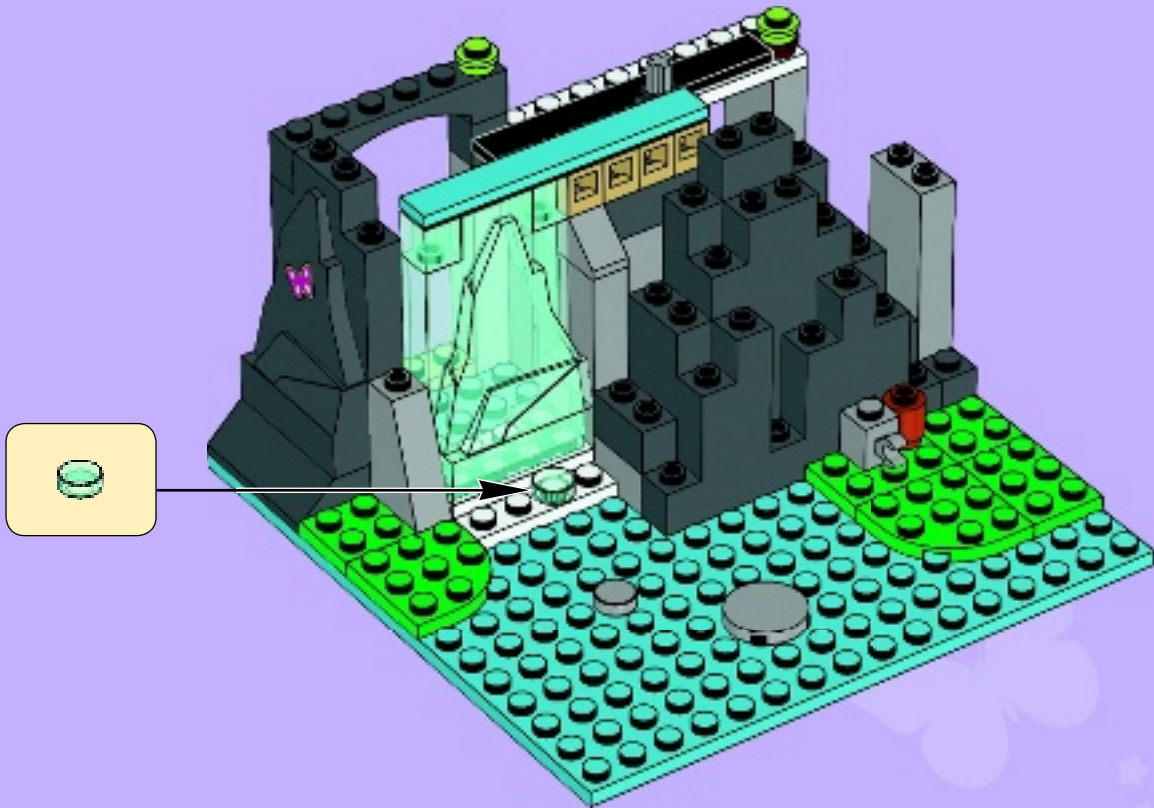

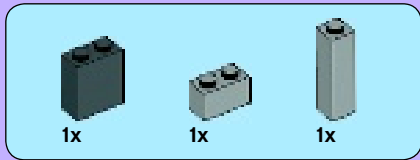

18

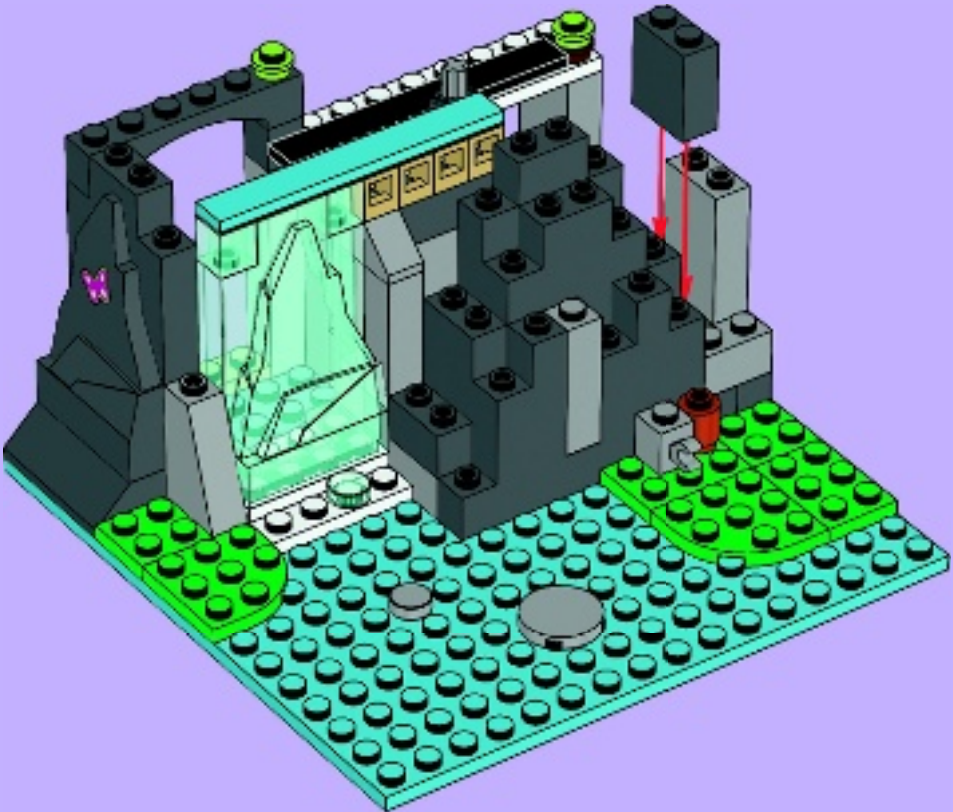



1x



2x



2x

19

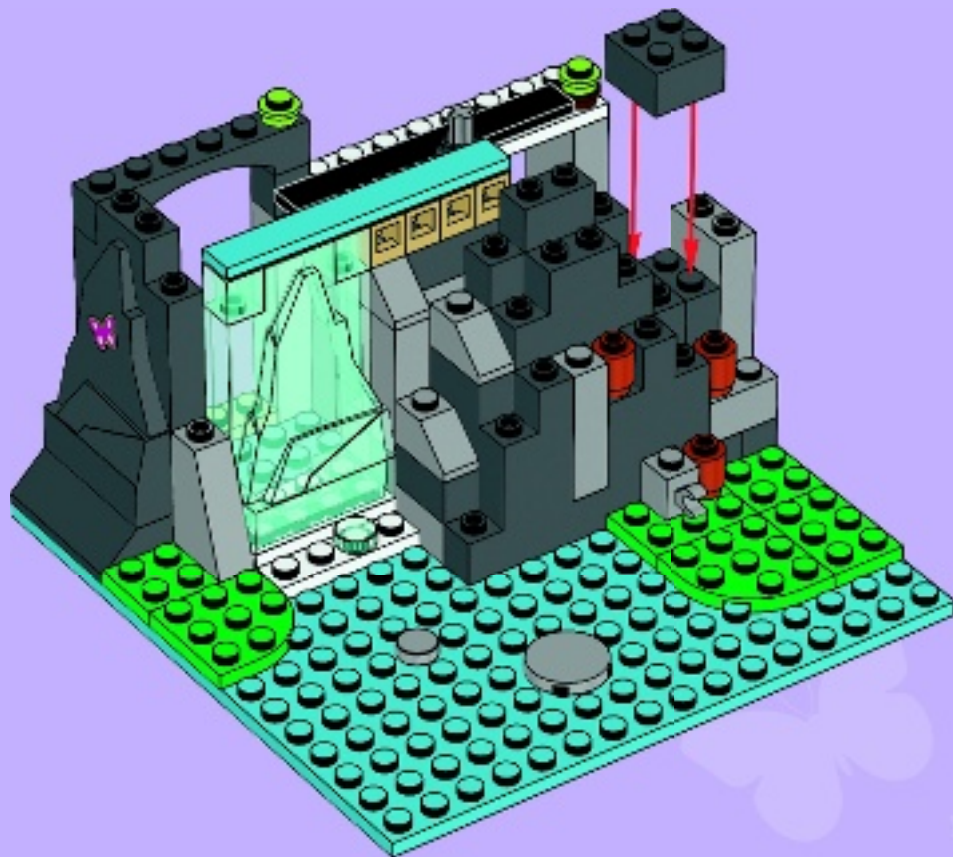



3x



1x

20

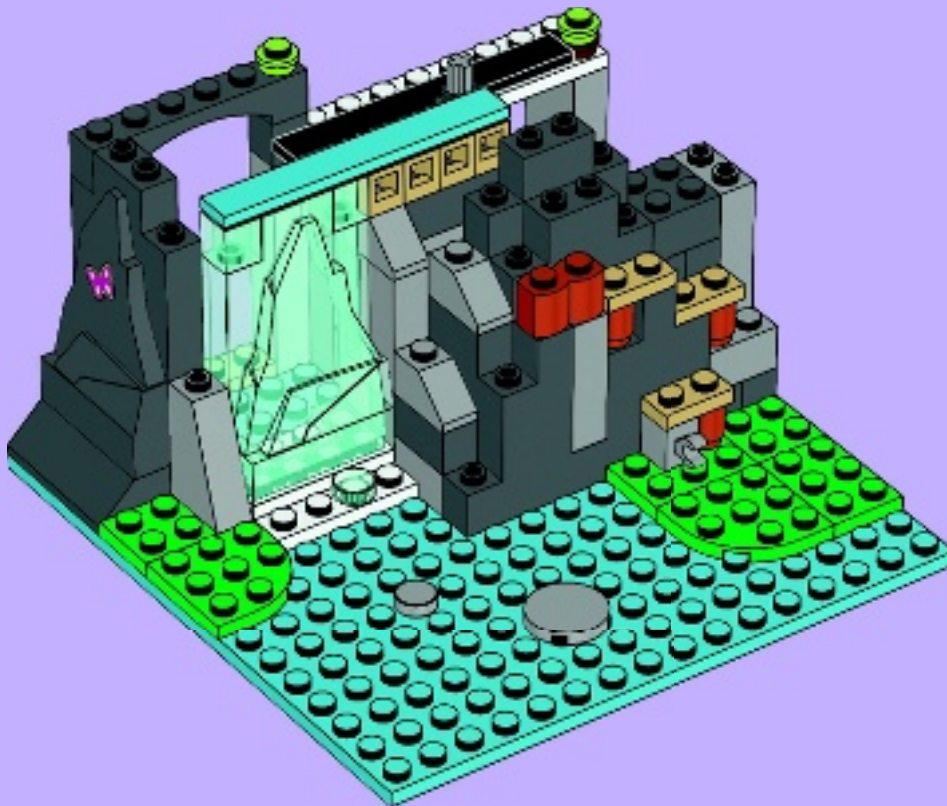

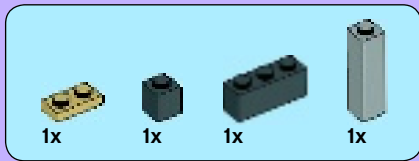

21

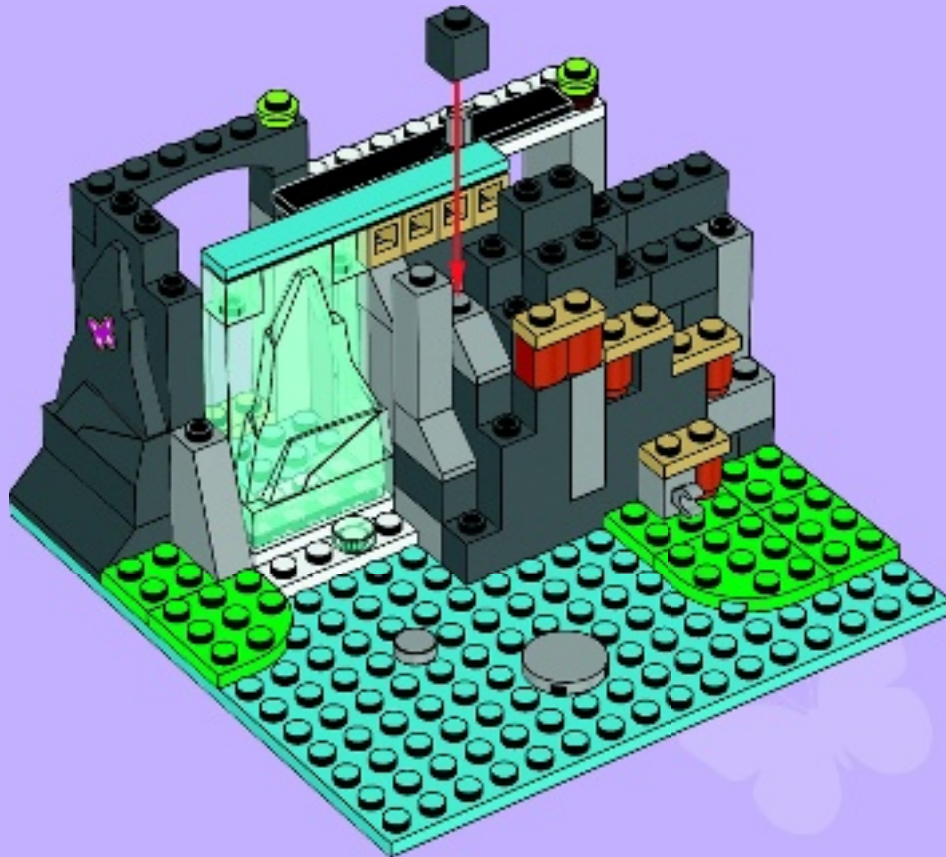



22

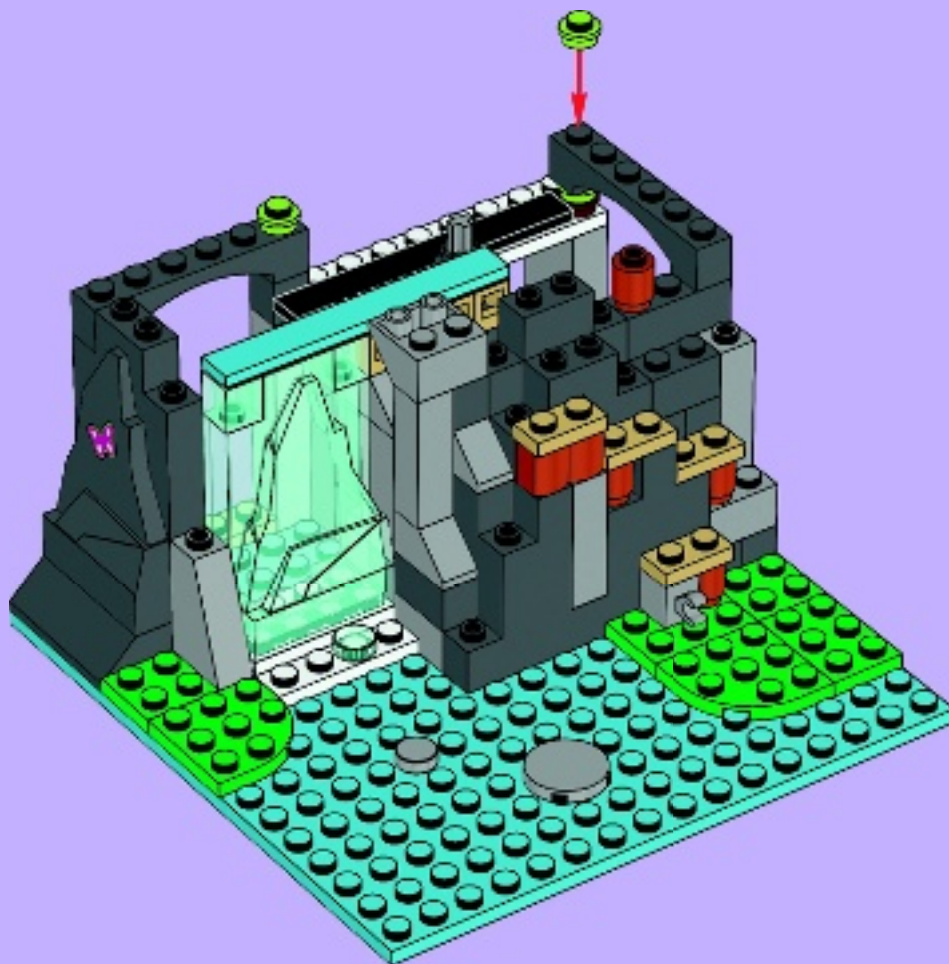

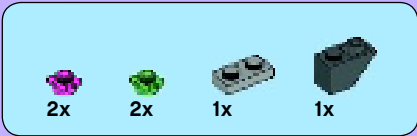

23

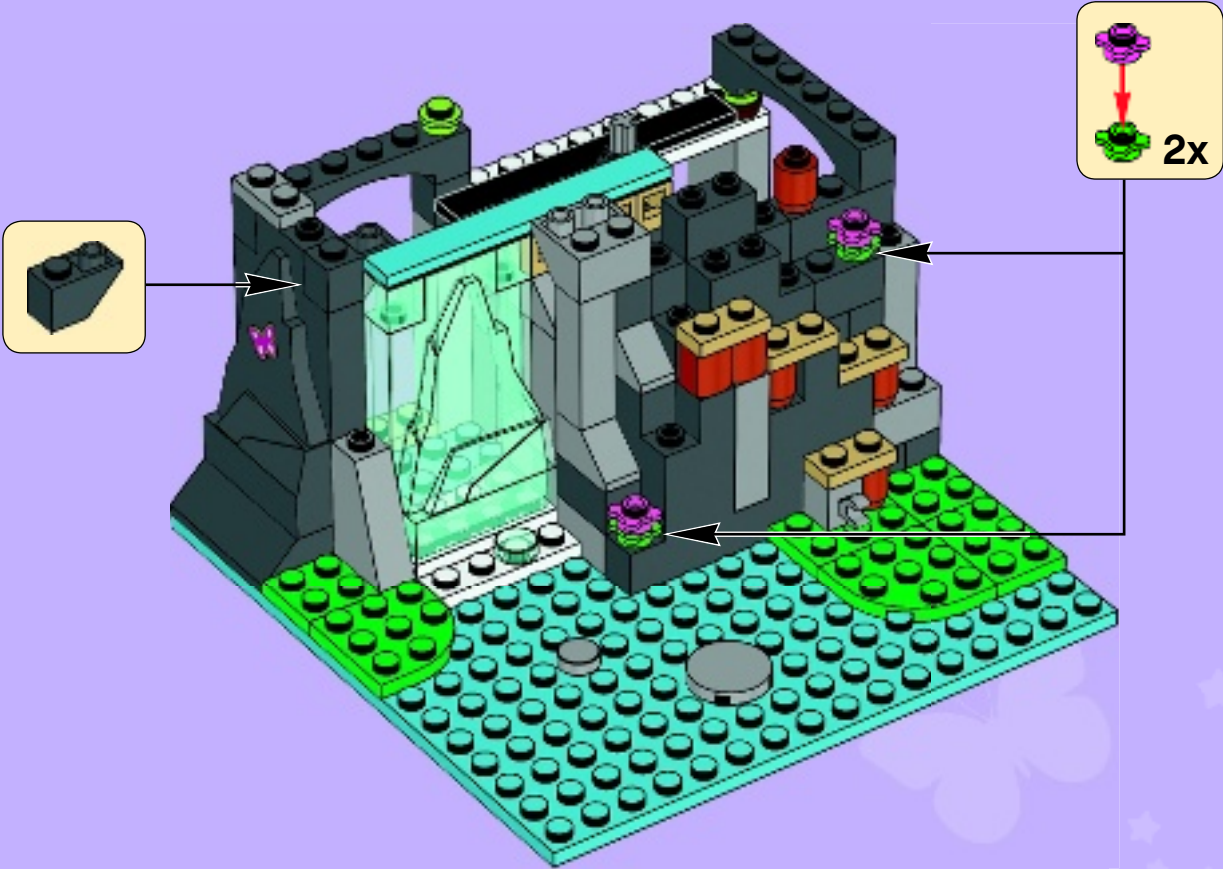



24

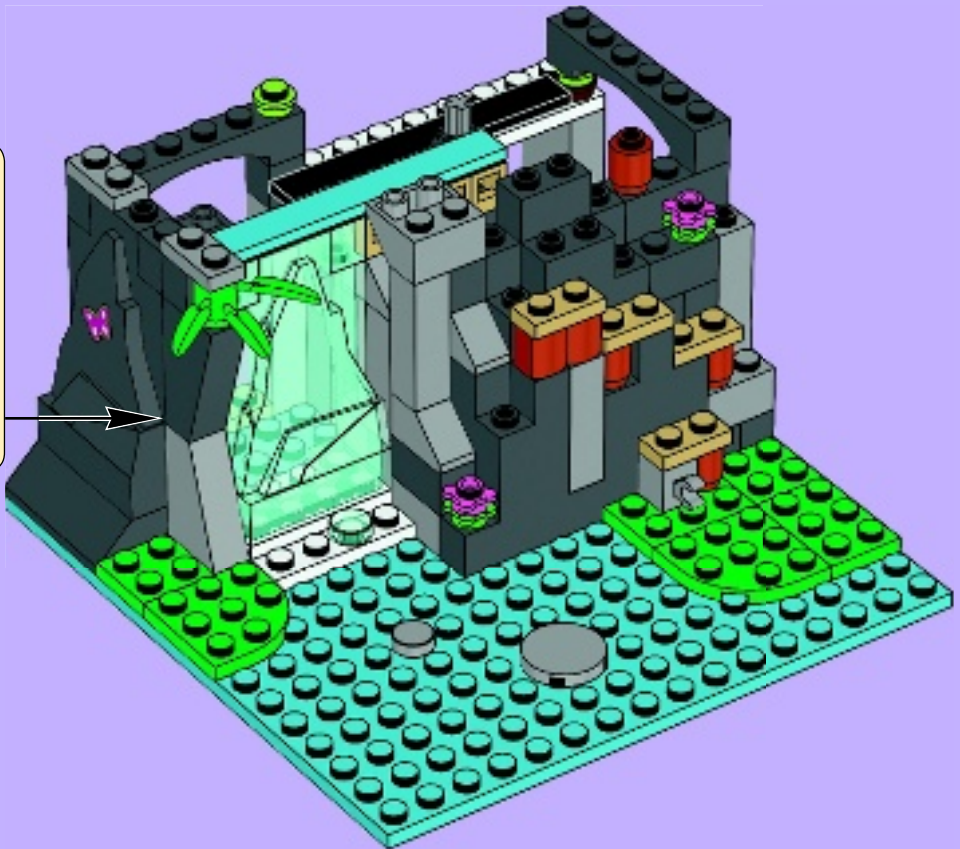
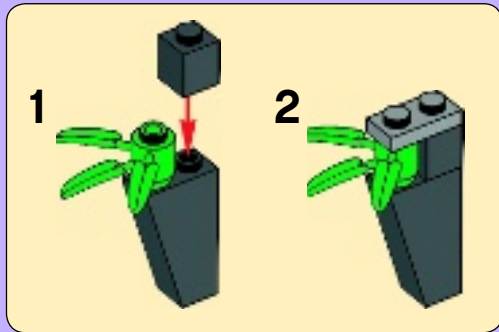

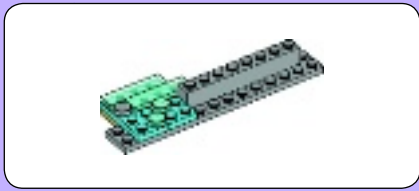

1

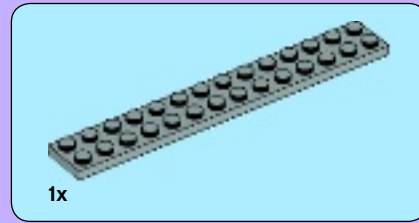
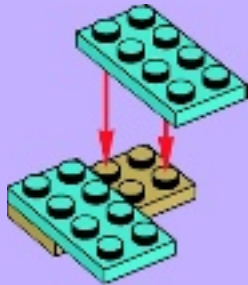

2

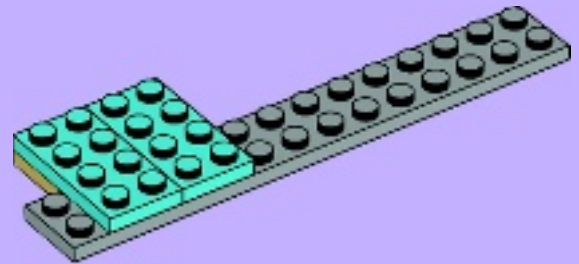

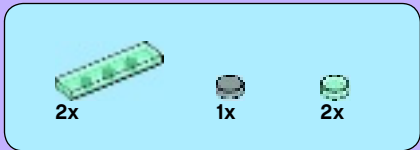

3

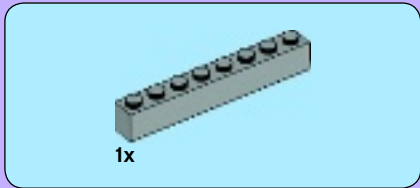
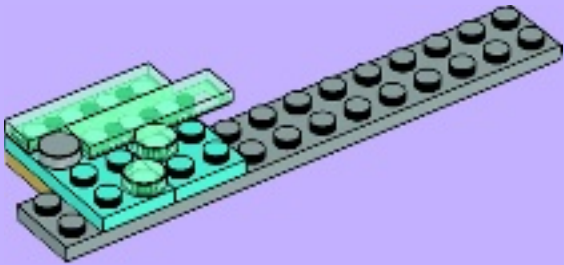

4

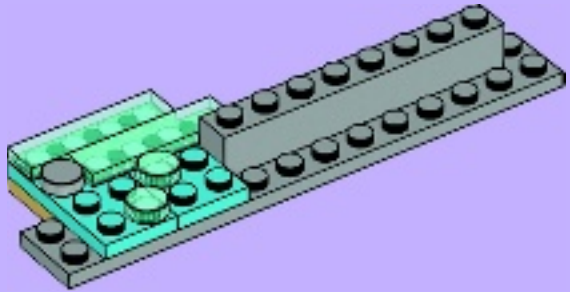

25

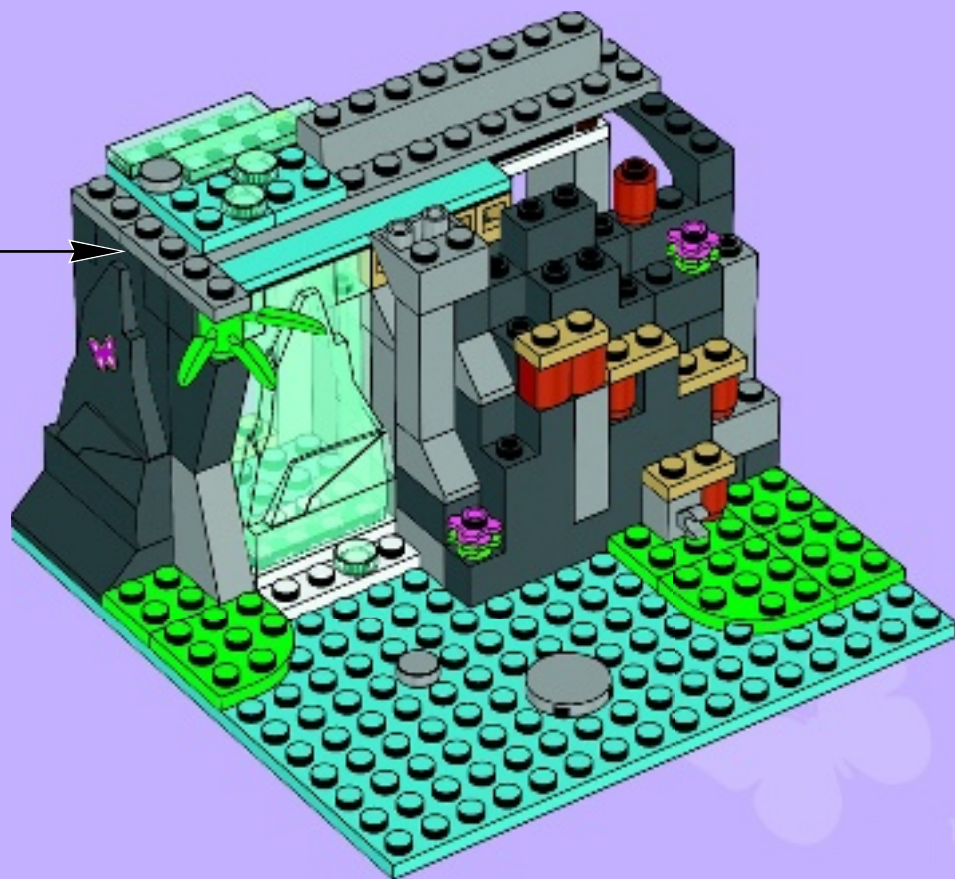



26

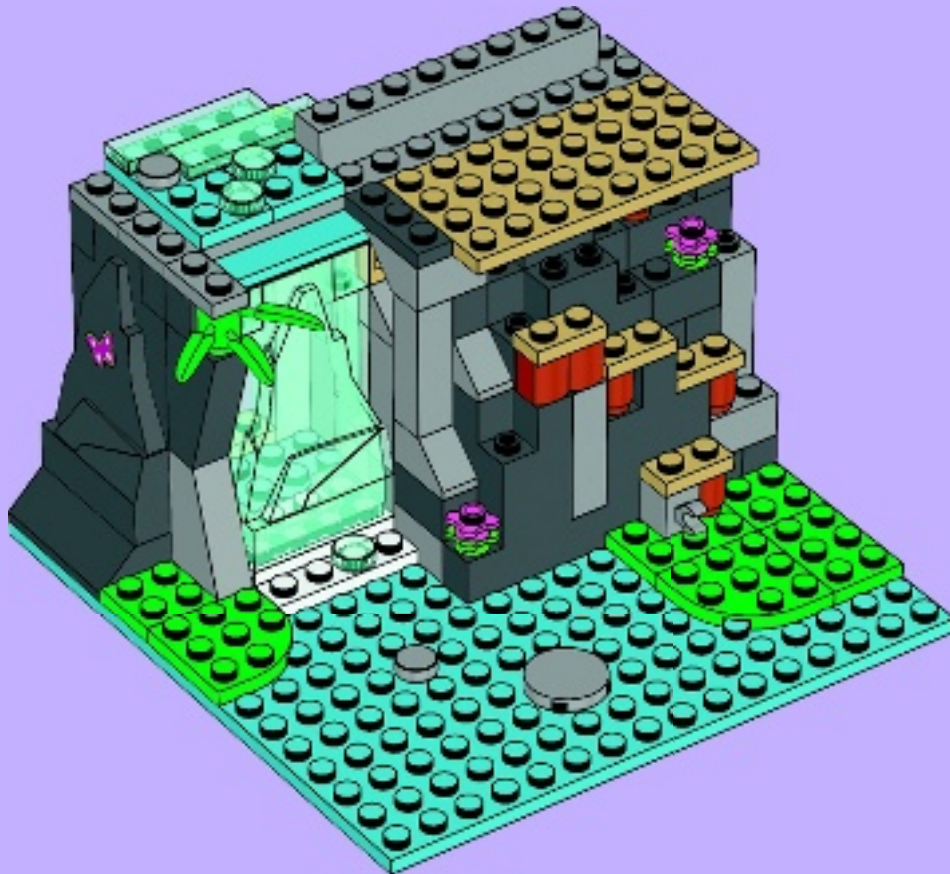

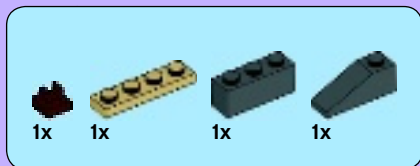

27

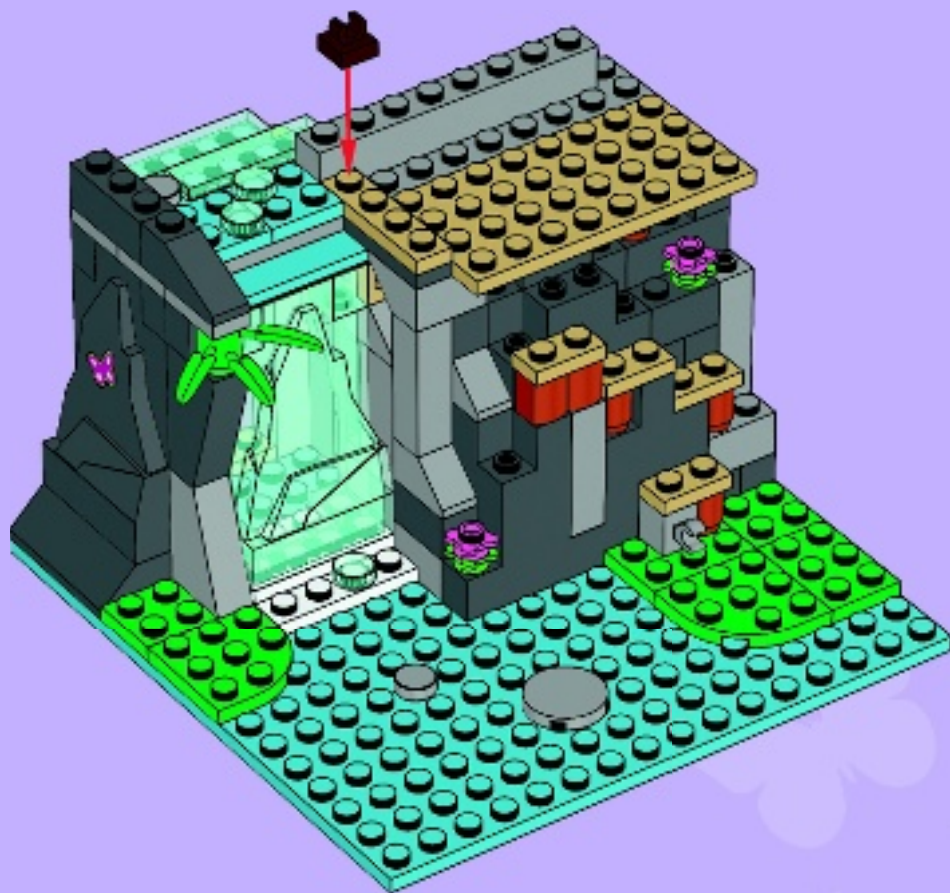



+



1x

1



4x

2

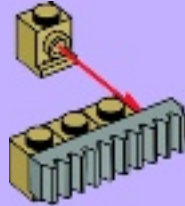



2x

3

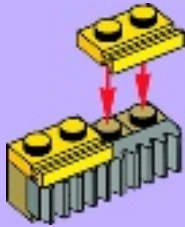

1x



1x

4

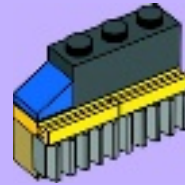

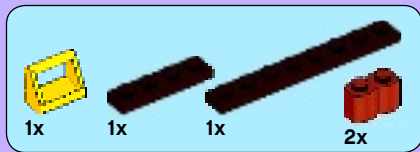

5

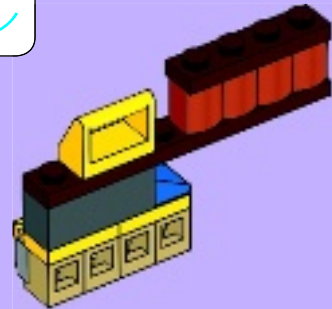
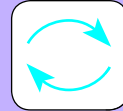
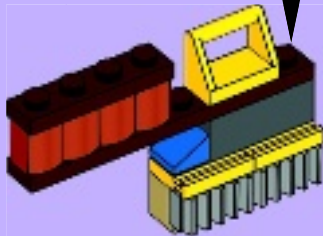
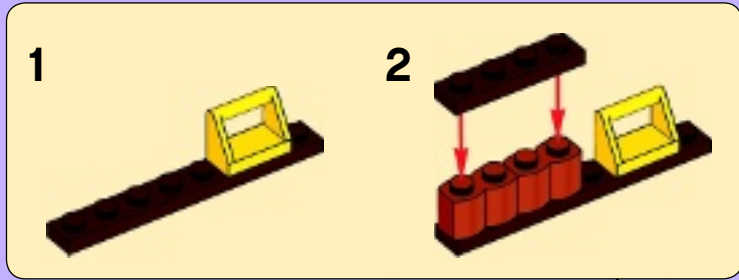

28

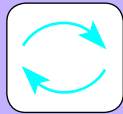



2x



1x

29

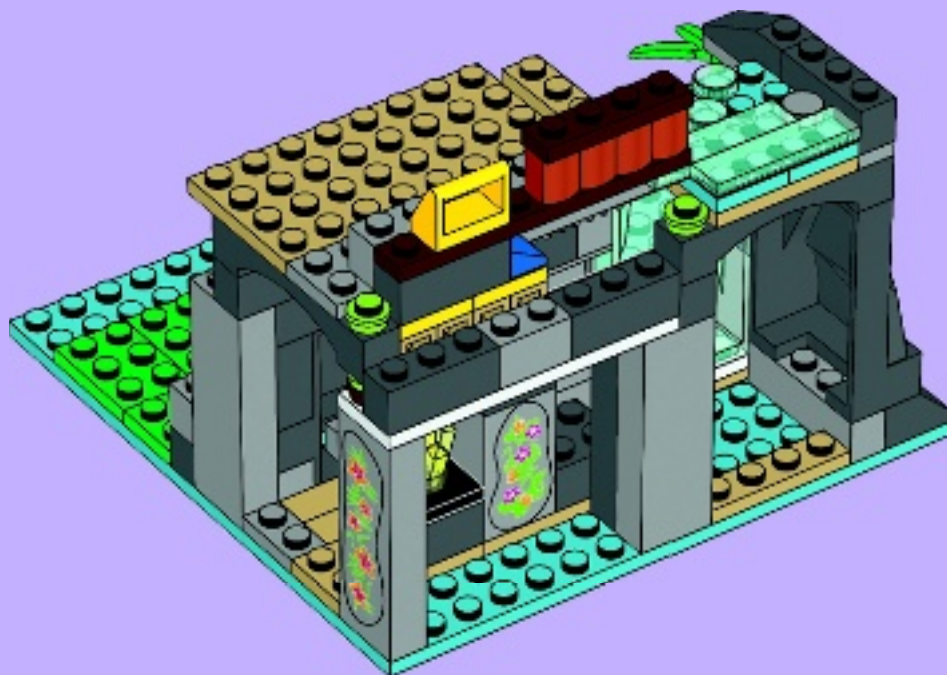

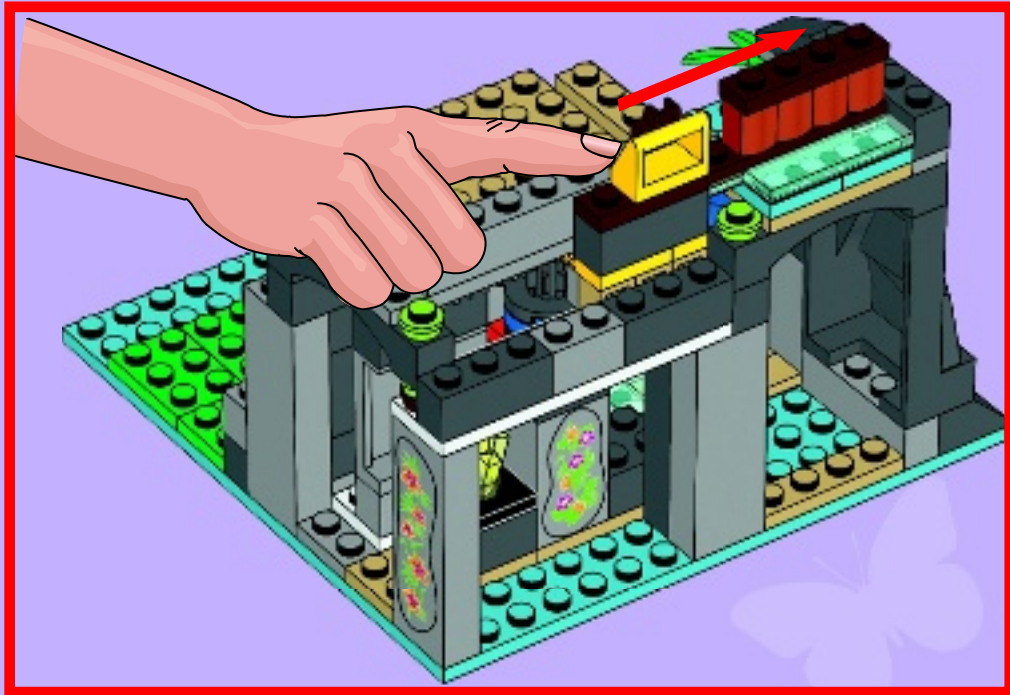

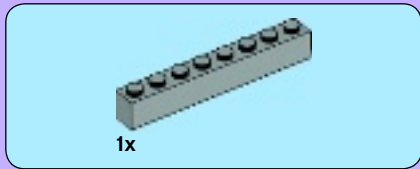

30

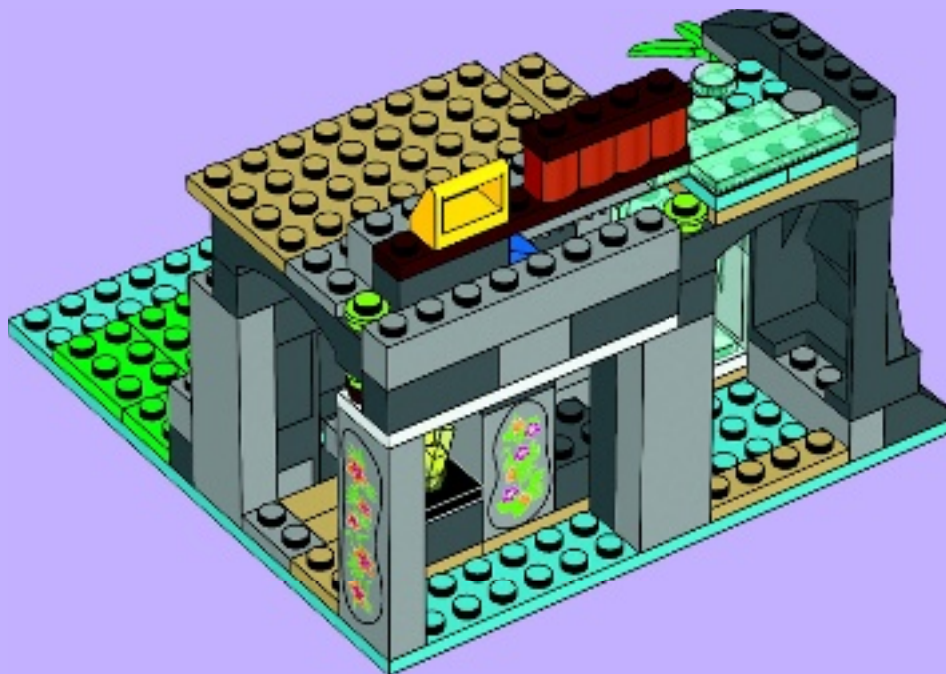

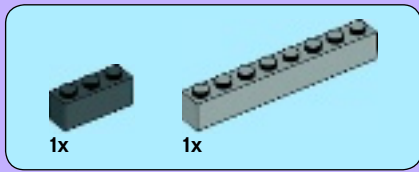

31

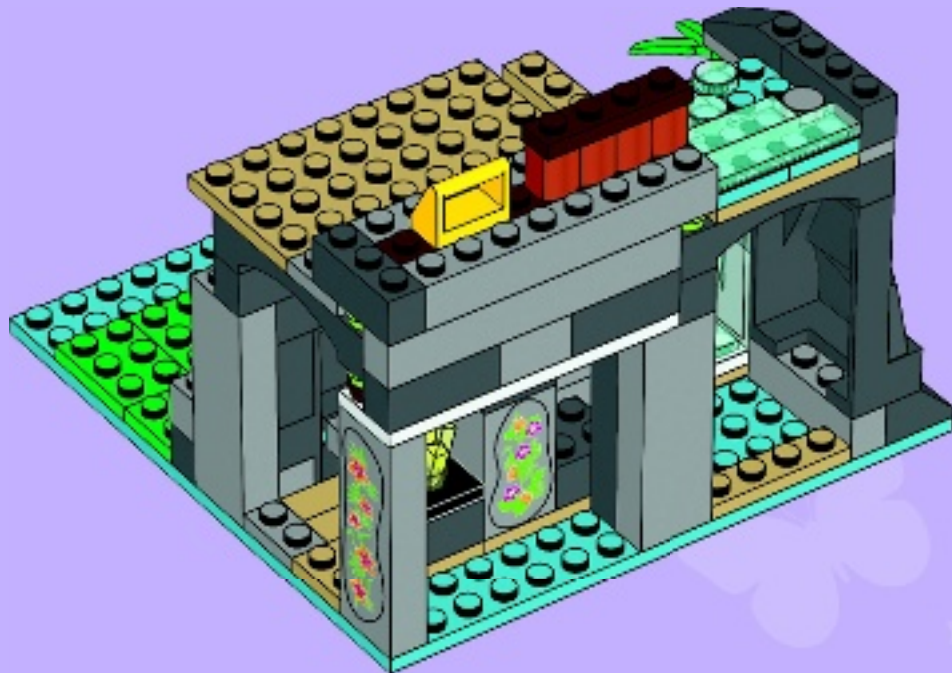



2x

32

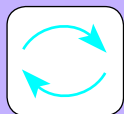

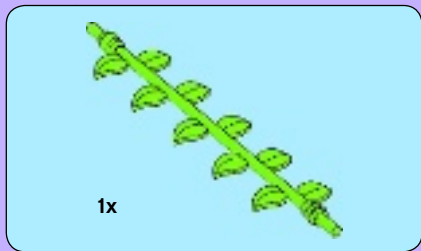

33





2x



2x

34

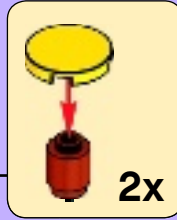



35

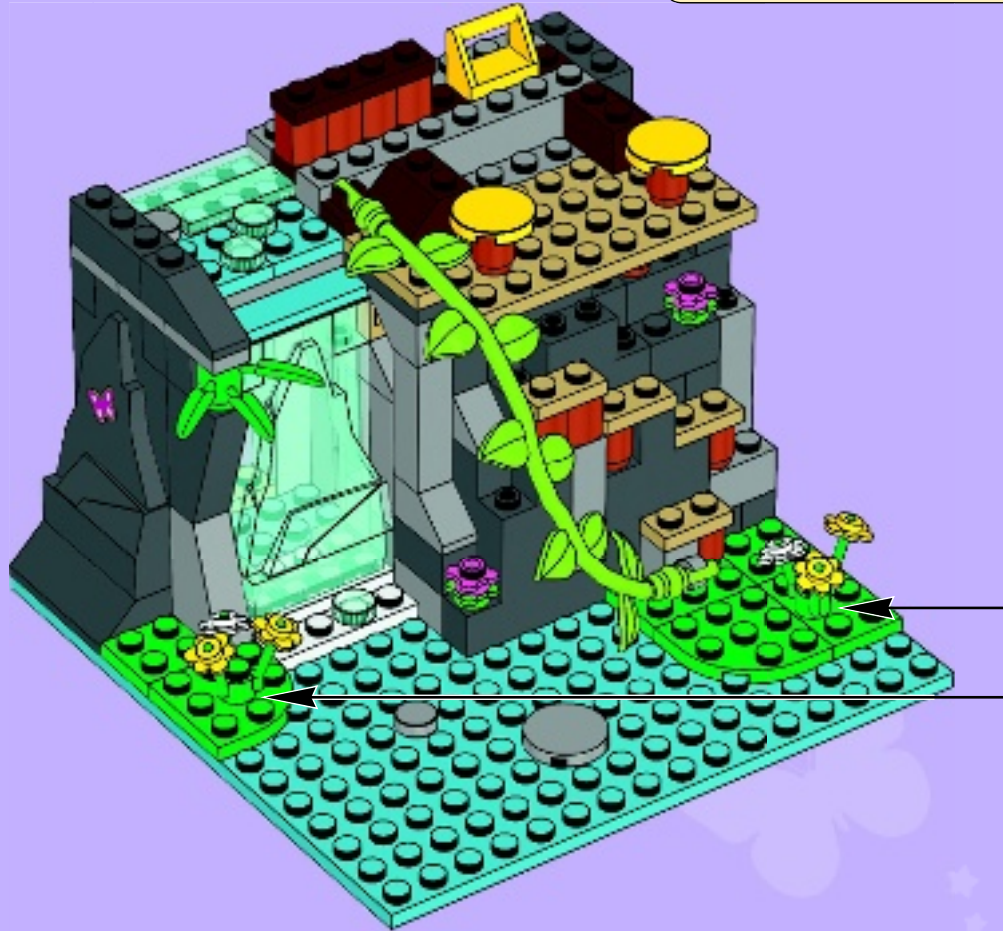



8x

36

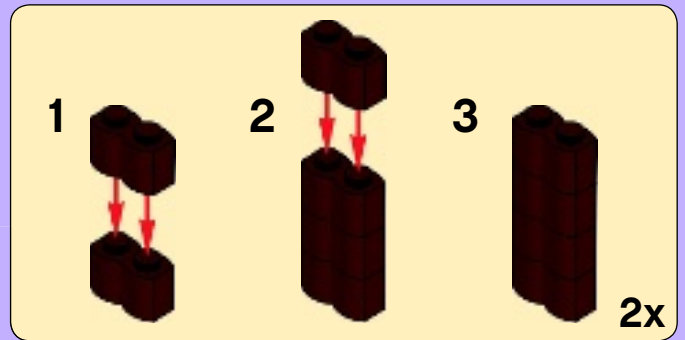
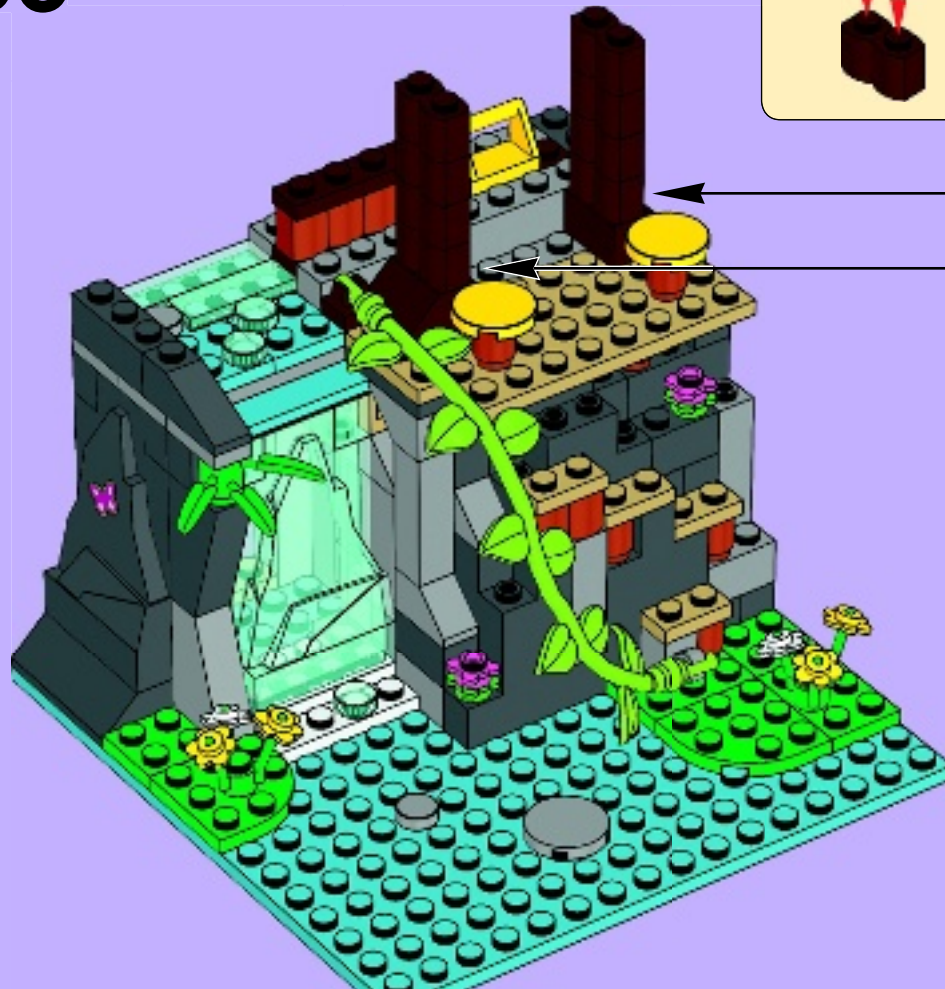

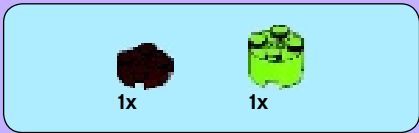

1



2

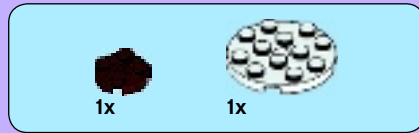

3

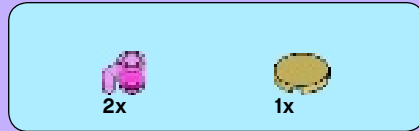

4



37





1x



1x

38



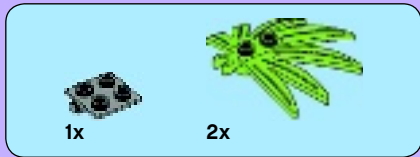

39



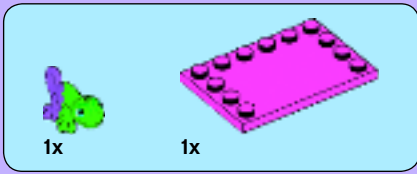

40

1

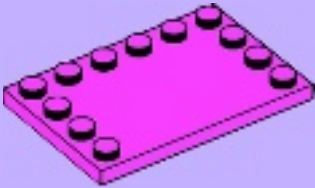

2



3







41

1



2

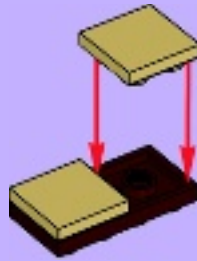

3

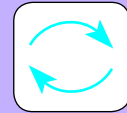





1x



1x



1x

42





1x
4186952



1x
6052202



1x
371001



2x
303401



1x
4515347



1x
4600294



8x
4118793



4x
4113917



2x
4113233



3x
4114309



4x
4157277



1x
4113993



1x
4509897



2x
6013081



1x
6066344



1x
4599537



1x
243224



2x
4141630



2x
6078279



1x
4565323



1x
416226



1x
393726



2x
302228



2x
302128



2x
6062166



2x
374128



2x
4114348



2x
4619599



1x
6086772



3x
4666352



6x
6074890



1x
368021



1x
6033019



2x
4586557



3x
6022171



2x
6052994



1x
4540417



2x
4527943



3x
4183133



2x
6023832



1x
4504380



1x
403223



1x
6074805



1x
6052284



8x
4211180



2x
4211202



1x
4211190



1x
4211186



1x
4216945



1x
6030720



1x
4216581



3x
4211159



1x
6024672



2x
4216479



3x
6061702

4x
4211388

3x
4211363

1x
4211650

3x
4211394

3x
4211392

1x
4535764

1x
4211494

3x
4211614

1x
4211436

3x
4211398

2x
4650260

1x
6052200



1x
6059033

1x
4540203

1x
4211881

2x
4211450

1x
4211815



1x
4210690

1x
4210978

4x
4211060

7x
4211104

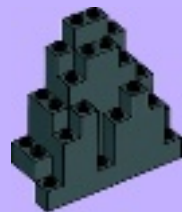
1x
4513326

1x
4216709

1x
4211096

1x
4500975

2x
4211045

1x
4211127

4x
4211098

2x
4620760

1x
4211133

1x
6055313

1x
6012451

1x
6096137

1x
6043921

1x
6073198



1x
6055590



2x
4655256

1x
6078339

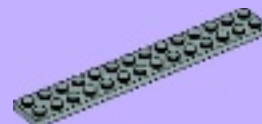
1x
4143404

1x
6074884

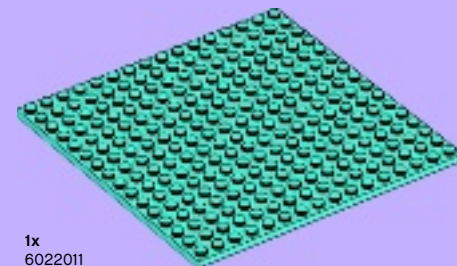
1x
4662161

1x
6022011

Customer Service
Kundenservice
Service Consommateurs
Servicio Al Consumidor
LEGO.com/service or dial

 : 00800 5346 5555
: 1-800-422-5346



Friends



LEGO

Friends



41033



41032

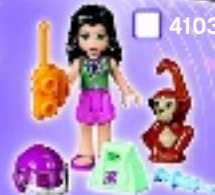

41038



41036





Friends



LEGO.com/friends

Apple, the Apple logo and iPad are trademarks of Apple Inc., registered in the U.S. and other countries. App Store is a service mark of Apple Inc. Apple, le logo Apple et iPad sont des marques de commerce d'Apple Inc., déposées aux États-Unis et dans d'autres pays. App Store est une marque et service d'Apple Inc. Apple, el logotipo de Apple e iPad son marcas comerciales de Apple Inc. registradas en EE. UU. y otros países. App Store es una marca de servicio de Apple Inc. Google Play is a trademark of Google Inc. Google Play est une marque de commerce de Google Inc. Google Play es una marca comercial de Google Inc.



Friends

41030



Heartlake City



41031



41034



41058





41058

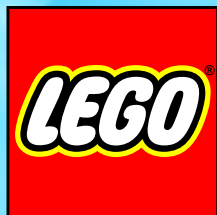

CREATOR

31019



WIN

GO TO WWW.LEGO.COM/PRODUCTFEEDBACK AND
GIVE US YOUR SHORT **FEEDBACK** ABOUT THIS
LEGO® SET FOR A CHANCE TO WIN
A COOL LEGO PRIZE.



LEGO.com/productfeedback

GEWINNE



Erzähle uns auf
www.LEGO.com/productfeedback

etwas über die Erfahrungen, die du mit
diesem LEGO® Set gemacht hast, und
sichere dir die Chance auf einen coolen
LEGO Preis!

GAGNE



Rends-toi sur
www.LEGO.com/productfeedback

et donne-nous quelques commentaires
sur ce produit LEGO® pour avoir une
chance de gagner un prix LEGO !

GANAN



Visita
www.LEGO.com/productfeedback

y envíanos tu opinión acerca de este set
LEGO®. ¡Participarás en el sorteo de un
premio LEGO!

获取奖品



登录
www.LEGO.com/productfeedback

给出关于此乐高®套装的简短反馈，
就有机会获得炫酷乐高奖品