



# CREATOR

31015



31020



31022



31025



**3** IN **1**



1



2

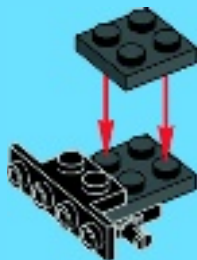

3



4



5



1

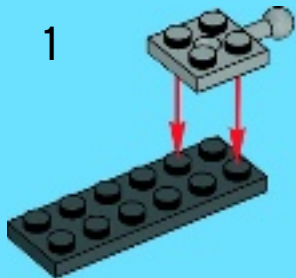

2

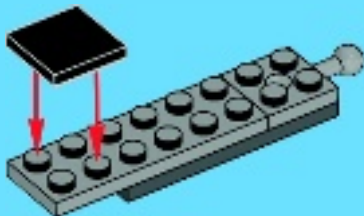

6

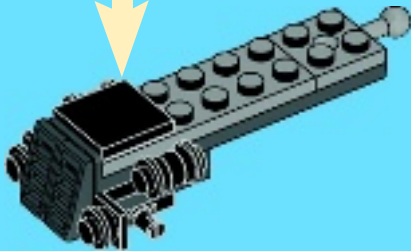

7

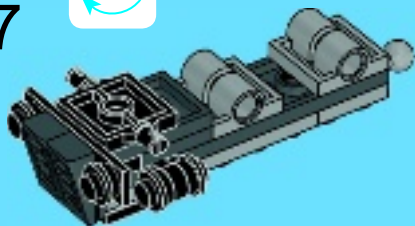

8

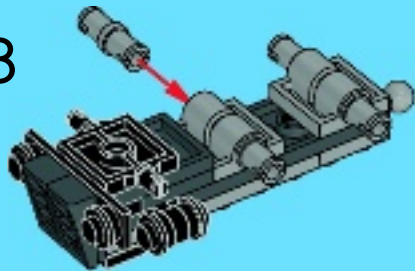

9

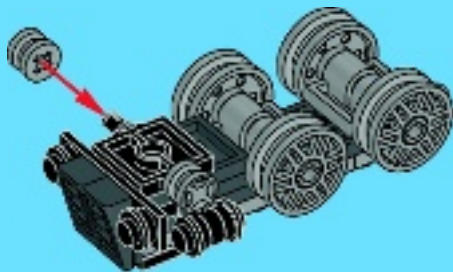

1

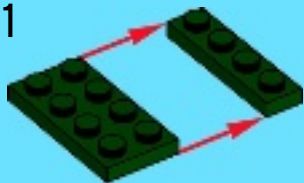

2



3



4



10

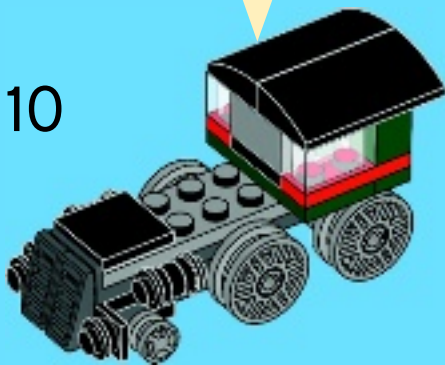



1



2





3



4



5



6



11

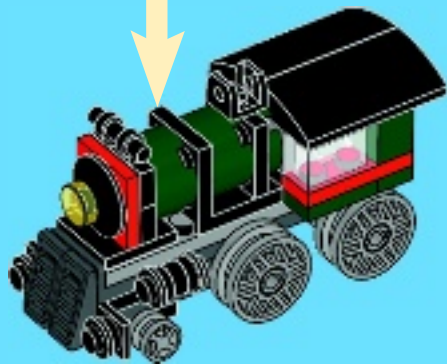

1



2



12

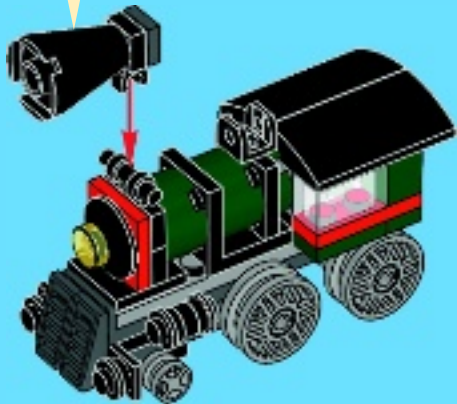

13

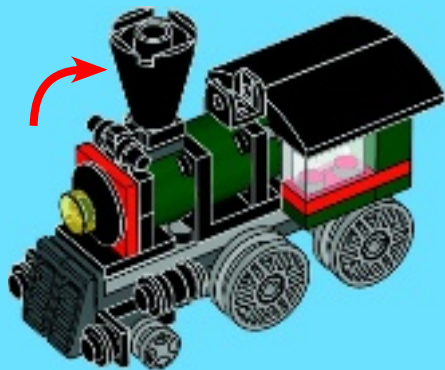



1



2

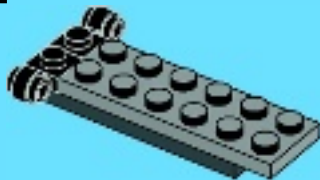

3

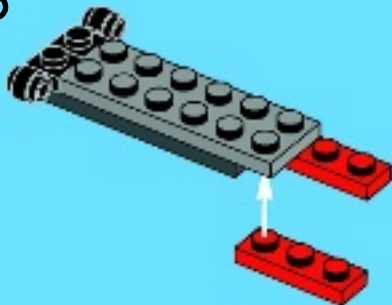

4



5



1



2

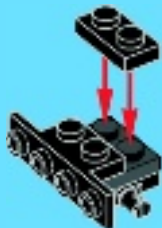

3





4



6

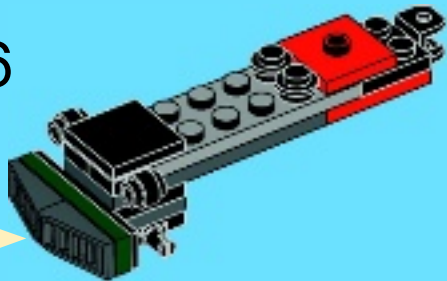



7

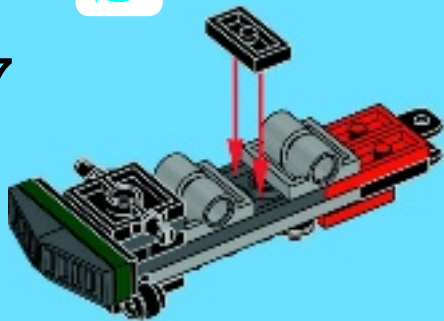

8

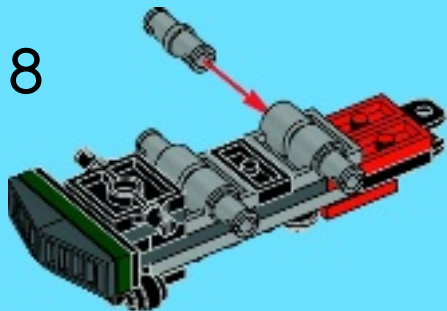

9

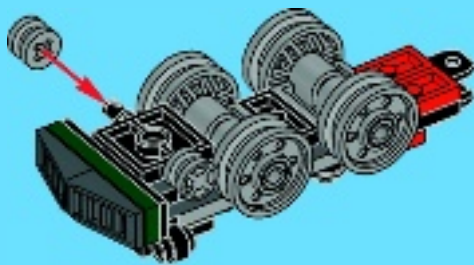

1



2



3



10

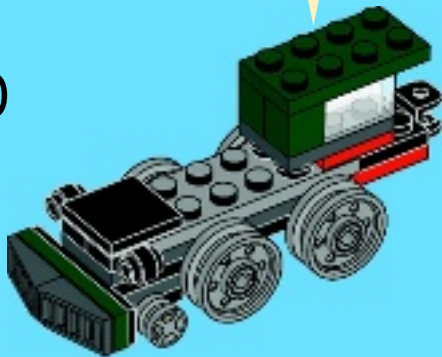



1



2



3



4

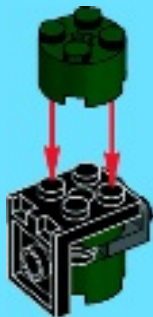

5





6



11

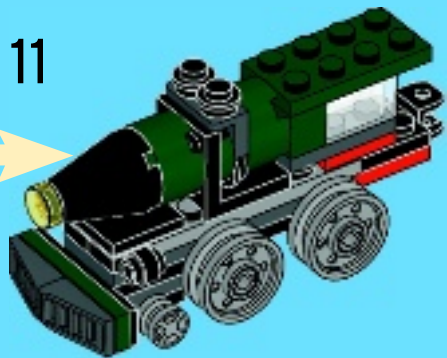



1

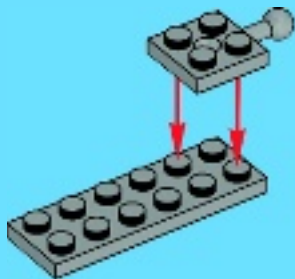

2





3



1



2



2x

4

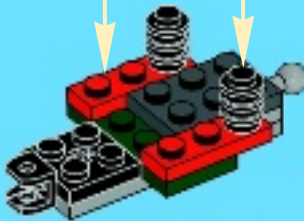

5



6



7

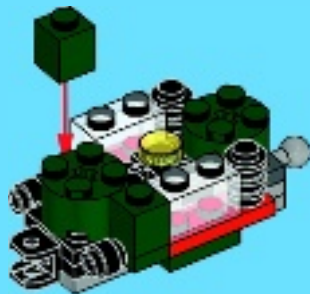

8

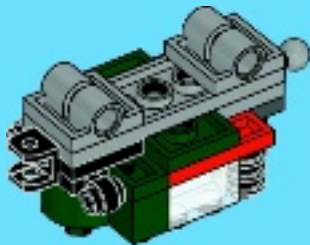

9



10

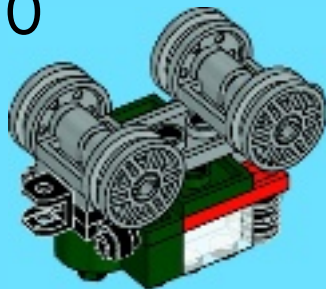



11





1x  
4581308



2x  
362321



2x  
306540



1x  
4650500



1x  
6022160



2x  
4587844



2x  
302326



1x  
306826



1x  
4517925



2x  
4632571



1x  
4140588



1x  
4529064



1x  
6019217



1x  
4282746



6x  
614126



1x  
474026



1x  
460026



2x  
4521915



2x  
6055770



1x  
6020923



1x  
6035029



1x  
4586057



1x  
4211388



1x  
4211452



2x  
4211376



1x  
6063611



2x  
4211506



4x  
6044729



4x  
4211807



1x  
4210848



1x  
4211094



1x  
4211043



1x  
4211002



1x  
6000606



2x  
4540386



**Customer Service**

**Kundenservice**

**Service Consommateurs**

**Servicio Al Consumidor**

**LEGO.com/service or dial**



**00800 5346 5555 :**



**1-800-422-5346 :**





# CREATOR

31025



[LEGO.com/creator](http://LEGO.com/creator)



# WIN!

Go to [LEGO.com/productfeedback](http://LEGO.com/productfeedback) to fill out a survey for a chance to win a cool LEGO® Product.

No purchase necessary.

Open to all residents where not prohibited.



## LEGO.com/productfeedback

### GEWINNE!

Nimm an der Umfrage auf [LEGO.com/productfeedback](http://LEGO.com/productfeedback) teil und hab die Chance ein cooles LEGO® Produkt zu gewinnen!

Die Teilnahme am Gewinnspiel führt zu keinerlei Kaufverpflichtungen. Teilnahme in allen nicht ausgeschlossenen Ländern möglich.

### WIN!

Ga naar [LEGO.com/productfeedback](http://LEGO.com/productfeedback), vul een enquêteformulier in en maak kans op een cool LEGO® product.

Geen aankoopverplichting. Ledereen mag deelnemen, uitgezonderd ingezetenden van landen waar een enquêteverbod geldt.

### GAGNE !

Visite [LEGO.com/productfeedback](http://LEGO.com/productfeedback) pour répondre à un questionnaire et avoir une chance de gagner un produit LEGO® très cool !

Aucune obligation d'achat. Ouvert à tous les résidents des pays autorisés.

### 当てよう!

[LEGO.com/productfeedback](http://LEGO.com/productfeedback) にアクセスして、アンケートにご記入ください。当選者にはレゴ®製品を差し上げます。

お買い上げの必要はありません。禁止されていない限り、すべての皆様にご利用いただけます。



6071644 / 6071649

LEGO and the LEGO logo are trademarks of the/sont des marques de commerce de/son marcas registradas de LEGO Group. ©2014 The LEGO Group.