



# STAR WARS

75000



1



2



3



4



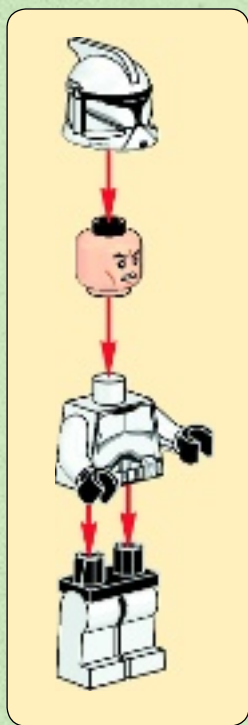

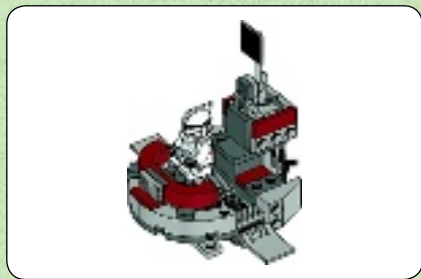

1

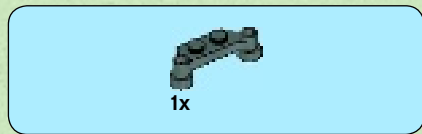
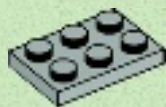

2

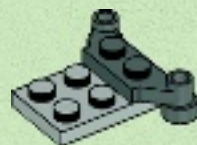



3

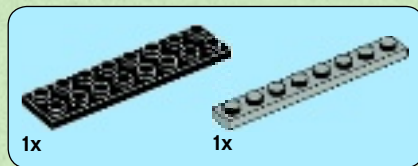

4

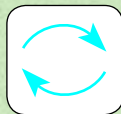



5

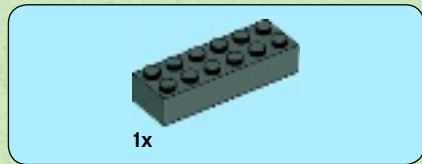
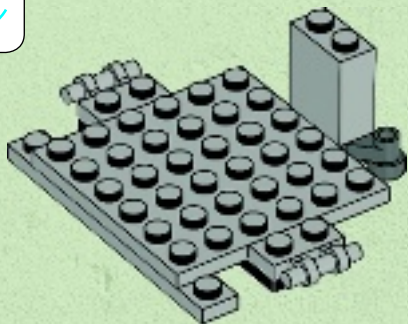
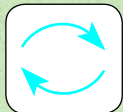

6

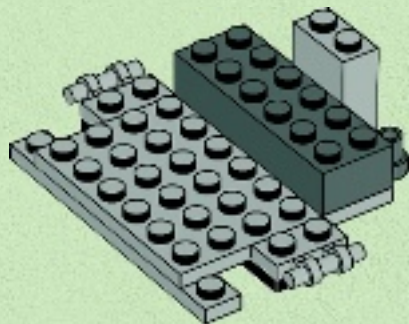



1x

7

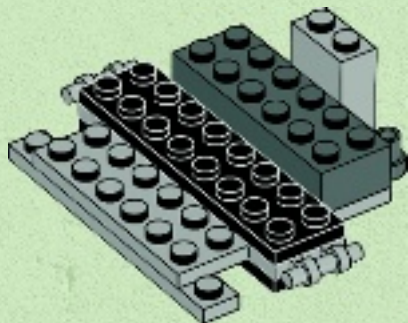

2x

8

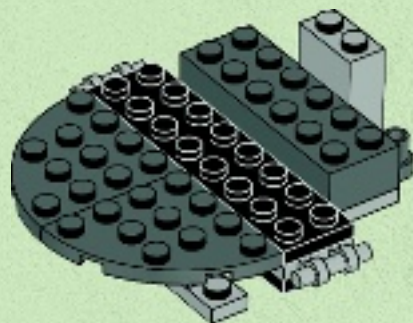



2x



2x

9

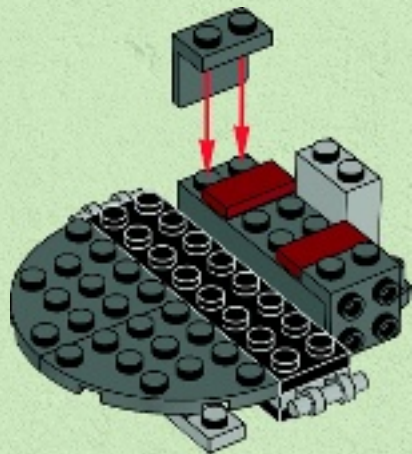

1x



2x

10

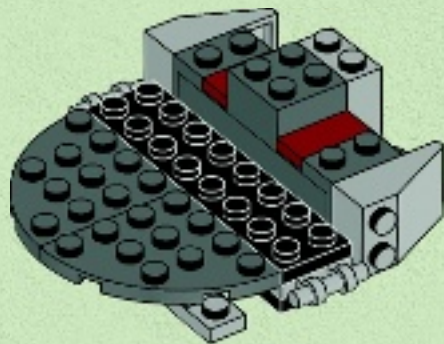





11

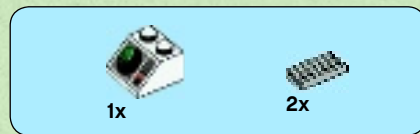
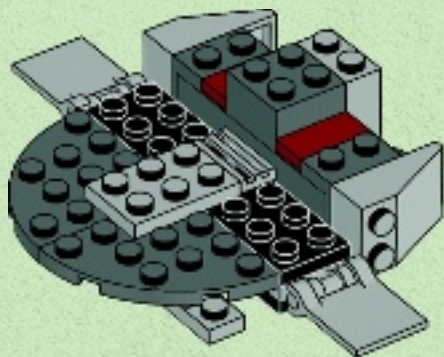

12

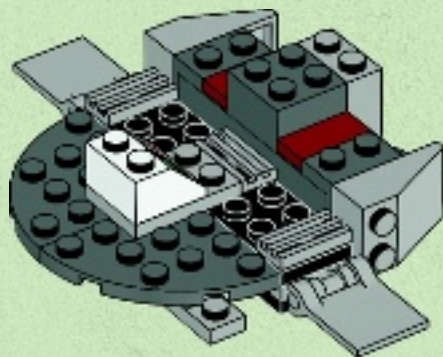



2x

13

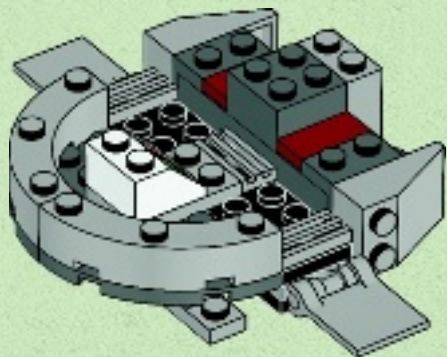

2x



1x

14

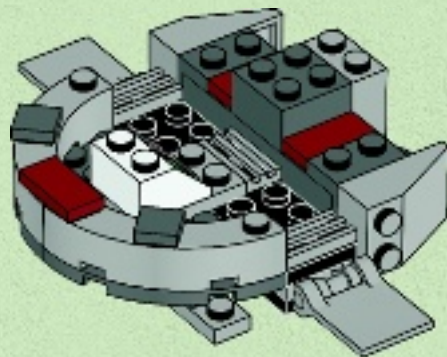



1x



1x

# 15

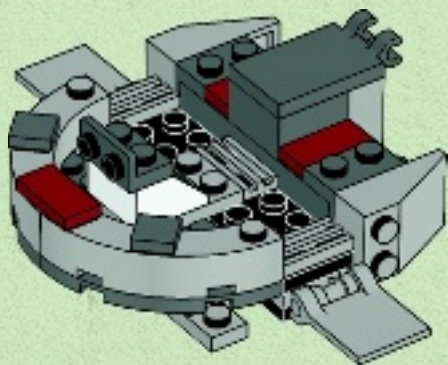

2x

# 16

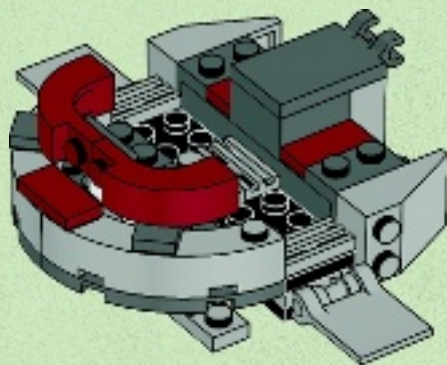



1x



1x

# 17

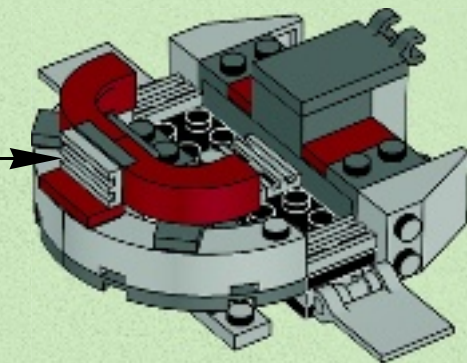
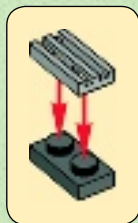



1x

1



1x



1x

2



2x

3

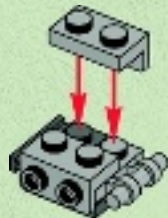



1x

4

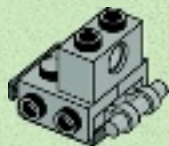

2x

5

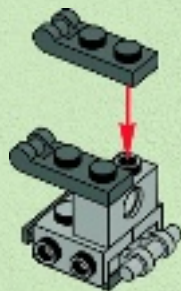



2x

6

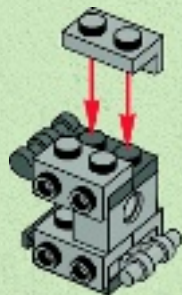

2x



2x

7





1x

8

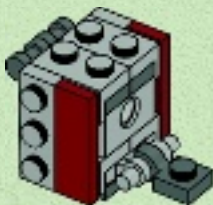

1x



1x



1x

9

1

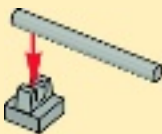

2

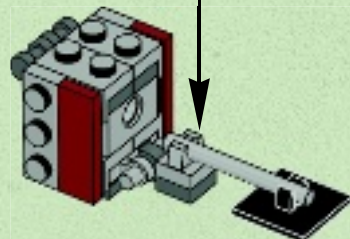
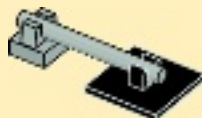





1x



1x

10

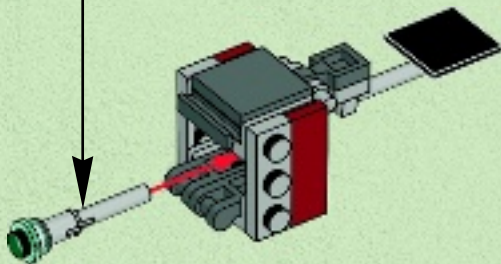
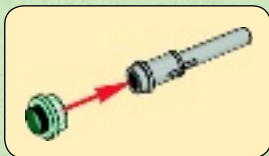
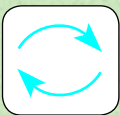

18

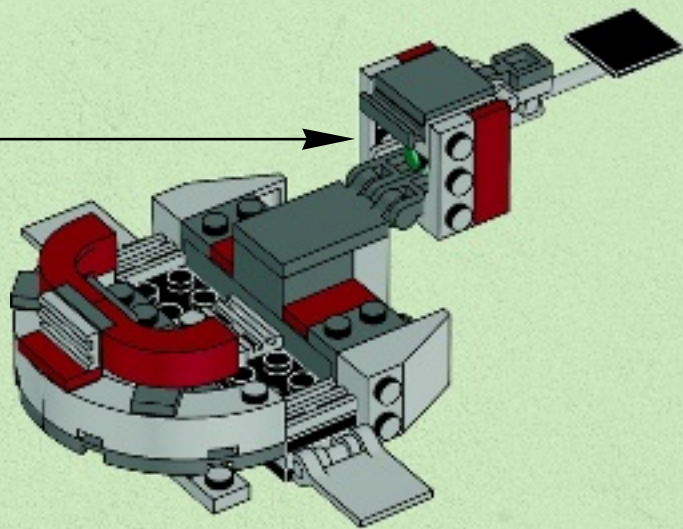

19

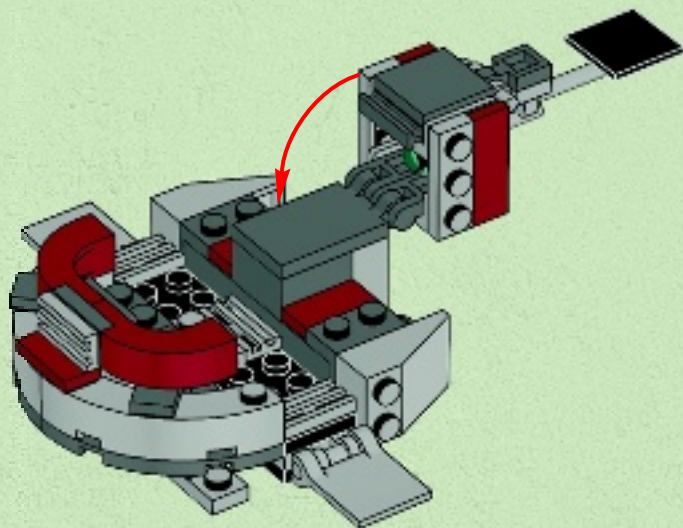

20

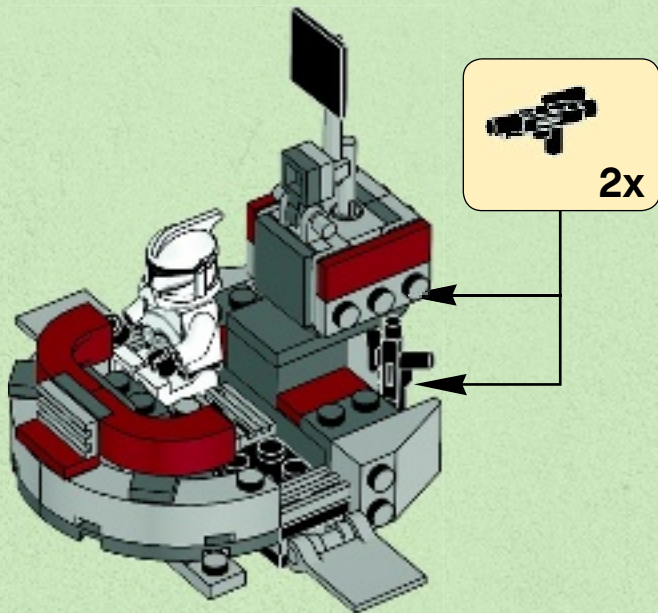



1

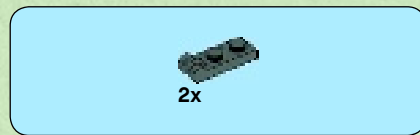

2

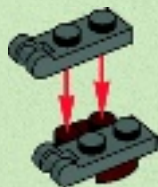

3

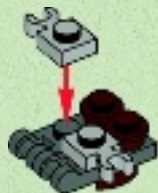



2x

4



1x

5





3x

6



3x



1x

7



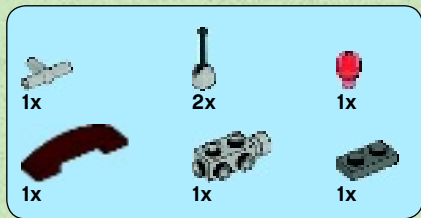

8

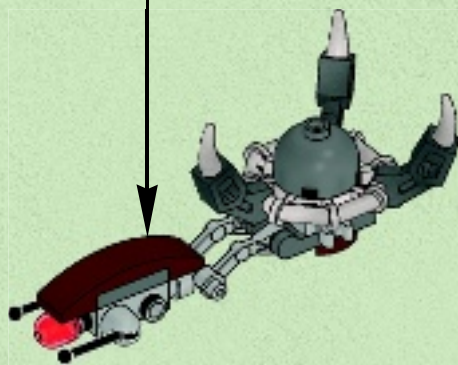
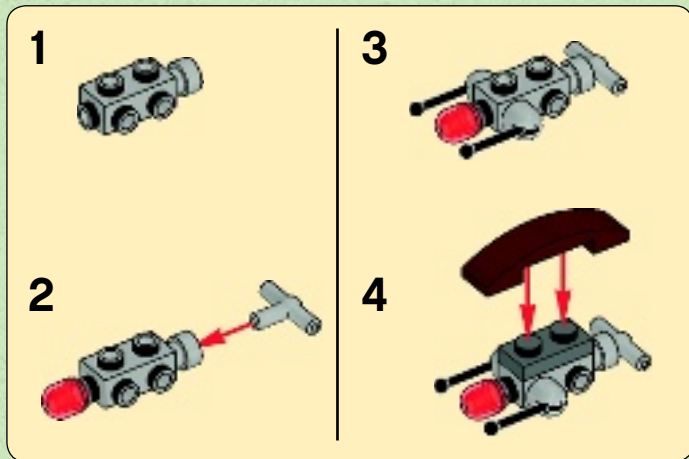





9

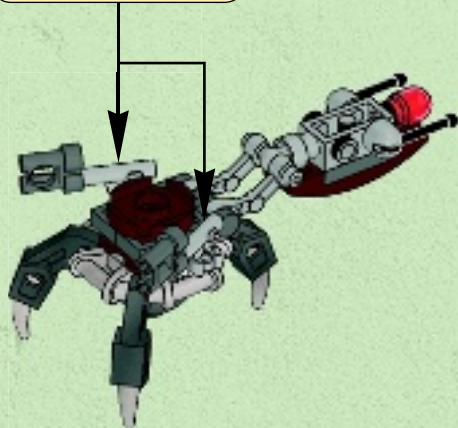
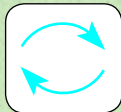
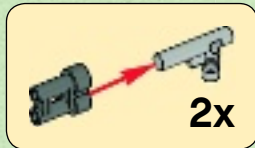

2x





1x  
4261941



2x  
74326



1x  
6022144



1x  
6021562



1x  
6021251



1x  
6021630



2x  
303426



1x  
4547041



2x  
4498713



2x  
4497943



1x  
4163917



2x  
6028713



3x  
4539090



2x  
4583299



2x  
4658005



4x  
4216581



2x  
4211159



1x  
4211564



2x  
4211502



2x  
4215472



1x  
4211440



2x  
4211421



2x  
4211429



2x  
4211396



1x  
4211425



1x  
4211474



1x  
6030711



4x  
4594238



4x  
4211350



4x  
4654582



3x  
4211632



4x  
4221775



2x  
6011817



1x  
4211628



4x  
4211658



4x  
4514195



1x  
4520320



2x  
4211508



1x  
6021060



1x  
4210875



2x  
4161674



3x  
4211063



2x  
4210848



1x  
4579354



2x  
4277928



1x  
6000606



1x  
4543086



1x  
6013082



6x  
4521187



1x  
4217558



1x  
4227517



2x  
4222042



1x  
4211124



4x  
4211051



2x  
6020990



6x  
4612901



6x  
6008484



2x  
6021888



**Customer Service**  
**Kundenservice**  
**Service Consommateurs**  
**Servicio Al Consumidor**  
**LEGO.com/service or dial**



**: 00800 5346 5555**  
**: 1-800-422-5346**

# LEGO.com/starwars



s4yh3y



Internet Connection Required  
Internetverbindung erforderlich  
Connexion Internet requise  
Se requiere conexión a Internet  
Requer ligação à Internet  
Internetkapcsolat szükséges



75000



75000



75001



75001



75001



75001



75002



75002



75002



75003



75003



75003



75004



75005



75005



75004



75004



75005



75005



75000



75001



75003



75002



75004



75005

1



2



3



www.LEGOclub.com/Max

www.LEGOclub.com/Max

LEGO club™

FREE\*! GRATIS! GRATUIT!

\*Paid subscription in Australia and New Zealand.
\*Abonnement payant en Australie et Nouvelle-Zélande.

©2013 The LEGO Group.



LEGO club MAGAZINE

WHO IS THE GREEN NINJA?



# WIN!

Go to [www.LEGOsurvey.com/product](http://www.LEGOsurvey.com/product) to fill out a survey for a chance to win a cool LEGO® Product.

No purchase necessary.

Open to all residents where not prohibited.



## [www.LEGOsurvey.com/product](http://www.LEGOsurvey.com/product)

### GEWINNE!

Nimm an der Umfrage auf [www.LEGOsurvey.com/product](http://www.LEGOsurvey.com/product) teil und hab die Chance ein cooles LEGO® Produkt zu gewinnen!

Die Teilnahme am Gewinnspiel führt zu keinerlei Kaufverpflichtungen. Teilnahme in allen nicht ausgeschlossenen Ländern möglich.

### WIN!

Ga naar [www.LEGOsurvey.com/product](http://www.LEGOsurvey.com/product), vul een enquêteformulier in en maak kans op een cool LEGO® product.

Geen aankoopverplichting. Iedereen mag deelnemen, uitgezonderd ingezetenden van landen waar een enquêteverbod geldt.

### GAGNE!

Visite [www.LEGOsurvey.com/product](http://www.LEGOsurvey.com/product) pour répondre à un questionnaire et avoir une chance de gagner un produit LEGO® très cool!

Aucune obligation d'achat. Ouvert à tous les résidents des pays autorisés.

### 当てよう!

[www.LEGOsurvey.com/product](http://www.LEGOsurvey.com/product) にアクセスして、アンケートにご記入ください。当選者にはレゴ®製品を差し上げます。

お買い上げの必要はありません。禁止されていない限り、すべての皆様にご利用いただけます。



LEGO.com

6035382

LEGO and the LEGO logo are trademarks of the LEGO Group. ©2013 The LEGO Group. © 2013 Lucasfilm Ltd. & TM. All rights reserved.