



# NINJAGO

Masters of Spinjitzu



70505



**GOLDEN NINJA  
INCLUDED**



1

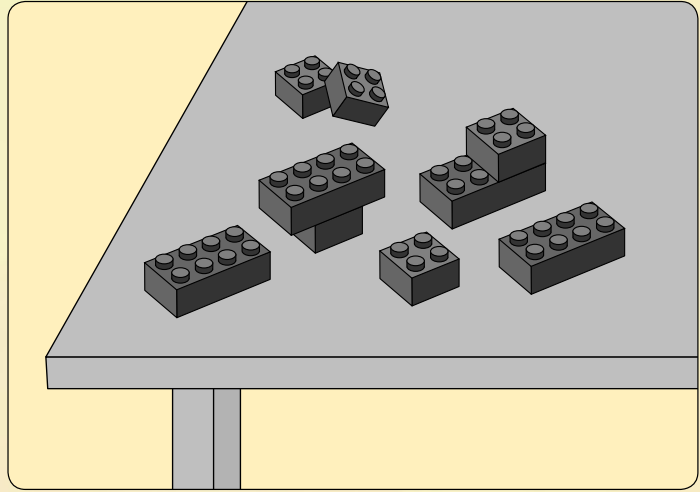
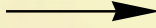
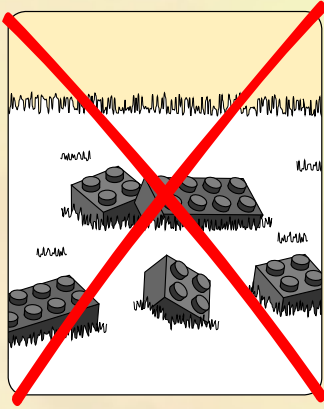

2



<http://lego.com/brickseparator>



**GOLDEN NINJA INCLUDED  
GOLDENER NINJA ENTHALTEN  
NINJA D'OR INCLUS  
INCLUYE AL NINJA DORADO  
NINJA DOURADO INCLUIDO  
ARANY NINZSA A DOBOZBAN**





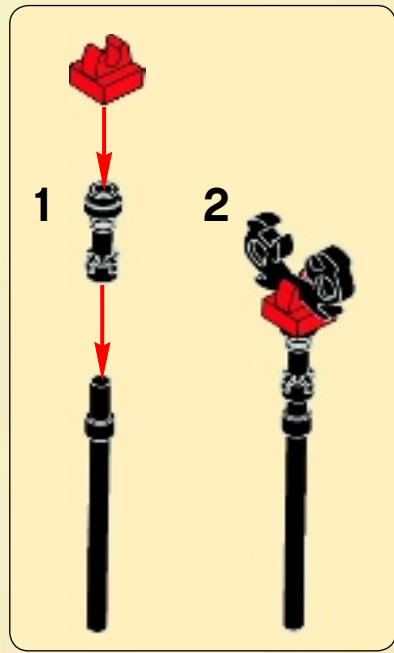



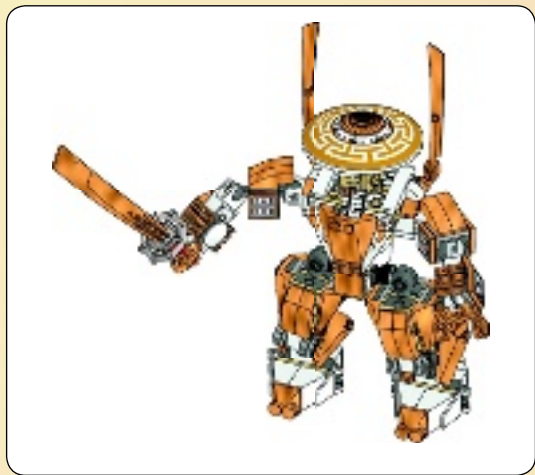

1x

**1**

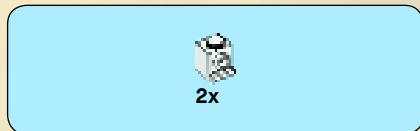

2x

**2**





2x



1x

# 3



4x

# 4



1x



2x

# 5





1x

6

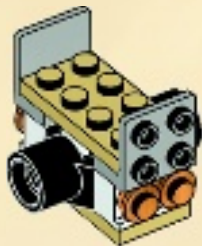

2x

7

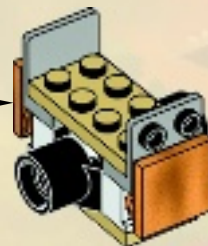

1x

8







1x

9



1x

10





2x



4x

# 11



2x

# 12

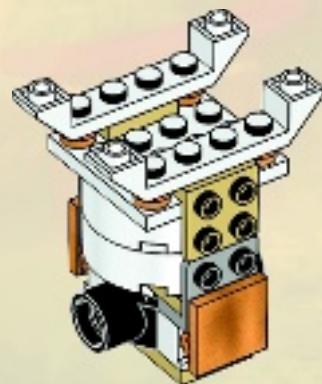



# 13

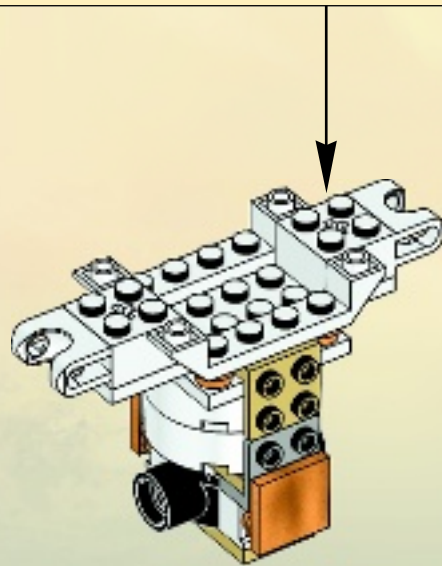
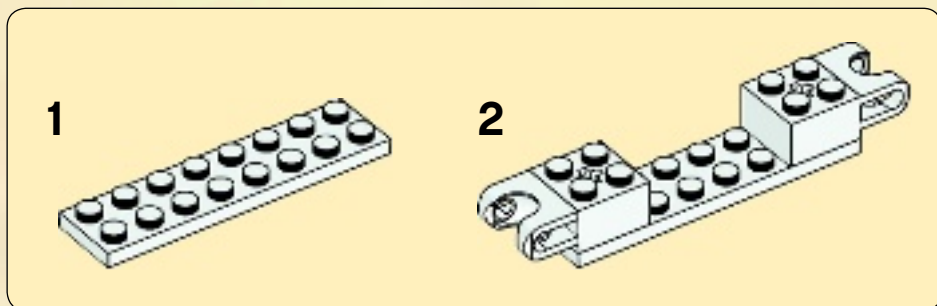





8x

# 14

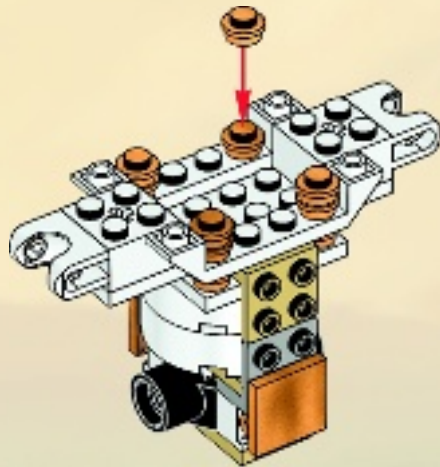

2x



4x

# 15

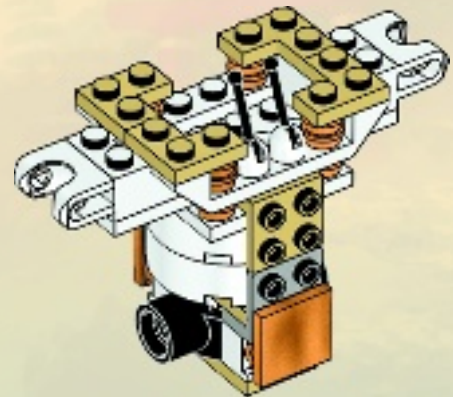



4x

# 16

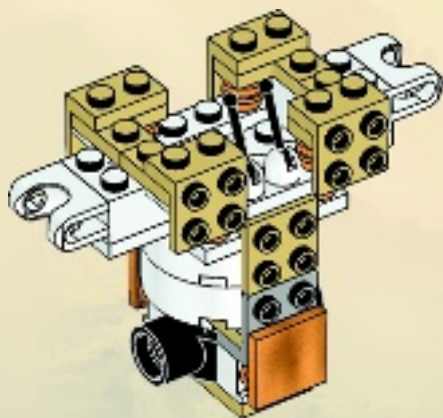

2x

# 17

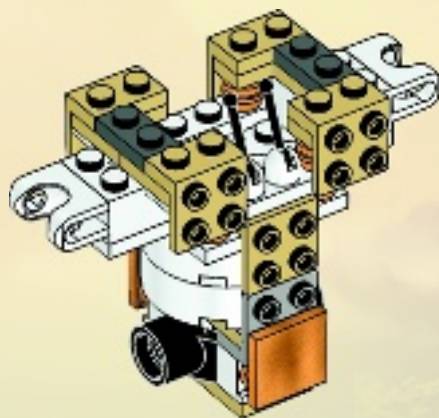



2x

18

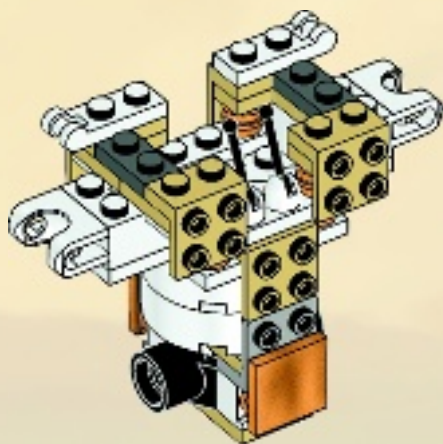

2x

19

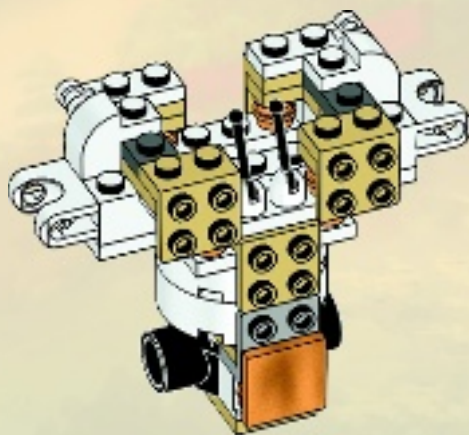





2x



2x

# 20

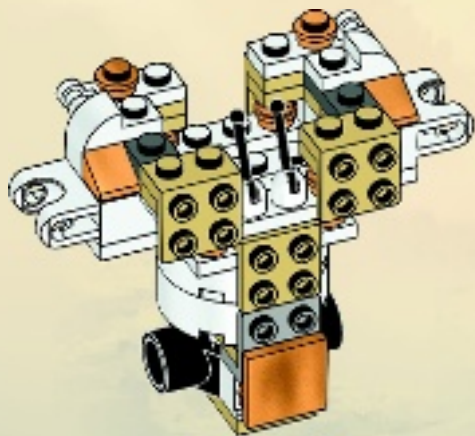

2x

# 21

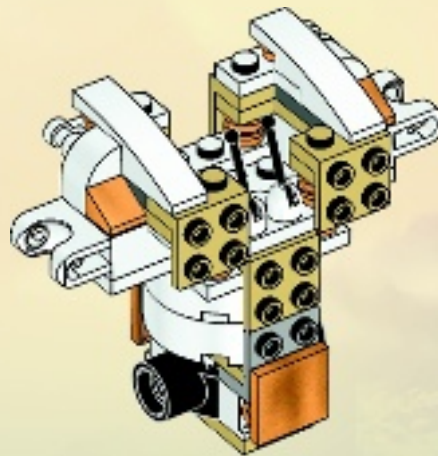



1x

# 22

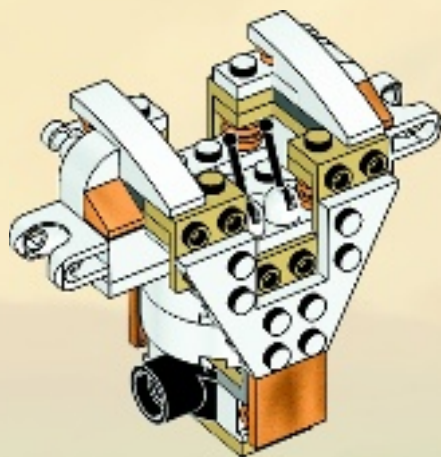

1x



2x

# 23

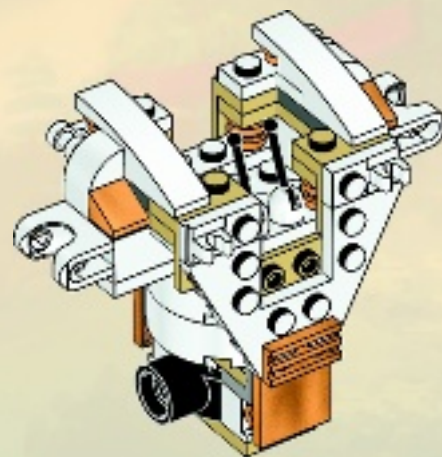

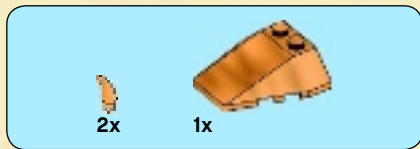

24

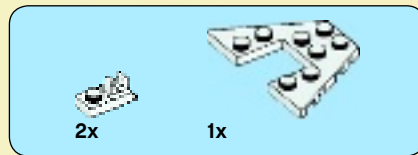
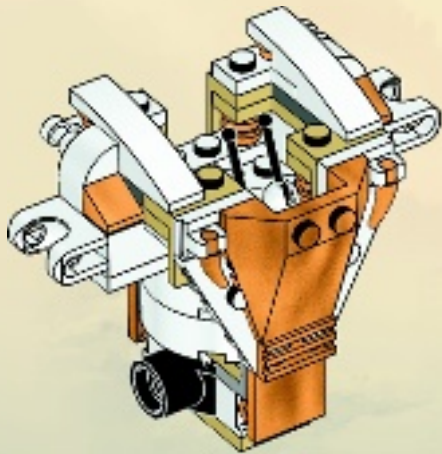

25

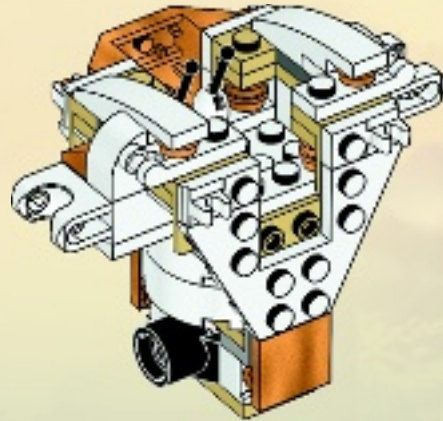
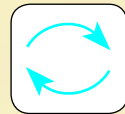





26

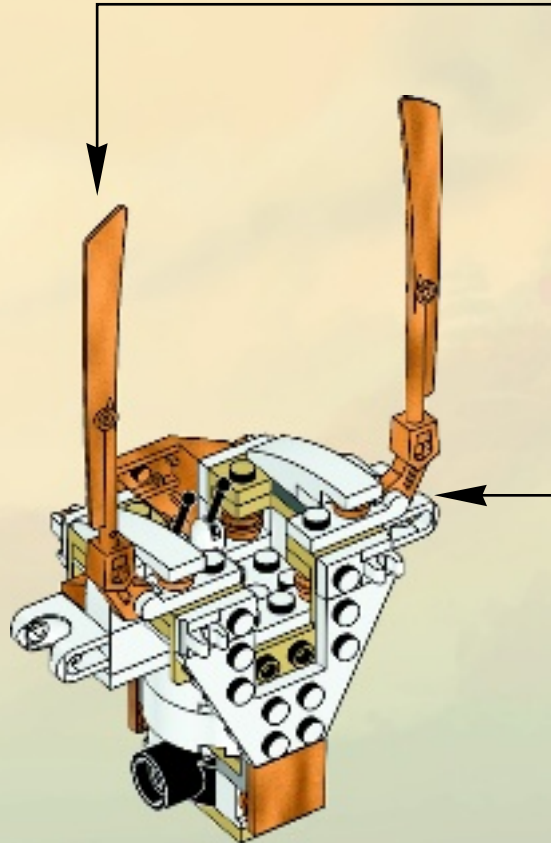
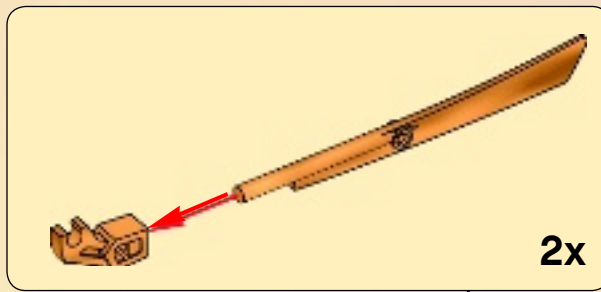

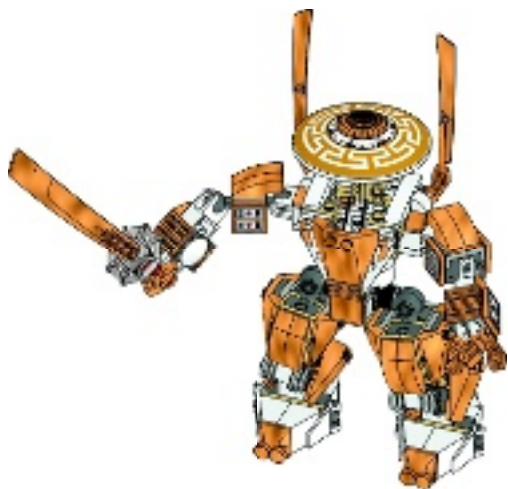

2x

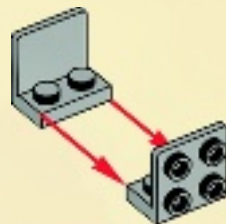

1x

2



2x

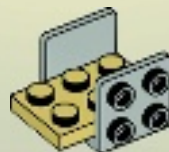



3

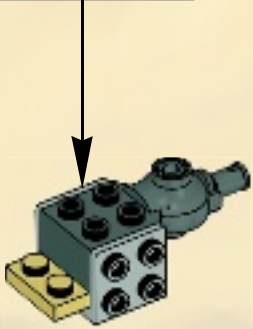
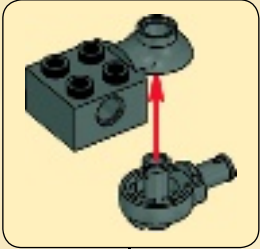

4



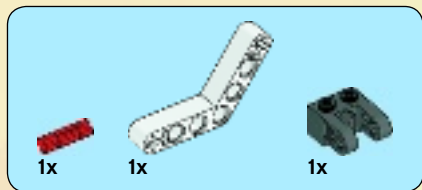

5

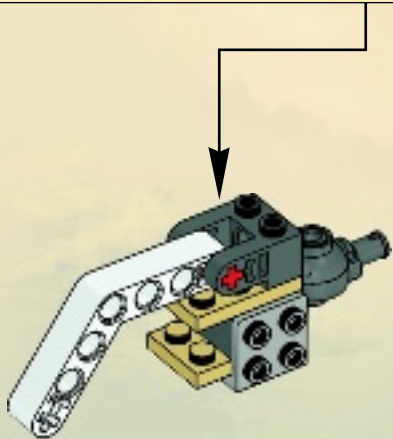
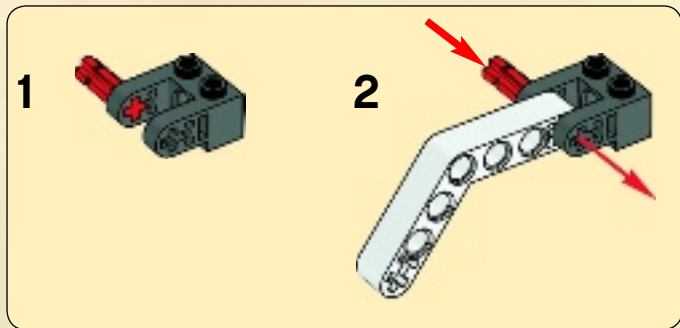

6

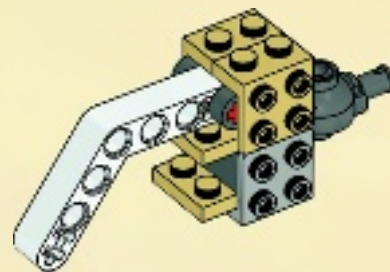

7

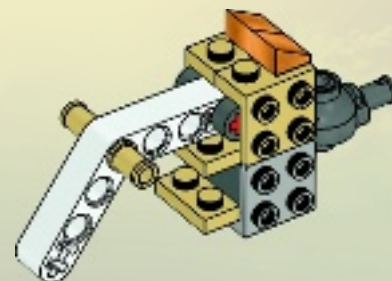

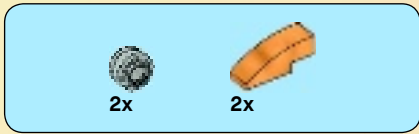

8

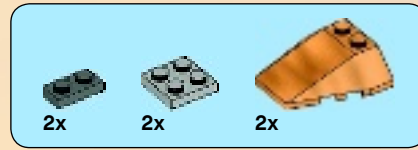
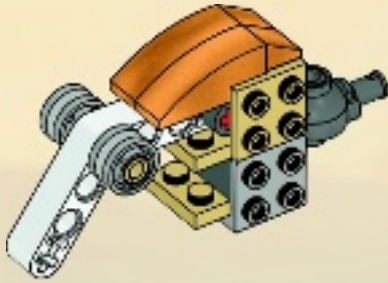

9

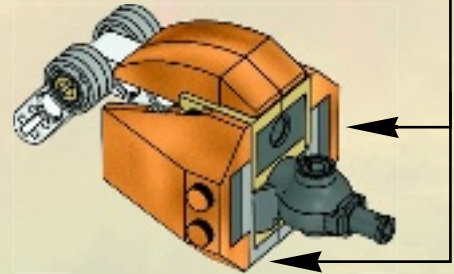





2x

1

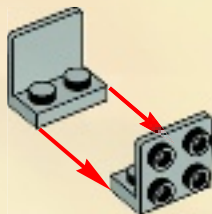

1x

2



1x

3

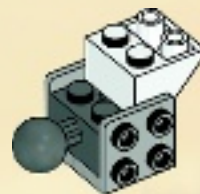



1x

4



1x

5





1x

6

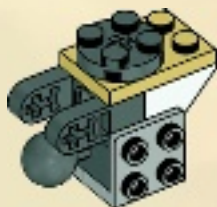

2x

7





1x



1x

8

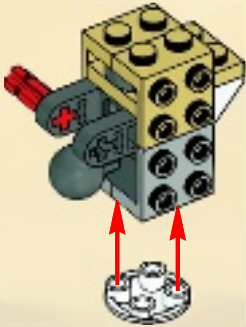

9

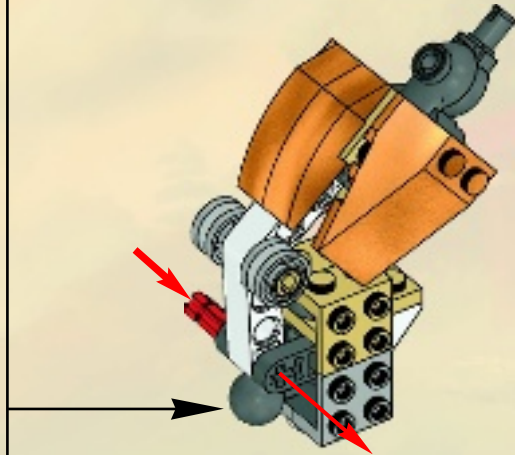



2x

1

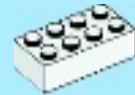
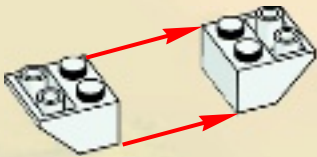

1x

2

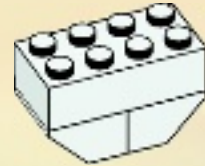



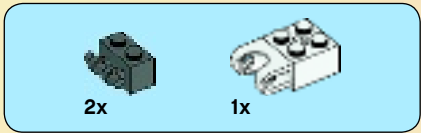

3



4





2x

5

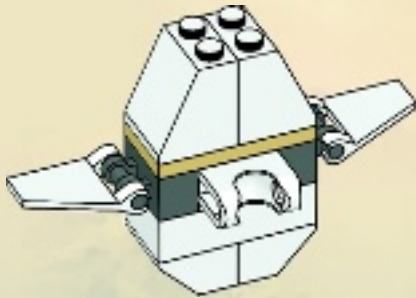

1x

6

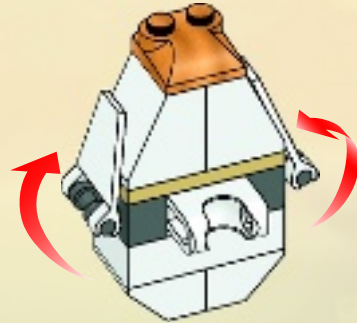



1x



2x

# 7

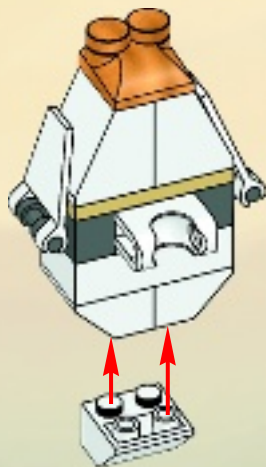

# 8

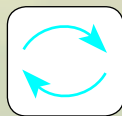
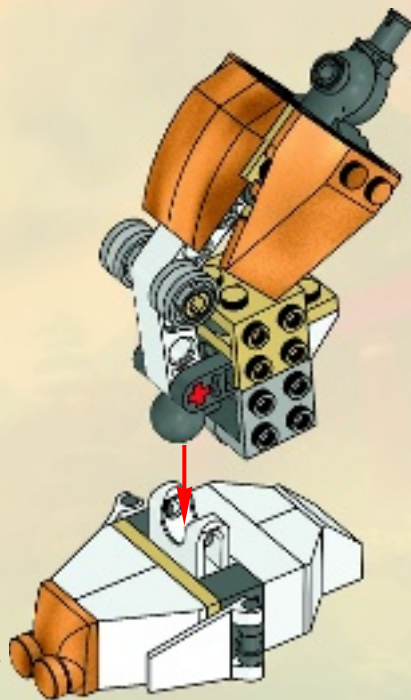



2x

9



2x

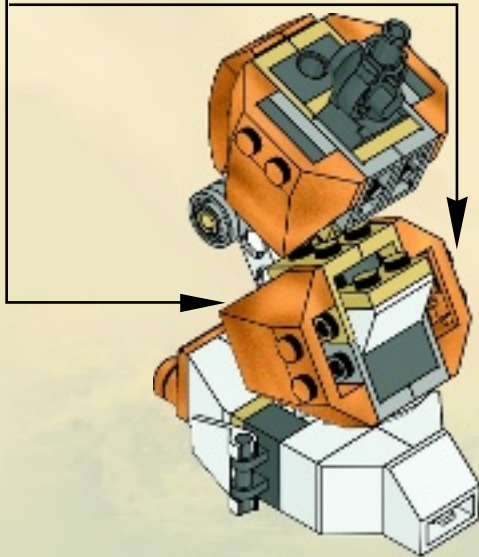

10

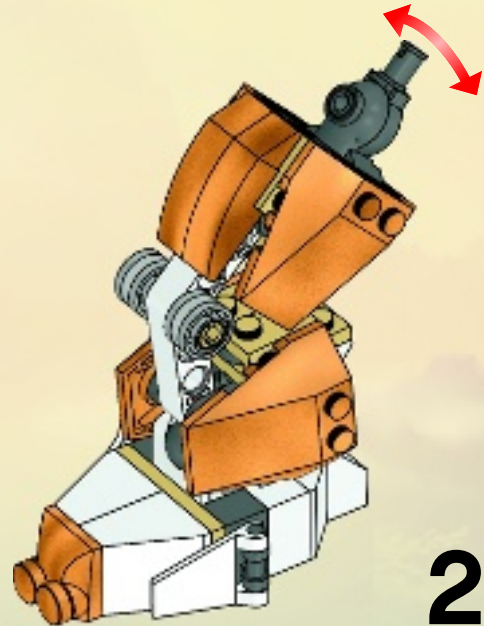

2x

11

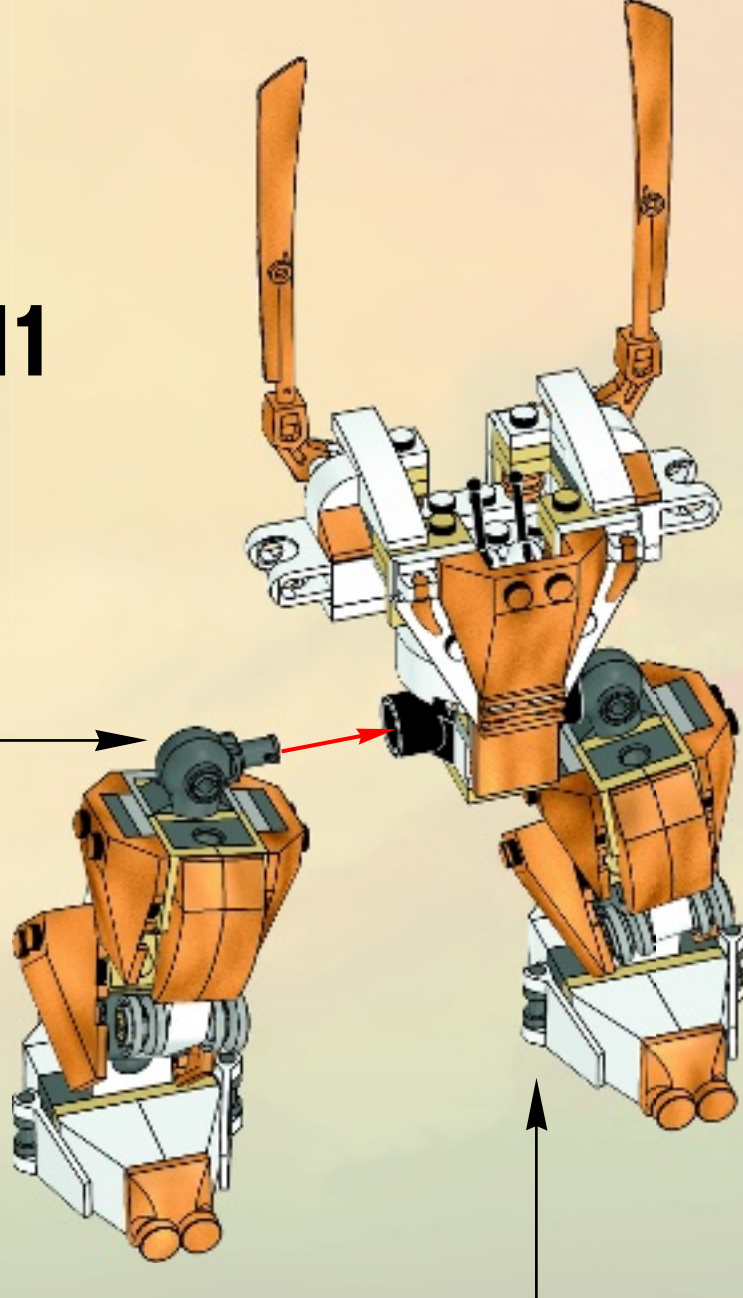



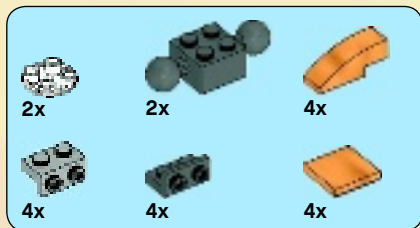

# 12

1

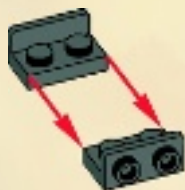

2



3



4



5

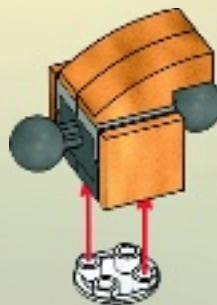

2x

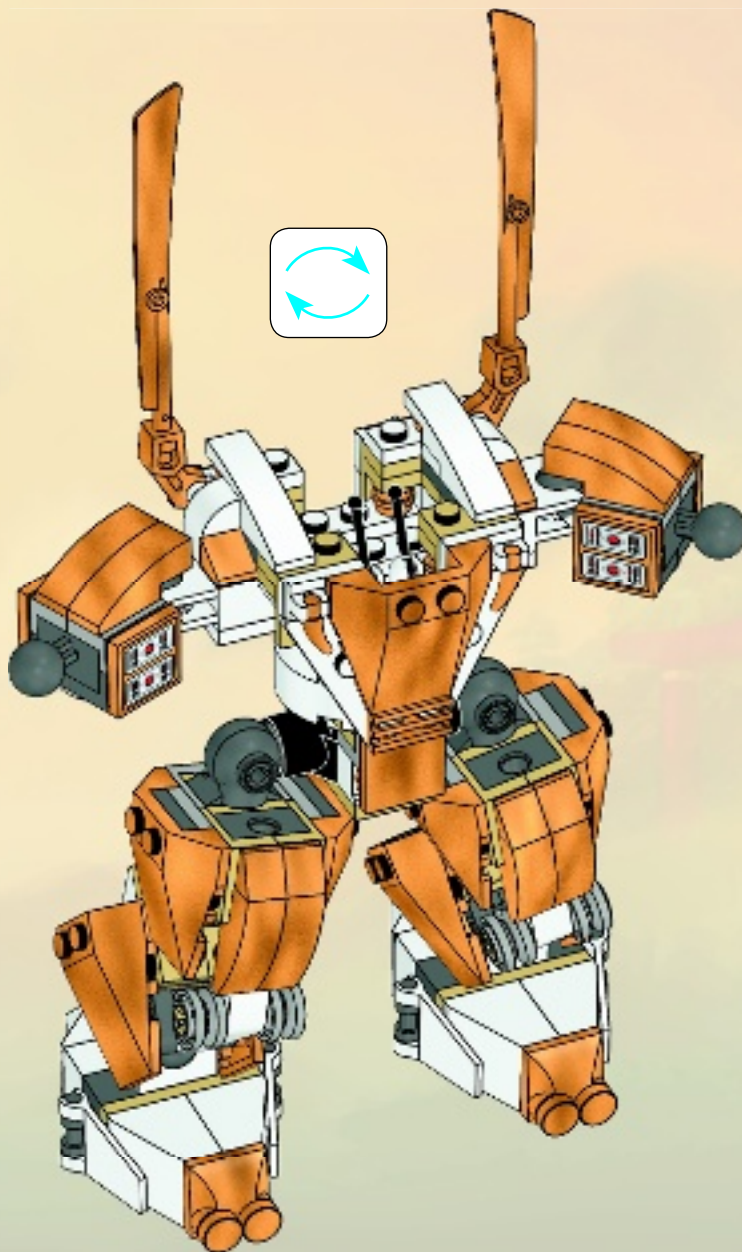
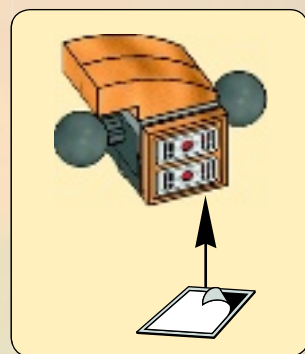
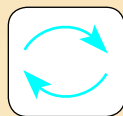
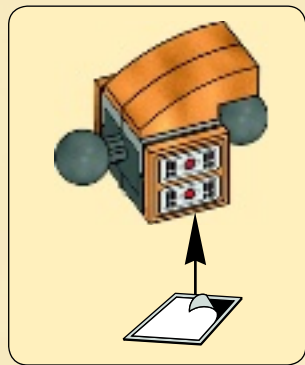



2x



1x

1



2x

2

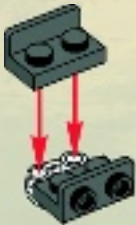

1x

3

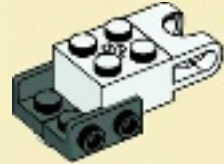

1x



2x

4

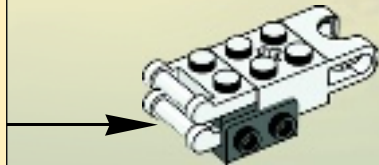
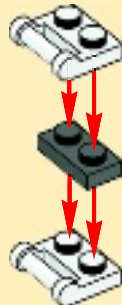



2x

5



2x

6



4x

7

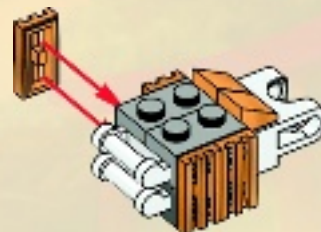



1x

8



3x

9



10

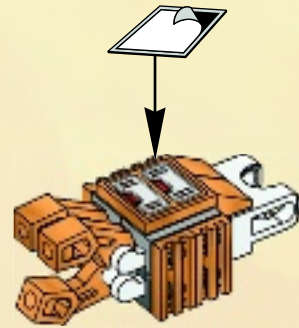

2x



11

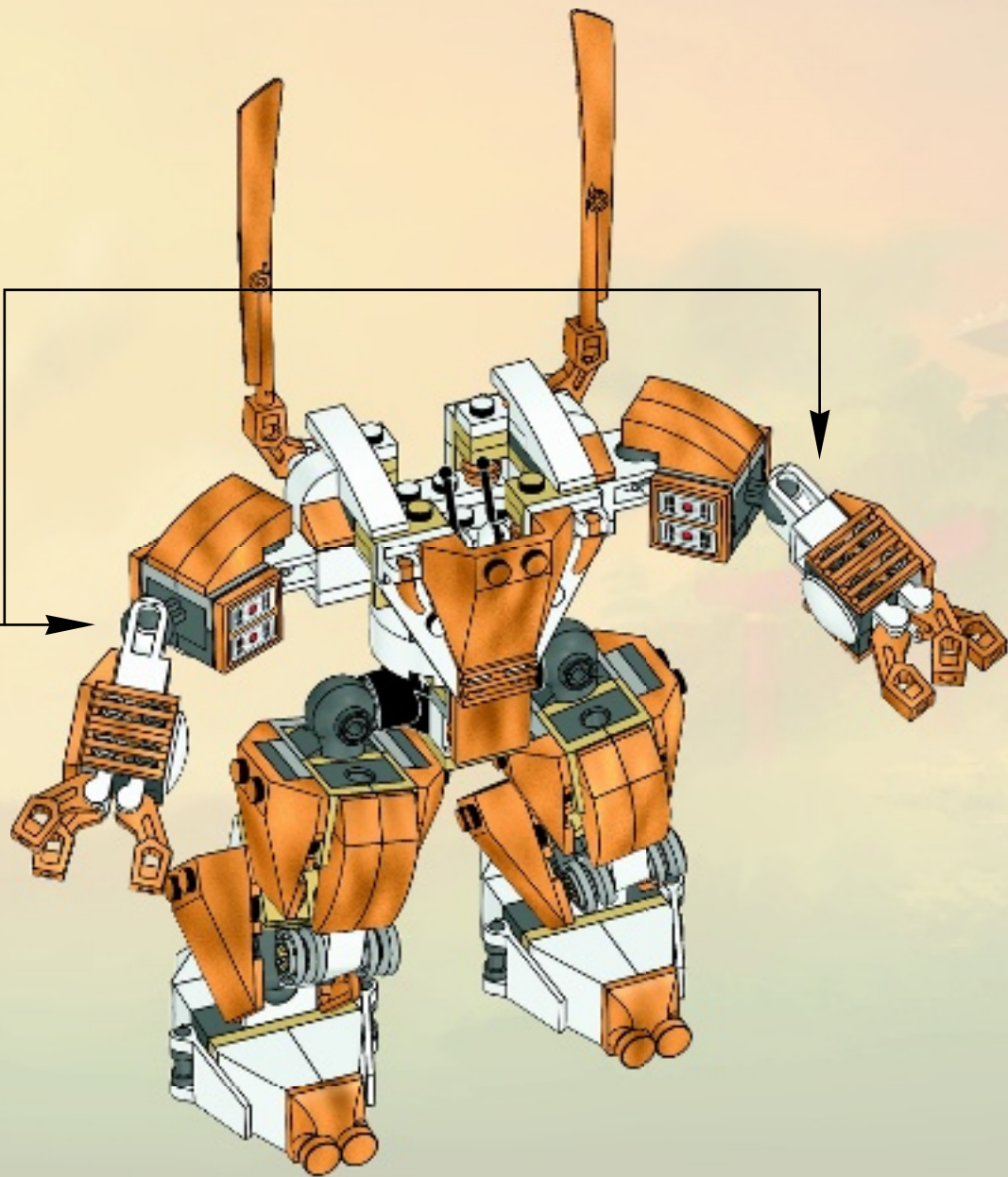

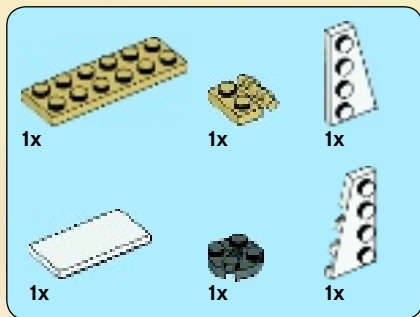

# 12

1



2

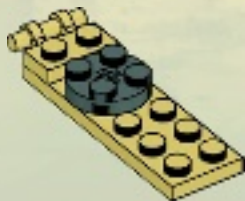

3



4



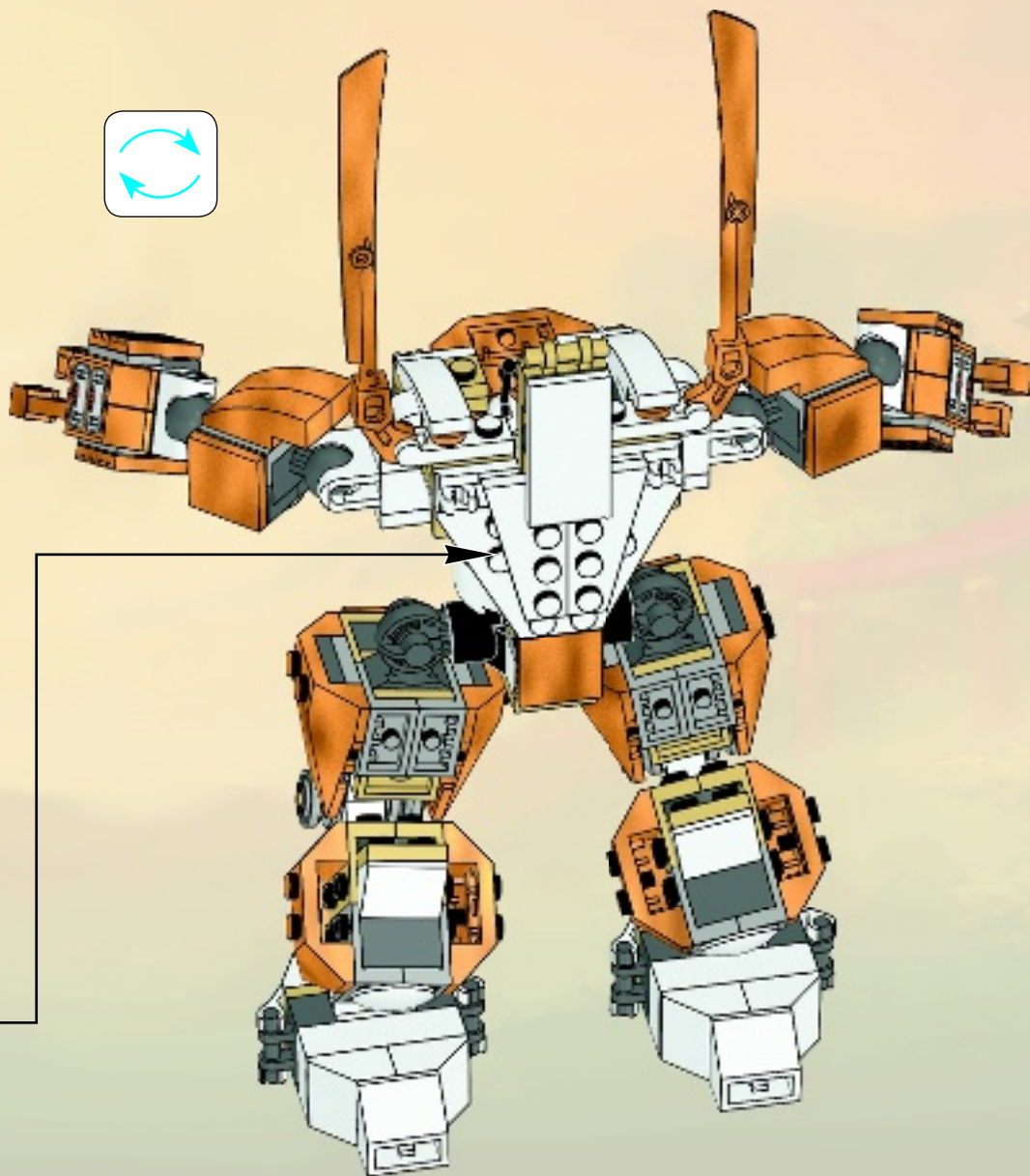





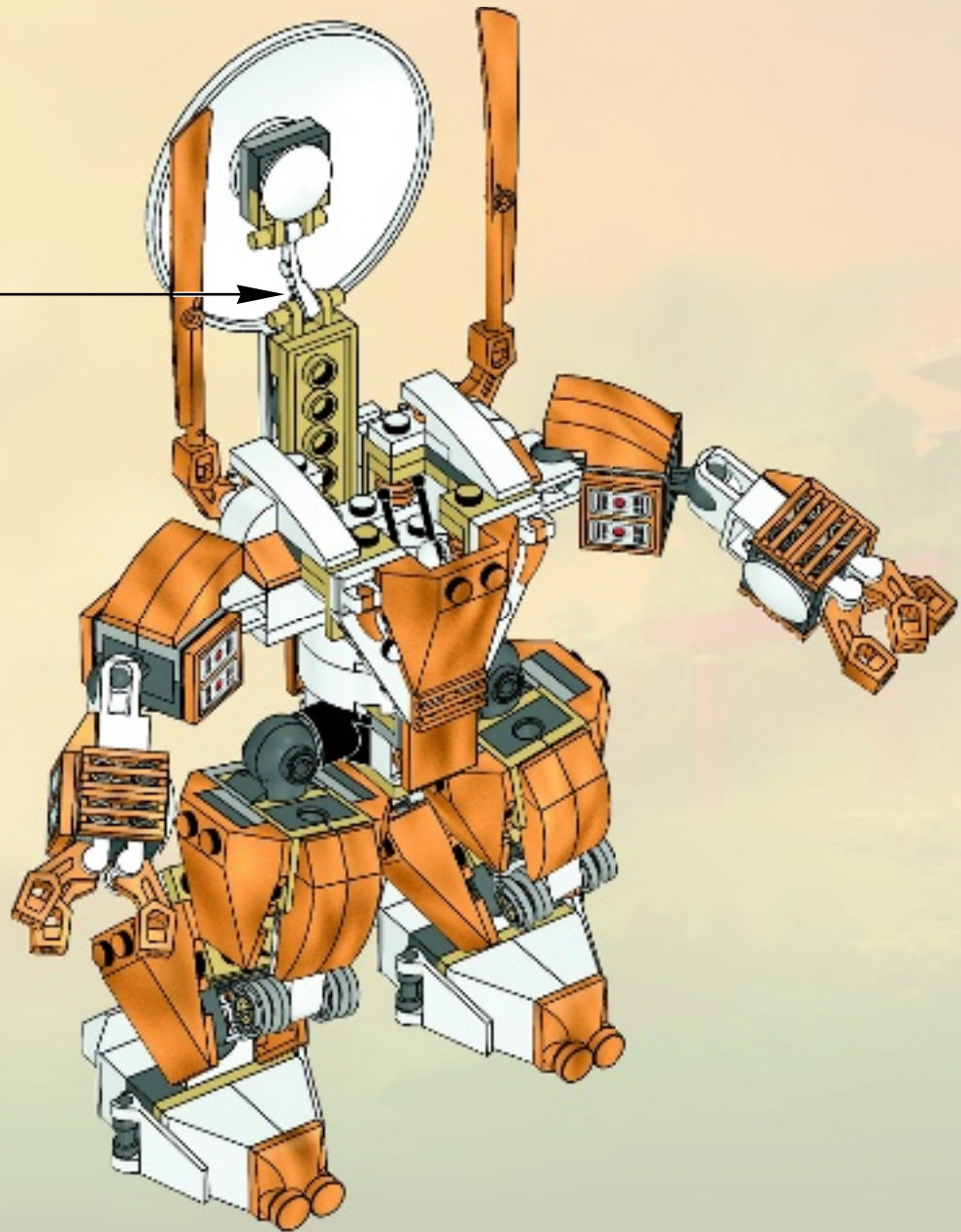
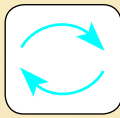

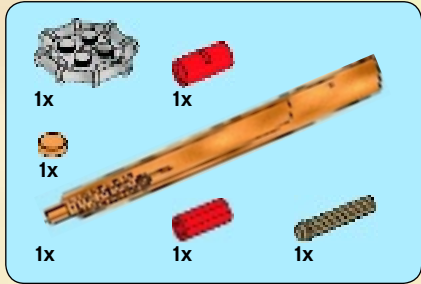

14

1

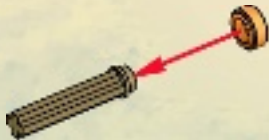

2



3





4

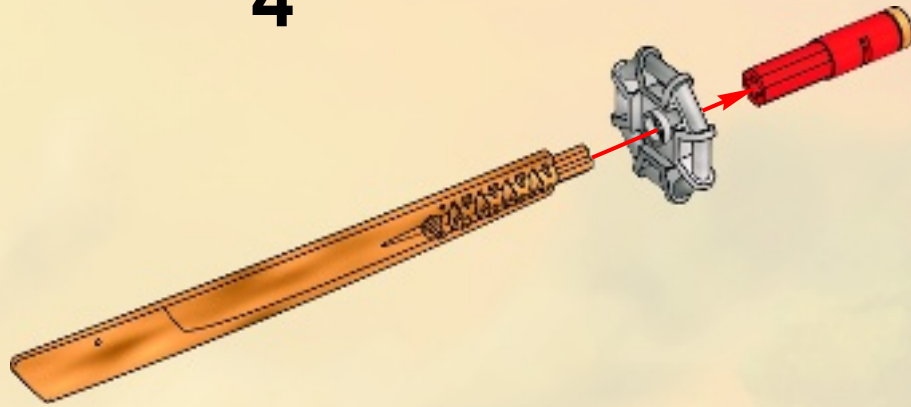

5

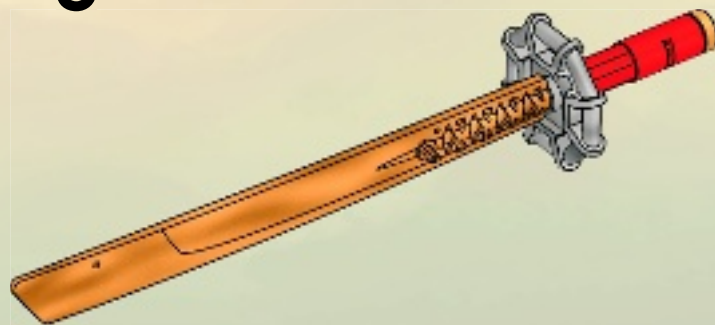

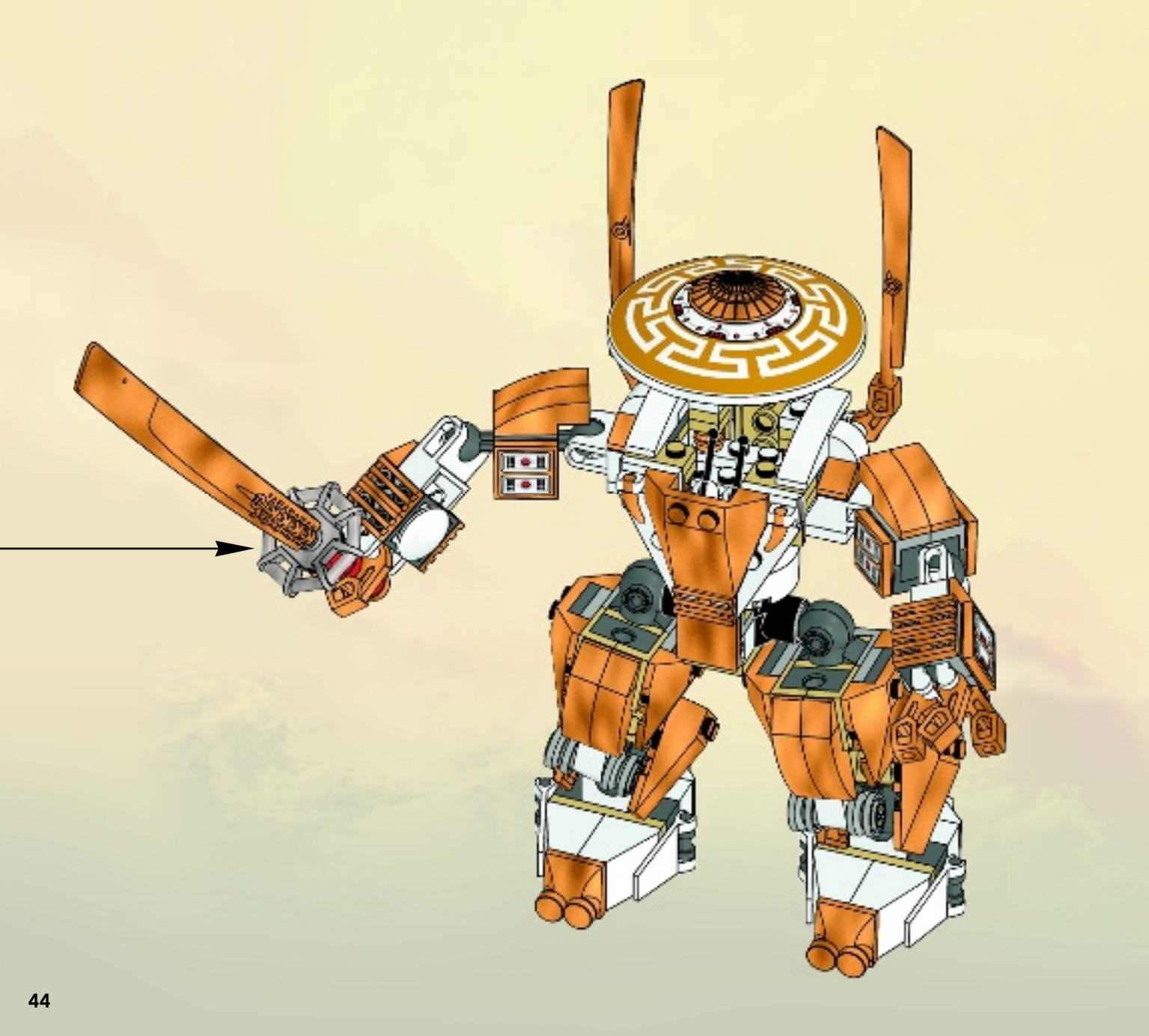





# NINJAGO

Masters of Spinjitzu







# NINJAGO

Masters of Spinjitzu



AS SEEN ON TV



GET THE APP

[LEGO.COM/NINJAGO](http://LEGO.COM/NINJAGO)





1



2



3

www.LEGOclub.com/Max

www.LEGOclub.com/Max



club™

FREE\*! GRATIS! GRATUIT!

\*Paid subscription in Australia and New Zealand. \*Abonnement payant en Australie et Nouvelle-Zélande.



# WIN!

Go to [www.LEGOsurvey.com/product](http://www.LEGOsurvey.com/product) to fill out a survey for a chance to win a cool LEGO® Product. No purchase necessary. Open to all residents where not prohibited.

 [LEGO.com](http://LEGO.com)

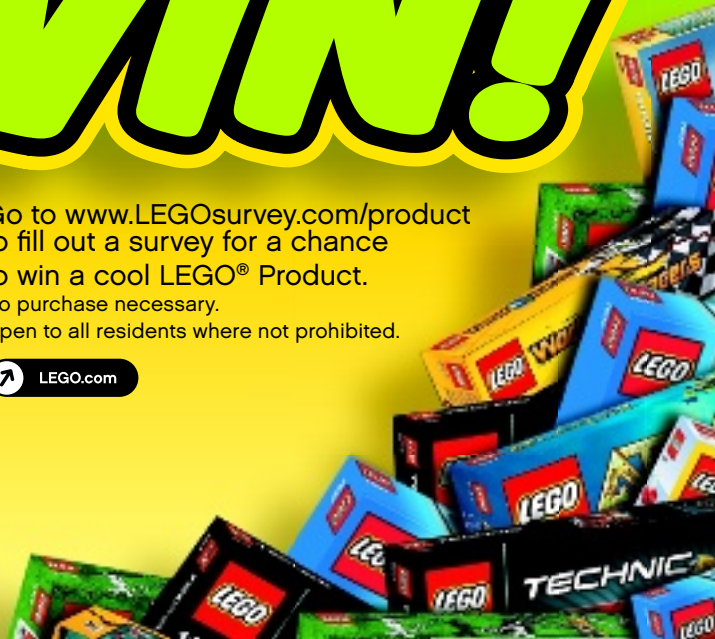

## [www.LEGOsurvey.com/product](http://www.LEGOsurvey.com/product)

### GEWINNE! WIN!

Nimm an der Umfrage auf [www.LEGOsurvey.com/product](http://www.LEGOsurvey.com/product) teil und hab die Chance ein cooles LEGO® Produkt zu gewinnen!

Die Teilnahme am Gewinnspiel führt zu keinerlei Kaufverpflichtungen. Teilnahme in allen nicht ausgeschlossenen Ländern möglich.

Ga naar [www.LEGOsurvey.com/product](http://www.LEGOsurvey.com/product), vul een enquêteformulier in en maak kans op een cool LEGO® product.

Geen aankoopverplichting. Iedereen mag deelnemen, uitgezonderd ingezetenden van landen waar een enquêteverbod geldt.

### GAGNE! 当てよう!

Visite [www.LEGOsurvey.com/product](http://www.LEGOsurvey.com/product) pour répondre à un questionnaire et avoir une chance de gagner un produit LEGO® très cool!

Aucune obligation d'achat. Ouvert à tous les résidents des pays autorisés.

[www.LEGOsurvey.com/product](http://www.LEGOsurvey.com/product) にアクセスして、アンケートにご記入ください。当選者にはレゴ®製品を差し上げます。

お買い上げの必要はありません。

禁止されていない限り、すべての皆様にご利用いただけます。





# NINJAGO

Masters of Spinjitzu

70505



**GOLDEN NINJA  
INCLUDED**





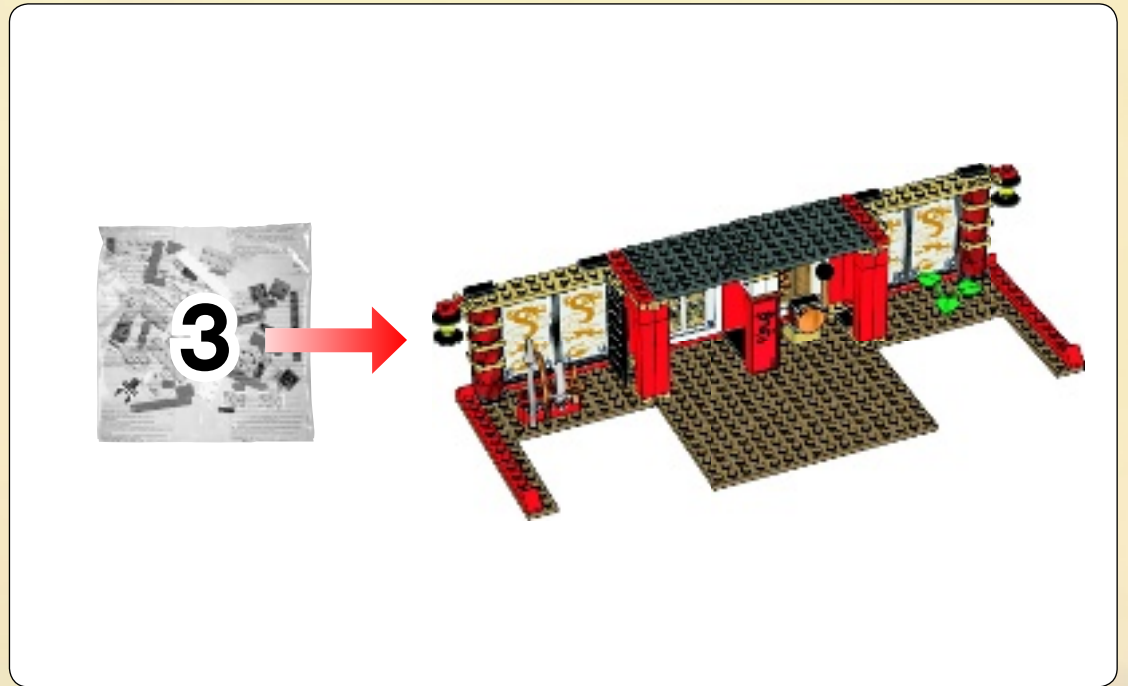

**GOLDEN NINJA INCLUDED  
GOLDENER NINJA ENTHALTEN  
NINJA D'OR INCLUS  
INCLUYE AL NINJA DORADO  
NINJA DOURADO INCLUIDO  
ARANY NINZSA A DOBOZBAN**

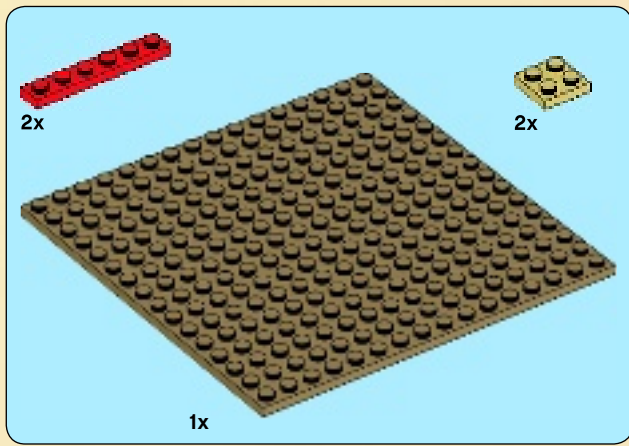

1

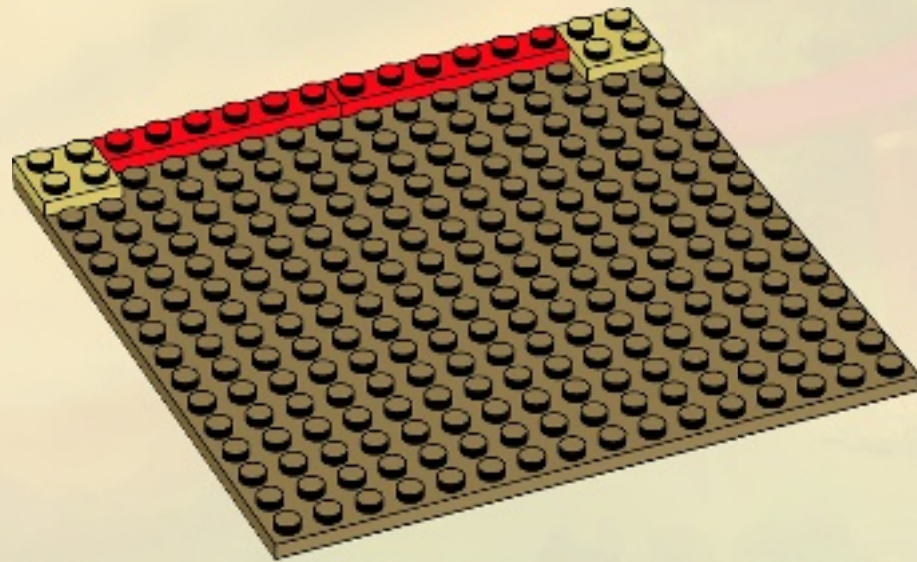

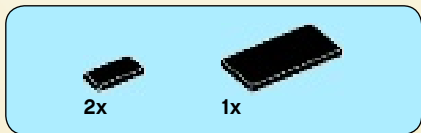

2

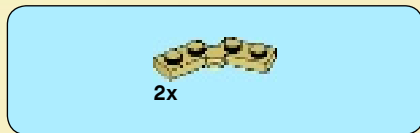
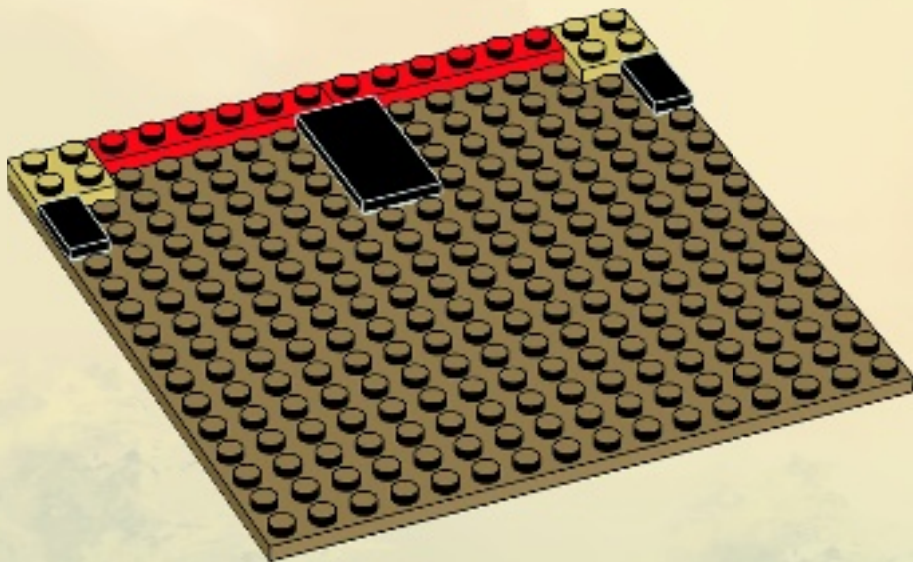

3

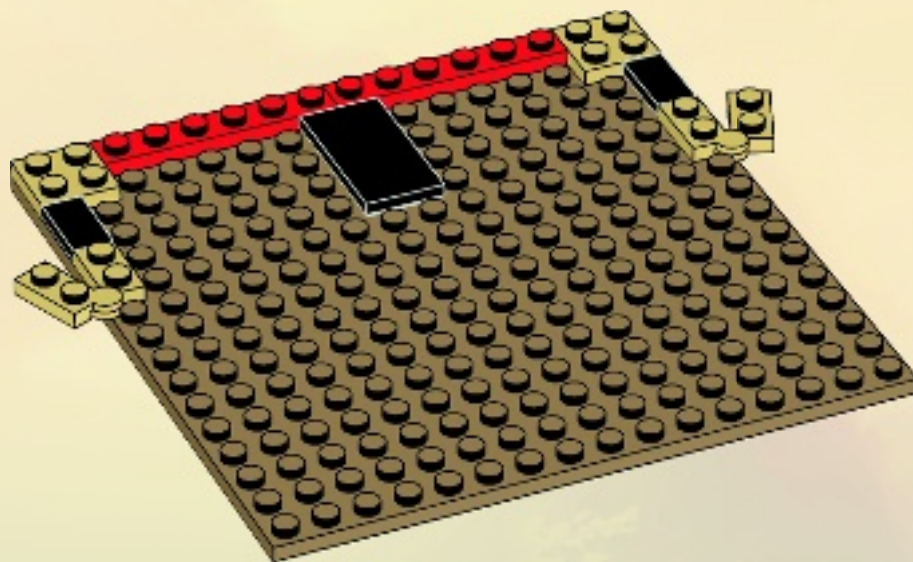



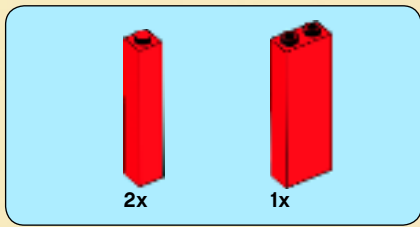

4

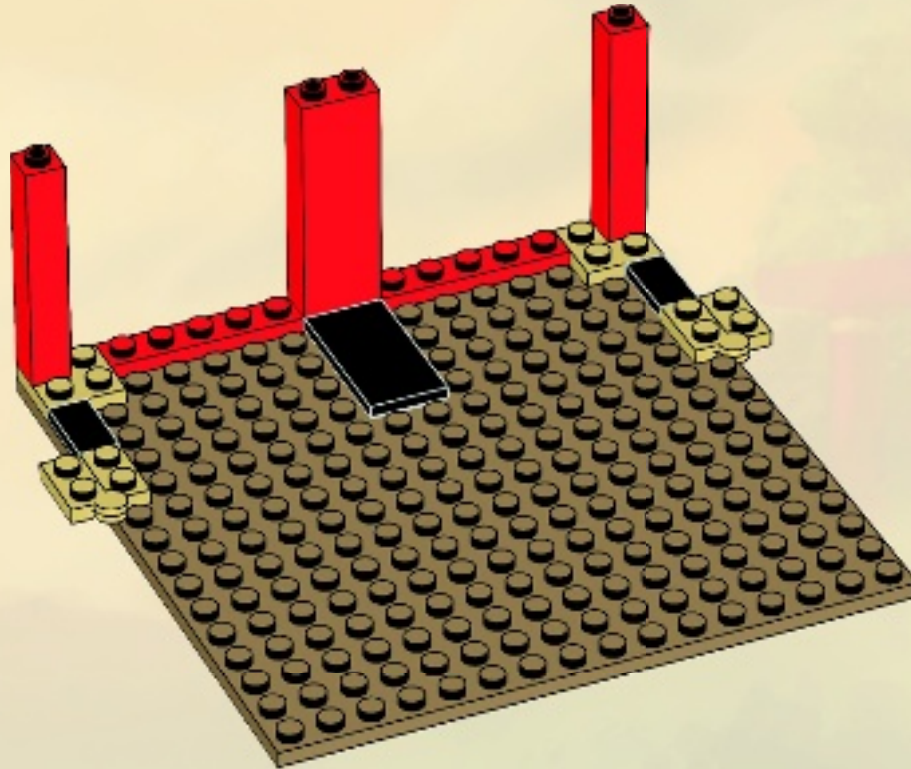

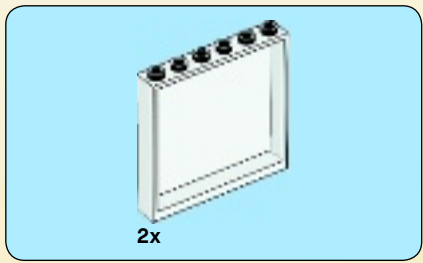

5

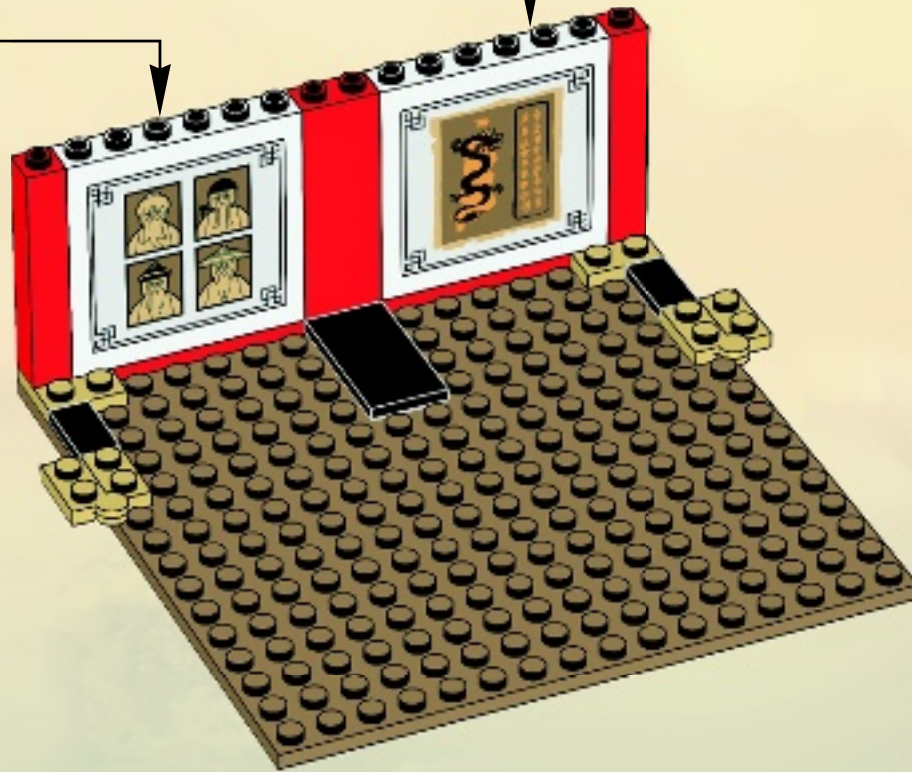
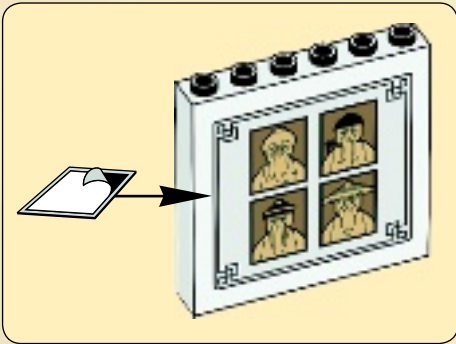
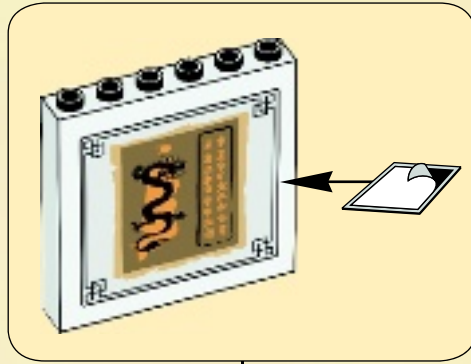



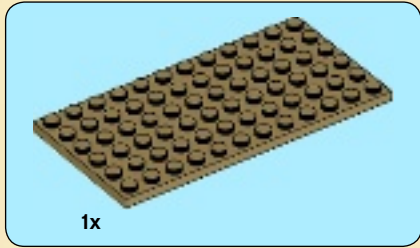
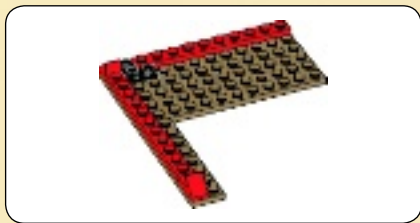

1

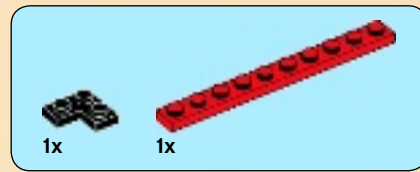
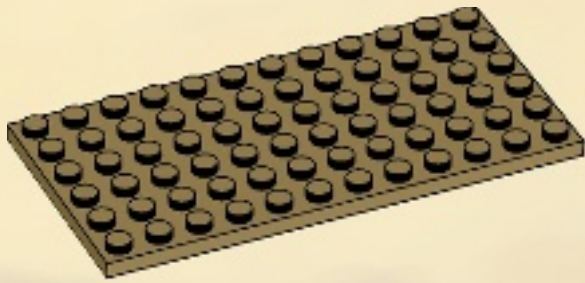

2

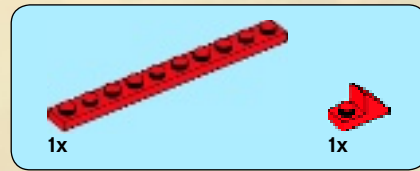
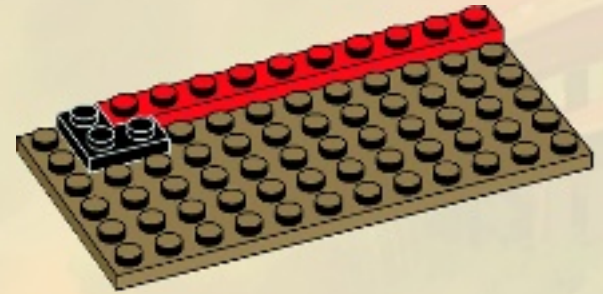

3

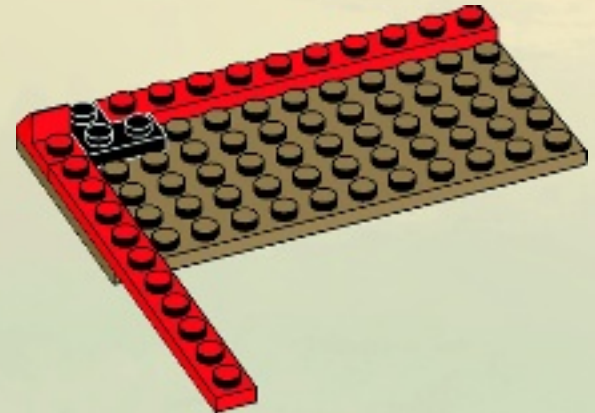

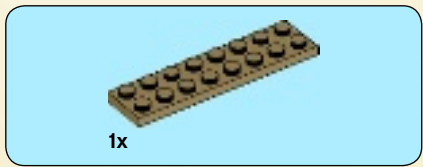

4

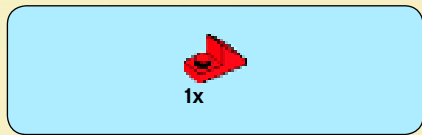
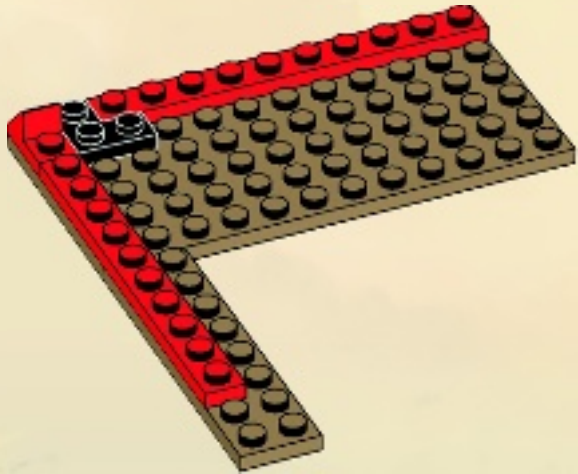

5

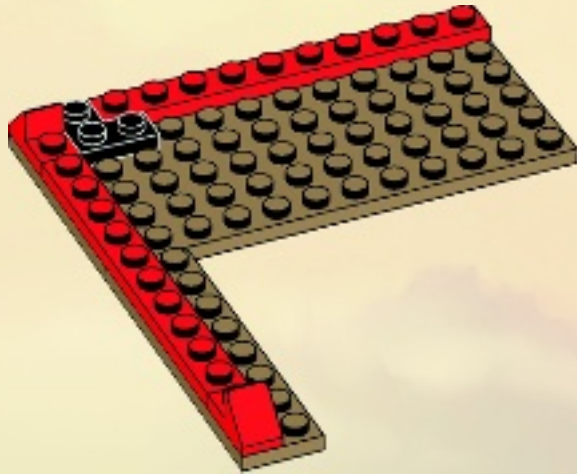

6

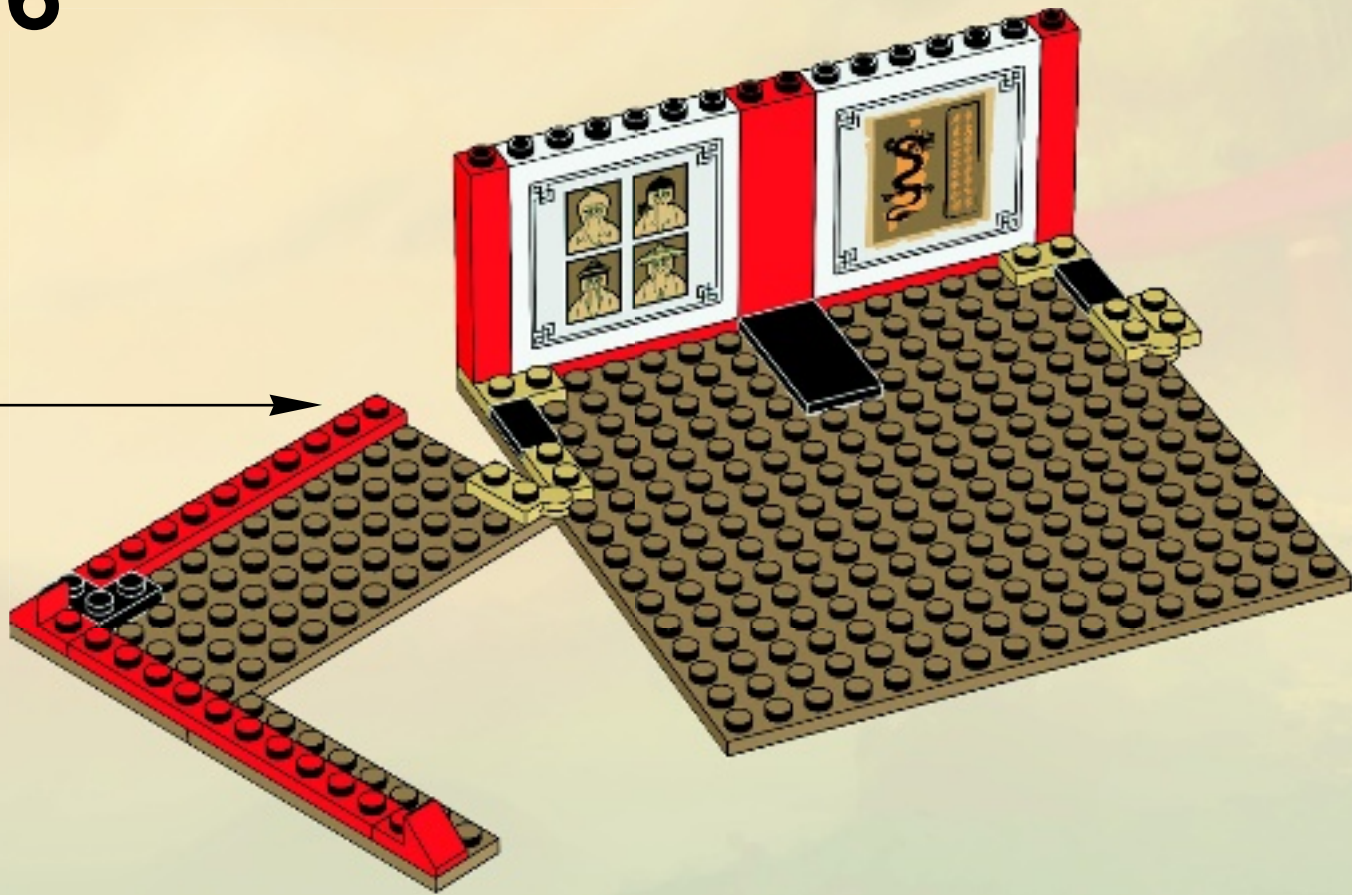

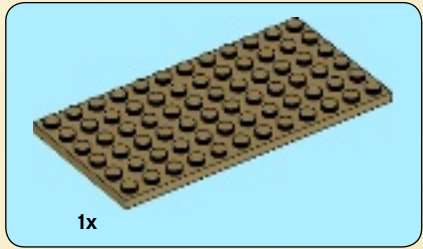
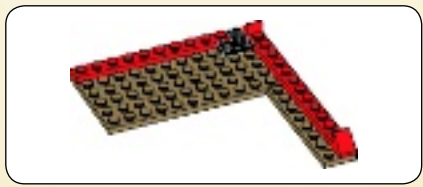

1

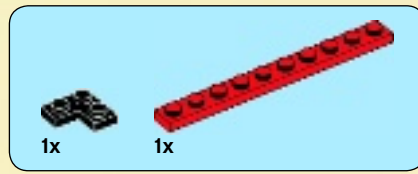
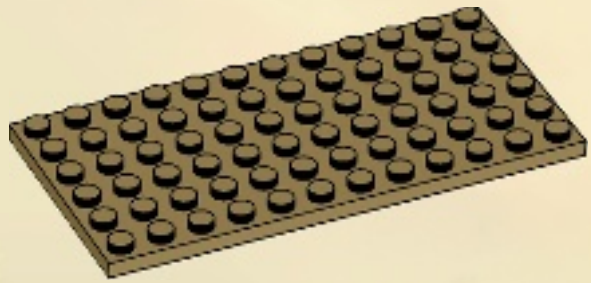

2

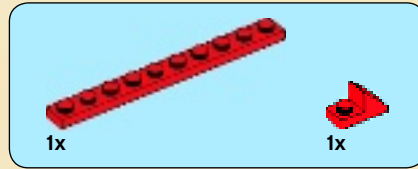
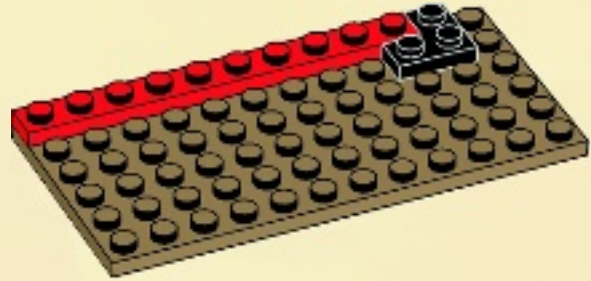

3





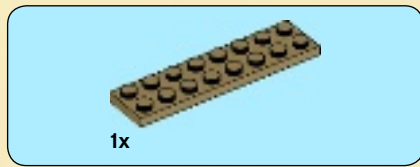

4

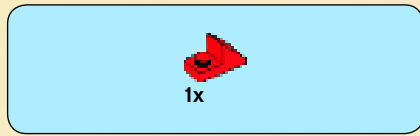
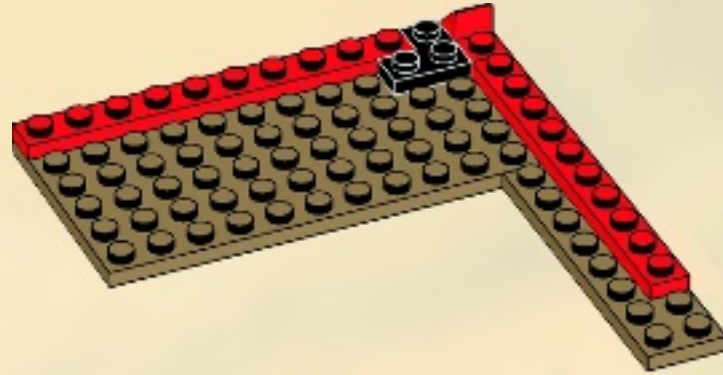

5

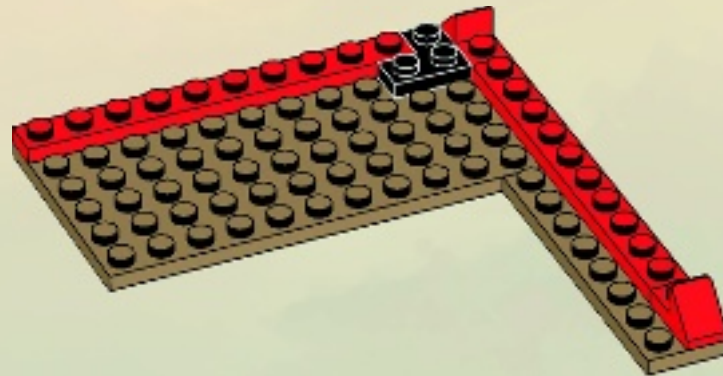

6

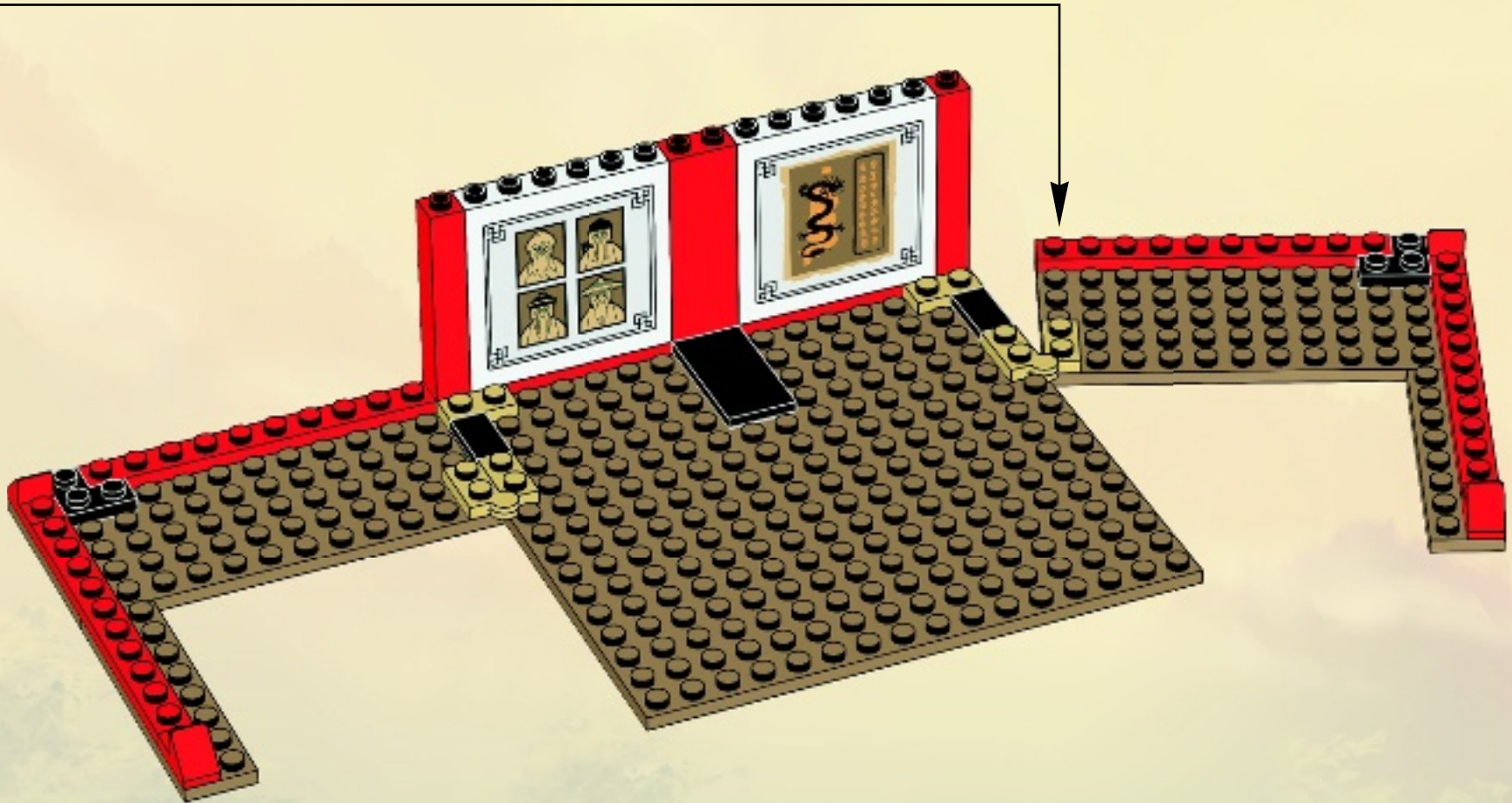



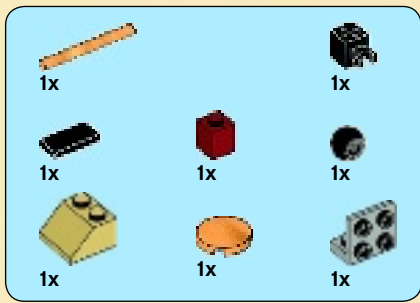

# 7

1

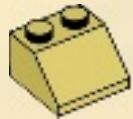

2

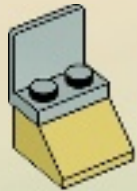

3



4

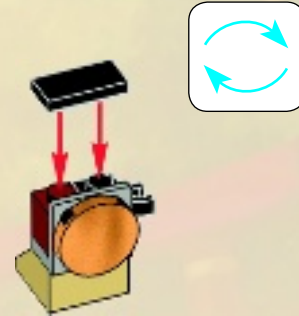

5

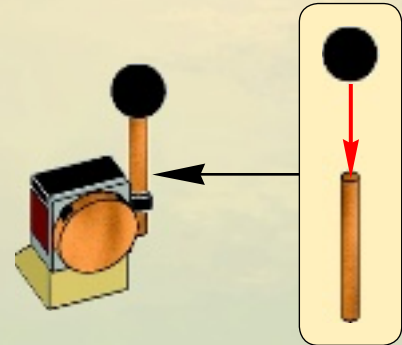

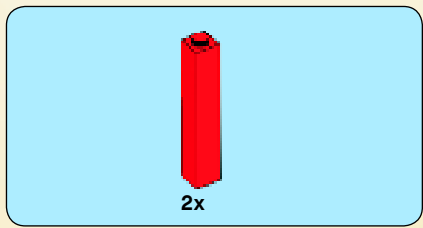

8

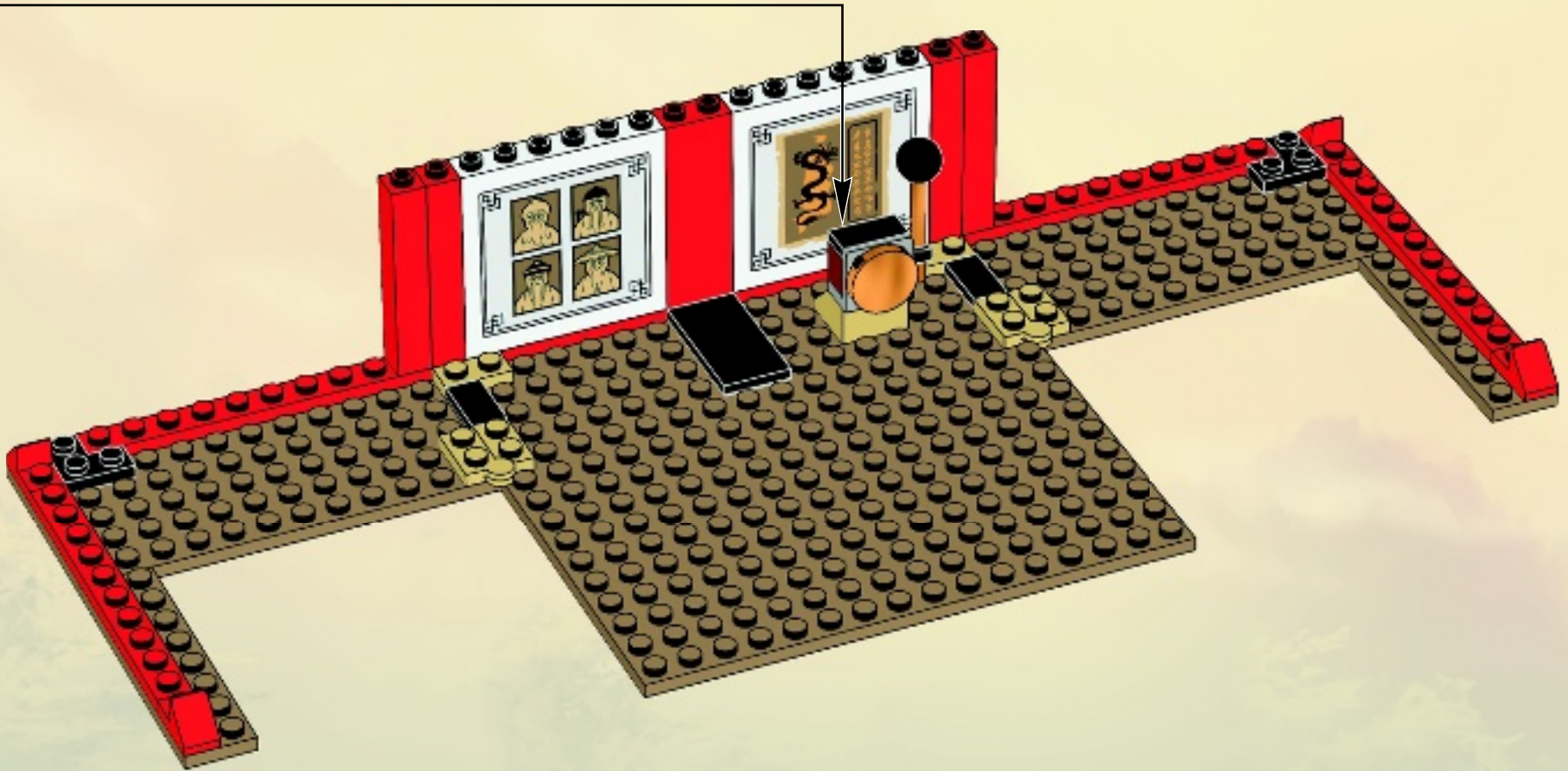

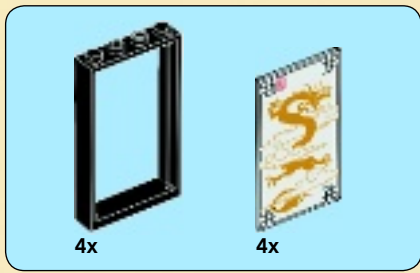

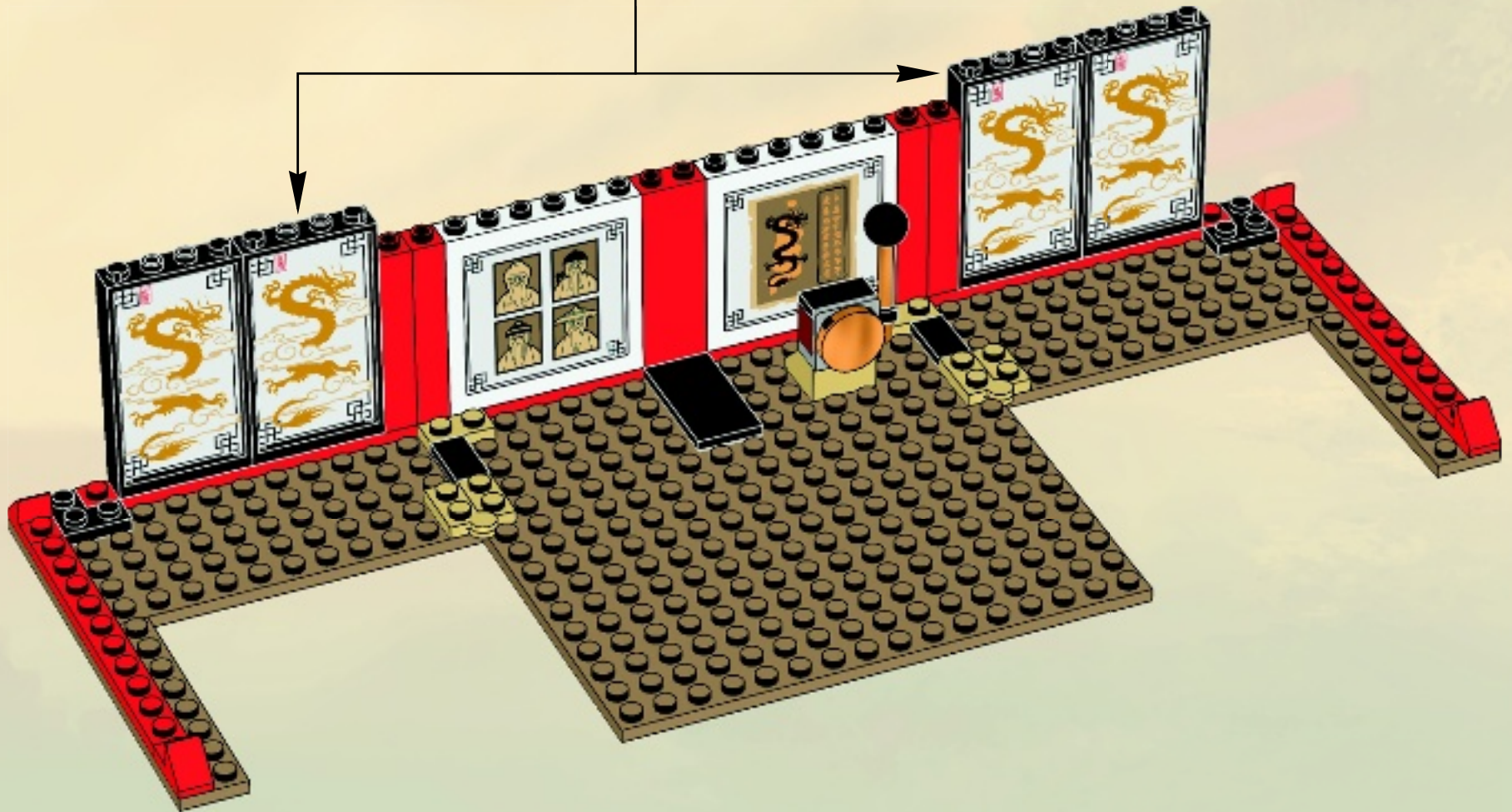
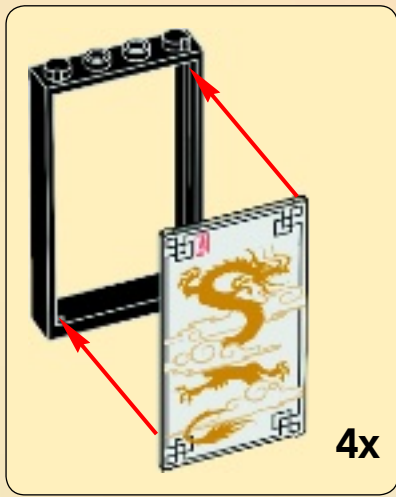

9



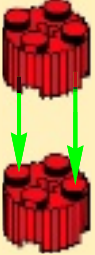
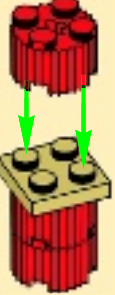

6x  10x 

10

1  2  3  2x

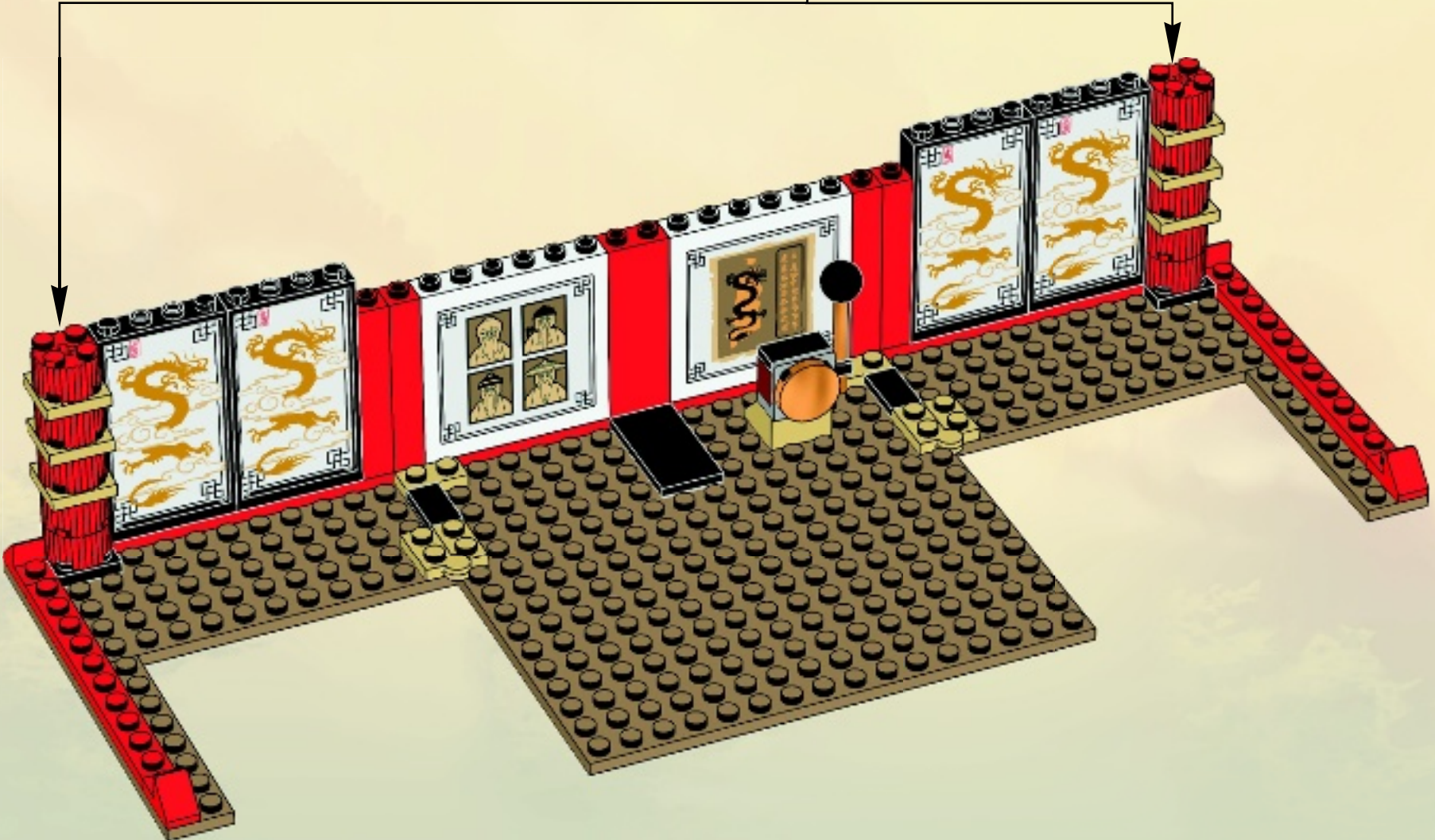

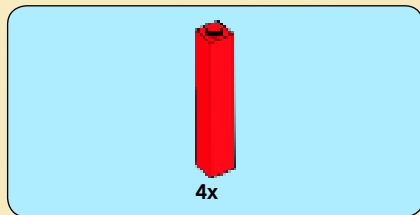

11

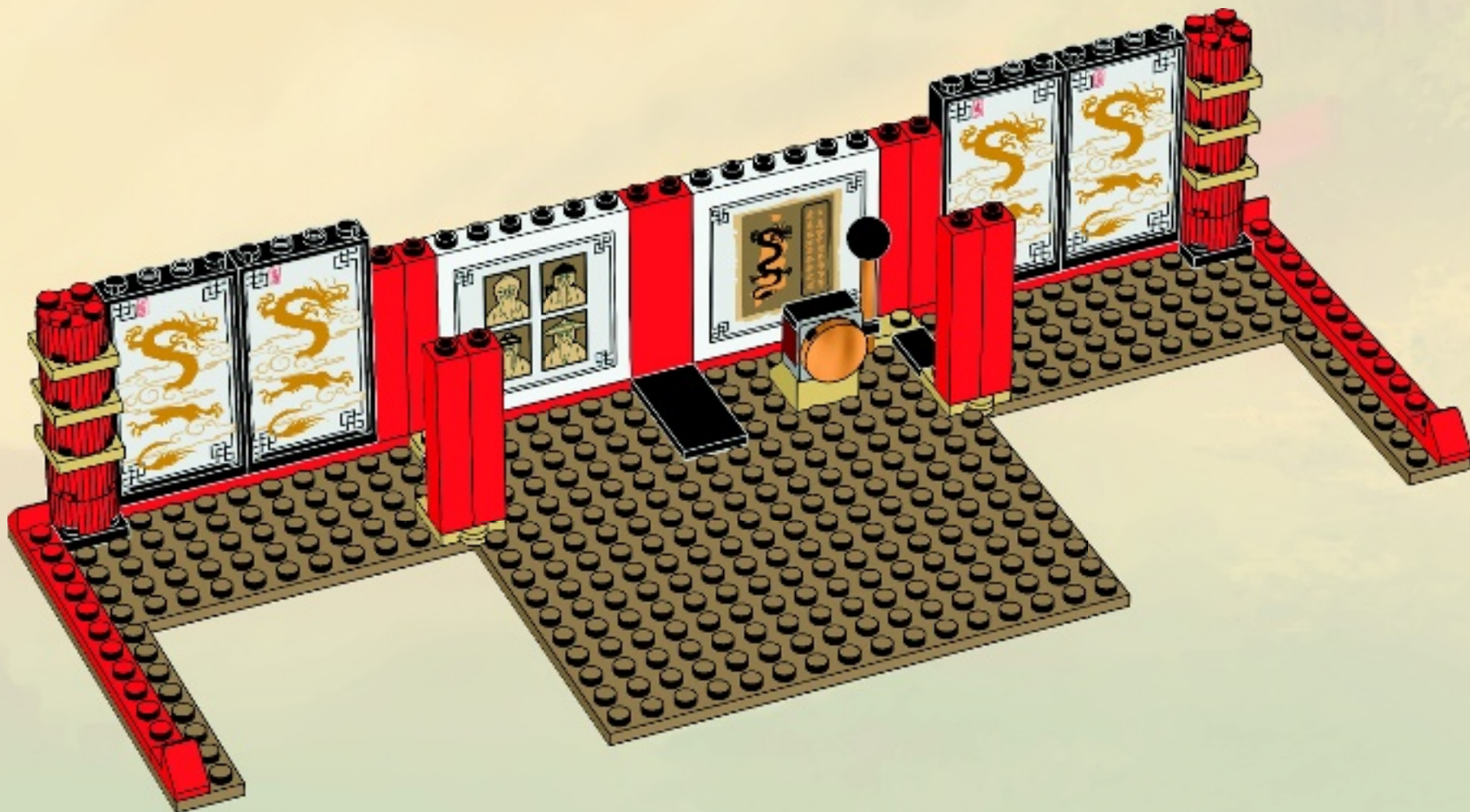



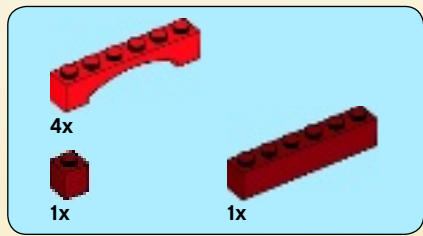

12

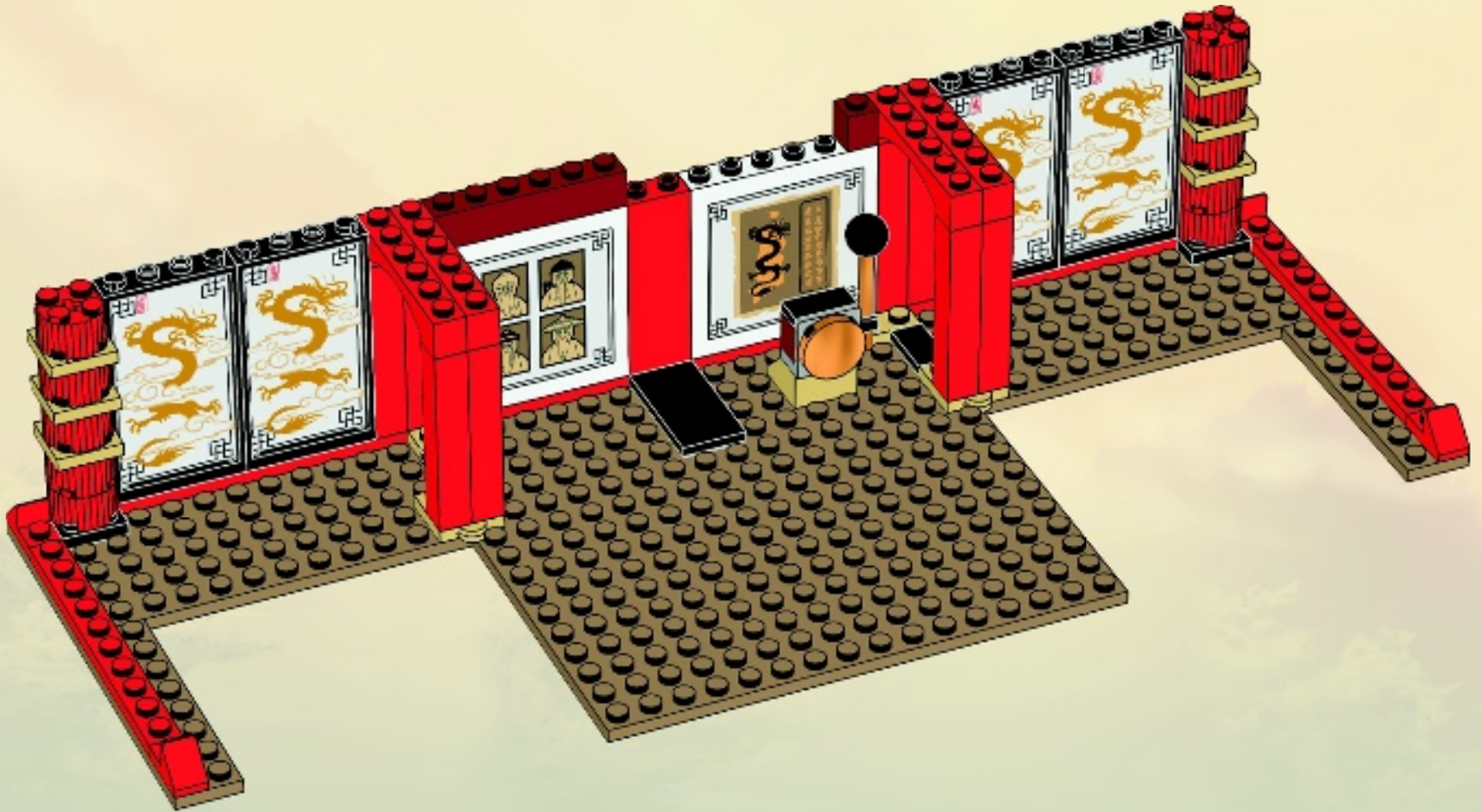

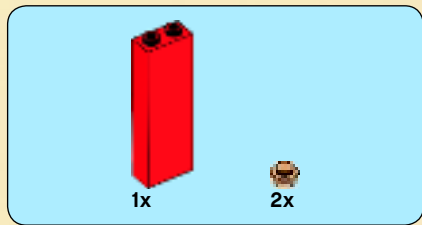

13

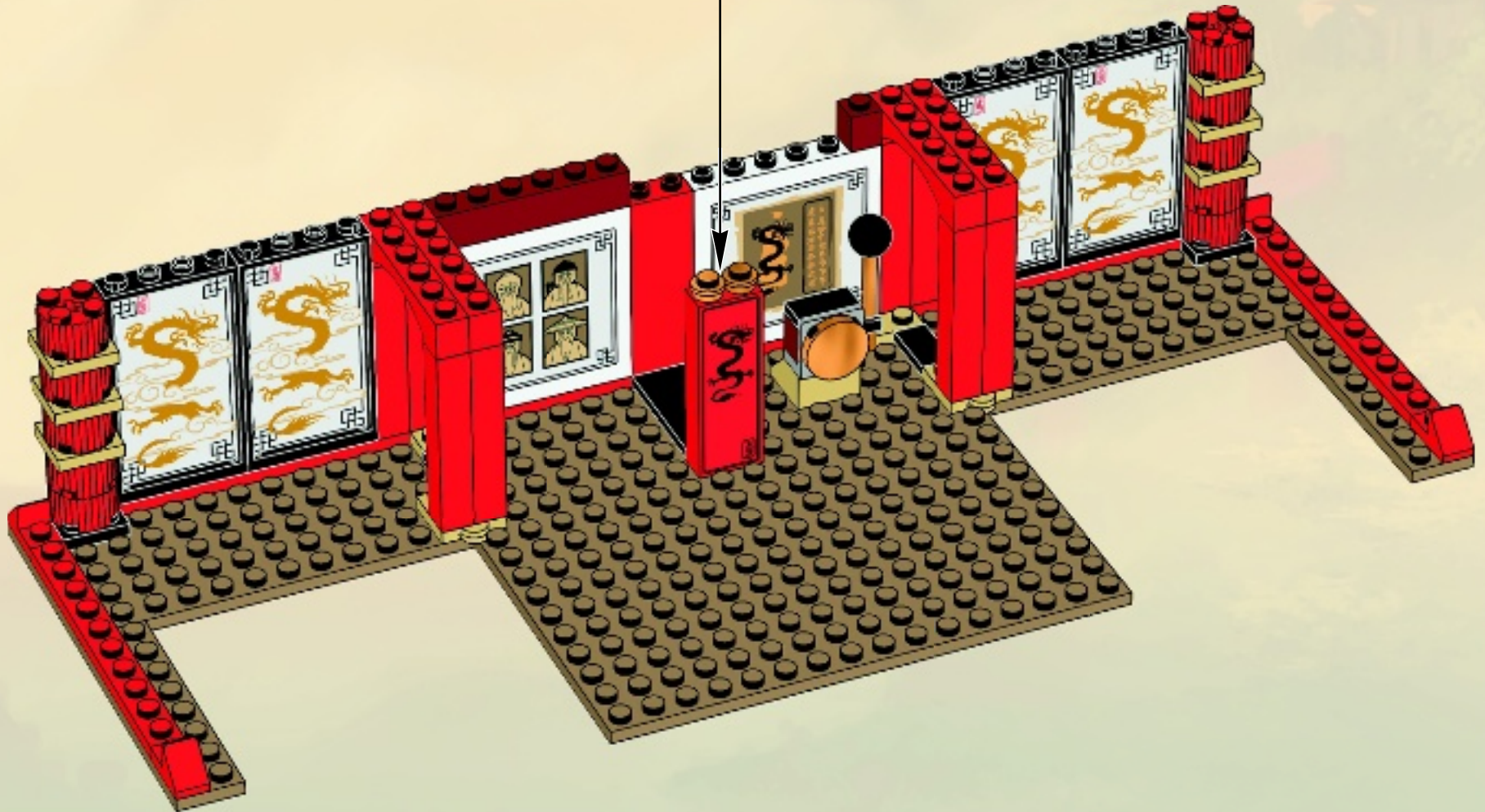
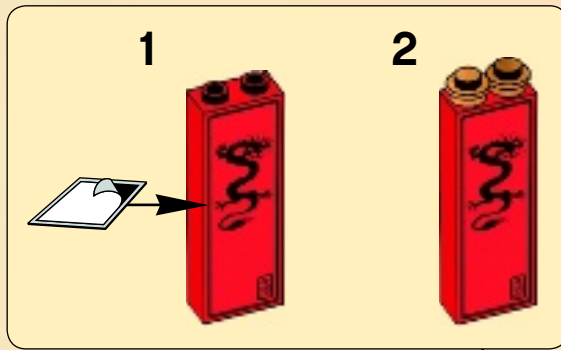

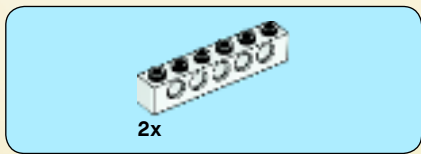

1

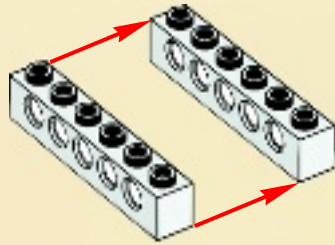

2

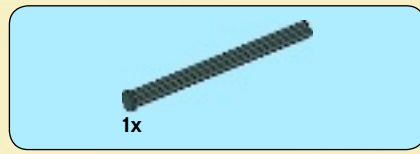

3

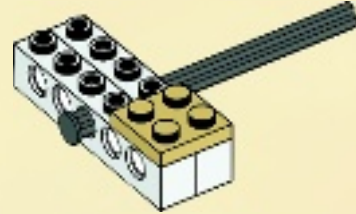

4

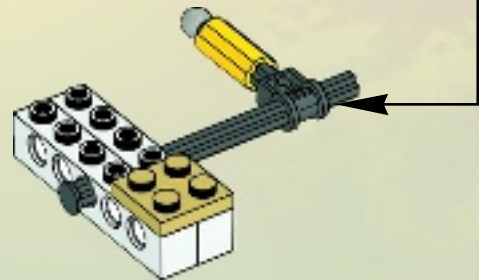
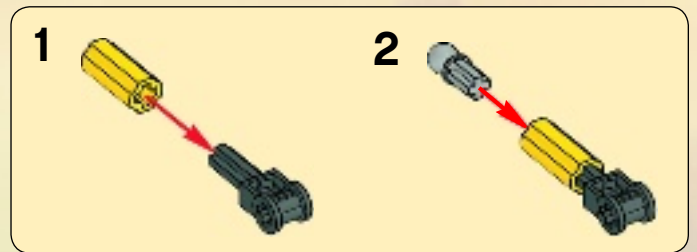



1x

5

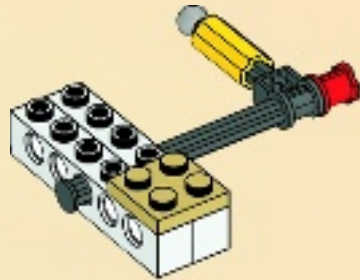

14

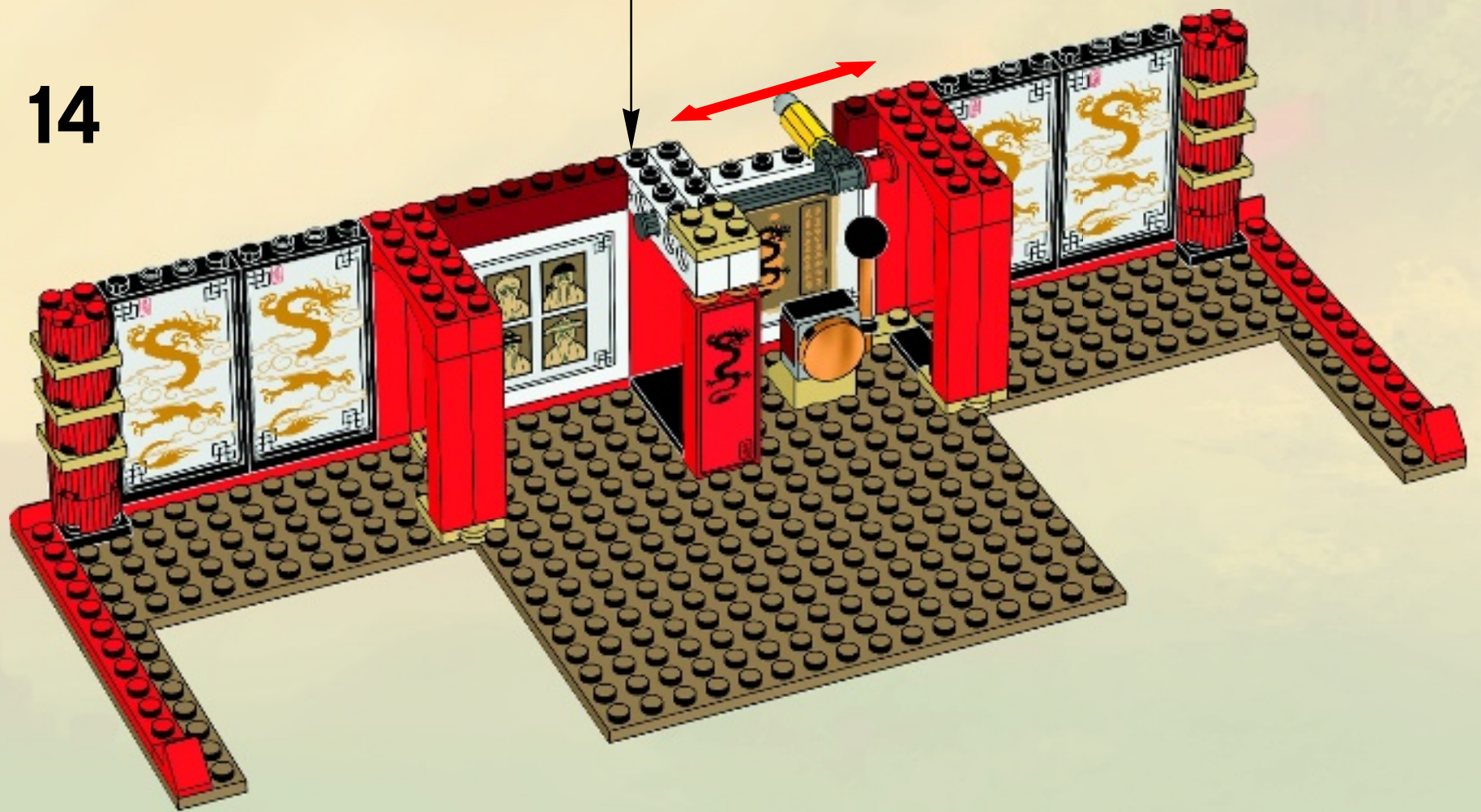



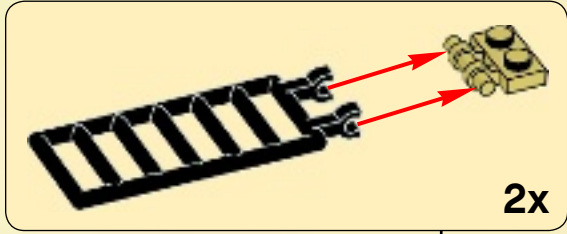
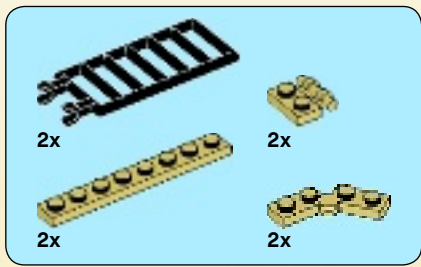

15

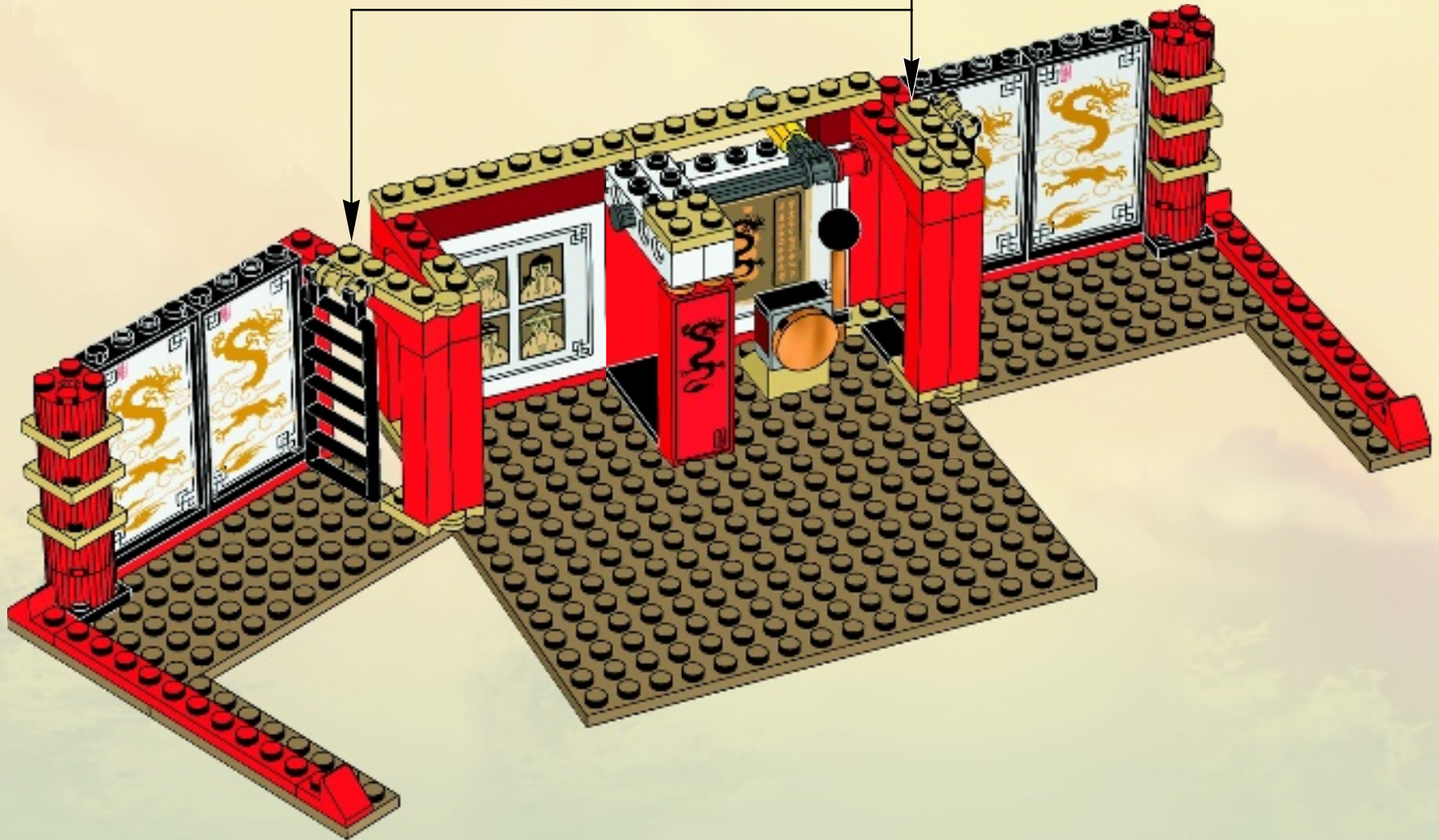

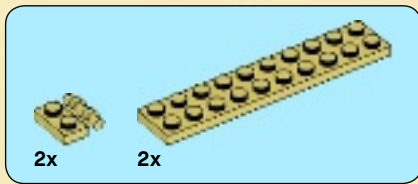

16

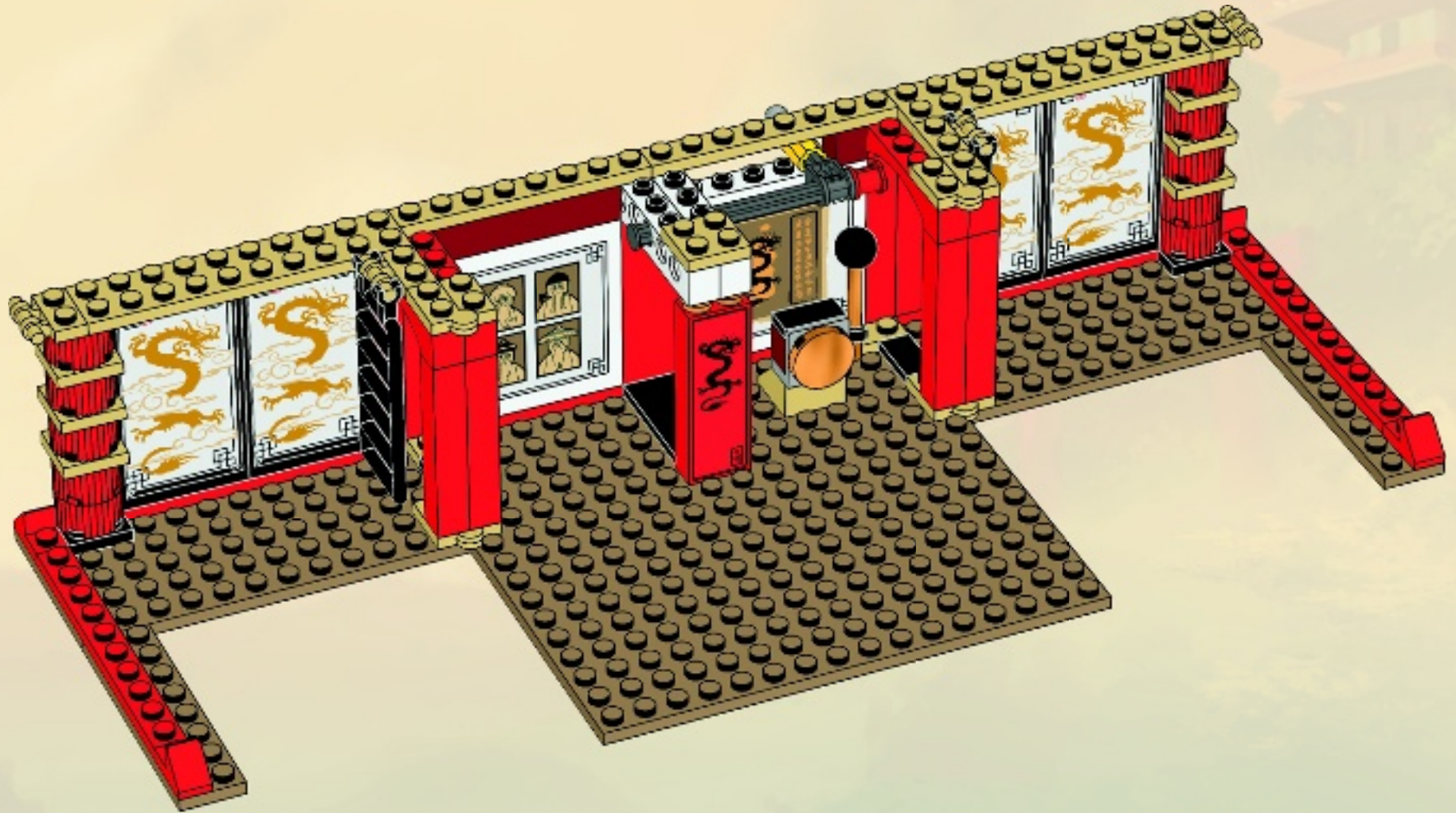



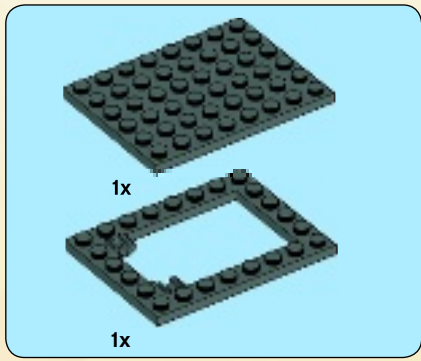

17

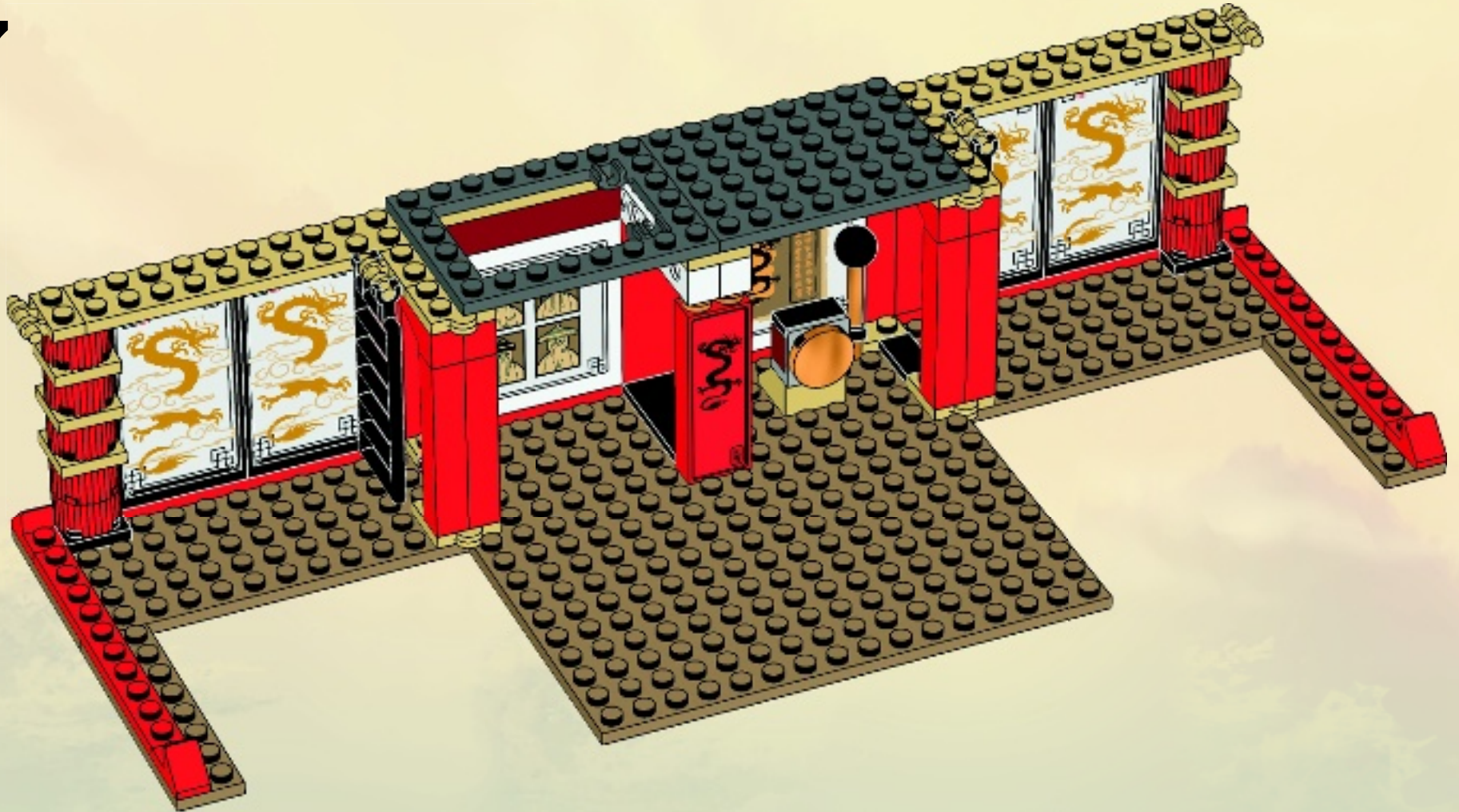

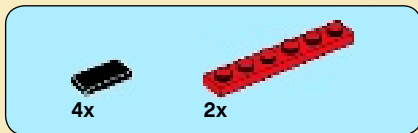

18

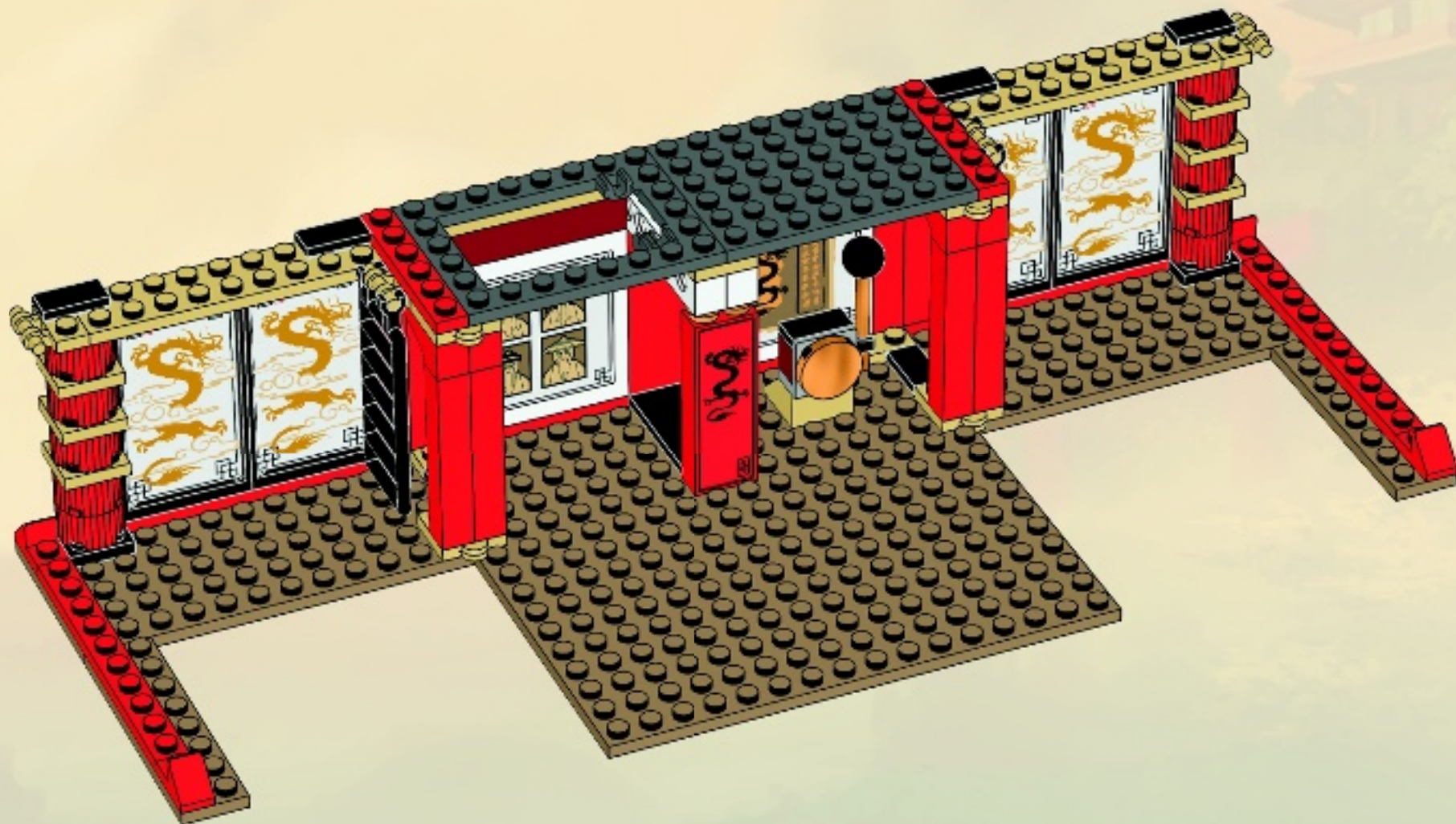



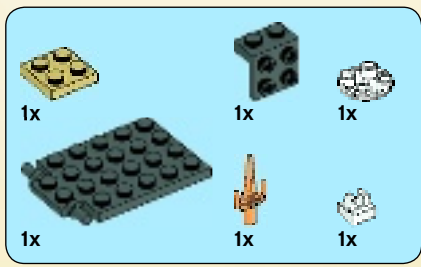

19

1



2



3

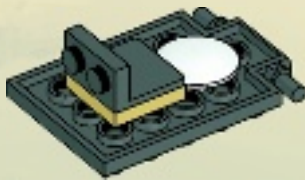

4

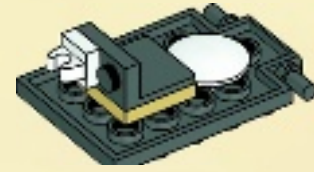

5

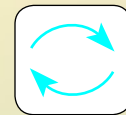
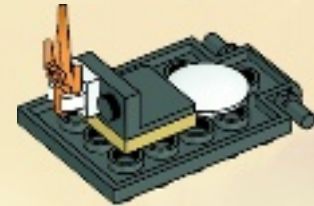

6



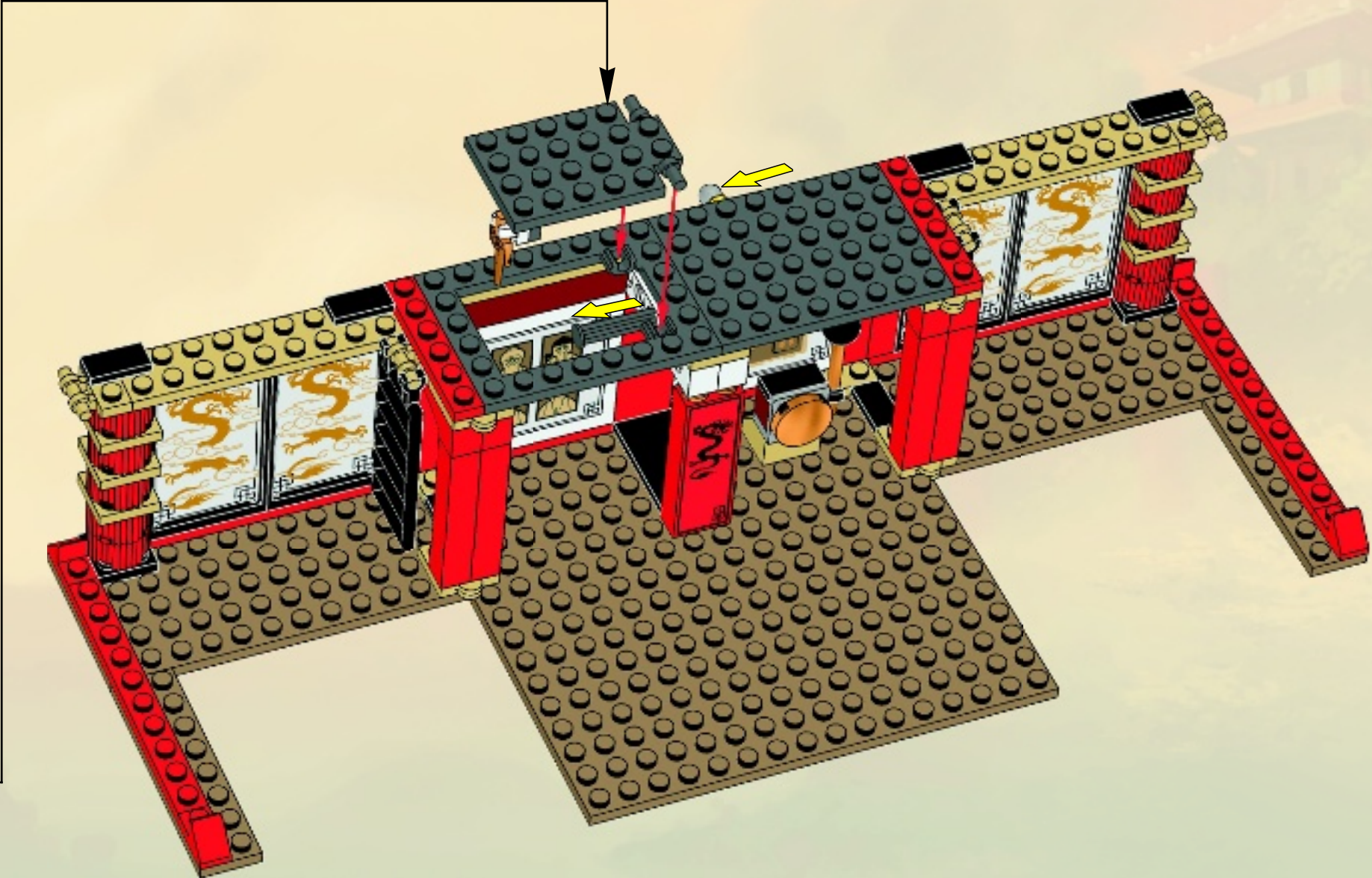

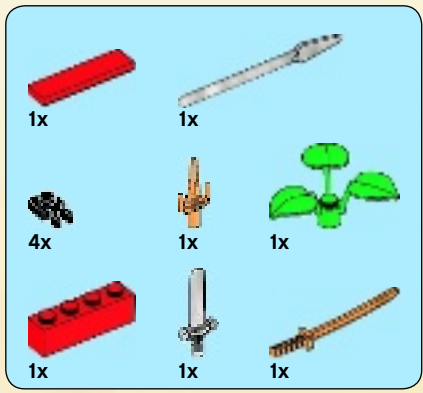

# 20

1



2



3

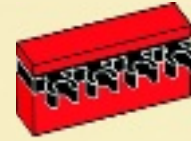

4

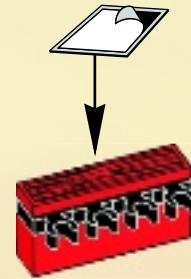

5





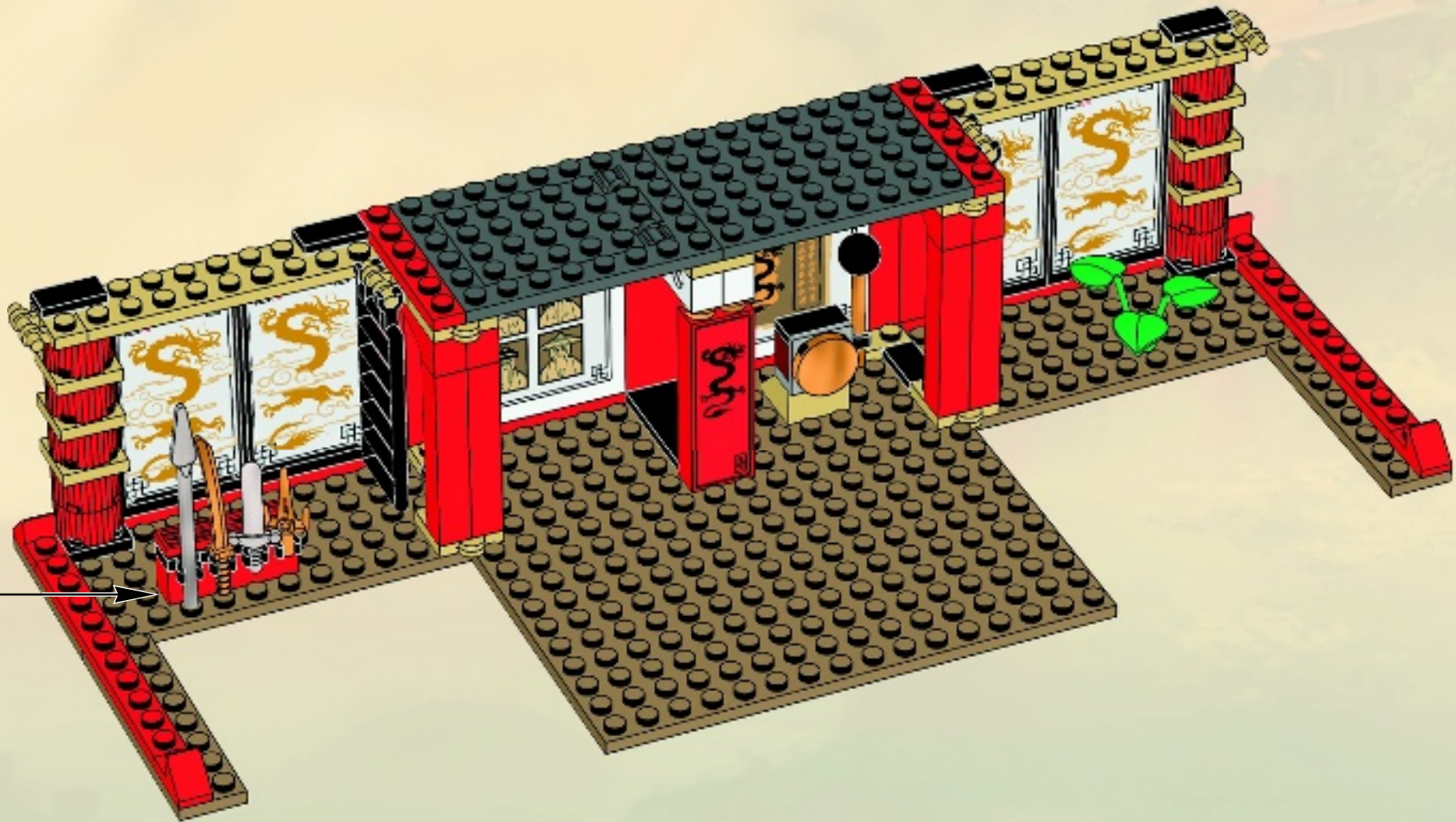



4x 2x 2x

21

1 2 3 4 2x



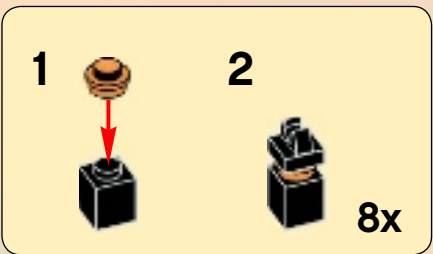
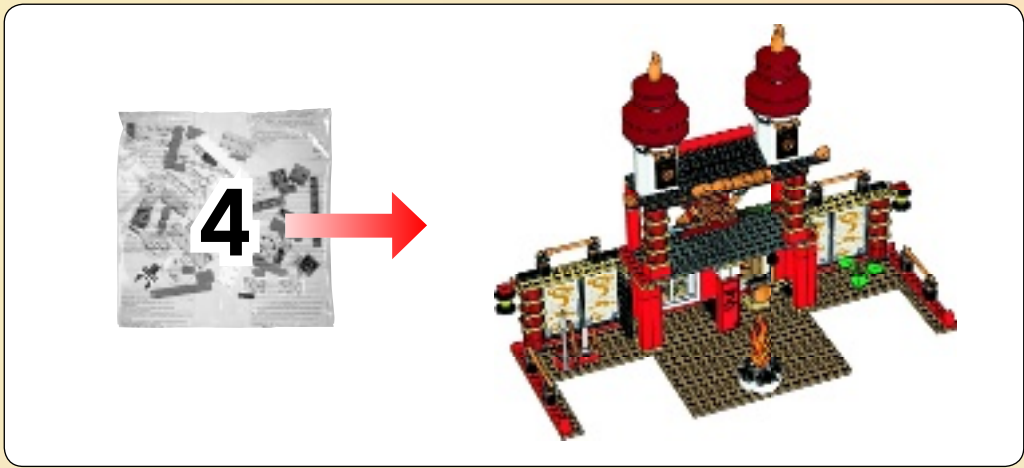

22

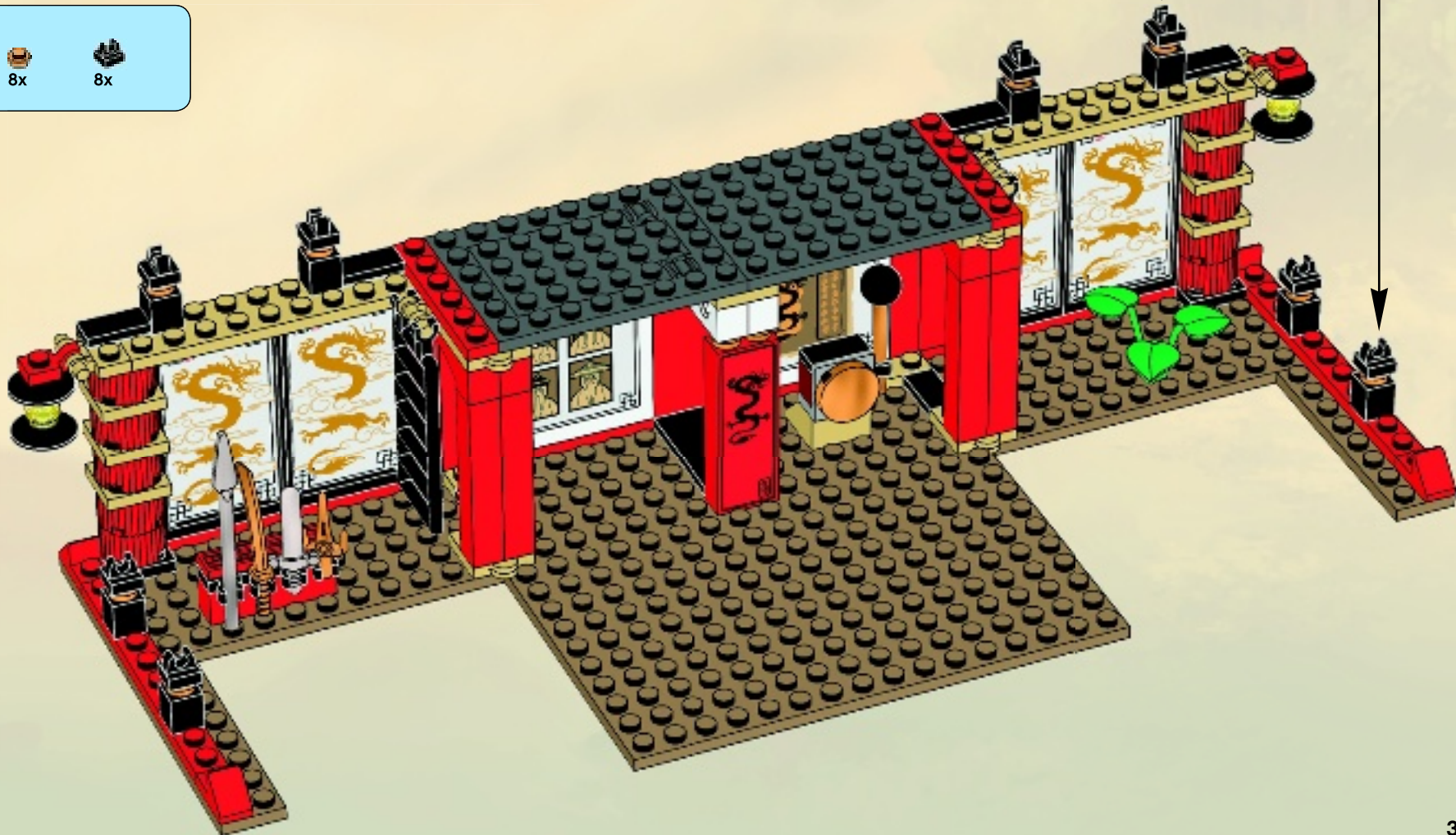



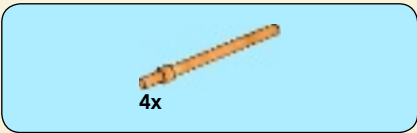

# 23

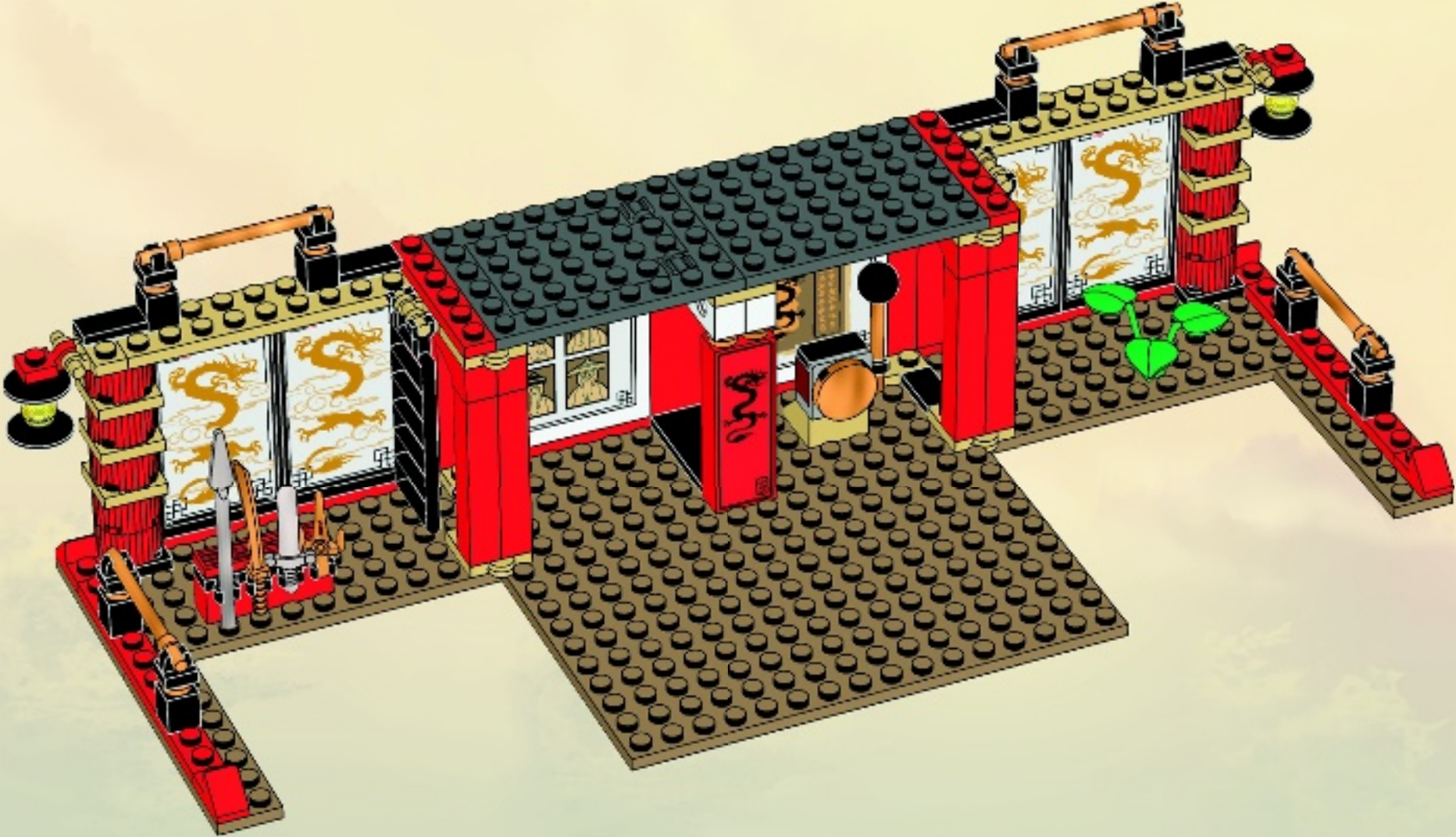

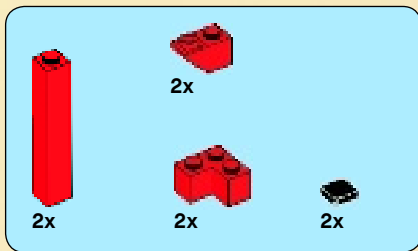

24

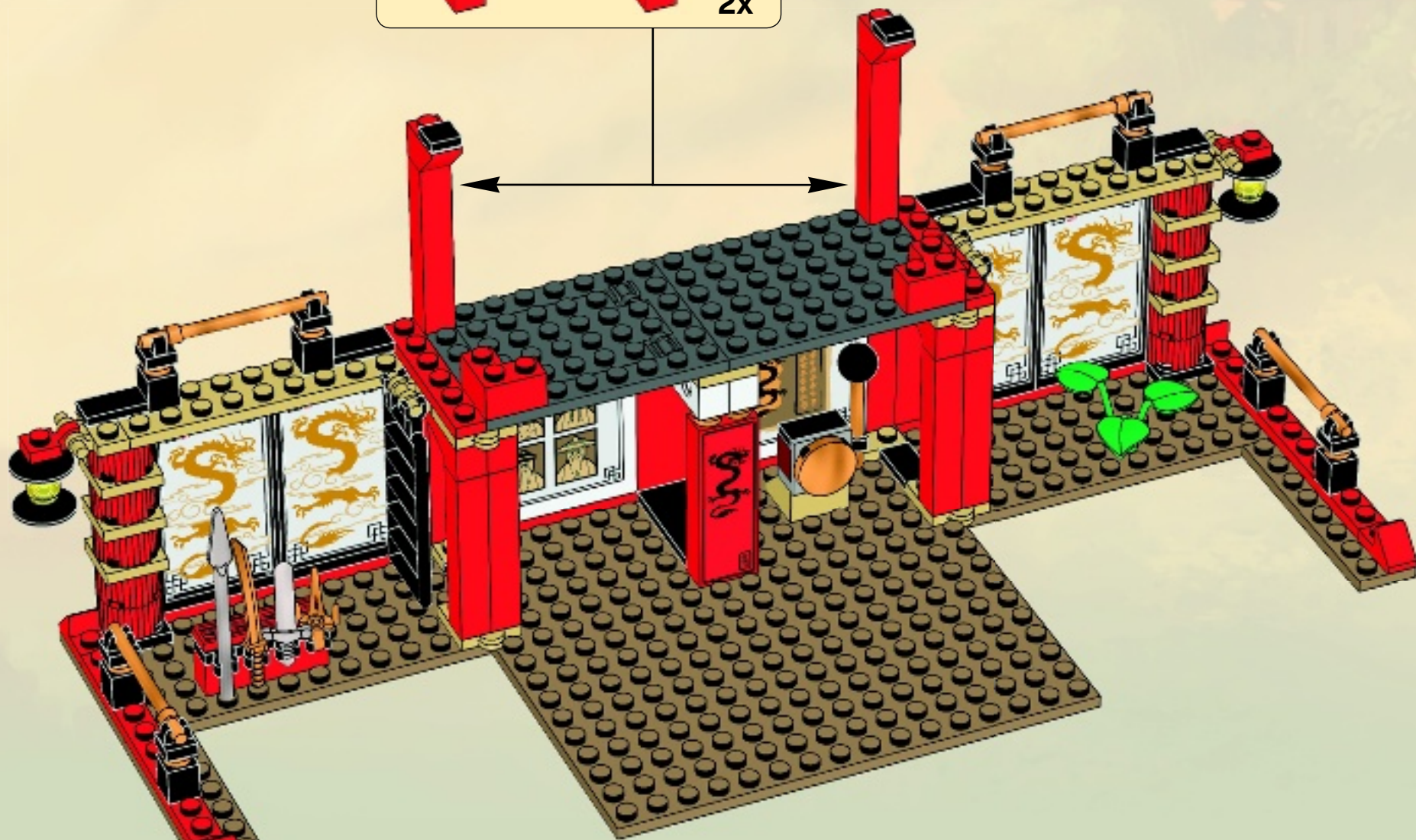
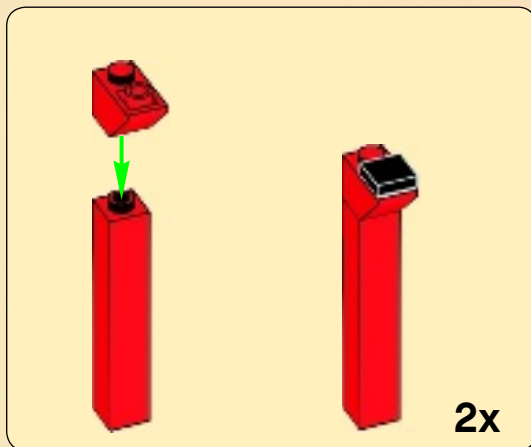



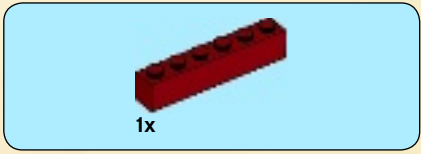

1



2

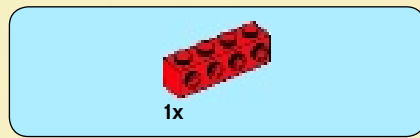
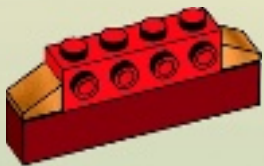

3



4





5



6

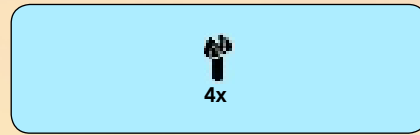

7



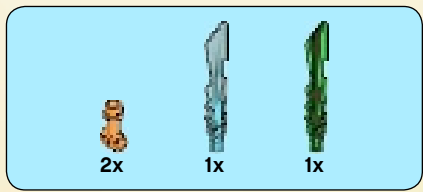

8

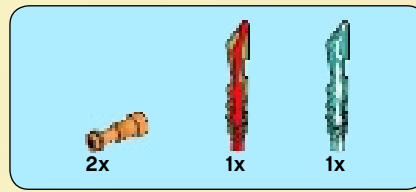
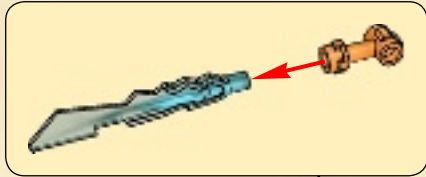

9

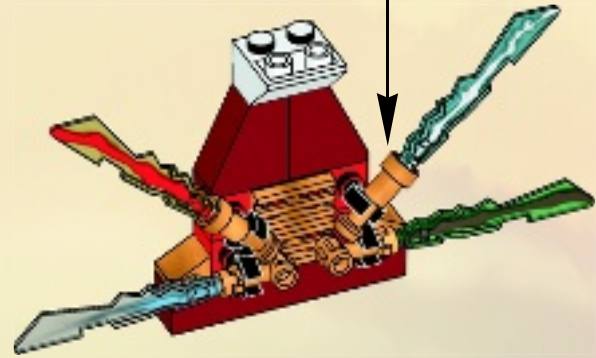
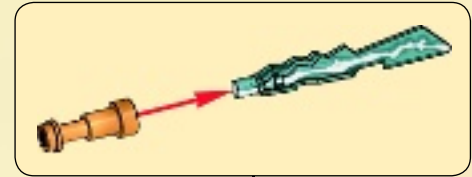



25

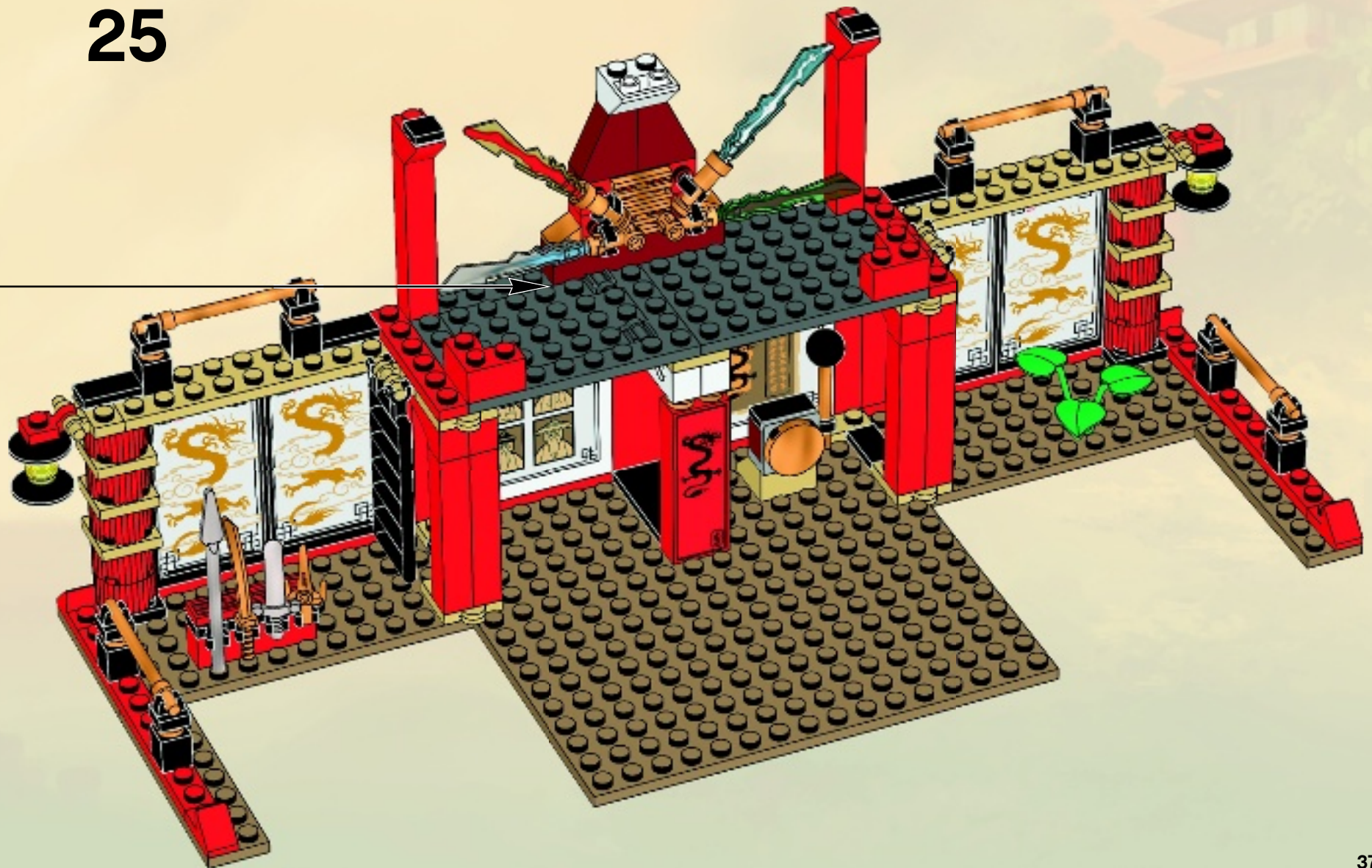



# 26

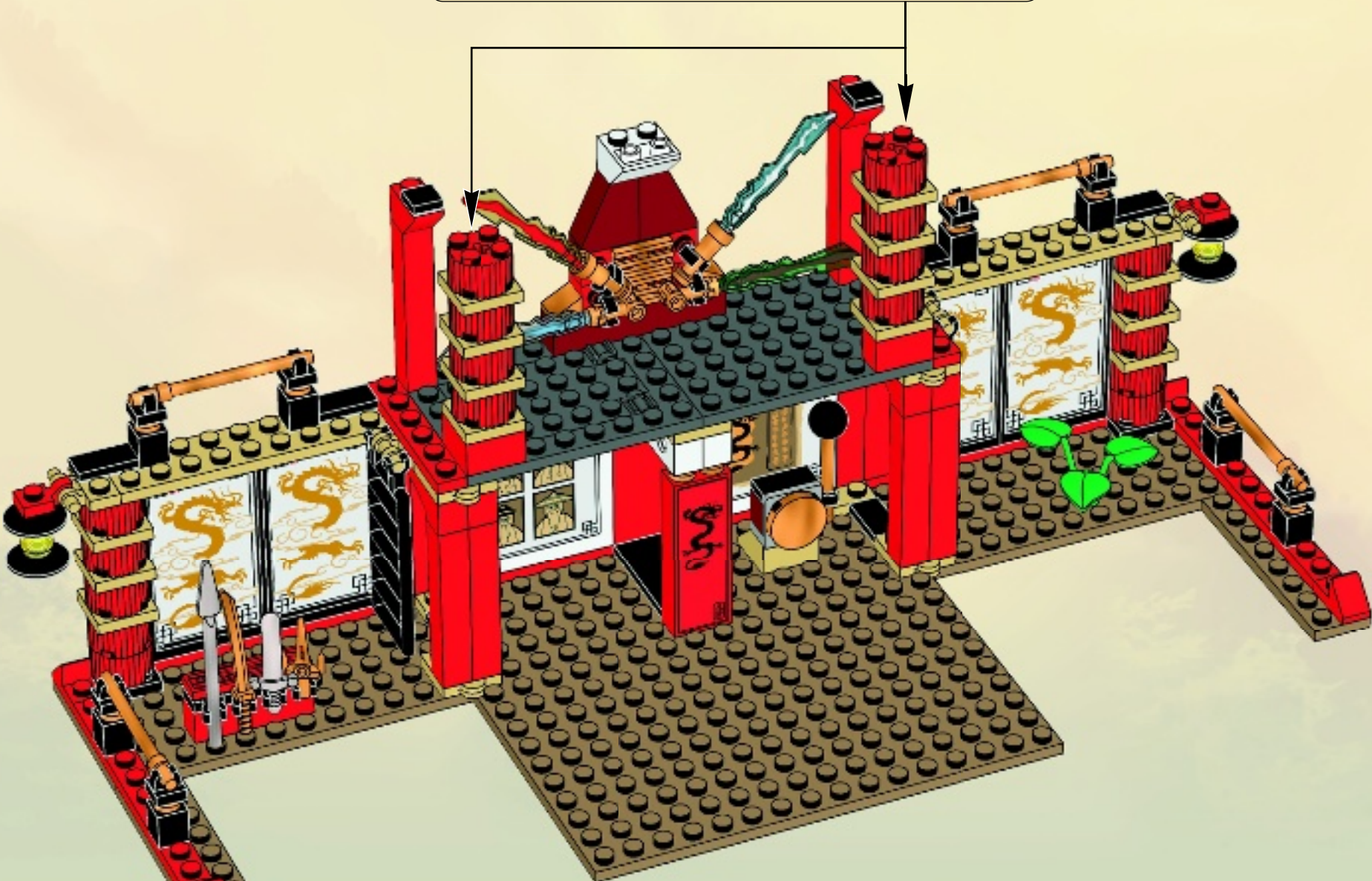
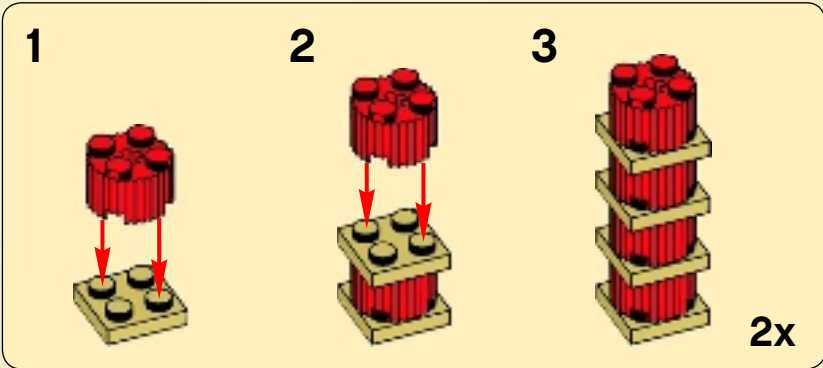



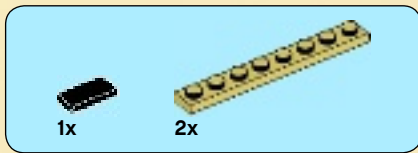

27

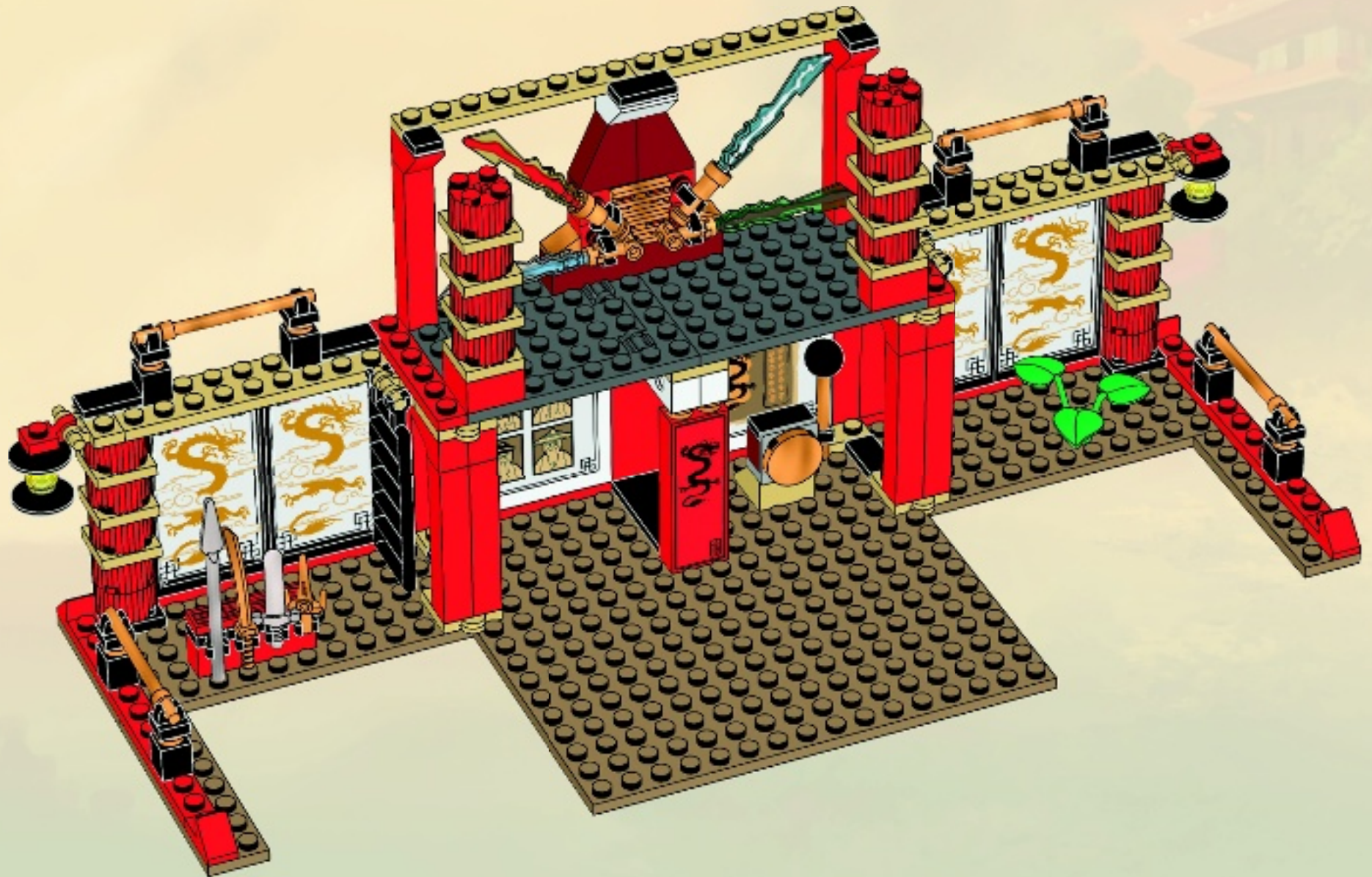



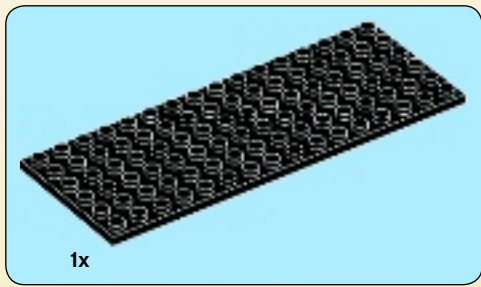

28

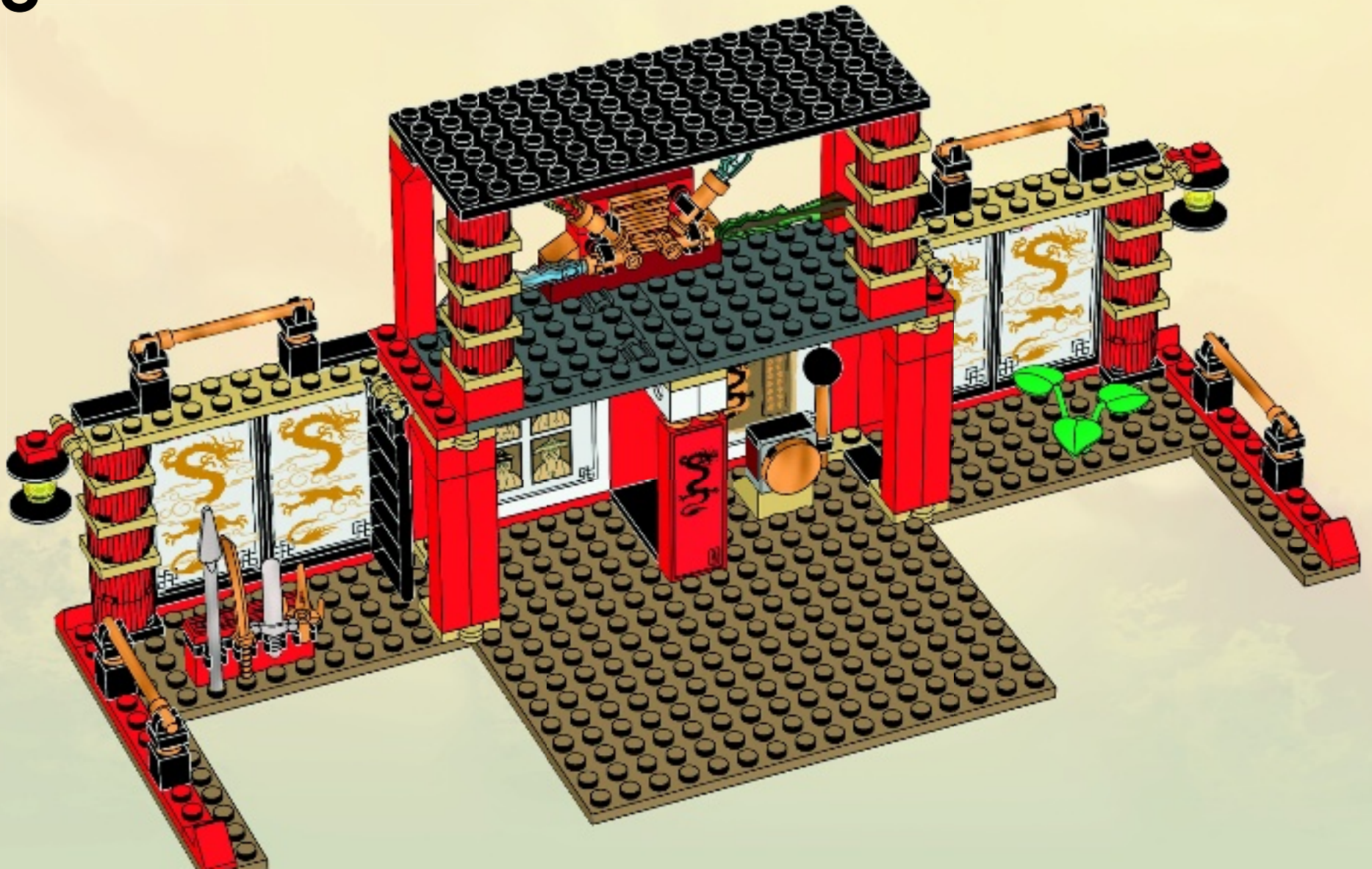



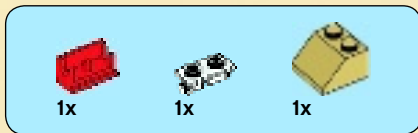

29

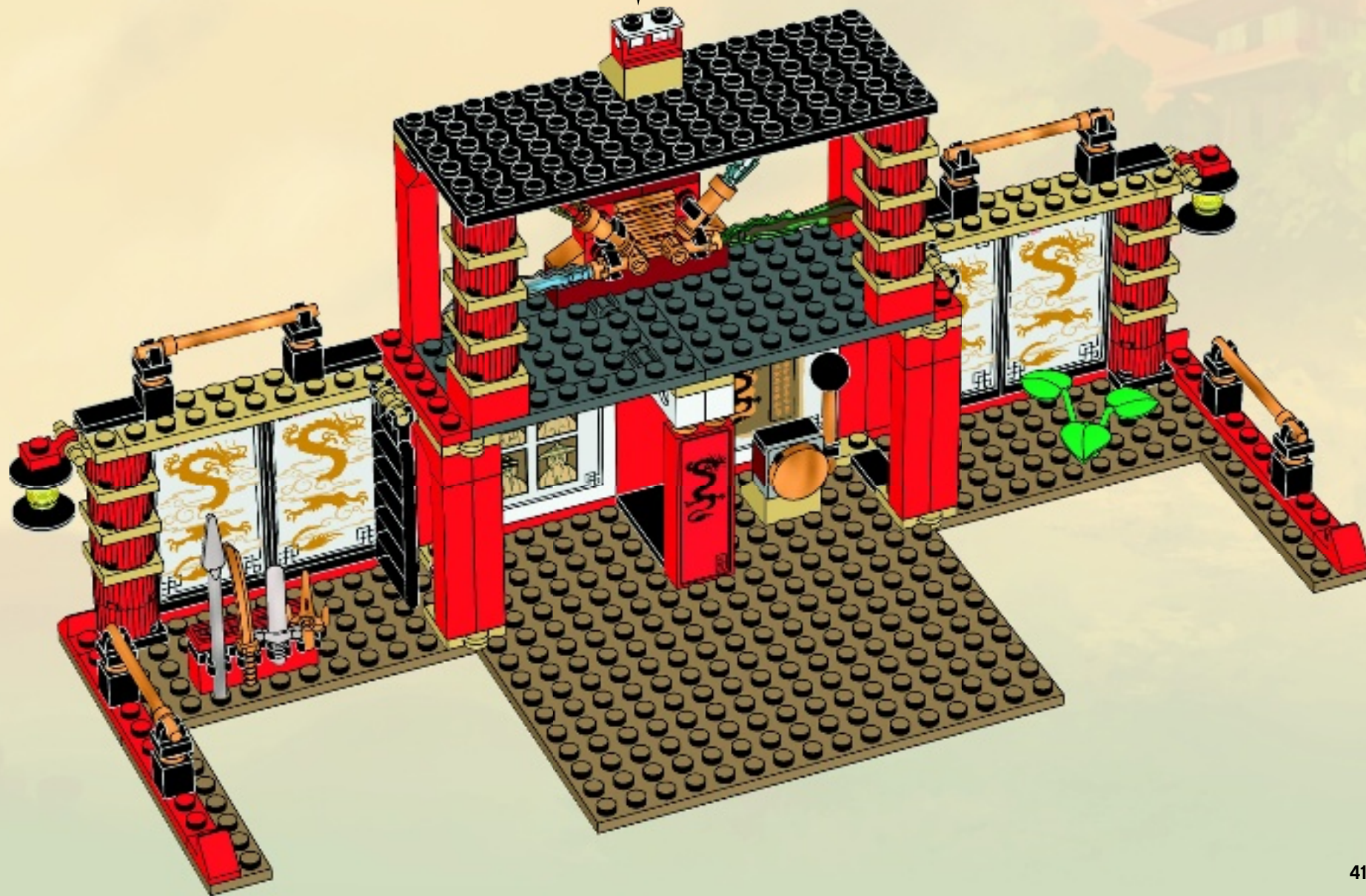
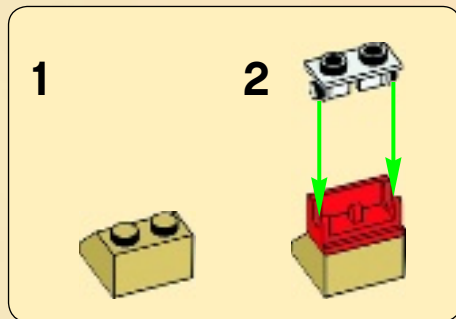



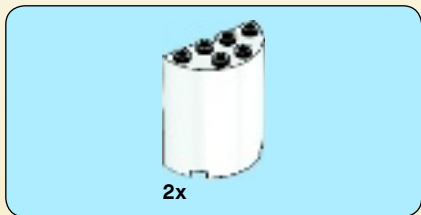

30

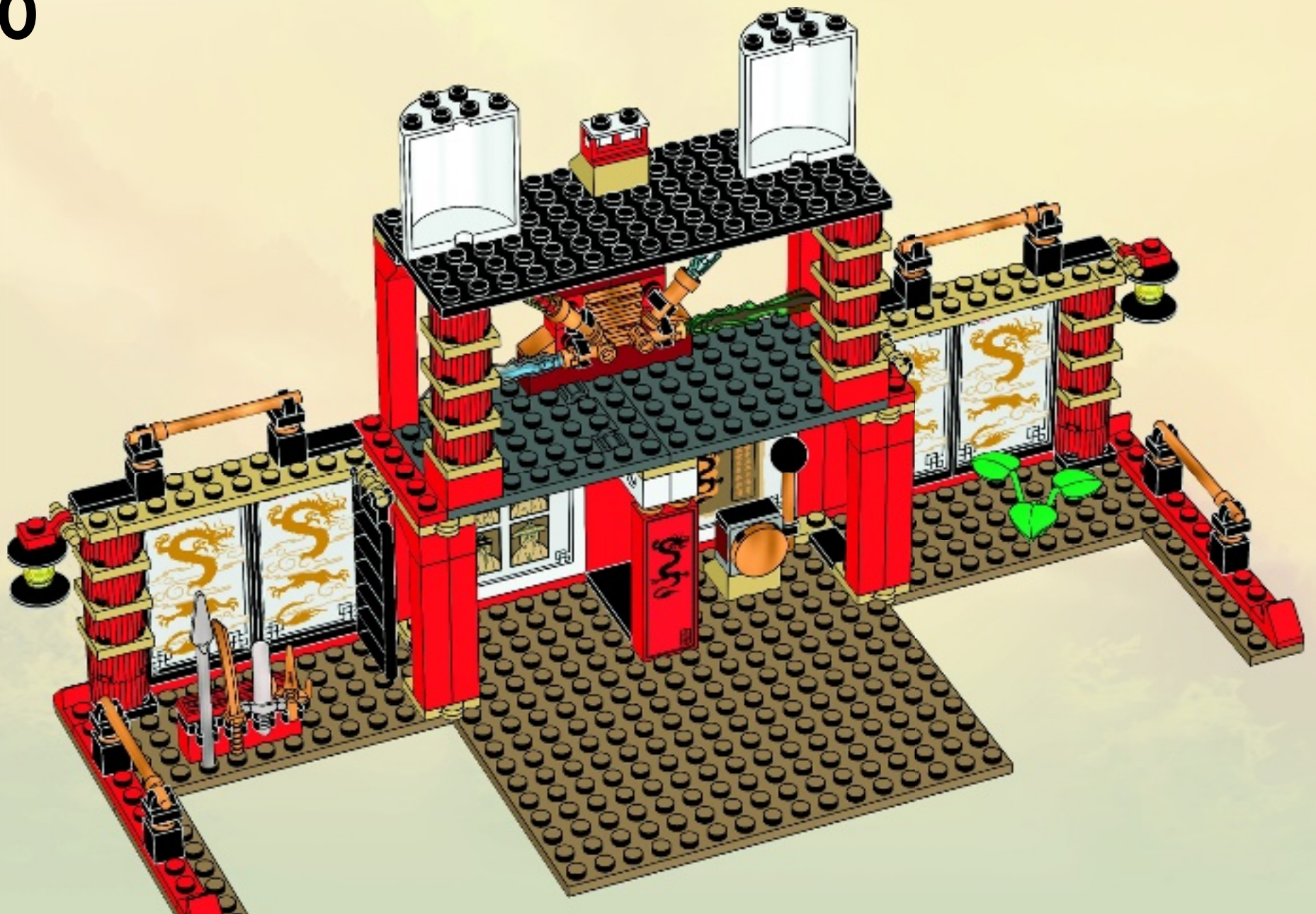





31





2x  4x 

# 32

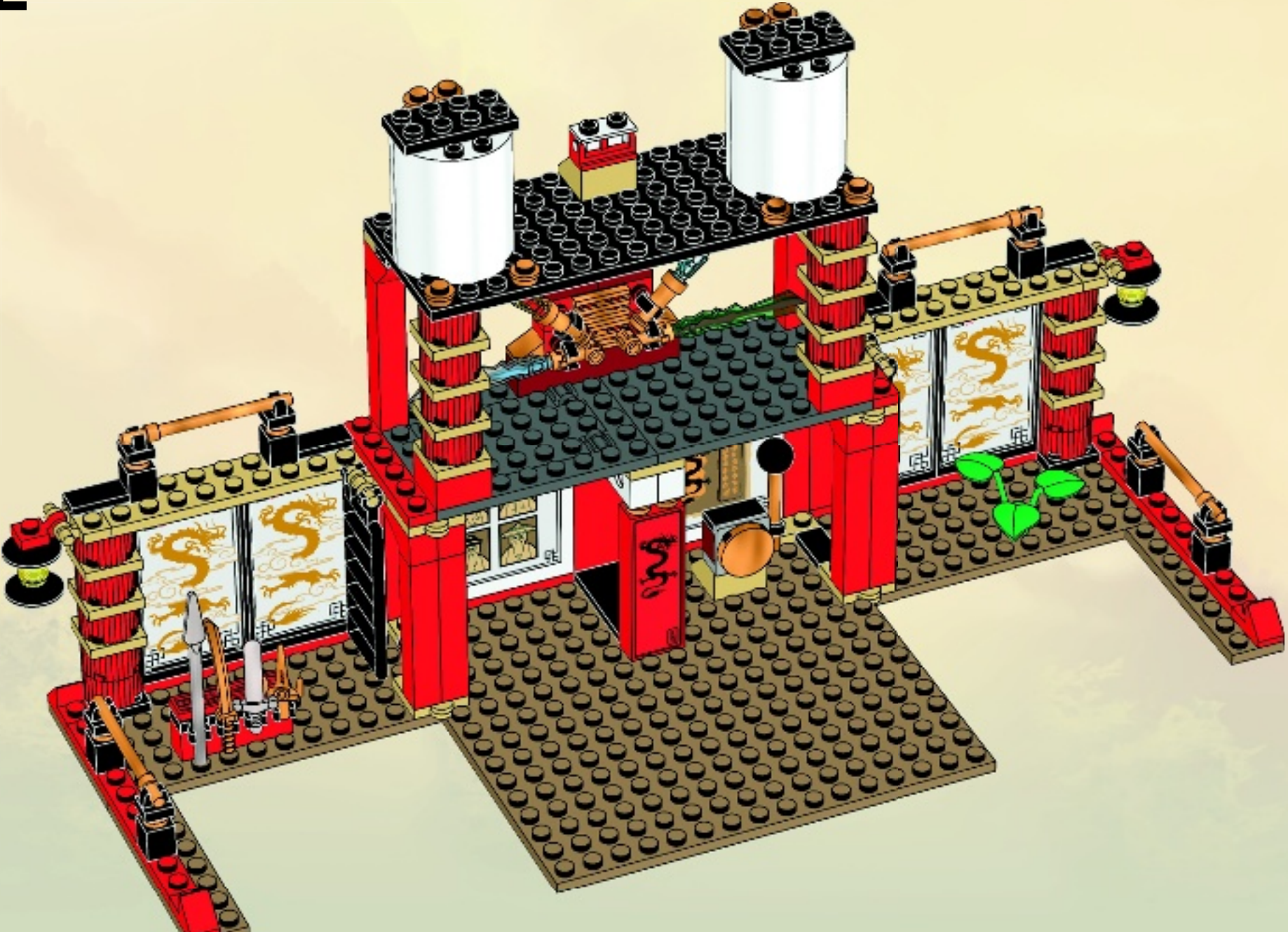





33

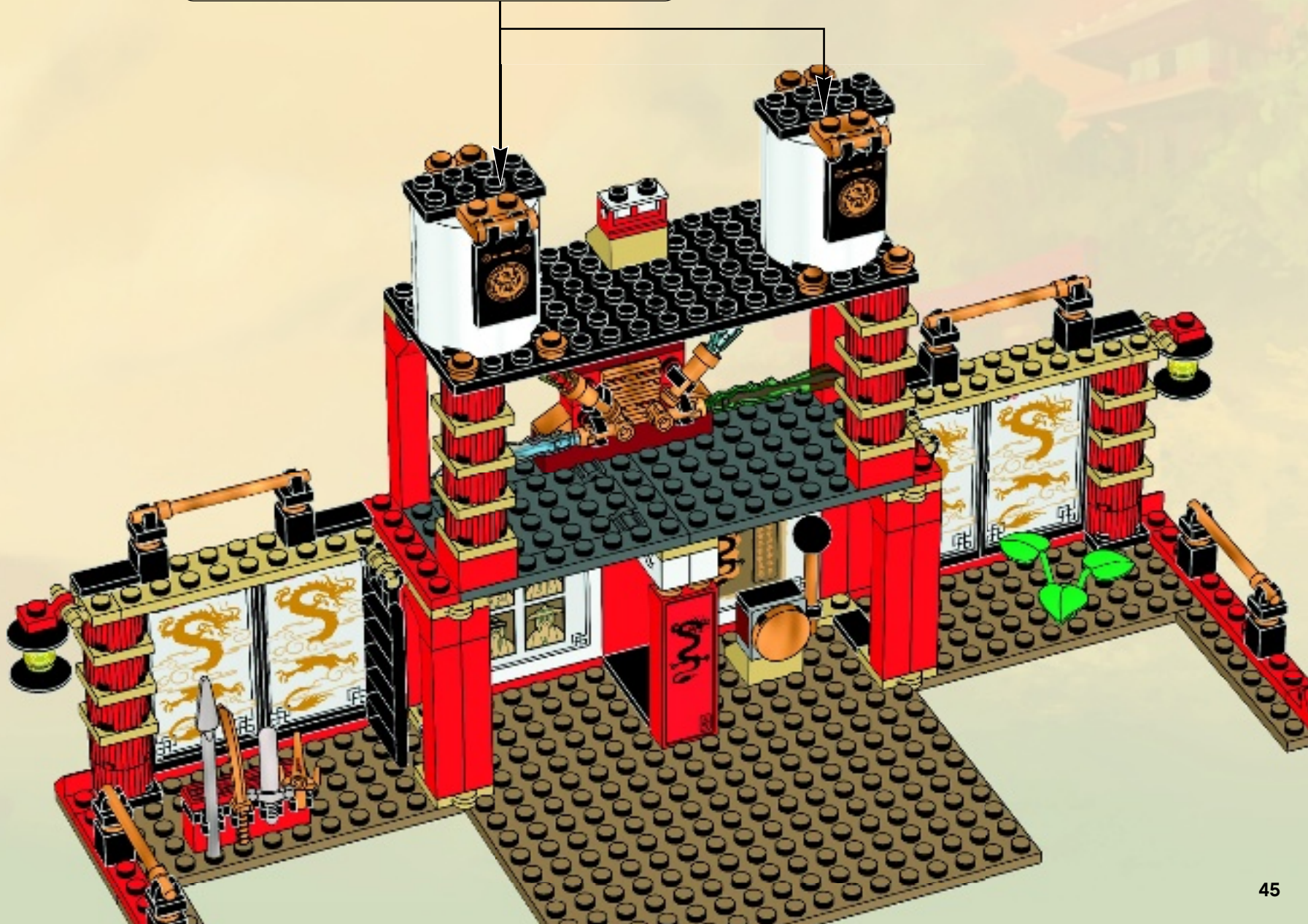
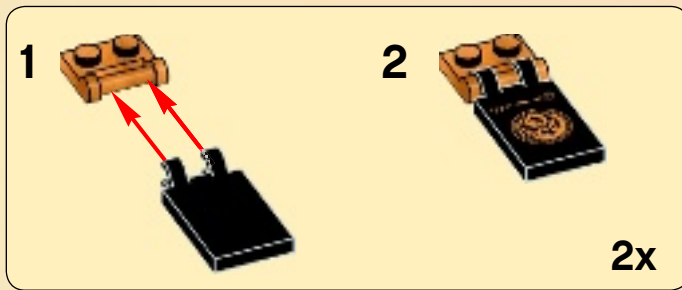



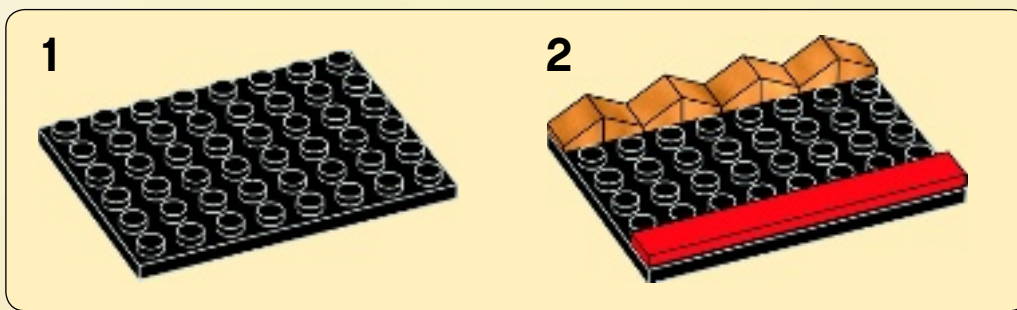
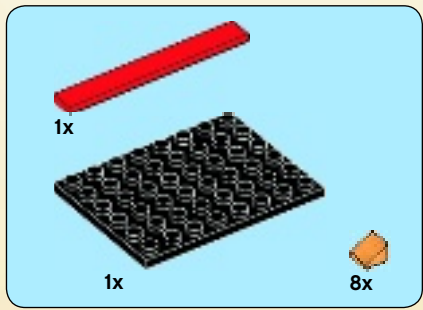

# 34

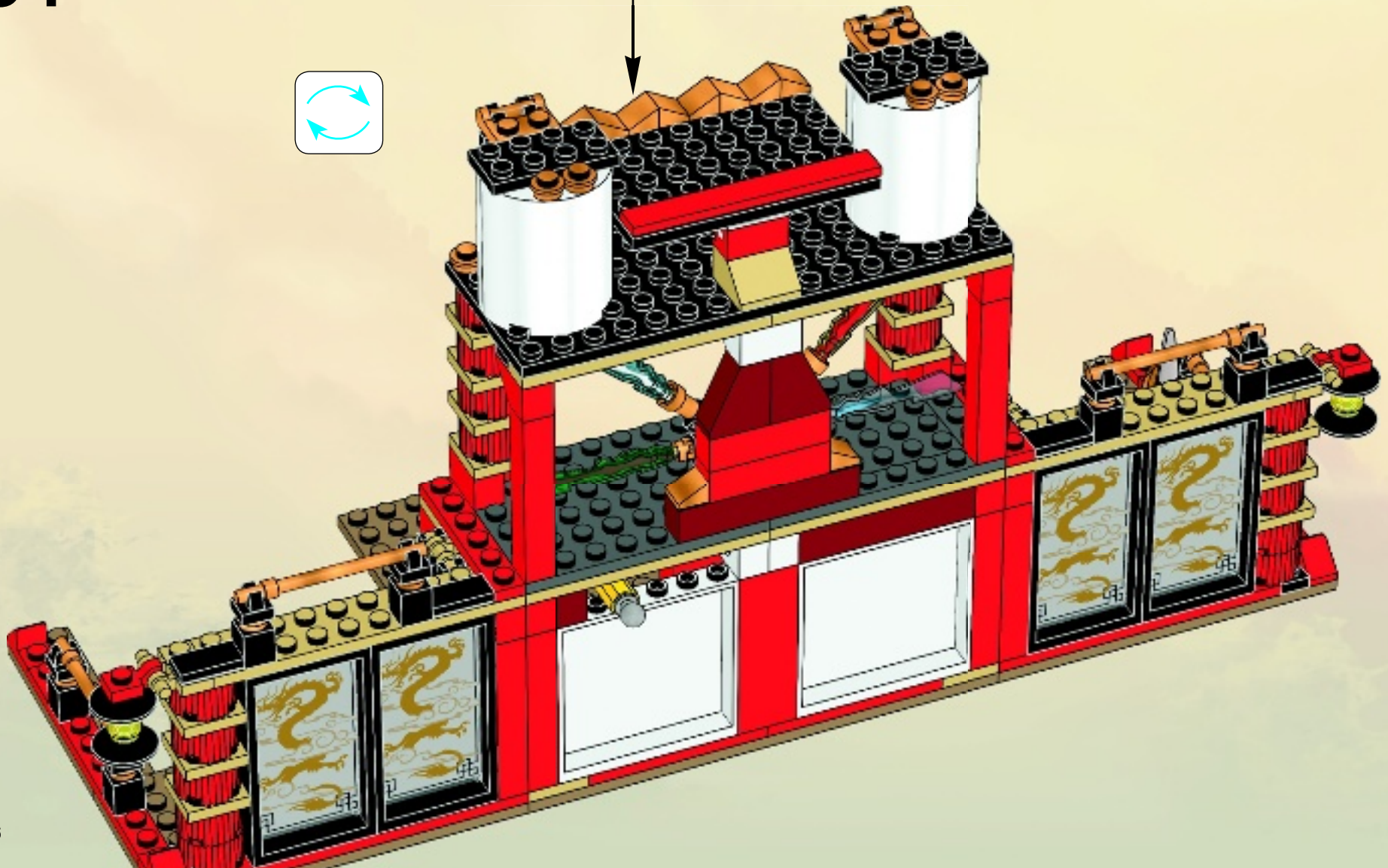
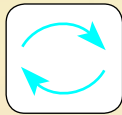



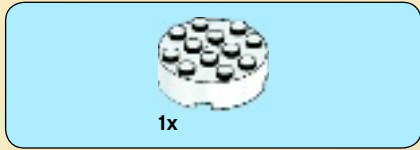

1



2

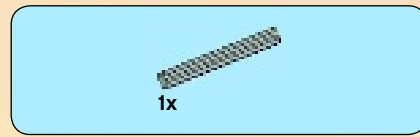

3



4





1x

5



1x

6



2x

7



1x

8

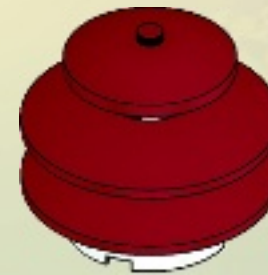



1x

9



1x

10





35

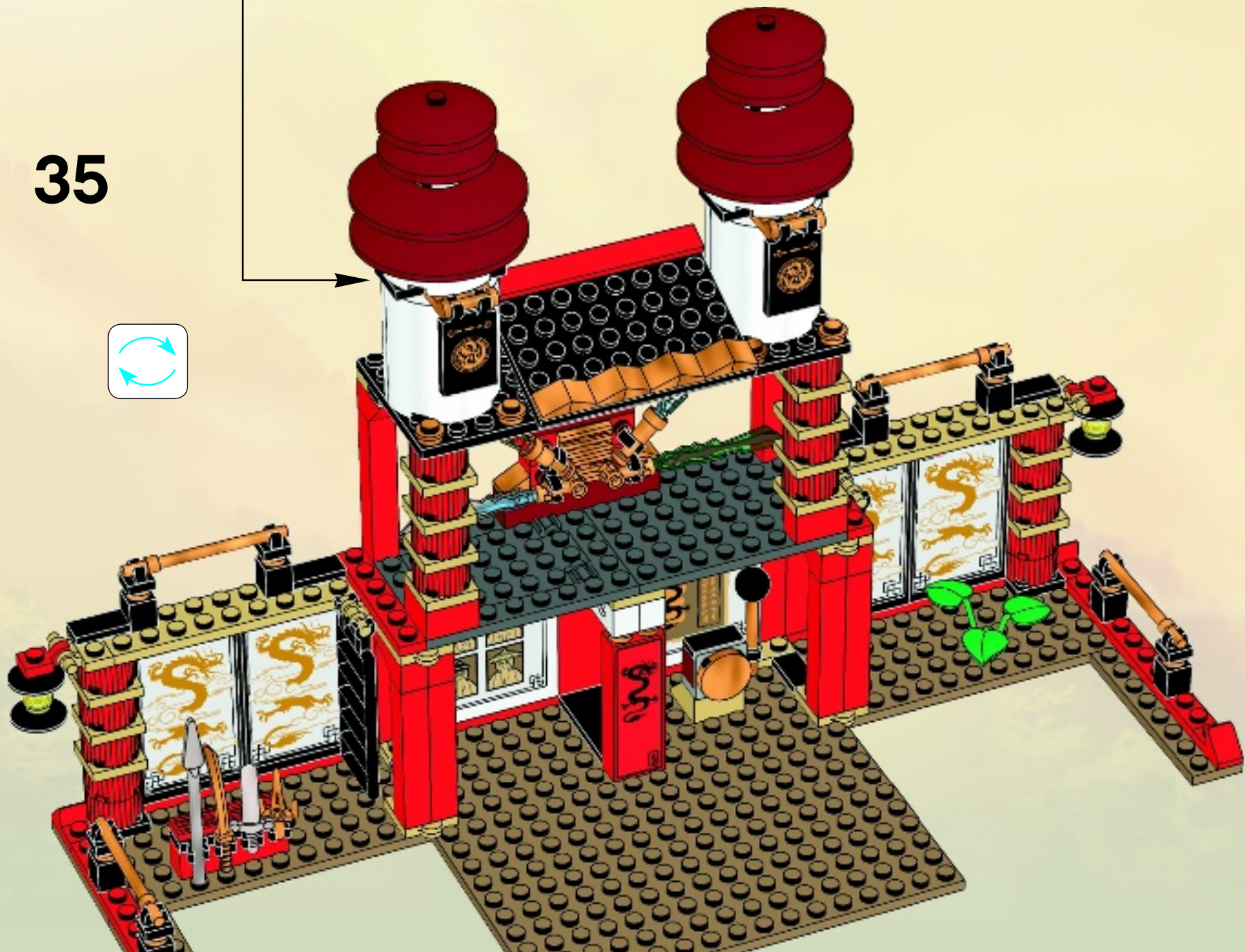
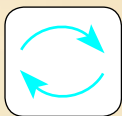



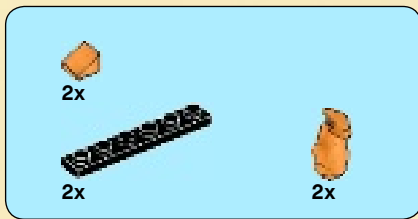

36

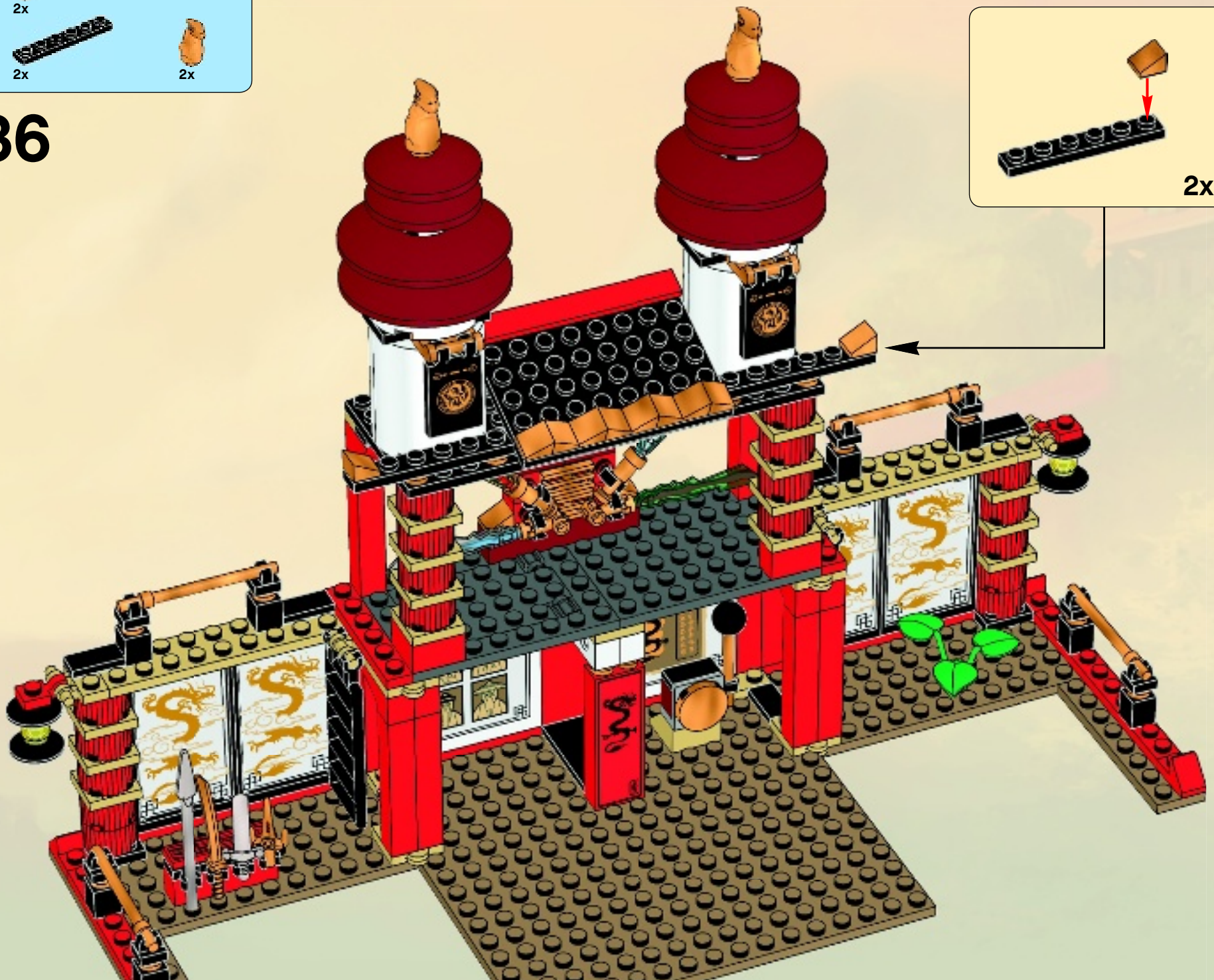

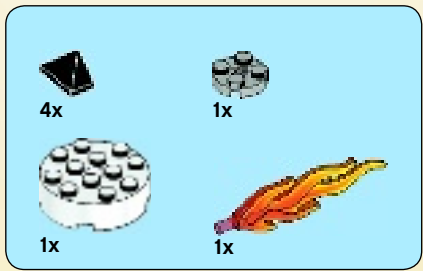

# 37

1



2



3



4











- 2x 300101
- 4x 407001
- 6x 6021315
- 2x 4650644
- 5x 4558956
- 2x 389401
- 4x 4234525
- 9x 366001
- 2x 4259937
- 2x 609101
- 2x 4518992
- 1x 4243812
- 1x 303401
- 1x 6030716
- 4x 4598527
- 4x 4222017
- 2x 4515364
- 1x 4560178
- 1x 4160857
- 1x 4161326
- 7x 403201
- 8x 4278271
- 2x 6003065
- 1x 6022759
- 4x 4163987
- 2x 4504228
- 2x 73737
- 4x 6023099
- 1x 4651720
- 1x 4651703
- 1x 4260649
- 1x 4609289
- 1x 393801
- 2x 4509912
- 2x 4114322
- 18x 4114084
- 4x 4114077
- 6x 4118790
- 4x 4114309
- 1x 4113993
- 4x 4114324
- 2x 4249019
- 14x 4278046
- 6x 4140593
- 4x 4227507
- 2x 4514554
- 10x 4212410
- 2x 4212414
- 2x 235721
- 1x 301021
- 2x 4157223
- 18x 4650646
- 2x 366521
- 4x 4603263
- 4x 4620762
- 4x 366621
- 4x 447721
- 1x 6030717
- 2x 4524644
- 1x 243121
- 1x 416221
- 2x 6016173
- 1x 6019652
- 1x 6020757
- 1x 393721
- 1x 4227155
- 4x 4142865
- 1x 4513174
- 1x 4526984
- 1x 4611432
- 1x 4519010
- 8x 300526
- 1x 4533771
- 1x 4275826
- 4x 304826
- 2x 242026
- 2x 302026
- 2x 366626
- 1x 303626
- 1x 302726
- 1x 6021269
- 2x 307026
- 8x 6030718
- 4x 4550017
- 8x 306926
- 2x 4297713
- 1x 4560182
- 4x 474026
- 4x 4535834
- 2x 602026
- 1x 4538722
- 1x 4596914
- 1x 4650761
- 1x 6020160
- 1x 6023669
- 1x 6017976
- 1x 6017991
- 1x 6023373
- 2x 6020753
- 1x 4598897
- 1x 4114206
- 4x 4289538
- 1x 4290713
- 1x 4106895
- 4x 6029885
- 1x 6022109
- 1x 4548009
- 1x 6022638
- 2x 3006844
- 1x 6020758
- 1x 3005748
- 1x 6022644
- 1x 4654448
- 2x 4246957





2x  
4266897



1x  
4613196



1x  
4566927



2x  
4541376



2x  
4541528



2x  
4645101



4x  
4541386



4x  
6024146



5x  
4211397



11x  
4654580



8x  
4654582



3x  
4211475



4x  
4211758



1x  
4211375



2x  
4211639



4x  
4211128



2x  
4497253



2x  
4227395



2x  
4498096



4x  
4547958



9x  
4211063



1x  
4210794



1x  
4277928



8x  
6000606



1x  
4595710



1x  
4595708



3x  
4211042



2x  
6018493



2x  
4522784



1x  
4210665



1x  
4499858



22x  
4587002



9x  
6018482



8x  
4585621



1x  
4579099



11x  
4490599



2x  
4585493



8x  
6005488



36x  
4523159



5x  
4649422



2x  
4538126



1x  
4600267



5x  
4600270



1x  
6021479



1x  
6021340



1x  
6021209



2x  
4649896



8x  
6006741



2x  
4640843



1x  
4614404



1x  
6019607



2x  
4646843



2x  
4646866



1x  
4646814



2x  
4618195



2x  
6023891



2x  
4286597



1x  
4646835



1x  
6020990



1x  
6020190



1x  
4646835



1x  
6020990



1x  
6020190



1x  
4611883



1x  
4617248



1x  
4646806



1x  
4650750



LEGO.com

LEGO and the LEGO logo are trademarks of the LEGO Group. ©2013 The LEGO Group. 6062192



Customer Service  
Kundenservice  
Service Consommateurs  
Servicio Al Consumidor  
LEGO.com/service or dial

00800 5346 5555 :   
1-800-422-5346 :