



# Harry Potter



4842





1

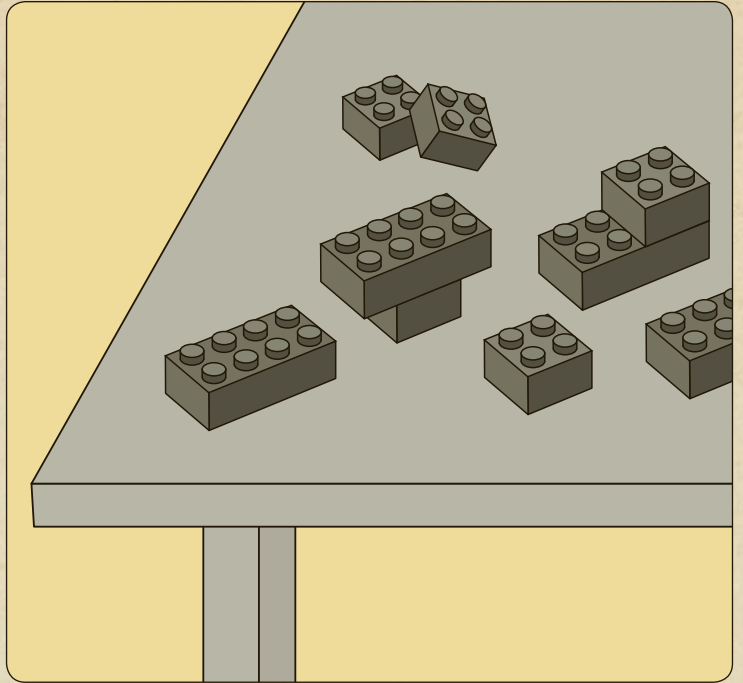
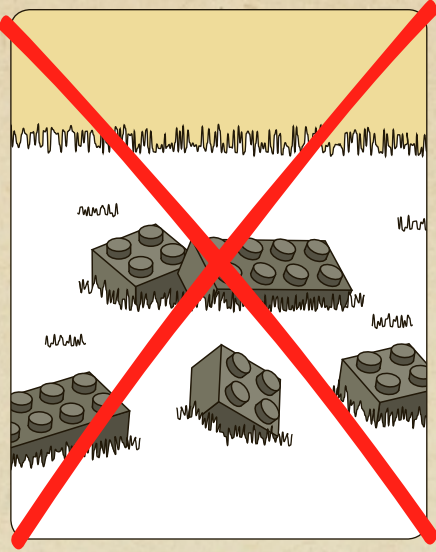

2





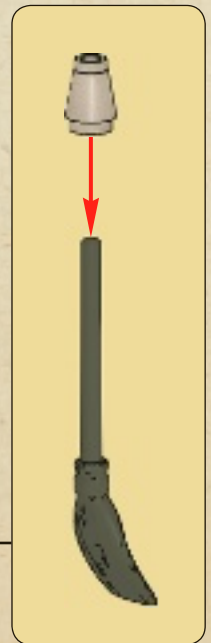
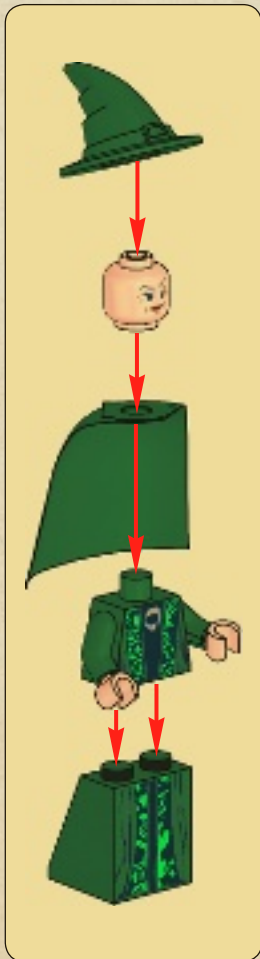
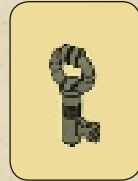



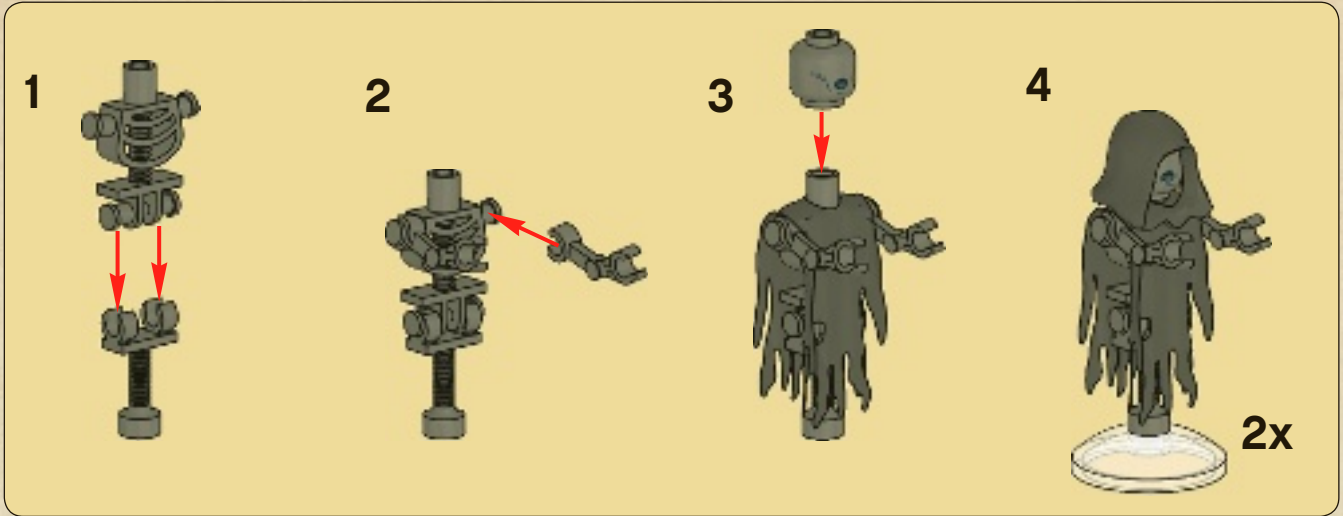

1

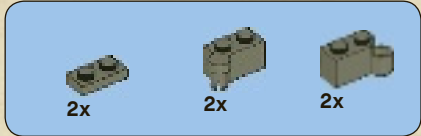
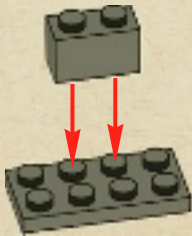

2

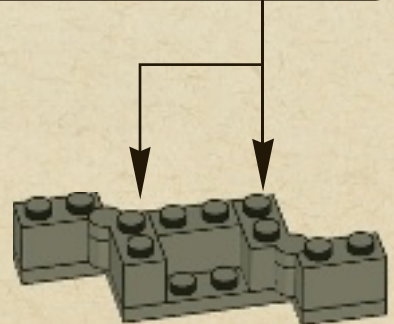
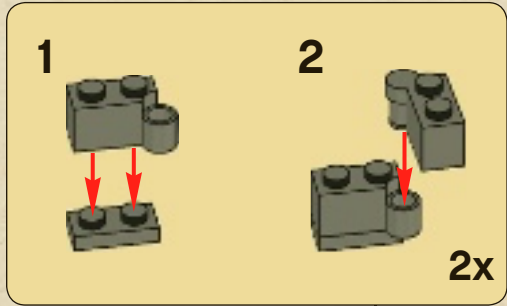





3

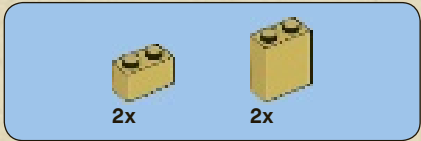

4

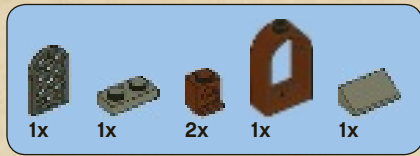
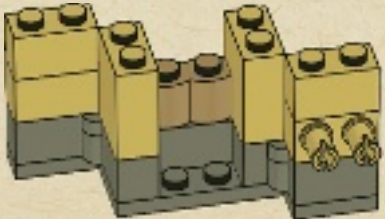

5

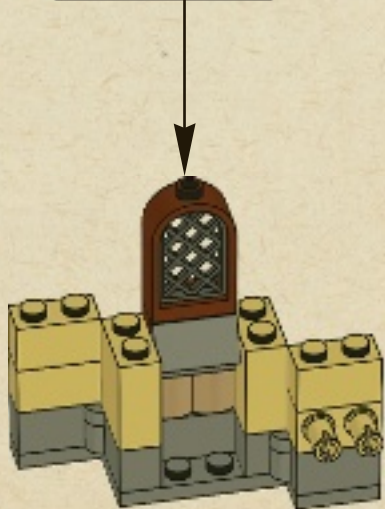





2x

6

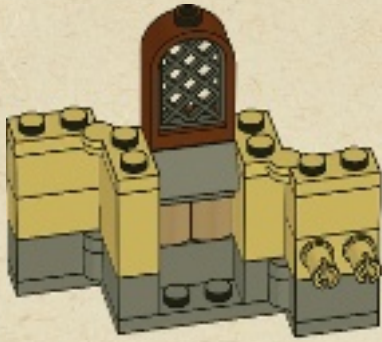

1x



2x

8

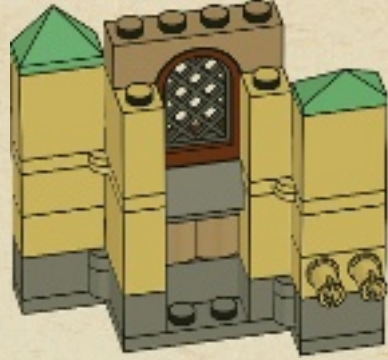

4x

7

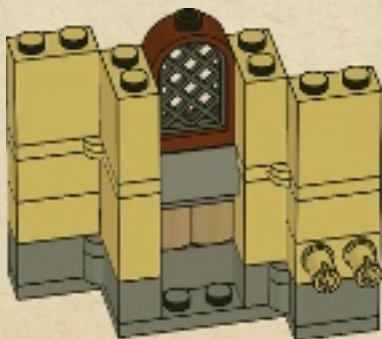

2x

9

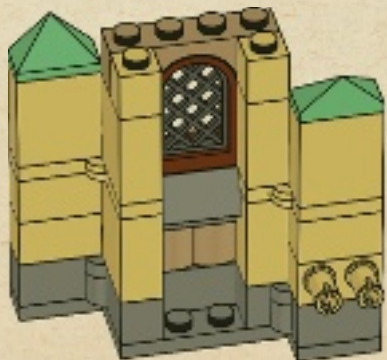





10



11

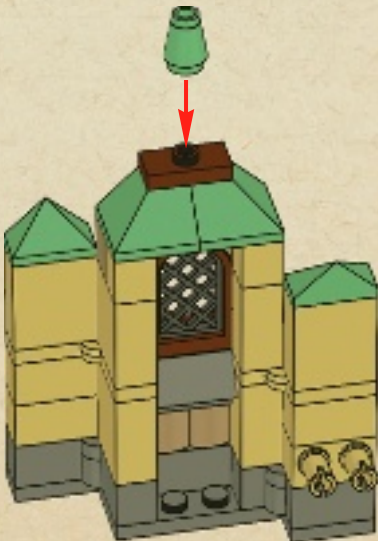

1

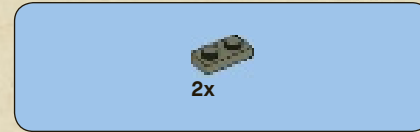
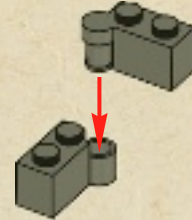

2

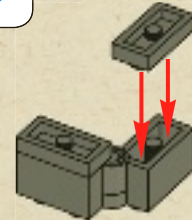
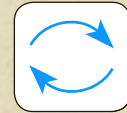

3

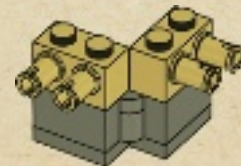





1x

4

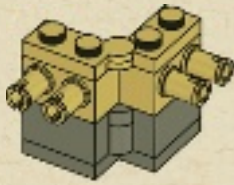

2x

6

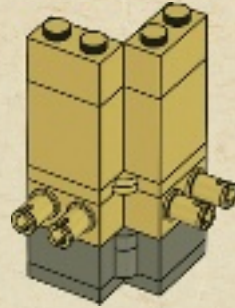

2x

5

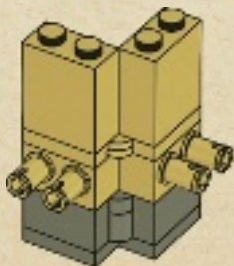

2x

7

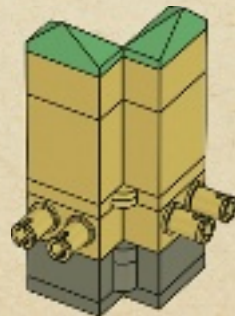

2x



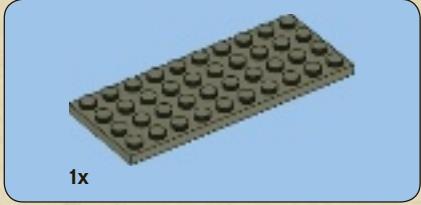
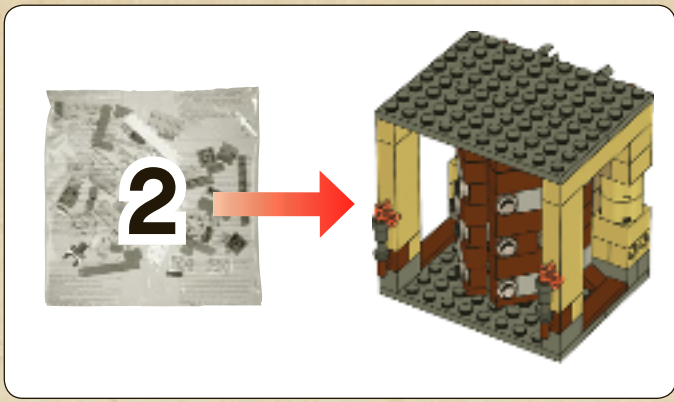

1

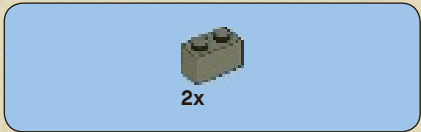
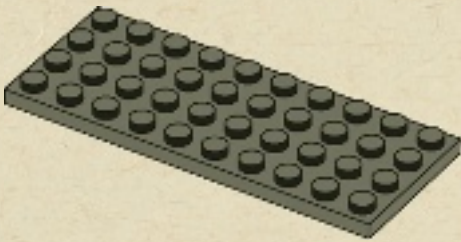

2

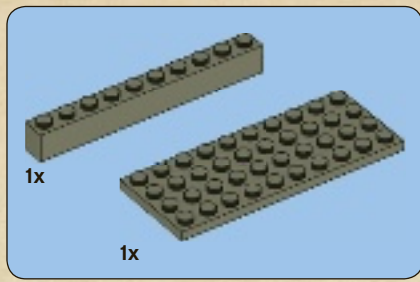
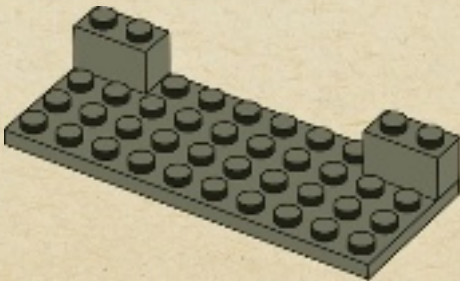

3

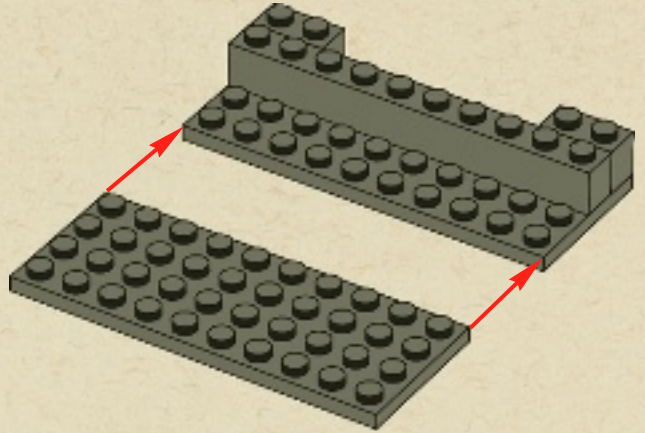

4

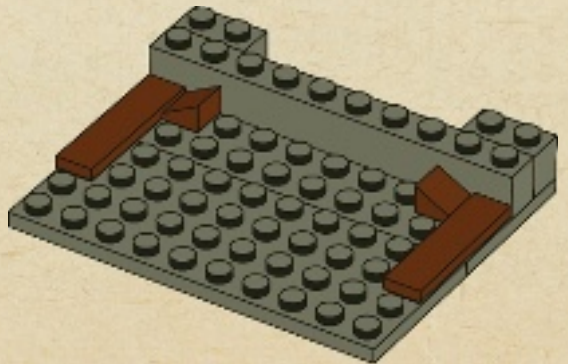





5

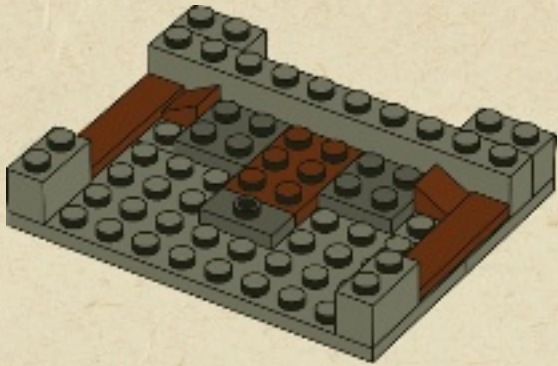

6

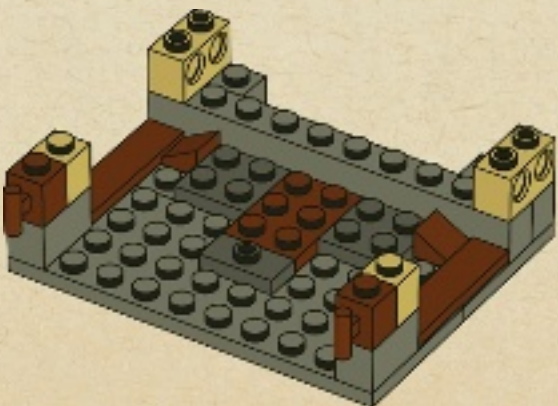

7

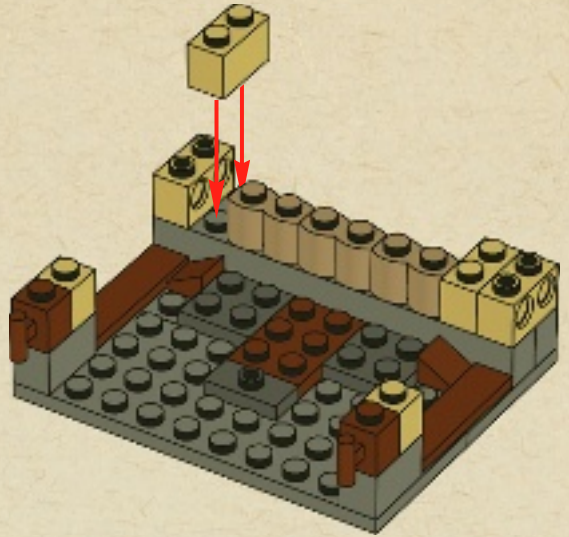

8

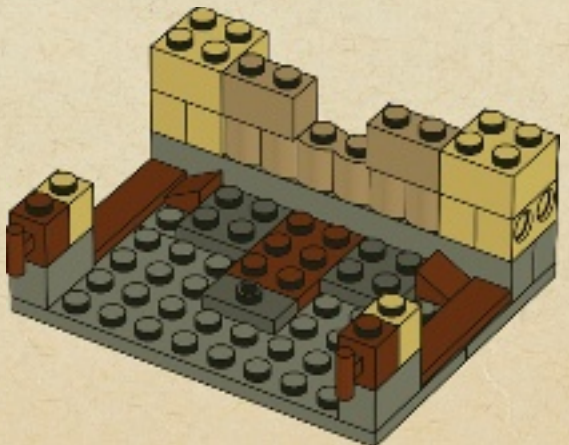



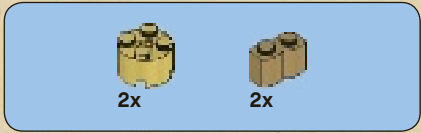

9

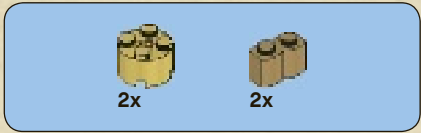
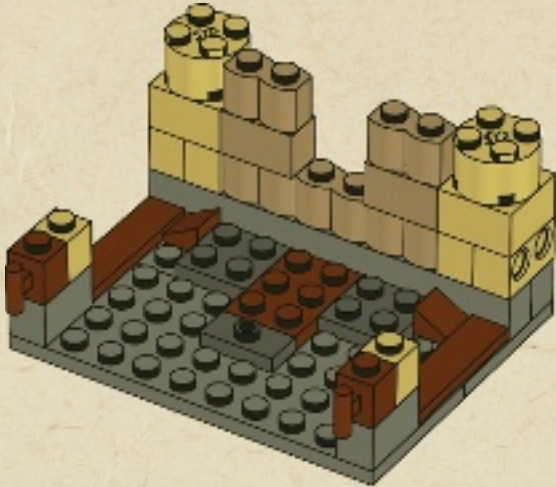

10

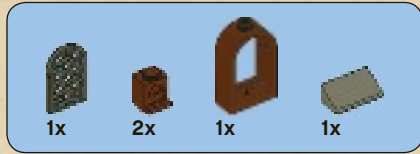
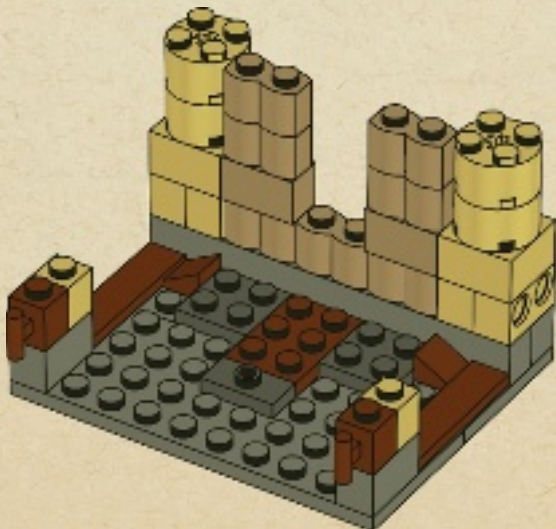

11

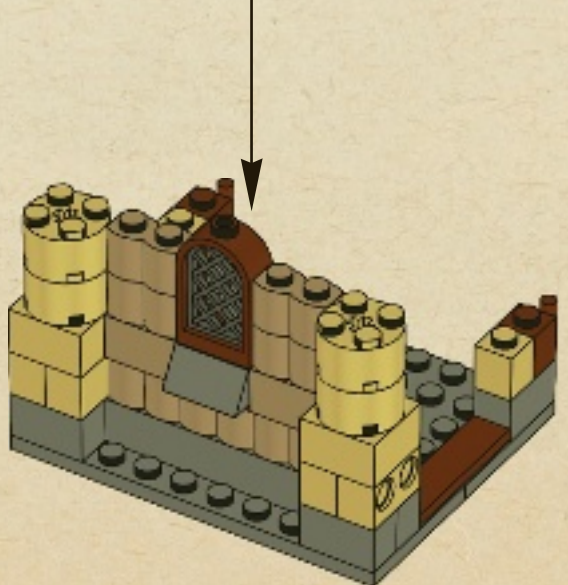



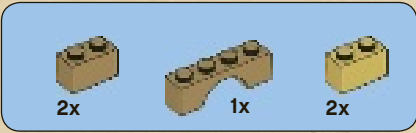

12

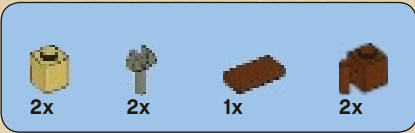
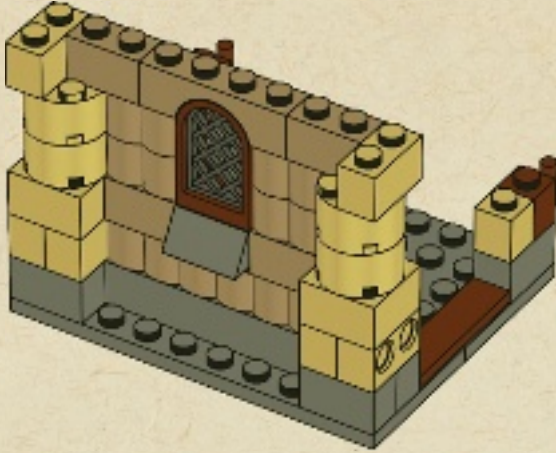

14

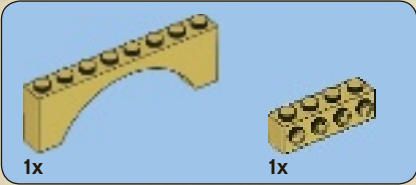
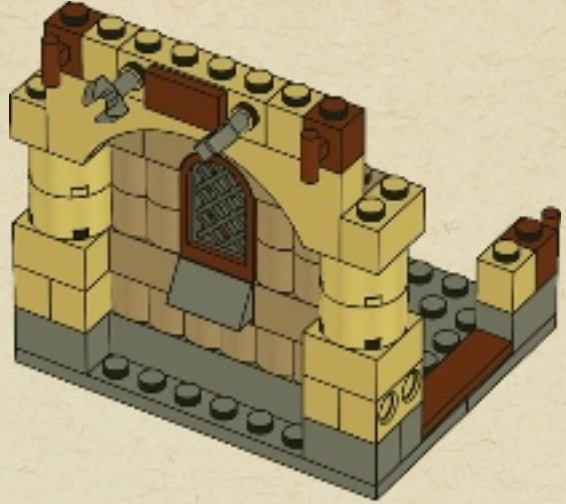

13

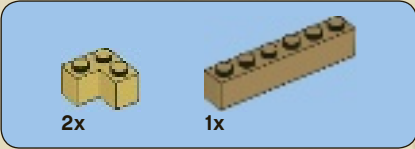
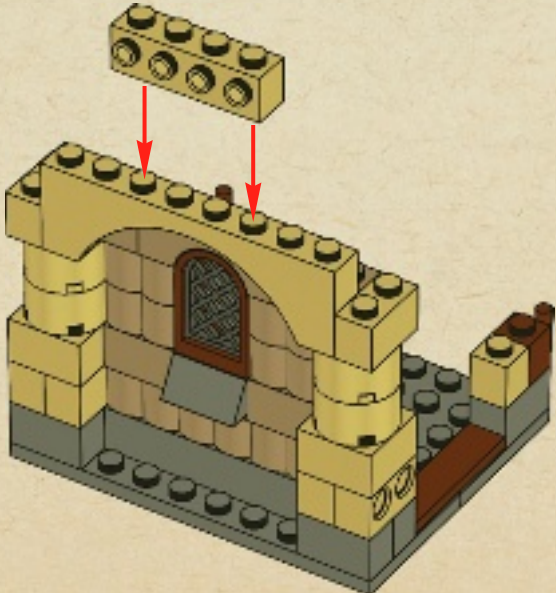

15

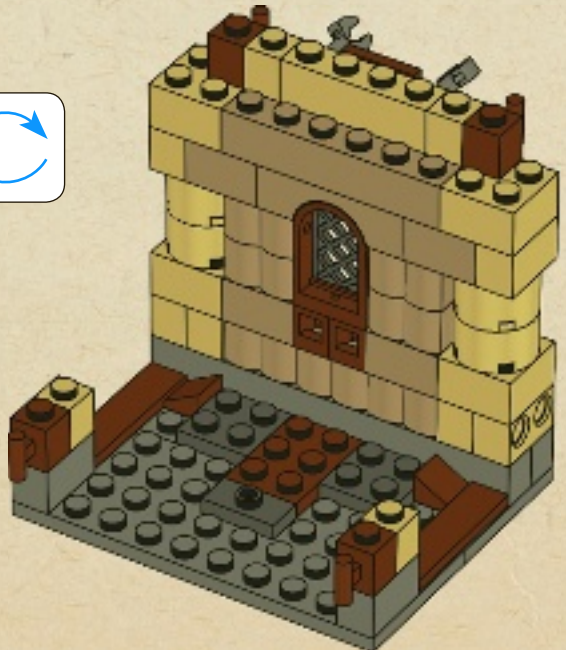





1

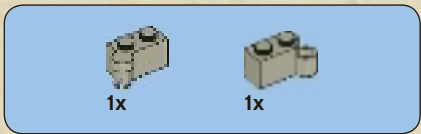
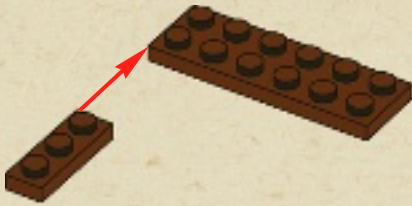

2

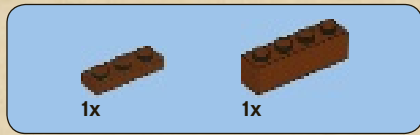
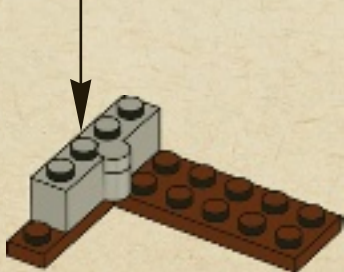
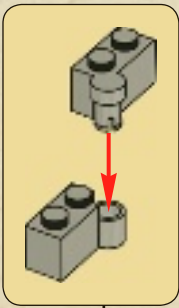

3

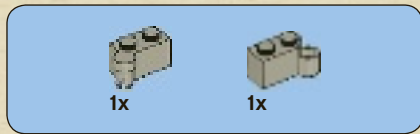
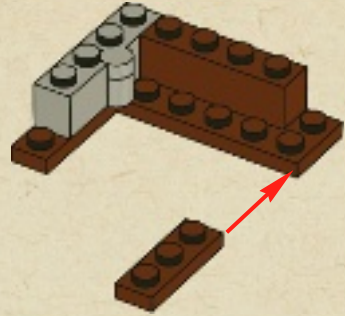

4

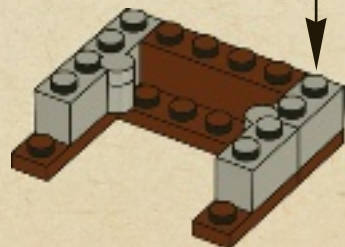
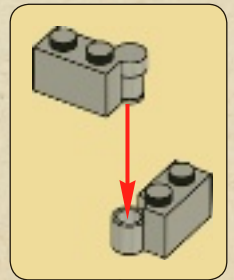





2x



2x

5

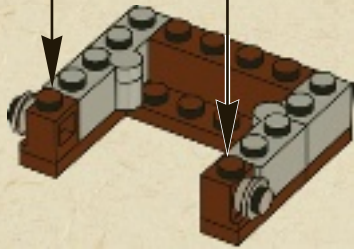

2x



1x

7

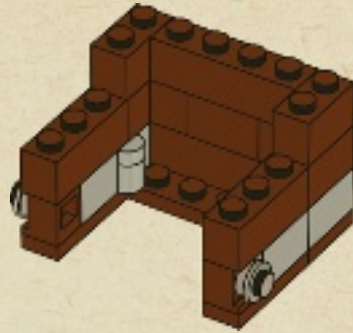

1x



2x



2x

6

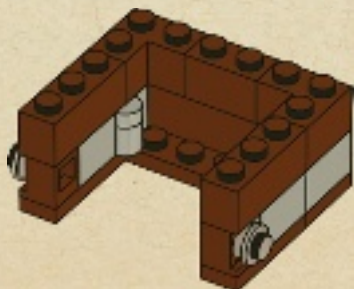

2x



4x



4x

8

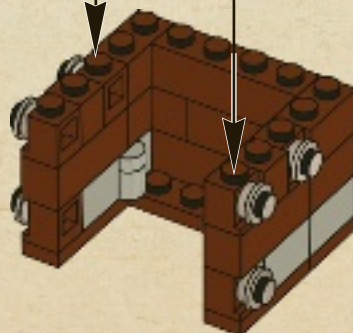





9

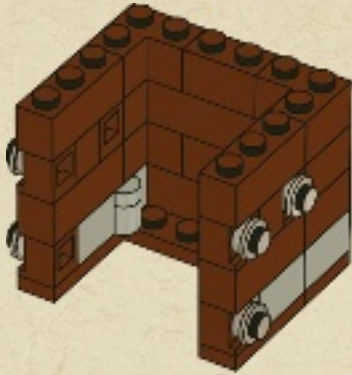

11

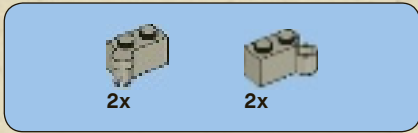
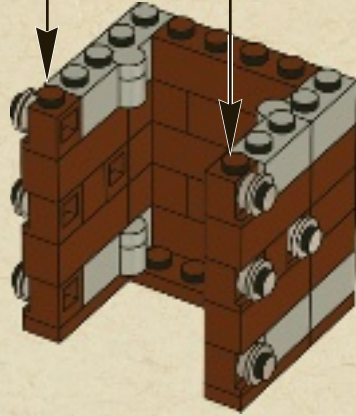
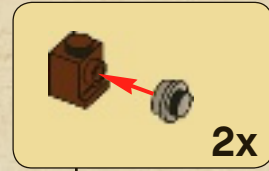

10

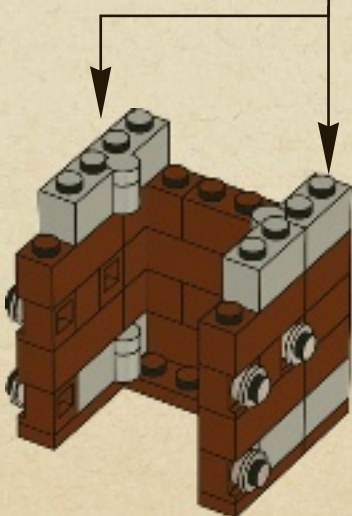
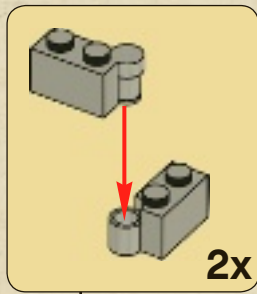

12

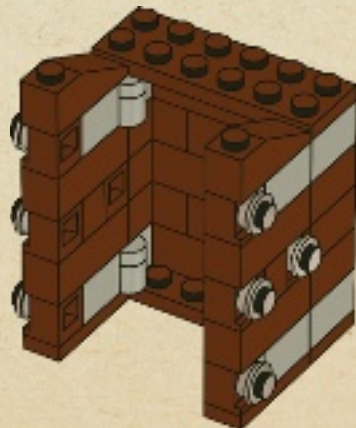





2x

13

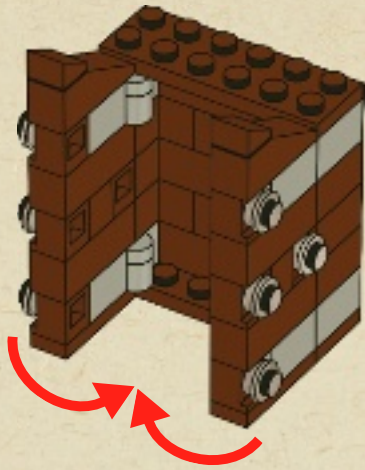

2x

17

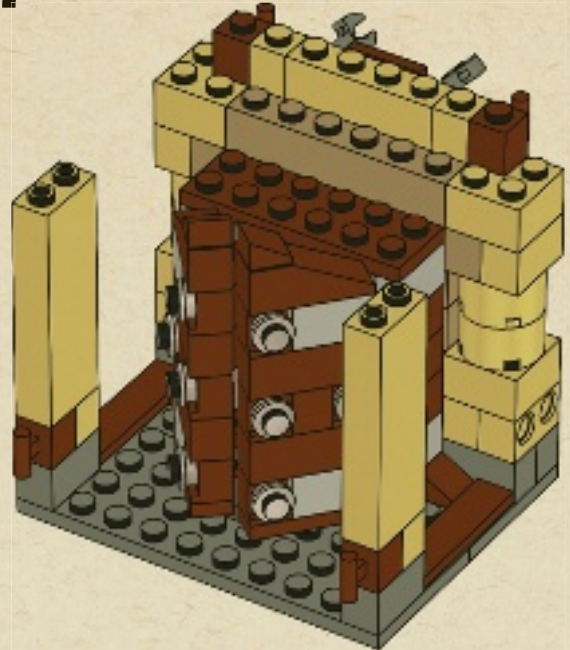

2x

16

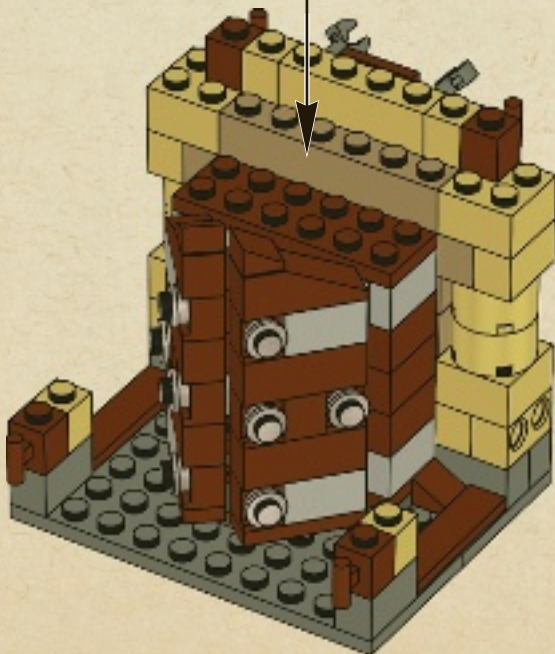

18

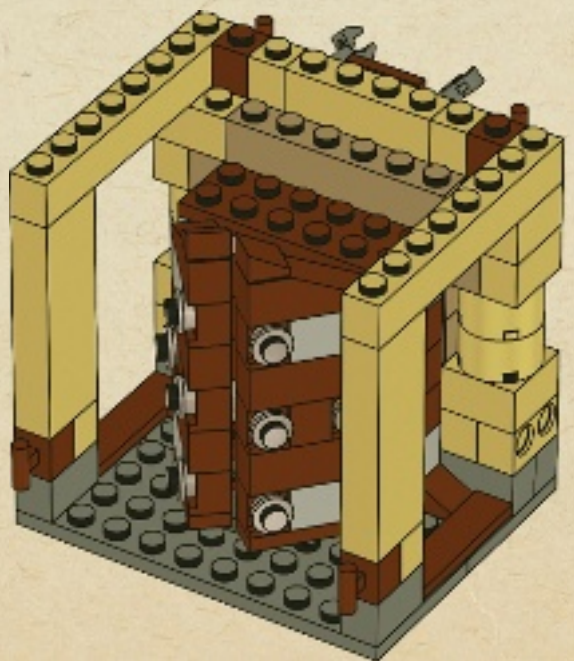



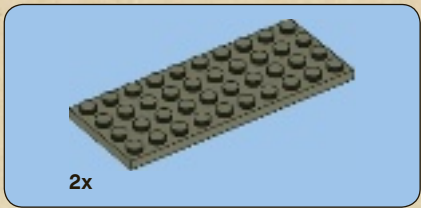

19

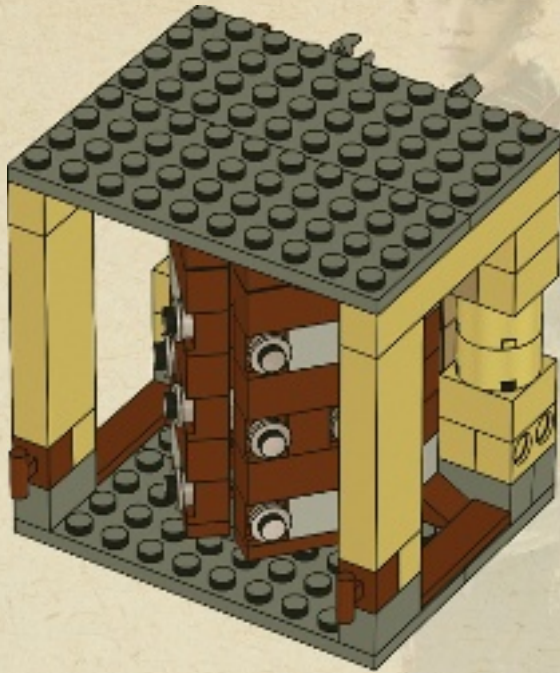

20

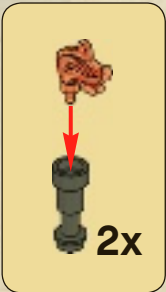
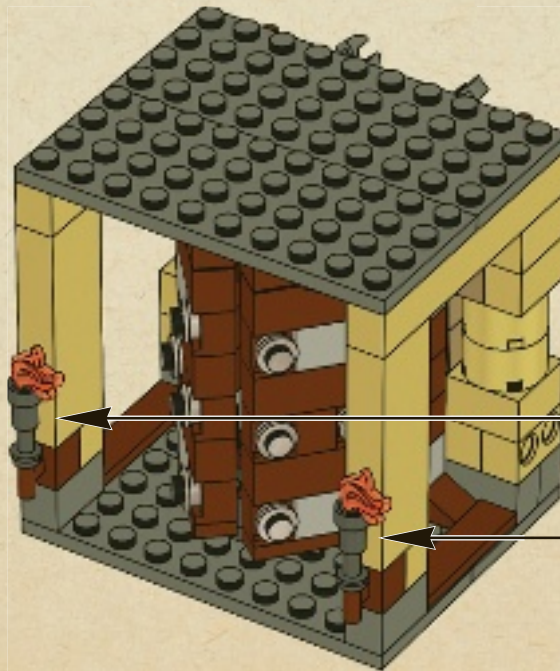



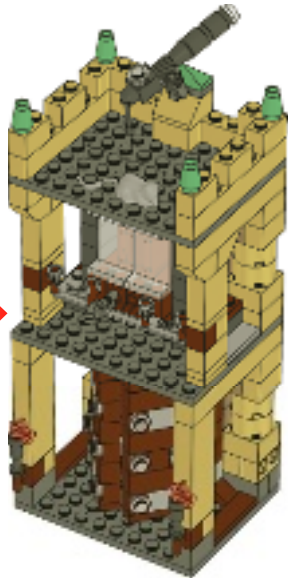

2x



3x

# 21

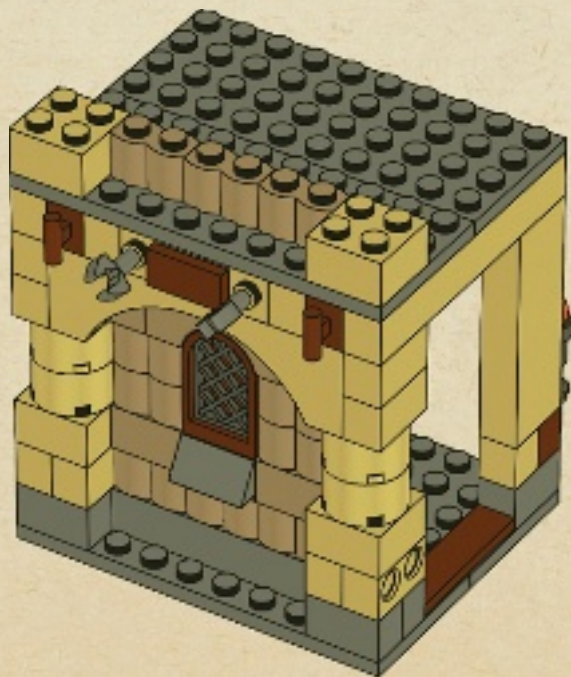

2x



2x

# 22

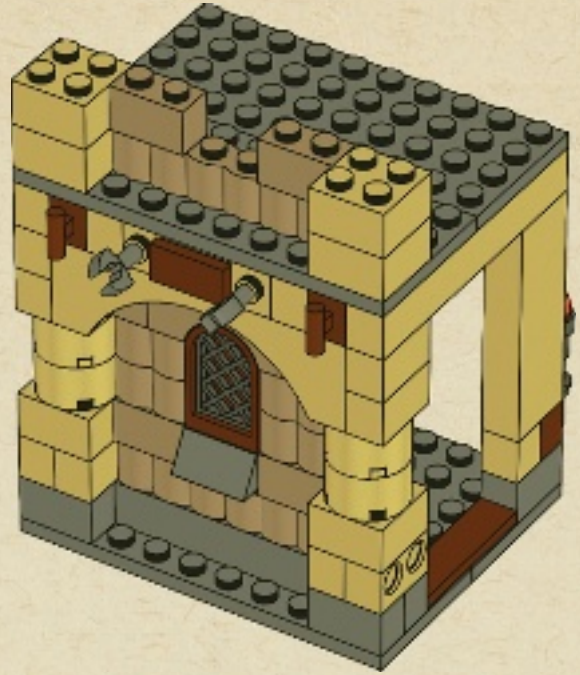

2x



2x

# 23

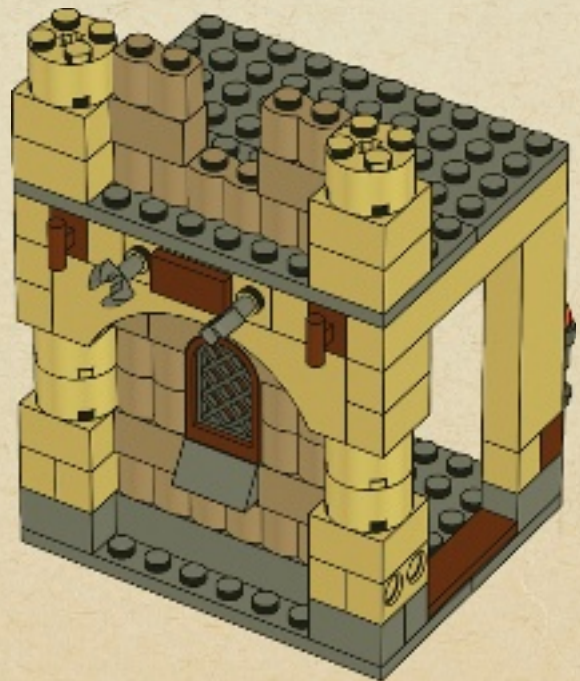



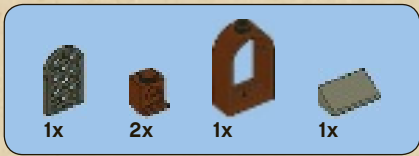

# 24

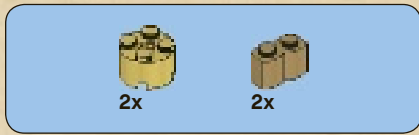
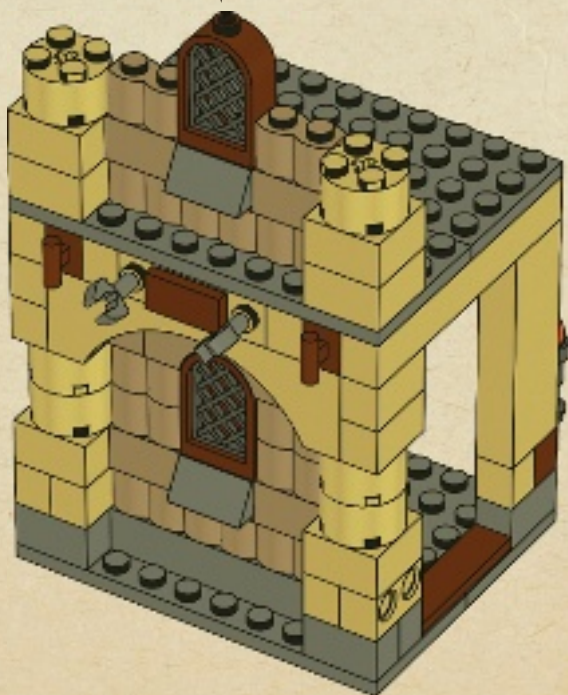

# 25

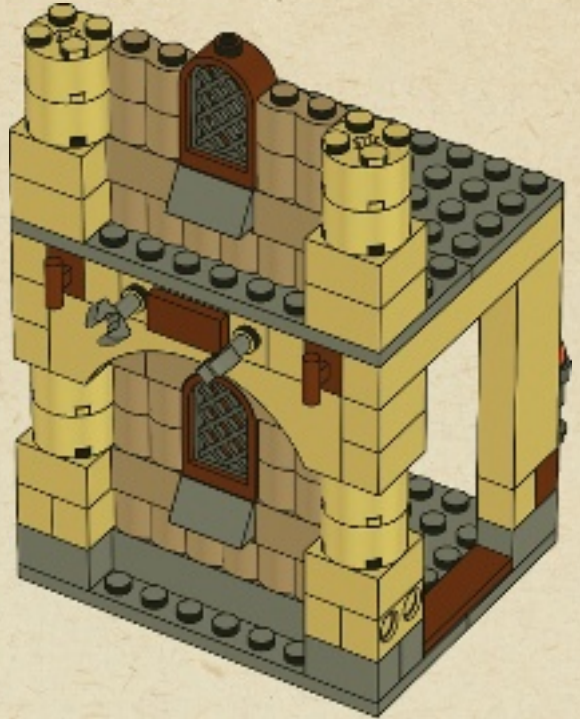

# 26

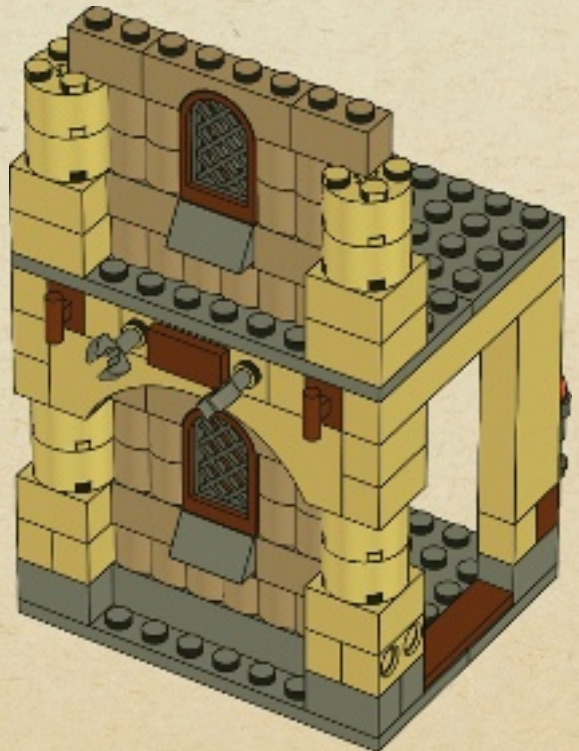



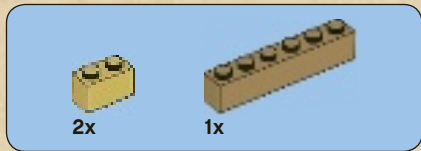

27

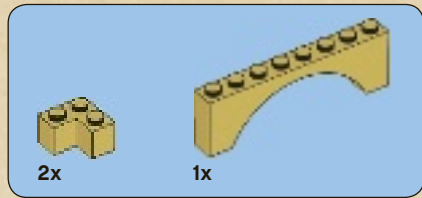
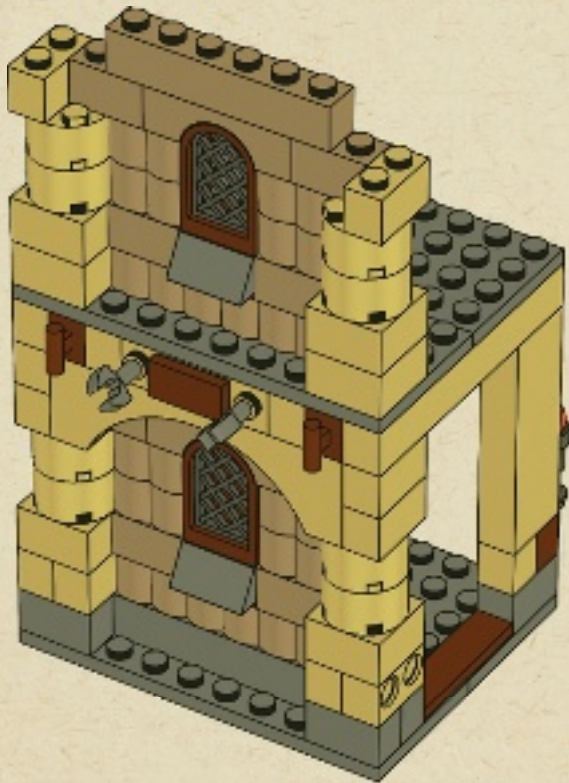

28

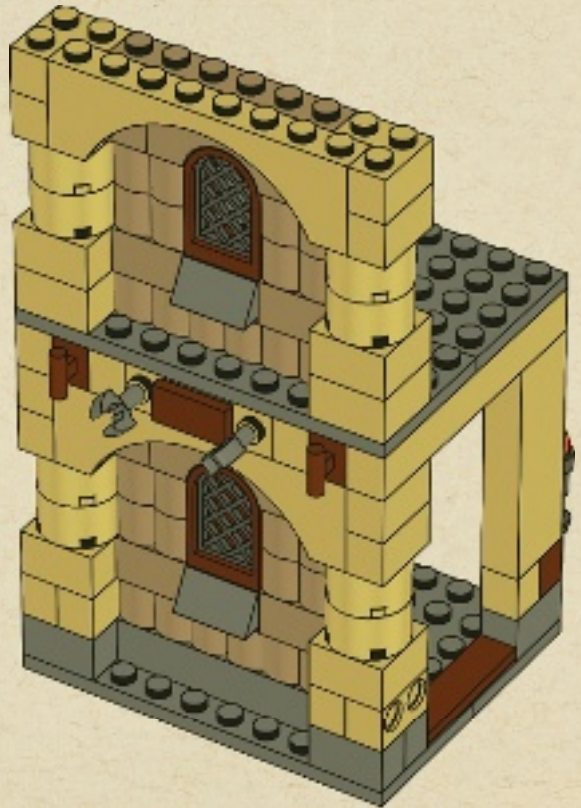





# 29

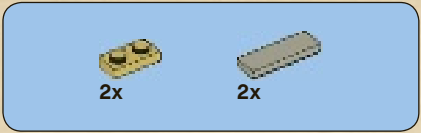
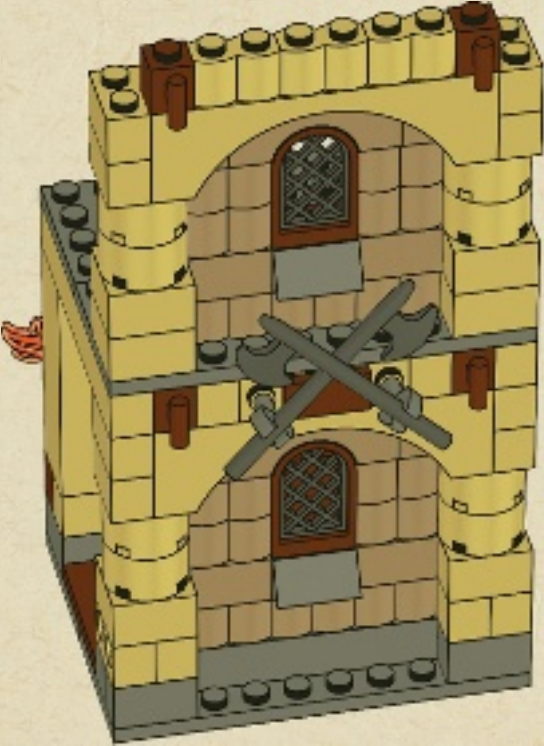

# 30

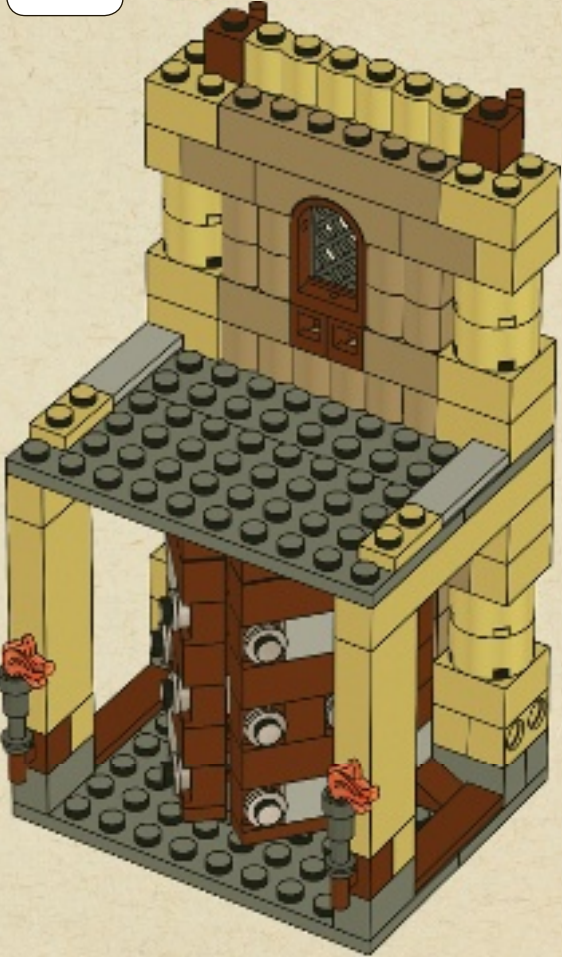



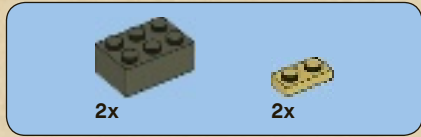

# 31

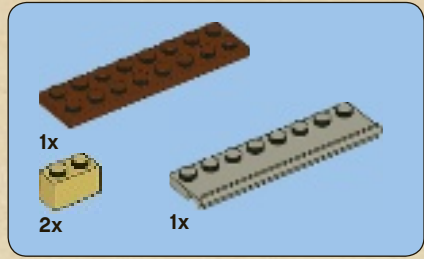

# 32

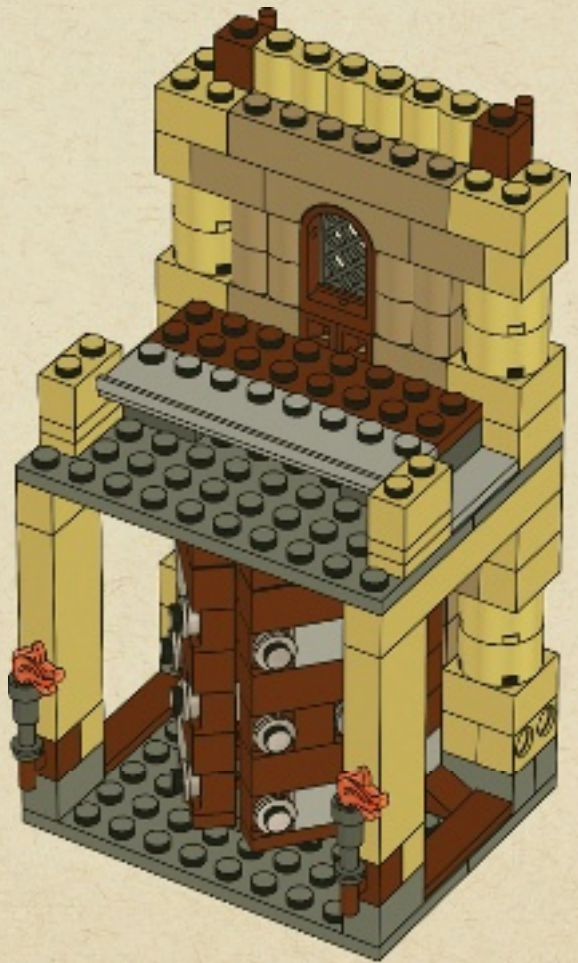





# 33

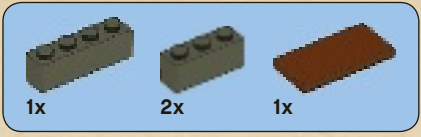
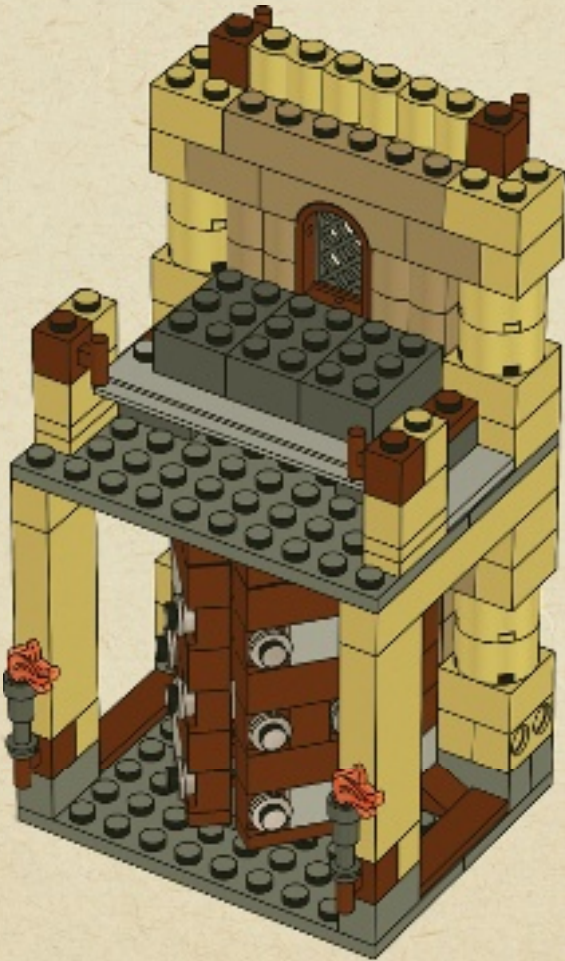

# 34

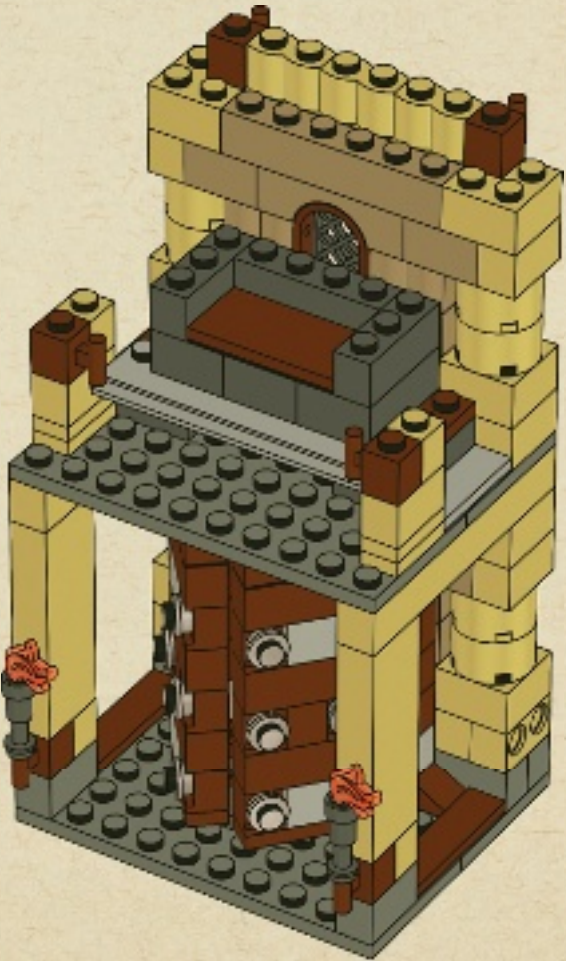



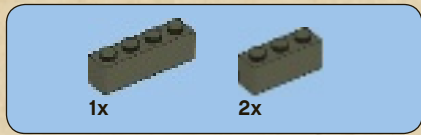

# 35

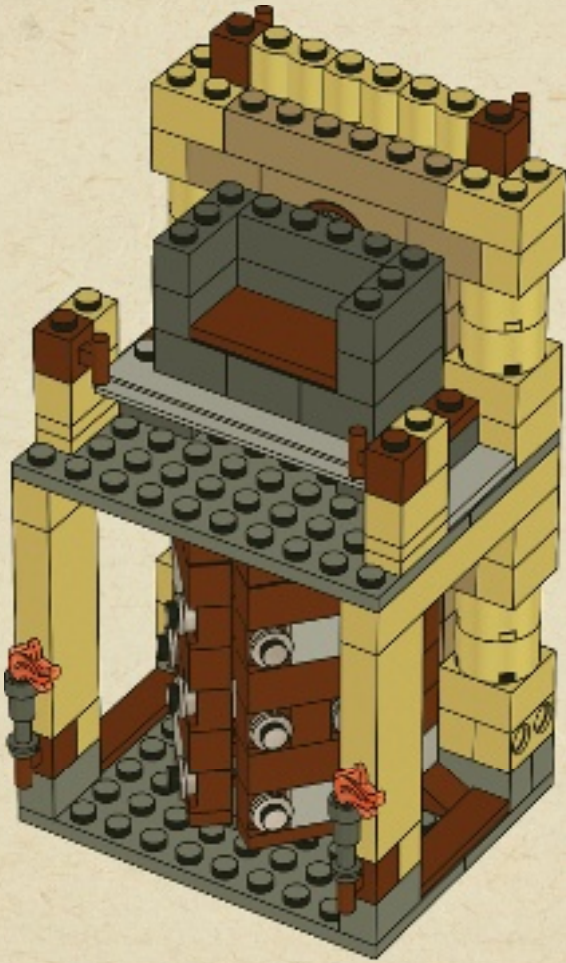

# 36

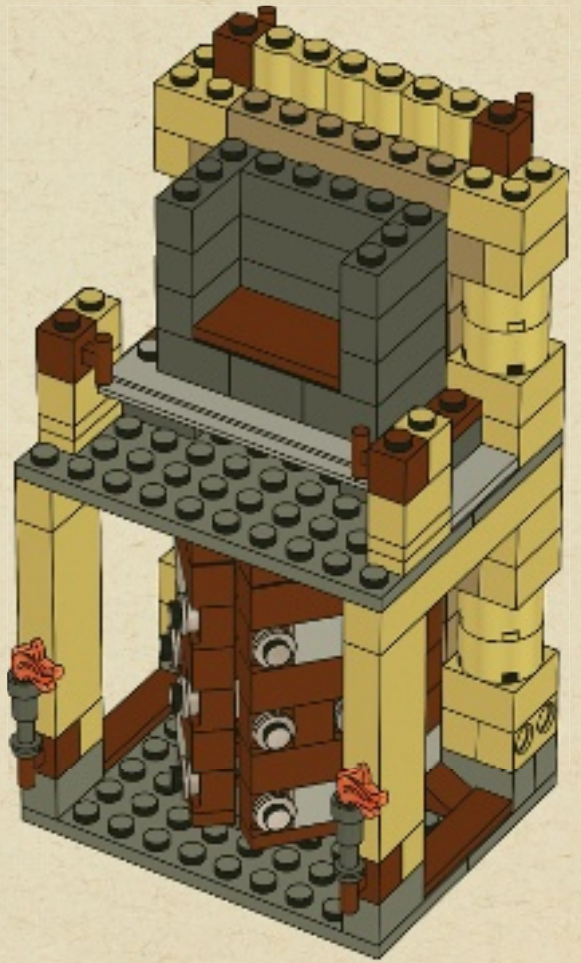





# 37

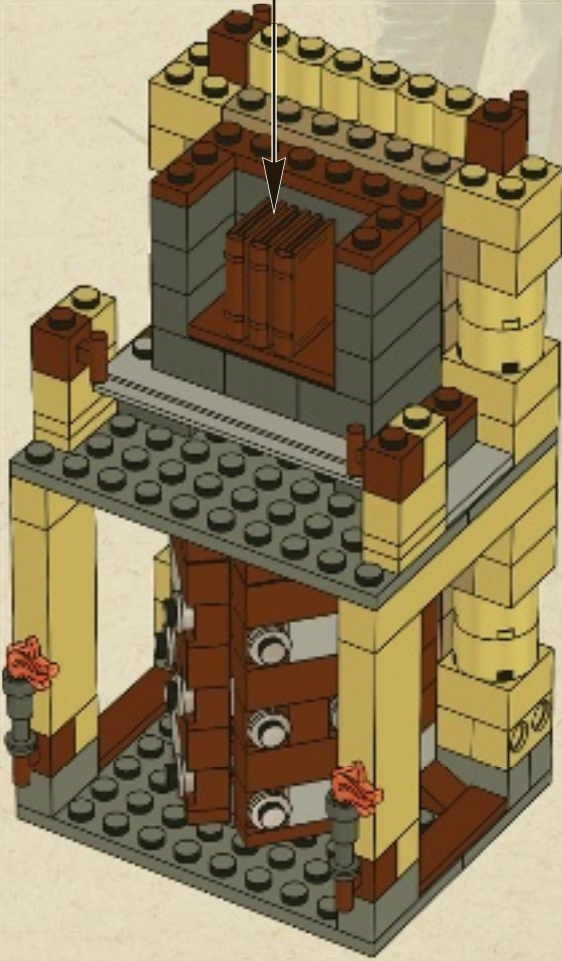



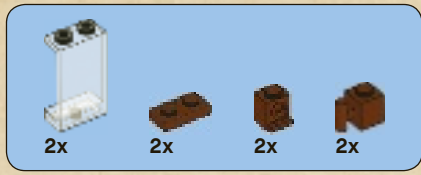

# 38

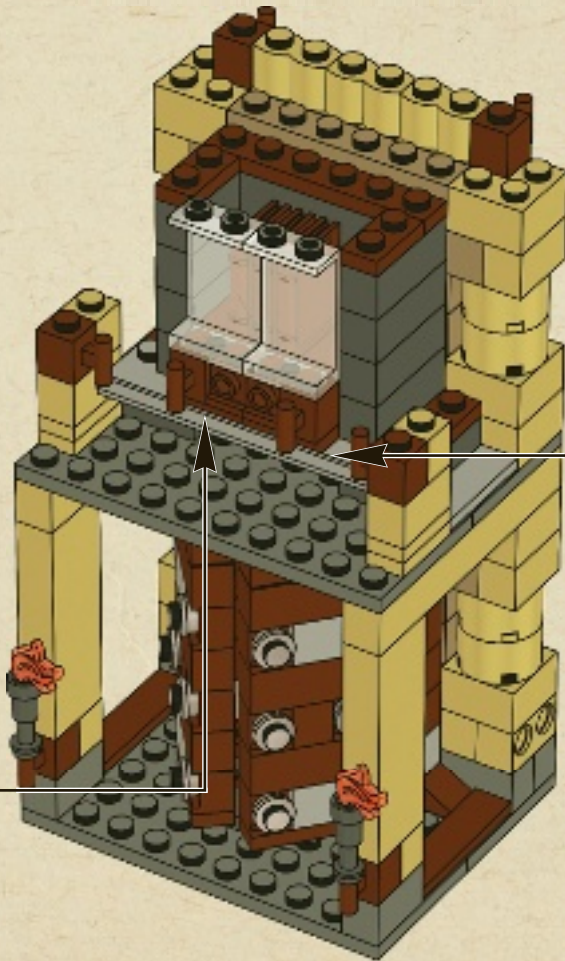



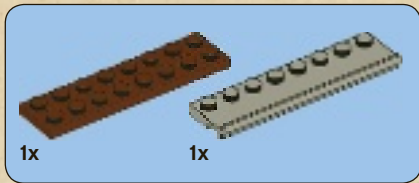

39

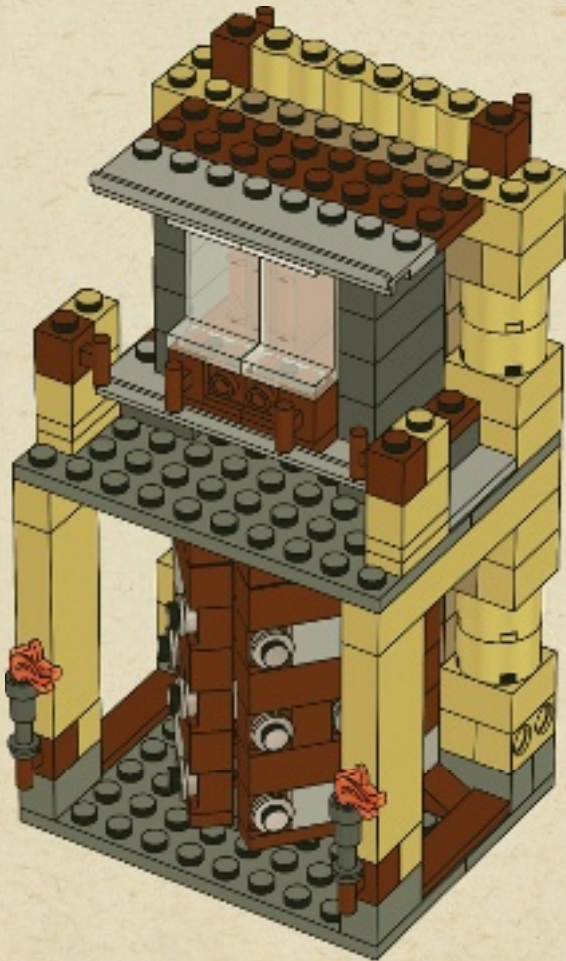

40

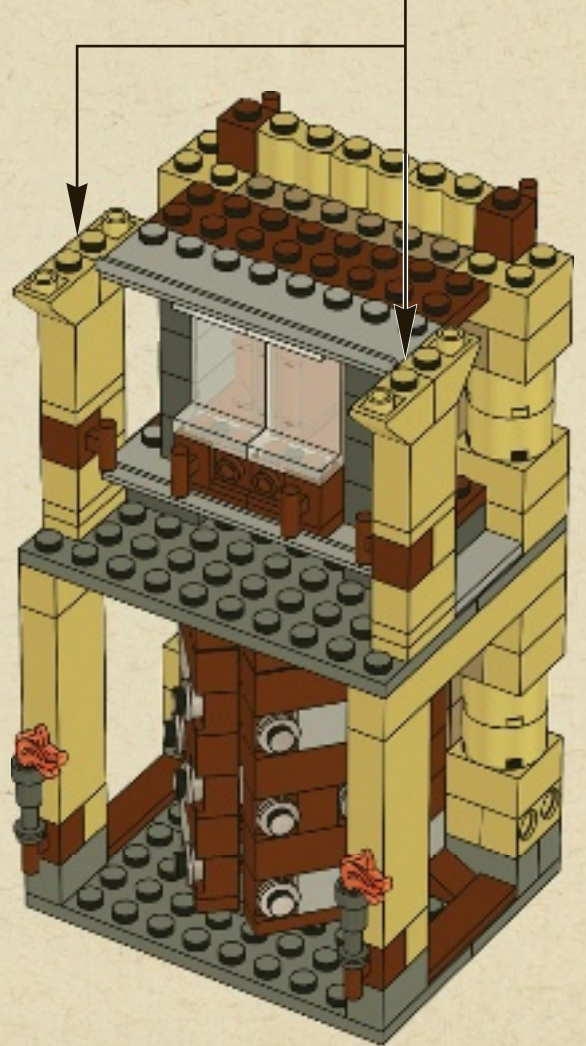
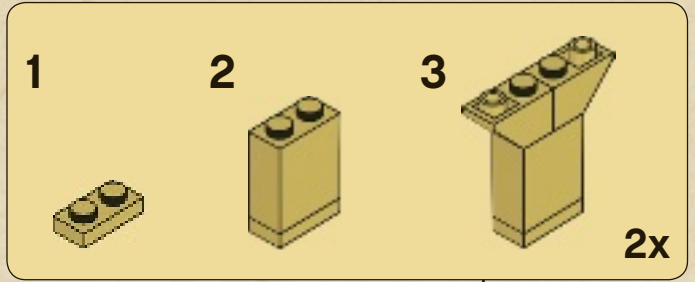



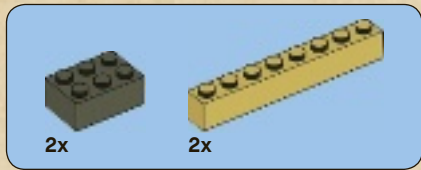

41

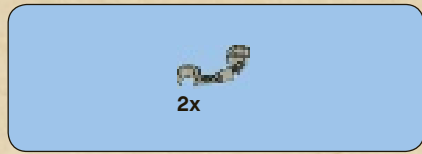
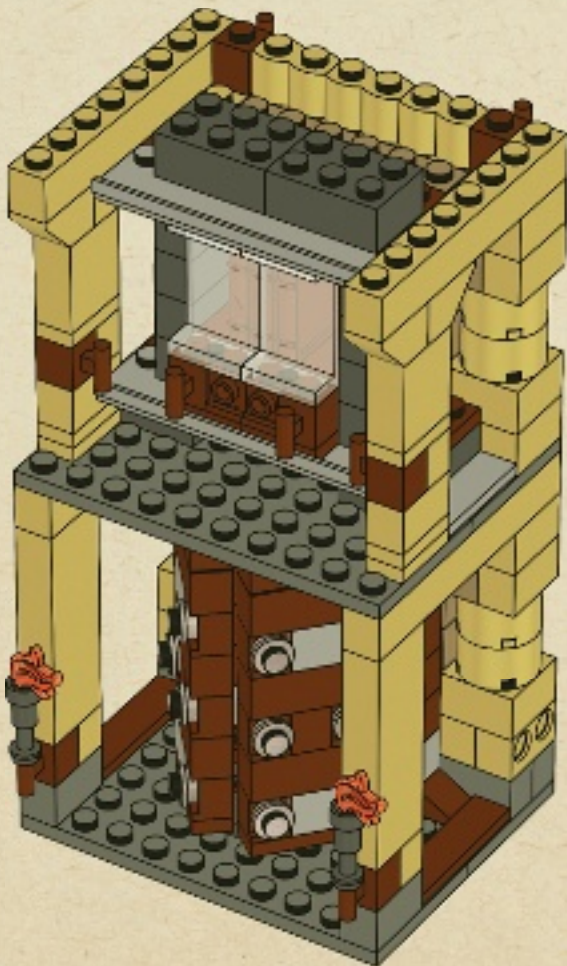
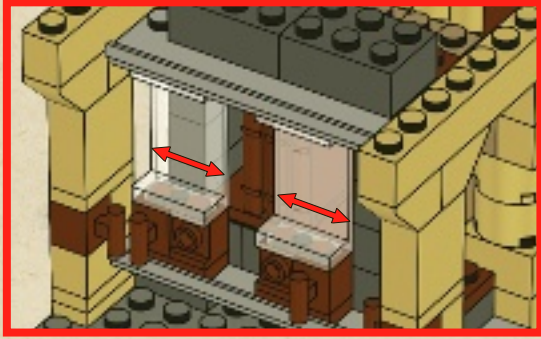

42

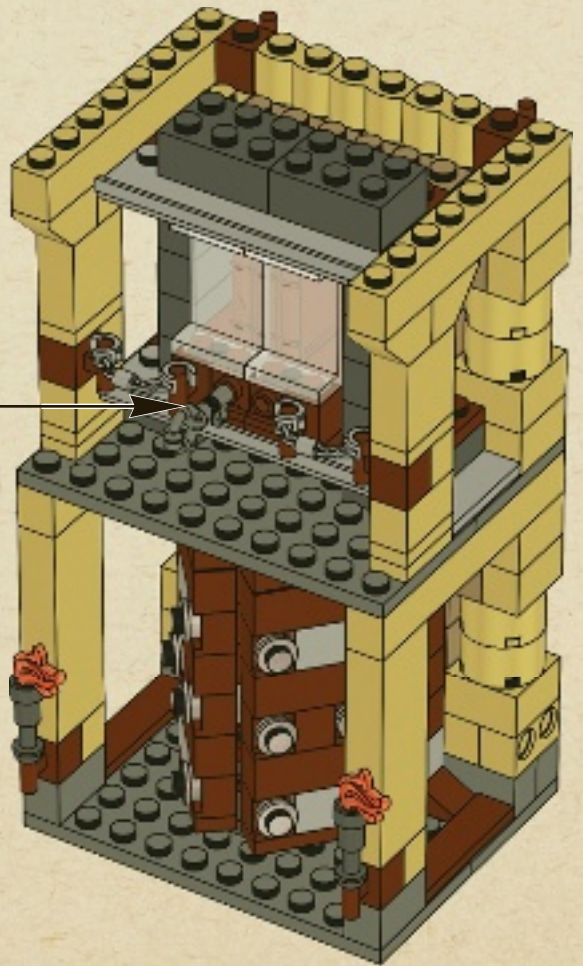



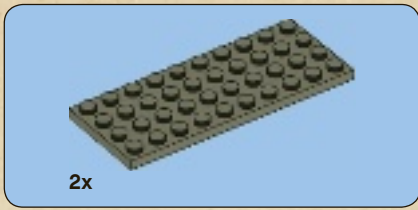

43

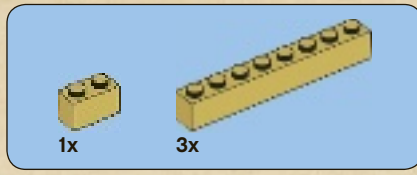
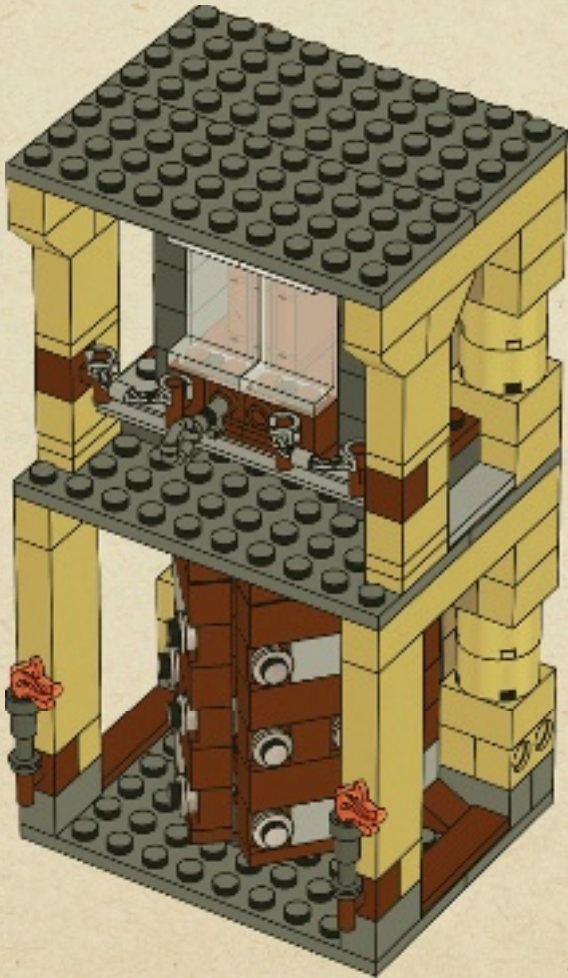

44

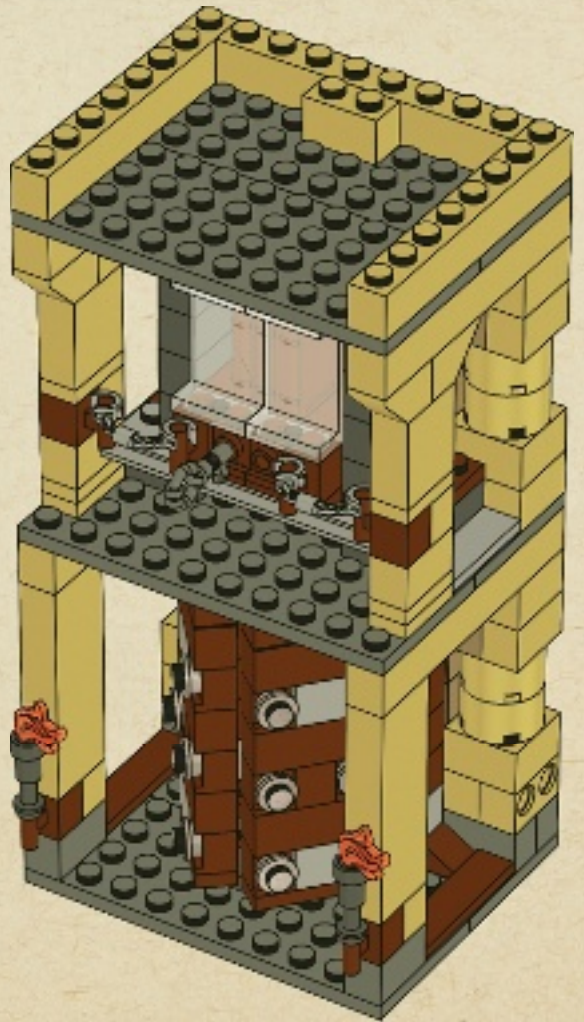





# 45

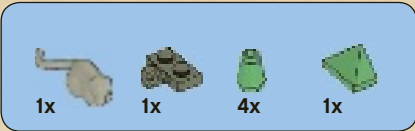
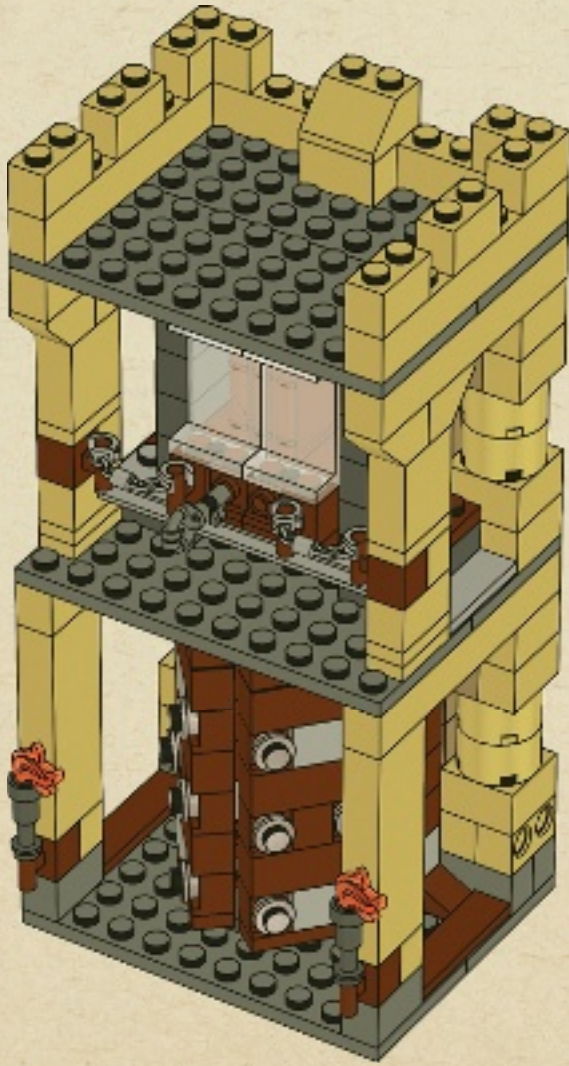

# 46

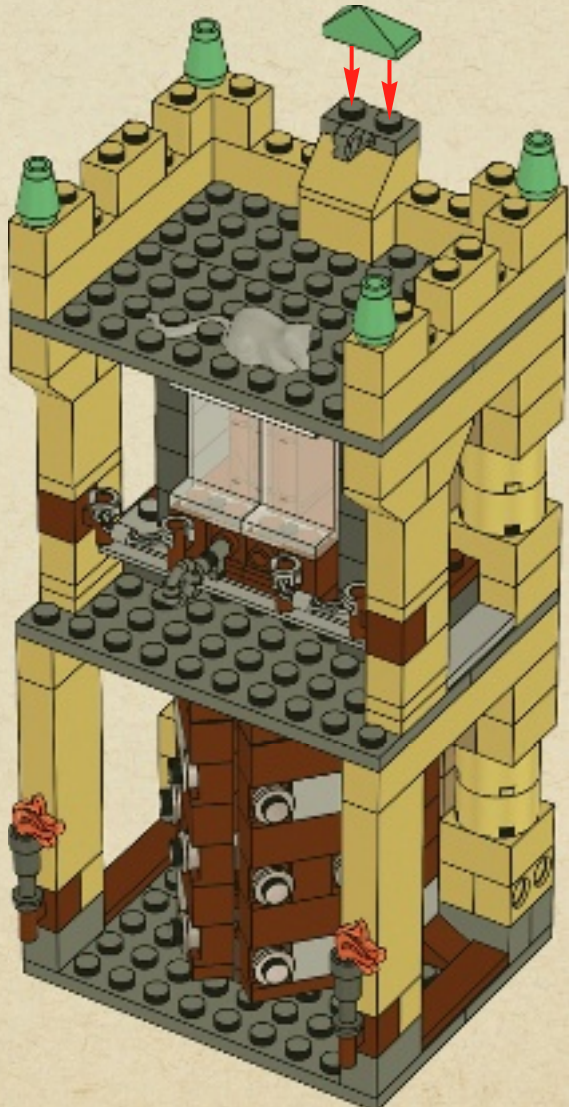





# 47

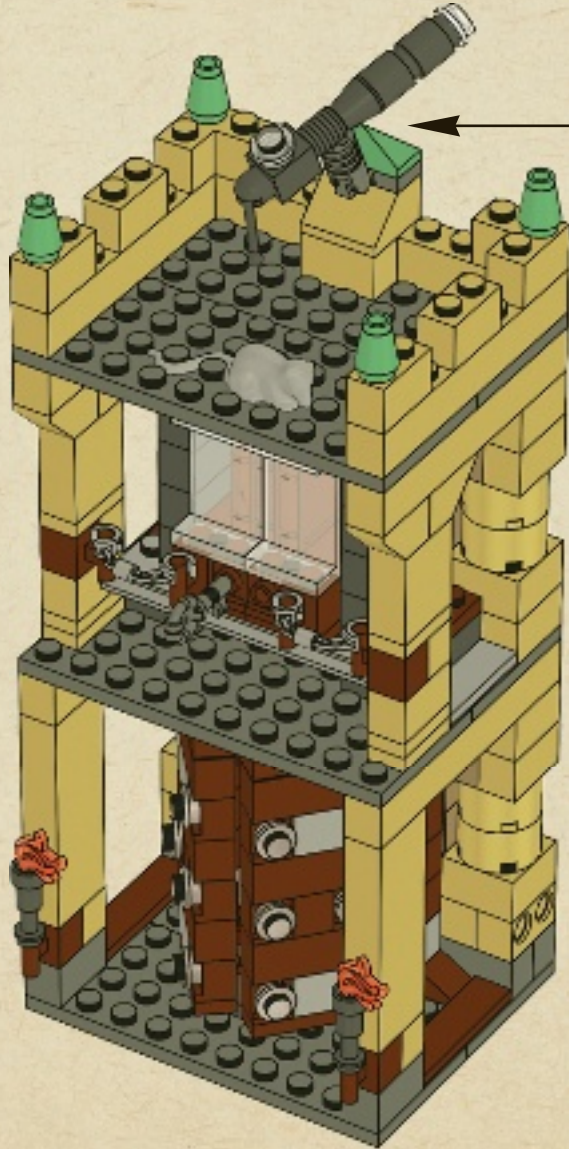
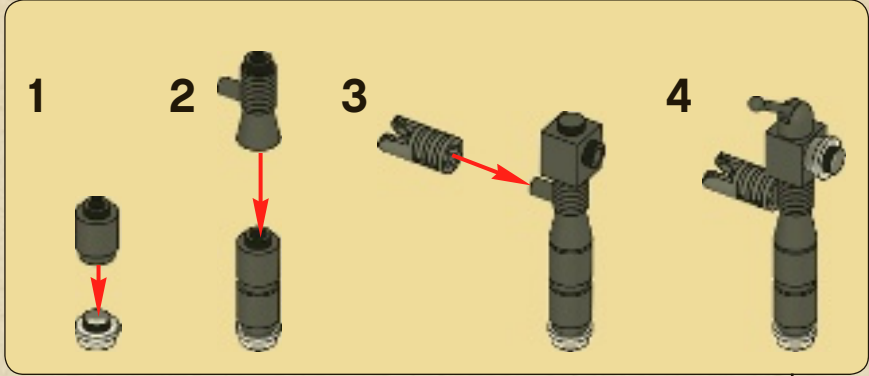



48

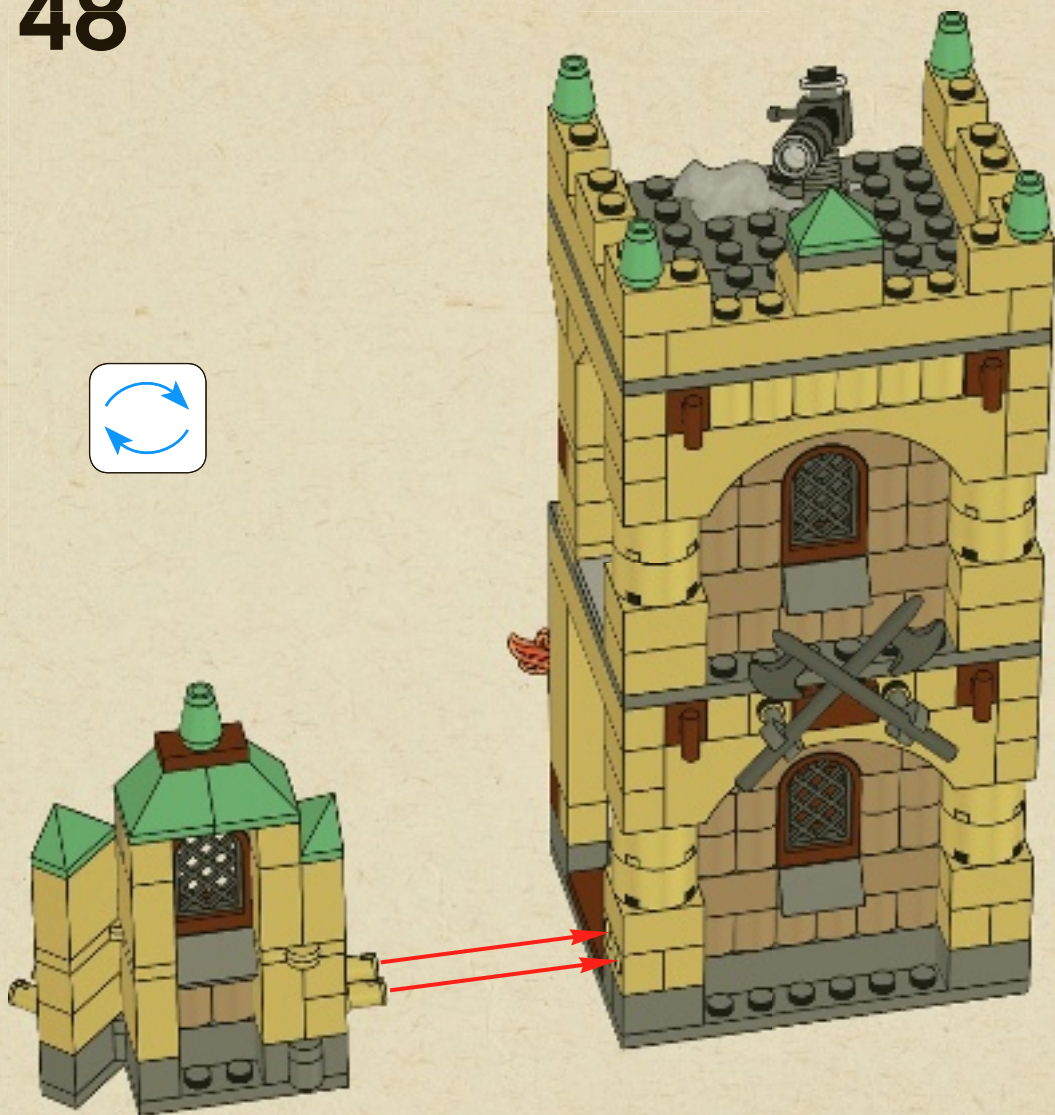
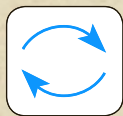



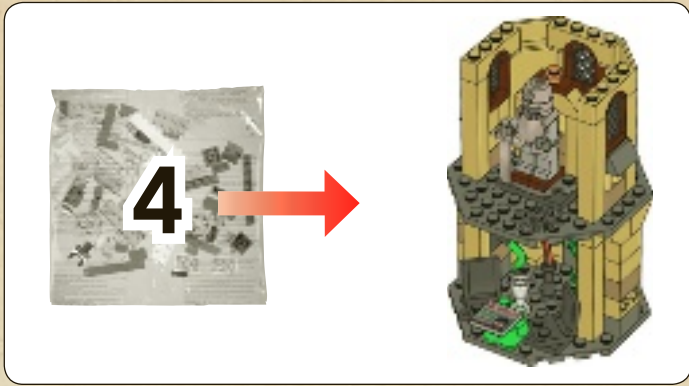

4



1

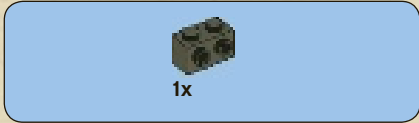
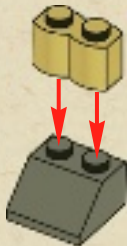

2

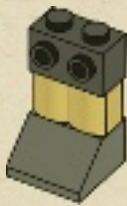

3

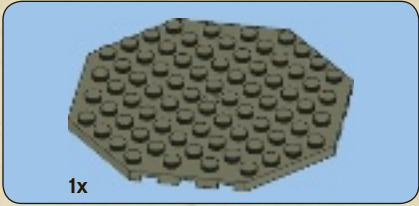
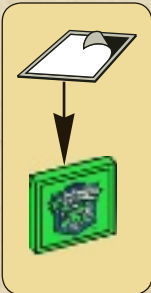

5

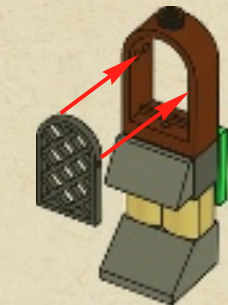



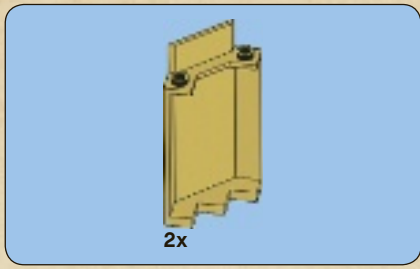

# 6

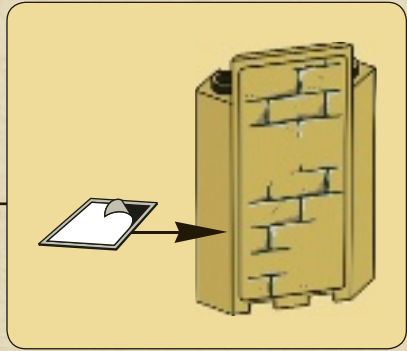
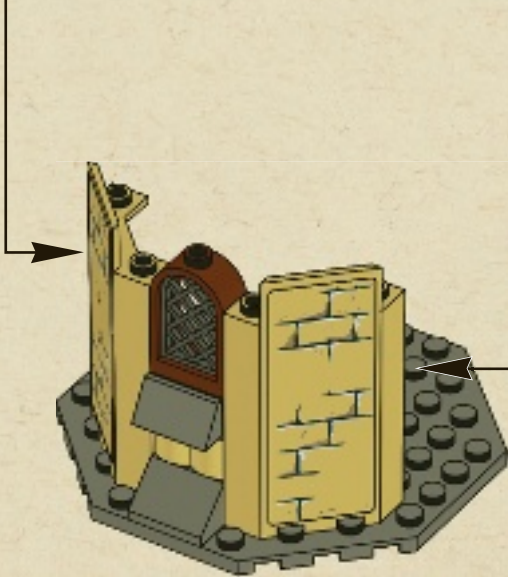
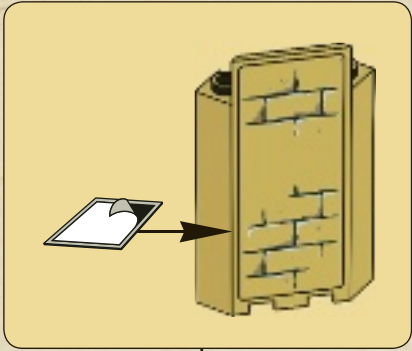



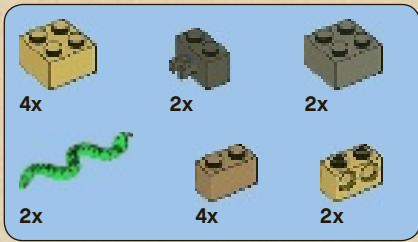

# 7

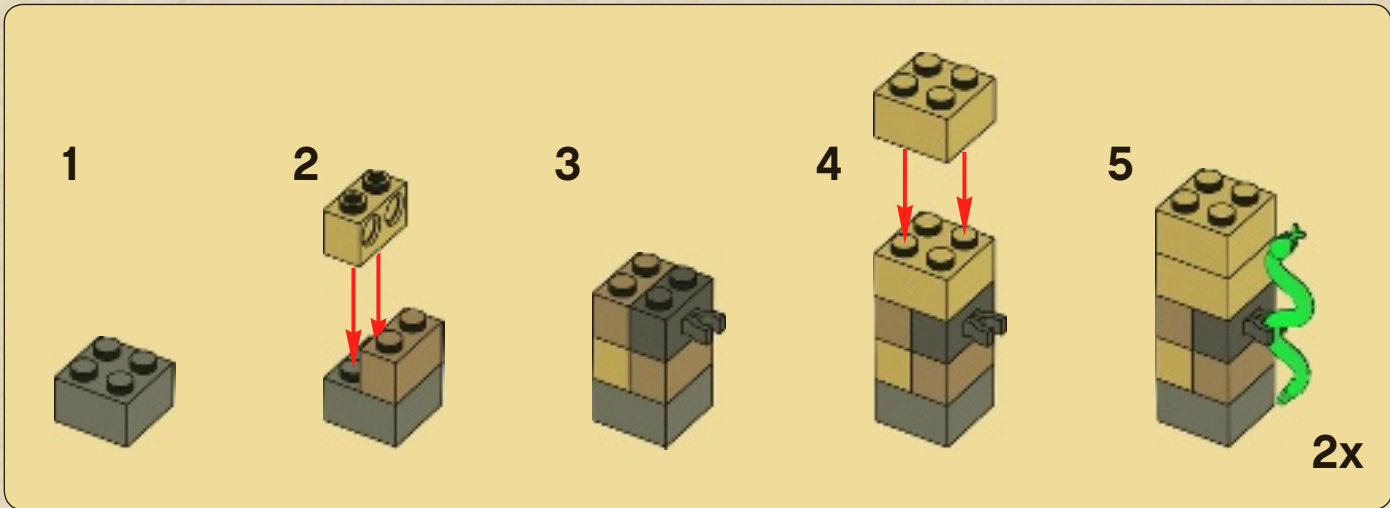



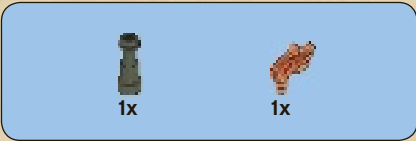

8

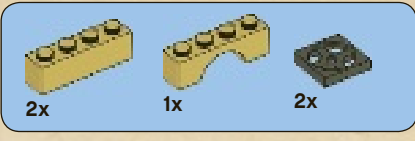
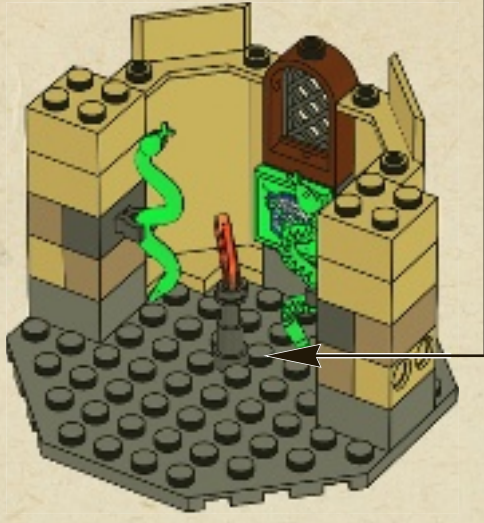

10

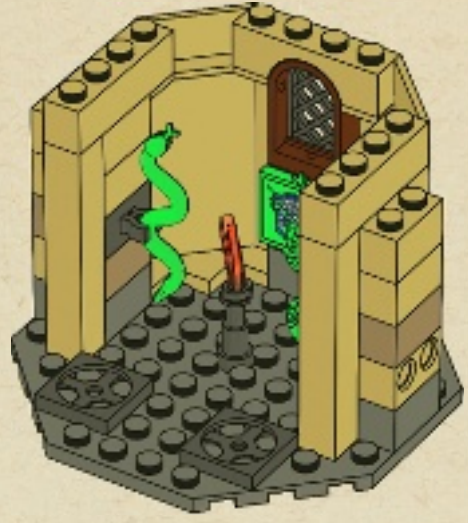

9

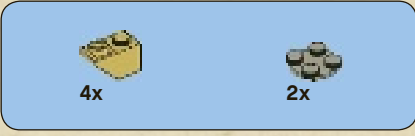

11

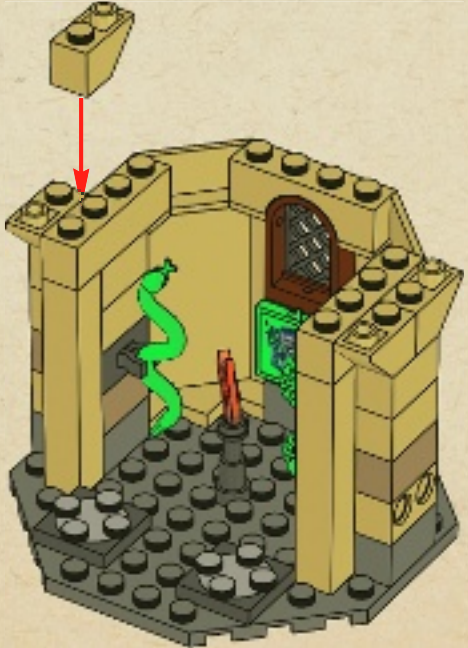





# 12

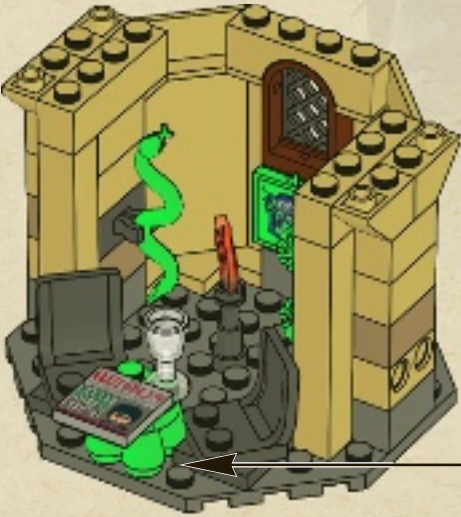
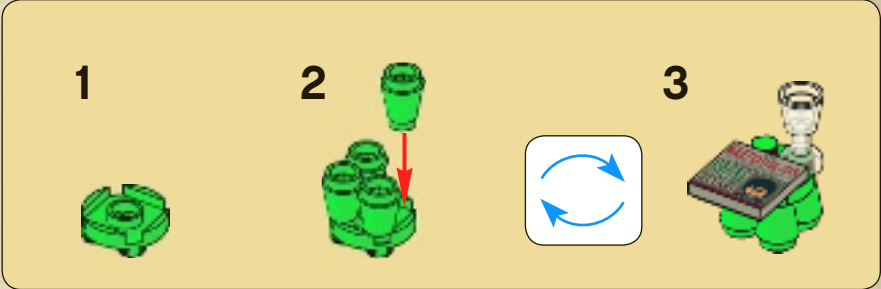



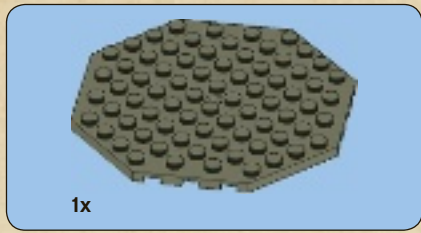

13

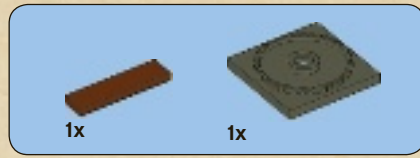

14





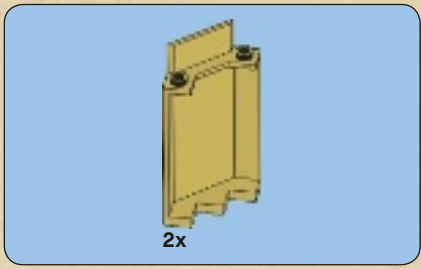

15

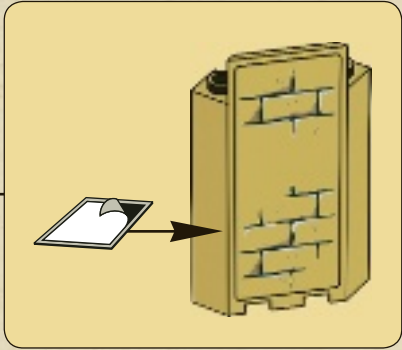
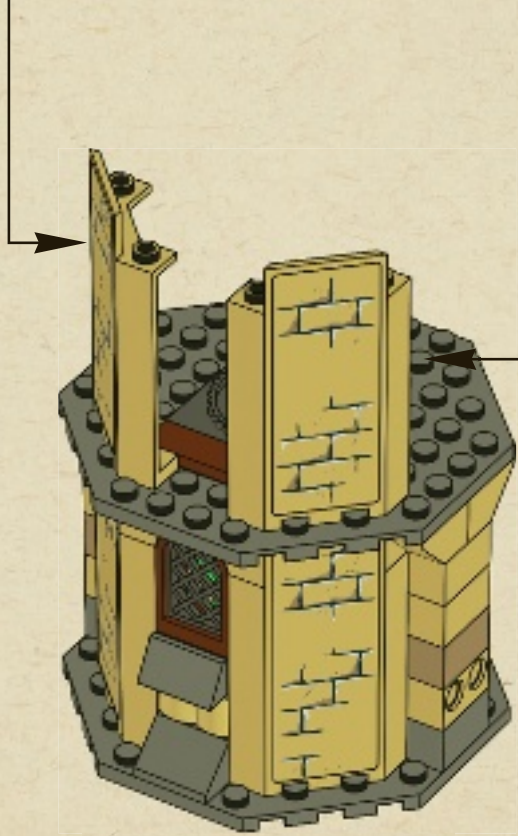
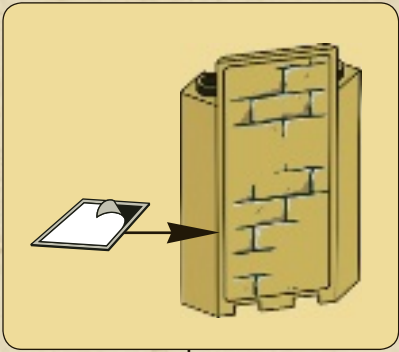



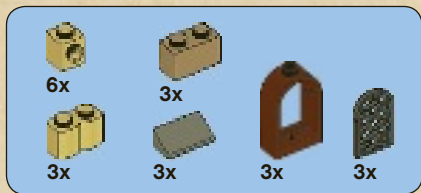

# 16

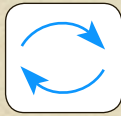
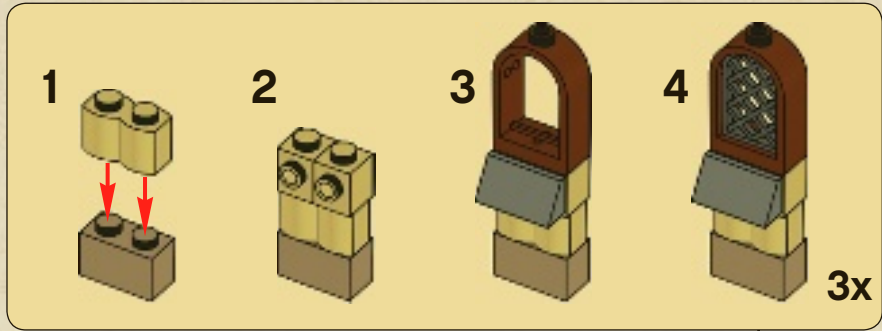



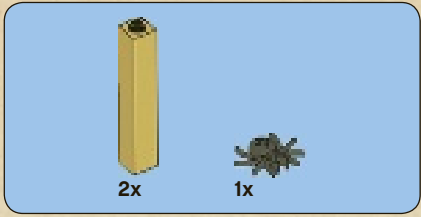

17

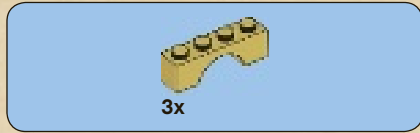

18







1

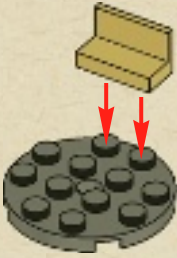

2

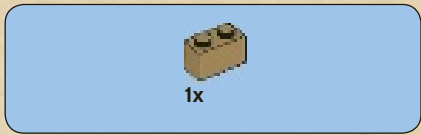

3



4







5



6

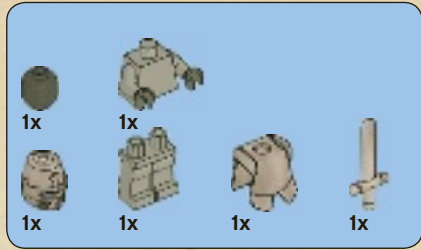
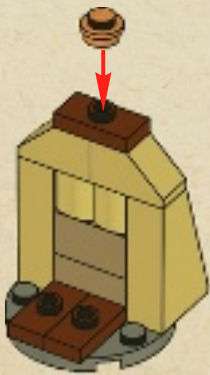

7

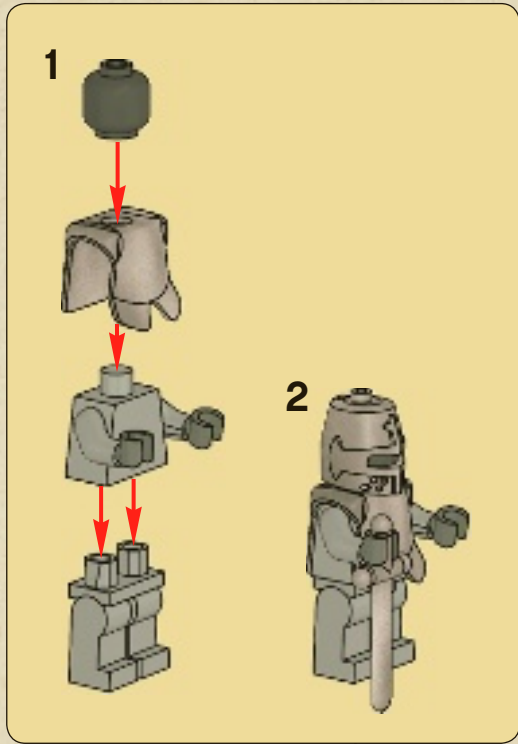





1x

8



19





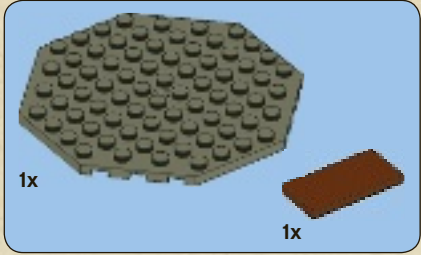

1



2

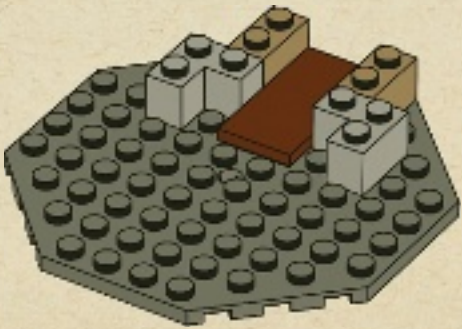



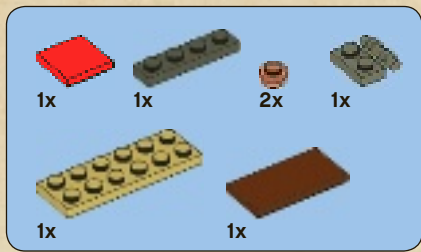

# 3

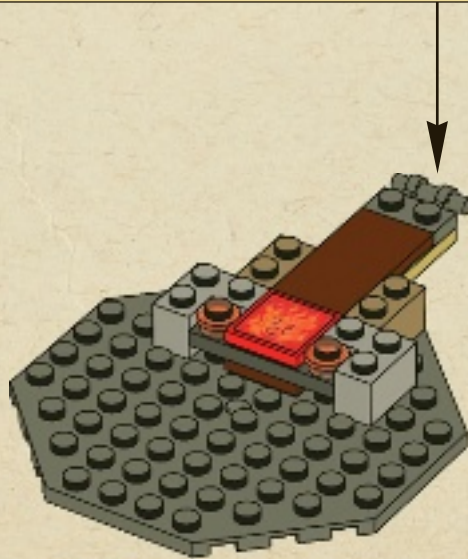
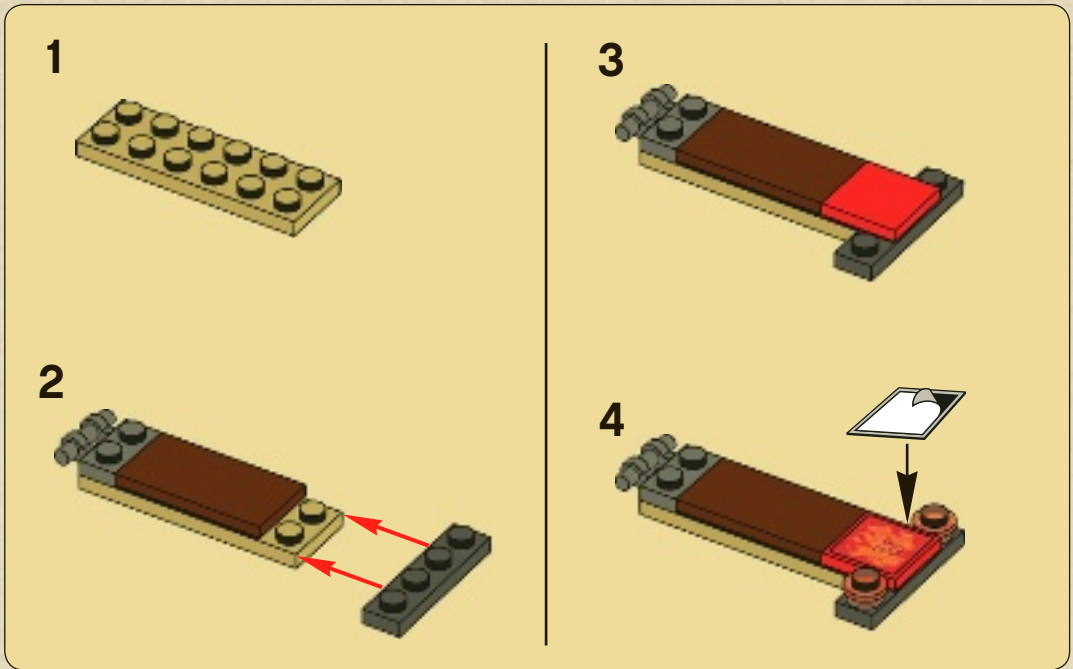





4

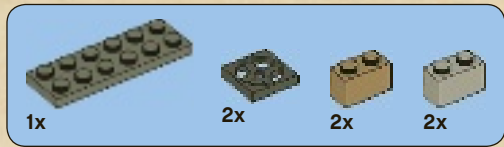
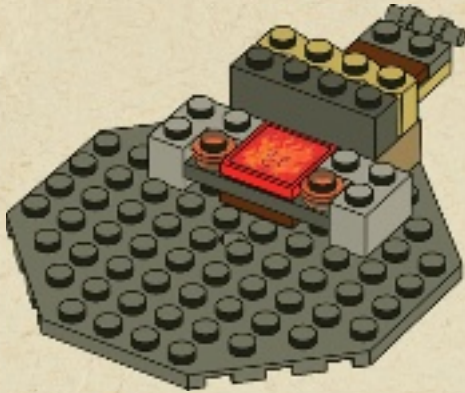

6

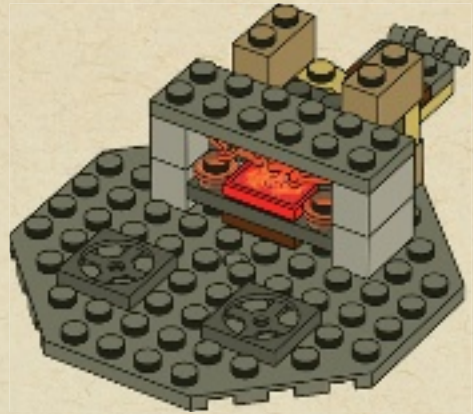

5

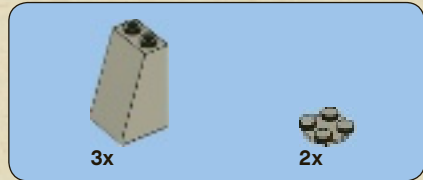
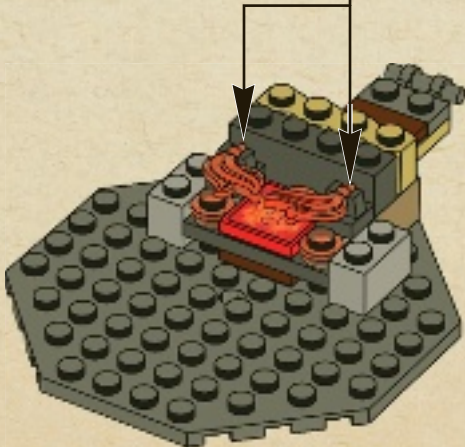

7

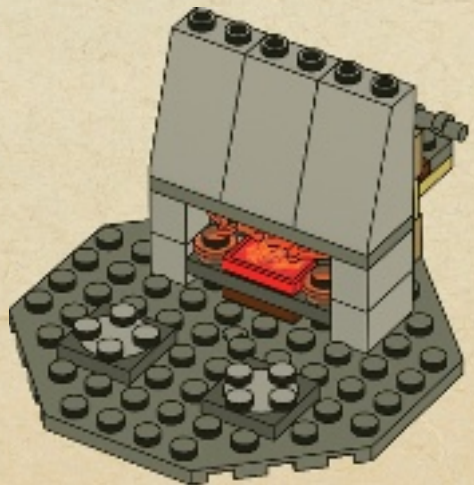





8

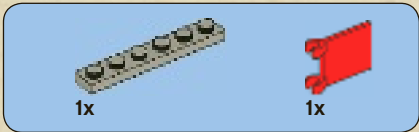
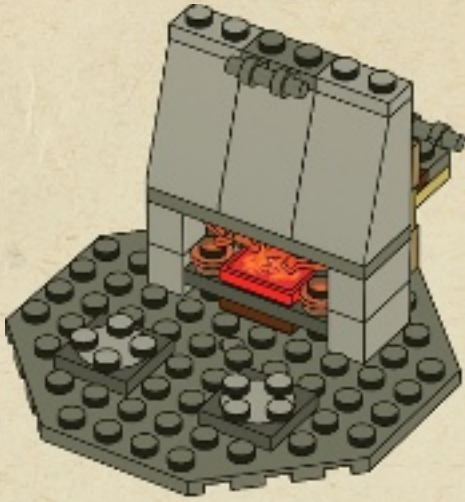

9

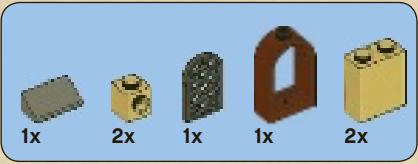
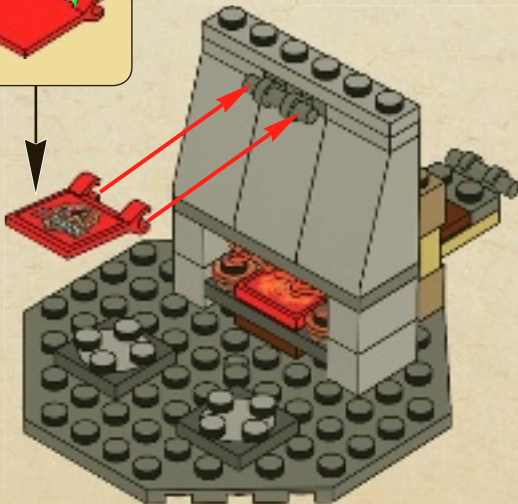
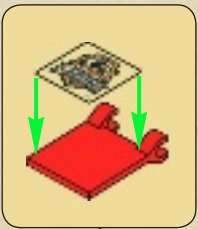

10

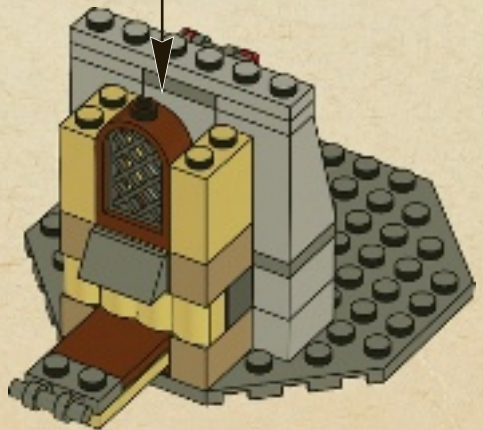
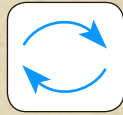
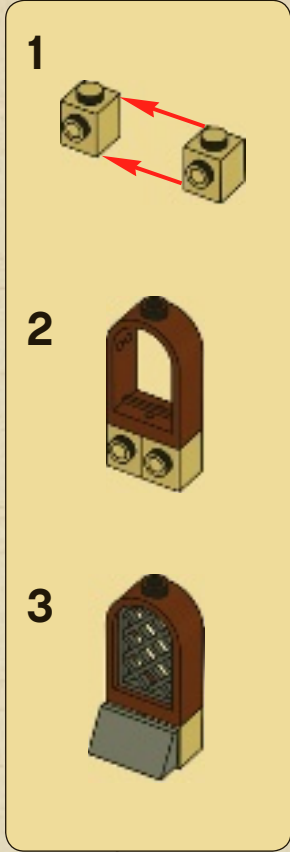



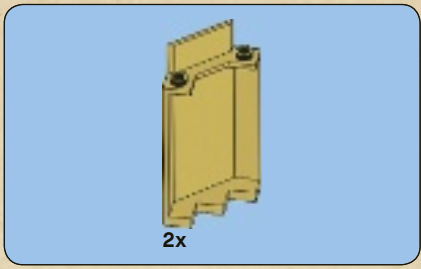

11

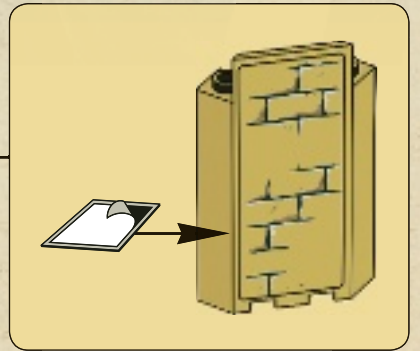
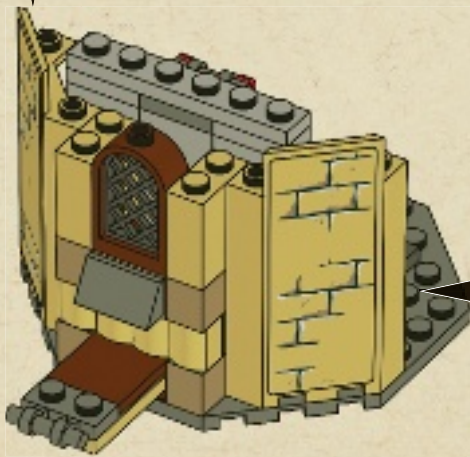
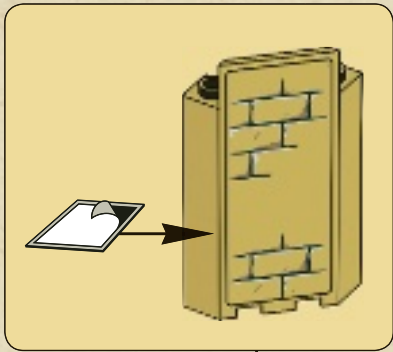





2x

# 12

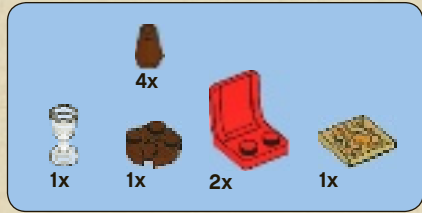
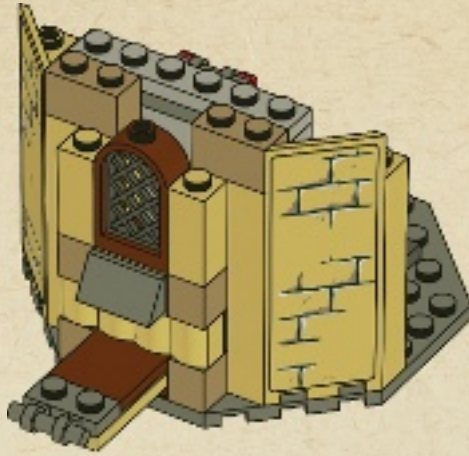

# 13





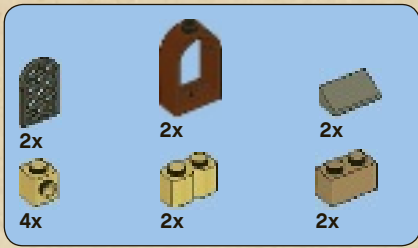

# 14

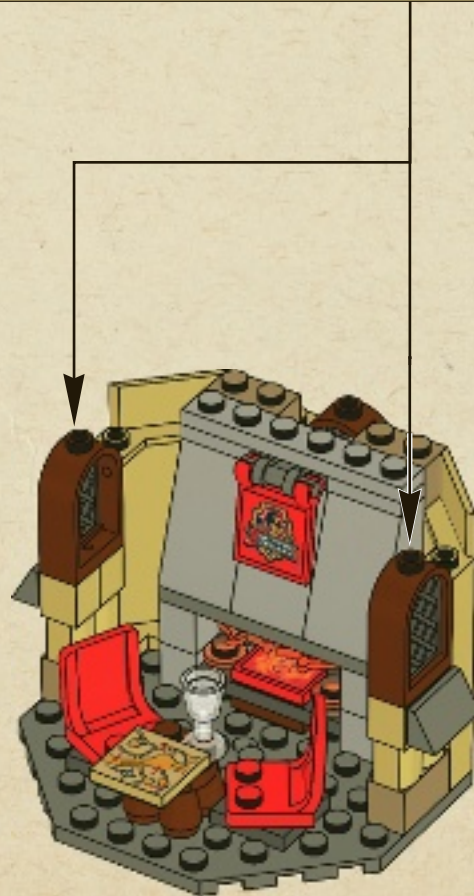
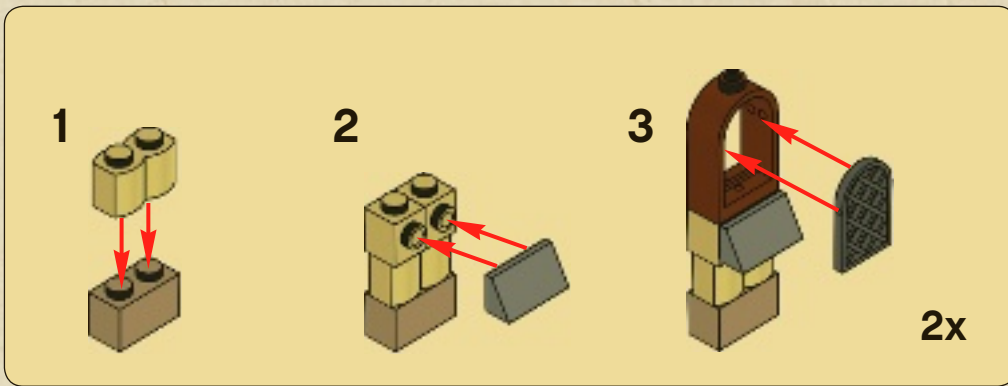





15

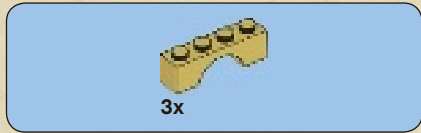

16

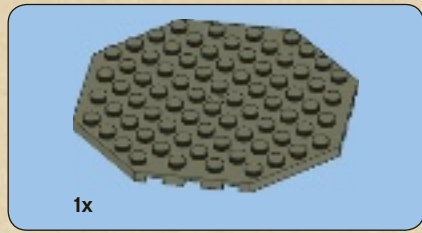

17







18



19

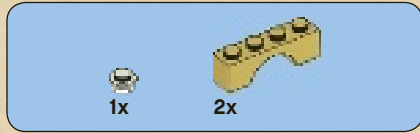

20







# 21

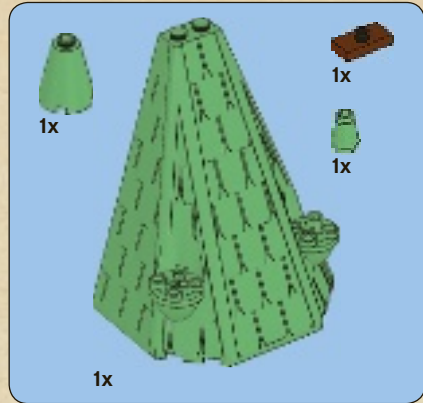

# 22

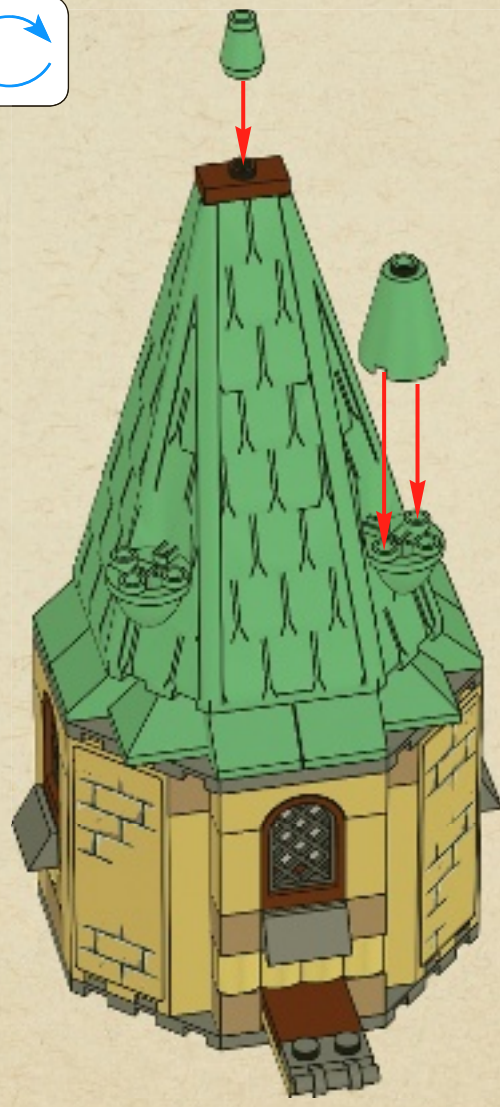
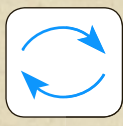



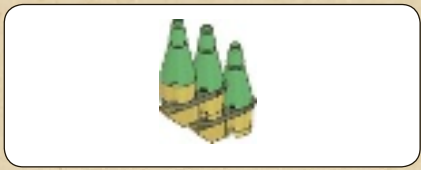

1



2

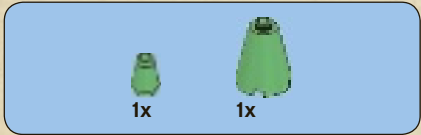
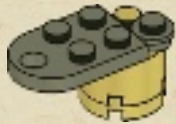

3

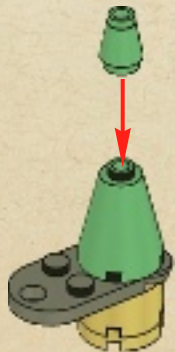

4

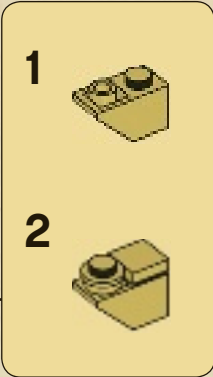
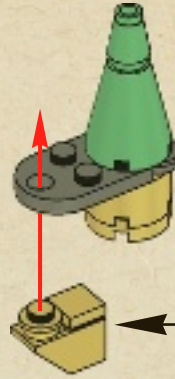

5

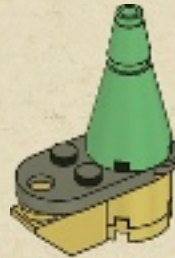

2x

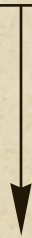

6





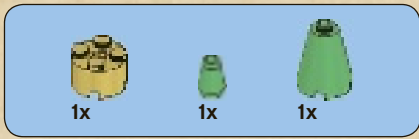

7

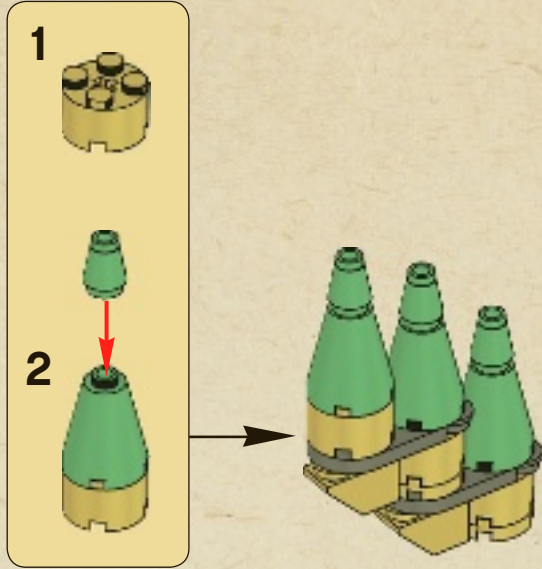

23

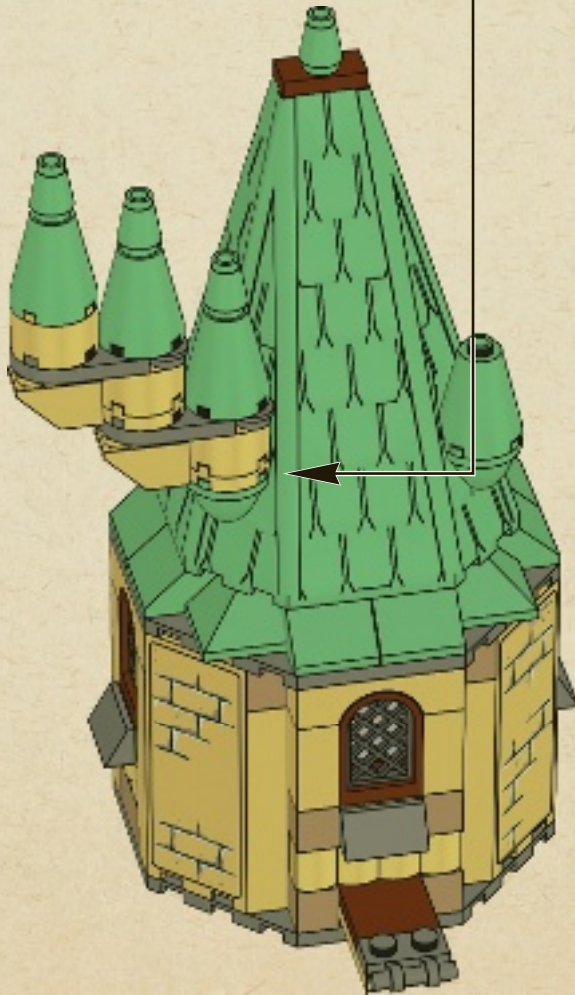



24

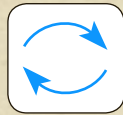



25

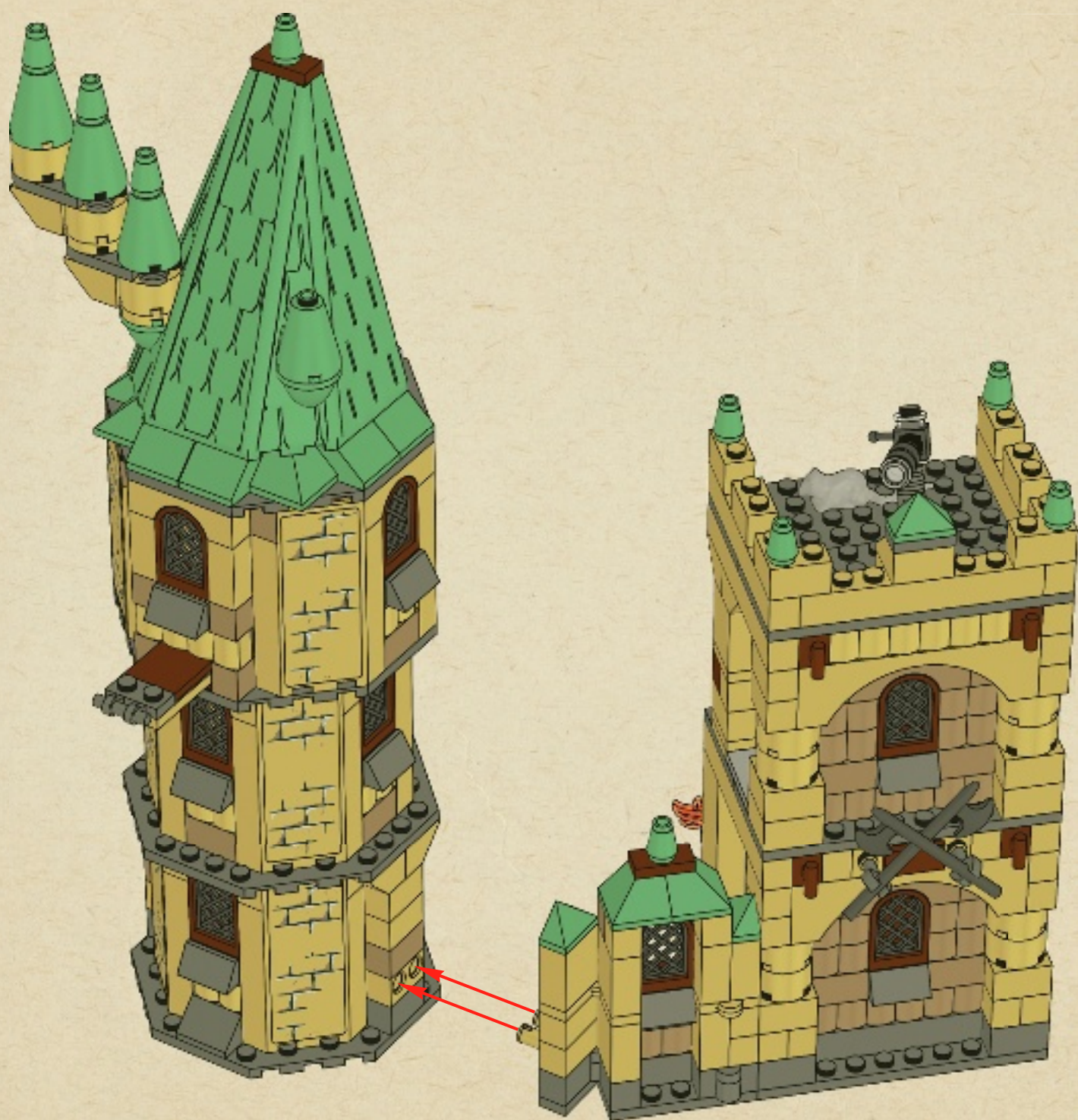



26

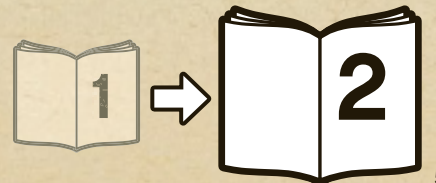
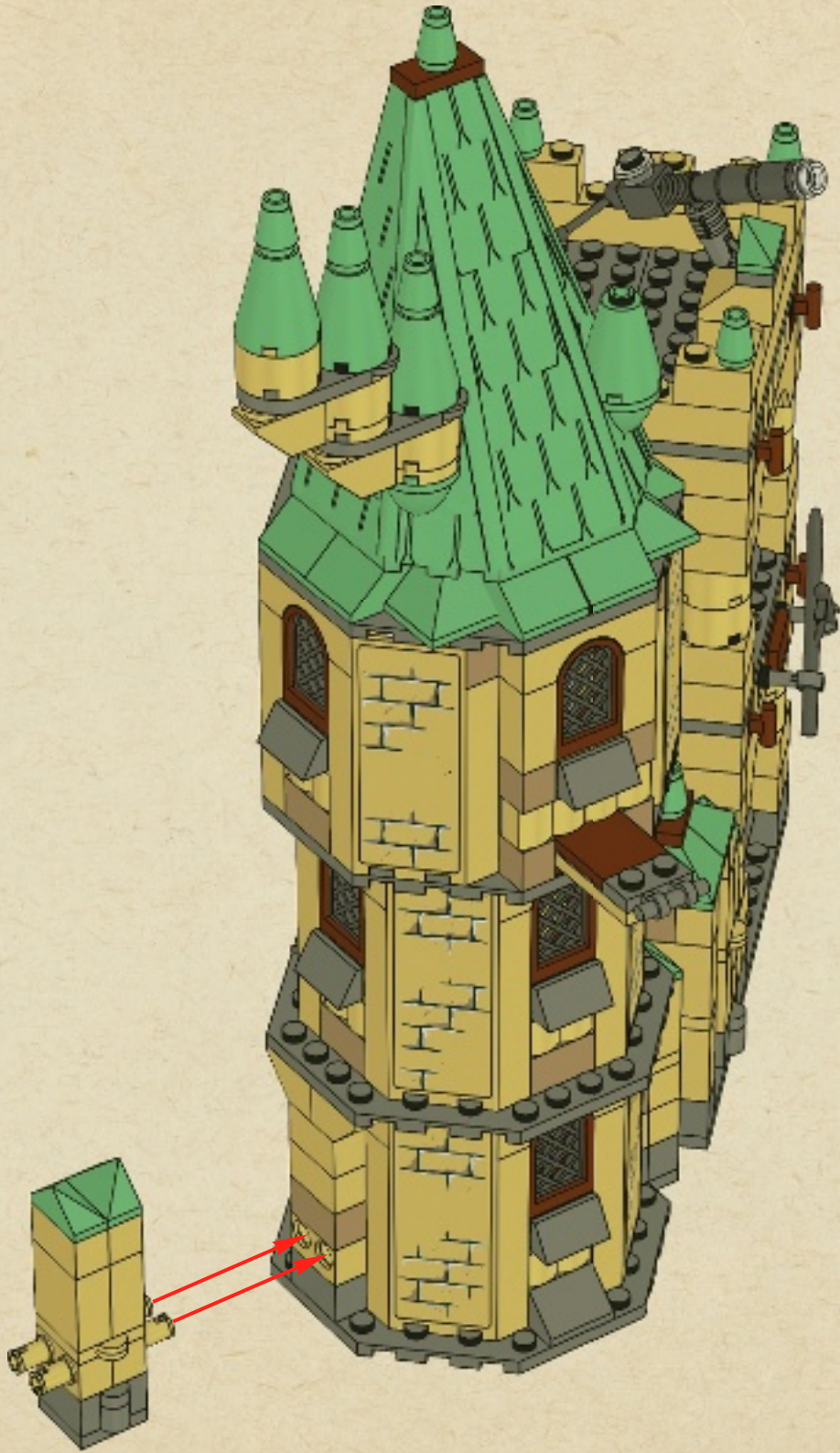





# Harry Potter

YEARS 1-4



[WWW.MAGICISBUILDING.COM](http://WWW.MAGICISBUILDING.COM)

Wii

NINTENDO DS



PlayStation



Games for Windows



XBOX 360

RATING PENDING

RP

ESRB

Visit [www.esrb.org](http://www.esrb.org)  
for rating information

LEGO HARRY POTTER YEARS 1-4 is based on © 2010 J.K. Rowling Publishing Ltd. Produced by J.K. Rowling under license from the LEGO Group, LEGO, the LEGO logo, the Brick and the Knob configurations and the Minifigure are trademarks of the LEGO Group. © 2010 The LEGO Group. "PlayStation" and the "PS" Family logo are registered trademarks of Sony Computer Entertainment Inc. Wii and Nintendo DS are trademarks of Nintendo. © 2010 Nintendo. Microsoft, Xbox, Xbox 360, Xbox LIVE and the Xbox logo are trademarks of the Microsoft group of companies and are used under license from Microsoft. Windows and the Windows logo are trademarks of the Microsoft group of companies and "Games for Windows" and the Windows 4 logo are trademarks of Microsoft. All other trademarks and copyrights are the property of their respective owners. All rights reserved.



HARRY POTTER characters, names and related indicia are trademarks of and © Warner Bros. Entertainment Inc. Harry Potter Publishing Rights © 2010. WB® LEGO, WB SH ELD.™ & © Warner Bros. Entertainment Inc. (s12)







# Harry Potter



4842





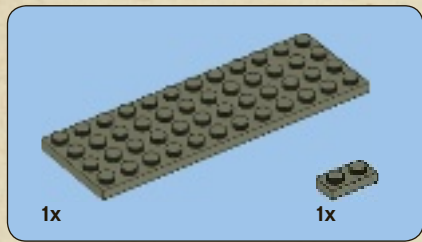
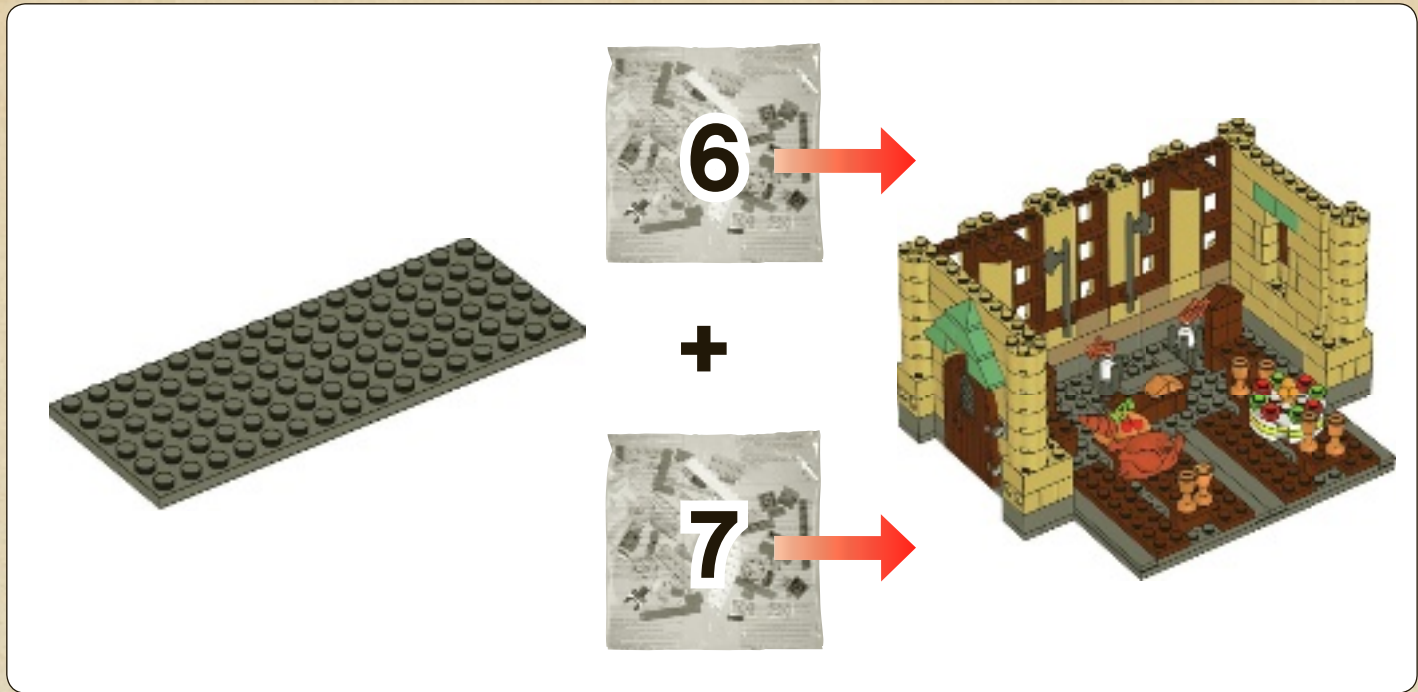

1

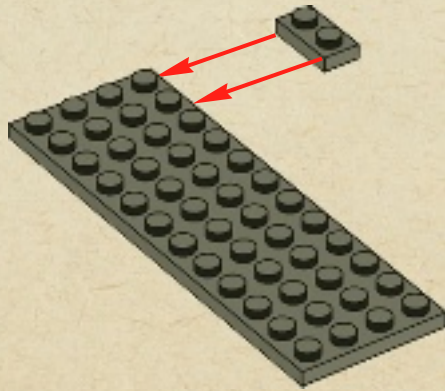





2

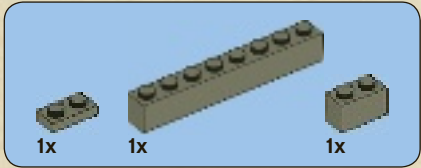
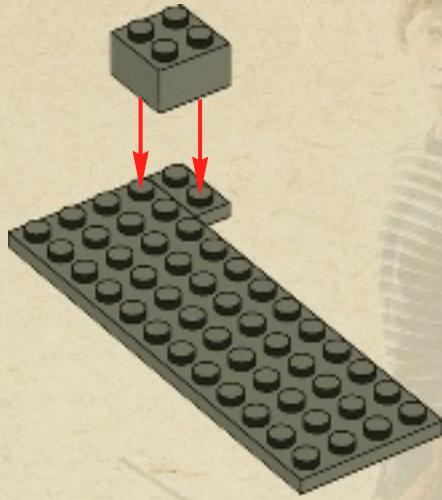

3

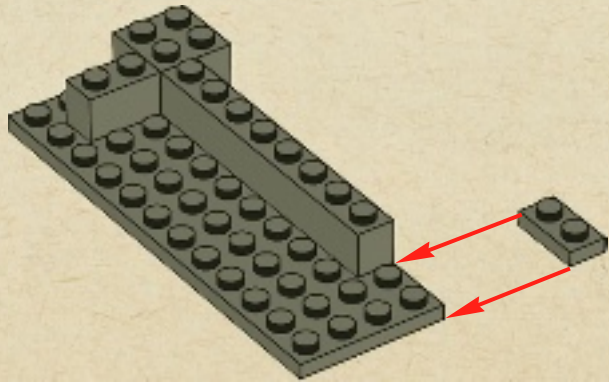



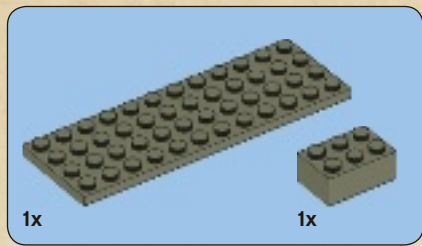

4

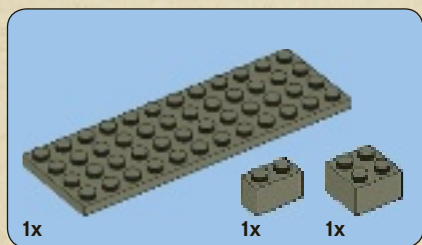
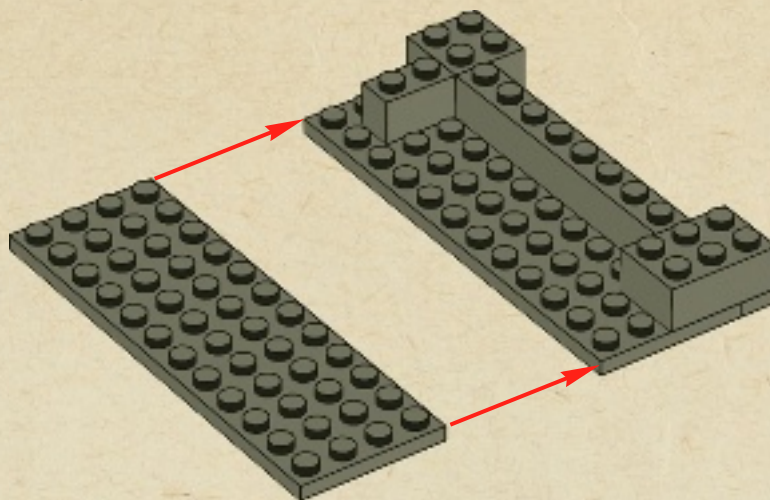

5

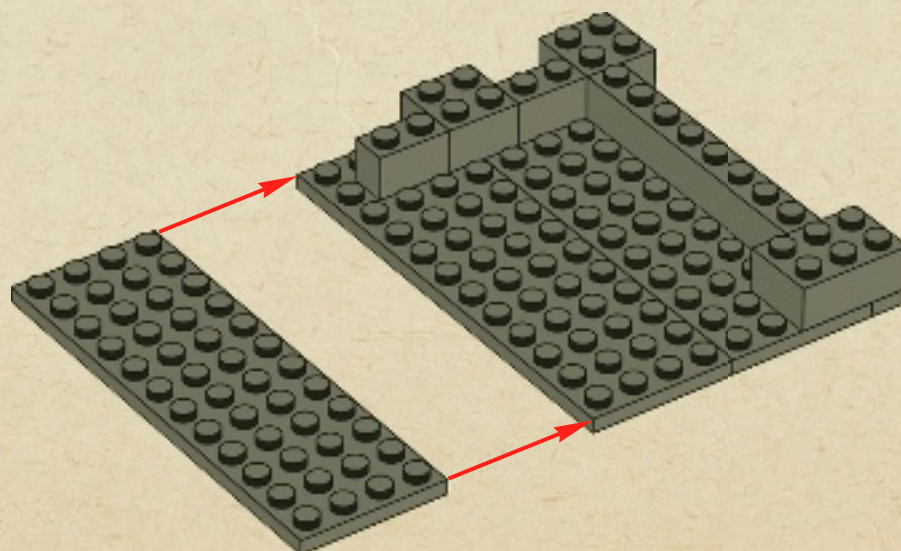





6

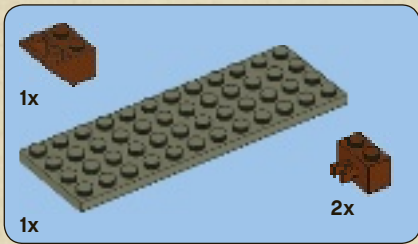
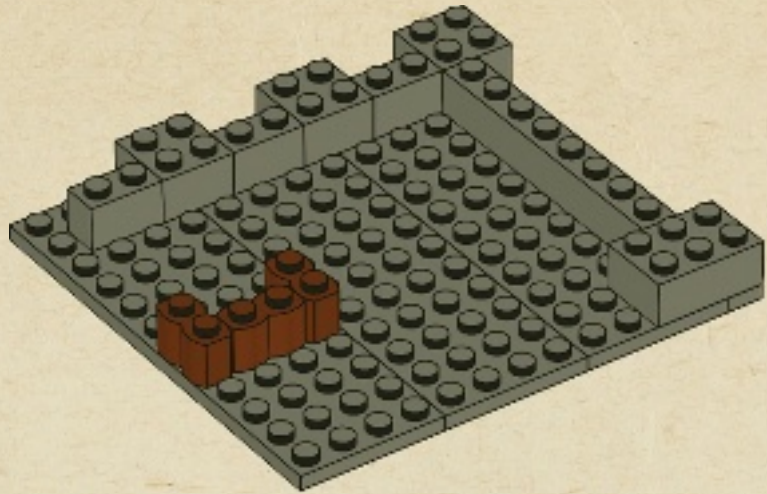

7

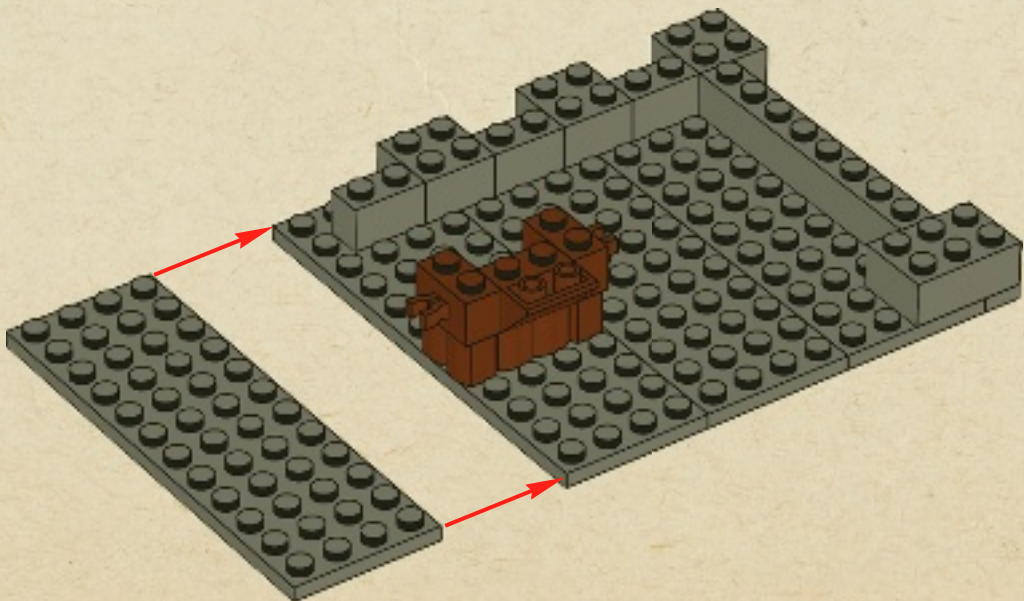



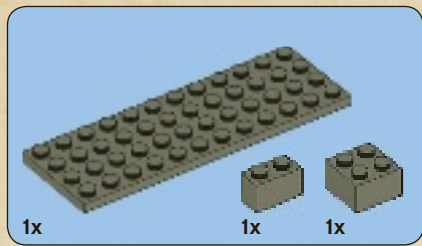

8

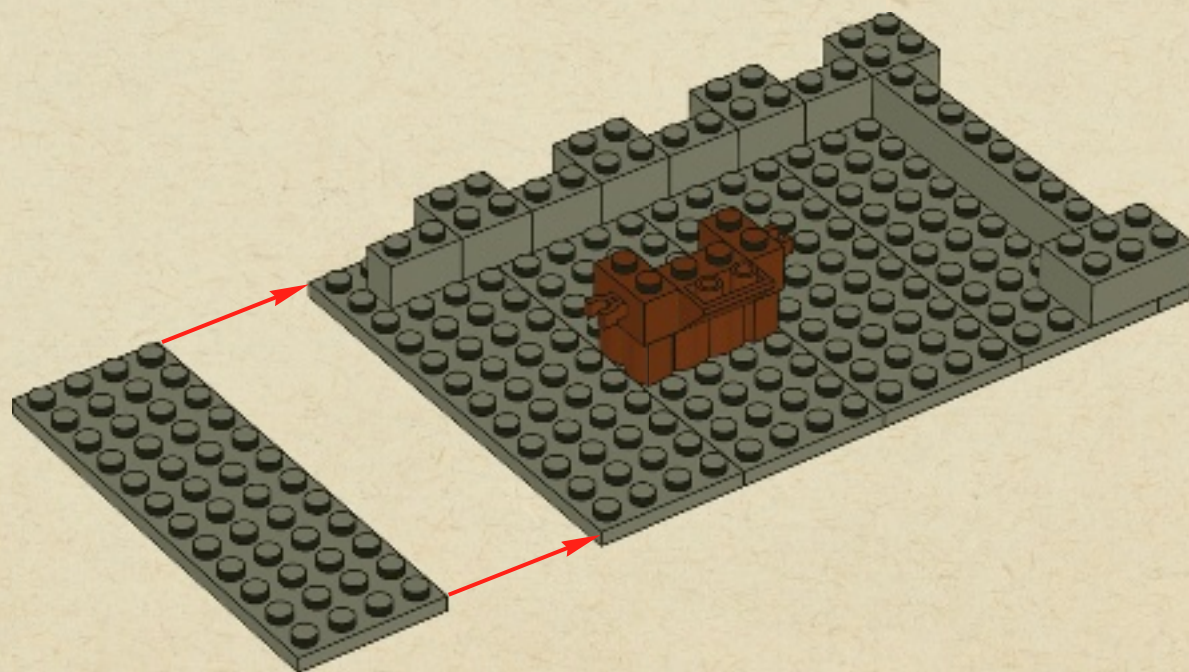





9

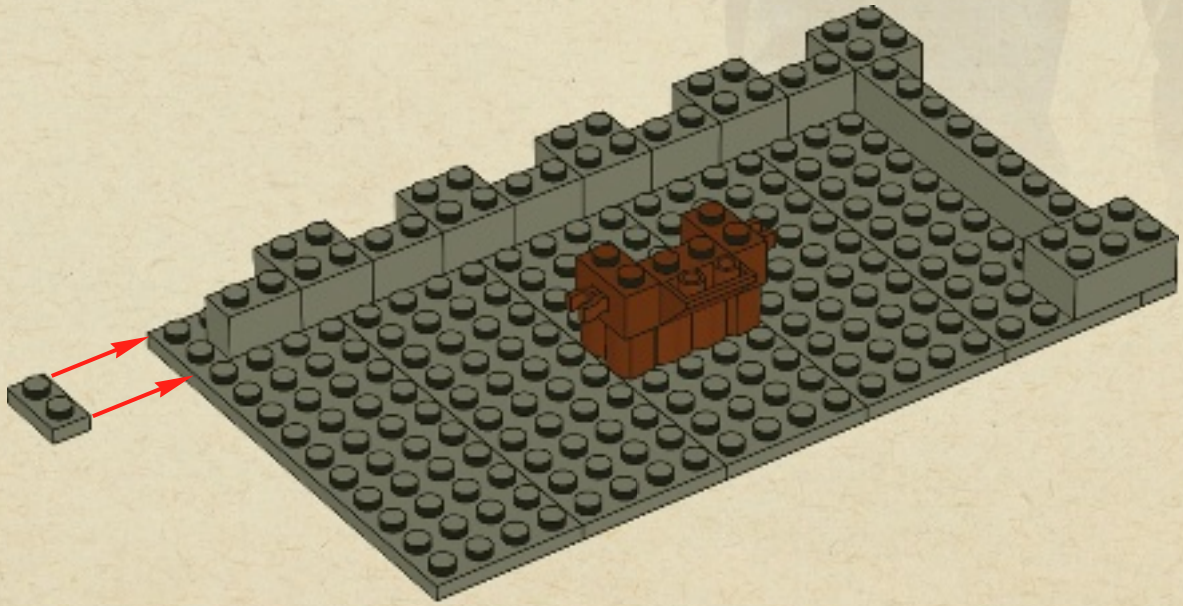



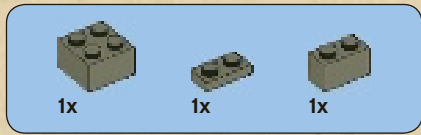

# 10

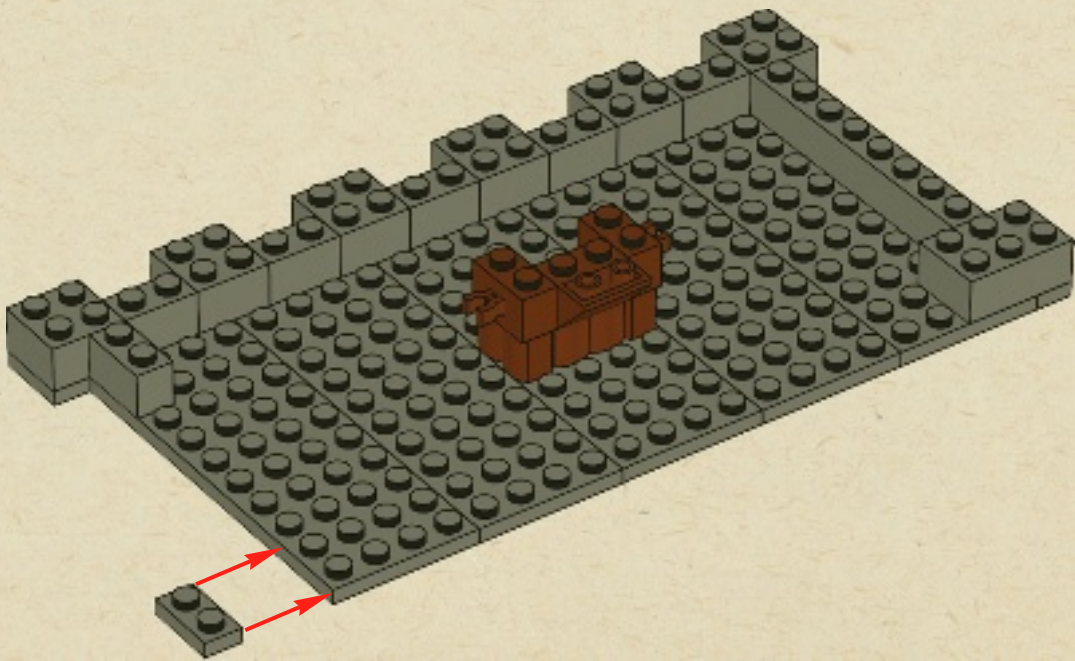





1x



1x

# 11

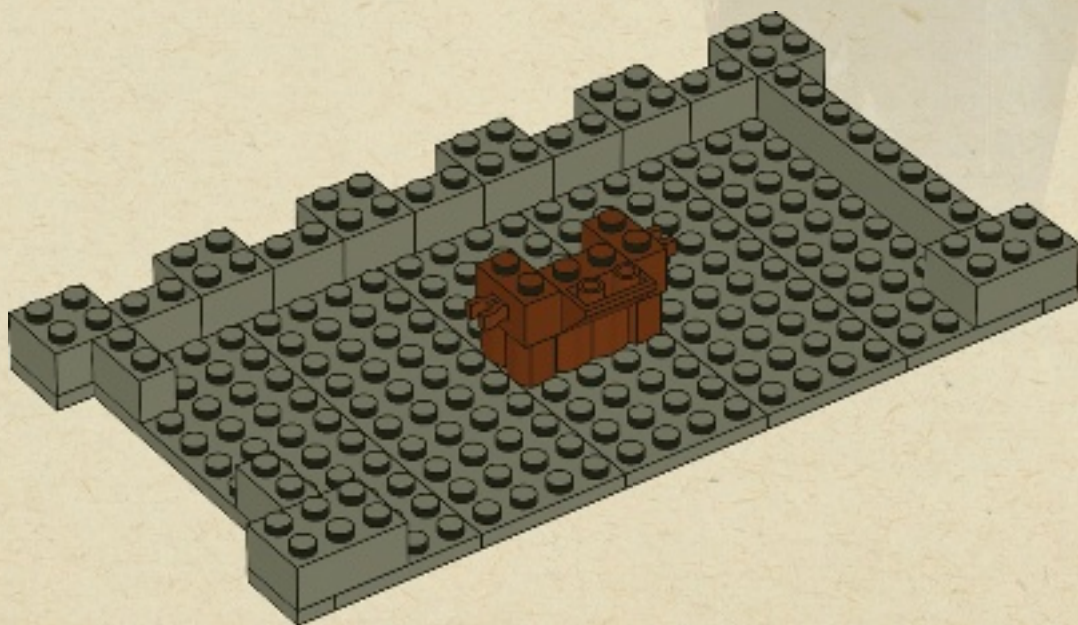



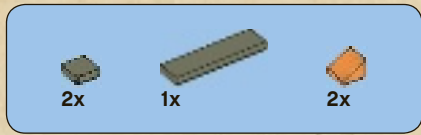

# 12

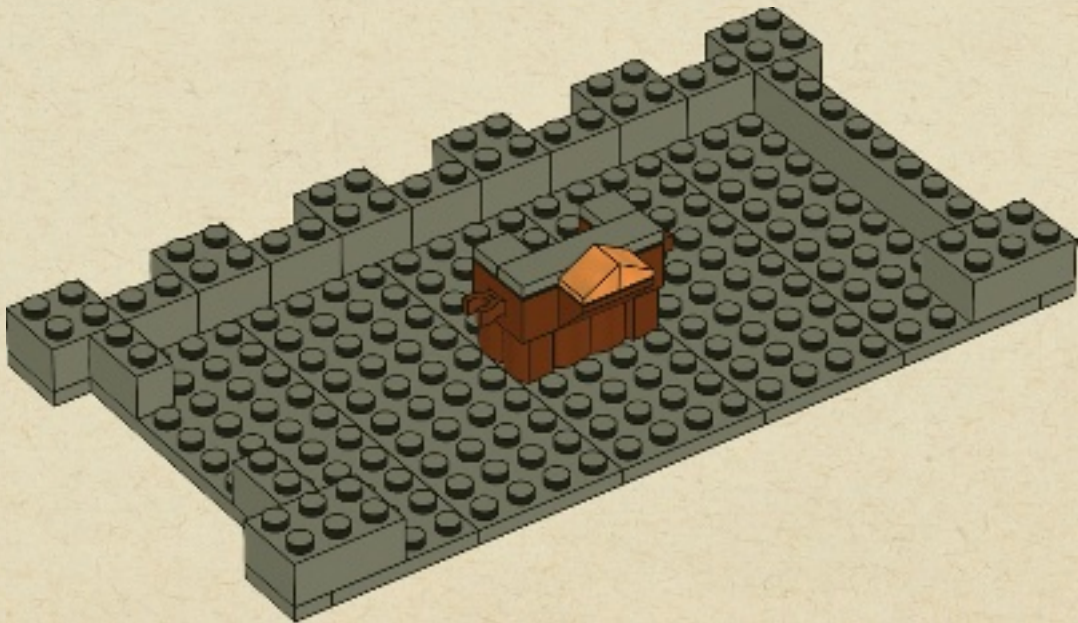





4x

# 13

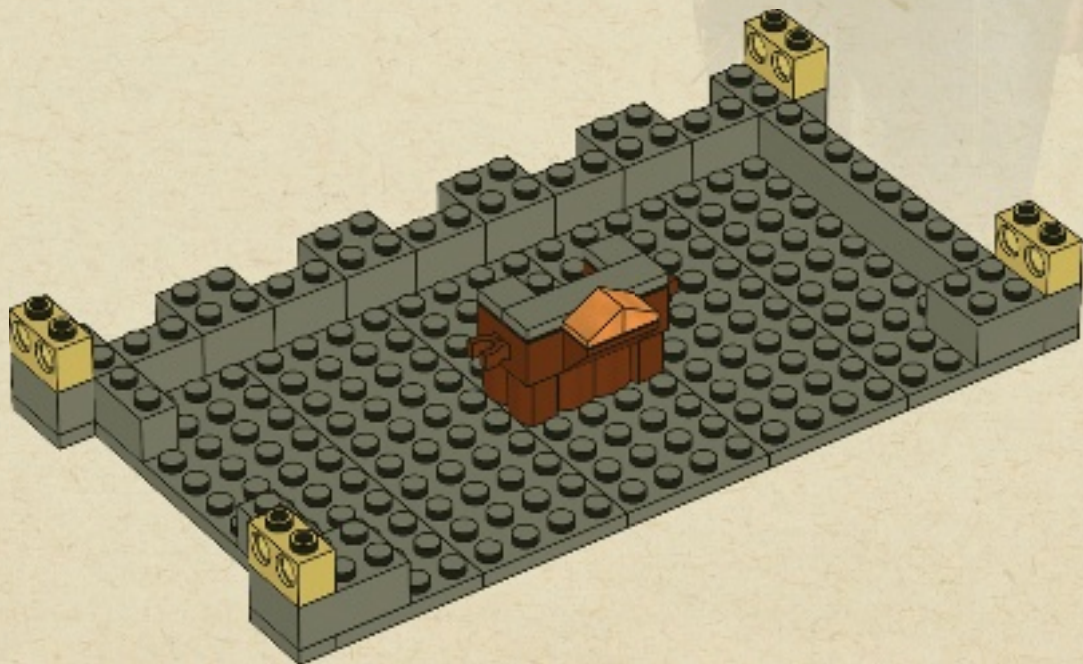



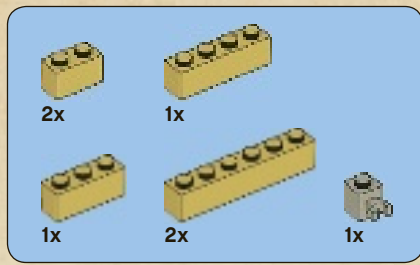

# 14

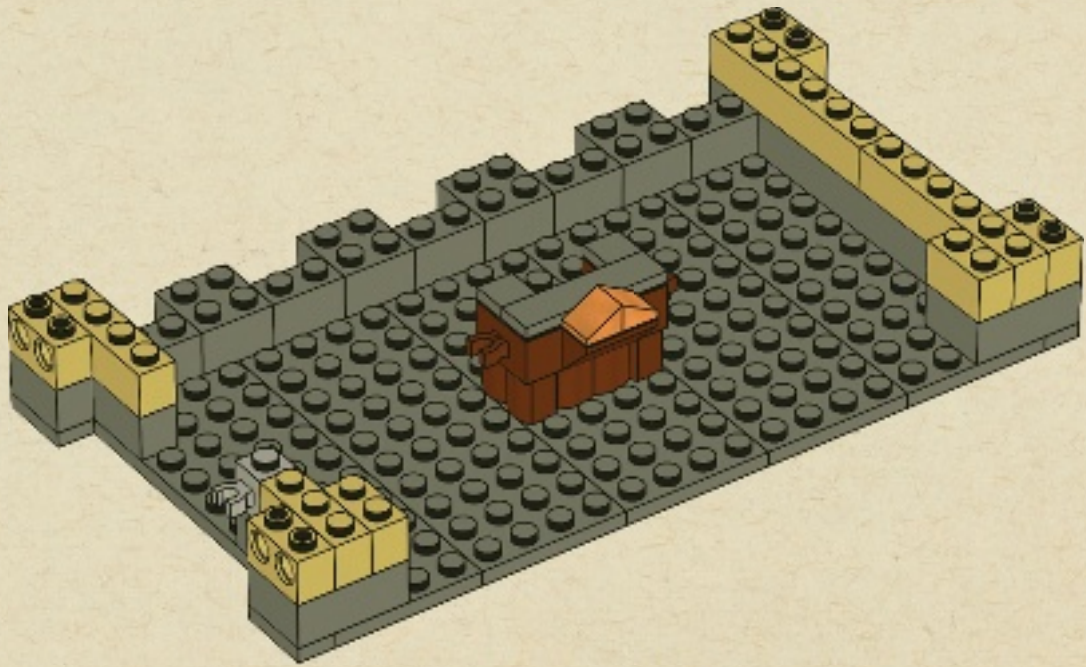



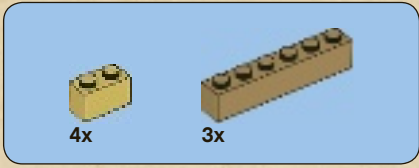

# 15

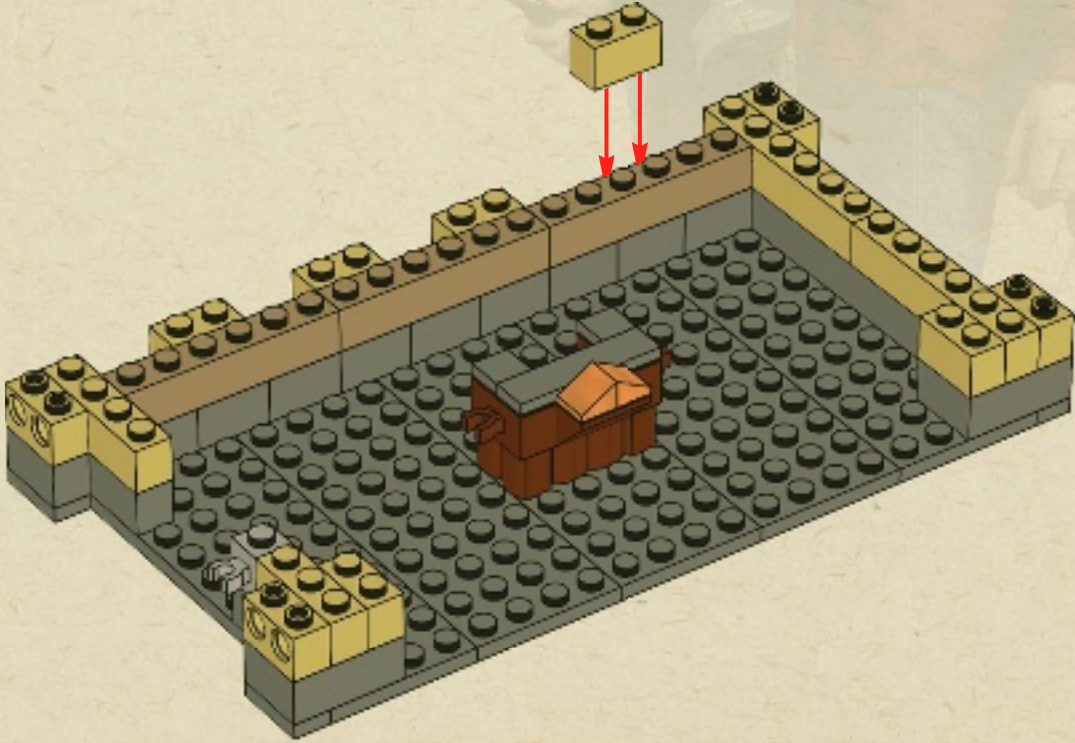



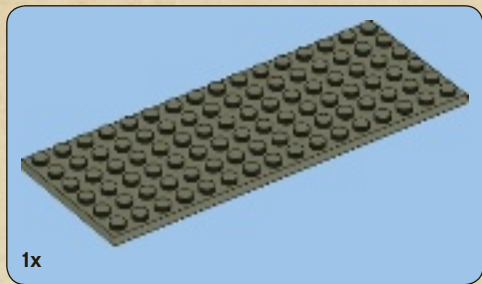

1x

# 16

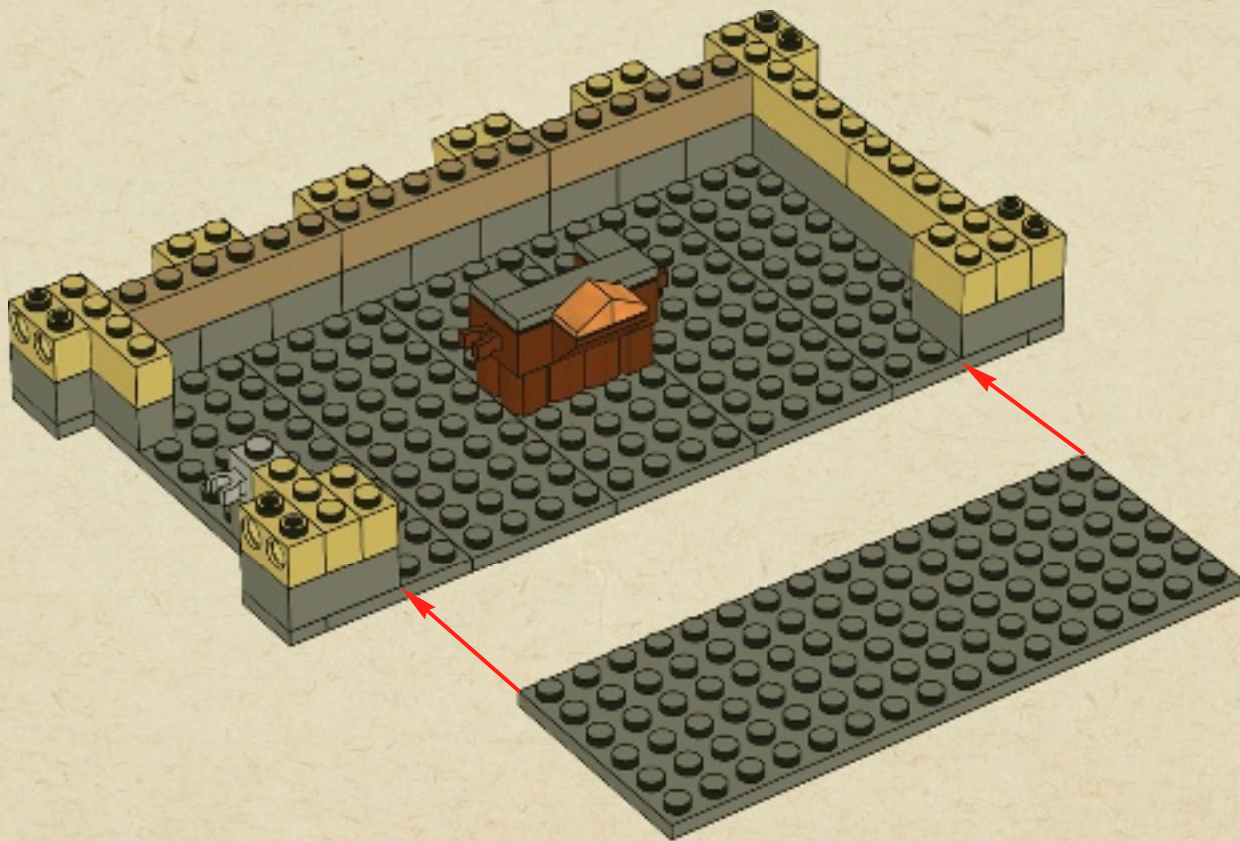



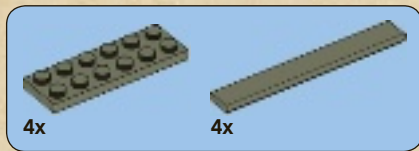

17

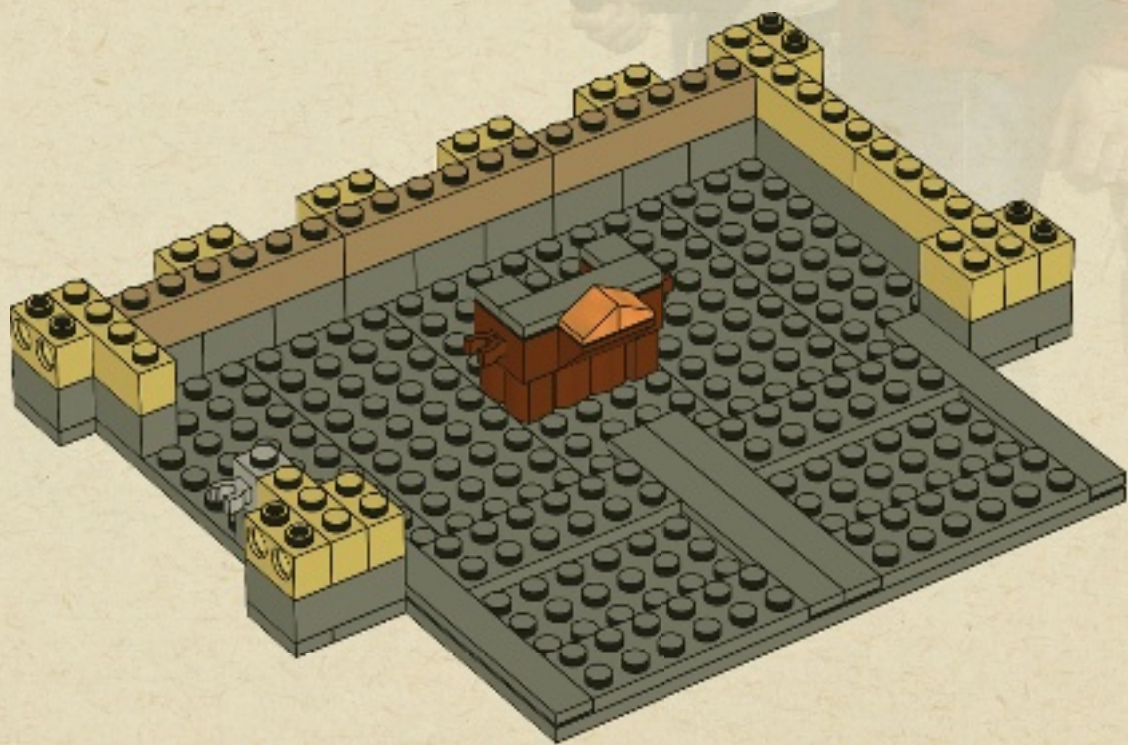



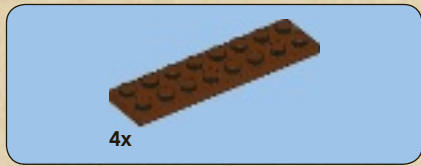

18

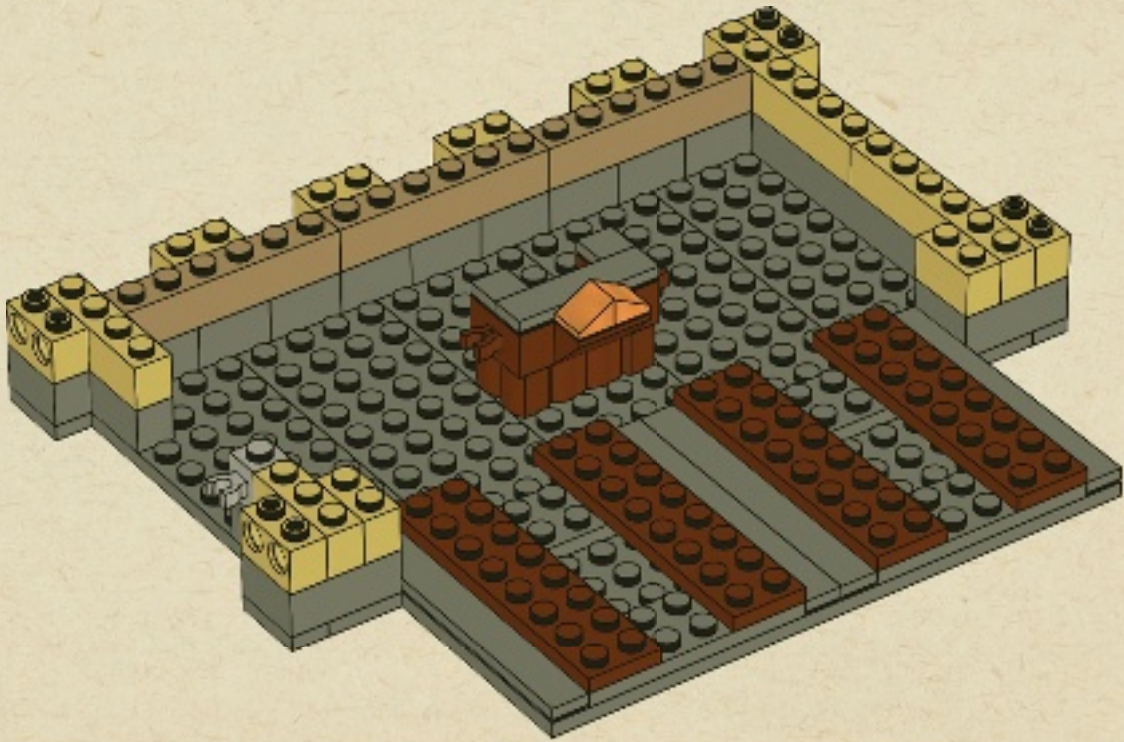





4x

# 19

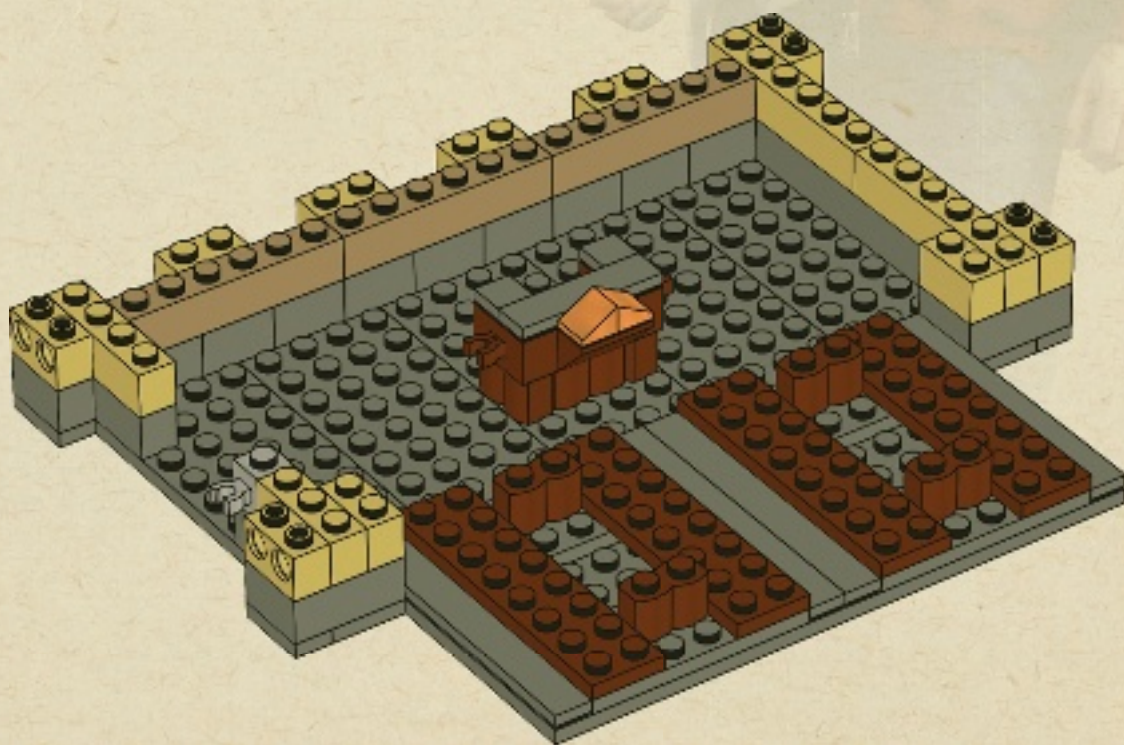



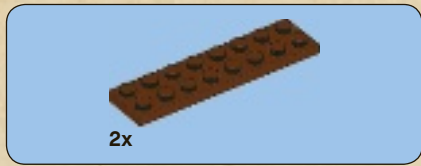

20

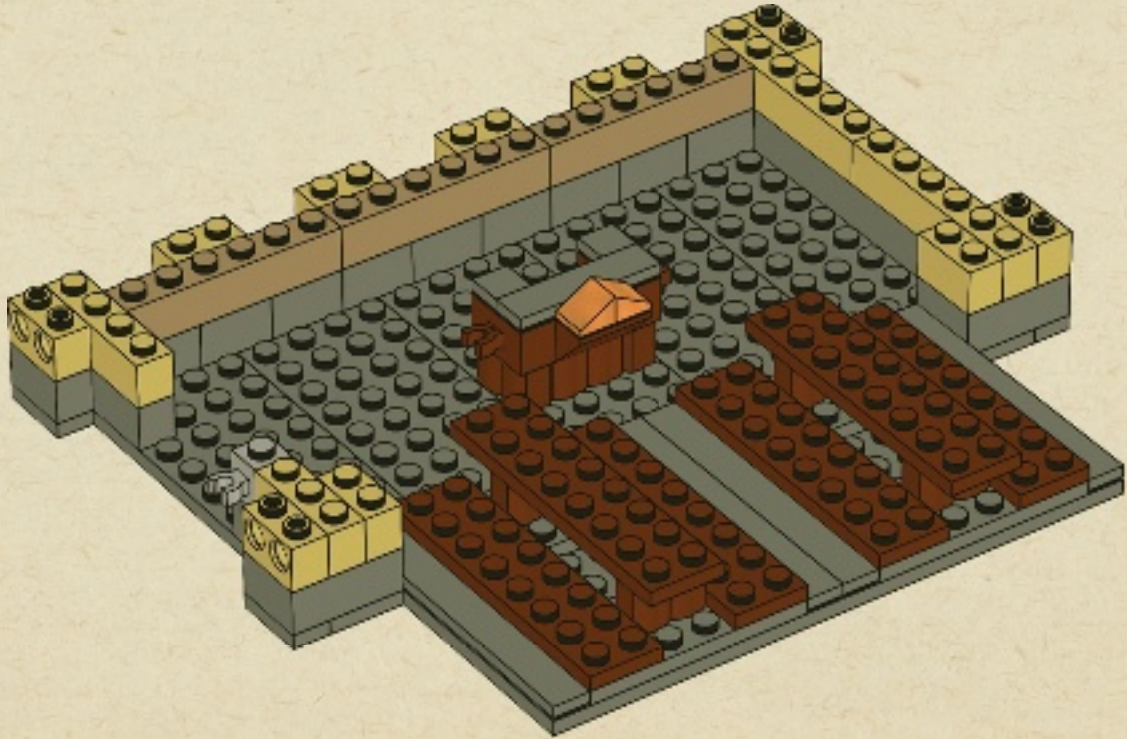





# 21

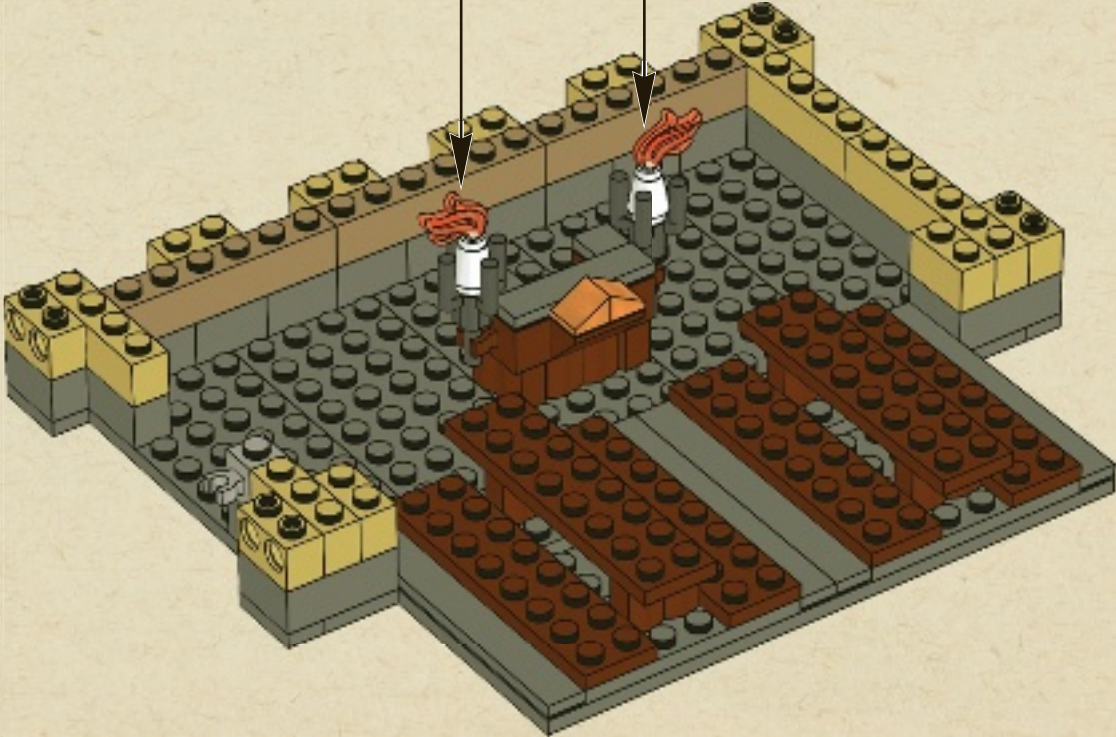
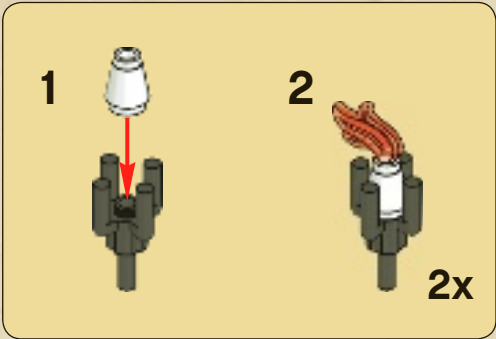



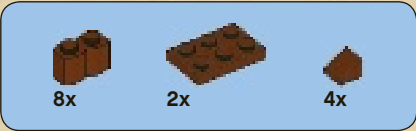

# 22

1

2

3

4

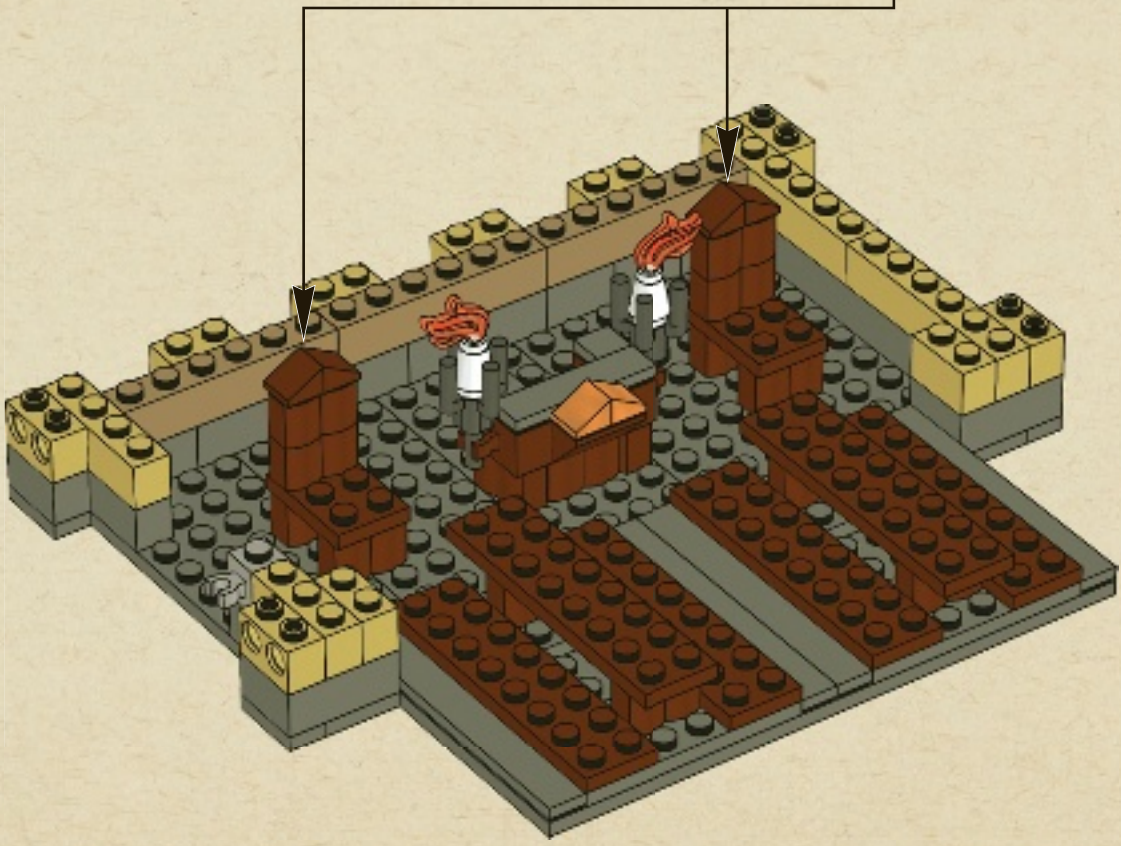





6x



5x

# 23

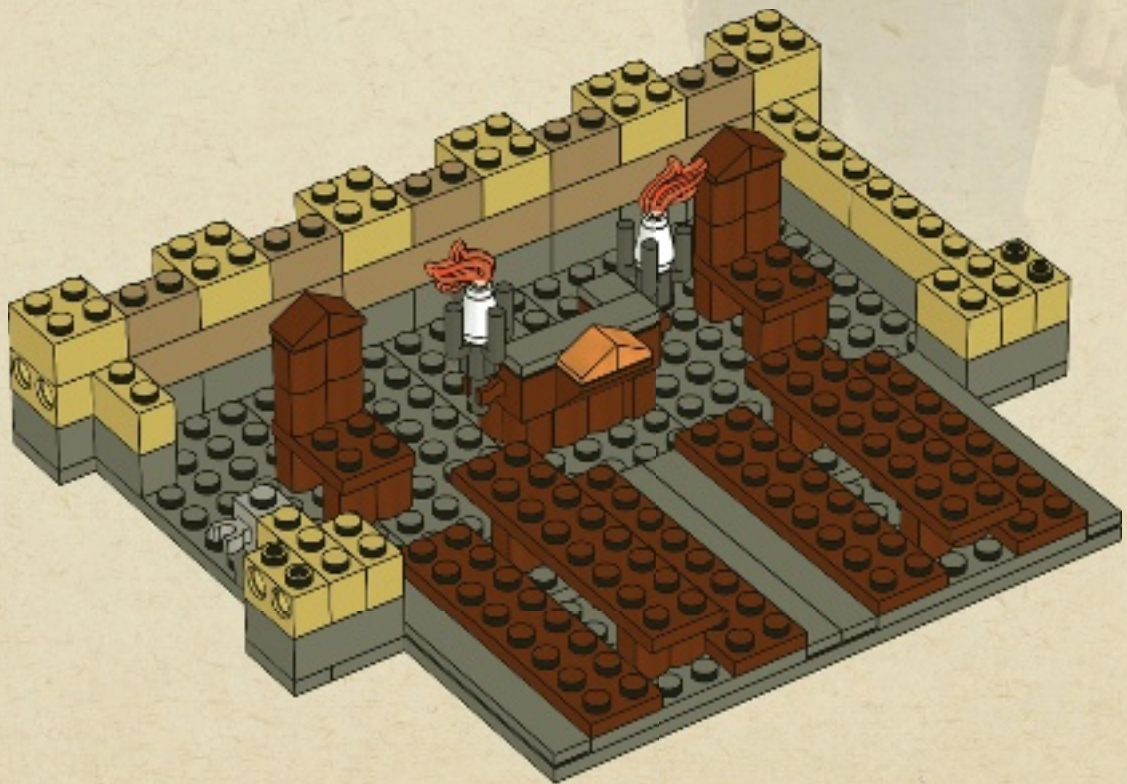





24

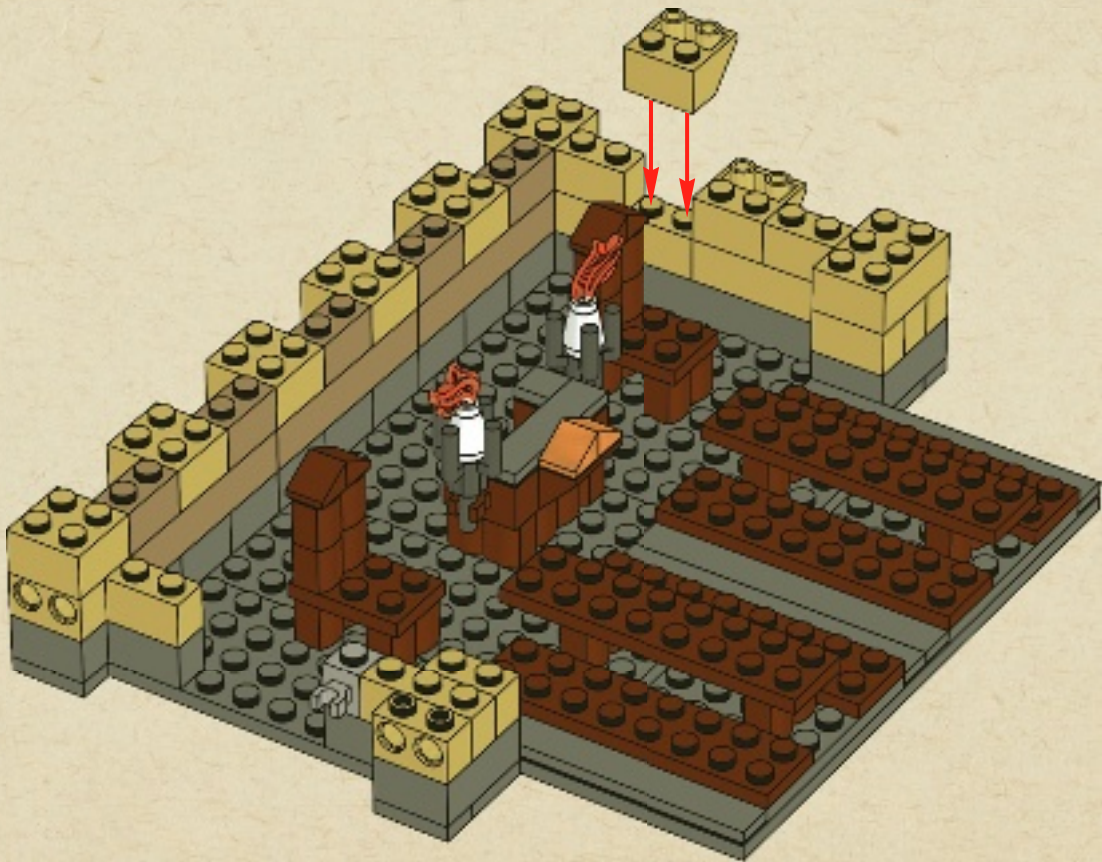





2x



1x

# 25

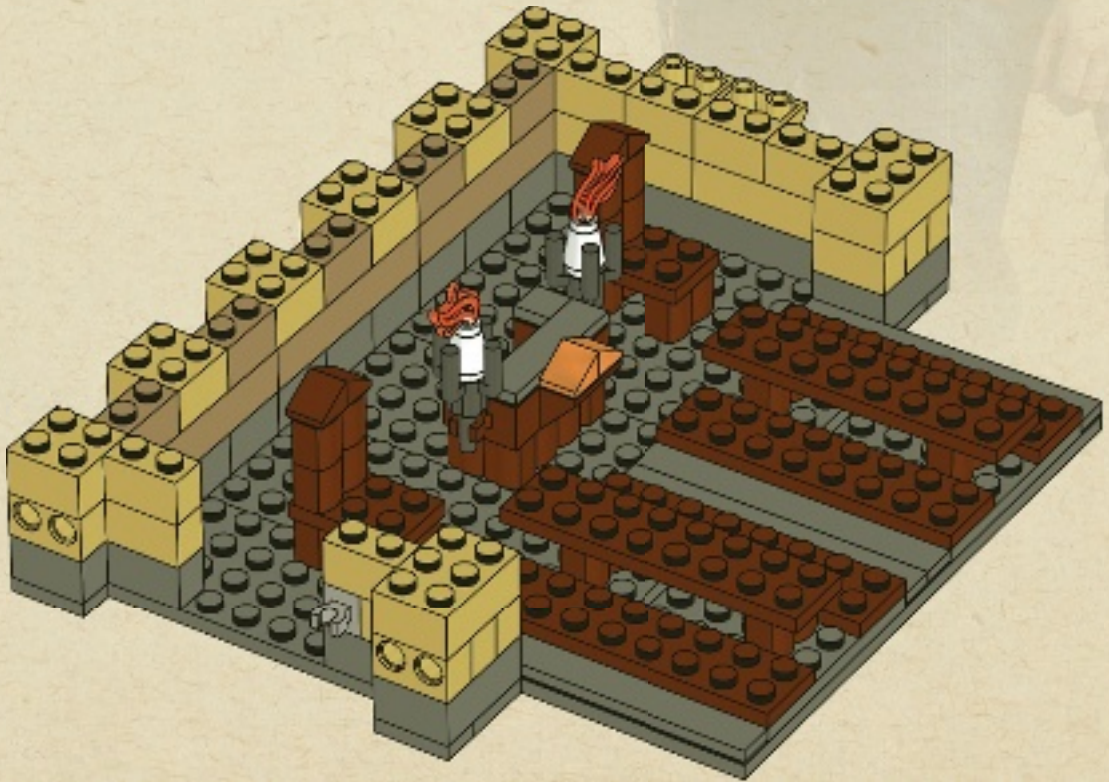





2x

# 26

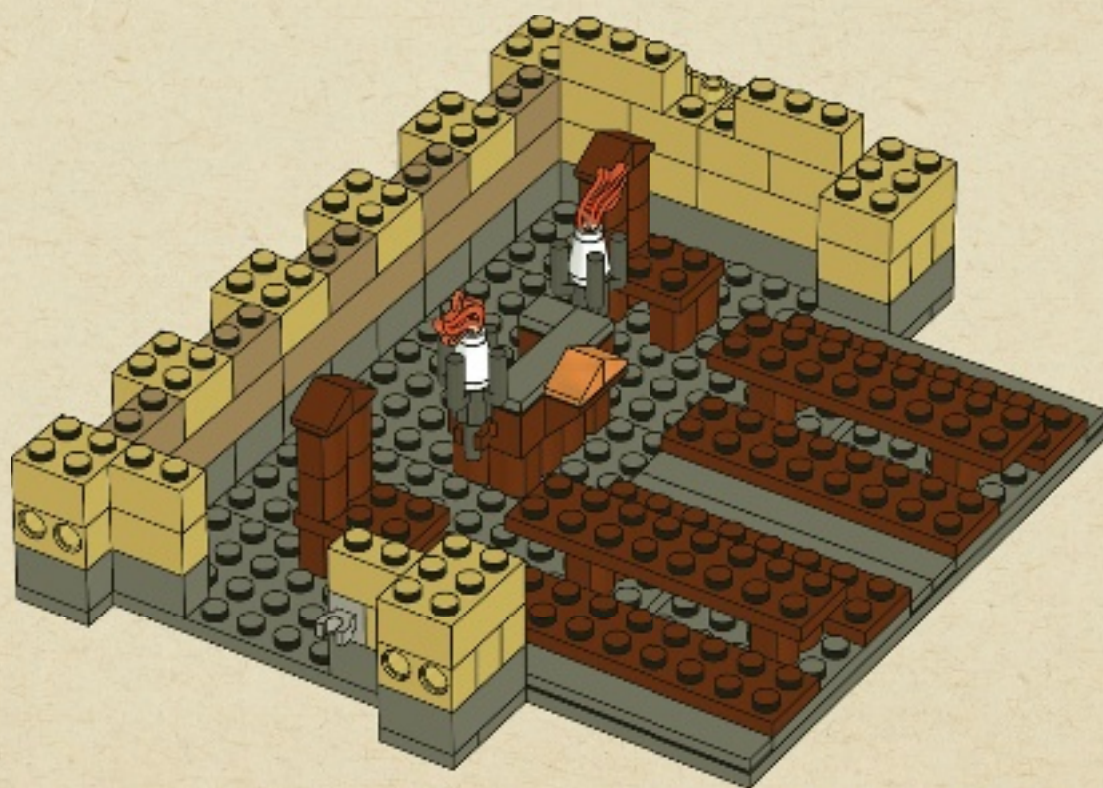





2x

27

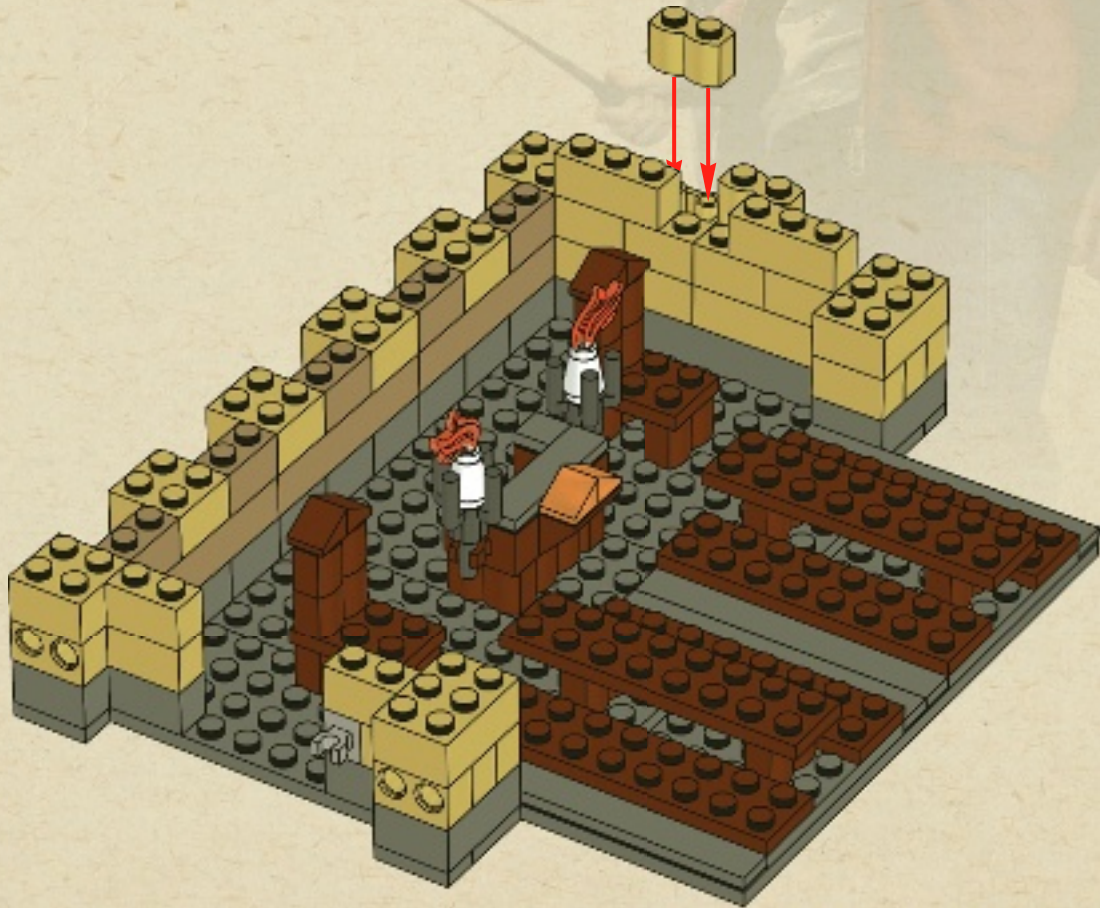





2x



2x

# 28

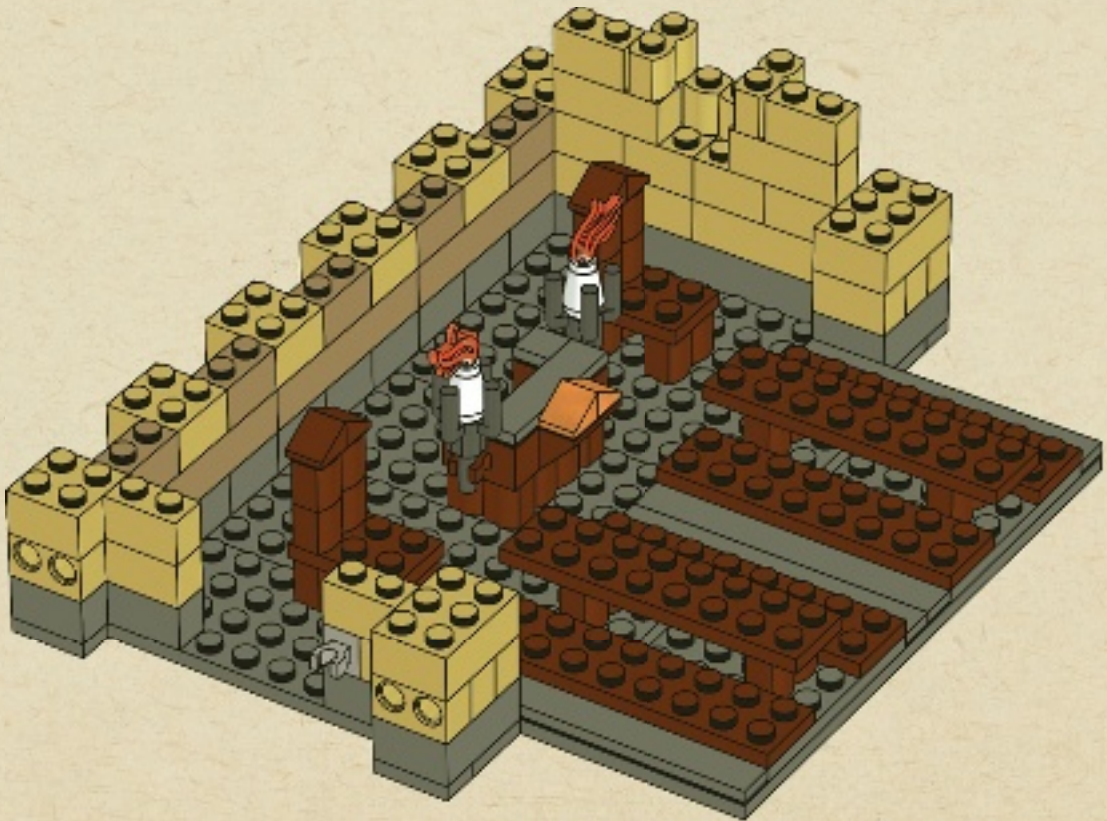



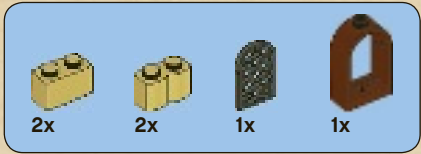

29

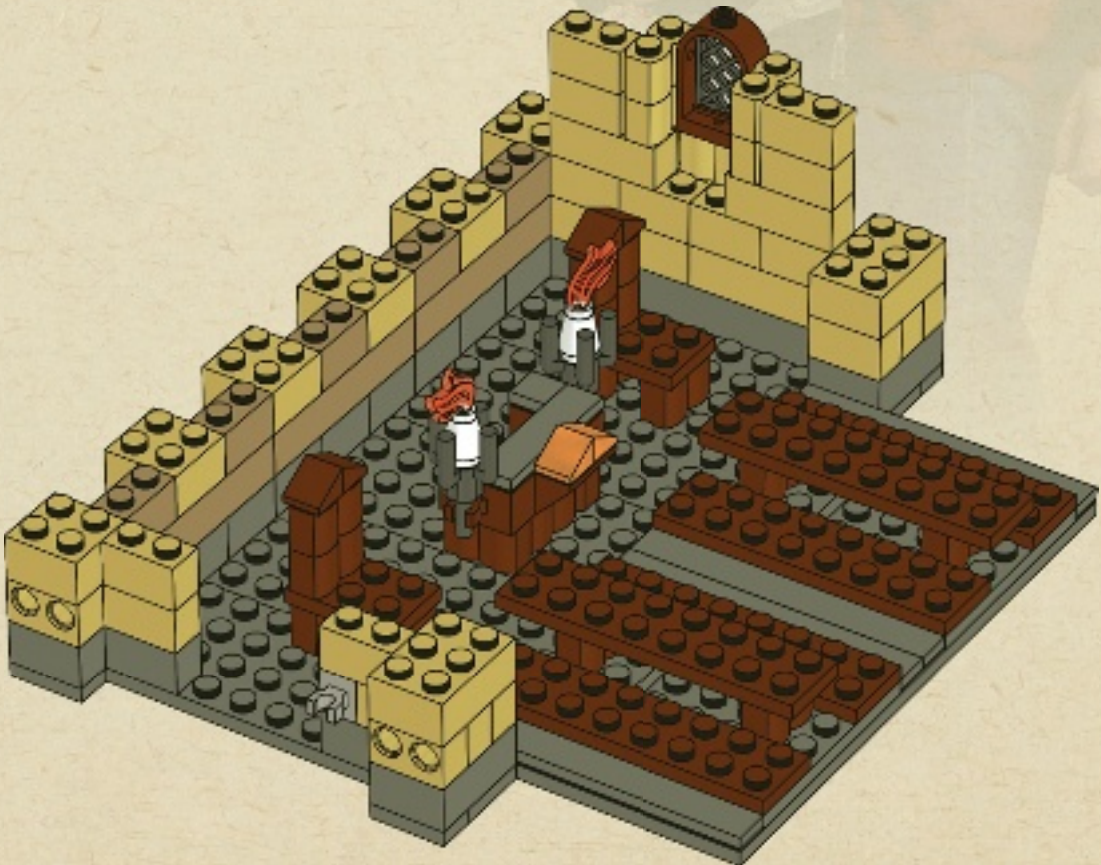



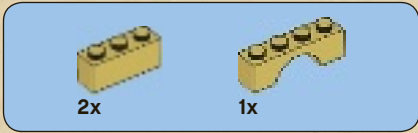

# 30

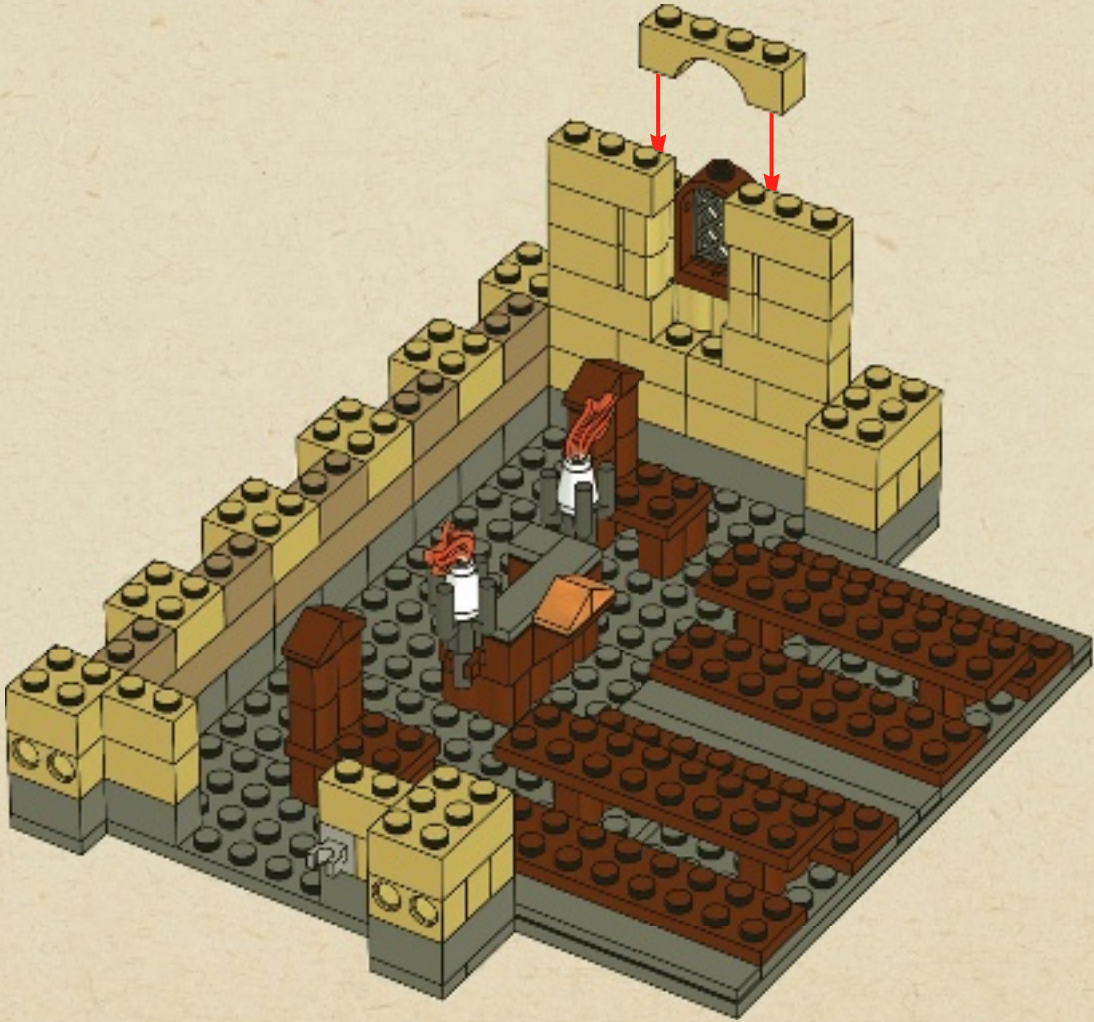





2x



2x

# 31

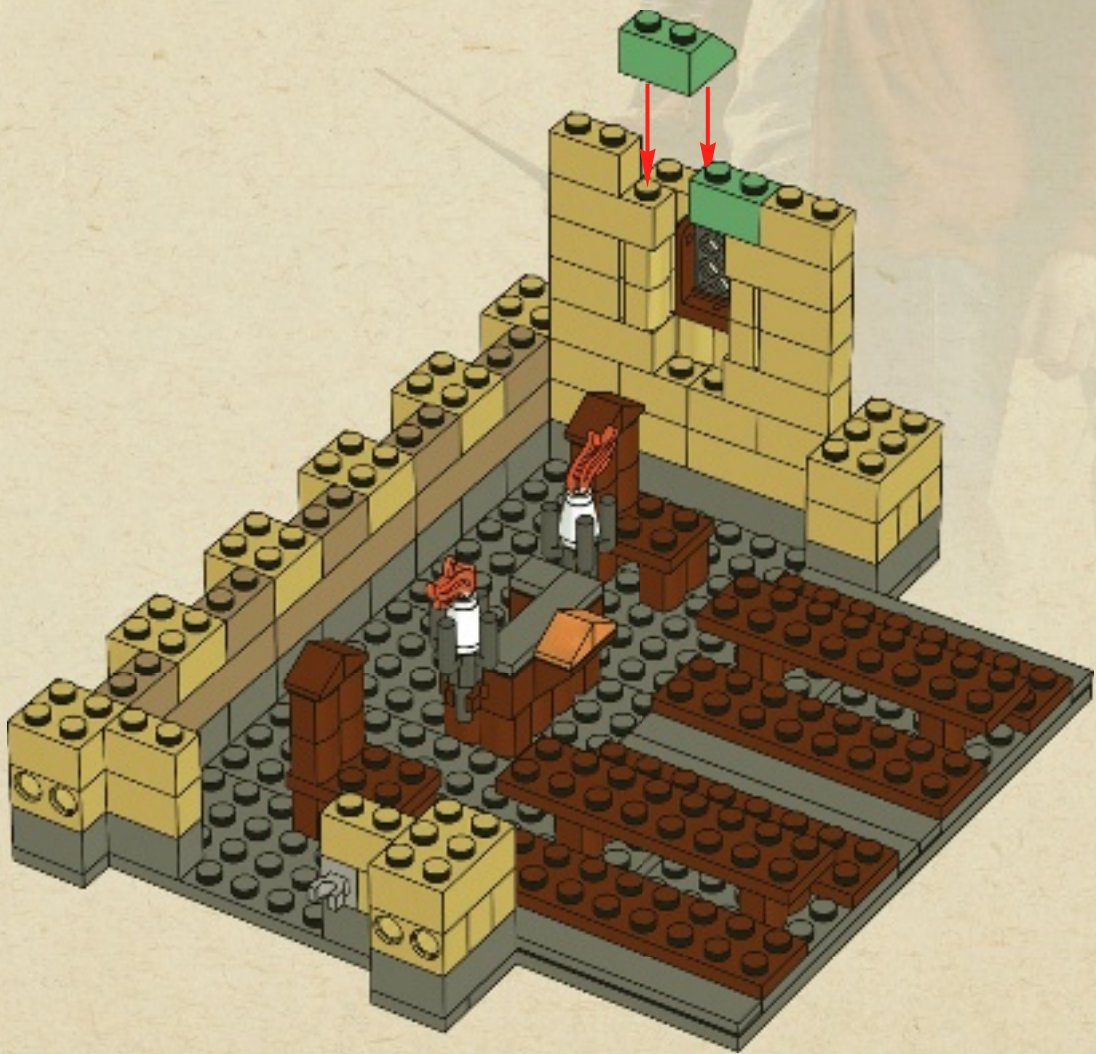



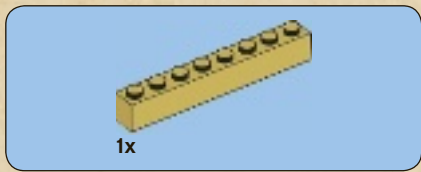

# 32

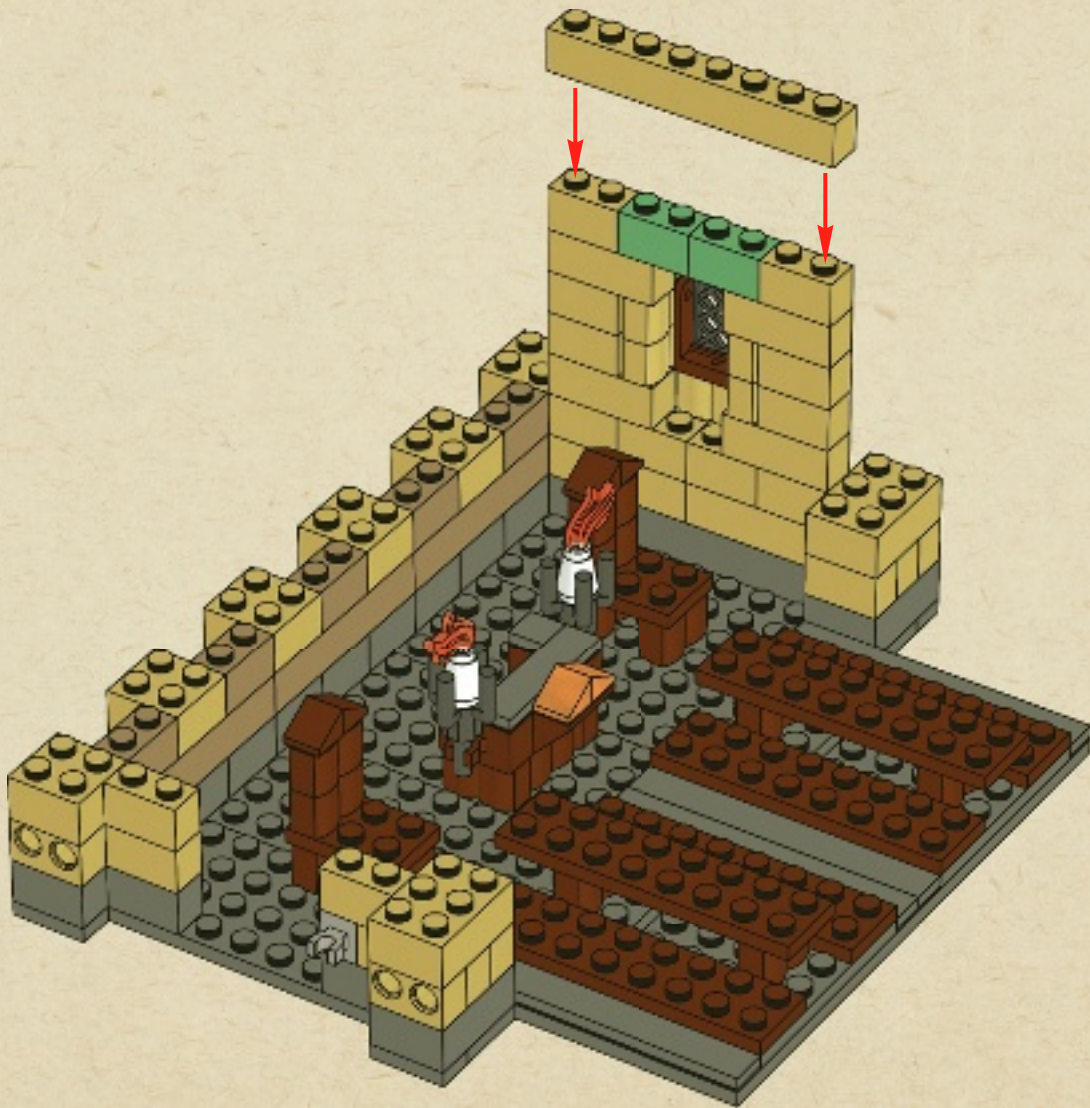





24x

# 33

1

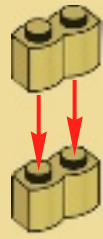

2



4x

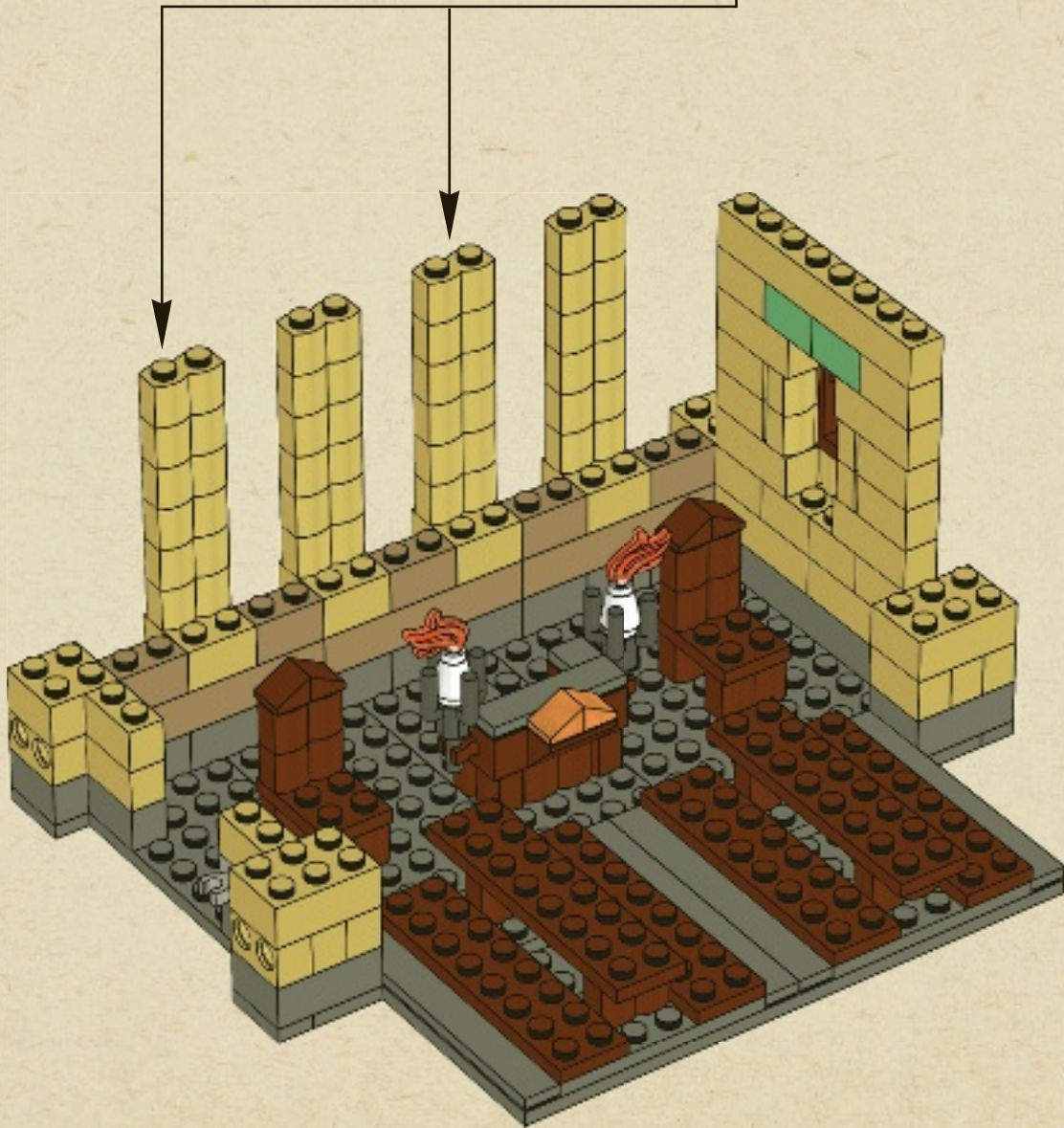



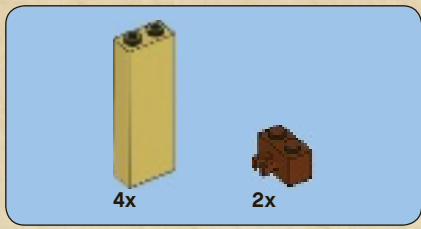

34

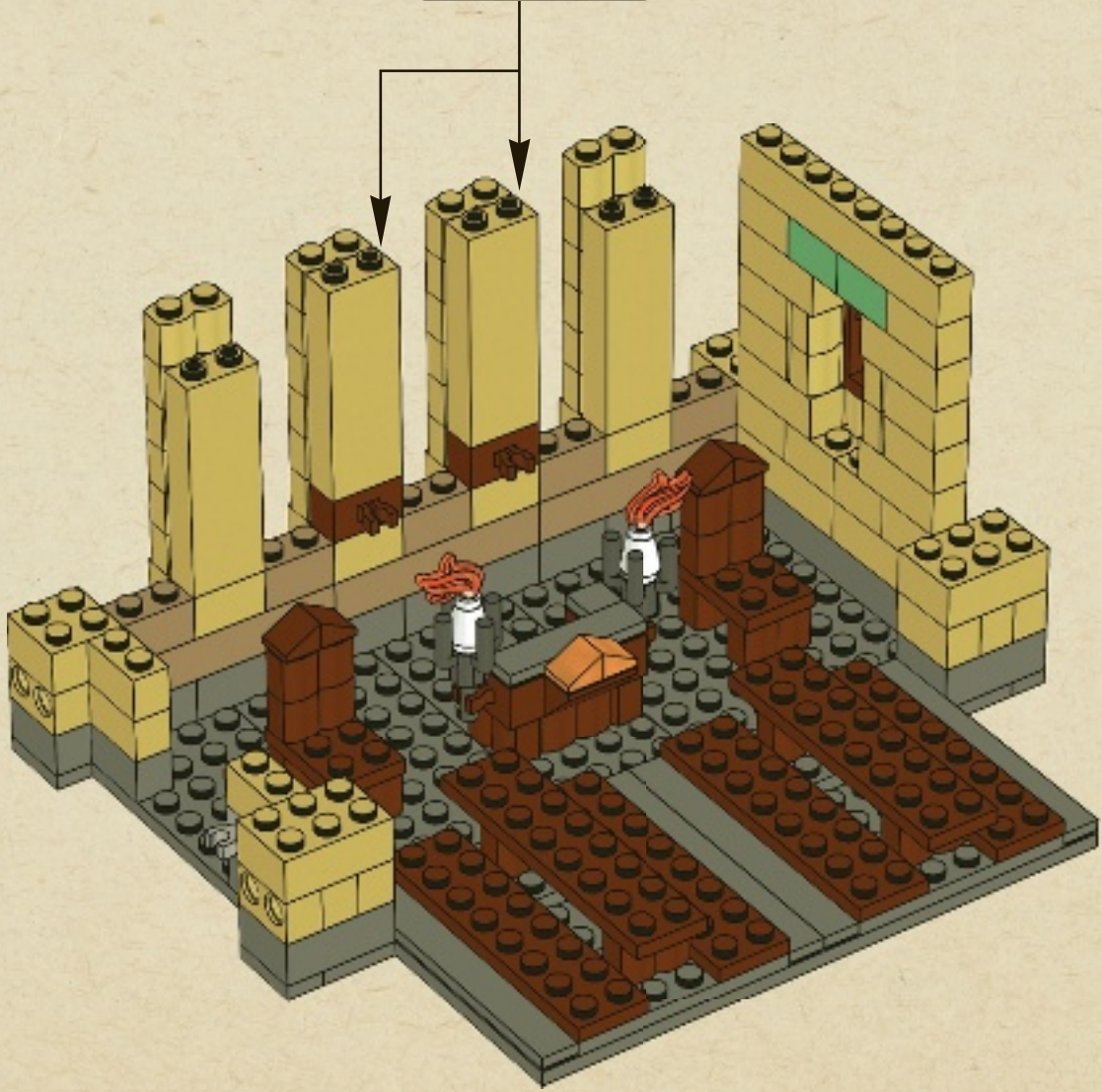
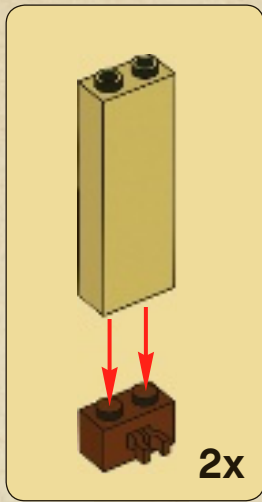





15x

# 35

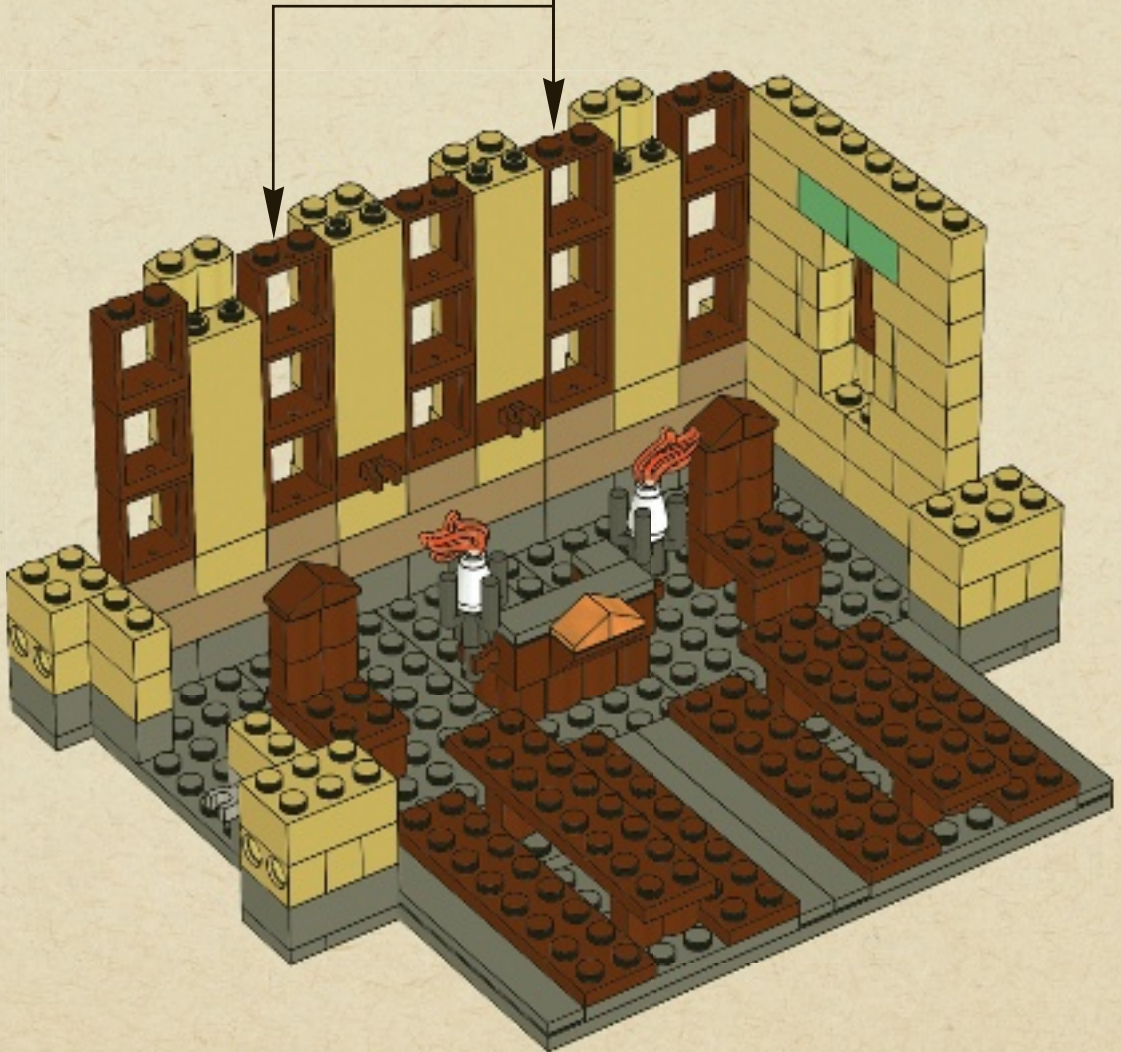
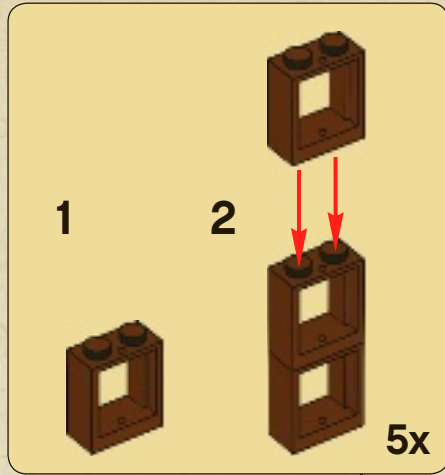





# 36

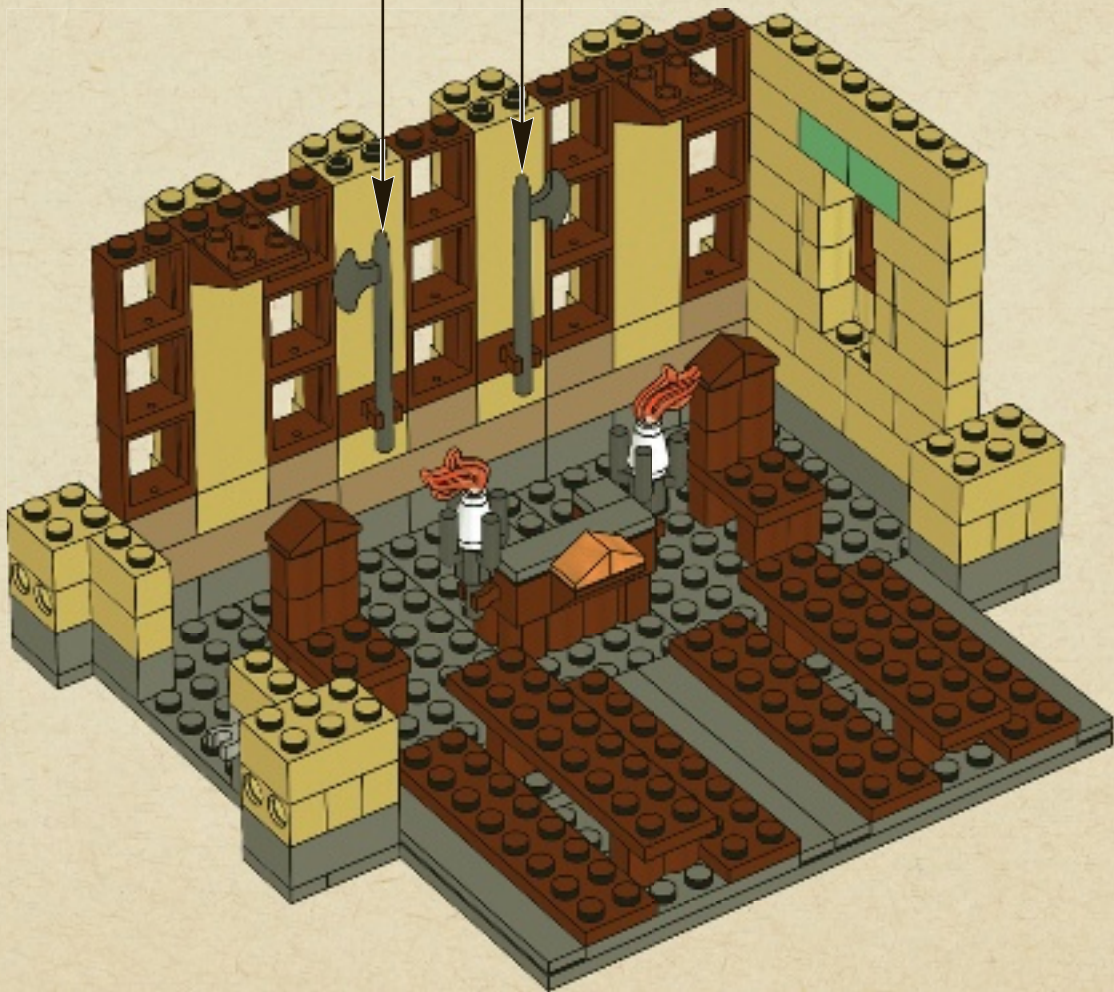





1x



1x



1x

# 37

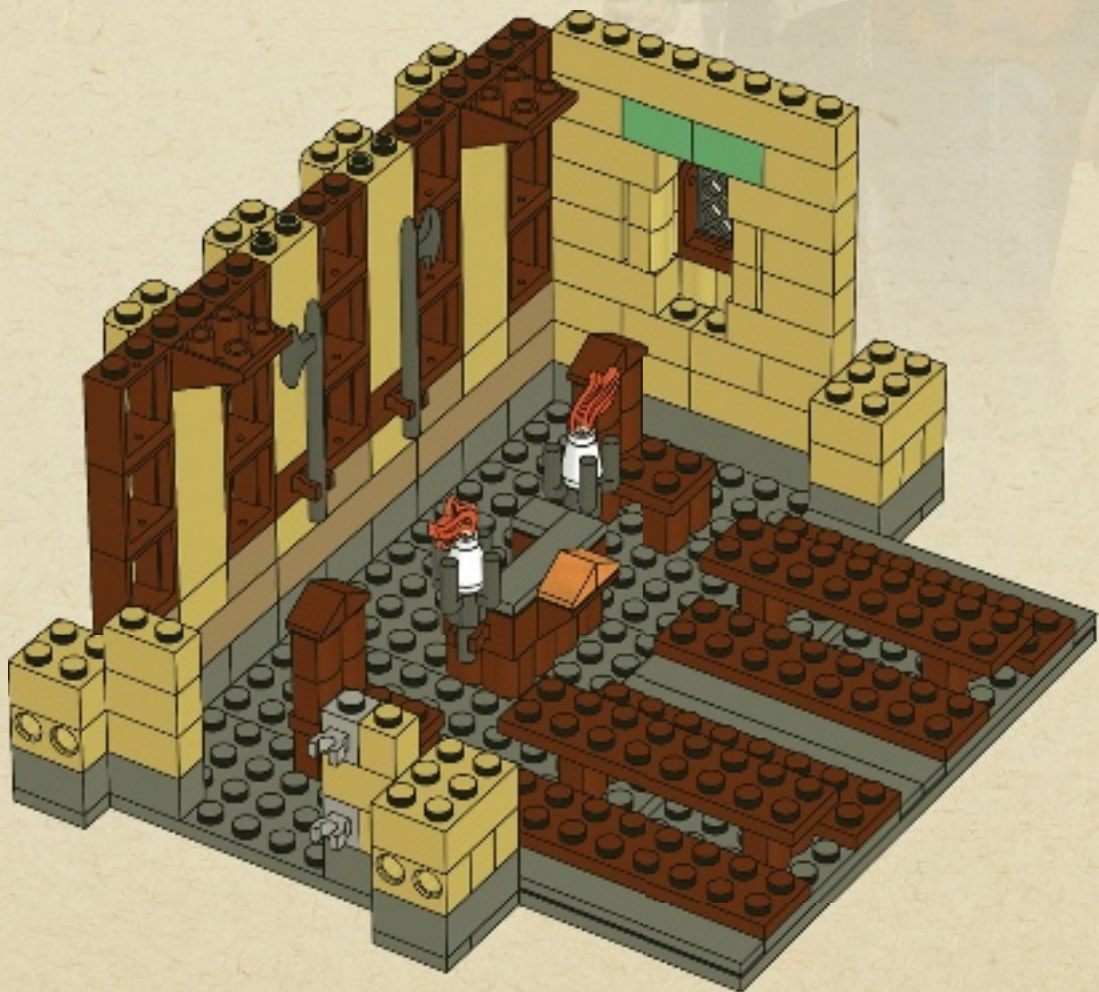



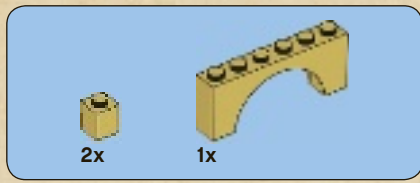

# 38

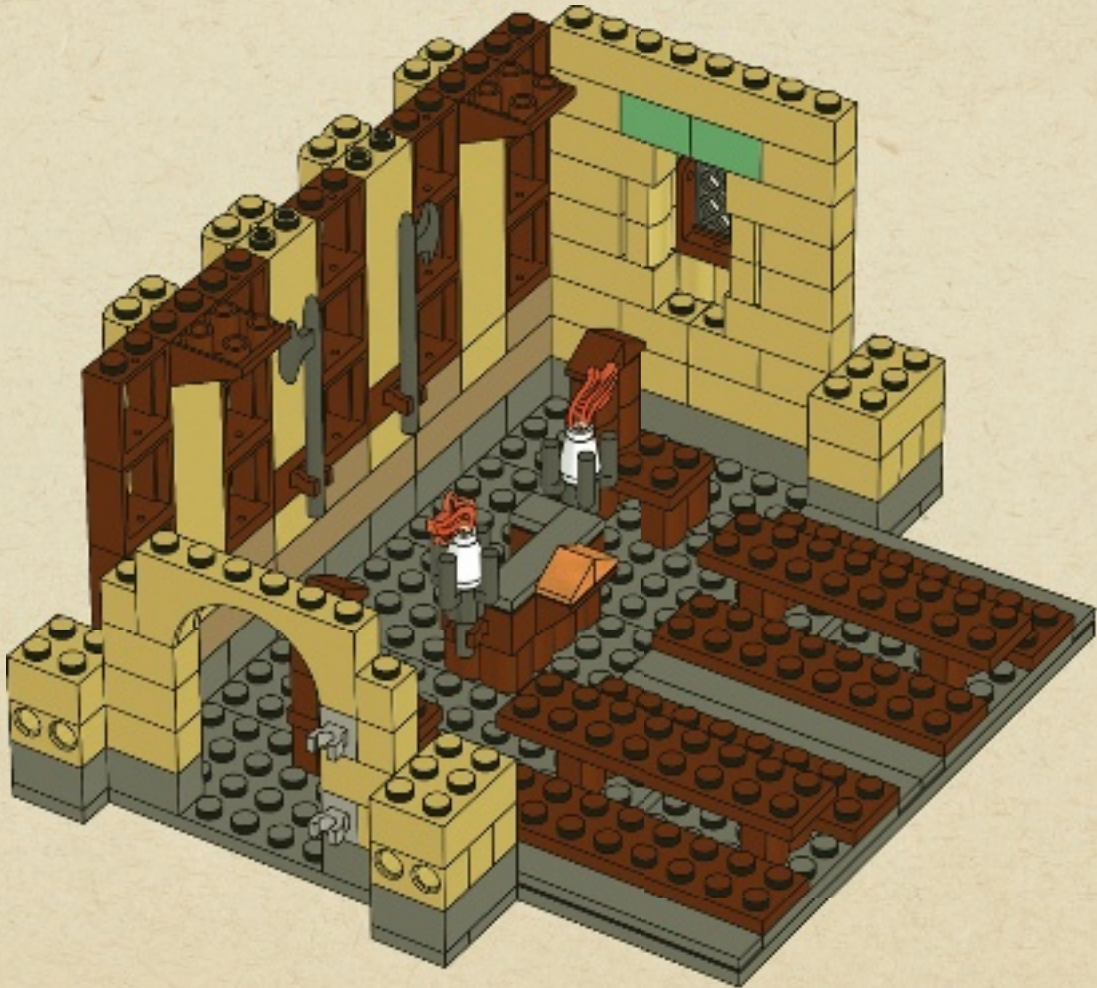





# 39

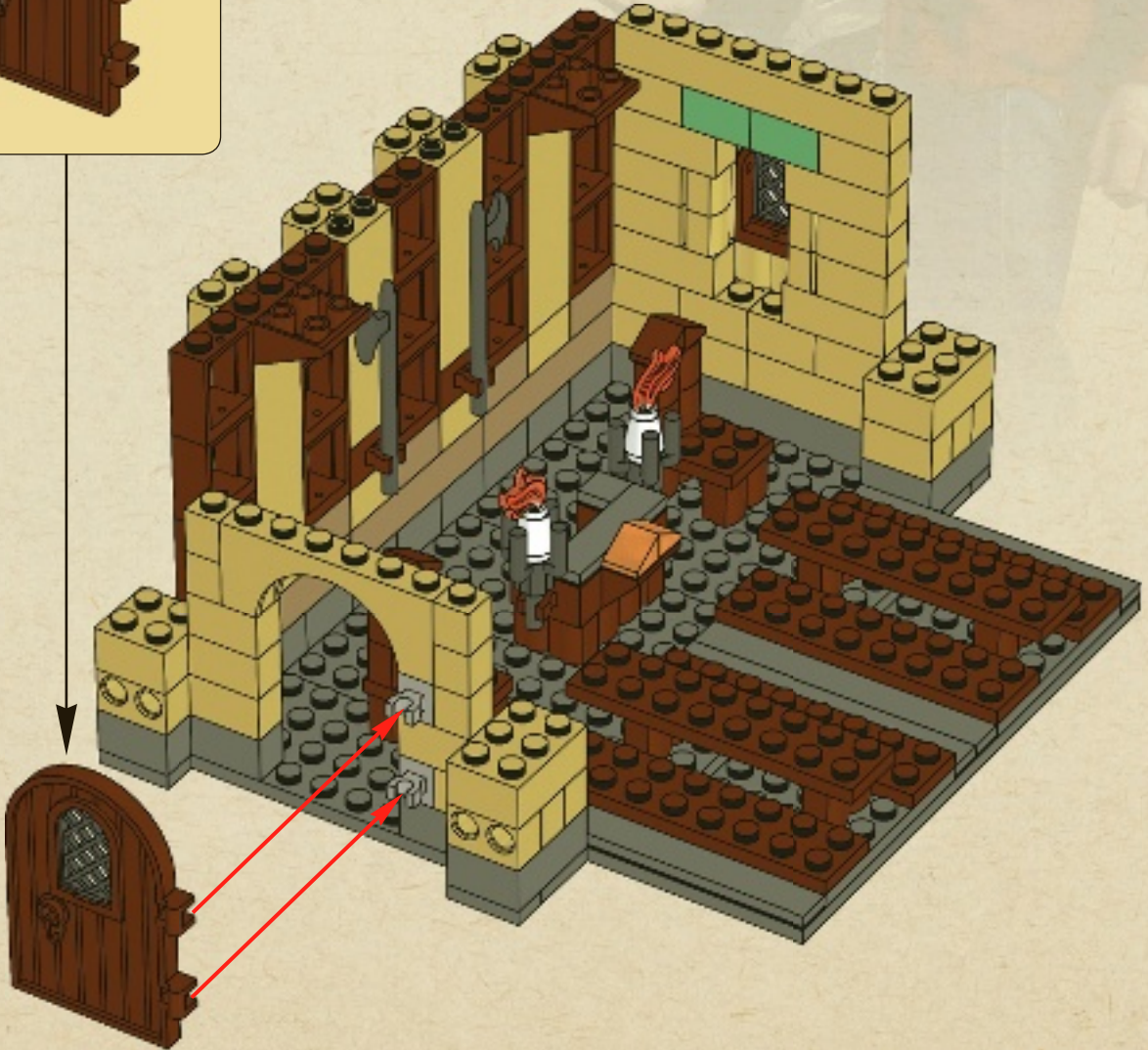





1x



2x

# 40





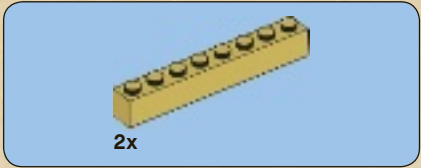

41

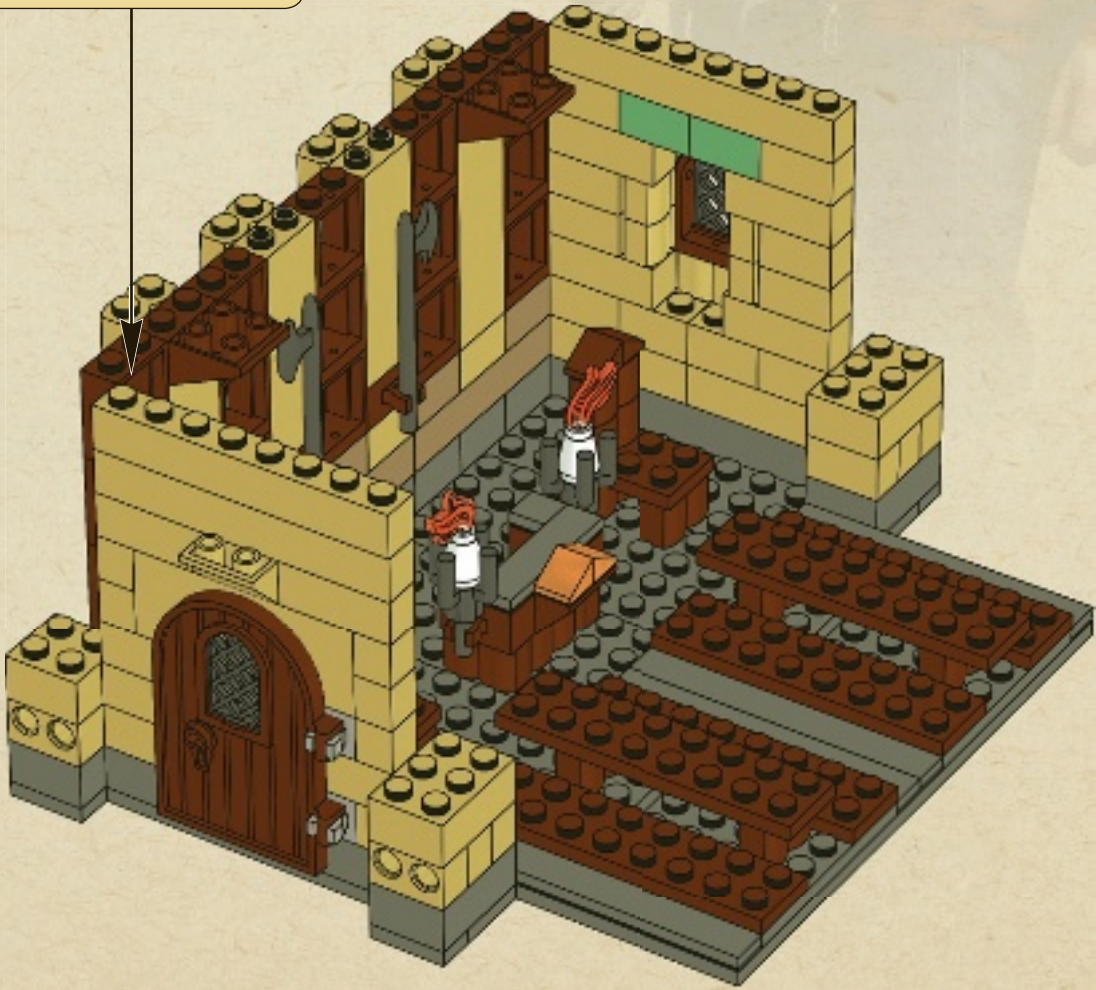
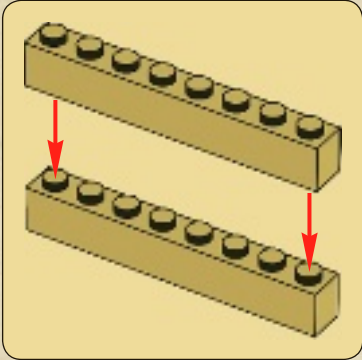





# 42

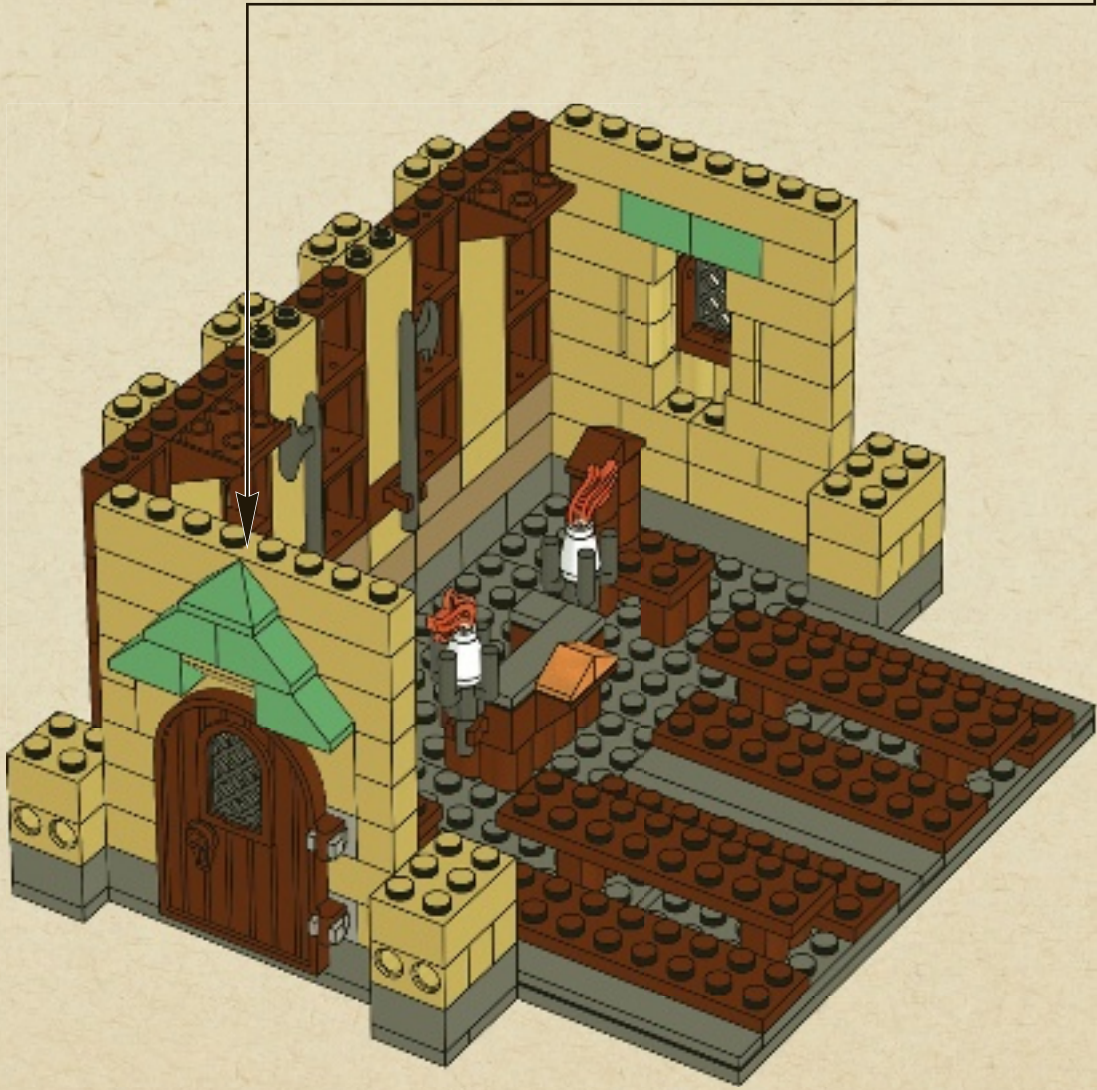
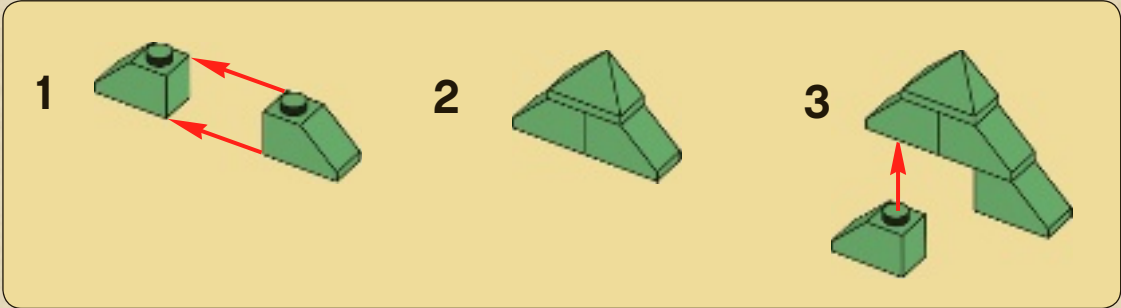



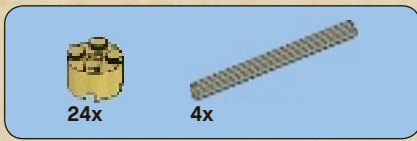

# 43

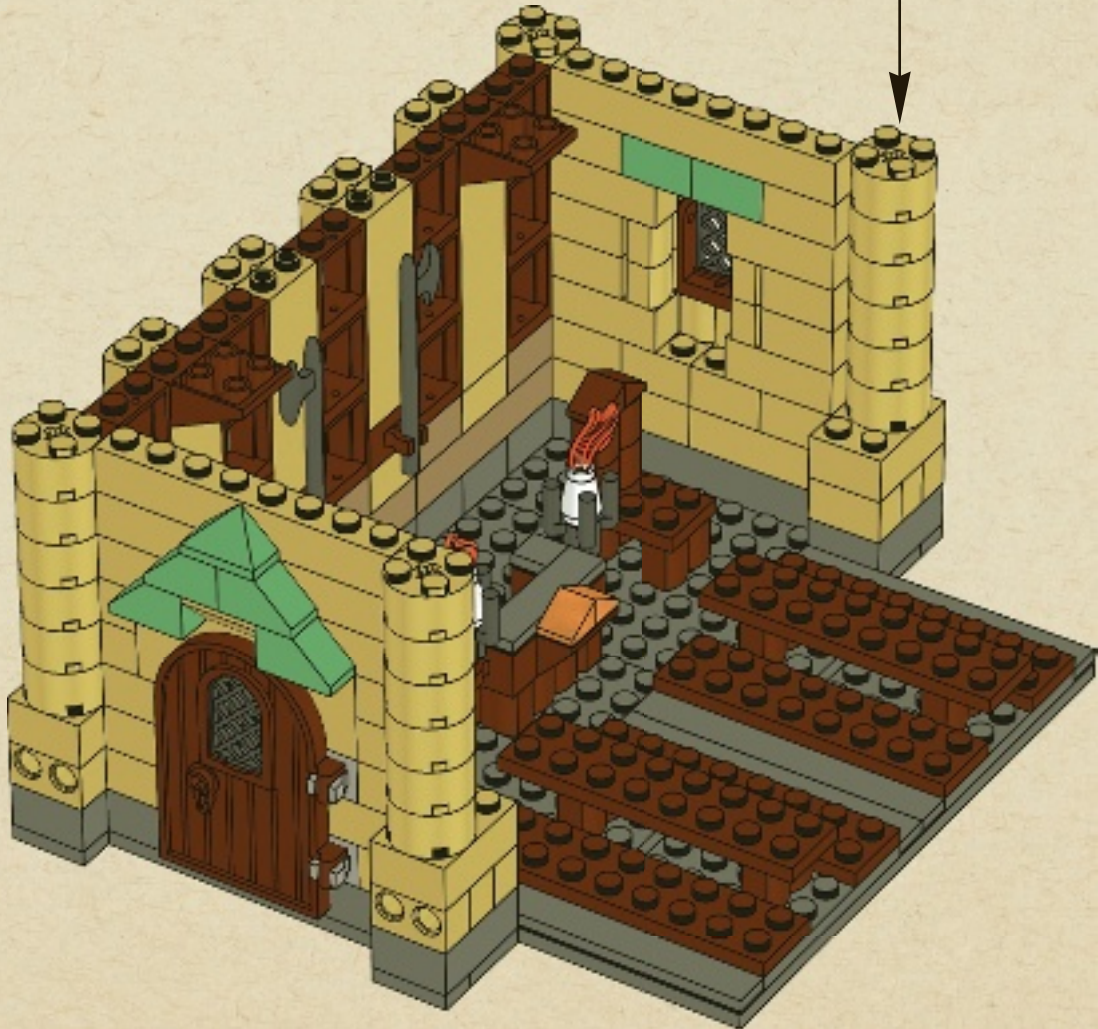
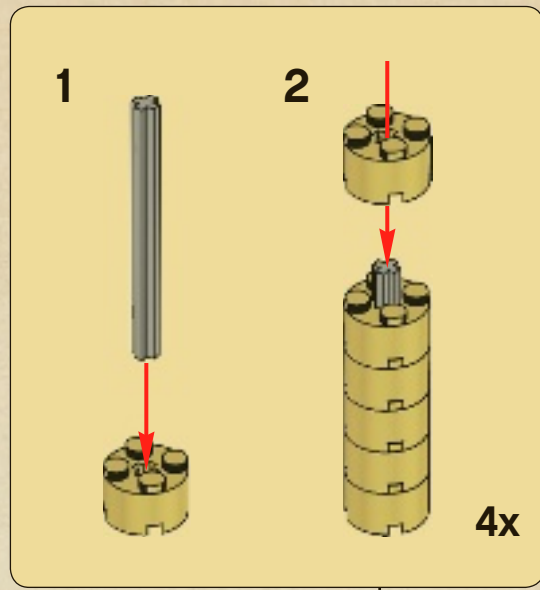





# 44

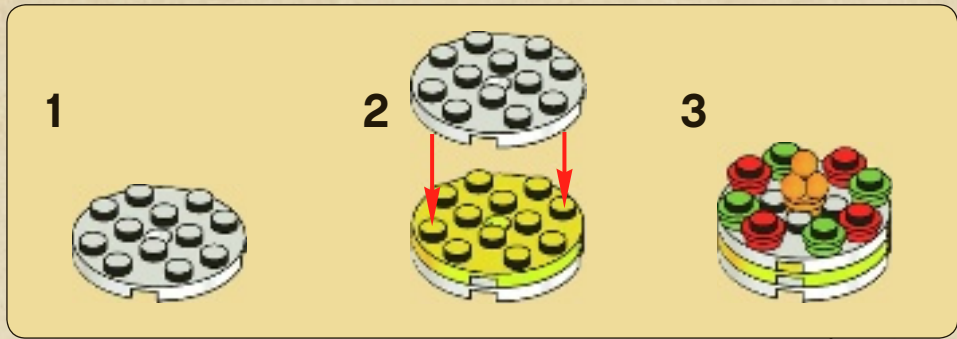



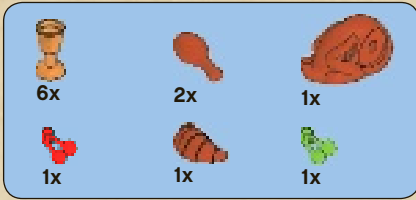

# 45

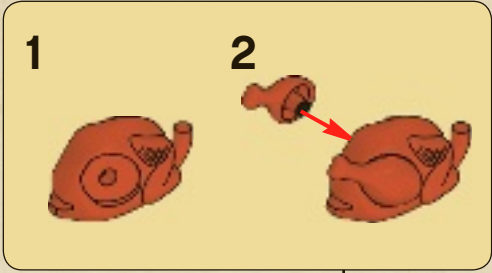



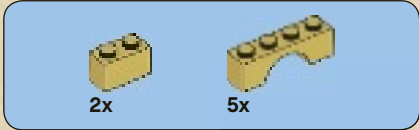

46





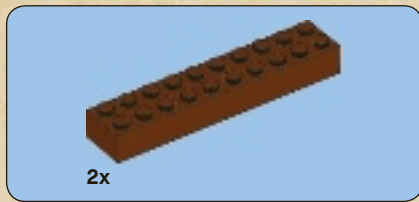

47







# 48

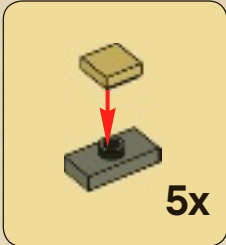





# 49

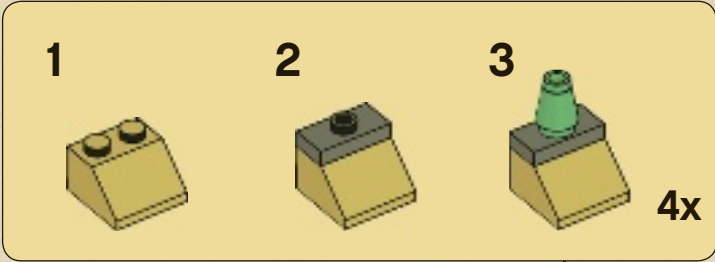





2x



2x

# 50

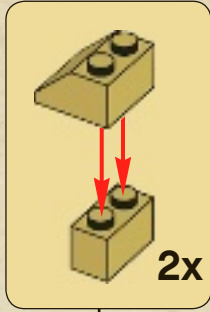



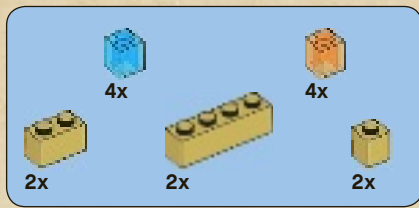

51







# 52







# 53







4x



2x



2x

# 54







2x

# 55







2x

# 56

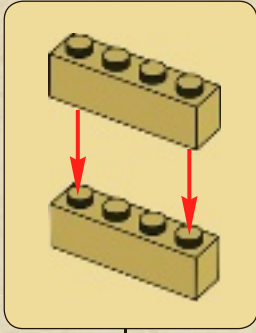



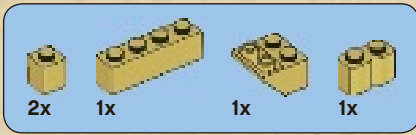

# 57

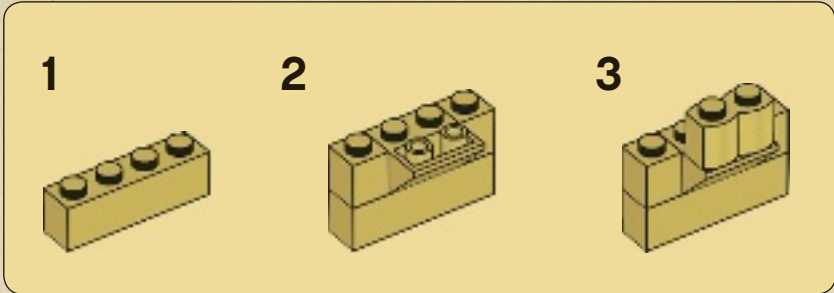



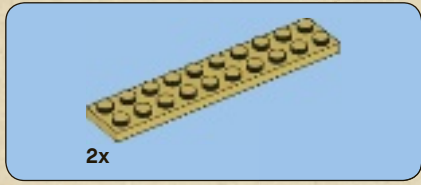

1

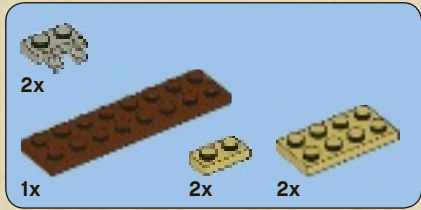
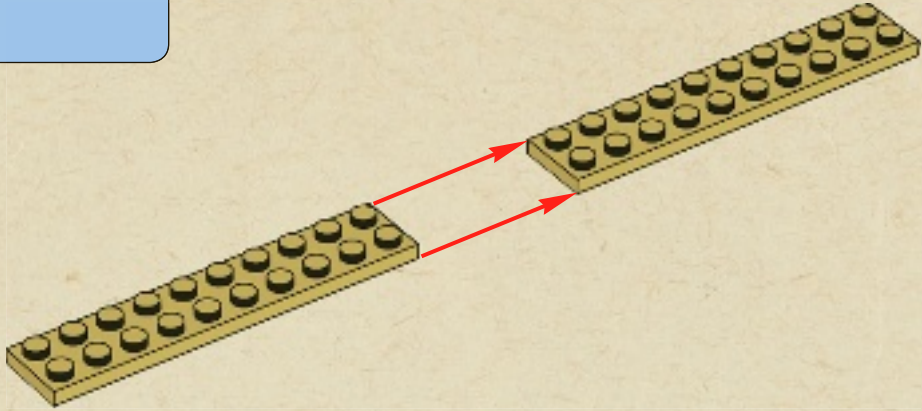

2

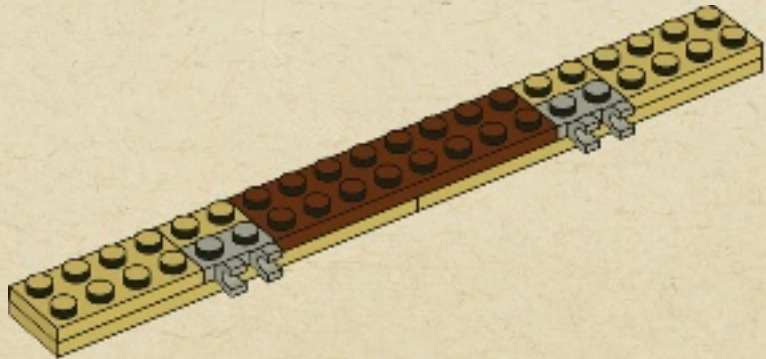



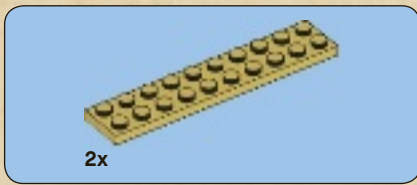

3

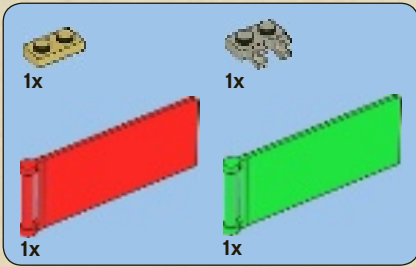
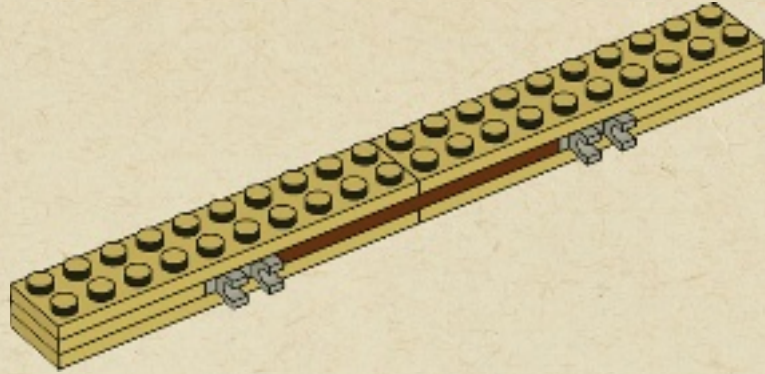

4

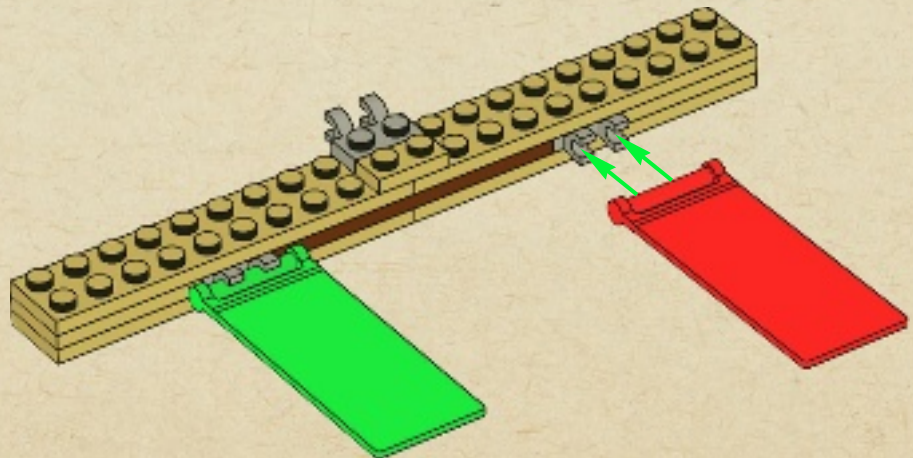



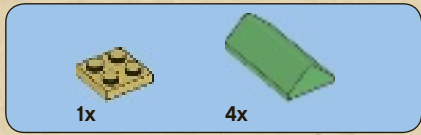

5

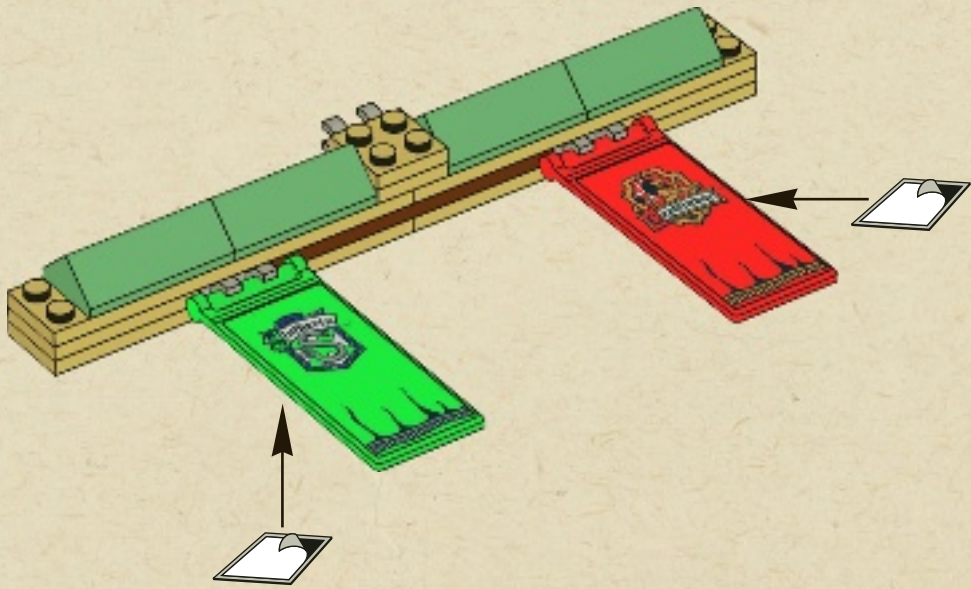



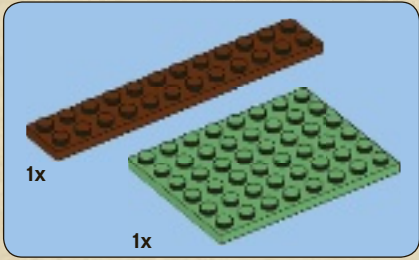
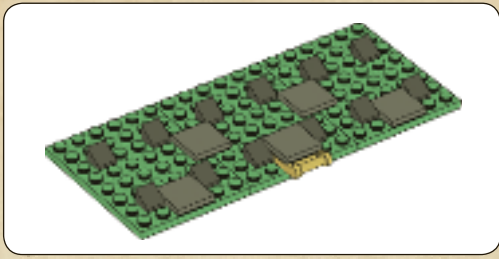

1

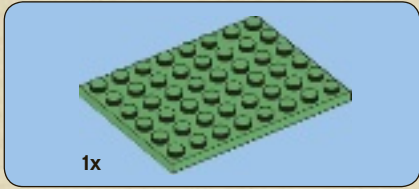
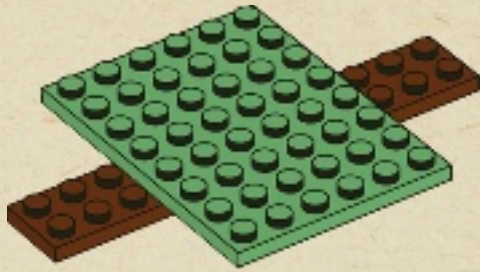

2

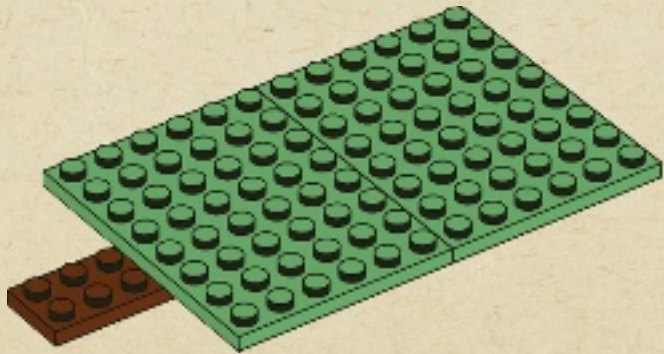



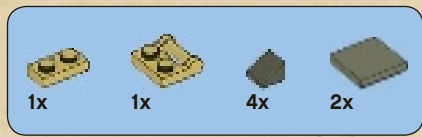

3

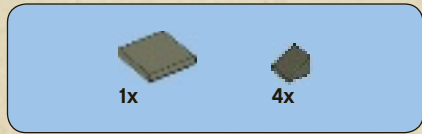
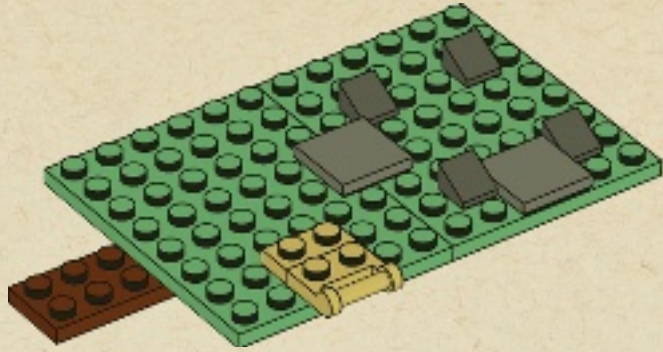

4

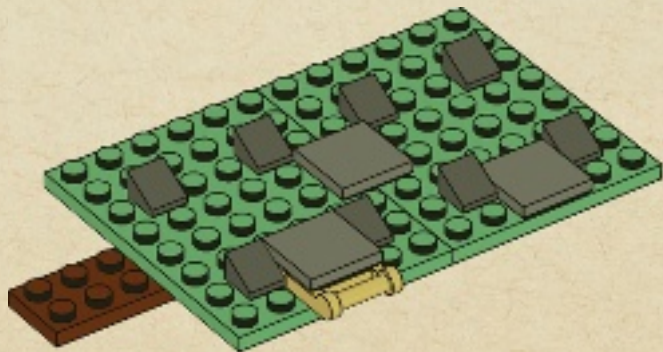



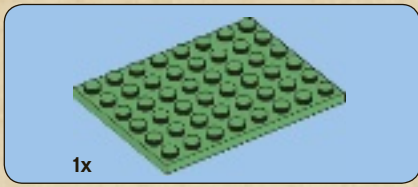

5

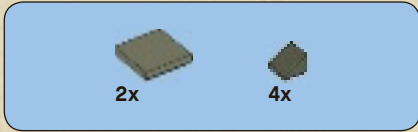
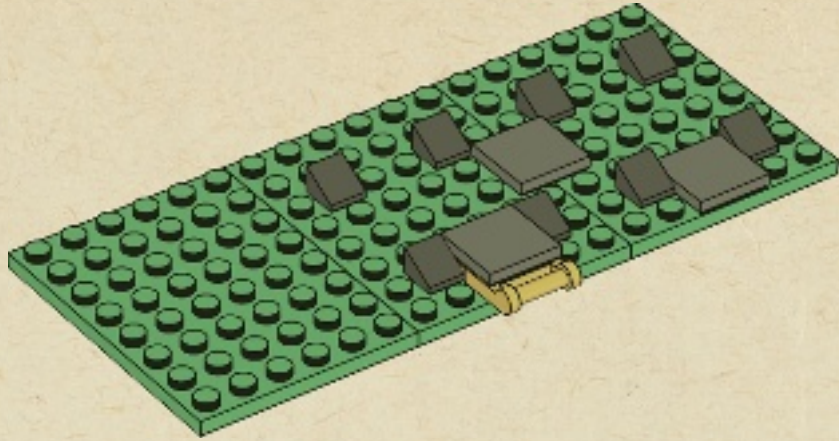

6

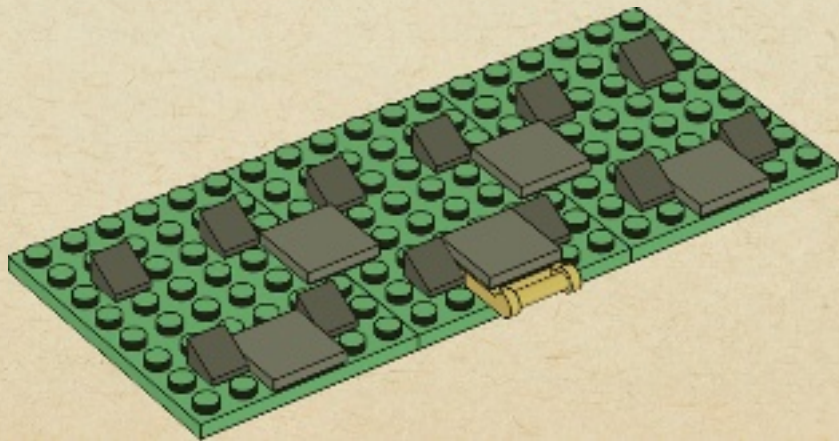



7

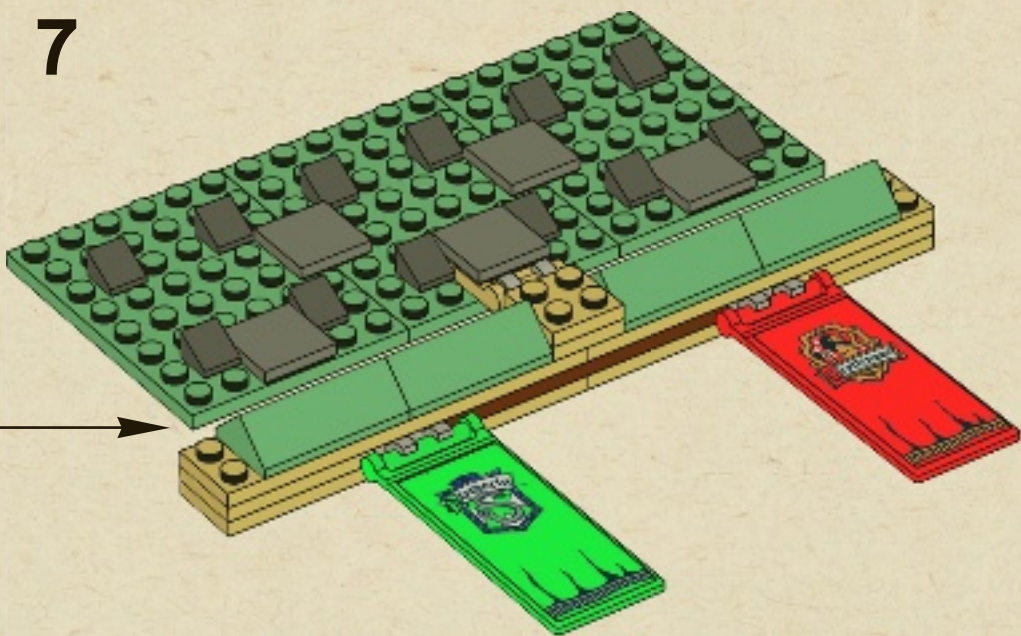



8

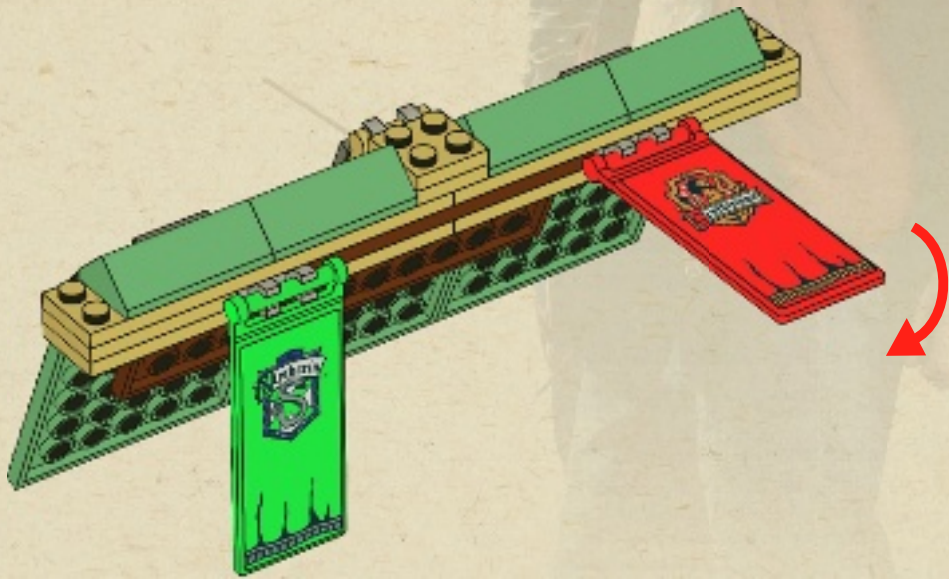



58







# 59

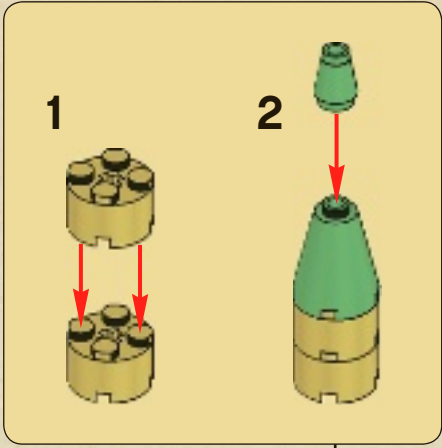



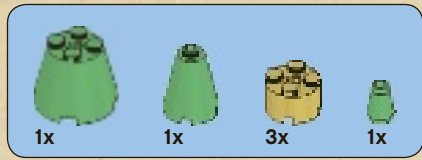

60

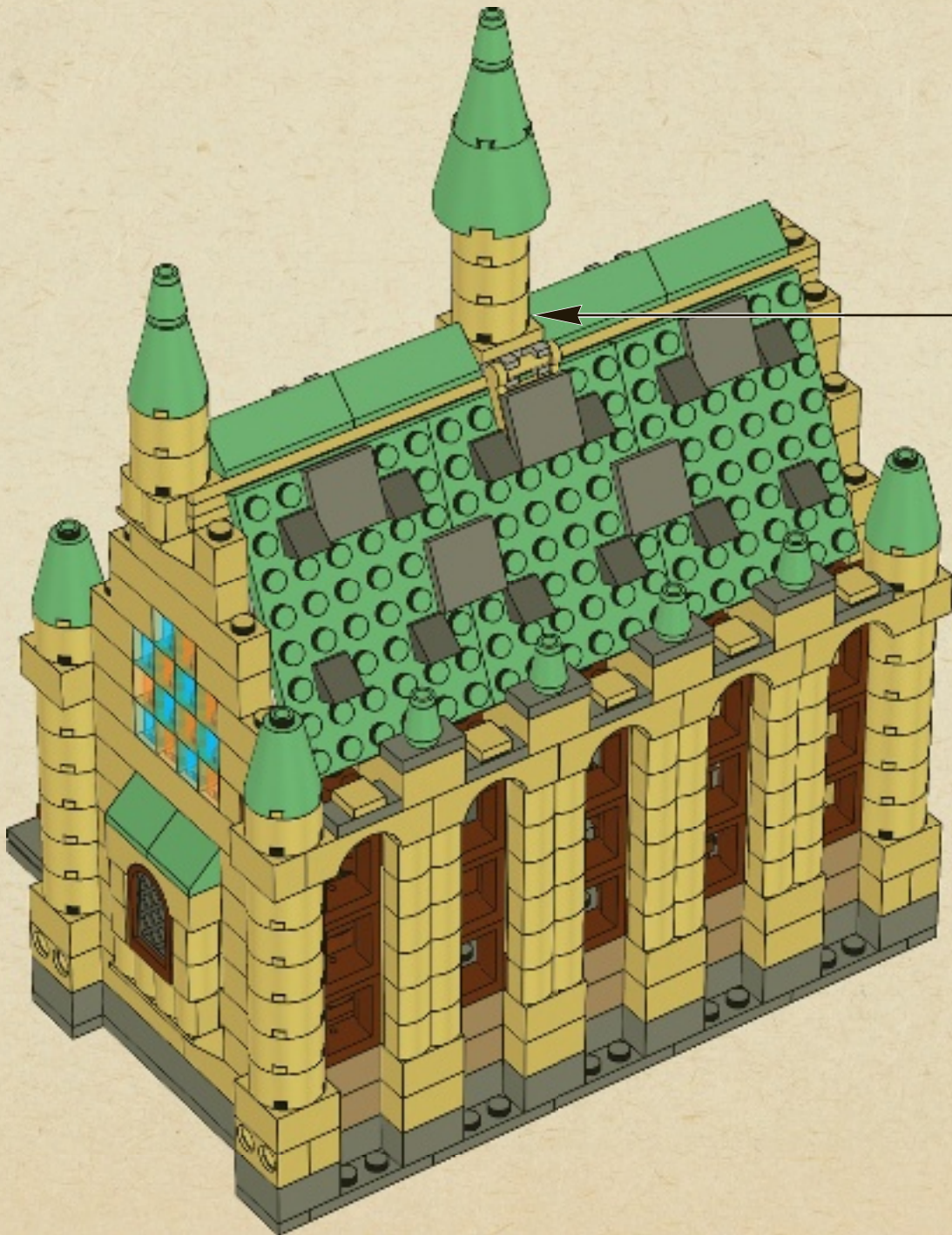
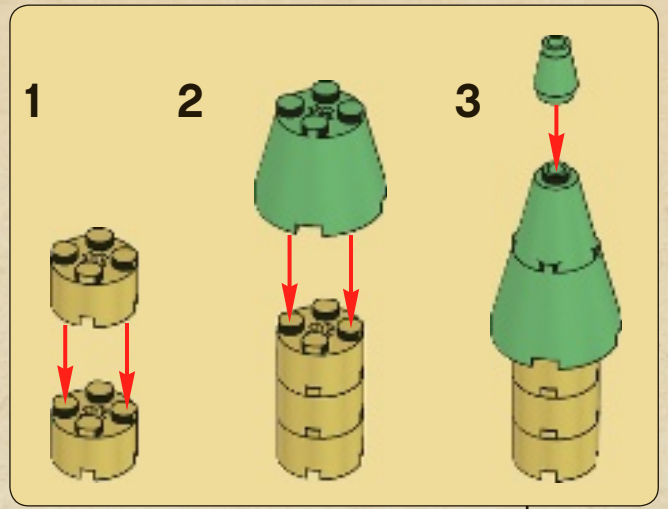





61

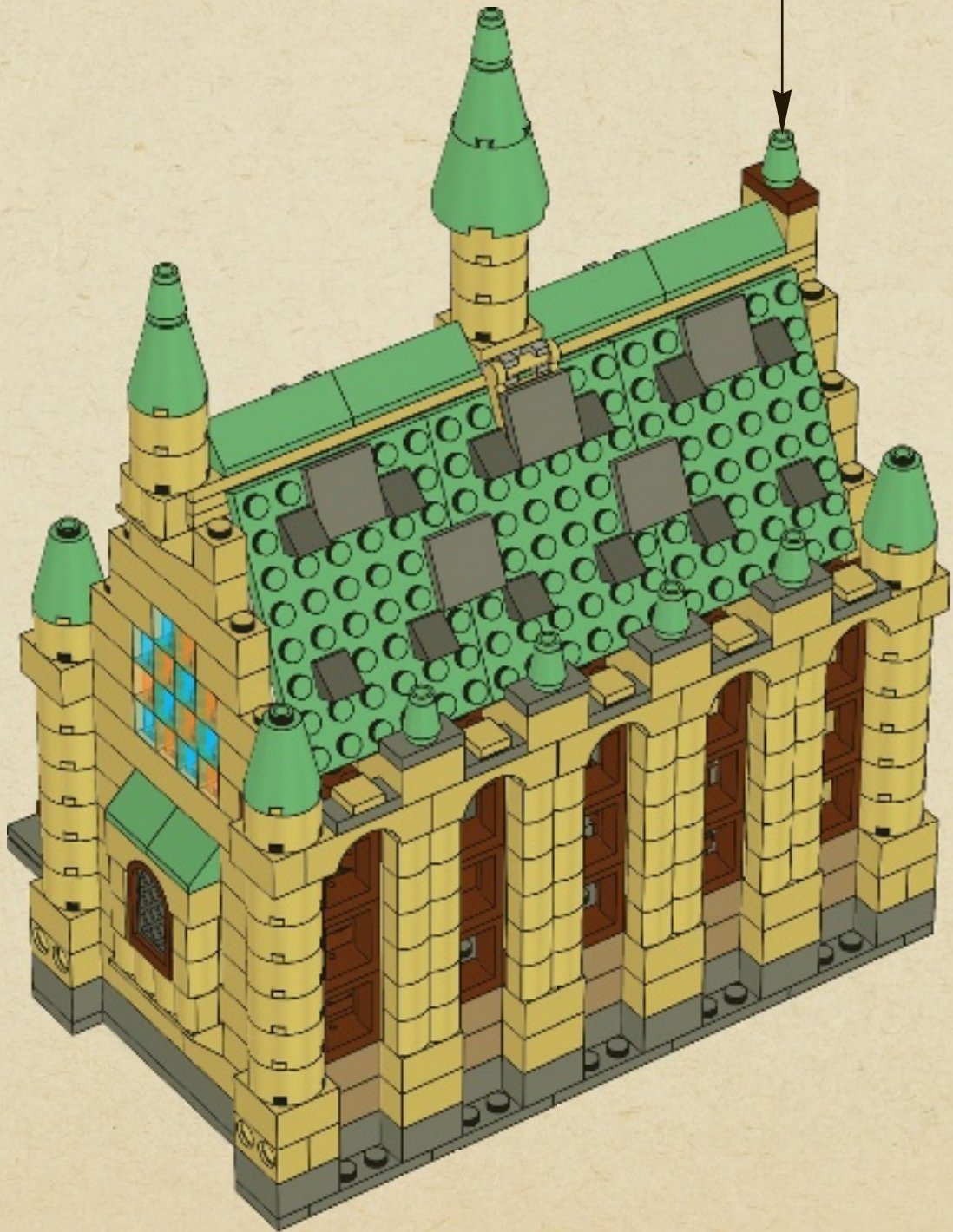
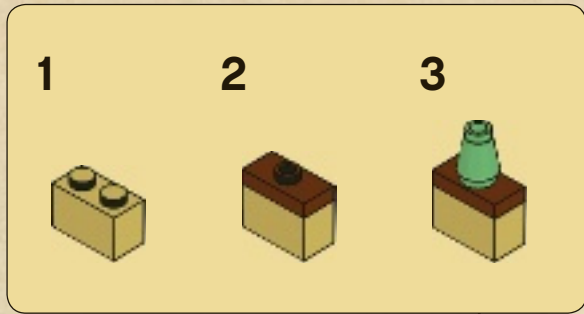





1



2

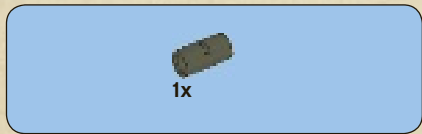

3



4

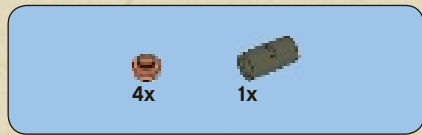
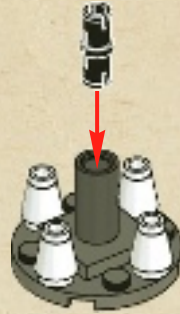

5

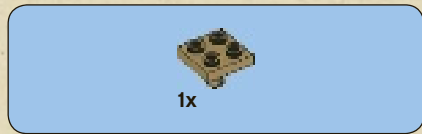

6





62





63

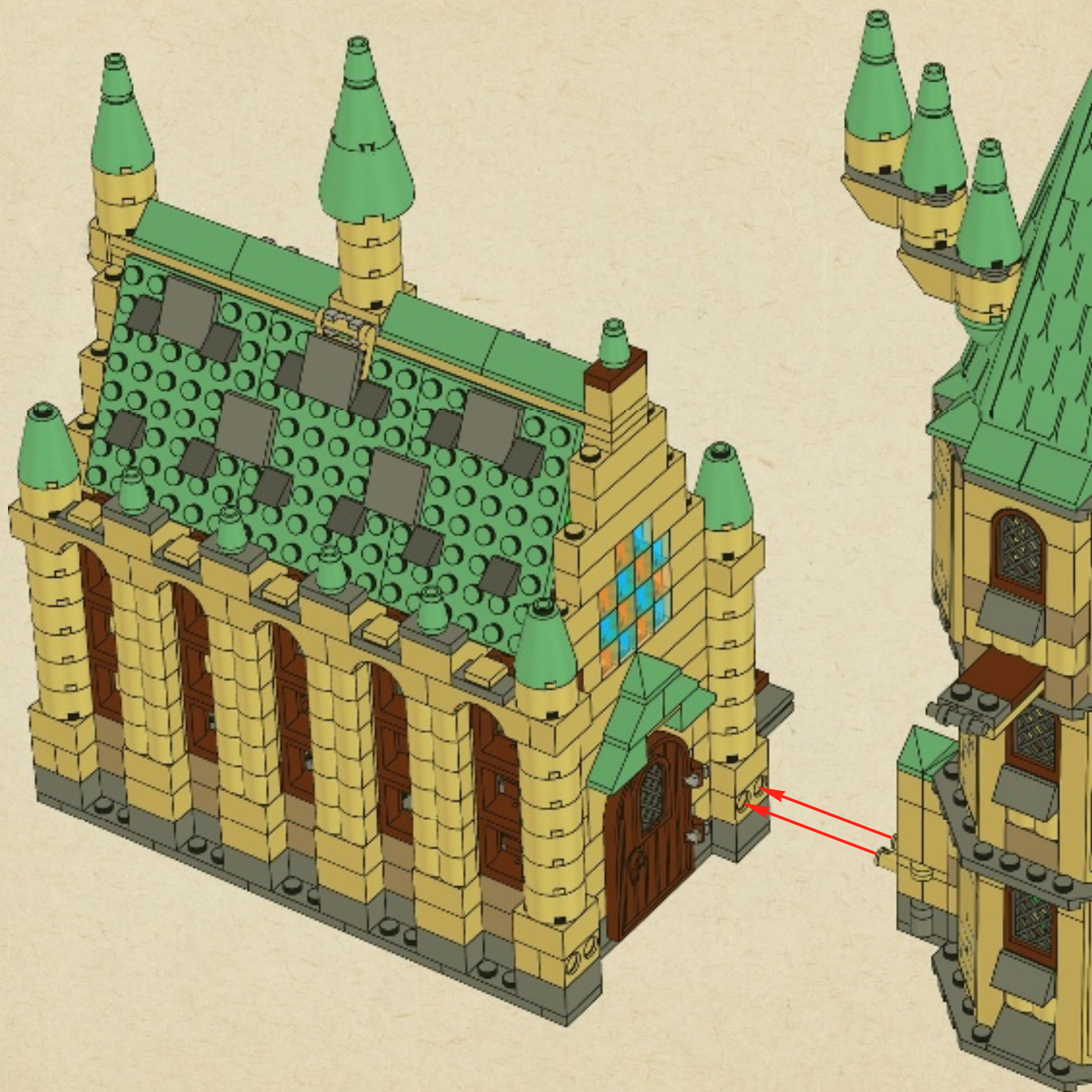







64

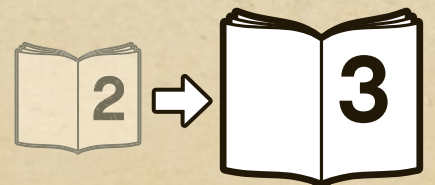





# Harry Potter™ HOGWARTS™



3862  
Harry Potter™ Hogwarts™

    
2-4 8+ 20-40







# Harry Potter







# ATLANTIS



8078



8077



8076



**FREE! GRATIS! GRATUIT!**



**club**  
MAGAZINE™

**www.LEGOclub.com**



**00800 5346 5555\***

**1-866-534-6258 • 1-877-518-5346**

US & Canada only

Canada seulement

\* FreePhone. Mobile charges may apply. \* Numéro sans Frais. Des Frais peuvent s'appliquer avec les téléphones cellulaires. \* Gebührenfrei, Kosten für Anrufe aus Mobilfunknetzen können abweichen. \* Gratis telefoonnummer vanaf vaste lijn. \* Deel of eets gratis nummer, niet du ringen Fro PostTelefon. \* Deel of gratis, niet du ringen Friin en Post telefon.



**VISIT THE WORLD'S  
BIGGEST LEGO® SHOP!**

**www.LEGOshop.com**



**www.LEGO.com**





# Harry Potter



4842





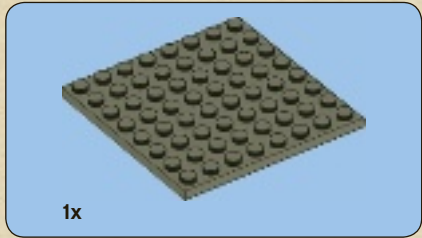
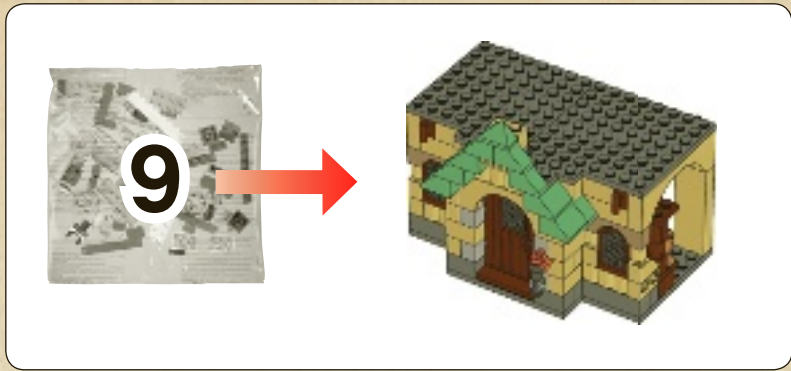

1

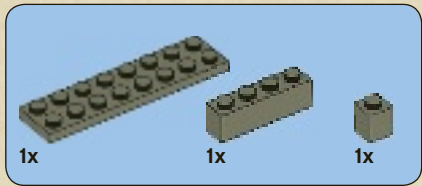
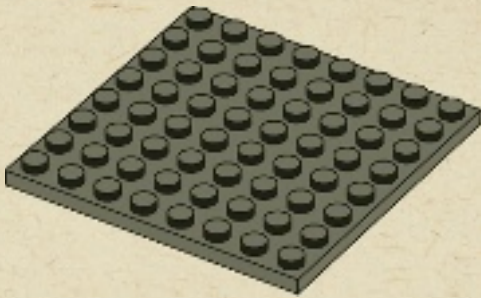

2

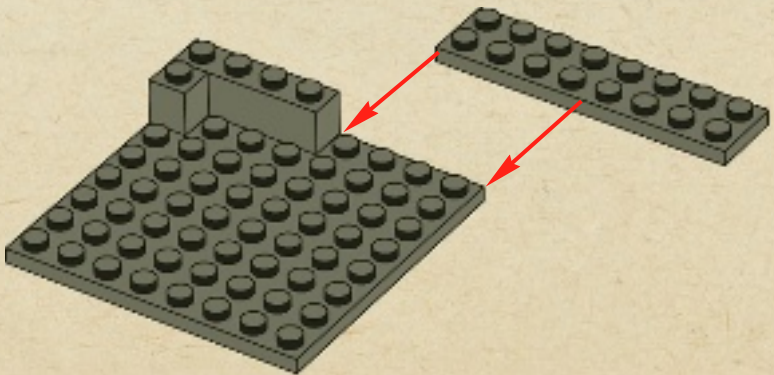



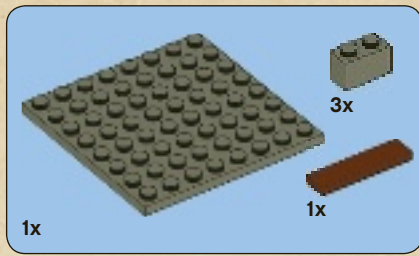

3

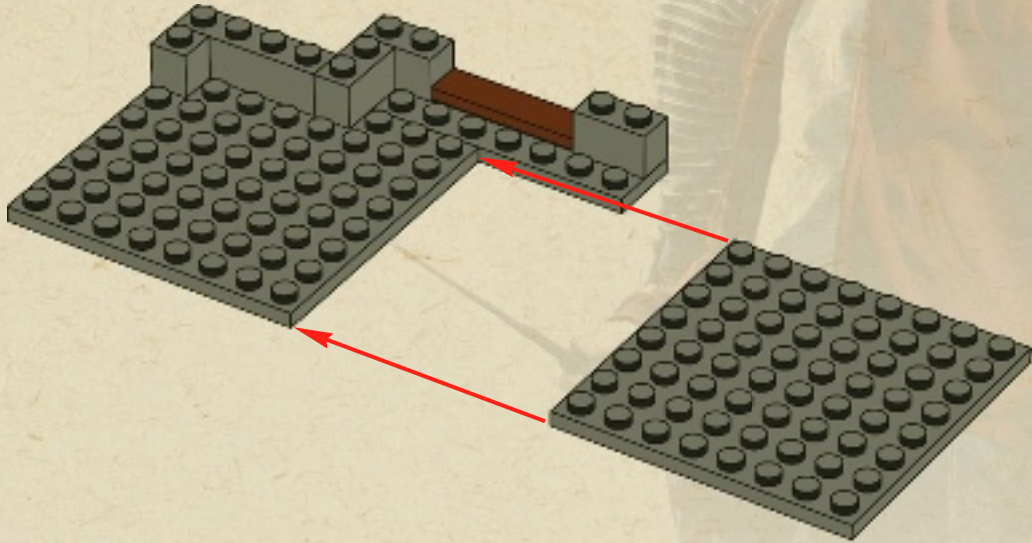

4

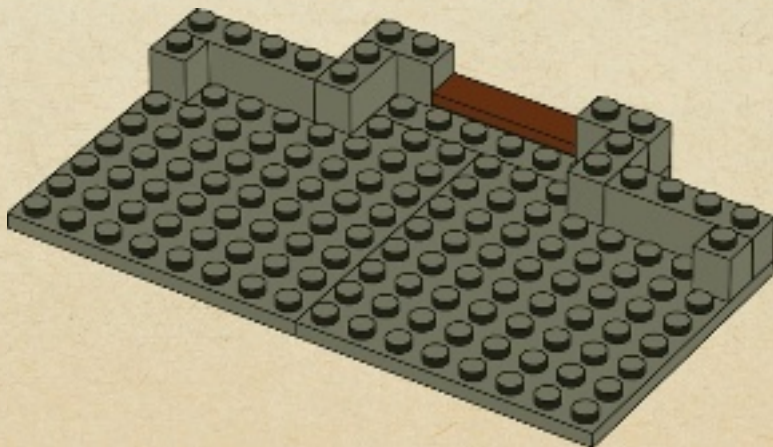





2x

# 5

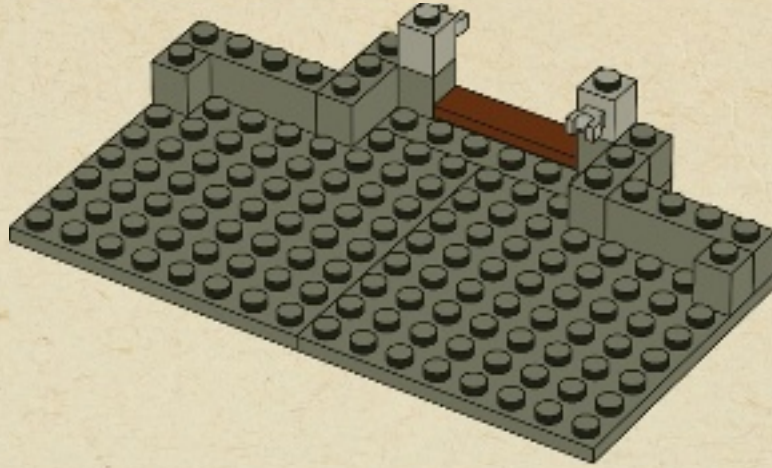

2x



2x



2x

# 6

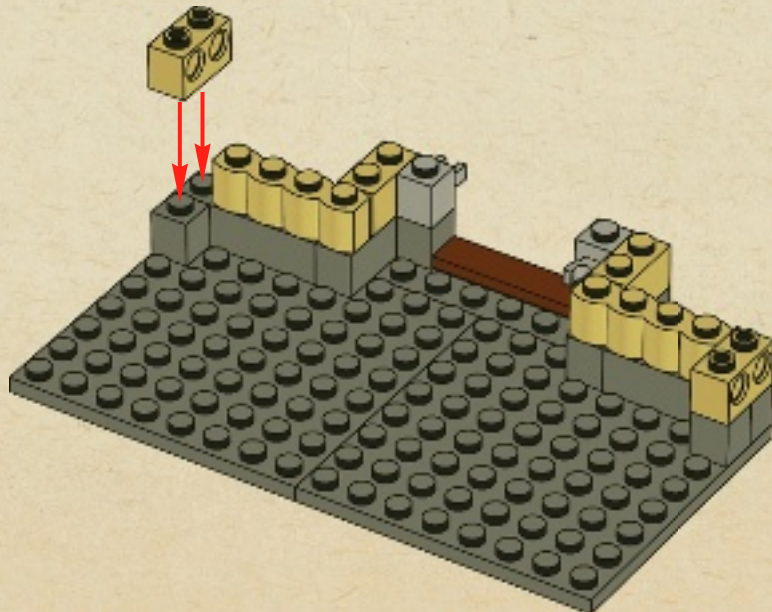



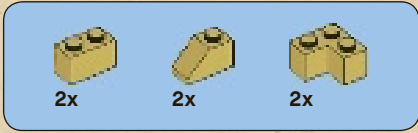

7

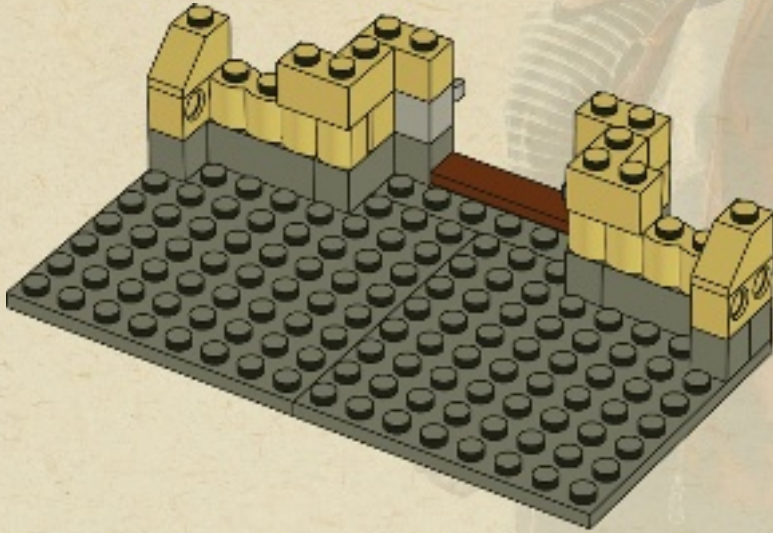

8

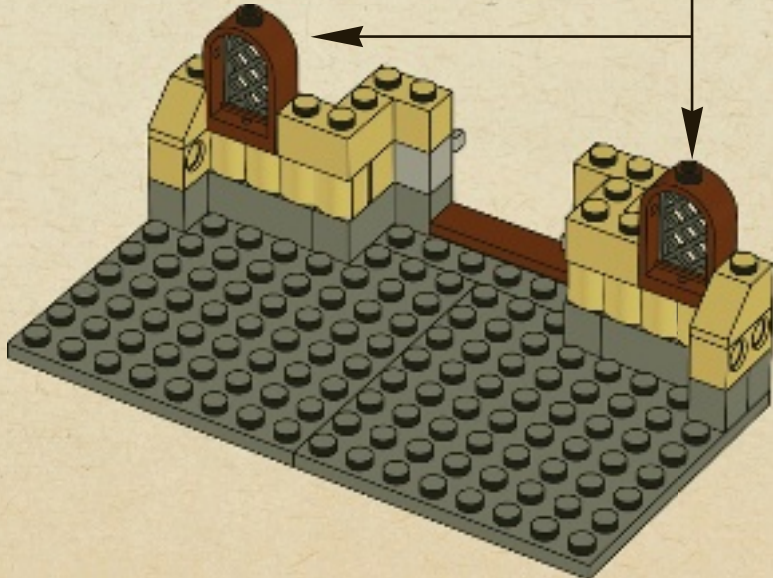





2x

# 9

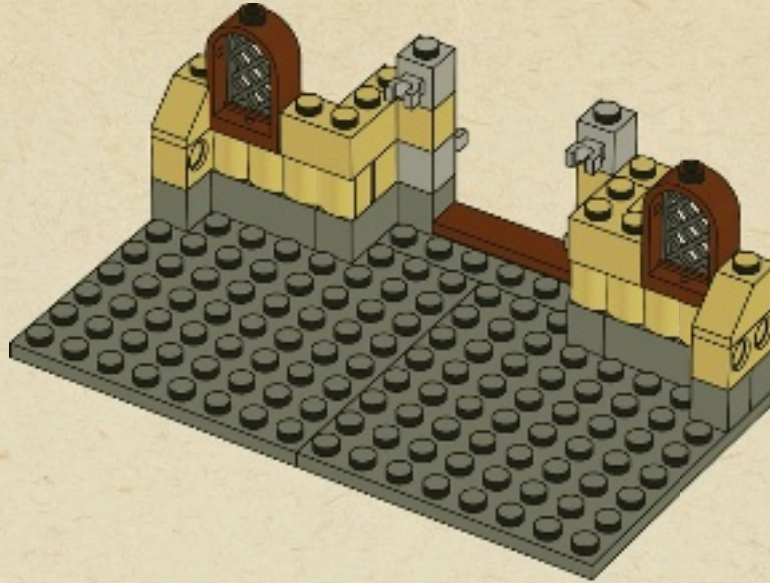

4x



2x

# 10

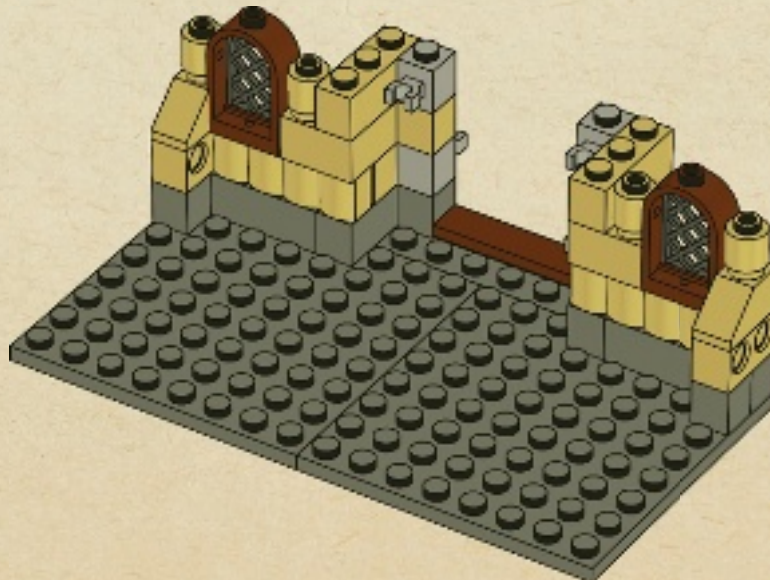



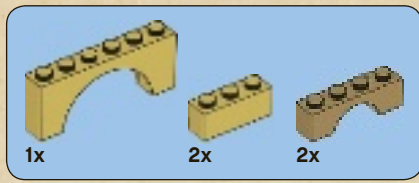

11

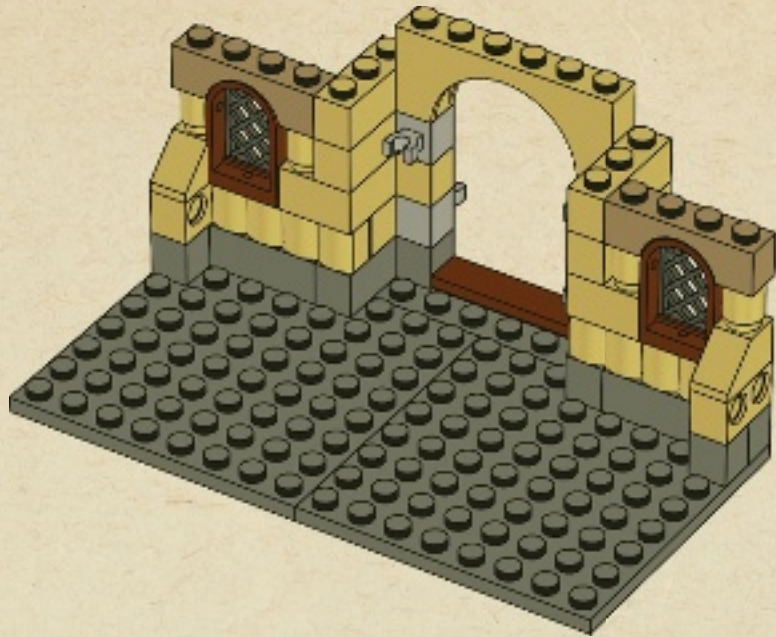

12







13

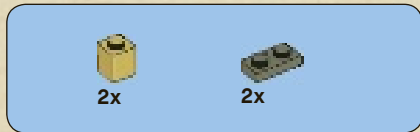

14

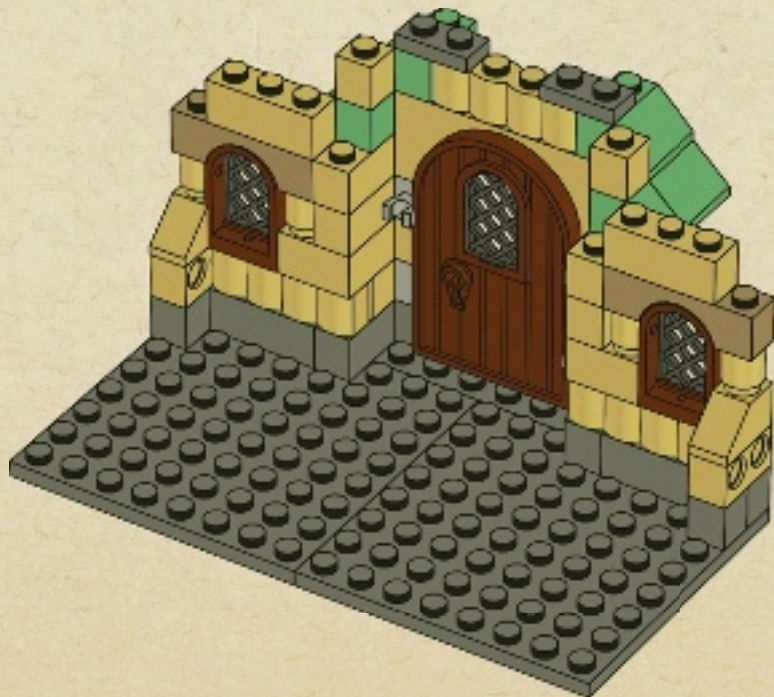



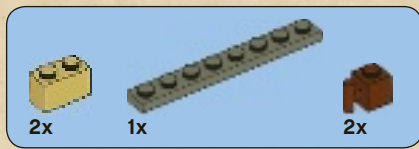

15

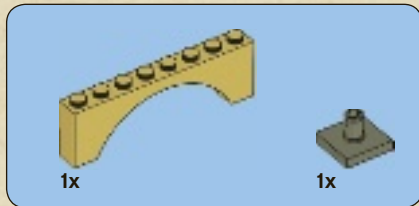
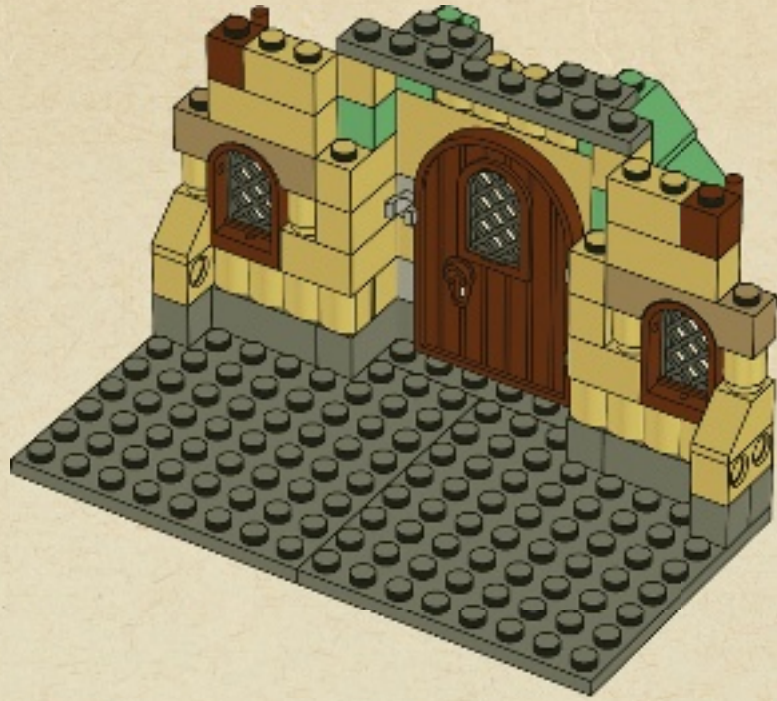

16







1x

1



2x

2

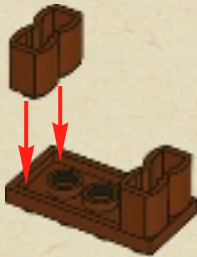

1x

3



2x



2x

4



1x



1x

5

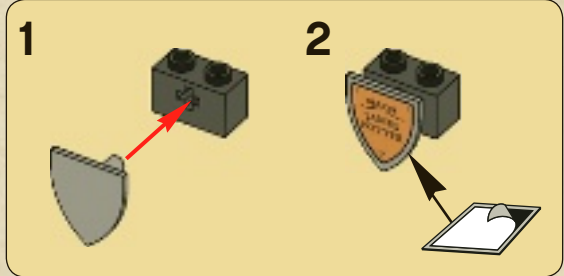



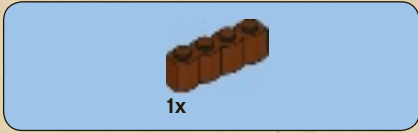

6

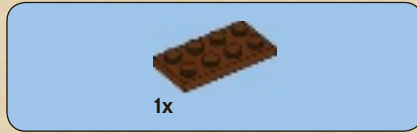

7



17

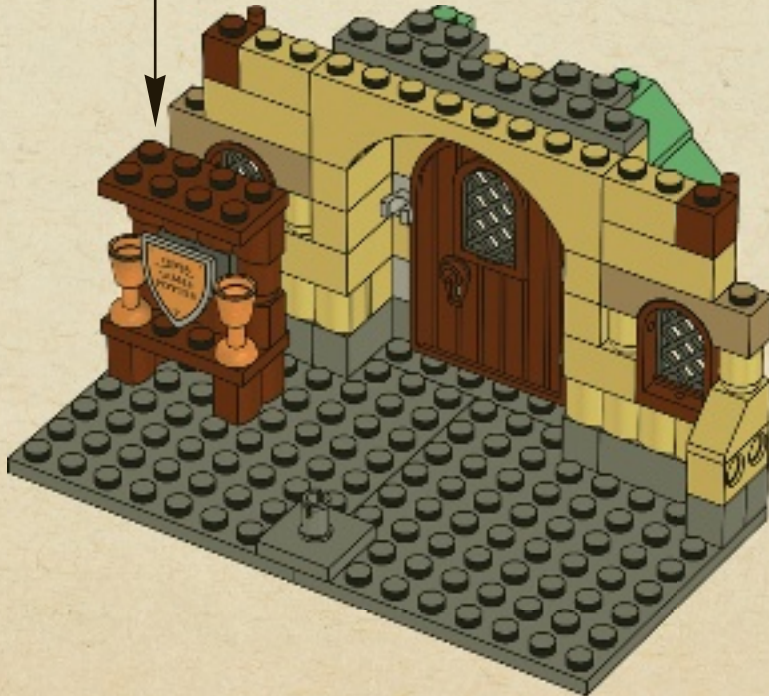



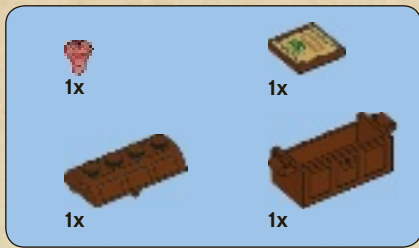

# 18





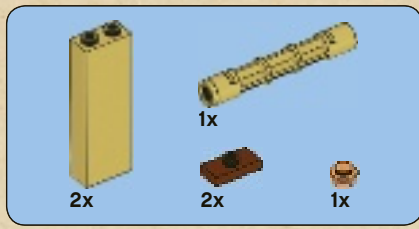

19

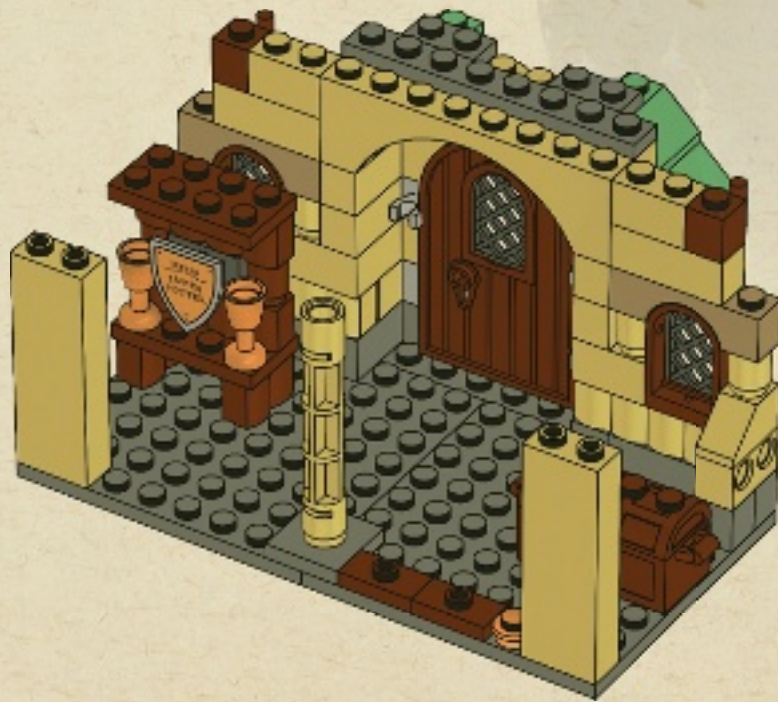



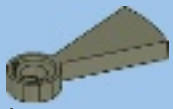

1x

20

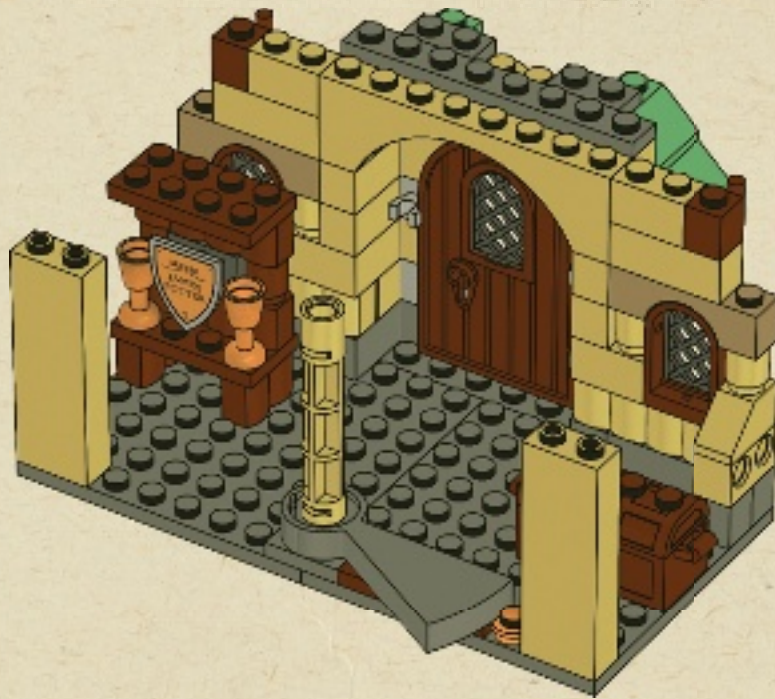



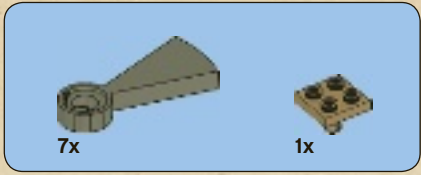

# 21

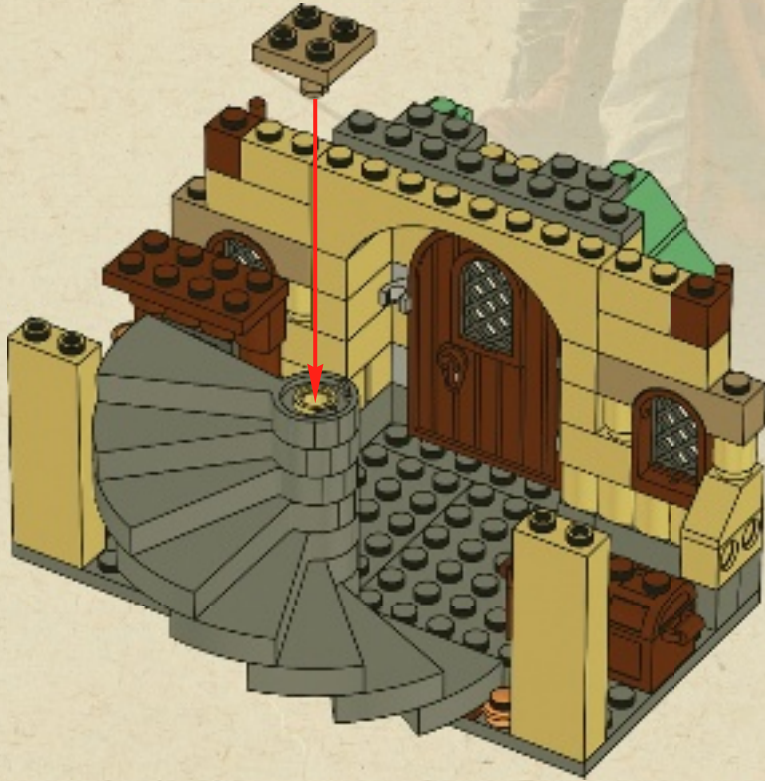



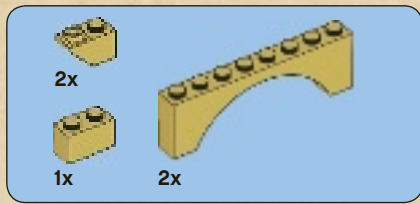

22

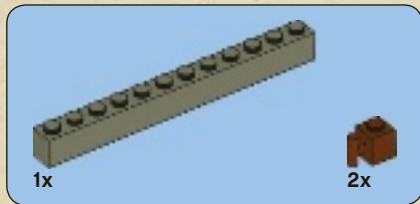
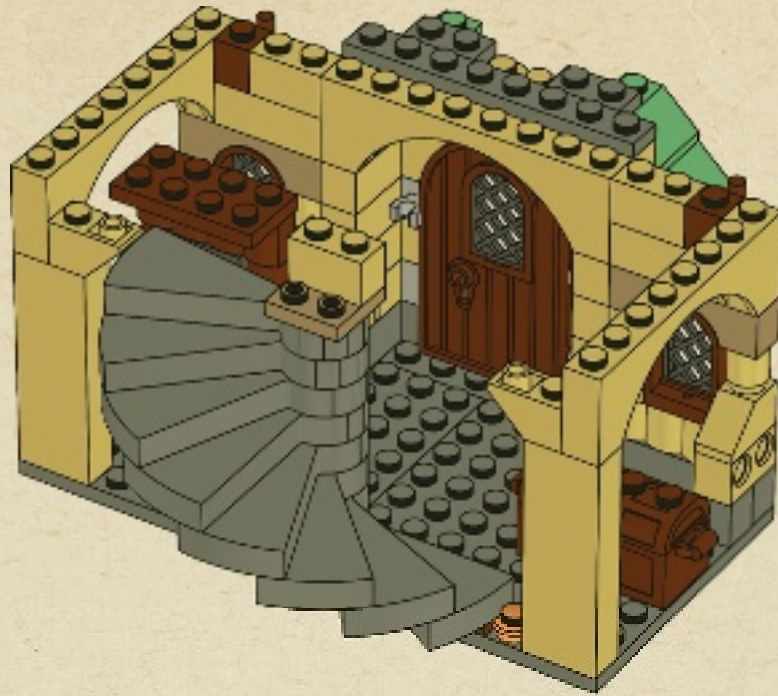

23

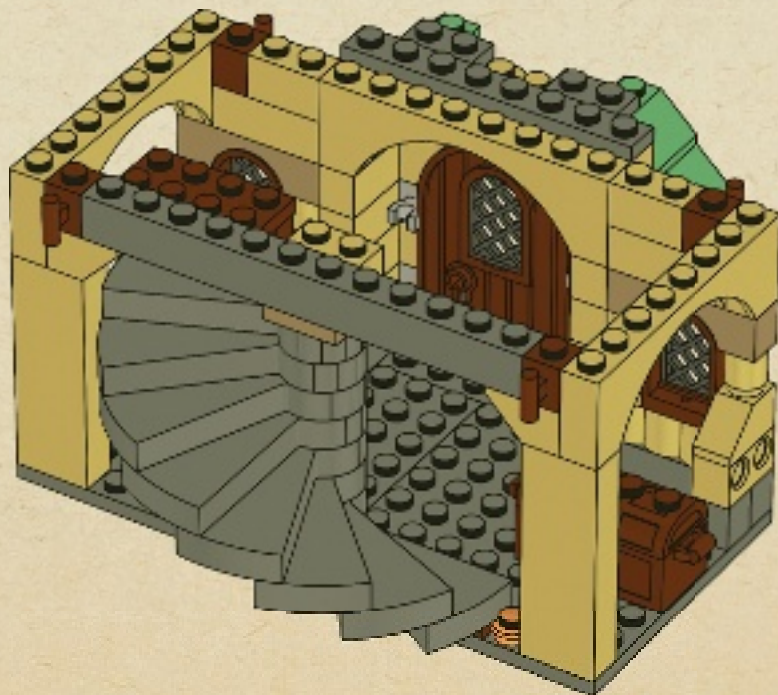



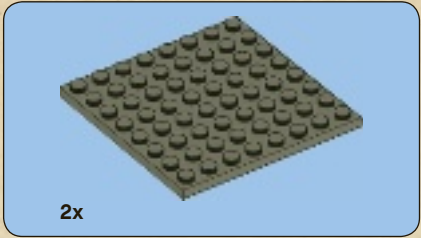

24

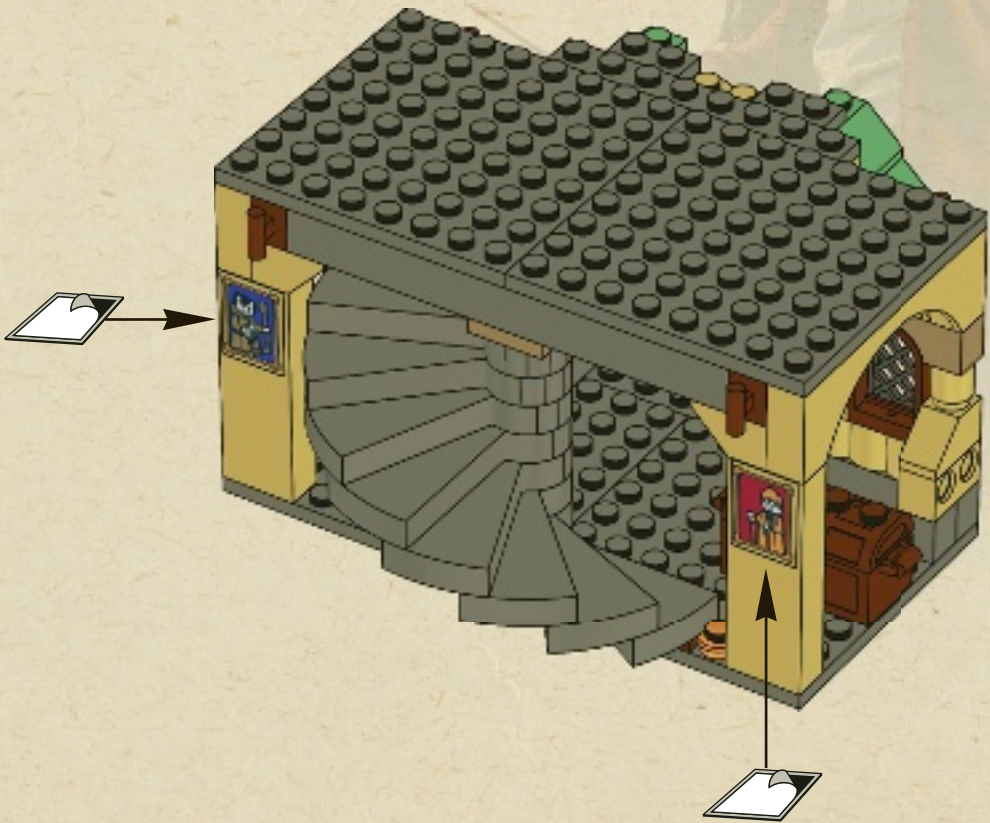





# 25

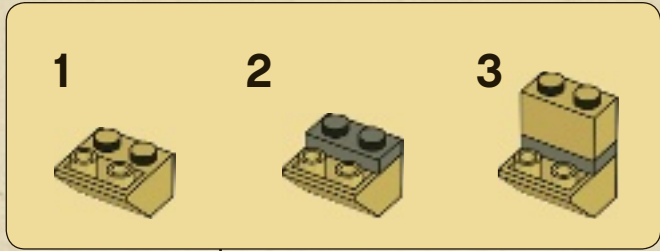





2x

# 26

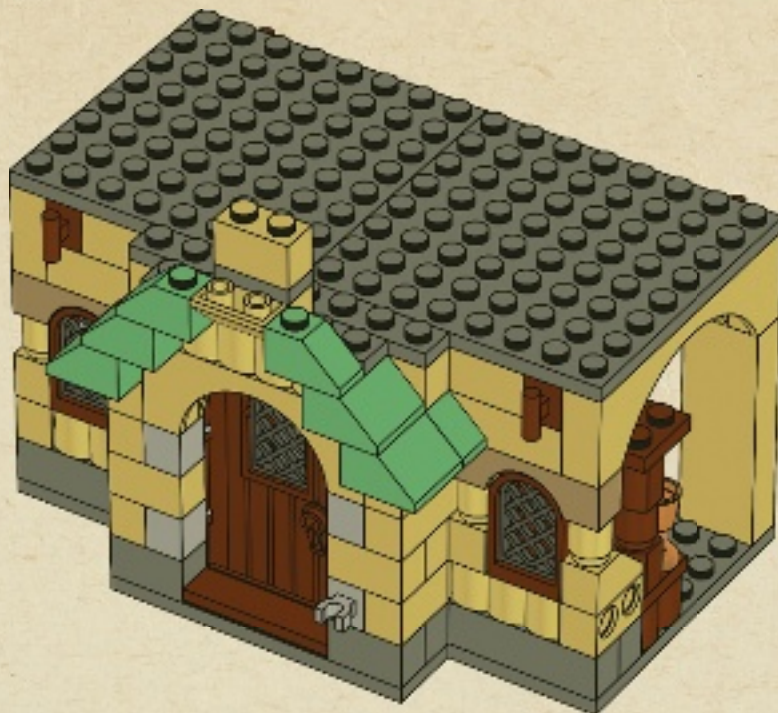

2x

# 27







1x

# 28



1x



1x

# 29

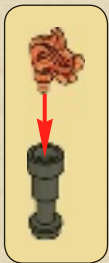
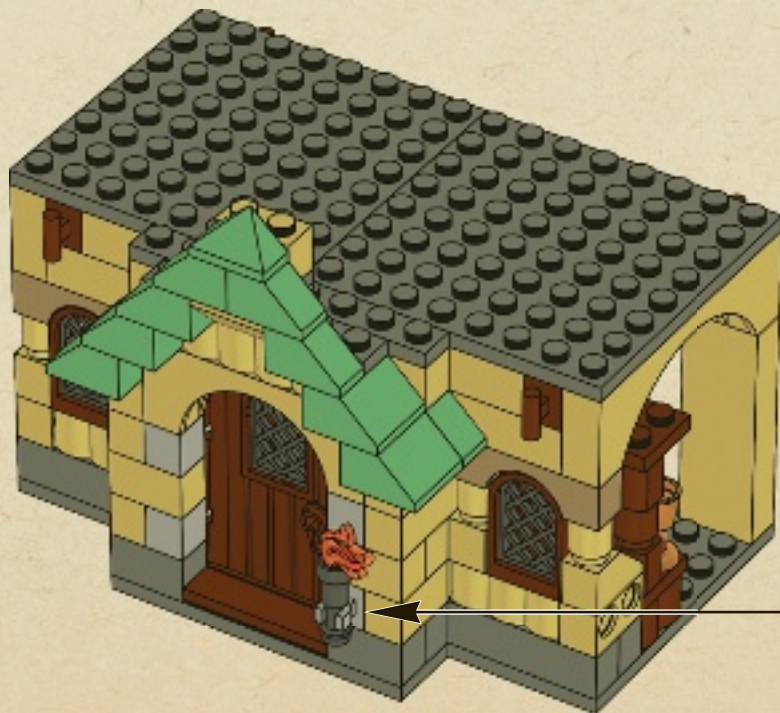



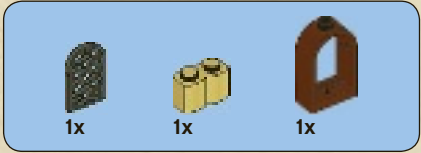
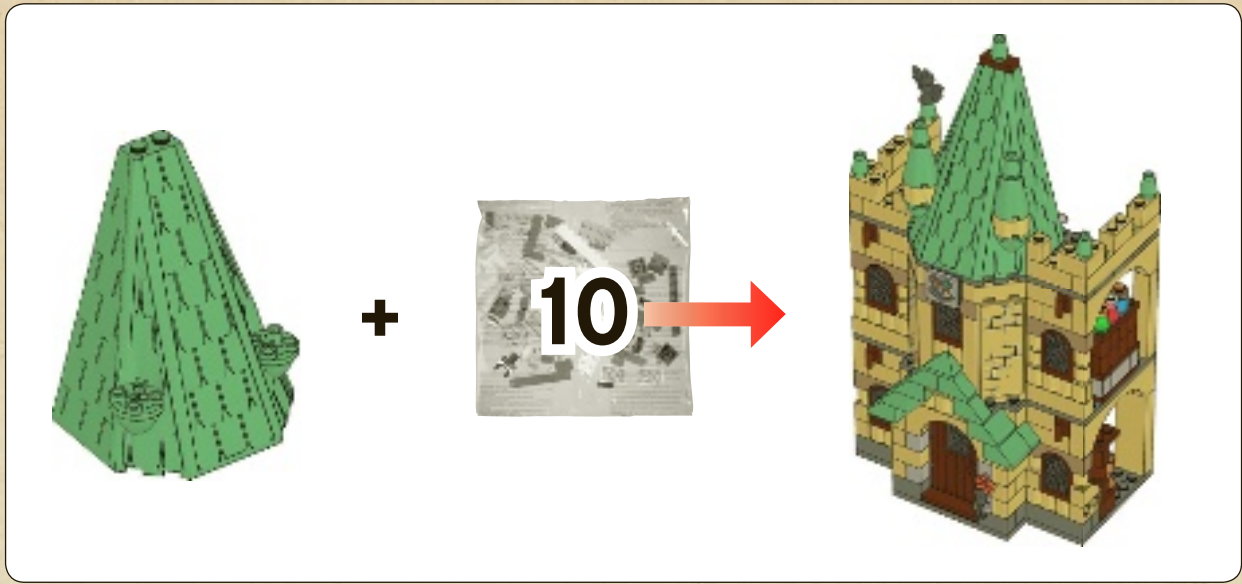

30





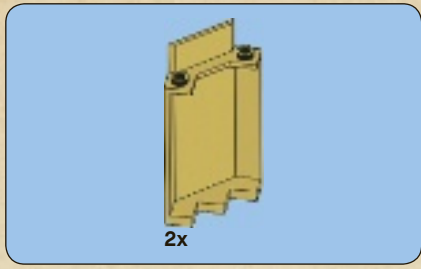

# 31

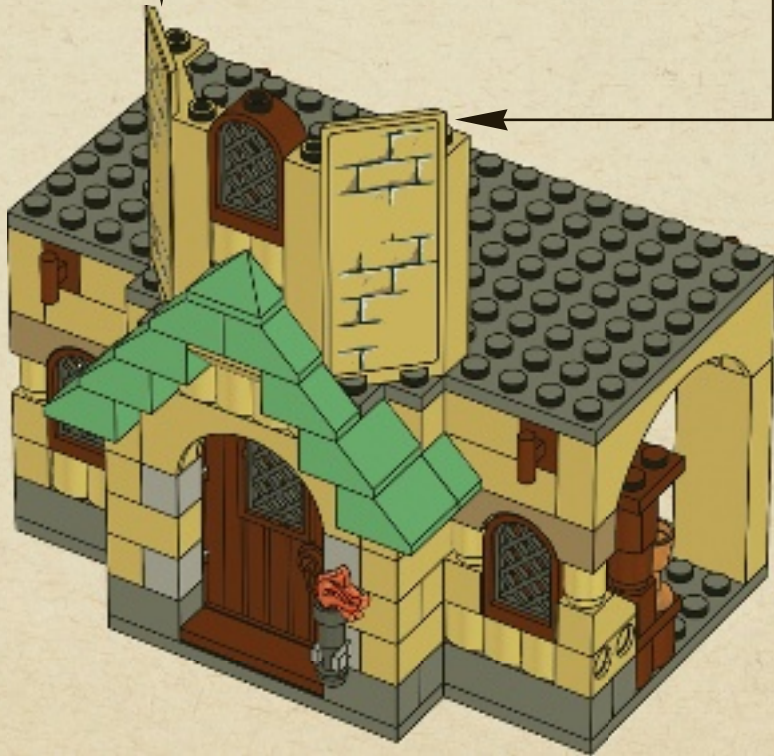
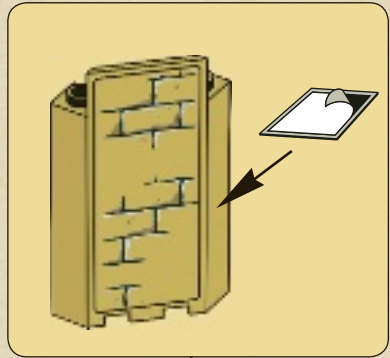
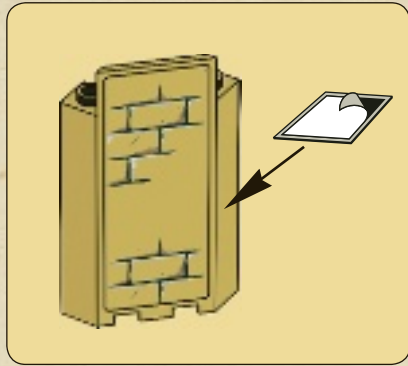



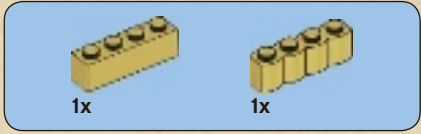

1

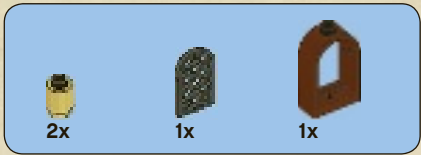
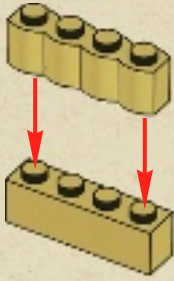

2



3

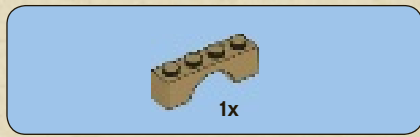

4



2x



32







# 33

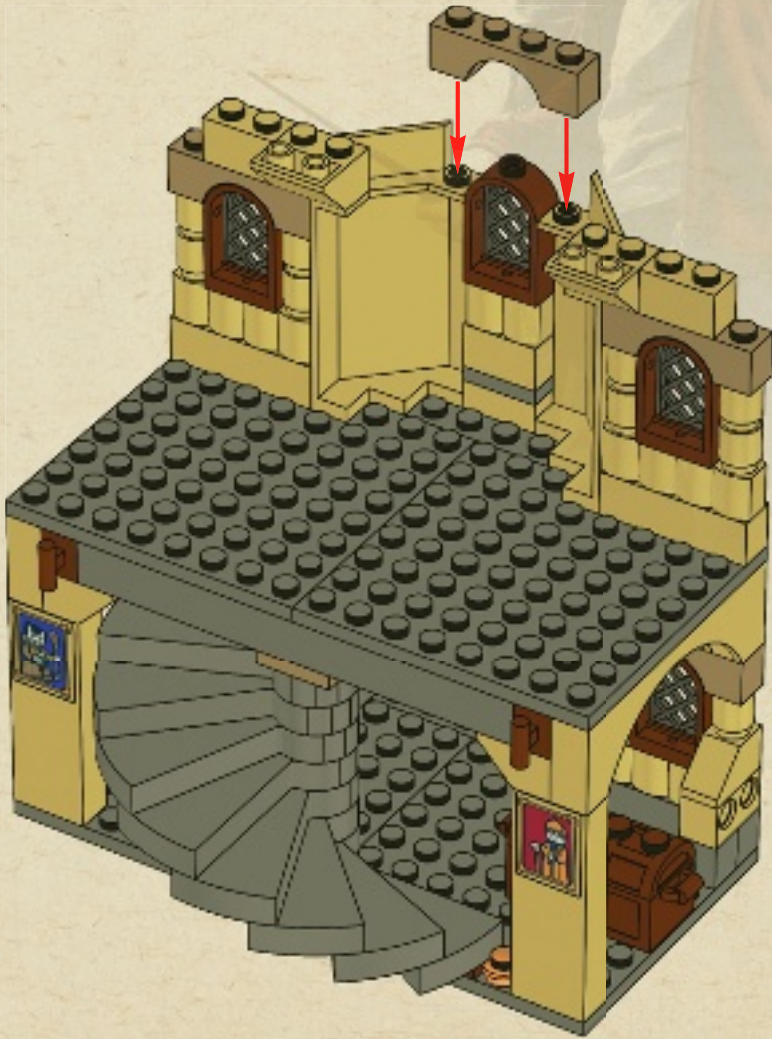





# 34

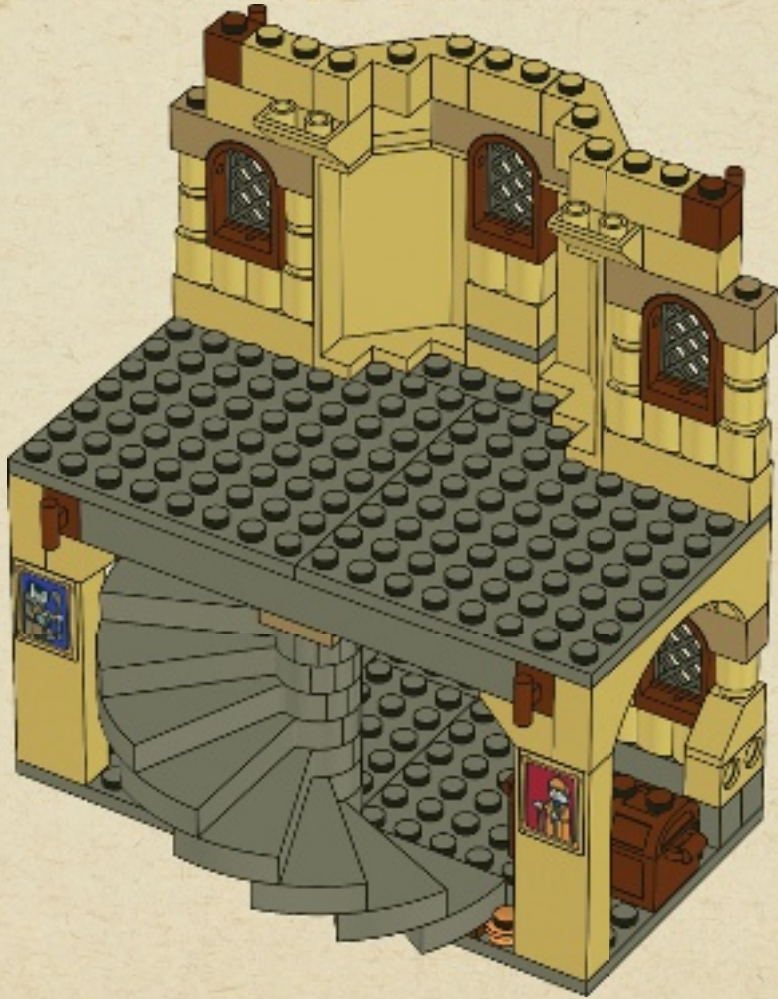





1x



1x

# 35

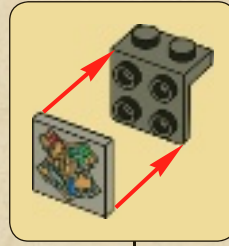





1

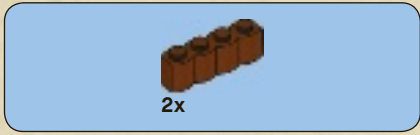

2



3



4





1x 2x

5



2x

6



36





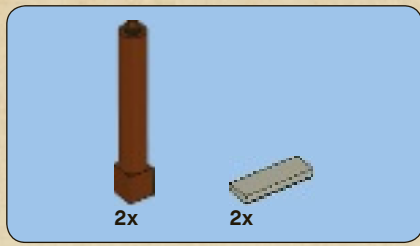

37







2x

38







1

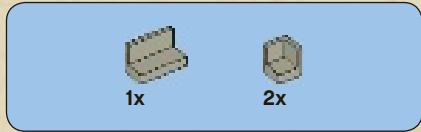

2

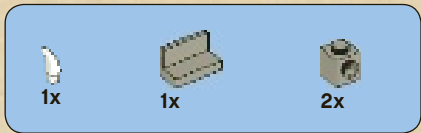
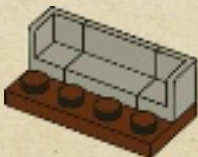

3

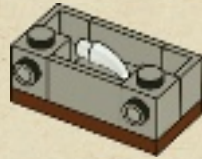

4





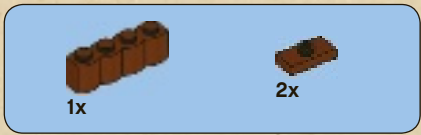

5



6



7



8







1x



1x

9



39

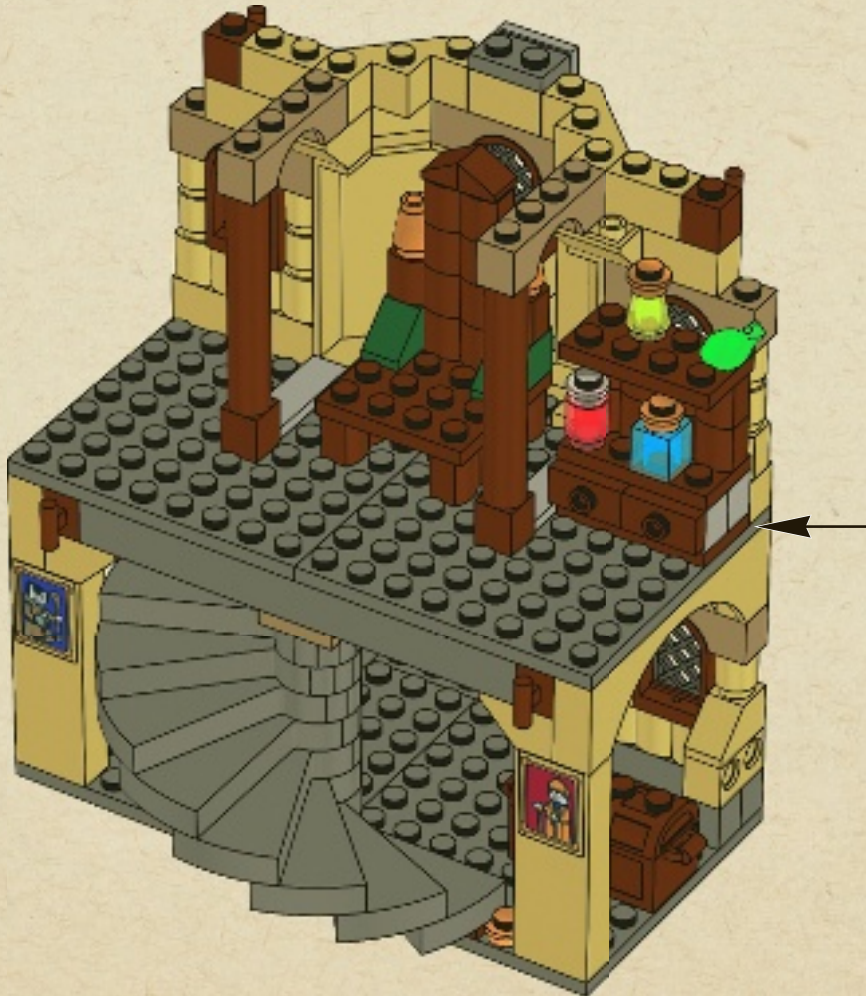





1

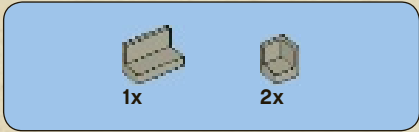

2

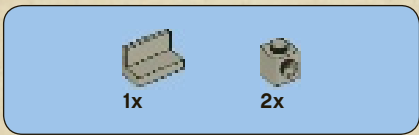
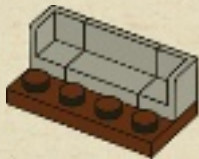

3

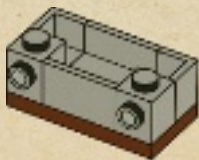

4



5

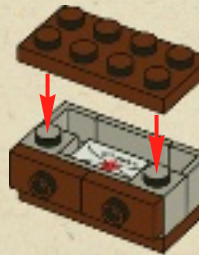

6







7



8



9



10





40





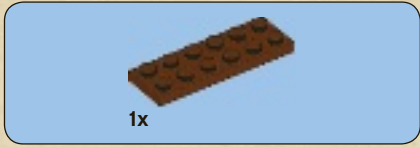

1



2

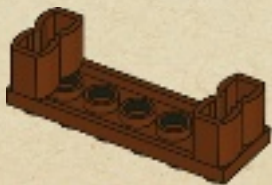

3



4







1x



1x

5



41







2x

42





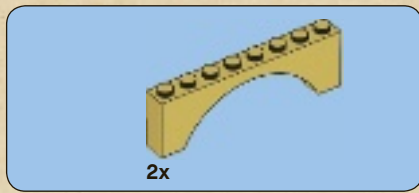

43







44





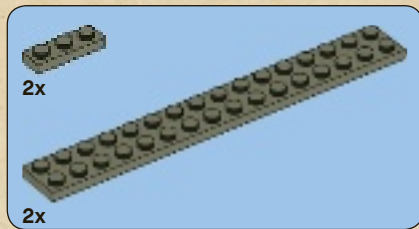

45





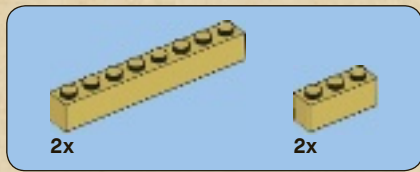

# 46







47







48







1x



4x

# 49





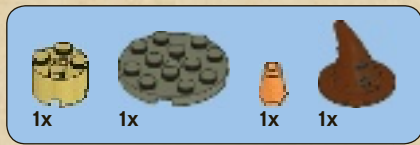

# 50

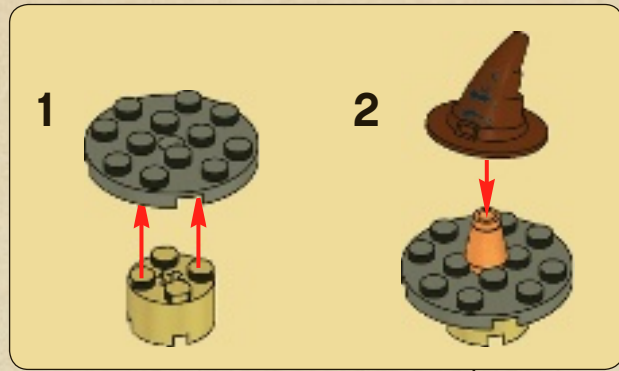



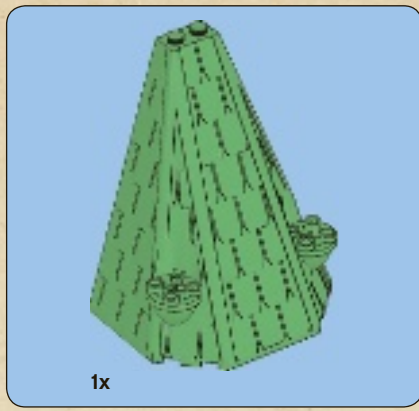

51





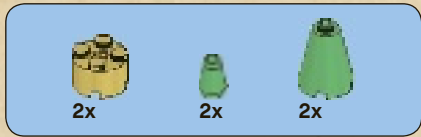

# 52

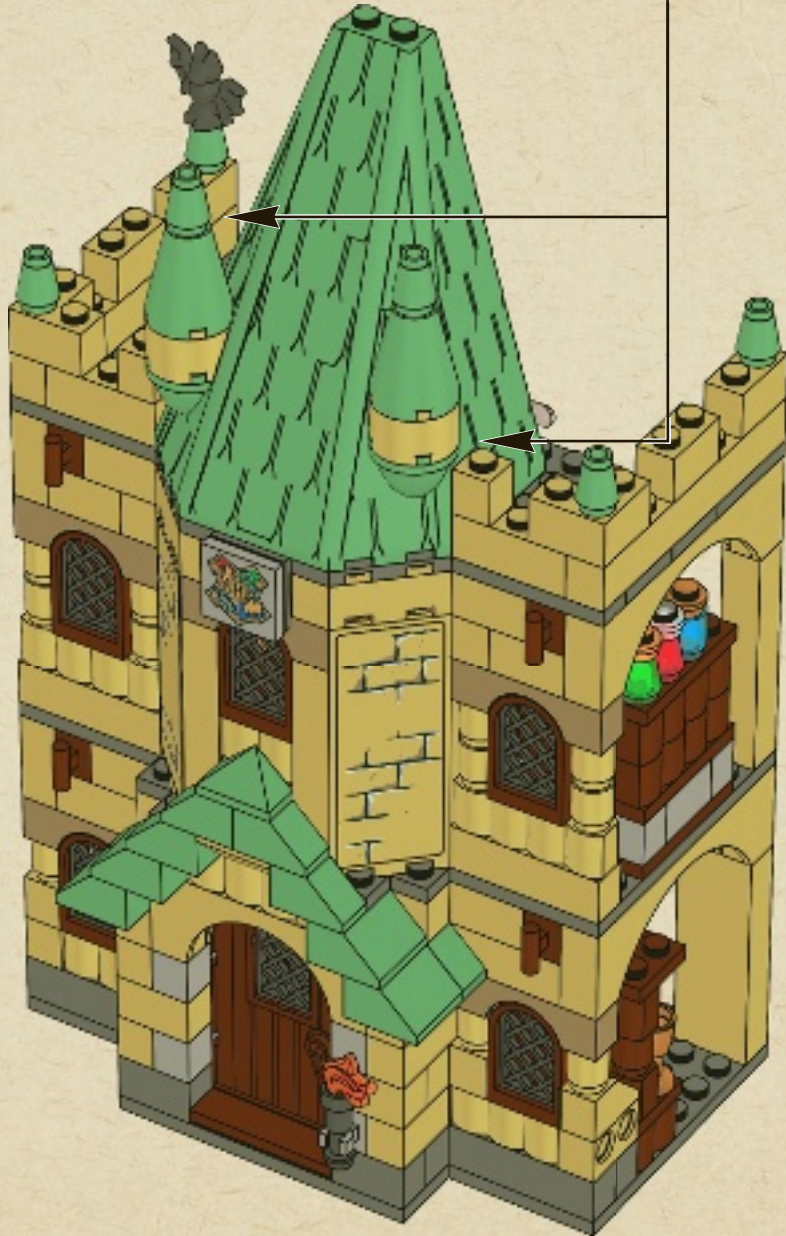





1x



1x

# 53





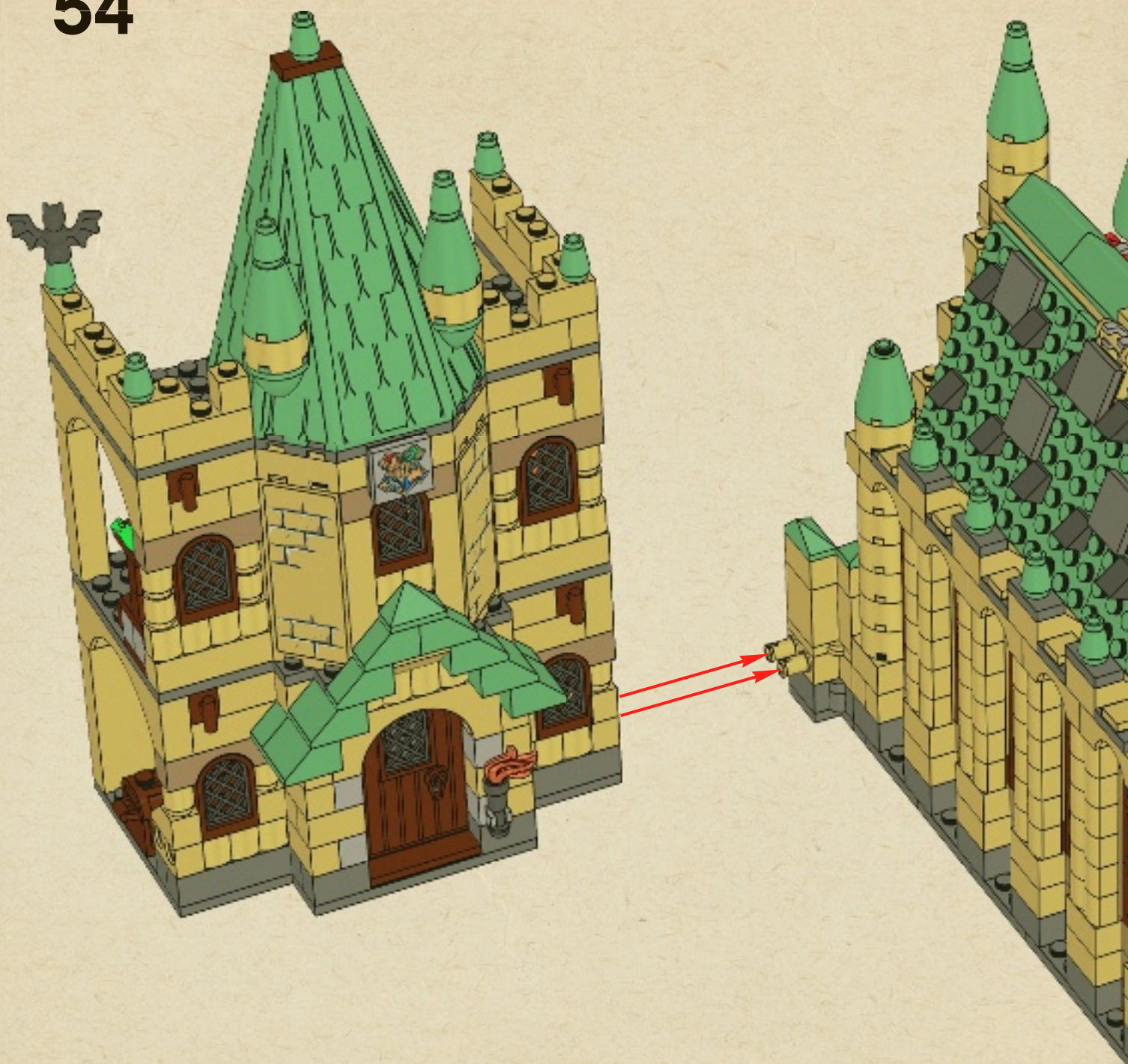



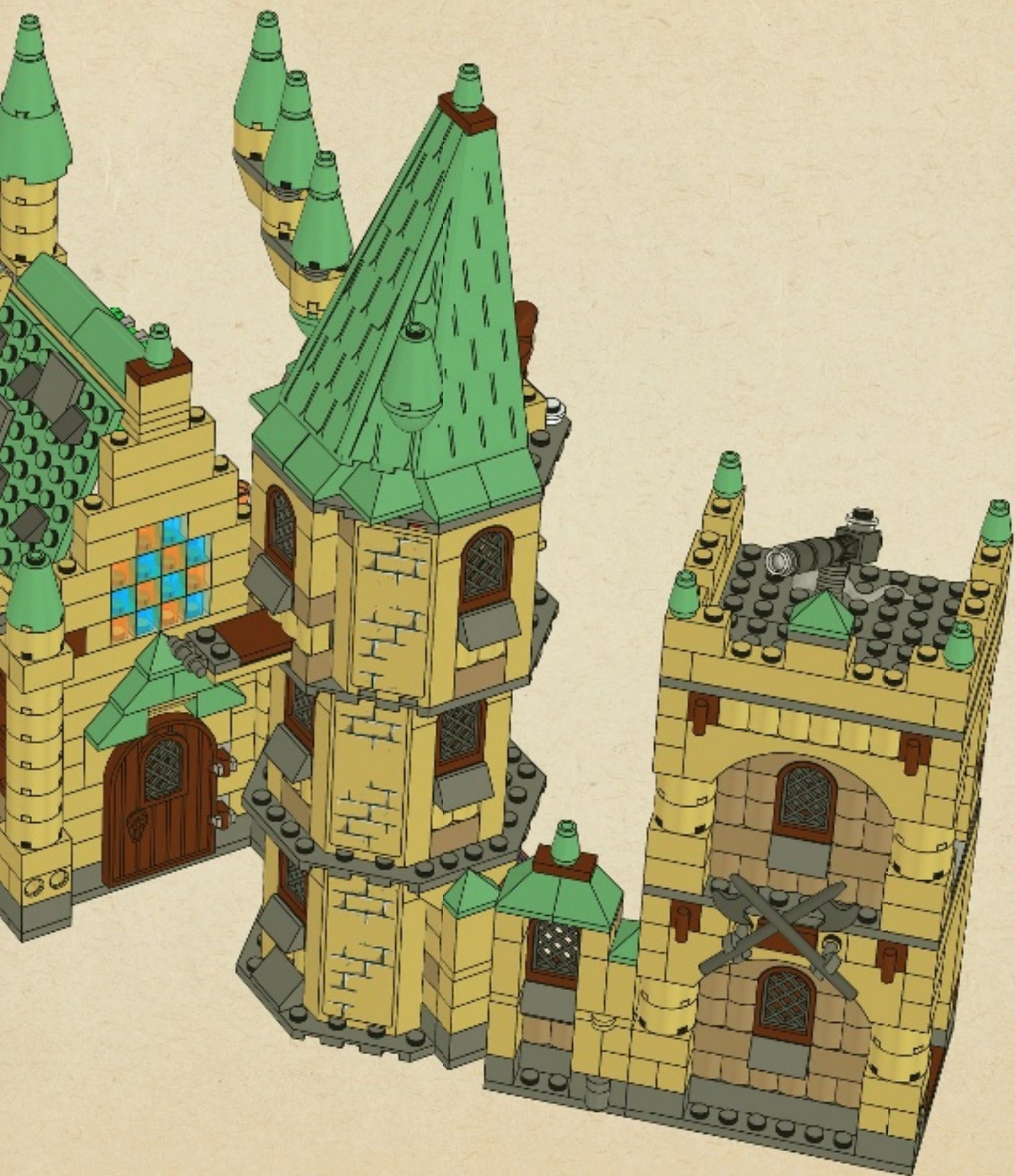











- 6x 4518400
- 1x 4119410
- 2x 614101
- 2x 4515347
- 1x 4129836
- 1x 4597233
- 1x 4568387
- 1x 4596754
- 8x 4112980
- 21x 4113915
- 72x 4109995
- 14x 4159279
- 8x 4114064
- 16x 4114306
- 10x 4124455
- 15x 4162465
- 2x 4159739
- 10x 4113916
- 12x 4579260
- 42x 4218749
- 6x 4599519
- 6x 4523148
- 14x 4117070
- 2x 4598467
- 10x 4523145
- 12x 4159196
- 1x 4288363
- 4x 4112982
- 12x 4159774
- 1x 4201062
- 2x 4114309
- 1x 4113993
- 4x 4249019
- 7x 4596319
- 15x 4550323
- 2x 4114073
- 7x 4125253
- 10x 4113917
- 1x 4594309
- 1x 4596918
- 1x 4114084
- 47x 4125220
- 7x 4118866
- 7x 4114322
- 4x 4121972
- 2x 4129996
- 1x 4217562
- 4x 4227507
- 2x 4161734
- 2x 4140562
- 8x 4594782
- 1x 4124460
- 1x 4508646
- 1x 306221
- 1x 306821
- 1x 403221
- 1x 4595822
- 1x 4523404
- 2x 407921
- 4x 614121
- 1x 4114585
- 1x 4515349
- 6x 362226
- 7x 300226
- 4x 301026
- 1x 4558954
- 1x 4233487
- 2x 4118624
- 1x 4253815
- 2x 306226
- 12x 4504382
- 2x 302226
- 1x 362326
- 1x 371026
- 2x 255526
- 1x 4517925
- 1x 379426
- 1x 614126
- 18x 3004626
- 1x 459926
- 1x 4538456
- 1x 4140303
- 1x 4597471
- 4x 9339
- 1x 4611992
- 1x 4596914
- 1x 4597469
- 1x 4597232
- 1x 362626
- 1x 4157659
- 2x 4277668
- 1x 4568933
- 1x 4179876
- 1x 434926
- 4x 4118867
- 2x 4124171
- 1x 4106513
- 1x 4113209
- 2x 4532220
- 4x 368026
- 1x 4517986
- 1x 4597644
- 1x 4121715
- 2x 4526982
- 2x 407926
- 4x 4529239
- 1x 4107762
- 1x 403228
- 1x 4598486
- 1x 4157270
- 2x 4249063
- 1x 4106556
- 4x 3005740
- 2x 4186513
- 2x 4100381
- 1x 4567334
- 2x 4597417
- 1x 4597340
- 1x 4596174
- 1x 3006844
- 15x 4119350
- 1x 3006843
- 2x 3000240
- 1x 4114128
- 1x 3006848
- 1x 4567333
- 4x 4183133
- 1x 4294982
- 1x 4267425
- 1x 4596937
- 2x 4541618
- 30x 4521914
- 5x 4247151
- 15x 4520257
- 10x 4596218
- 2x 4255624
- 1x 4597074
- 1x 4596942
- 1x 4587616
- 1x 4597294
- 9x 4597660
- 23x 4520959
- 12x 4593755
- 1x 4595809
- 12x 4598055
- 4x 4597012
- 10x 4597014
- 4x 4597643
- 3x 4595790
- 2x 4598536
- 1x 3006841
- 1x 4544720
- 1x 4286789
- 8x 4249039
- 1x 4587105
- 1x 4529351
- 1x 4611879
- 1x 71014
- 1x 4611881
- 1x 4113954
- 1x 4603517
- 2x 4211183
- 4x 4529242
- 10x 4504376
- 16x 4225469
- 2x 4211242





22x 4211180  
4x 4211149  
4x 4211200  
4x 4211220  
3x 4211225  
3x 4211189  
5x 4211194  
3x 4579690  
8x 4211186  
1x 4221590  
2x 4561915  
1x 4211163  
1x 4533101  
9x 4211181  
1x 4243838  
3x 4211247  
9x 4211211  
1x 4225700  
2x 4617863

2x 4508616  
1x 4211151  
4x 4211150  
1x 4586043  
2x 4211152  
2x 4520612  
1x 4211221  
2x 4211197  
13x 4219726  
1x 4211159  
16x 4542131  
15x 4595814  
16x 4225823  
4x 4215496  
3x 4262974  
1x 4506003  
1x 4611993  
1x 4596335  
3x 4598334

2x 4211388  
2x 4211349  
4x 4558953  
6x 4533772  
4x 4211460  
4x 4211461  
3x 4211684  
2x 4211398  
1x 4594330  
1x 4596917  
4x 4558169  
1x 4211438  
3x 4556157  
2x 4222019  
4x 4215513  
4x 4211515  
1x 4227657  
1x 4292298  
2x 4227658  
1x 4211465  
2x 4518282

1x 4225778  
1x 4512743  
4x 4540203  
4x 4211805  
2x 4211098  
16x 4211088  
8x 4211060  
2x 4211105  
2x 4211103  
2x 4210848  
14x 4211063  
5x 4211055  
2x 4596315  
1x 4611989  
2x 4211133  
2x 4211001  
1x 4211053  
1x 4211065  
3x 4528323  
2x 4210897  
8x 4153418

5x 4210706  
2x 4210796  
1x 4226358  
4x 4583688  
6x 4211122  
4x 4210802  
1x 4210798  
1x 4211107  
5x 4211002  
1x 4210998  
4x 4211008  
1x 4210997  
1x 4211099  
4x 4210795  
10x 4567887  
1x 4211054

4x 4210900  
2x 4596208  
2x 4597114  
1x 4287814  
1x 4596738  
2x 4289542  
2x 4603212  
1x 4210695  
1x 421069  
1x 4210892  
9x 4211119  
1x 4277928  
2x 4210660  
2x 4211129  
2x 4225733  
2x 4210633  
4x 4221591  
15x 4262655  
1x 4567338

2x 4278013  
1x 4273743  
1x 4540849  
1x 4597573  
1x 4597036  
1x 4597037  
1x 4596302  
1x 4596915  
1x 4596916  
1x 4597398  
4x 4529247  
2x 4587002  
8x 4523159  
8x 4505990  
1x 4287800  
6x 3005747  
8x 4540865

  
**Customer Service**  
 Kundenservice  
 Service Consommateurs  
 Servicio Al Consumidor  
[www.lego.com/service](http://www.lego.com/service) or dial  
  
 : 00800 5346 5555  
 : 1-800-422-5346













Go to [www.nielsen.com/LEGO](http://www.nielsen.com/LEGO)  
to fill out a survey for a chance  
to win a cool LEGO® Product.  
No purchase necessary.  
Open to all residents where not prohibited.

 [www.LEGO.com](http://www.LEGO.com)

[www.nielsen.com/LEGO](http://www.nielsen.com/LEGO)

**GEWINNE!**

Nimm an der Umfrage auf [www.nielsen.com/LEGO](http://www.nielsen.com/LEGO) teil und hab die Chance ein cooles LEGO® Produkt zu gewinnen!

Die Teilnahme am Gewinnspiel führt zu keinerlei Kaufverpflichtungen. Teilnahme in allen nicht ausgeschlossenen Ländern möglich.

**WIN!**

Ga naar [www.nielsen.com/LEGO](http://www.nielsen.com/LEGO), vul een enquêteformulier in en maak kans op een cool LEGO® product.

Geen aankoopverplichting. Iedereen mag deelnemen, uitgezonderd ingezetenden van landen waar een enquêteverbod geldt.

**GAGNE!**

Visite [www.nielsen.com/LEGO](http://www.nielsen.com/LEGO) pour répondre à un questionnaire et avoir une chance de gagner un produit LEGO® très cool!

Aucune obligation d'achat. Ouvert à tous les résidents des pays autorisés.

**当てよう!**

[www.nielsen.com/LEGO](http://www.nielsen.com/LEGO)にアクセスして、アンケートにご記入ください。当選者にはレゴ製品を差し上げます。

お買い上げの必要はありません。禁止されていない限り、すべての国籍にご利用いただけます。

LEGO and the LEGO logo are trademarks of the LEGO Group. ©2010 The LEGO Group. ©2010 Lucasfilm Ltd. & TM. All rights reserved. Used under authorization. HARRY POTTER, characters, names and related indicia are trademarks of and © Warner Bros. Entertainment Inc. Harry Potter Publishing Rights © JKR. TM & © Warner Bros. Entertainment Inc. (S10)