

LEGO

RACERS

7970



1

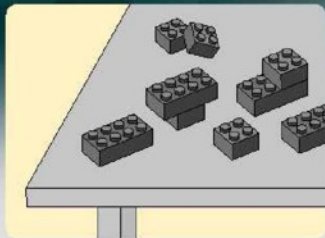

2





1



2

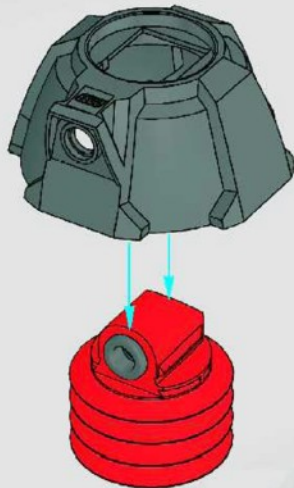

3

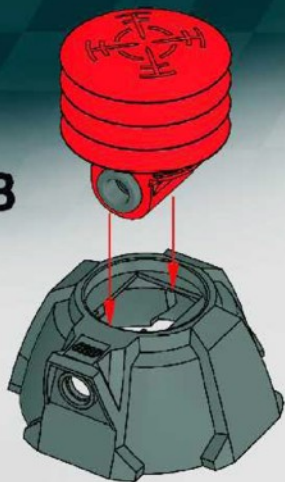

4

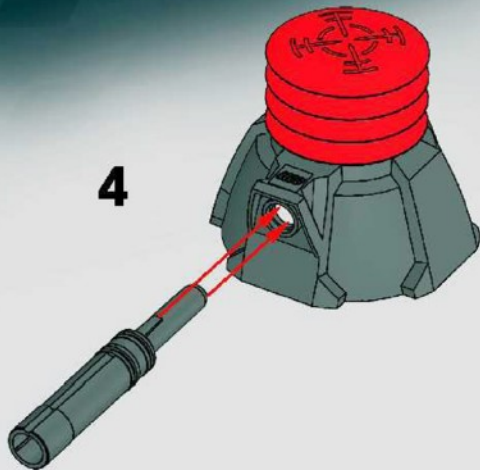

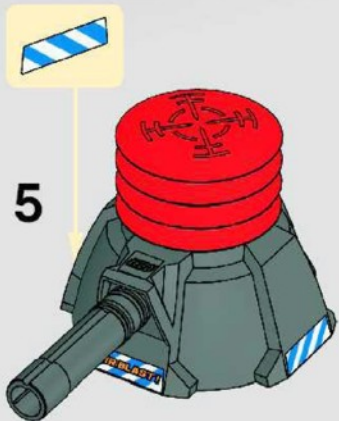



1



2



3

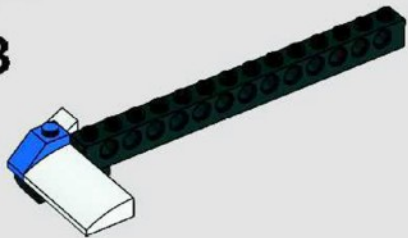

4

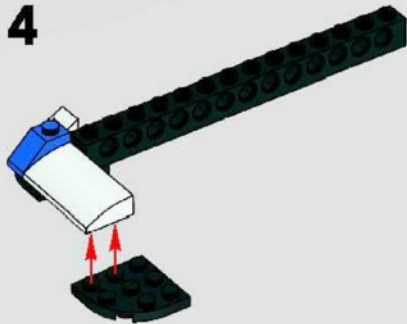

5

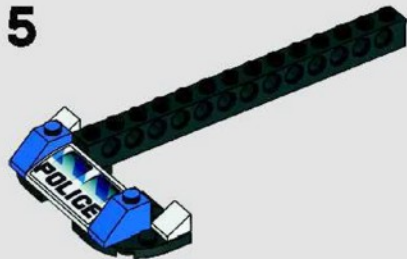

6

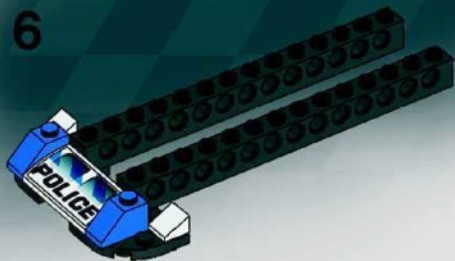

7

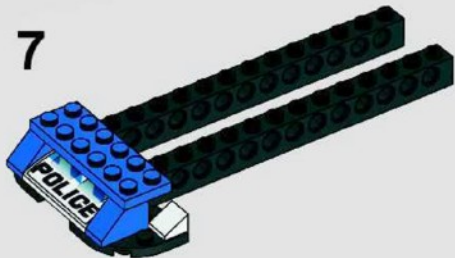

8

8

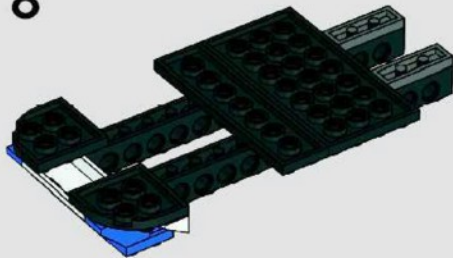



9

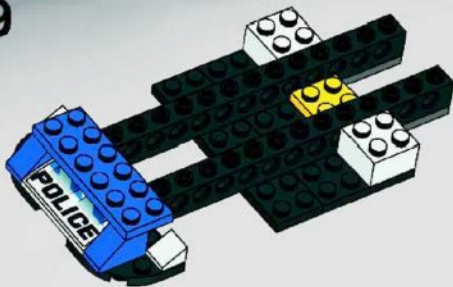

10

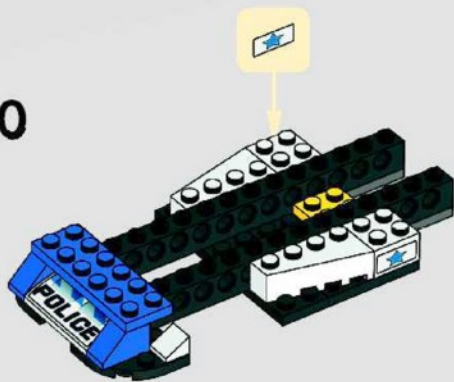

11

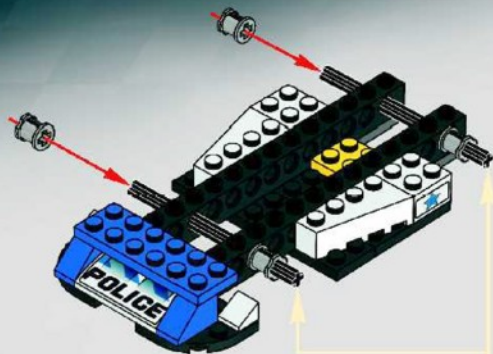

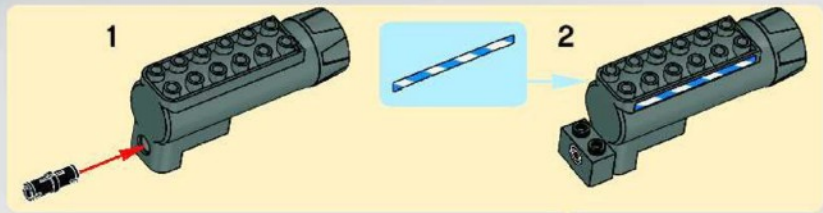

12

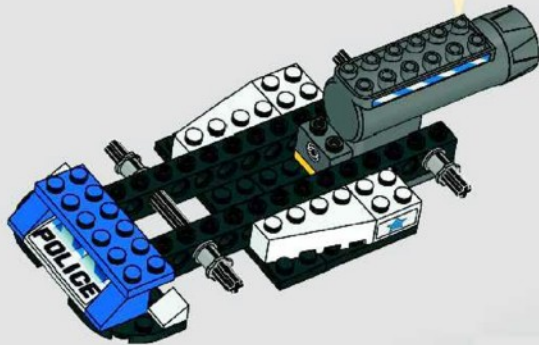

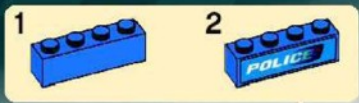

13

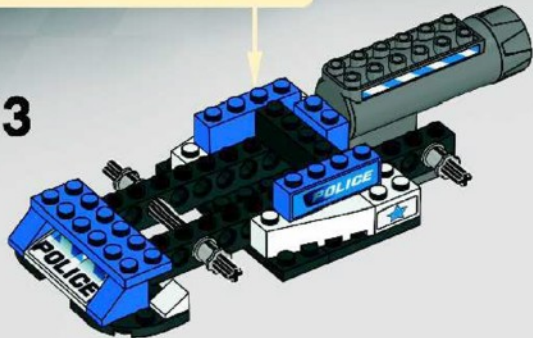

14

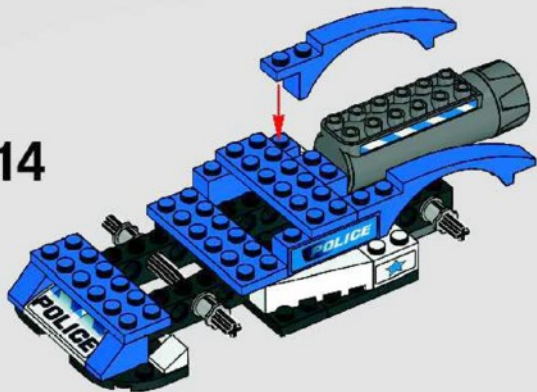

15

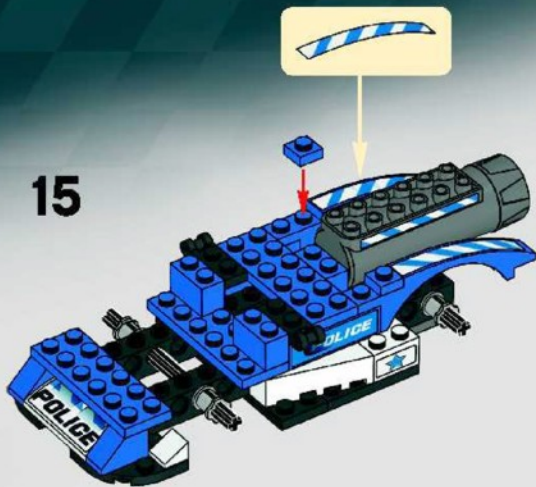

16



17

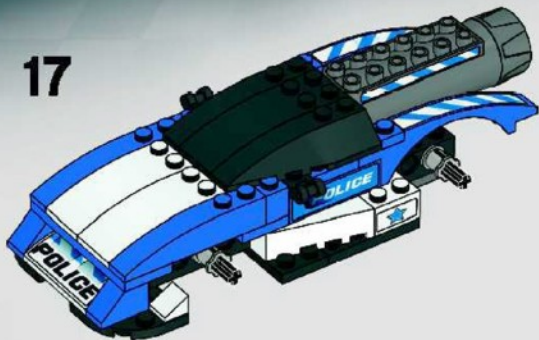

18



19

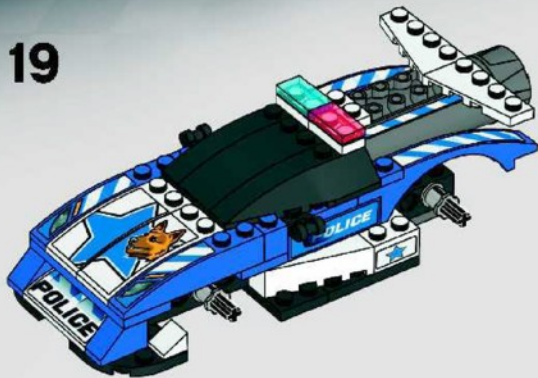

20



21

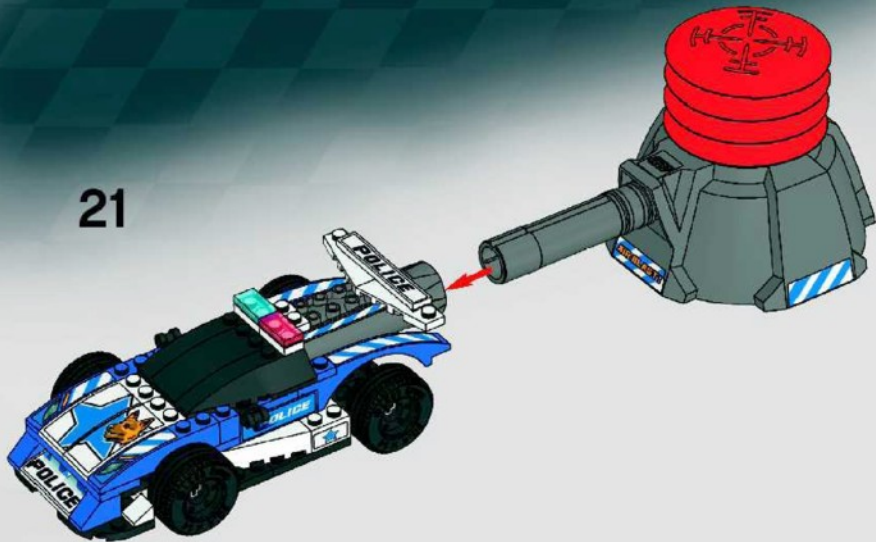



2x
300301



1x
4100325



1x
4100343



2x
4504369



2x
4179870



2x
242001



1x
663001



1x
4161325



1x
4160857



1x
4583297



1x
4568690



3x
300423



2x
301023



2x
4121935



2x
4160301



2x
4569286



2x
302423



3x
379523



1x
302224



1x
301026



2x
4107559



1x
4190548



1x
4160108



1x
4160130



1x
303426



1x
303526



2x
4515368



2x
4227392



4x
4517737



4x
4550937



1x
4121715



2x
370726



1x
4189801



1x
413854



4x
421622



1x
421181



2x
421133



1x
4563226



1x
4568692



1x
4563215

Customer Service

Kundenservice

Service Consommateurs

Servicio Al Consumidor

www.lego.com/service or dial



: 00800 5346 5555

: 1-800-422-5346





WIN!

Go to www.nielsen.com/LEGO
to fill out a survey for a chance
to win a cool LEGO® Product.
No purchase necessary.
Open to all residents where not prohibited.



www.LEGO.com

www.nielsen.com/LEGO

GEWINNE!

Nimm an der Umfrage auf
www.nielsen.com/
LEGO teil und hab die Chance ein cooles
LEGO® Produkt zu gewinnen!
Die Teilnahme am Gewinnspiel führt zu keinerlei
Kaufverpflichtungen. Teilnahme in allen nicht
staugechlossenen Ländern möglich.

WIN!

Ga naar www.nielsen.com/LEGO,
vul een enquêteformulier in en
maak kans op een
cool LEGO® product.
Geen aankoopverplichting.
Iedereen mag deelnemen, uitgezonderd
ingesloten landen.
van landen waar een enquêteverbod geldt.

GAGNE!

Visite www.nielsen.com/LEGO
pour répondre à un questionnaire
et avoir une chance de gagner
un produit LEGO® très cool !
Aucune obligation d'achat.
Ouvert à tous les résidents des pays
autorisés.

当てよう!

www.nielsen.com/LEGO
にアクセスして、
アンケートにご記入ください。
当選者にはレゴ製品を
差し上げます。
お買い上げの金額は関係ありません。
抽選されています。すべての年齢に適用されません。

4584916

LEGO and the LEGO logo are trademarks of the LEGO Group. ©2010 The LEGO Group. ©2010 LucasFilm Ltd. & TM All rights reserved. Used under authorization.